

2 1 2.5
8 4 H A

13
1705

Bob Blankwaardt

Hand Drilled Wells

A Manual on Siting, Design, Construction
and Maintenance

212.5-1705

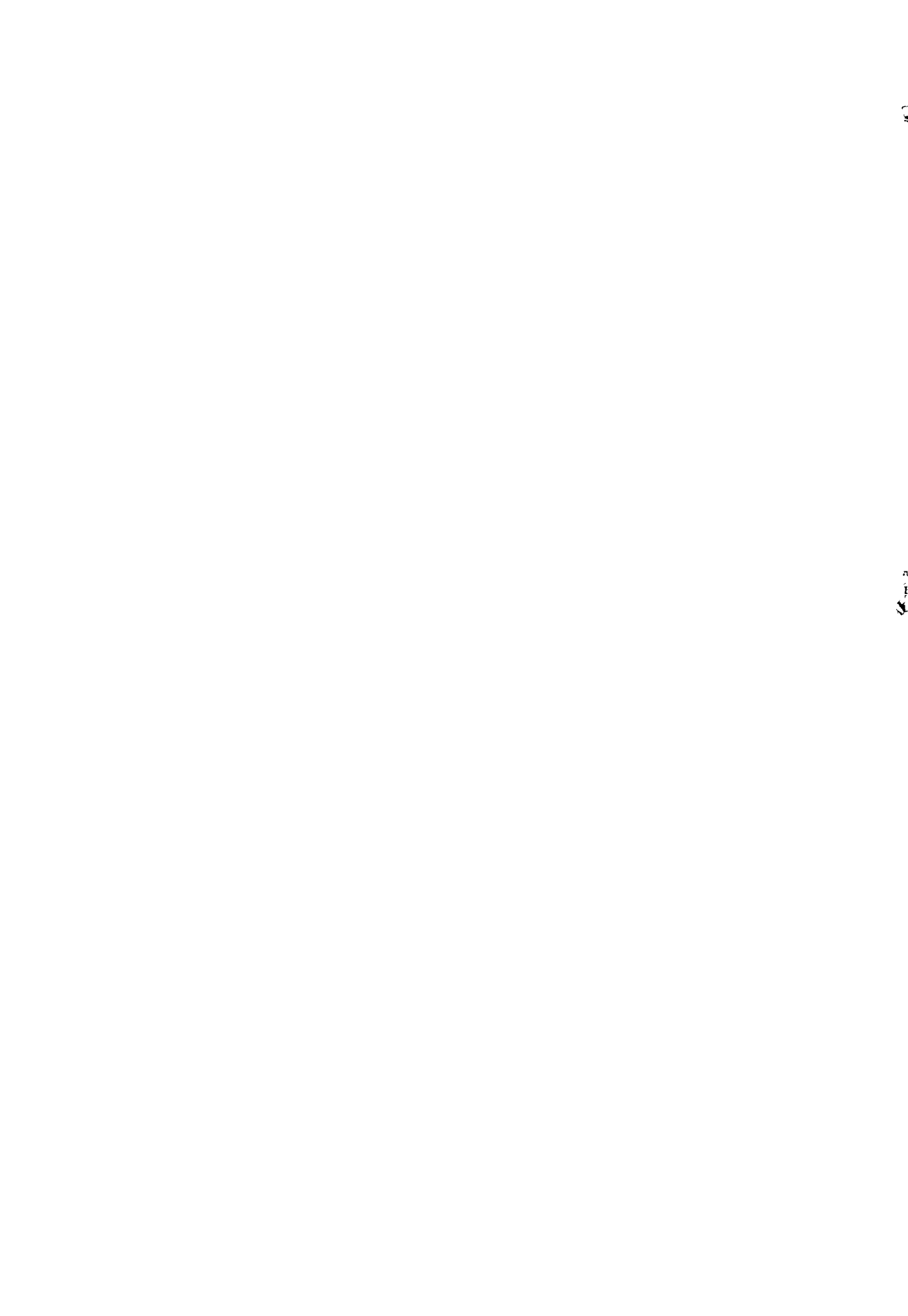

Hand Drilled Wells

A Manual on Siting, Design, Construction
and Maintenance

Bob Blankwaardt

INTERNATIONAL REFERENCE
SERIES FOR THE WORLD WATER SUPPLY
AND SANITATION (WSS) PROGRAM
FOR THE YEAR 2000. The page
no. is 212.5.

~~5149~~ ISBN = 1705
212.5 84HA



Rwagarulila Water Resources Institute

The preparation and printing of this publication has been made possible by grants from the United Nations Children's Fund (UNICEF) and the Swedish International Development Agency (SIDA)

© 1984 Bob Blankwaardt

ISBN 9976 936 01 X

Published by the Rwegarulila Water Resources Institute,
P.O. Box 35059, Dar es Salaam, Tanzania

Layout and cover design by Loes Dolkens, Illugrafika, Den Haag

Drawings by the author

Photography by Rwezaula J Kabengula,
Library Photographic Unit, University of Dar es Salaam

Typeset and printed in the Netherlands by
Roeland Foto-Offset B V, Den Haag

Distribution overseas by TOOL Foundation,
Entrepôtdok 68A/69A, 1018 AD Amsterdam, the Netherlands

Copyright is reserved under Protocol 2 of the Universal Copyright Convention. Nevertheless, permission is hereby granted for reproduction of this material, in whole or part, for educational, scientific or development-related purposes, except those involving commercial sale, provided that a) full citation of the source is given and b) notification in writing is given to the Rwegarulila Water Resources Institute

Hand Drilled Wells

Foreword

We, at the Rwegarulila Water Resources Institute, are very happy with the publication of this handbook.

In trying to opt for least cost alternatives in providing our people with clean drinking water and hygienic sanitation, the Ministry of Water, Energy and Minerals directed the Institute to give priority to local resources technology in its craft and technical curriculum.

Training in Shallow Wells Technology has been included in our three year Full Technician Programme. While meaningful development in this direction has been achieved, lack of performance oriented instructional materials has been our major setback. The publication of this handbook is timely. It is indeed an invaluable input into our training system.

For those involved in the construction and maintenance of tube wells at community level this handbook will be of much help.

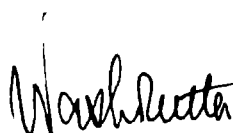

Washington Mutayoba

Principal
Rwegarulila Water Resource Institute

Preface and Acknowledgements

This Manual on Hand Drilled Wells is the product of 3 years' field and classroom teaching experience, first at the Morogoro Wells Construction Project and later at the Rwegarulila Water Resources Institute. When I was asked to prepare the manual I accepted the task with enthusiasm, but I was immediately confronted with a problem. Although primarily meant for pre-service students at the Institute, the book should, at the same time, serve a much broader public including craftsmen, technicians and practising engineers, and also project planners. I have tried to solve this problem by writing a kind of reference book with some features of a "true" manual in the sense that the most important operations have been described as step-by-step procedures and illustrated with many drawings and photographs. However, since I am convinced that practical skills can only be improved by theoretical knowledge, I have included more background information than strictly required for a manual.

I realize that by writing in the English language, I will not reach the entire group of people involved in well construction. Particularly for the in-service training courses which are mainly followed by craftsmen with primary education only, and in view of the strongly recommended village level operation and maintenance of water supply systems, a translation in due course of relevant parts of the book into Kiswahili remains a task of high priority.

The manual is built up in six parts. The first part - Chapter 1 - is an introduction to the subject. In the second part - Chapters 2 and 3 - the most necessary hydrogeological theory is given. Part three which includes Chapters 4 and 5, deals with site investigation and the criteria for approving a site for construction of a well. In part four - Chapter 6 - the design of the well is discussed, and in part five - Chapters 7 to 11 - the actual construction of the well including the installation of a hand pump. In the last part - Chapter 12 - a possible approach towards the maintenance of pumps and wells is indicated. In order to keep the size of the chapters on site investigation and well drilling operations limited, the survey and well drilling equipment have been described in separate appendices.

In the course of reading this manual, the realization of a well can be followed with the help of an actual example from Chamazi village near Dar es Salaam. I am much indebted to the people of this village for their hospitality. In fact, this village has virtually become a permanent training ground for the Institute. Most of the photographs were taken here.

Publication of this manual would not have been possible without the continuous encouragement of Washington Mutayoba, the Principal of the Institute, and the teaching staff: Elnathan M. Mundo, John T. Sambu, Juma M. Kaeje and Abdallah S. Bunga, who gave me good advice on the desired content of the book.

I am very grateful to the following persons for their invaluable contributions.

- My former colleagues in the Morogoro Wells Construction Project, especially Aat van der Wel who read an early version and made very helpful comments.
- The Organization of Netherlands Volunteers for giving me the opportunity to finalize this work.
- Abubakr Kigingi, executive engineer in the Morogoro Regional Water Engineer's office, Frans van der Laak and Geert van den Honing of the Morogoro Wells Construction Project, Hartmut Floegel of the Tanga Integrated Rural Development Project and Jo Smet of the Community Health Department, Faculty of Medicine, University of Dar es Salaam, for their critical review of several chapters.
- Daphne Beaton and Malcolm Norris of the Communication Skills Unit, University of Dar es Salaam, for their patient and undaunted correction of my English.
- Helen Cramer, for typing the first version and large parts of the final manuscript.

To Peter van der Werff, an old friend of mine, I owe special thanks for all his tireless work behind the scenes.

Bob Blankwaardt

Dar es Salaam, April 1984

Contents

Chapter 1 Introduction

1.1	Comparison of water supply systems	1
1.2	Hand drilled wells: a short description	2
1.3	Hand drilled wells versus dug wells	3

Chapter 2 Groundwater

2.1	The hydrological cycle	5
2.2	Types of aquifers	6
2.3	Characteristics of aquifers	6
2.4	Basic well hydraulics	8
2.5	Groundwater level fluctuations	9

Chapter 3 Origin and occurrence of unconsolidated sediments

3.1	The process of weathering	12
3.2	Slope erosion	13
3.3	Erosion and sedimentation by rivers	13
3.4	The search for aquifers	17

Chapter 4 Site investigation

4.1	Preparations in the office	21
4.2	Preparatory work in the village	22
4.3	Test drilling operations	23
4.4	Survey pump test	26
4.5	Description of soil samples	27
4.6	Drawing a section	29
4.7	Recording and storage of survey data	31

Chapter 5 Criteria for borehole approval

5.1	Test yield criterion	33
5.2	Water quality criteria	34
5.3	Hydrogeological criteria	35
5.4	Summary	36

Chapter 6 The design of tube wells

6.1	Components of a tube well	37
6.2	Design principles	37
6.3	Example of a design	40

Chapter 7 Well drilling operations

7.1	Preparations	41
7.2	Drilling without a casing	42
7.3	Installation of casing and bailing	44
7.4	Drilling inside the casing	46
7.5	Completion of the borehole	46
7.6	Telescopic drilling	47
7.7	Borehole description	48

Chapter 8 Installation of filter pipe and gravel pack

8 1	The gravel	49
8 2	The filter pipe	50
8 3	Installation of the filter pipe	51
8 4	Installation of the gravel pack	52
8 5	Methods of removing the casing	54

Chapter 9 Development, pump test and backfilling

9 1	Objectives of development	56
9 2	Overpumping	56
9 3	Surging	57
9 4	Pump test	58
9 5	What to do if the pump test fails	58
9 6	Clay seals and backfill	59

Chapter 10 Construction of the slab

10 1	Design of the slab	61
10 2	Building materials	63
10 3	Building the slab	64

Chapter 11 Hand pumps and their installation

11.1	Choosing an appropriate pump	68
11 2	Pumps in Tanzania	68
11 3	Cylinder, rising main and pumprod	70
11 4	Installation of the pump	72

Chapter 12 Maintenance of pumps and wells

12 1	Towards village level operation and maintenance	76
12 2	Village maintenance tasks	79
12 3	The role of MAJI in well maintenance	80

References 82

Appendices

A	Prevention of water-related diseases	85
B	Surveying equipment	87
C	Water quality standards	96
D	Well drilling equipment	99
E	Topographical maps	107
F	Checklist for pump maintenance	114
G	Disinfection of a well	116

Annexes

1	Village Sketchmap	117
2	Situation Sketchmap	119
3	Survey Borehole Description Form	121
4	Well Description Form	123
5	Maintenance report	125
6	Educational posters	127

Index 129

Chapter 1

Introduction

For the development of rural water supply the Tanzanian Government started the National Rural Water Supply Programme in 1971, and has adopted the United Nations' Water and Sanitation Decade target: "To provide a reliable water supply by the year 1991, whereby all people have ease of access (at a distance of 400 m or less) to a public domestic water point". The ministry responsible for the planning, preparation and execution of this programme is the Ministry of Water, Energy and Minerals (MAJI).

The Government's optimistic claim that currently 40% of the rural population of 15 million people has access to clean drinking water, might hold true if it were based on the installed capacity. However, taking into account the water supply schemes that are out of order, probably not more than 3 million people at present have access to a reliable supply. The remainder of the population is still (or again!) entirely dependent on the use of water from hand dug holes, unprotected wells, rivers, pools, etc. The traditional picture of women fetching water of dubious quality at places many miles from their homes is still the rule in the rural areas. Long walking distances also imply a low rate of consumption. Both the poor quality and the small quantity of water (often less than 10 litres per person per day) are responsible for the spread of water-related diseases.

Assuming a growth rate of 3% per year, the total rural population will have grown to about 20 million people by the year 1991. Consequently new water supply systems will have to be constructed, and old ones rehabilitated, for 17 million people in 7 years' time; that is to say, for around 2.5 million people per year, provided that none of the existing or new supplies breaks down. In the present economic situation it is entirely beyond the country's capabilities (even with donor assistance) to provide every household with a tap inside the house. The country has to resort to low cost technology which requires the least capital expenditure per head of population for investment, operation and maintenance and at the same time guarantees a reliable and safe supply.

1.1 Comparison of water supply systems

Supply systems of the following types are commonly constructed in the country

- gravity-fed or pumped surface water,
- deep boreholes with motor-driven pumps,
- wells with hand pumps.

The features of these systems can briefly be described as follows

- a) Surface water - pumped or gravity-fed - is generally polluted, bacteriologically unsafe and carries a high seasonal sediment load. Very often it needs treatment which results in high investment and operational costs and in a demand for skilled manpower
- b) For the construction of deep boreholes machine-powered equipment is required. Even the simplest drill rig requires skilled operators and high investment, and its operation depends on the availability of fuel and spare parts. Moreover, the exploration of deep ground-water requires expensive geophysical investigations

Both surface water and borehole supplies require capital intensive distribution systems. These include pipelines,

break-pressure tanks, storage tanks and domestic water points. The cost depends, of course, on the location of the river intake or borehole and the size of the village(s) to be supplied

- c) Tube wells and ring wells of shallow to medium depth (often not quite correctly called "shallow wells") can be made by hand drilling and digging respectively. This leads to comparatively low investment costs. Construction failures (lower yield than anticipated) seldom occur if the location and the design of the wells are based on the results of proper test drilling and pumping. Operational costs are low because these wells can be equipped with hand pumps, which do not require any fuel or highly skilled personnel. Moreover, if maintenance is made the responsibility of the village, maintenance costs can be limited. In fact, centralized maintenance may well be beyond the country's financial and organizational capabilities

A comparison of estimated investment, operational and maintenance costs of the various systems is given in Table 1.1

Table 1.1 Cost of water supply systems per head of population in T.Shs.

Type of supply	Investment	O & M ^{a)} /year
Gravity	600-1200	10
Pumped surface water	600- 900	20
Deep borehole	600- 900	15
Concrete ring well ^{b)}	100- 150	5
Hand drilled tube well ^{b)}	60- 100	5

a) Operational and maintenance costs

b) Equipped with handpump

Source: Reference [16]

Given these figures, it is not surprising that the Regional Water Engineers' Conference in 1980 passed the following resolution "An appropriate technology mix emphasizing the shallow well technology as a least cost alternative should be worked out and used as a means of realizing the objectives of the programme where possible"

1.2 Hand drilled wells: a short description

The term "shallow well" is frequently used to describe any water supply from a borehole which is not constructed by percussion or drill rig. This is incorrect. According to current international terminology, a shallow well is a well from which the water can be pumped by means of a suction pump, which implies a water level not lower than 6 to 7 m below ground level.

However, a large number of hand drilled wells draw their water from deeper levels. Therefore, such a well should be termed a *hand drilled tube well* or, more briefly, a *hand drilled well*. It may be necessary to add *shallow to medium depth*.

Site investigation and construction

Construction of a well, be it a drilled well or a dug well, must always be preceded by a detailed survey in the area in order to find the most suitable location. The best method for site investigations has proved to be drilling by hand of small test boreholes (ϕ 100 mm), followed by a simple pump test whenever a prospective aquifer is found. If the test yield and the water quality meet certain criteria, and if the site itself fulfils certain other conditions, a site can be approved for construction. This procedure greatly diminishes the risk of a low yield and/or unsatisfactory water quality after construction.

Tube wells (Figure 1) are constructed in a relatively small diameter borehole and this manual will deal with only the hand drilling of such boreholes. A PVC filter pipe is set into the borehole, the lower part of which (the screen) is provided with small openings to let the water pass through. The upper part is closed and serves as a lining. A

gravel pack is installed around the screen to prevent it from clogging up. Where necessary the aquifer(s) is sealed off by means of one or more clay seals. The rest of the borehole is backfilled with soil. The well is brought to its maximum capacity by means of surging and overpumping. At ground level a hard-core slab is constructed around a sturdy pre-cast concrete well cover. This slab prevents unhygienic conditions from developing around the well and a built-in gutter drains the spill water into a ditch. Equipped with one of the hand pumps described in this manual, a tube well can serve 250 to 300 people.

Public health aspects

A great many of the communicable diseases prevailing in the country are in one way or another related to water or to impurities in the water. Improvement of the water supply conditions is therefore one of the key factors in the struggle to push back these *water-related* diseases. The mechanisms by which these diseases are transmitted are known and their spread can be largely prevented by putting certain conditions to the siting, construction and maintenance of wells, as described in Appendix A.

However, it appears time and again from studies in developing countries that improved village water supplies may have no significant effect on public health conditions, when they are the sole environmental intervention. Extensive health education and proper excreta disposal are just as crucial in achieving any improvement in public health. And of course, the availability of water is a prerequisite for their success.

It is often said that if people are used to drinking contaminated water, improvement of the water quality will diminish their immunity against disease. This is certainly not true in Tanzania, where malnourishment is the main reason for lack of immunity. Therefore, this should never be used as an excuse to construct cheap supplies which are bacteriologically unsafe. However, the prevailing water-

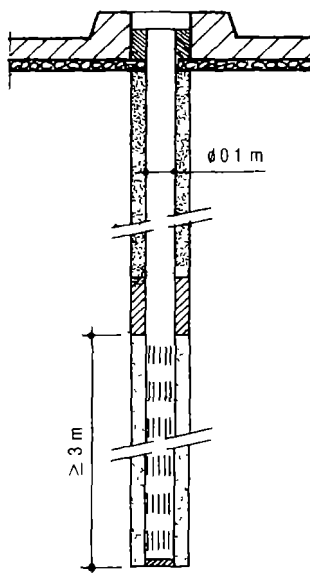

Fig 1 Section of a tube well.

related diseases in Tanzania are, apart from malaria, those conveyed by the water-washed mechanism. Thus priority should be given to quantity of the water. Advocating many cheap supplies, taking some contamination for granted, would seem to contradict the above. But if, apart from being cheap, such water supplies are also bacteriologically safe, then there is all the more reason to install these wherever possible.

Summary of well construction activities

Construction of hand drilled wells was started in Tanzania in 1975 by the Shinyanga Shallow Wells Project. The Morogoro Wells Construction Project (MWCP) continued with this approach to rural water supply, becoming a training centre for personnel from all regions and a supply centre for drilling equipment and construction materials (including hand pumps). In 1981 the training programme was transferred to the Water Resources Institute in Dar es Salaam. Some other organizations involved in well construction programmes are:

- Regional and District Water Engineers;
- Regional Integrated Development Projects,
- Finnwater Consulting Engineers in Mtwara/Lindi,
- Tanzania Water Development Project in Singida,
- Tanganyika Christian Refugee Service in Dar es Salaam (Mishamo and Ulyankulu settlements)

The total number of tube wells with hand pump so far constructed in the country now amounts to approximately 2500. It is anticipated that because of favourable hydrogeological conditions in large parts of the country, 50 to 60% of the rural population can be served by this type of water supply.

1.3 Hand drilled wells versus dug wells

The construction of hand dug wells has a long history in the country. Along the coast we can still find quite a number of masonry wells, dating back to the period of Arab settlements, most of them of (very) shallow depth and not protected by any cover. A bucket on a rope, whether or not wound onto a windlass above the well, was the traditional means of drawing water. In later days, many new wells made of concrete rings were built and these were mostly covered with concrete slabs and sometimes provided with heavy-duty hand pumps. However, as shown in Section 2.5, the wells often ran dry and the water quality deteriorated in the dry season. Therefore, when the Shinyanga Shallow Wells Project was started, emphasis was put on the improvement of the groundwater exploration methods (test drilling and pumping) and construction methods (e.g. introduction of porous concrete filter rings) in order to guarantee water in the well throughout the year. For a typical section of a ring well see Figure 2.

For the construction of hand dug ring wells, reference should be made to two excellent publications on this subject:

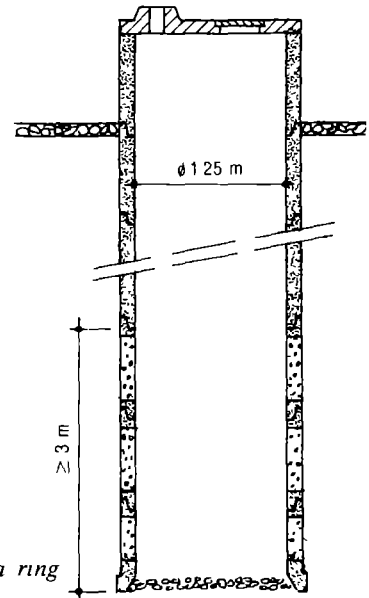

Fig 2 Section of a ring well

- * *Hand dug Wells and their Construction* (1976), by S B Watt and W E Wood, see Reference [22]
- * *Shallow Wells* (2nd ed 1979), by DHV Consulting Engineers, see Reference [4]

However, this method of well construction was cumbersome and relatively expensive, and more reliable water bearing formations than the shallow top aquifers could often not be reached due merely to their depth or to an excessive flow of water into the dug hole making installation of the rings impossible. For these reasons, hand operated equipment was developed for drilling boreholes in which small diameter PVC pipes could be installed. Ever since, there has been discussion as to which type of construction is most appropriate.

Advantages of dug wells

The obvious advantages of hand dug ring wells above tube wells are that they can be constructed in areas where

- the soil conditions are unfavourable for drilling by hand (very hard formations such as laterites and calcretes, the presence of big stones, etc),
- the permeability of the aquifers is too low or its thickness too small for a sufficient flow towards a small diameter tube well and storage capacity is required in the well for overnight recharge.

In fact, in such areas, a ring well may be the only alternative.

Secondly, in the case of a breakdown of the pump, water can still be drawn from a ring well by letting a bucket down through the man-hole in the cover of the well. This is, of course, impossible with a small diameter tube well. However, in such a case the well water might become contaminated by the use of dirty buckets.

Thirdly, some people argue that the use of ring wells would contribute to an increase in village participation.

True, more people can be involved at the construction stage, but whether this would have such a positive influence on the attitude of the people towards the upkeep and maintenance of the wells can be much doubted

Advantages of hand drilled wells

On the other hand, there are many factors which make large-scale production of hand drilled wells more attractive than that of hand dug ring wells

Construction method and materials

In the first place, drilling a borehole is much easier than digging the hole for the concrete rings, because this does not require dewatering during construction. Secondly, installation of a PVC filter pipe (screen and lining) in a borehole is much simpler than lowering concrete rings. The whole process takes place above the ground, which makes the operation less troublesome and dangerous.

Hand drilling equipment and construction materials can be carried virtually anywhere while the heavy concrete rings limit the location of ring wells to places accessible by lorry only, unless they are manufactured on the spot. Furthermore, the availability of cement is often a serious bottleneck in the production of rings, except in those regions with easy access to a cement factory. With the existing national supply centre for construction materials in Morogoro, this problem is largely solved for tube wells in those regions where they are hydrogeologically feasible.

Depth of the wells

Deeper aquifers are, in general in Tanzania, more suitable for water supply than unconfined top aquifers because

- the seasonal groundwater fluctuations are smaller and therefore the likelihood of wells drying up during the dry season is reduced,
- they can be sealed off completely so that no contamination by polluted surface or spill water can occur

Proportionately more ring wells have their intake in a shallow unconfined aquifer because of dewatering problems at greater depth. Tube wells, on the other hand, mostly draw their water from unconfined aquifers

Construction time

Experience has shown that the construction time for a ring well is 3 to 7 weeks, depending on depth and soil conditions, whereas a tube well is normally constructed in only 3 to 5 days. Consequently, the budget allowing, an average of 5 times as many tube wells can be constructed in the same period of time, an important factor with the 1991 target in mind.

Investment costs

Figure 3 shows a graph of costs versus depth for ring wells and tube wells. From a depth of 6 to 7 m, a sharp increase in the price of hand dug wells can be observed. At this point, the normal suction pumps used for dewatering no longer function and other, more expensive, high-capacity pumps have to be used. In addition, the cost of labour and transport of rings increases rapidly with depth. So, for an average depth of 8 to 10 m, a ring well is approximately 2 to 2.5 times as expensive as a tube well. If produced on a large scale the difference in investment costs becomes substantial.

Even in areas where after initial investigation the possibilities for tube wells seem to be limited, the relatively cumbersome and expensive construction of ring wells can often be avoided by means of an intensified survey of the area. Once a surveyor has arrived in a village, the cost of an extra test borehole is very low (maximum T Shs 200-300). This means that for the additional cost of a ring well, 30 to 40 survey boreholes can be drilled to find a suitable site for a tube well.

Note: Operational and maintenance costs are approximately the same for both types of well, if they are equipped with the same type of hand pump.

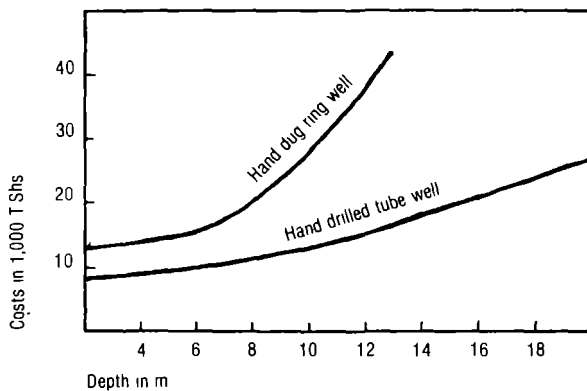

Fig 3. Investment costs of wells as a function of the well depth. Source Reference [16]

Chapter 2

Groundwater

Groundwater is one of the best sources for drinking water because it is generally free from pathogenic organisms, has an almost constant quality and temperature and is available in large quantities. How much value is attached to these properties may be illustrated by some examples from West European countries.

- In West Germany, only temporary permits are issued for the exploitation of river water for domestic supply.
- In Austria, which has plenty of very clean surface water, over 99% of the domestic water is groundwater.
- In the Netherlands, large quantities of river water are first stored underground for filtration.

In other countries, particularly those with very dry climates, groundwater is often the only source available throughout the year.

2.1 The hydrological cycle

The total amount of water on the earth does not change. Due to meteorological conditions it is in continuous movement, changing into different phases: solid, liquid and gaseous. This is called the *hydrological cycle*. In broad outline it can be described as follows: water evaporates from the ocean, forms clouds which move inland and condense to fall on the land as rain. From the land, water runs back to the ocean either in rivers or underground. This process is illustrated in Figure 4.

For a better understanding of underground storage and movement, this cycle needs further consideration. The main factors which influence the groundwater balance are described below.

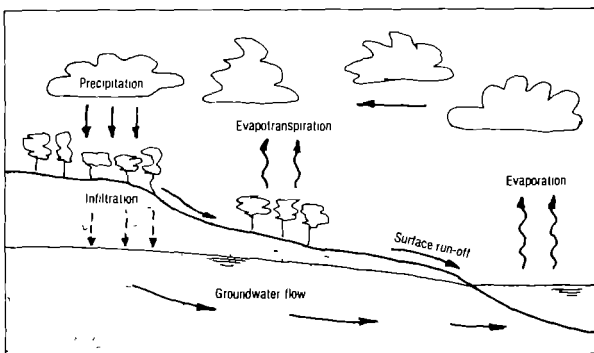

Fig. 4 The hydrological cycle

Infiltration

When rain falls on the land, part of it *infiltrates* into the ground and part runs off over the surface. How much water infiltrates depends on:

- the permeability of the topsoil e.g. in sandy soils, it is easier for the water to enter the ground than in clay,
- the slope of the terrain the flatter the area, the smaller the amount of water which runs off immediately;
- the intensity of the rain during heavy rainstorms most of the water runs off because it cannot be absorbed all at once. Gentle rains over an extended period are much more favourable for infiltration.

The soil layers close to the surface are only partly filled with water and infiltrating rain is first used to replenish any deficiency of this *soil moisture*. The water in this upper zone is held up against gravity by molecular and capillary forces and it is this water which plants absorb by means of their roots. If more water infiltrates than can be used for replenishing the soil moisture, it *percolates* to deeper layers under the influence of gravity. At a certain depth it reaches the *saturated zone*, where all the pores of the soil are completely filled with water and this is the zone in which the groundwater is stored.

Evapotranspiration

Part of the groundwater returns to the atmosphere in the form of vapour through the combined processes of *evaporation* and *transpiration*, under the influence of solar energy. Direct evaporation of groundwater only occurs when the water table is not very far from the ground surface (1 to 3 m, depending on the soil type).

Transpiration, on the other hand, is the process by which plants release groundwater into the atmosphere by "breathing". Most plants get their water from the soil moisture zone, and if the water table is near the surface, the roots will also extract water from the saturated zone. Some types of plants, particularly deep-rooting trees, are even

able to absorb water from far below the ground surface. The losses of groundwater by transpiration are generally much greater than those by evaporation

Discharge to rivers

The greatest losses of groundwater occur from discharge to streams, rivers, lakes and oceans. Groundwater in the saturated zone is not stationary, but flows very slowly with velocities varying from 1 m/year to 1 m/day, towards areas with a low water table. River flow in the dry season can only be the result of outflowing groundwater either directly into the river bed or indirectly through springs (Figure 5)

Note: The reverse situation may also occur when, at the beginning of the rainy season, the groundwater table is still low. Heavy rains may lead to big surface run-off and high river levels. At this point the river water can start feeding the groundwater

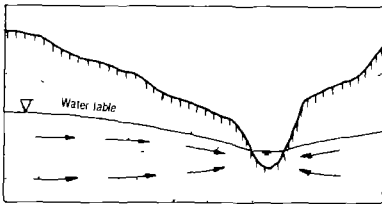

Fig. 5 In the dry season rivers are fed by the groundwater.

2.2 Types of aquifers

An *aquifer* or *water-bearing layer* is a rock or soil formation, which yields sufficient water to wells for them to serve as reliable sources of water supply. It may vary in thickness from less than half a metre to several hundreds of metres, it may lie under a whole village and its surroundings, it may be like a winding underground river or just be the river bed itself. A distinction is made between two types of aquifers.

- a) **Confined aquifer.** a confined aquifer is one in which the water rises to a higher level in the borehole than in the surrounding rock (borehole no. 1 in Figure 6). This occurs where the aquifer is confined at the top by an overlying impermeable layer and the level to which the water rises in the borehole is known as the *piezometric level*. In such an aquifer the water pressure is higher than atmospheric pressure. Water pressure can be so great that water flows out of the borehole opening and this phenomenon is called an *artesian well* (borehole no. 2 in Figure 6).

Replenishment or *recharge* of the water in a confined aquifer can occur far away from the location of the well by infiltration in a *recharge area*.

- b) **Unconfined aquifer** if a borehole is drilled in an unconfined aquifer, the water does not rise above the

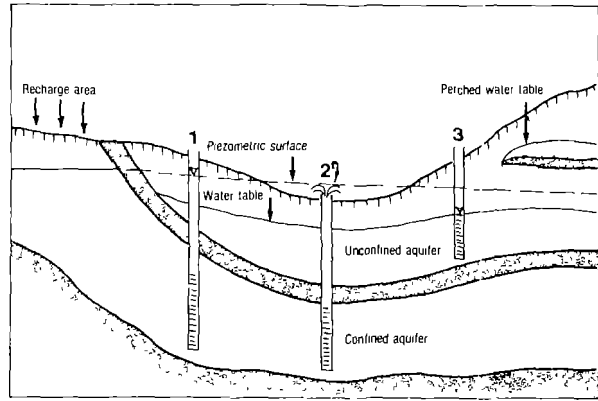

Fig 6 Different types of aquifers.

level where it was struck (borehole no. 3 in Figure 6). The water in such an aquifer is at atmospheric pressure, just like an open reservoir. The upper limit of the aquifer is formed by the *water table*, the shape and slope of which depend on local recharge/discharge areas and permeability.

Perched water tables can occur when infiltrating water is stored on top of impermeable layers of relatively small area such as clay lenses (Figure 6). They can easily be mistaken for the water table of the main aquifer which lies deeper. The chances are that a well in such a perched water body will quickly run dry, since the storage capacity is only small and recharge can only take place in the rainy season by local infiltration.

Note: Impermeable layers are, in reality, mostly slightly permeable. Water from a confined aquifer can pass through to an unconfined one and vice versa, depending on the levels in both aquifers.

2.3 Characteristics of aquifers

The aquifer material must contain interconnected open spaces or *pores*, filled with water, and the openings between these pores must be large enough to permit the water to move towards wells at a sufficiently high rate. The water yielding characteristics of aquifers, which are largely determined by the grain size of the soil particles, are described below and some representative values are listed in Table 2.1.

Porosity and specific yield

If a rock or soil contains many pores, it is described as a formation of high *porosity*. This means that, per unit of volume, a large amount of water can be stored in such an aquifer. Porosity is defined as the percentage of the total volume which is occupied by the pores. For example total volume of soil = 1 litre, volume of pores = 0.3 litre, porosity = 30%.

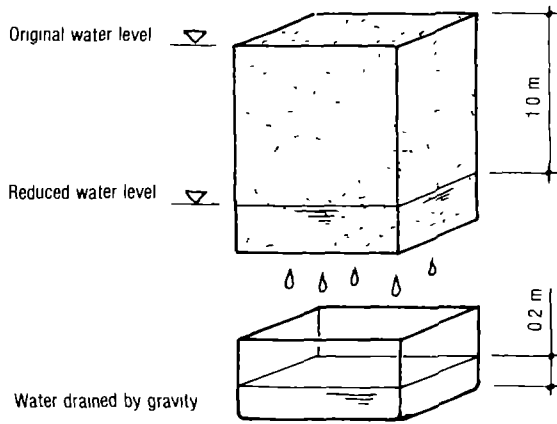

Fig. 7. In this example, the specific yield amounts $\frac{0.2}{1.0} \times 100\% = 20\%$

The water in the pores, however, is not always easy to remove by pumping. Some of it is very tightly connected to the soil particles by molecular forces. For example, clay has a very high porosity, but if saturated clay is placed on a sieve, hardly any water will drain out. Sand and gravel, on the other hand, easily release the stored water. They have a high *specific yield* and are therefore of more interest for the construction of wells. The specific yield of a soil is defined as the ratio of the volume of water that, after saturation, can be drained by gravity, to the original volume of the saturated soil (Figure 7) and is usually expressed as a percentage. Figure 8 shows that with increasing size of the soil particles, the value of the specific yield approaches that of the porosity because the influence of the molecular forces is reduced.

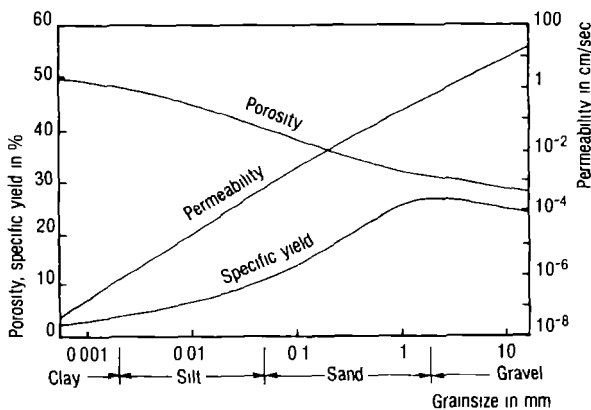

Fig 8 Porosity, permeability and specific yield as a function of the grainsize. Source Reference [3]

Storage coefficient

The *storage coefficient* is defined as the volume of water released from, or taken into storage, per unit surface area of the aquifer per unit change in the water level. In unconfined aquifers the storage coefficient is equal to the specific yield. For example, if during pumping, the water

table in such an aquifer drops by 0.8 m and the specific yield is 25%, the volume of water released amounts $0.8 \times 0.25 = 0.2 \text{ m}^3$ per m^2 of surface area. In confined aquifers, however, assuming that the aquifer remains saturated, a reduction of the hydrostatic pressure (as occurs during pumping) produces only a slight compression of the aquifer and expansion of the water, resulting in only a small change in storage. Values of the storage coefficient for confined aquifers fall in the range from 0.00005 to 0.005, whereas those for unconfined aquifers vary from 0.1 to 0.3. Hence, at the same pumping rate, the cone of depression (see Section 2.4) is generally larger in confined aquifers than in unconfined ones.

Permeability

Permeability is a measure of the capability of an aquifer to conduct water. If the connections between the pores are large, the water can flow easily and the permeability is high. It has the dimension of a velocity and is usually expressed in m/day or cm/sec. When the pores are not interconnected, water cannot pass through and the rock or soil is described as *impermeable*.

Some hard rocks can have a high permeability, despite the impermeability of the rock material itself. This is caused by faults and fractures in the rock through which the water can flow and is called *secondary permeability*. However, such aquifers are of no interest for the construction of hand drilled wells.

Conclusion

From Figure 8 which shows the data of Table 2.1 graphically, it is easy to see that the most suitable aquifers are those consisting of coarse sand and gravel. This does not mean, however, that layers of fine sand or even silt cannot be used for wells because the yield of the well is not only determined by the permeability of the aquifer, but also by its thickness (see also Section 2.4).

Note: The data of Figure 8 are valid for homogeneous aquifers only, i.e. with little variation in the size of the particles. In a heterogeneous material, e.g. a mixture of sand and gravel, the smaller particles fill the space between the bigger ones and block the passage of the water (Figure 9). This greatly reduces the specific yield and permeability of such a mixture.

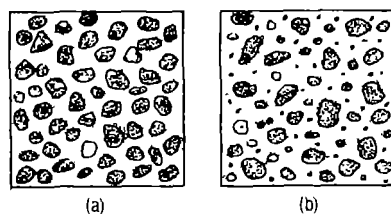

Fig. 9. (a) Homogeneous material (b) Heterogeneous material

Table 2.1 Characteristics of some unconsolidated sediments

Type of sediment	Gradation	Grainsize (μm)	Porosity (%)	Specific yield (%)	Permeability (cm/sec)
Clay		< 2	45-55	3-5	10^{-8} - 10^{-6} (very low)
Silt ^{a)}		2-50	40-50	5-10	10^{-6} - 10^{-3} (low)
Sand	fine	50-250	30-40	10-30	10^{-3} -1 (moderate)
	medium	250-500			
	coarse	500-2000			
Gravel		> 2000	25-35	20-30	1-100 (very high)

^{a)} Often the terms silt and loam are used as equivalents. Loam, however, describes a combination of clay, silt and fine sand, and is a soil classification used for agricultural purposes

2.4 Basic well hydraulics

Groundwater movement

Groundwater flows under the influence of a pressure difference. It travels in an aquifer from borehole A to borehole B if the water table or piezometric level in B is lower than in A (Figure 10). The velocity at which the water flows is determined by the permeability of the aquifer and the slope or *gradient* of the water table. The gradient is defined as the quotient of level difference and distance. This relationship is known as *Darcy's law*¹⁾

$$v = k \times i \tag{2.1}$$

where v is the velocity of the groundwater, k the permeability of the aquifer and i the gradient of the water table or piezometric surface. The above formula is valid for the flow in one direction only, that is, horizontally, parallel to the plane of the section in Figure 10

The flow towards a pumped well is more complicated to describe mathematically, because water flows from all directions in the horizontal plane. This flow system is known as *radial flow*. However, the phenomena that occur can easily be understood by means of Darcy's law

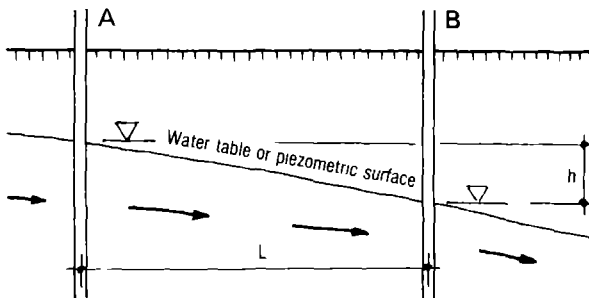

Fig. 10. The gradient of the groundwater table between A and B is defined as $i = \frac{h}{L}$

Flow towards a well

If water is pumped from a well, the water level in the vicinity of the well drops (Figure 11) and, due to the pressure difference, groundwater starts flowing towards the well. This drop in water level is called *drawdown*. It is the difference between the *static water level* (before pumping) and the *pumping level* (during pumping). The

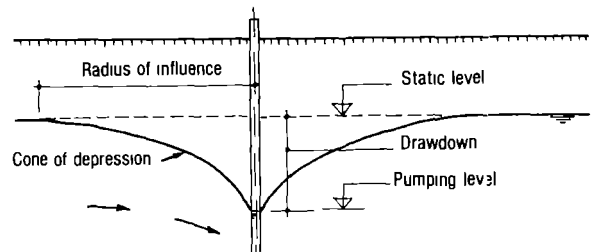

Fig. 11. The groundwater table in the vicinity of a pumped well

radial flow of groundwater implies that its velocity increases as it nears the well. Since - according to Darcy's law - the velocity is proportional to the gradient, the slope of the water table becomes increasingly steep towards the well. This effect causes the water table to assume the shape of a cone, known as the *cone of depression*, with the lowest point at the centre of the well.

With continued pumping the cone of depression expands. If the aquifer is extensive and no boundaries of constant level are present, this process, theoretically, continues indefinitely with time. However, the drawdown decreases logarithmically with time and distance from the well and consequently, after a period of pumping at a certain rate, the drawdown remains virtually the same. Furthermore, at some distance from the well, the effect of pumping on the water level is virtually zero. This distance is termed the *radius of influence*.

¹⁾ Henri Darcy, a French hydraulic engineer, investigated the flow of water through horizontal beds of sand to be used for water filtration, more than a century ago

The shape of the cone is influenced by the permeability in an aquifer of low permeability, the cone is deep with steep sides and the radius of influence is small. In highly permeable aquifers we find a shallow cone with a large radius of influence (Figure 12)

When pumping is stopped, the water level in the well rises again to the original static water level. The speed at which this *recovery* takes place is also important for the evaluation of a pump test: a fast recovery indicates a high permeability of the aquifer.

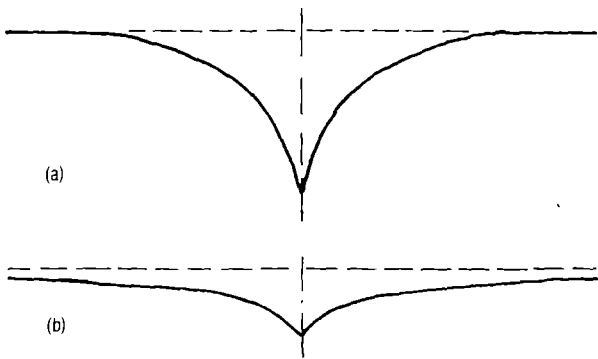

Fig 12 Different shapes of the cone of depression (a) in an aquifer of low permeability, (b) in an aquifer of high permeability

Well yield

If the flow towards a well has reached a condition of "equilibrium", i.e. one in which the drawdown changes negligibly with time, and the screen of the well penetrates the entire aquifer, the discharge or *yield* of the well can be written as

$$Q = \frac{2.73 k D s}{\log (R/r_w)} \quad (2.2)$$

where Q is the yield, k the permeability of the aquifer, D the "thickness" of the aquifer, s the drawdown in the well, R the radius of influence and r_w the radius of the well.

An important conclusion that can be drawn from the above formula is that an increase in the well diameter has only a limited effect on the well yield. For example, assuming R (radius of influence) = 20 m, then doubling the diameter of the filter pipe from 11 cm to 22 cm increases the yield by only 12%. A more substantial increase in yield, e.g. by 100%, can only be achieved by using a well diameter approximately 10 times larger.

Reduction of the screen length as shown in Figure 13 has a strong adverse (almost proportional) effect²⁾ on the well yield. For example, if the screen covers only half the thickness of a confined aquifer, the yield is decreased by approximately 40%. Therefore, wherever possible, the screen length should be equal to the full thickness of the aquifer.

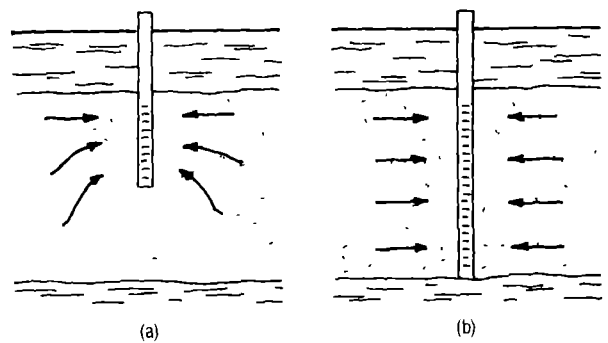

Fig 13 The yield of an "incomplete well" (a) is considerably lower than that of a well of which the screen covers the full thickness of the aquifer (b).

2.5 Groundwater level fluctuations

The phenomenon of well yields falling towards the end of the dry season is all too common throughout the country. Unaccounted for seasonal water level fluctuations are normally the cause of such events, although it is notably wells in unconfined aquifers which are sensitive in this respect.

Causes of fluctuations

Rises in water level are mainly due to recharge of the system by infiltrating rainwater. Although infiltration is governed by rainfall intensity and distribution, and also by surface run-off and vegetation, a clear relationship generally exists between rainfall and rises in water level. The main causes of a drop in water level are the natural drainage of groundwater, followed by the evapotranspiration of plants.

Particularly in tropical countries like Tanzania, with clearly defined dry and rainy seasons, it is very easy to distinguish one or two peaks per year in the groundwater level. An example of this is given in Figure 14 which shows the fluctuations of water levels as observed in different filter pipes in a deep borehole near Mtwara (Mbua Valley). In the year of observation (1975-1976) there was one continuous period of rain.

The graph also shows that the water level does not necessarily rise immediately after the start of the rains. There is often ½ to 1 month time lag, due to slow percolation: the dry soil has to be wetted before it allows water to penetrate deeper. On the other hand, as soon as the rains have stopped, the water level starts falling.

¹⁾ For confined aquifers D equals the actual thickness of the aquifer; for unconfined aquifers D equals half the drawdown in the well.

²⁾ This effect can only be derived from (2.2) by approximation since this formula is based on the assumption of horizontal flow, whereas in this case the flow towards the well is truly three-dimensional, the mathematical description of which is much more complicated.

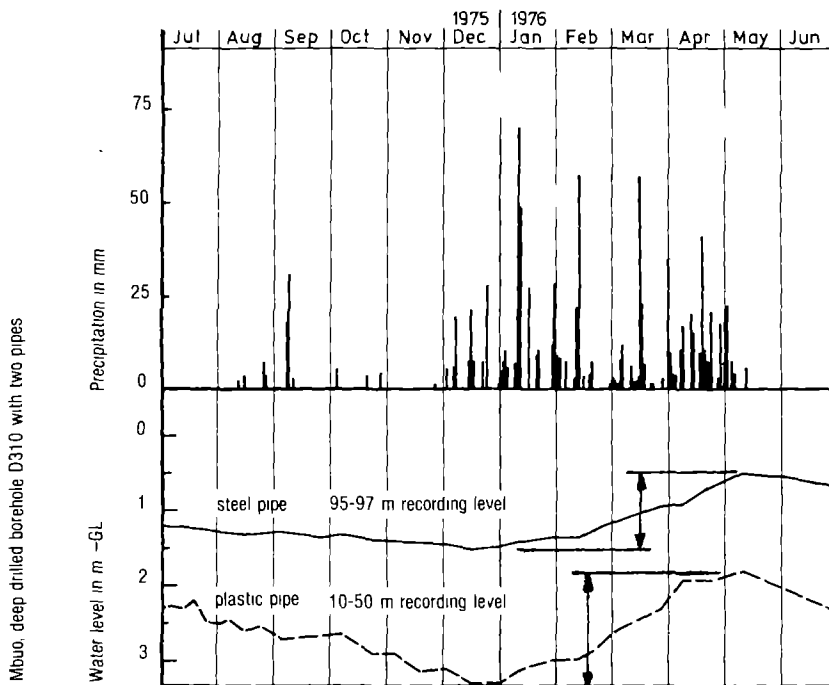

Fig 14 Recorded groundwater levels in a borehole in Mbuo Valley, Mtwara
Source Reference [12]

Influence of fluctuations in water level on water quality

Through evapotranspiration from an unconfined aquifer, the salts which are dissolved in the water remain behind and the salt content in the aquifer increases. Therefore a drop in the water table is often accompanied by a deterioration in water quality. Although the effect is strongest in unconfined aquifers, it is also felt in confined and semi-confined aquifers. How seriously entire areas can be affected, is shown in Figure 15. During the Water Masterplan studies villages all over Coast and Dar es Salaam Regions reported that shallow pits usually deteriorate in quality towards the end of the dry season.

This is again demonstrated in Figure 16. In the borehole shown in Figure 14, in Mbuo Valley, Mtwara, the electrical conductivity E.C (a measure of salt content) was determined at different depths and different times of the year. By the end of the dry season the E.C. had increased by more than 40%

Note: Figure 16 also shows that the E.C increases with depth. This is due to the fact that water in deeper layers has been in contact with the original or weathered bedrock for a longer period and therefore has a higher mineral content.

Consequences for surveying

A surveyor will be interested in the maximum annual water level fluctuation that can be expected in a certain area. The safest method of eliminating all uncertainties would be to investigate sites towards the end of the dry season only. For practical and economic reasons this is

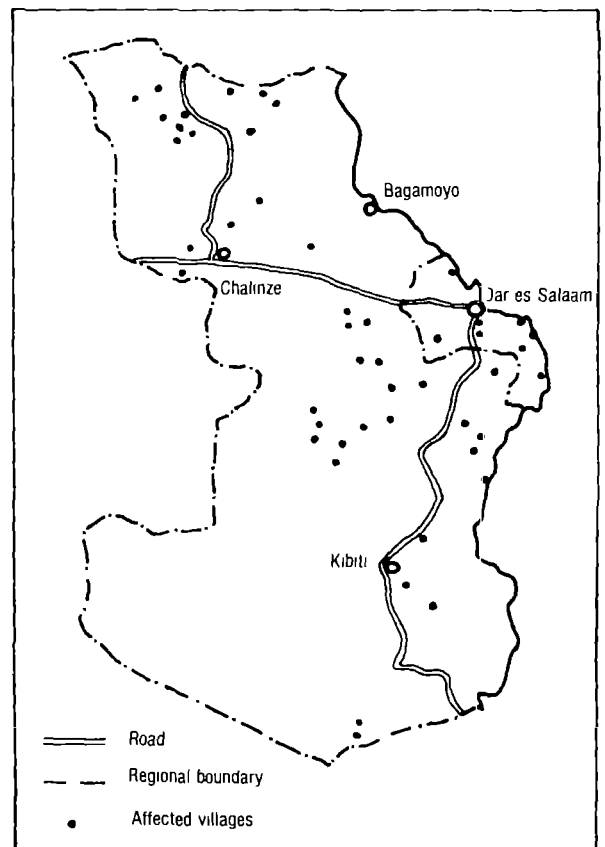

Fig. 15. Deterioration of the water quality in shallow wells during the dry season in Coast and Dar es Salaam Regions. Source: Reference [2].

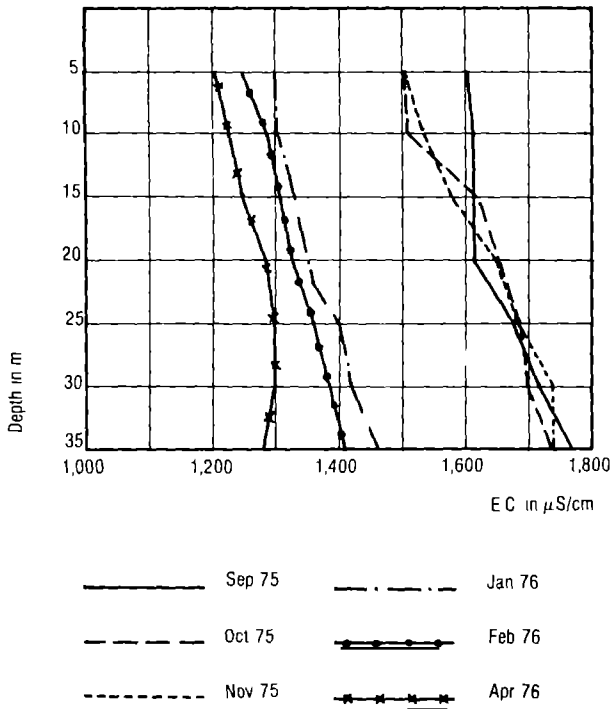

Fig. 16 Recorded E.C. values in a borehole in Mbuo Valley, Mtwara Source: Reference [12]

quite impossible but fortunately there are easy ways to collect information. Moreover, it is important to know how, by an intelligent choice of site location and aquifer, the fluctuations in a well can be minimized.

As will be explained in Chapter 5, some of the criteria applied for approval of a borehole for construction - test yield and E.C. - may have to be adjusted if the survey takes place during the rainy season. In this way, a good well yield and reliable water quality can be guaranteed throughout the year.

Where to find information

- * Some information can be obtained directly from the working area. Water levels in open ring wells or hand dug holes which get water from the aquifer under investigation are generally well-known by the villagers.
- * More general information can be found in water masterplans, agricultural studies, etc. Data in these kinds of publications are often based on prolonged observations of a few boreholes in a relatively large area. It will be obvious that such data can only give a rough indication and should be handled with care. Local situations may vary a great deal.
- * In areas where the fluctuations are considerable, for example 3 to 10 m, or where absolutely nothing is known about fluctuations, it might be wise to carry out the survey at the end of the dry season. In the latter case the water levels in several test boreholes should be recorded at least until the end of the rains so that the maximum fluctuation is established and can be applied to other sites in the area.

Choice of aquifer

In Tanzania, the seasonal fluctuation in deeper (confined or semi-confined) aquifers is generally smaller than that in unconfined aquifers: percolating rain and evapotranspiration are felt more directly in an unconfined aquifer. For example, in Figure 14, the water levels in the subsequent unconfined and confined aquifers show maximum fluctuations of 1.4 m and 0.9 m respectively. Investigation of a borehole should therefore not be stopped as soon as an unconfined aquifer has been found. A well in a confined aquifer has less chance of drying up and is also better protected against contamination by the overlying impermeable layer.

Chapter 3

Origin and Occurrence of Unconsolidated Sediments

Unconsolidated sediments ¹⁾ are potentially the most productive geological formations for the exploitation of shallow groundwater by means of hand drilled wells for the following reasons:

- they are relatively soft and easy to drill so that both investigation and construction are cheap;
- where they are found in valleys, groundwater levels are often closest to the surface and therefore no expensive pumps are required;
- the specific yield and permeability are generally higher than those of other types of rock.

In this chapter, some basic geological processes which contribute to the formation of these sediments, are discussed briefly. Methods are given for test drilling at locations where such sediments are most likely to occur.

3.1 The process of weathering

Any type of rock at the earth's surface is attacked and decomposed sooner or later by the action of the atmosphere, rainwater and organisms. The original rock breaks down into small pieces and, during this process which is known as *weathering*, its chemical composition is changed. Thus a topsoil is formed and the succession of layers, as shown in Figure 17, can normally be found in nature.

When all the material remains at the same place, the weathering process will stop after some time. If the top soil is carried away by erosion, the process continues.

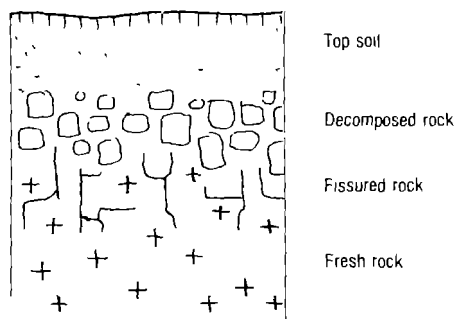

Fig 17 Solid rock disintegrates into soil by the process of weathering

Types of weathering

There are two types of weathering: mechanical and chemical, of which the latter is the most important in tropical areas. Both processes intensify the action of the other.

Mechanical weathering

- a) Rock is heated in the hot sun and expands. When sudden cooling occurs, e.g. by rain, the rock shrinks and cracks can develop in its outer layers.
- b) Roots of plants and trees can penetrate small cracks in the rock. When the roots grow in thickness, the cracks are widened and the rock splits apart.

Chemical weathering

Reactions occur between the minerals in the rock and chemical substances such as carbon dioxide, oxygen and organic acids which are dissolved in the water. Through these reactions the solid rock disintegrates and the original minerals are changed; for example, in the case of silicates, into clay minerals.

This chemical weathering has an important secondary effect: some of the original rock minerals are dissolved in the water. They largely determine the chemical composition of both groundwater and river-water.

Products of weathering

In particle size, the weathering products range from stones to gravel, sand, silt and clay. They may be derived from various types of rock such as granite, gneiss, basalt, limestones, siltstones and sandstones.

¹⁾Sediments which still have a loose structure and have not yet become solid under the influence of pressure from overlying layers and of time.

Typical products of chemical weathering in the tropics are the very thick red soils which mainly consist of.

- iron oxides, which give the soil its red colour;
- clay minerals, with aluminium and silicon as components

In areas with intensive rainfall, chemical weathering can be more extensive: the silicon is partly removed and the iron oxide content is increased. Such a soil is called a *laterite*. It can be very hard when dried out and can be a troublesome obstacle in hand drilling.

Weathering of granites needs special attention because the weathering products often form very good aquifers. Granites consist of several minerals, some of which have little resistance to weathering. Generally granites are cut by fractures several metres apart. Rainwater can intrude and along these fractures the rock gradually disintegrates into coarse grit, mainly consisting of quartz sand which is highly resistant. If this grit is washed away by rain, core stones remain behind forming outcrops called *tors* (Figure 18). These characteristic granite outcrops are found over large areas of the country, from the south (Mbeya, Iringa) to the north (Shinyanga, Mwanza).



Fig. 18. A granite "tor" near Iringa town

The weathering products of basalts, on the other hand, do not form good aquifers for tube wells. Basalt is a fine-grained rock which, after weathering, leaves a material of low permeability. Concrete ring wells with overnight storage capacity might be more suitable in such areas.

3.2 Slope erosion

Weathered rock material is usually carried down slopes by gravity, gradually eroding the surface of mountains, hills and even gently sloping areas. The intensity of slope erosion is highly influenced by:

- climate (intensity and frequency of rains, temperature),
- vegetation (type, density);
- characteristics of rock and soil (cohesion, permeability, resistance to weathering)

In the processes described below, water is the main agent for the erosion

- * Falling of loose stones: due to the fissuring process, the stones come away from the rock and form a slope of rock waste at the foot of the mountain.
- * Landslides: a mass of rock as a whole slides down a mountain (Figure 19). This usually occurs after heavy rains on steep slopes of rather soft rock, saturated with water

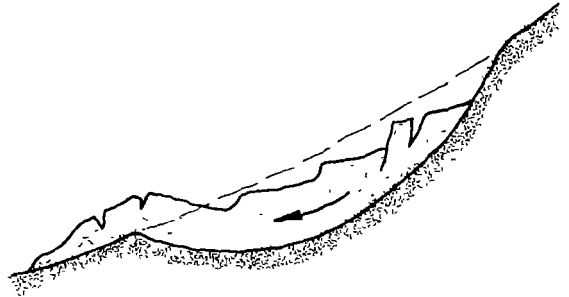

Fig. 19. A landslide

- * Washing away of topsoil by rainwater: when more rain is falling than can infiltrate, the remainder runs off over the surface. If vegetation is scarce, or not present at all, soil particles are carried away by the water. The effects can be very serious (Figure 20).

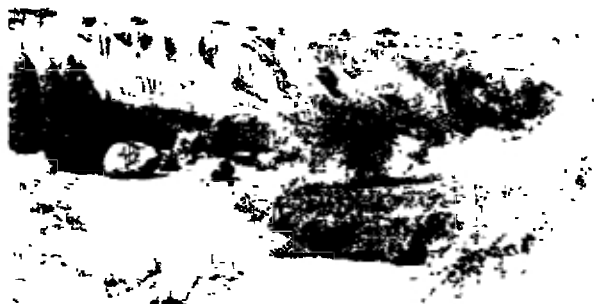

Fig. 20. Soil erosion in Singida Region. Photo Tanzania Government Information Service

Usually the surface run-off first collects in small gullies, the gullies then come together in streams and these develop into rivers which finally drain into the ocean and the lakes. Loose soil and rock particles can also be transported by wind and in areas outside the tropics ice can also contribute. In Tanzania, however, water is generally the most important factor.

3.3 Erosion and sedimentation by rivers

A river itself can be very erosive, particularly after heavy rains when the discharge, and therefore the transport capacity is high. The force of the water erodes both the bottom and the walls of the river-bed. The transported

stones and sand intensify this by their scraping and scouring action. As the velocity of the river-water decreases further downstream, the transported materials are deposited in the river itself and on the banks, in lakes or in the sea. Most unconsolidated sediments of interest for well construction were, and still are being deposited after transportation by rivers and these are called *alluvial sediments*. Apart from these there are also *lacustrine, marine and aeolian sediments*, deposited by lakes, the sea and wind respectively.

The "ideal" river

All particles transported by a river settle in time. The sedimentation rate mainly depends on:

- the size of the particles the smaller the particles, the further downstream they will be deposited,
- the velocity of the river-water the faster the water flows, the longer it will take before a particle settles in the river-bed.

Every river tends to develop an *equilibrium profile* along its length. Suppose a river originally flows from A (top of mountain) to B (sea) along a uniform slope (stage 1 in Figure 21a). Due to acceleration of the water it starts to erode the lowest part of the slope (stage 2). Through *backward erosion* stages 3 and 4 are successively developed. Stage 4 is known as the equilibrium profile. It has the approximate shape of a parabola, i.e. steep in the upper part and quickly flattening out downstream.

In a river with this regular longitudinal profile, the velocity of the river-water gradually decreases going downstream (Figure 21b) and the smallest particles are deposited furthest downstream (Figure 21c). This natural process is known as *progressive sorting*. The course of such a river is normally divided into three stretches: the *upper, middle and lower course*, and the sediments most suitable for the construction of tube wells are found in the middle and the lower course of the river.

Upper course

In this stretch the river is highly erosive and the river-bed is generally deeply incised, forming a V-shape (Figure 22). Occasionally in the dry season - when the velocity of the water is lower - some sand may be deposited, but this is immediately washed away by floods in the rainy season. Therefore only large stones and gravel will be found here. These sediments are of no use from the point of view of well construction.

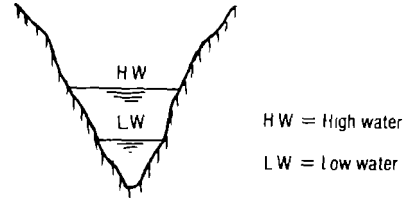

Fig 22. In the upper course of a river no suitable sediments are found.

Middle course

Here the valley and the river-bed are usually wider and the river both erodes and deposits. In the dry season (at the lowest rate of flow) the river is commonly found winding through its own sediments which largely consist of fine gravel and sand (Figure 23a). During the rains when the water level rises and the velocity increases, these sediments are often eroded again. They are not only transported further downstream but, due to lateral currents, also deposited at the sides (Figure 23b).

Lower course

Further downstream the river usually flows through a wide plain where deposition mostly takes place with very little erosion. At low water levels only a little fine material is

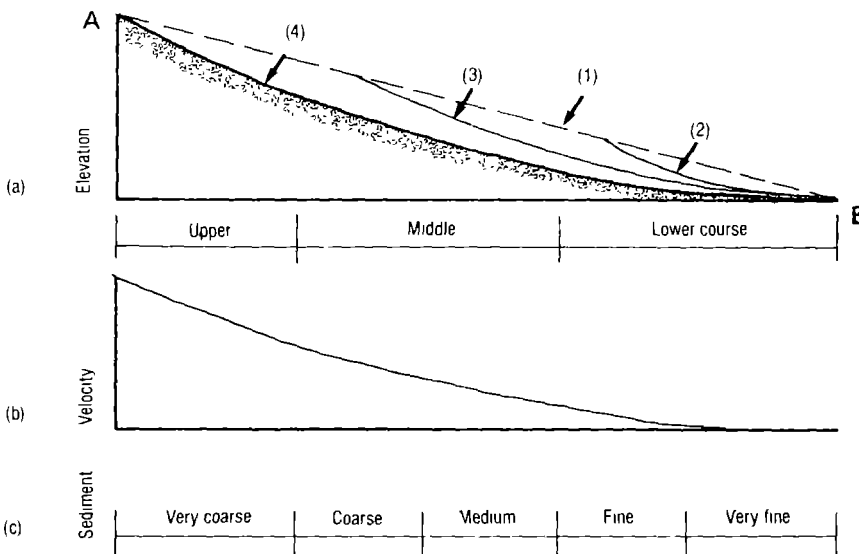

Fig 21 (a) Development of the "equilibrium profile" of a river. (b) Velocity of the river water in an "ideal river". (c) Sedimentation pattern in such a river.

transported (the coarser particles having already settled in the higher reaches of the river). With an increased river discharge, the sediment load also increases. If the river then floods the plain, the coarser material settles just outside the river-bed, forming slightly elevated river banks. Beyond the banks only very fine sand, silt and clay are deposited and thus thick clay beds can be found in the flood-plain (Figure 24)

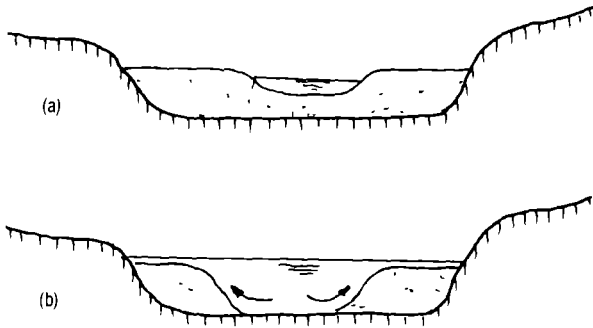

Fig 23 The middle course of a river showing sand banks: (a) in the dry season, (b) in the rainy season

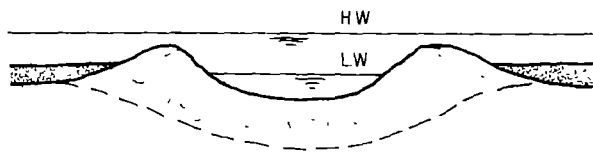

Fig 24 A typical section of the lower course clay deposits in the flood-plain beyond the river banks



Fig 25. An example of a meandering river: the Little Ruaha near Iringa town.



Fig. 26 Erosion and sedimentation in the bends of a meandering river.

Deviations from the regular pattern

Well-sorted sedimentation as described above for an "ideal" river with a regular longitudinal profile seldom occurs in nature. Differences in geological structure along the course of a river may cause irregularities in this profile and therefore also in the sedimentation pattern. Other disturbances in the normal sedimentation pattern may be caused by

- the inflow of tributaries with a high sediment load (the merging of the Blue Nile with the White Nile in Sudan is a well-known example),
- sedimentation of particles in natural or artificial lakes (the velocity of the river-water is strongly reduced so that virtually all transported material is deposited in the lake),
- severe floods, washing away previously deposited sediments.

It would be beyond the scope of this manual to discuss all these phenomena in detail. Three important examples, however, are given below

- a) In the middle and particularly the lower course where the river flows in a wider valley or plain, it often winds or *meanders* (Figure 25). In the bends of such a river both erosion and sedimentation take place. The outer banks are eroded due to the higher water velocity on that side of the river, while on the inner banks sediments are deposited, not only due to the lower velocity, but also due to lateral currents in the river (Figure 26). These sediments show a gradation upwards from gravel to coarse sand (good aquifers!) at the bottom and silty clay at the top.

The result of these processes is that the bends tend to move further and further outwards, until short-circuiting occurs (see arrow in Figure 25). The sickle-shaped abandoned part of the river is then very slowly filled up with fine sediments (mainly clay), but with sand and gravel found at the ends.

- b) Due to hard layers at point C, the river cannot further erode its bed backwards and the profile shows a sharp bend (Figure 27). Upstream of C fine material is deposited. At point C the river ceases to deposit and begins to erode again. A short distance downstream of this point coarser deposits can be found again.

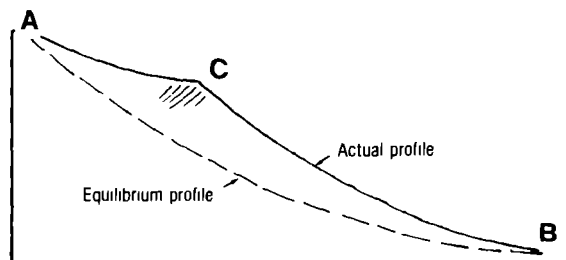

Fig. 27. A discontinuity in the longitudinal profile of a river caused by more resistant rocks at point C.

c) The river profile is disturbed by a fault in the rocks at point D (Figure 28) The velocity of the water decreases rapidly there, resulting in large quantities of sediments They are often deposited in a cone or *alluvial fan* of which an overhead view is given in Figure 29 An alluvial fan generally contains rich aquifers

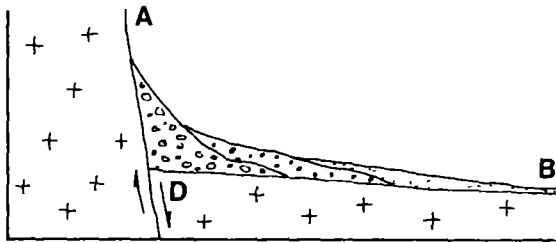

Fig. 28. The equilibrium profile can also be disturbed by faulting of the mountains



Fig. 29. Aerial photograph of an alluvial fan at Lake Mansi, south of Dar es Salaam. Note the typical triangular shape Source. Reference [2]

The longitudinal profile (as derived from topographical maps) of the Wami River with some of its tributaries (Figures 30 and 31) clearly shows a combination of cases b) and c) Case b) is found between Dakawa and the Tanga-road bridge, and case c) occurs near Kilosa where Mkondoa River comes down from the Rubeho Mountains

A river profile such as this can give us a clear indication of the possible locations of good aquifers. For example, from this profile we might conclude that the area east of Kilosa is very suitable for the construction of wells, whereas in Dakawa it will be more difficult to find good aquifers (which in reality is the case)

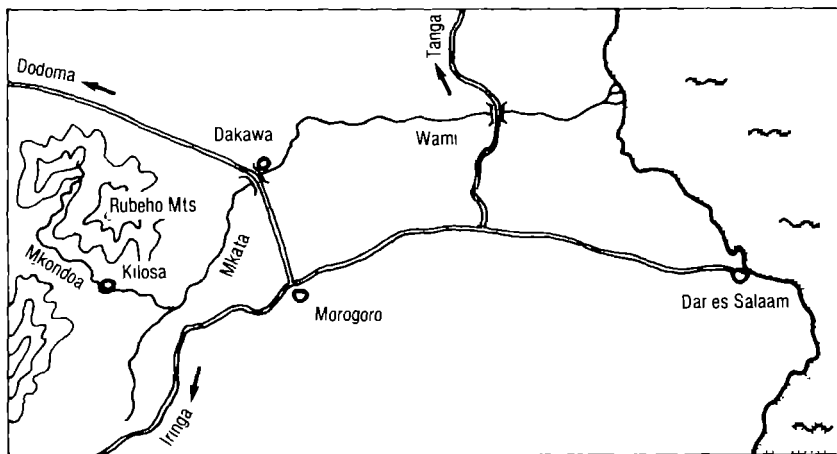

Fig. 30. The course of the Wami River and some of its tributaries

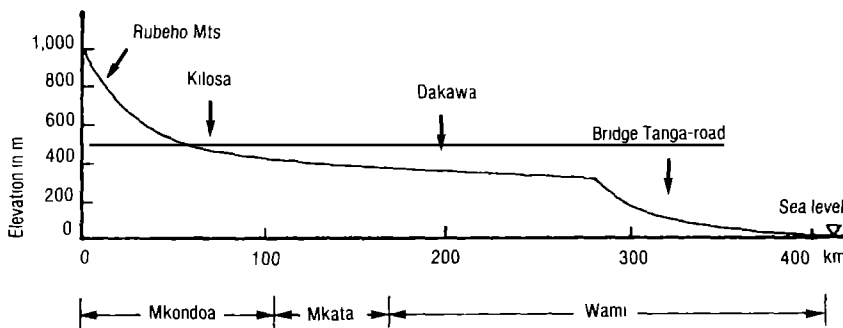

Fig 31 The longitudinal profile of the Wami River.

3.4 The search for aquifers

The sediments of interest for groundwater exploitation are normally covered by formations of more recent date and are therefore not visible from the surface. Moreover, these older sediments were often deposited at places which - at first sight - have no, or little, correlation with present-day locations of sedimentation. The geological history of large parts of the country, however, is only known in rough outline and detailed studies have virtually always been aimed at the exploitation of ores, minerals or deep groundwater. Little knowledge therefore exists about the exact position of water bearing formations in the upper 20 m of the ground (20 m is about the maximum depth of hand drilled wells).

Nevertheless, without detailed knowledge of an area, some hydrogeological sites with reasonable prospects of shallow groundwater, can be detected by an experienced eye from the topographical and landscape features of the area. For a number of typical hydrogeological sites in Tanzania, possible approaches to test drilling which have proven their value in practice are described below. The purpose of the given drilling patterns is to collect, in the most economical way, information about the substructure and to avoid inefficient random drilling. It should be remembered however, that it is impossible to give a straightforward plan of operation for every different situation and that drilling patterns often have to be adapted locally. The order in which the described sites are found in nature, is from the mountains towards the sea approximately.

Alluvial fans

The formation of alluvial fans has already been discussed in the previous section. They are mostly found along mountain ridges bordering *tectonic valleys* or wide river valleys. Tectonic valleys owe their origin to movements of the earth crust rather than to erosion by rivers. For example, the East African Rift Valleys have been developed between sets of parallel faults during an upheaval of the earth crust (Figure 32).

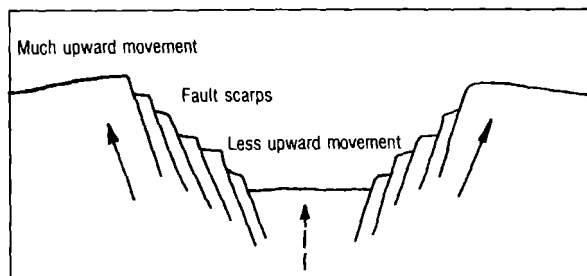

Fig 32 Formation of the Rift Valley. Source: Reference [13]

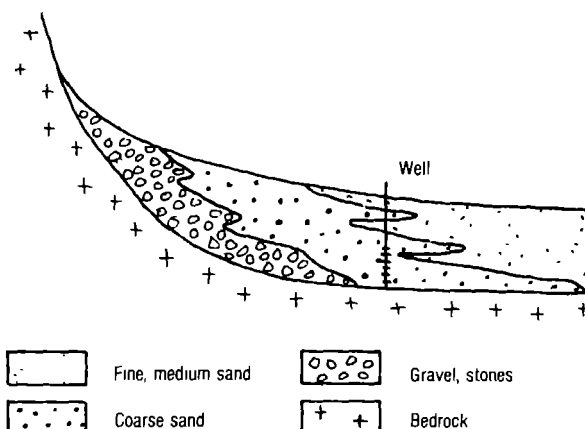

Fig 33. An alluvial fan site

Pediments

These are very gently sloping areas at the foot of mountain ranges or individual mountains or hills (Figure 34), often combining to form vast *pediplains*. They are usually underlain by the bedrock, the upper part of which is weathered and covered with a few metres of silty soil. Because of the generally open vegetation in these areas, the weathered material is easily washed away by rains and this allows weathering of the bedrock to continue.



Fig 34. Pediments at the foot of the Uluguru Mountains near Morogoro town.

The best locations for wells are usually some distance from the mountains, in order to avoid large quantities of stones which may have been deposited there (Figure 33). Test drilling should take place along profiles perpendicular to the mountain range, in order to find the transitions from fine to medium to coarse deposits and where they are bounded by the bedrock. Drilling should start in the lower, flat area and then move to sites further uphill. Wells should not be located too high on the slope: although the aquifers may be more permeable because they consist of coarser material, they can easily run dry in the dry season.

The best prospects for well sites are in depressions, small valleys and, of course, near pools and wet places. A number of boreholes should then be drilled along two profiles perpendicular to each other.

If the mountains from which the pediment originated consist of granite, suitable aquifers may be found at the foot of the granite outcrops. Figure 35 shows a typical section.

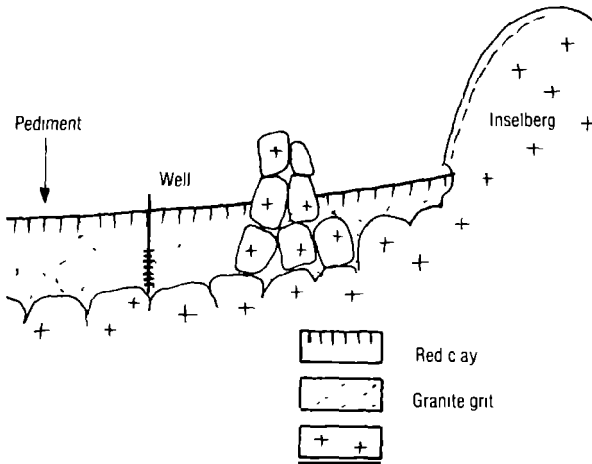

Fig 35 Formation of a pediment at the foot of granite rocks. Note that the inselberg is eroded at the foot, causing the rock to be "peeled off" gradually. Source: Reference [18]

Small river valleys

Most valley deposits have a simple succession from coarse sands near the bottom to silts and clays at the top. It is important to trace the course of the buried valley in order to find out where the aquifer is deepest and thickest.

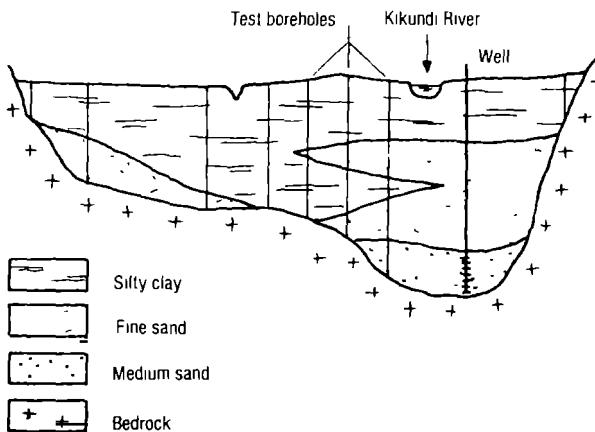

Fig. 36. Sediments in a small river valley: Kikundi River near Morogoro town

Therefore, test drilling should be carried out in profiles more or less at right angles to the current river-bed position. Figure 36 shows an example of the drilling pattern along a section of the Kikundi River valley at Melela village, 30 km from Morogoro town. How such a section is drawn, is explained in Section 4.6. Test boreholes were drilled 20 to 50 m apart and the best location for a well was easily found by this method. In order to reduce the danger of flooding, try to locate the wells as far as possible from the present river-bed.

Alluvial plains

In alluvial plains, often formed by large river systems in tectonic valleys, e.g. the Wami and Mkata plains, the sequence of layers is usually far from regular. Instead, alternating layers of sand, gravel, clay and silt occur and often more than one aquifer is found in a single borehole (Figure 37). It is also not at all unusual to obtain completely different borehole descriptions only a few tens of metres apart. Since the danger of flooding by the existing, much smaller, rivers is reduced, villages are often established on the plains and local dug wells are commonly used in this situation.

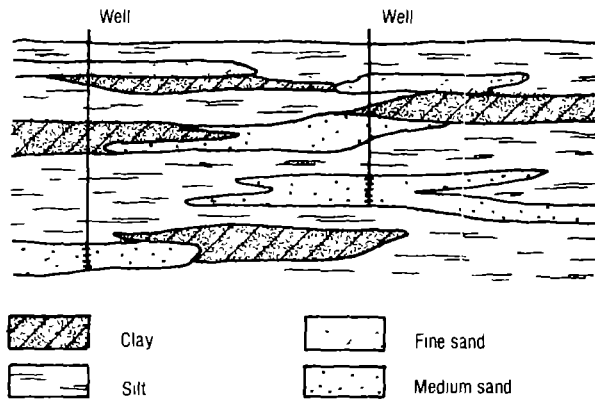

Fig 37 In alluvial plains often more than one aquifer is found in a single borehole

Because of the flatness of this type of area, it is rarely possible to predict the best locations for well sites from the surface. Drilling therefore has to proceed along parallel profiles at intervals of 50 to 100 m. In this way a clear picture of the hydrogeology of the area is obtained and the best well sites can be selected.

River terraces

A river terrace is the remainder of an earlier valley floor, into which the river has cut a new course. The formation of river terraces is mainly due to changes in sea level during

the glacial periods and to mountain formation, which caused changes in the longitudinal profile. The river has had to erode backwards into the sediments deposited previously. Particularly when the original valley was wide and the new incision is shallow, the terraces thus formed may contain good aquifers (Figure 38). These rivers are often seasonal, in the dry season, when the river-bed appears to be dry, there is actually a slow flow of underground water beneath the surface

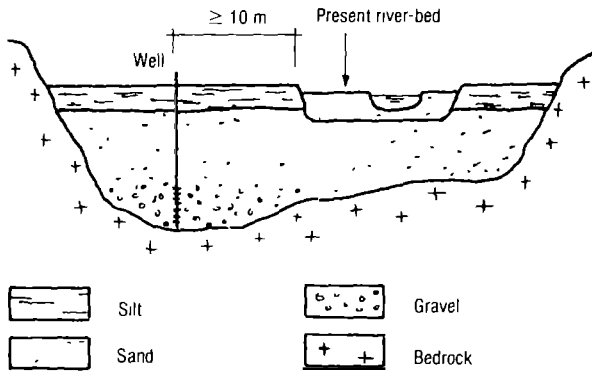

Fig. 38 A typical river terrace site

The best strategy for test drilling in these cases is to drill boreholes parallel to the direction of the valley at relative distances of about 50 m, and at least 10 m distance from the present river-bed. Where a promising aquifer is found, boreholes should be drilled along a profile across the valley, in order to find an underground connection with the present river-bed. Try to locate the well as far as possible from the river because

- natural filtration of the water will be enhanced,
- the well will be closer to the village,
- the risk of flooding will be smaller

Coastal plains

Particularly in the lower courses near the coast, rivers flowing in a wide plain are liable to change their course frequently. During high floods the river-banks may break causing the main stream to shift and start building a new bed in the fine material previously deposited outside the former bed. Afterwards the abandoned river-bed will be buried under new deposits of fine sediments. Such old, buried river-beds (Figure 39) can be very good aquifers

Test drilling in profiles across the plain, perpendicular to the main axis of the river, gives the best chances of locating such aquifers. In this situation, boreholes should be drilled at intervals of 100 to 200 m.

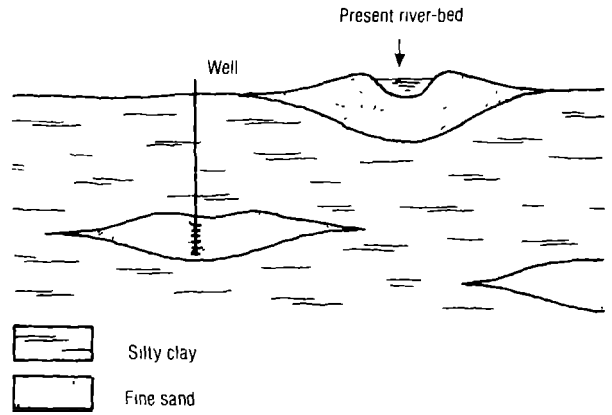

Fig. 39 Buried riverbeds offer good prospects for wells

Beach ridges, which are found along the coast, were formed by the ocean in former times, when the sea level was higher than at the present day. They are commonly underlain by very permeable sediments

Drilling should take place in profiles, perpendicular to the ridges

Springs

Good sites for wells can often be found near springs, where groundwater appears at the surface as a stream of flowing water. Springs occur in all kinds of rock, sometimes on mountain slopes, but also in valleys and depressions. Of interest are those springs which are fed by groundwater flowing in unconsolidated sediments

Since spring-water is traditionally highly valued by the population, villagers will always be able to tell a surveyor if springs exist in or near the village and whether they flow throughout the year

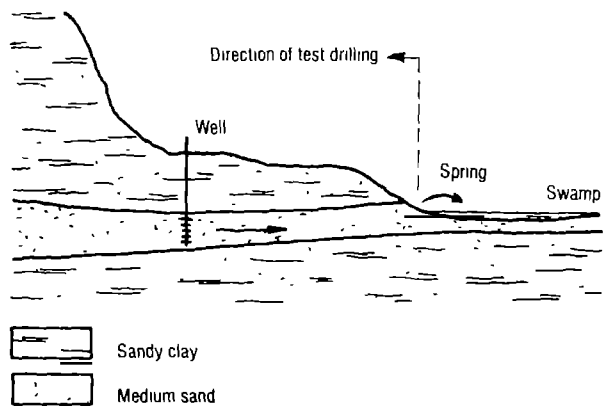

Fig. 40. A section of a spring in Chamazi village. site no. 186/3-15 (see also Figure 55)

Test boreholes should always be drilled going uphill away from the spring (Figure 40). The purpose is to find a location where the aquifer is more or less confined by overlying impermeable layers, in order to reduce the risk of pollution from the surface. If a suitable site is found on a slope, measures should be taken to protect the future well against soil erosion.

Dry valleys

The most economical way to collect information about the structure of small dry valleys, of limited width (100 to 200 m) and where no river flows, is the following.

Boreholes should be drilled along two perpendicular profiles: one profile in longitudinal direction in the centre of the valley, and the other one across the valley. The distance between the boreholes should be 20 to 50 m.

Site Investigation

The importance of proper site investigation cannot be stressed enough since this determines to a very large extent whether the performance of the wells will be satisfactory throughout the year.

There are many methods of exploring shallow groundwater, although they vary widely in investment, operational and maintenance costs, degree of difficulty of interpretation, skilled manpower requirements and effectiveness.

Some examples include:

- geo-electrical resistivity measurements;
- seismic refraction measurements;
- geophysical well logging;
- test drilling and pumping.

It is the last method which is preferred for detailed groundwater surveys for both hand drilled tube wells and hand dug ring wells. Apart from the fact that it can provide absolute certainty about quantity and quality, which none of the other methods can, test drilling and pumping is also a very cheap method, if carried out with hand operated equipment.

Most of the survey equipment can both be manufactured and repaired locally and almost everybody can learn to handle it properly in a short period of time. It does not require fuel and can easily be transported. For a detailed description of this type of equipment, see Appendix B.

4.1 Preparations in the office

No fieldwork should be undertaken without prior planning and study of the available documents relating to the area. The latter is normally done by the hydrogeologist in charge because it requires specialist knowledge.

Planning of the survey

In principle, planning of the survey in a District or Region is based on a list of villages with priority for improvement of the water supply conditions. When well construction is undertaken on a large scale, however, it may be more feasible to concentrate on entire areas rather than on individual villages because this greatly reduces transport costs.

When planning the survey of a village or area, the time of year must be taken into account. In areas where

- the groundwater level fluctuations are known to be very great, e.g. 3 to 10 m, or completely unknown, and/or
- the E.C. of the groundwater is known to have a value close to the highest acceptable level,

the survey is preferably carried out towards the end of the dry season (see also Section 2.5). At this time the water levels will be at their lowest and the water quality will be poorest. Any borehole in which the yield and water quality meet the criteria given in Chapter 5 can then be safely approved.

Another factor that influences planning is the accessibility of the villages. Where villages cannot be reached during the rains, any surveying has to take place in the dry season.

Study of existing data

Before fieldwork in the village starts, as much information as possible about the hydrogeological situation should be collected from existing reports, maps, etc. Most useful for this purpose are:

- * *Water masterplans*, which generally give a good picture of the existing supplies, the hydrogeology of the area (groundwater levels and fluctuations) and the possibilities for future supplies
- * *Geological maps*, which may give useful information on the characteristics of deeper layers and possible weathering products and which usually indicate alluvial sediments. However, since these maps are generally small scale, they are insufficiently detailed to indicate small aquifers which are often quite adequate for wells with a hand pump.
- * *Topographical maps*, which, although not providing information on the subsoil, indicate surface level features such as rivers, valleys and plains from which

information about groundwater can be derived (see Appendix E) Make sure that the part of the map under study corresponds with the actual location of the village most topographical maps have not been updated since the villagization operation, started in the early 1970s

- * *Aerial photographs*, which may give some clues about the presence of shallow groundwater from the types of vegetation and other characteristics of the landscape Interpretation is a highly specialized job.

Information from these data can, when combined, provide quite reliable predictions of groundwater occurrence. It should be noted, however, that water masterplans are sometimes inaccurate or even biased in their suggestions for future supplies For example, in some places, more expensive piped supply systems were recommended although, after detailed investigation, well construction appeared to be quite feasible Such recommendations may have been made because

- masterplan studies often have to cover a large area in a short period of time, with the result that smaller aquifers remain undetected,
- the technology of tube wells with hand pumps was not known at the time or was considered technologically inferior

4.2 Preparatory work in the village

For an optimal participation of the village in the water supply project and a self-reliant maintenance of the wells afterwards (see also Section 12.1), the actual site investigation - test drilling and pumping - should always be preceded by one or more meetings with the village authorities. At these meetings which could be organized by District or Regional Community Development staff, assisted by MAJI or the executing agency, agreement should be reached with the village government about:

- the election of a Village Water Committee to represent the village in all matters concerning the water supply and water-related developments;
- the required number of wells in the village,
- the mobilization of self-help labour in all stages of the project,
- the responsibilities of the village for proper upkeep and maintenance of the wells

The tasks of the surveyor during these visits should be

- an explanation of his work and working methods,
- a reconnaissance of the village in order to assess the required number of wells,
- an initial selection of well sites in close cooperation with the villagers

Reconnaissance of the village

In order to collect relevant information about the present water supply conditions, the hydrogeology of the area and

the layout of the village, the surveyor should make an orientation tour through the village, accompanied by members of the Water Committee This walk around the village is a very important part of the survey work and should not be undertaken by car! It does not matter if it takes a whole day or even two or three days proper selection of the sites saves a lot of drilling work The following equipment is required during this tour.

- water level meter,
- E C. meter,
- compass,
- topographical map;
- paper and pen

The surveyor should always find out where the villagers draw their water at present. Existing wells, hand dug holes or springs may reveal aquifers suitable for wells, particularly if they provide water throughout the year The villagers who built these wells can often give further information such as the depth of the aquifer or difficulties met while digging The depth and the water level of these sources should be sounded and the E C should be measured as well to give an indication of the quality of the groundwater

The landscape features provide information about the hydrogeological conditions and notice should be taken of rivers, streams, valleys, swamps, mountains and other features of the area. Certain types of vegetation such as papyrus, date palm, certain species of *Ficus* and crops like bananas, yam and sugar cane, indicate the presence of shallow groundwater (Figure 41).

In order to get a clear picture of the layout of the village a sketchmap should be drawn, showing the boundaries of the village, the settlement pattern, the roads, streams, power lines, most important buildings, existing wells and other



Fig. 41 The date palm is an indicator of fresh shallow groundwater. Photo Royal Tropical Institute, Amsterdam.

prominent features Distances can be measured by counting steps and should be marked on the sketchmap The north arrow should also be marked having determined the direction with a compass

Required number of wells

How many people can be served by one well, depends on the average daily water consumption per head of population and the maximum quantity of water delivered by the pump during water collection hours

The average consumption in villages with access to a reliable supply is at present 15 to 20 litres per person per day. New water supplies are commonly designed for a service period of 20 years In this period the consumption level will definitely not remain the same because availability of the water and the awareness of its benefit increases demand Therefore a prognosis should be made of the water consumption after 20 years, to which the capacity of the water supply system will have to be attuned

For the rural areas the design criterion for water consumption in the coming 20 years is set at 30 litres per person per day

This criterion prescribes a water allowance, rather than giving a real estimate of future demand However, given the present consumption level and the policy of MAJI to restrict services in the rural areas provisionally to domestic water points (i e no taps inside the houses yet) in order to serve as many people as possible within the limited budget, the above criterion seems reasonable.

Water is commonly collected during two peak periods, namely from 6 00 to 9 00 in the morning and from 3 00 to 6 00 in the afternoon, making a total of six hours If the pump has a capacity of 1,000 to 1,500 litres per hour, a total quantity of 6,000 to 9,000 litres per day is drawn from a single well With a water consumption of 30 litres per person per day, such a well can serve 200 to 300 people, or an average of 250 people

Therefore, theoretically, the required number of wells in a village equals the total population divided by 250 For example, in a village of 1,500 inhabitants, 6 wells will be required

However, the distribution of the houses and the layout of the village may influence this number. Where villages are very spread out or even split up into several sub-villages, the walking distance from the houses to the wells may become decisive Although the two villages A and B in Figure 42 have the same number of inhabitants, more wells will be required in village B because of the way it is spread out along the road.

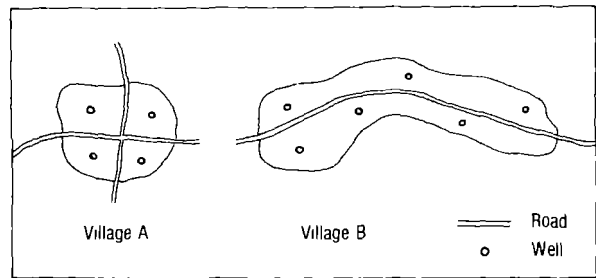

Fig 42 The required number of wells in a village is not only determined by the number of inhabitants, but also by the settlement pattern

Initial selection of well sites

With the aid of the information gathered during the village tour, sites are selected for test drilling Each site has to fulfil the following conditions:

- it should be within a distance of 400 m of that part of the village for which the well is meant to serve and must be acceptable to the villagers,
- it must be safe from flooding,
- it must meet environmental criteria, i e. be at least 50 m from pit latrines, cattle pools, etc. (see also Appendix C),
- it must be accessible to the villagers throughout the year,
- it should be located in such a way that spill water and rainwater can be drained away from the well

Exceptions may be made in cases where no alternative solutions are available For example, if no suitable site can be found within the maximum walking distance, either a longer walk has to be accepted, or the houses have to be moved closer to the available source. Furthermore, when planning the sites, a well should be located near the school and another near the dispensary Such wells may have a very favourable effect on the health conditions in the village

The proposed sites should be plotted on the village sketchmap, so that it is easy to check if each part of the village is served equally (see sketchmap of Chamazi village near Dar es Salaam in Annex 1)

4.3 Test drilling operations

A surveyor never knows what kinds of soil he is going to encounter and he has to develop a certain feeling for handling the equipment For example, he should know:

- under which conditions drill-bits should be changed;
- how much force can be applied to the drill-rod and casing without damaging them,
- how many strokes it takes to fill the bailer, etc.

All these "tricks of the trade" can only be learned from experience in the field and every surveyor, after some

time, will develop his own style of working. However, the principles of drilling as described in this section remain the same for all.

Preparations at the site

When choosing a location for a borehole, make sure that no power transmission or telephone lines are just above the working area. Touching such wires with the extension rods can be fatal. Although the shade of a tree can be attractive, it is better to locate the borehole a little away from the tree itself because

- the extension rods may get tangled in the branches,
- it may not be possible for the construction team to set up a tripod or install the long filter pipe close to the tree trunk.

Secondly the drilling place has to be cleared. An area of 2 x 2 m around the borehole is sufficient, but a space should also be cleared for laying out the soil samples.

The ten-cell leader living nearest to the site can be asked to store the drilling equipment for the night. This will save transporting the equipment every day from camp to site and vice versa. A simple trolley is a practical means of transporting equipment from site to site (Figure 43).



Fig. 43 Transport of surveying equipment in the village

Drilling without casing

Normally drilling is started with the ϕ 100 mm combination or riverside auger of the light-weight set (Figure 44). If the topsoil is very dry and hard, it may be necessary to break up the upper layer with a hoe or pickaxe. It is advisable to drill a pilot hole with the ϕ 70 mm augers in cases when

- drilling in very stiff soils, e.g. heavy clay,
- surveying in difficult areas, where a large number of test holes is required for each approved site.

As soon as an aquifer has been found, the borehole is then reamed with the ϕ 100 mm bits, so that the casing can be inserted.



Fig. 44 Test drilling is normally started with a combination auger of 100 mm diameter



Fig. 45 If the soil is too hard, the heavy-weight set can be used.

In hard or stony layers, when little or no progress is being made, the sturdier heavy-weight set which is operated by four men instead of one, may be more effective (Figure 45).

The borehole must always be as vertical as possible: a slanting borehole may give problems at greater depth, both for the drilling operations and for the installation of the casing.

If the first metre is vertical, the rest of the borehole will almost automatically be vertical as well. Assembly and disconnection of the drill-rod has to be done in pieces not longer than 3 m, i.e. max. 3 extension rods at a time,

in order to prevent bending of the rods. Drilling with the ϕ 100 mm bits is continued until the borehole starts caving in. This is quite easy to see because either

- the soil is too loose to remain in the auger so it is pulled up empty, or
- there is no progress in the drilling, i.e. the borehole does not become any deeper

This collapse or *caving* of the borehole can be expected particularly in sandy layers below the water table (Figure 46), although even silty layers show the same tendency. Where caving occurs, a casing pipe has to be inserted to retain the borehole wall and the wet sand has to be removed by means of a bailer.

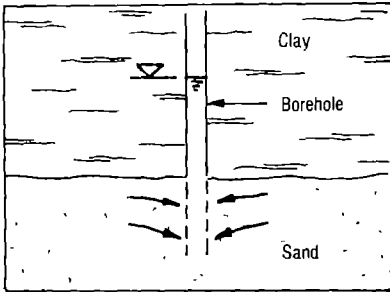

Fig 46 Caving of a borehole occurs in sandy layers below the water table

Bailing in the casing

The casing is lowered section by section into the borehole with the slotted pipes first, the lower one with the casing shoe, so that the total screen length is 3 m. On top of these come the plain pipes. Always remember how many sections have been installed in order to ensure that the screen has really reached the aquifer when the pump test is started.

The most effective way to use the bailer is to move it quickly up and down in the upper 10 cm of sand. As a result a kind of *quicksand* (sand particles "floating" in the water) is created, which facilitates the flow of sand into the bailer. The bailer should never go deeper than 10 to 20 cm below the casing shoe, otherwise excessive caving will occur.

When the bailer is pulled up it will be full of sand and water withdrawn from the borehole. This will make the water level inside the casing drop, resulting in a flow of water and sand from underneath into the casing (Figure 47a). In order to prevent this, a bucket of water should be poured into the borehole before the bailer is taken out (Figure 47b).

Note: Take care that no water is spilled outside the casing. It will wash the sand in around the pipe and make it difficult to remove.

The casing must be lowered as bailing takes place, otherwise the borehole will not become any deeper. A casing clamp is used to push the casing down, thereby rotating it clockwise (Figure 48). This job should always be done by one person only, otherwise the casings may be damaged. As soon as a more solid layer is reached, bailing



Fig 48 The casing has to be lowered while bailing and is rotated clockwise

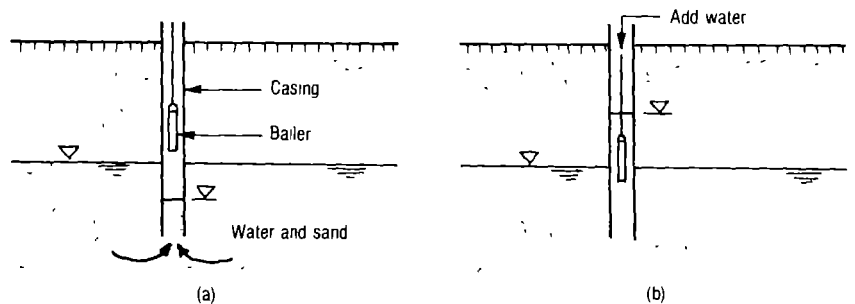

Fig. 47. The flow of sand into the borehole (a) can be prevented by adding water before the bailer is lifted (b).

should be stopped and the casing is pushed into this layer, unless it is bedrock, in order to prevent further caving.

Whether or not to do a pump test should be decided at this point. If the aquifer is well protected by a clay layer and its thickness and grain size look promising, a pump test should be performed. If the test results turn out to be unsatisfactory, drilling can always be continued. If, on the other hand, the aquifer is unconfined, it is generally advisable just to continue drilling in the hope of finding a deeper aquifer, without performing the pump test.

If an aquifer is struck which has an E.C. value higher than the allowable standard ($2,000 \mu\text{S}/\text{cm}$), this does not automatically imply that the pump test must be omitted or that drilling must be stopped. It often happens that the E.C. value decreases during the pump test (see Section 5.2).

Drilling down to a second aquifer

Further drilling should take place inside the casing with the $\phi 70$ mm augers, with the casing being left initially where it is, to seal off the upper aquifer. It is only pushed further down into the borehole if a deeper aquifer is actually found. By this means, a lot of unnecessary hard work can be avoided because it can never be known beforehand if a second aquifer is actually found.

When the casing has to pass through very stiff clay, for example, it may be tempting to push it down with two or more persons. Again this should never be allowed when using ABS casings, for this equipment has been designed for operation by a single person only! If it is impossible to continue down any further, the only solution is to start drilling at another location.

The screen of the casing is lowered into the second aquifer by means of bailing as described above. Where possible, the casing is pushed into an underlying layer so that sand will not enter the borehole and affect the pump test. After the pump test is finished, the casing is retrieved by both pulling and rotating it (also clockwise). Rotating is essential since this greatly reduces the friction between pipe and soil.

4.4 Survey pump test

When a promising aquifer has been found, a pump test of one hour duration and some simple water quality checks must be carried out. "Promising", in this respect, means a confined aquifer of at least 1 m or an unconfined aquifer of 4 to 5 m thickness, with an E.C. preferably under $2,000 \mu\text{S}/\text{cm}$. If the E.C. is much higher the pump test should be omitted and a new borehole drilled.

The test described here is not a true pump test, from which the characteristics of the aquifer - permeability, storage coefficient - can be calculated. Such a test would require at least one more observation borehole, a pump of constant discharge and a longer testing period. However, this simple test gives sufficient information to base decisions upon.

Test procedure

The following equipment is required for a survey pump test:

- hand operated test pump,
- water level meter,
- watch or alarm clock,
- 1 or 2 buckets;
- electrical conductivity meter,
- bottle (clear glass or plastic),
- fluoride test kit (only in certain regions)

This equipment is described in more detail in Appendix B.

Assembly of the pump and rising main is a simple job. Make sure that the foot valve is approximately 1 m above the bottom of the borehole to reduce the likelihood of sucking in sand or air. The foot plate should always rest on top of the casing, which must be as close as possible to ground level (if necessary a casing of 0.5 m length can be used for this purpose). The pump should be operated by one man (Figure 49), but changing operators every 10 to 15 minutes may be necessary. Note that quick, long strokes secure the best results, i.e. a maximum discharge.



Fig. 49 Survey test pumping. In order for the casing not to be damaged by the foot plate of the pump, a steel head is screwed on top of the casing.

A rapid decrease in discharge generally means that the water level has dropped below the intake. Sometimes this can also be noticed from water spurting out at the top of the pump. In this situation either the intake has to be lowered or, if this is not possible, there must be a delay until the water has risen again.

The pump test should be carried out over a period of one hour according to the procedure below.

- 1 Measure the water level in the borehole. Take ground level as the point of reference.
- 2 Check the foot valve in a bucket of water.

3. Assemble pump and rising main of desired length and lower it into the borehole.
4. Pump up 5 buckets worth in order to "develop" the borehole and wait until the water has reached its static level again
5. Start pumping as intensively as possible and maintain this for the entire test period, unless the water level drops below the intake and a delay is necessary. This delay time must be included in the test period!
6. Every 10 minutes record
 - the number of buckets drawn;
 - the water level;
 - the E. C. of the pumped water
7. After one hour, stop pumping, but leave the pump in the borehole
8. Immediately after pumping, measure the water level recovery for a period of 5 minutes at 1 minute intervals
9. At the end of the test, take a water sample in a clear bottle for some simple physical quality checks.

The results of the pump test should be entered on the back of the Borehole Description Form (see Annex 3). The yield of the borehole in litres per hour is calculated as the total number of buckets multiplied by the content of one bucket which is normally about 15 to 20 litres.

Follow-up

On the basis of the test results a decision must be taken as to whether the aquifer can supply water of sufficient quantity and quality. The criteria to be applied for the evaluation of a borehole are described in Chapter 5.

If the pump test fails because the yield is too low or the quality is sub-standard, other test holes should be drilled according to the patterns indicated in Section 3.4. If the other boreholes also fail to give the desired results, the site must be abandoned and drilling must be resumed at a new site. If, on the other hand, the borehole can be approved, some additional drilling still has to be carried out in order to

- investigate the extent of the aquifer,
- find the best location for the well

After the test drilling at a site has been completed, a situation sketchmap of the site is prepared, indicating the exact locations of the boreholes. An example is shown in Annex 2. The best borehole, that is the one with the



Fig. 50 A benchmark indicates the location of an approved borehole.

highest yield, in the deepest part of the aquifer or closest to the village, is chosen and is marked with a *benchmark* (Figure 50). The surveyor shows this place to the village authorities, stressing that the benchmark should not be removed because it may be some time before a construction team arrives in the village.

4.5 Description of soil samples

The soil samples must be described very carefully because the design of the well - particularly the depth and location of the screen - is based on this description. It must therefore be accurate, consistent and uniform.

- the description of a soil sample by a surveyor today should not differ from his description of the same sample tomorrow,
- there should be no big differences when two surveyors describe the same sample independently.

In order to get uniformity of soil description, it is advisable to check regularly with colleagues.

Sampling

The drilling up soil is removed from the augers or bailer and is neatly collected in rows of 1 m length, each row corresponding to one metre of the borehole (Figure 51). The first row should be laid at least 1.5 m from the borehole, in order that the samples should not be disturbed by the drilling operations. The sample rows are laid from left to right, when facing the borehole. Description of the samples has to be done after every 1 to 2 m drilling, otherwise they may dry out or change colour and consistency.

A water sample should then be taken as well for determination of the electrical conductivity (E. C.).



Fig. 51 Sample row after 7.5 m of test drilling. Counting is easier if a space is left open after every 5 m.

Recognition of soils

The most important characteristic used to classify soils is the size of the particles. For projects where a very accurate soil description is required, such as road or dam construction, the samples are sieved in a laboratory by means of a series of standard sieves. From the results a grain size

distribution diagram is drawn for every sample. To carry out such an analysis for all the samples from the test boreholes would be much too expensive and time consuming and moreover, it would produce a lot of irrelevant information. For the siting of wells, field methods are adequate. The only instruments required are the hands and eyes of the surveyor, providing a cheap and quick method of sufficient accuracy.

Each type of soil has its own particular feel when it is rubbed between the fingers

- o clay – is plastic and sticky when moist and can be rolled into threads, it makes clear finger prints and often stains the skin,
- o silt – has a smooth soapy feel, a moist sample can be moulded to some degree, but will break easily,
- o sand – the rigid particles can easily be felt and seen, when dry it is loose and when wet, not sticky at all.

The description of a sample becomes more difficult when it is a mixture of different soil types. Generally the characteristics of one of the components are dominant, which is then called the *major part*. Any additional material is called a *minor part*. Particularly with mixtures of clay and silt it may be difficult to determine which is the major part. Where in doubt, the following method can be applied

Roll a moist sample between your hands to form a "worm", the thickness of a pencil. If you can make a ring from the "worm", the major part will be clay (Figure 52). The more readily the sample breaks during moulding, the higher is the silt content



Fig. 52 This soil sample has a high clay content

Soil description

The details of the samples from the borehole should be entered on the front of the *Survey Borehole Description Form* (see Annex 3). All the items to be entered are briefly discussed below. The abbreviations to be used can be found in the Index on the form

Depth

The location of the layers, expressed in metres below ground level (m -GL), is derived from the rows of samples. Because the samples inevitably become a little mixed, it is

useless to measure to the nearest centimetre. Give round figures like 1.45 - 2.20, and not 1.44 - 2.18.

Lithology and gradation

These have to be filled in for both major and minor parts. The technique for recognizing the different soils has been explained above. Gradation is only given for sand fine, medium or coarse because clay and silt particles are too small for further subdivision

Note: Sand is usually brought up by means of the bailer. As a result of the up and down movement, the coarsest and heaviest particles tend to sink to the bottom of the bailer but when the bailer is emptied, the fine particles come out first and the coarsest appear on top. Therefore a sand sample should be mixed before it is described

Consistency

This indicates the solidity of the soil. The most common descriptions are

- soft – easy to mould, e.g. silt or mixtures with silt can be soft, especially when wet,
- sticky – hard to remove from the auger, e.g. moist clay,
- loose – runs easily through the fingers, e.g. sand,
- hard – difficult to break the fresh sample, e.g. dry clay,
- weathered – special condition of bedrock (see Section 3.1)

Colour

Different shades in colour are indicated by "dark" and "light", and "mottled" means that different coloured spots can be seen on the sample

Water content

This is an important item for the appraisal of the borehole and for the construction of the well because the location of the screen is based on this information. Four descriptions are used

- dry – a sample may be wet on the outside but be completely dry on the inside and this is especially true of clay,
- moist – a moist sample is usually easy to mould,
- wet and/or water bearing – classification as wet or water bearing has not so much to do with the actual water content as with the soil type. saturated clay can be very wet (high porosity), but can never be water bearing (low permeability), silt on the other hand can be wet and water bearing, sand below the water table is virtually always water bearing

E. C.

As soon as water is reached, a sample is taken with the bailer and the electrical conductivity is measured. This is repeated for every metre drilled

Kind of auger

The kind of auger used will provide information on possible difficulties to be expected during construction of the well

Soil profile

A *soil profile* is a schematic drawing of the lithological borehole description, in which the soil types are represented by symbols. It must always be drawn in the special column on the right-hand side of the Borehole Description Form. An experienced surveyor will be able to "read" a soil profile much more easily than an extensive written description. It will immediately give him a good picture of the succession of layers. When several soil profiles are combined in *sections* of a site or area (see Section 4.5), they can help the surveyor or hydrogeologist to choose the best location for a well at a particular site, estimate the extent of an aquifer, select promising new sites and so on.

A soil profile will also facilitate the work of the designer of the well. It will give him direct information on the depth of aquifers, confining clay layers, etc. In the case of

uncertainty about the properties of a specific layer, the corresponding description can act as a supporting check.

The symbols used in a soil profile are listed in Table 4.1. For most soils, 2 or 3 symbols are given: the first one is to be used when the soil type is present as a major part, the second and third when it is a minor part, i.e. large and small amounts respectively.

Note: A single symbol is given for all bedrock (undifferentiated) since identification of the different types of rock requires specialist geological knowledge which is beyond the scope of this manual.

Bedrock can only occur as a minor part, when it is weathered.

The symbol for a mixed soil is given by superimposing the symbols for major and minor parts. For example, the symbol for "medium sand with clay" is composed as shown in Figure 53.

An example of a soil profile is given in Annex 3. Note that the water bearing formations and the static water level are also indicated in the profile.

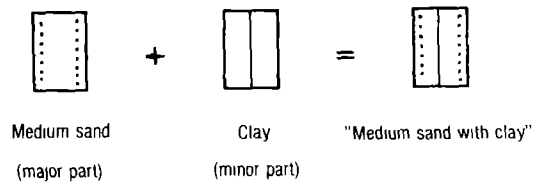

Fig 53. Composition of the symbol for "medium sand with clay"

Table 4.1 Symbols for soil profiles

Description	Soil symbol	
	Major part	Minor part
Clay		
Silt		
Sand, (very) fine		
Sand, medium		
Sand, (very) coarse		
Sand, undifferentiated		
Gravel, rounded		
Gravel, angular		
With thin clay layers		
Alternating sand and clay layers (≤ 10 cm)		
Calcrete or laterite		
Bedrock, undifferentiated		

4.6 Drawing a section

As already explained in Section 3.4, the best method of getting an insight into the hydrogeological conditions of a site or area, is to prepare *sections*. A section is a schematic drawing of the sub-surface structure on an imaginary vertical plan. For this purpose the boreholes should be located more or less in a straight line. The main difficulty in making a section lies in the logical combination of information from a limited number of boreholes, into a consistent picture of the geological formations. However, the use of soil profiles made from each borehole facilitates this work considerably.

A step-by-step procedure for drawing a section is described below and is illustrated by the example in Figure 54. The succession of layers in this example has been kept simple. In nature, however, much more complicated structures may occur and in this case it is important to try and focus on the overall pattern rather than on small details, especially to start with. In cases of doubt, e.g. whether or not an aquifer is interrupted between two boreholes, it is better to make the effort to drill another borehole for extra information, rather than simply to guess. In the example, information is available from five boreholes drilled along a straight line across a small river.

HAND DRILLED WELLS

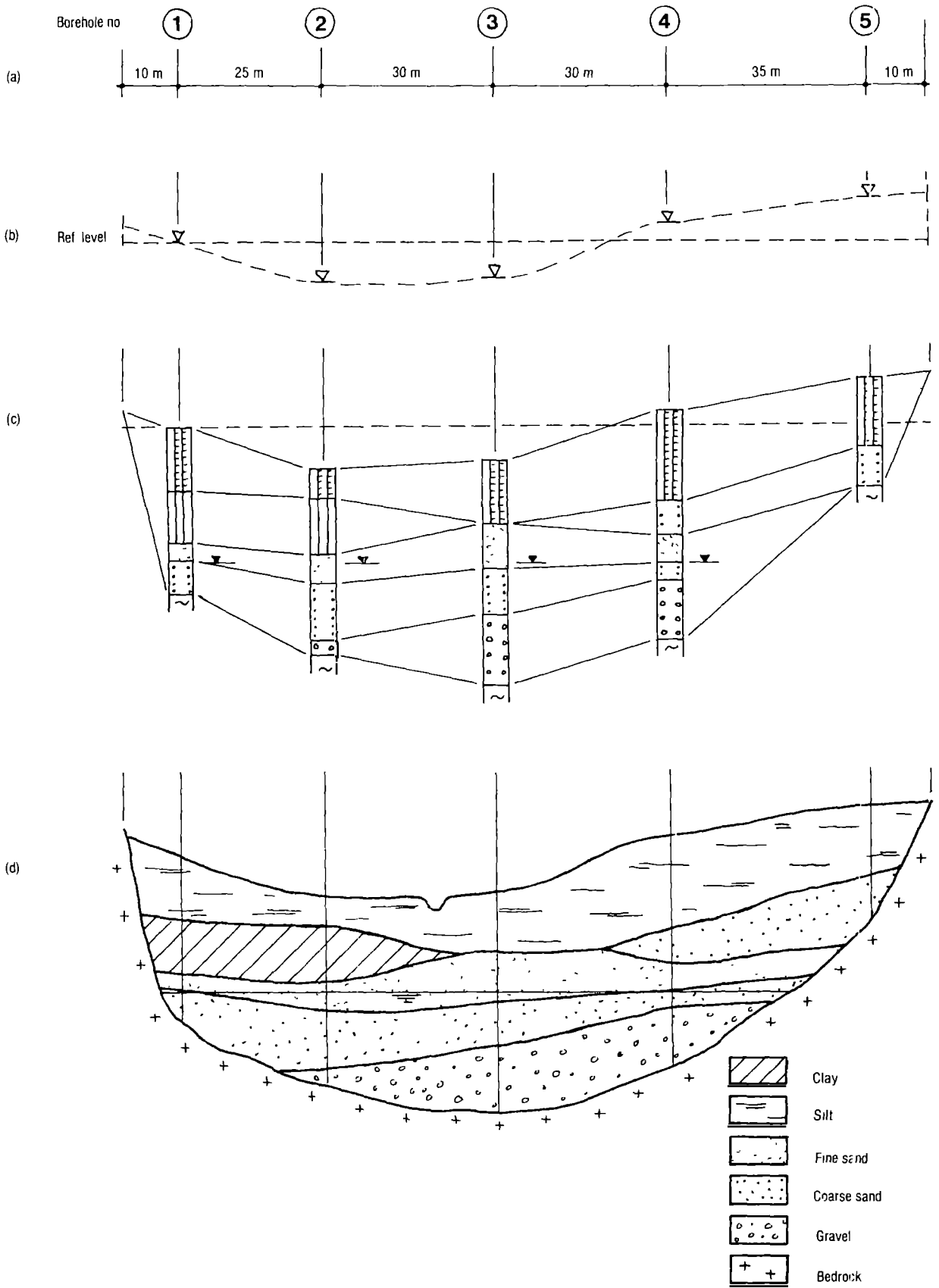

Fig. 54 How a section is prepared. For a description of steps (a) to (d) see text.

valley The total width of the valley is 140 m, and distances between the boreholes are 25, 30 and 35 m respectively. The outermost boreholes are each at 10 m distance from the outcropping bedrock at the edges of the valley

Procedure (see also Figure 54)

- 1 Draw a horizontal line which serves as a point of reference. Select a suitable horizontal scale¹⁾ and plot the position of the boreholes on this line. Also indicate the location of important features such as the river, boundaries of the valley, etc. In this example, 1 cm was chosen to represent 10 m in the field in order to make the drawing fit on the paper.
2. Choose an exaggerated vertical scale²⁾, e.g. 1 cm corresponding to 2 m in the terrain, and plot the elevation of the boreholes. Take the ground level of one of the boreholes as a point of reference. Differences in elevation in the field are easily determined with a levelling instrument.
3. Draw the soil profile of each borehole at the marked location, starting from ground level and using the same vertical scale (every 2 m of depth is represented by 1 cm).
4. Try to connect layers of the same composition in the different boreholes in a logical way by drawing lines from profile to profile.
5. Make a second diagram, leaving out the soil profiles, in order to get a clear picture of the different formations. Provide the diagram with a key for explanation of the different symbols used.

4.7 Recording and storage of survey data

All information gathered in the field by the surveyor must be recorded for purposes of further analysis. This is not only essential for the approval of a site and for the design and construction of single wells, but also for the planning of future siting activities. An important part of the survey work is to try to combine the field data with other available information to give an overall picture of the hydrogeological conditions in an entire area. More accurate predictions can then be made of the feasibility of hand drilled (or hand dug) wells in other parts of the area.

For purposes of uniformity the survey data are recorded on three types of pre-printed standardized forms

- * Village Sketchmap;
- * Situation Sketchmap;
- * Borehole Description Form,

Village sketchmap (Annex 1)

When the survey work in the village is finished, the surveyor draws a second village sketchmap which is a review of all the approved and rejected sites. Note that the

first sketchmap only served for the purpose of planning the work. This second map need not be to scale, but the main distances within the village should be indicated. A copy of the map should be handed over to the village authorities.

Situation sketchmap (Annex 2)

For every site, whether approved or not, a situation sketchmap should be made, on which the locations of the different boreholes should be clearly plotted, and distances between the boreholes and some distances to points of reference marked on. On this sketchmap the main buildings, houses (with name of the owner if close to the site), roads, tracks and so on should be indicated. The main purpose is to judge the extent of the aquifer and to provide sufficient information for a construction team to find the approved boreholes.

Borehole Description Form (Annex 3)

This form should be filled in for every separate borehole. For the greater part it is completed in the field, only a few additions need be made in the office afterwards. Apart from the lithological description and the pump test data, the following data should also be recorded:

- The date of surveying which is important for the comparison of the groundwater level with later recordings, e.g. during construction and maintenance. In this way seasonal fluctuations can be determined.
- The name of the surveyor and those of the villagers who assisted in drilling the borehole.
- The location of the borehole, i.e. village, ward, division, district, coordinates. How to derive the coordinates from the topographical map is shown in Appendix E.
- The type of equipment used. Either LSD or HSD (light- or heavy-weight set) is circled.
- A summary of the hydrogeological data. Depth of the aquifer(s), water level, yield, maximum drawdown, etc. should be given.
- Recommendations for the construction such as total well depth and location of the screen.
- The number of the borehole.

One system for numbering boreholes is based on the numbers of the topographical map sheets. A site located in an area covered by a certain map sheet, receives the number of that sheet followed by a serial number for the site. For example

A site number would be 186/3-20
where 186/3 is the map sheet number, and
20 is the serial number of the site

1) For an explanation of scales, see Appendix E

2) The vertical scale should be exaggerated as compared to the horizontal scale, otherwise the topography and the successive formations cannot be distinguished clearly.

A test borehole drilled at that site is given the number of the site, followed by a serial number for the borehole and thus

Where a borehole number is 186/3-20-4,
 186/3-20 is the site number, and
 4 is the serial number of the borehole

Boreholes at any one site are numbered from 1 onwards. In order to avoid duplication of site numbers when several surveyors work in the same area, each surveyor should be allocated a series of site numbers, e.g. from 186/3-21 to 186/3-40

When the borehole is approved and the well is constructed, the well will be given the same number as the site. Only if more than one well is constructed on the same site, which rarely occurs, must the borehole serial number also be mentioned in the well number

Village plot on topographical map

If a topographical map sheet of the area is available, the layout of the village with the approved sites should be drawn on this map. A simple plotting method is described in Appendix E and an example is given in Figure 55. The map was prepared before the village was established, and

has not been updated since, the sisal estate, for instance, no longer exists. In this case the easiest reference points were the stream just south of the village (Chamazı River, see arrow) and the distance from the Kilwa road (measured with the trip-counter of a car)

Storage of survey data

The survey data should be stored in such a way that they can easily be retrieved when necessary. Two possible systems for filing are suggested

- * Filing by map sheet number. All the papers are filed under the respective topographical map numbers in order of site number. This is quite an easy system and only leads to minor problems if information is wanted about a village which is divided between two adjacent map sheets
- * Filing by village or ward name in alphabetical order. Particularly filing by ward name can have advantages, since correspondence about maintenance of wells or requests for wells mostly takes place at ward level.

For every approved site, copies of the Situation Sketch-map and the Borehole Description Form are handed over to the construction department for the design of the well.

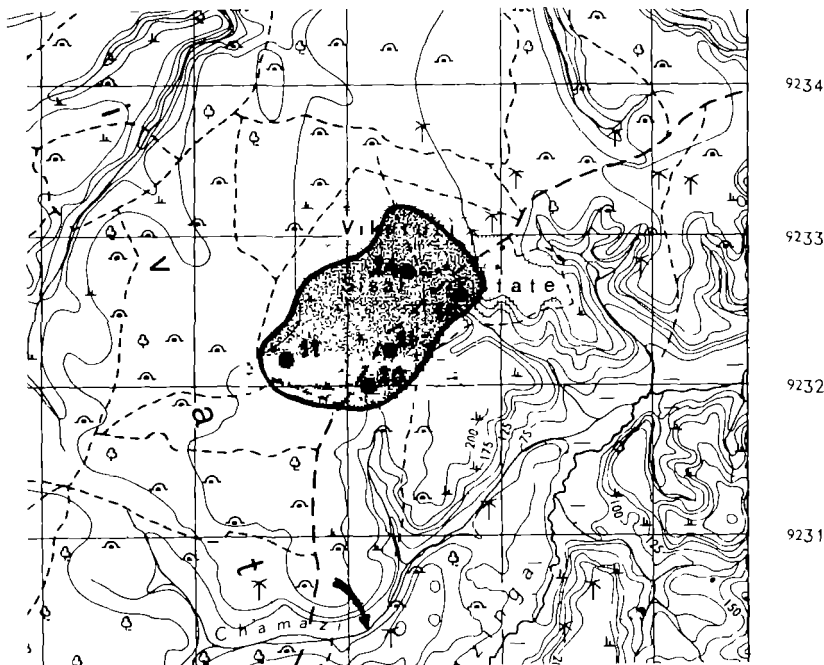

Fig. 55 The layout of Chamazı village with approved sites plotted on a topographical map

Criteria for Borehole Approval

The surveyor in the field has to decide whether a borehole can be approved for the construction of a tube well and when he should start working at another site. Together with the conditions already discussed for the location of the future well (see Section 4.2), a number of additional criteria serve as the basis for his assessment of the borehole. These criteria include:

- the yield of the pump test;
- the quality of the water;
- the hydrogeology of the borehole or the site.

Usually official approval has to be given by the hydrogeologist in charge, although the same criteria will be applied.

In fact, the same criteria - except the one concerning the test yield - apply to the assessment of a borehole for the construction of a larger diameter ring well.

5.1 Test yield criterion

The question immediately arising when judging a borehole on its merits is how high the yield of the pump test should be in order to guarantee a sufficient yield for the well. The required yield of a well will generally not exceed 1,000 litres per hour, that is roughly one bucket per minute, because this is approximately the minimum capacity of a hand pump. The minimum required survey test yield can be calculated, using equation (2.2). If the permeability and thickness of the aquifer are constant, the test yield can be written thus

$$Q_t = \frac{K}{\log(R_t/r_t)} \quad (5.1)$$

and the well yield can be written as

$$Q_w = \frac{K}{\log(R_w/r_w)} \quad (5.2)$$

where K is a constant and t and w are the indices for "test" and "well" respectively

Assuming that in both cases the radius of influence (R) is the same, (5.1) and (5.2) can be combined and thus the test yield can be calculated from

$$Q_t = Q_w \frac{\log(R/r_w)}{\log(R/r_t)} \quad (5.3)$$

Substituting the following values $R = 20$ m, $r_w = 0.11$ m (including gravel pack), $r_t = 0.045$ m and $Q_w = 1,000$ l/hr, the following criterion is obtained

With a test yield of 850 l/hr or more, construction of a tube well with ϕ 103/110 mm filter pipe is possible in principle ¹⁾

In fact, this criterion is very reliable because

- the survey borehole has not been "developed", unlike the future well (for an explanation of development see Section 9.1);
- the slots in a survey casing are more easily blocked than those in a filter pipe, since there is no surrounding gravel pack

If the test yield was limited by the capacity of the pump, the construction pump test (see Section 9.4) may show much higher yields - over 10,000 l/hr has been recorded. Only if the test yield was equal to the maximum yield of the aquifer, which can be concluded from a steadily increasing drawdown during the pump test, will the well not yield more water after construction.

¹⁾ For a ring well with its storage capacity of at least 3 m³, a well yield smaller than 1,000 l/hr is required because the well slowly fills up during the time the pump is not in use. A flow towards the well of approximately only 600 l/hr under pumping conditions is required and hence - using equation (5.3) with $Q_w = 600$ l/hr and $r_w = 0.5$ m - a test yield of 350 to 400 l/hr is sufficient to approve a borehole for construction of a ring well.

However, if the survey is carried out in the rainy season, the yield criterion may have to be adjusted

An example illustrates this

If an aquifer has a water bearing thickness of 4 m in the rainy season and if the expected groundwater level fluctuation is 1.5 m, then the effective thickness in the dry season would be only 2.5 m. Thus the required test yield has to be $4.0/2.5 \times 850 = 1,360$ l/hr.

5.2 Water quality criteria

All village water supplies have to meet the *Temporary Standards of Quality of Domestic Water in Tanzania*, as described in Appendix C of this manual

Groundwater - if protected by overlying clay or thick sand layers - is generally free of pathogenic organisms and therefore bacteriologically safe. Furthermore, toxic substances like heavy metals or phenols are unlikely to occur in groundwater in the rural areas. Since all the materials used for the construction of the well are corrosion-resistant (plastic, brass, stainless steel), factors such as hardness, pH and the carbon dioxide content of the water are not decisive for the approval or rejection of a borehole. For these reasons a preliminary evaluation of the water quality can be conducted based on some simple measurements in the field, to which the criteria below are applied. However, only after a complete chemical and bacteriological analysis of the water has proven its suitability for drinking purposes, can a borehole be given definitive approval.

The E C should have a value lower than 2,000 $\mu\text{S}/\text{cm}$

The easiest way of determining the salinity or *Total Dissolved Solids (TDS)* is by measuring the *Electrical Conductivity (E C)* which (in $\mu\text{S}/\text{cm}$) corresponds to roughly 1.5 times the TDS (in mg/l)

A very high concentration of salts (E C over 2,000 $\mu\text{S}/\text{cm}$) makes drinking water unacceptable to human beings. However, a lower standard, i.e. a higher E C, can sometimes be accepted if the well is only used for cattle watering. An exact criterion cannot be given, but wells with an E C up to 3,000 $\mu\text{S}/\text{cm}$ have been constructed for this purpose.

Sometimes the E C of the water in the borehole exceeds 2,000 $\mu\text{S}/\text{cm}$ at the start of the pump test but decreases rapidly during the test. This could happen if the borehole was drilled through clay layers with the result that the water in the borehole may have been temporarily mineralized by salts accumulated in the clay. Soon after pumping has started, the E.C. will drop to the value of the water from the pumped aquifer

It may happen that during the test the E C increases but still remains below the acceptable value of 2,000 $\mu\text{S}/\text{cm}$ at the end of the test. The reason could be that more highly mineralized, i.e. more saline, water from deeper strata starts flowing towards the borehole. Pumping should still be continued in this case, until a better notion is formed of the water quality to be expected after prolonged pumping.

As already demonstrated for the yield, the criterion should be used with caution if the survey is carried out in the rainy season

For instance, a borehole with an E C of 1,800 $\mu\text{S}/\text{cm}$ in the rainy season could be approved. However, this value might easily rise above the acceptable limit in the dry season (see also Section 2.5), not only because of a concentration of salts due to evapotranspiration, but also because water of poorer quality from deeper layers might be pumped up if the water level dropped. Whether or not such a borehole should be approved, depends on the local hydrogeological conditions. For instance, if the groundwater level fluctuations are known to be considerable and the aquifer is of limited thickness, it would be advisable either to repeat the survey in the dry season or to reject the borehole.

If a borehole has to be rejected because of a seasonal problem of high salinity and no alternative sources can be found, the villagers might still accept such a well, but this must be thoroughly discussed with them

The fluoride content should be lower than 8 mg/l

If the content is higher than 8 mg/l, the borehole must be abandoned since the water can cause *fluorosis*, a disease which causes damage to teeth and bones. If no other sources of safe drinking water are available in the area, treatment of the water might be considered. A simple and cheap method of defluoridation has been developed by the National Environmental Engineering Research Institute in India¹⁾, from whom information can be obtained.

A water sample taken after the pump test should be clear and colourless

In addition to this, it should not contain any visible living organism nor remnants of plants and the like. In areas where laterites occur (see Section 3.1), the groundwater may have a milky white colour which is not harmful. It is not necessary to reject a borehole with such water, although the villagers may initially find it unacceptable.

¹⁾ NEERI, Nagpur - 20, India

Note: Because there is no proper gravel pack in a survey borehole to filter the water, there may be some silt or sand in the sample. Therefore it should be left standing for a few minutes

The water sample should neither smell nor taste salty, sour, soapy or bitter.

In fact, the water should be almost tasteless. If it tastes salty, this should correspond to a high EC value as explained above. On the other hand, a high EC does not necessarily result in a salty taste. This depends on which types of salts are present. Salts like chlorides and sulphates can make the water undrinkable, but other types of salts, e.g. calcium or magnesium carbonates, the presence of which causes hardness of the water, hardly influence the taste at all.

5.3 Hydrogeological criteria

Whether a well will give water throughout the year, depends on the hydrogeological conditions at and around the site. These include: the characteristics and extent of the aquifer, and the recharge potential. Exact criteria cannot be given, but there are a number of indicators for the suitability of the site

Water level observations

From the water levels as measured during the pump test, extra information about the characteristics of the aquifer can be derived.

The static water level, in combination with depth and thickness of the aquifer, indicates to what extent the aquifer is water bearing and if seasonal fluctuations will influence the yield

A small drawdown - less than 1 m - throughout the test, shows that the aquifer has a high permeability. This should correspond to the soil type and a high test yield. It also shows that the maximum yield of the aquifer will be higher than the test yield

A fast recovery of the water table after the test also shows high permeability and usually goes hand in hand with a small drawdown, whereas a slow recovery indicates the contrary

Note: For definitions of the underlined terms, see Section 2.4

Extent of the aquifer

If no recharge occurs in the dry season, the quantity of water stored in an aquifer should be sufficient to cover this period, i.e. 8 months or 250 days. Insight into the extent of the aquifer can only be obtained by drilling a number of test boreholes at the site. The boreholes should preferably

be drilled in straight lines, so that geological sections can be drawn as shown in Section 4.5. The example below gives an indication of the necessary extent of an aquifer

With a daily demand of 6,000 l or 6 m³, a total amount of 250 × 6 = 1,500 m³ of water is required

If the aquifer has a specific yield of 20%, its minimum volume should be 1,500 / 0.2 = 7,500 m³. Supposing the thickness of the aquifer is 2.5 m, then the area should be 7,500 / 2.5 = 3,000 m². Therefore, if this aquifer covers an area of 30 × 100 m or 50 × 60 m and recharge possibilities exist, the well will not run dry.

A practical example

In 1980-1981 four wells were constructed in Chamazi village near Dar es Salaam (well nos. 186/3-11, -15, -21 and -24). The performance of the wells was satisfactory, until the dry season of 1981 when one of the wells (no. 24) started drying up. By December 1981 the water level had reached the bottom of the well (Figure 56) and it had to be abandoned. The water levels in the other three wells showed a normal "dry season curve" - a slow decline.

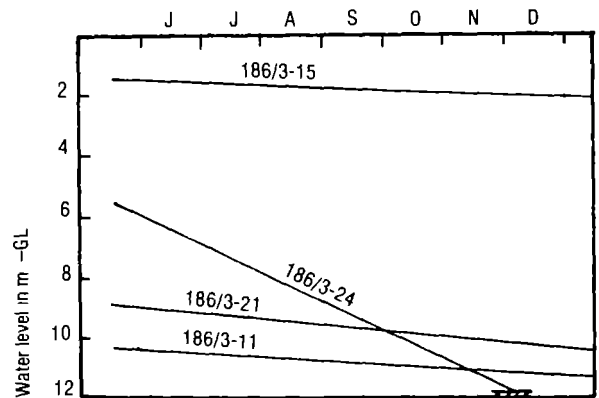

Fig. 56. Recorded water levels in four wells in Chamazi village during the dry season of 1981.

The survey of site no. 24 was carried out in March 1981 in the rainy season. The test yield was 1,800 l/hr, which was amply sufficient, even taking into account the fact that it was the rainy season. The maximum drawdown during the pump test was quite favourable, being 0.7 m, and the aquifer lying at a depth of 10 m below ground level was confined. Moreover, the thickness of the aquifer of coarse sand - approximately 1 m - could not have been a reason for rejecting the borehole.

However, a serious mistake was made: only one test borehole was drilled at the site. Apparently this was a "lucky strike" in the middle of a small aquifer with very limited recharge potential. Had the extent of the aquifer been examined more carefully, the site would certainly have been rejected.

5.4 Summary

In the outline below all the criteria for the approval of a site have been summarized. If a site meets these conditions, a tube well equipped with hand pump can be constructed.

- | | |
|-------------|--|
| Location | <ul style="list-style-type: none">○ Accepted by the villagers○ Within 400 m walking distance○ Safe from flooding○ Safe from contamination○ Spill water drainage possible |
| Quantity | <ul style="list-style-type: none">○ Test yield 850 l/hr or more |
| Quality | <ul style="list-style-type: none">○ E.C. lower than 2,000 $\mu\text{S}/\text{cm}$○ Fluoride less than 8 mg/l○ Bacteriologically safe○ Clear and colourless○ No smell and no taste |
| Reliability | <ul style="list-style-type: none">○ Sufficient extent of aquifer○ Recharge potential |

The Design of Tube Wells

When a site has been approved, a copy of the Survey Borehole Description Form is handed over to the construction team. The design of the well, which serves as a guideline for the drilling operations and the construction of the well, is based on this information. It indicates the depth of the well, the location of the screen, gravel pack, clay seal(s) and backfill. It also gives an estimate of the required quantities of materials such as PVC piping and gravel.

6.1 Components of a tube well

The following elements can be distinguished in a tube well (Figure 57)

- * The *filter pipe* which serves as a housing for the pump cylinder and the rising main. It consists of two parts
 - the *screen* where the water from the aquifer enters the well through *slots*;
 - the *plain* pipes which are the lining of the well from the screen up to ground level
- * The *gravel pack* which prevents coarse particles in the aquifer from clogging the screen and which allows the finer particles to pass through during development of the well.
- * *Clay seals* which are designed to prevent water from the surface or from other aquifers from entering the well
- * *Backfill* which is used to fill the remaining space in the borehole and supports the filter pipe. Any available soil can be used for this purpose

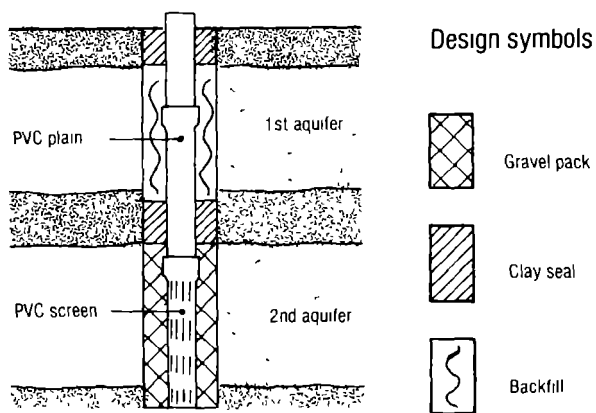

Fig 57. The components of a tube well.

Since the number of wells to be constructed under a Regional or District water supply programme can be considerable, up to over 1000 wells, emphasis has been put on standardization of the well design and materials. As a result of further standardization of the drilling equipment, the following standards are now in use for all tube wells

- * The filter pipe is composed of standard 3 m PVC pipes with a diameter of 103/110, 117/125 or 147/160 mm, both for the screen and the plain pipe
- * The screens are provided with slots of 0,7 mm standard width.
- * The gravel is sieved between two standard mesh sizes of 10 and 45 mm, and is used in a gravel pack of standard thickness.

The combination of slots and gravel of the above sizes allows the intake of the well to be constructed in aquifers of almost any material, from very fine sand to gravel (see also Chapter 8)

The variables in the design of the well are now reduced to

- the depth of the well,
- the location and length of the screen,
- the height of the gravel pack,
- the location of the clay seals

6.2 Design principles

The examples in this section serve to illustrate the design principles. Consequently the soil profiles have been kept simple and only show aquifers and impermeable layers with clear boundaries. In reality the situation is always more complex. For instance, it may be difficult to determine from the Survey Borehole Description Form exactly which formations are water bearing. However, the most

HAND DRILLED WELLS

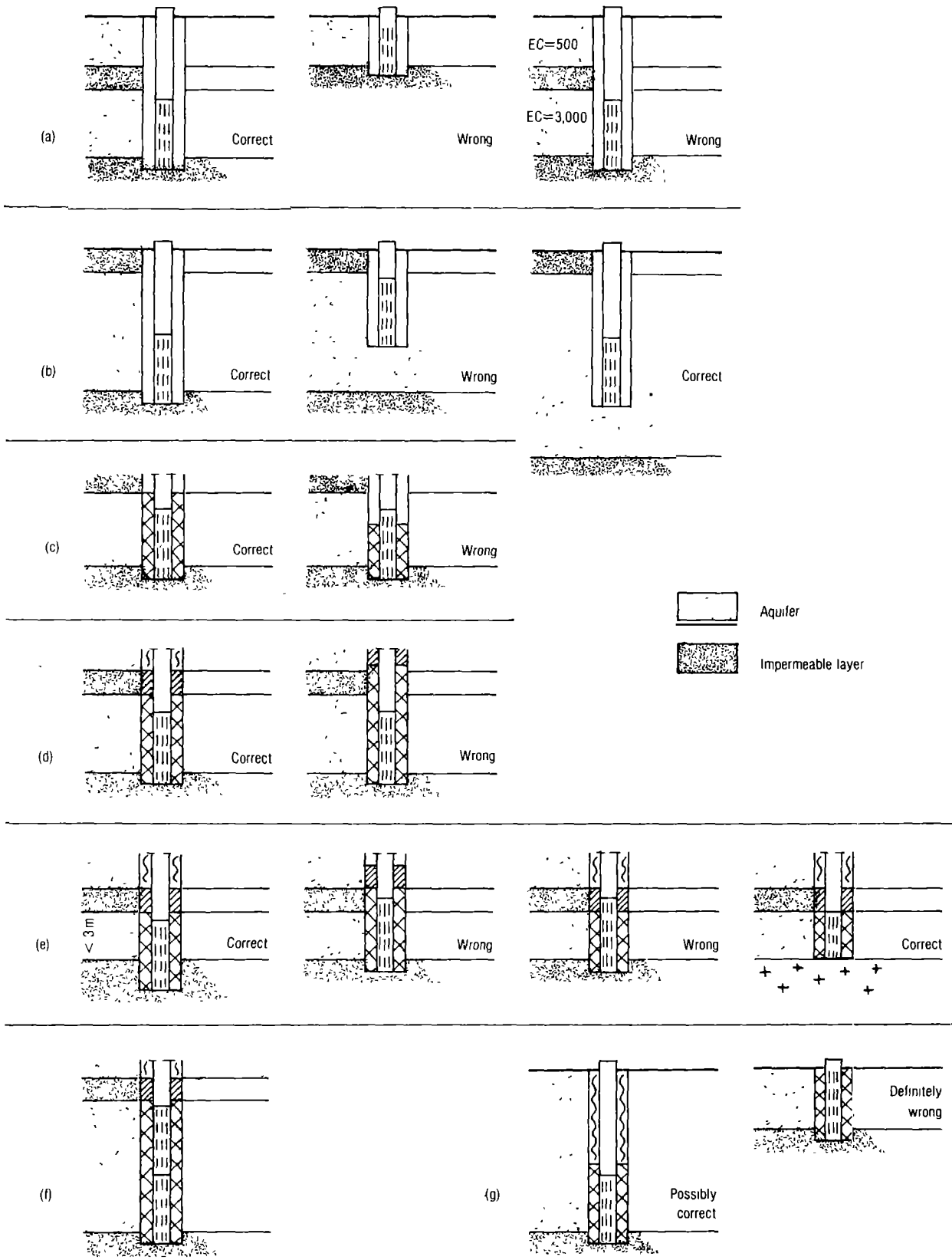

Fig 58. (a) to (g) Summary of the most important design principles for hand drilled tube wells For an explanation see text.

complex situations can generally be reduced to simpler ones, to which the principles below can be applied

- 1 A standard screen of 3 m length, installed in an aquifer with a survey test yield ≥ 850 l/hr, will guarantee a sufficient yield for a tube well with hand pump.
- 2 Whenever possible, the bottom of the well is to be set 20 cm into an underlying more solid layer. This facilitates construction of the borehole.
- 3 For reasons discussed in Section 2.5 and see also Figure 58a, the screen is preferably installed in a confined aquifer, unless
 - the water quality does not meet the standards,
 - the aquifer is too deep,
 - the yield is too low.
- 4 If more than one confined aquifer is present, the screen is installed in the lowest aquifer. But see the restrictions in 3. above.
- 5 The screen is installed as deep as possible in the aquifer in order to reduce the risk of the well drying up (Figure 58b). Where the aquifer is very thick (≥ 10 m), the screen may be placed half-way, if the groundwater level and its fluctuations allow this; this is known as an *incomplete well*.
- 6 The gravel pack must always cover the full length of the screen in order to prevent particles from the aquifer or other layers from entering the well (Figure 58c).
- 7 Clay seals must always be installed at the level of impermeable layers. (Figure 58d). Otherwise they serve no purpose.
- 8 If the aquifer has a thickness < 3 m, the screen is not cut, but the borehole is drilled deeper accordingly. Only if the sub-soil is too hard, may the pipe be cut (Figure 58e).
- 9 Sometimes an aquifer with low test yield (< 850 l/hr) is approved by the surveyor because there are no other possibilities in the village. In this case the yield of the well can be improved by extending the screen (Figure 58f). This is of course only possible if the aquifer is sufficiently thick, but if not, construction of a ring well might be considered.
- 10 If there is no other possibility but to install the screen in an unconfined aquifer, the well should only be constructed if this aquifer is reasonably thick (Figure 58g). Then at least some bacteriological filtration of polluted surface water can take place.

6.3 Example of a design

In Annex 3. Survey Borehole Description Form, the results are shown of the test drilling and pump test of borehole no 186/3-20-1 near the dispensary in Chamazi village. This borehole was approved for the construction of a tube well.

Water bearing formations were found at the following depths:

- 2.4 - 2.8 m - GL,
- 8.5 - 8.8 m - GL,
- 9.0 - 10.0 m - GL.

The upper aquifer is unconfined and, in addition, rather thin. The lower aquifers, however, on which the pump test was performed, are confined. A covering clay layer lies at a depth of 5.4 - 7.3 m - GL. Also the water quality in these aquifers is better: $E.C = 340 \mu S/cm$, compared to $640 \mu S/cm$ in the uppermost aquifer.

The design for this well is given in Figure 59, next to the soil profile of the borehole. The installation of the screen and the gravel pack from 7.5 - 10.5 m - GL (20 cm into the underlying clay) allowed for the installation of a proper clay seal at the same level as the confining clay layer. Near the surface a clay seal was also used.

For this well, one screen and three plain pipes of 3 m length each, were required. The top plain pipe had to be cut to the correct length. For the gravel pack a quantity of $3 \times 35 = 105$ litres of gravel was needed (see Table 8.1).

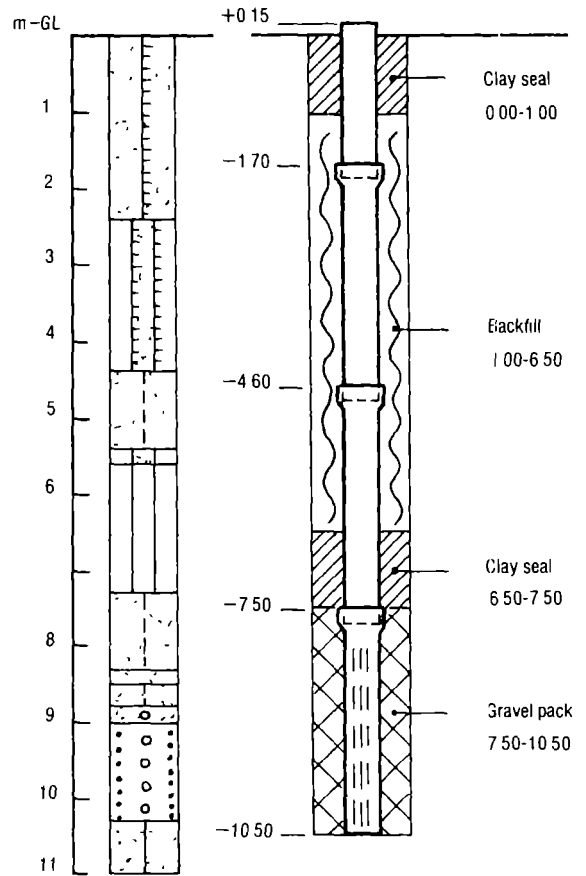

Estimated quantities of materials

- Filter pipe
 - screen 1 × 3.00 m
 - plain 2 × 3.00 m + 1.95 m
- Gravel
 - 3 × 35 = 105 litres

Fig 59. The design of well no 186/3-20 in Chamazi.

Well Drilling Operations

One of the essential differences between survey and construction drilling is that a surveyor never knows in advance the kind of soil he will find. However, the survey description provides the construction team with information on the location of the aquifer(s), any particularly hard layers, the depth to be drilled and so on. This means that the drilling method and the size and quantity of equipment can be anticipated and a strategy for drilling the borehole can be prepared in advance. As a result, construction drilling can be considered to be an easier operation than test drilling, although it is physically more difficult.

7.1 Preparations

Manpower and equipment

Experience from tube well construction projects in the country has shown that a drilling crew should consist of at least 3 skilled workers and 4 to 6 workers from the village. The foreman of the team is responsible for the actual construction of the well and the quality of the finished product. He is also responsible for the organization of the work, the maintenance of the drilling equipment and the field administration. A detailed description of the drilling equipment is given in Appendix D.

Layout of the site

The site should be arranged in such a way that all construction work for the well - from drilling to pump installation - can be executed without any hindrance. Therefore an area of at least 10 × 10 m around the borehole has to be cleared and levelled.

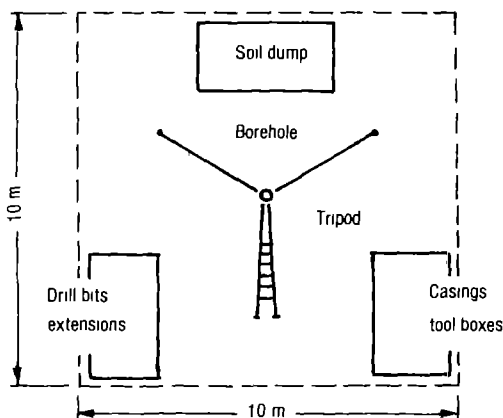

Fig 60 The layout of the construction site

A practical layout of the site is shown in Figure 60. Such a layout will guarantee sufficient working space and a good arrangement of the equipment. The soil dump is always located opposite the double leg of the tripod so that stability is assured and the winch operator can have a clear view.

Location of the borehole

The design of a well is always based on the survey data. Since the soil stratification may vary considerably, even within a few metres, the borehole for the well should be located as close as possible to the survey borehole. However, it should not be at exactly the same spot. If the survey borehole was not drilled vertically, then the construction borehole will probably not be vertical either, for the drill bits will follow the path of least resistance, i.e. the survey borehole.

Therefore, construct the well at a distance of 1 to 2 m from the survey borehole. This spot is marked with a peg and serves as a starting point for measuring and setting up the tripod.

Erecting the tripod

In order to handle the various pieces of equipment during drilling operations, a tripod has to be erected over the borehole. An optimum of strength, stability and working space is obtained when the legs of the tripod are positioned at the three points of a triangle with equal sides of 5.5 m. The height of the tripod is then 5 m and the working space in both horizontal and vertical directions is sufficient.

The forces acting on the legs are considerable, particularly when the casing is being pulled up from the borehole. They therefore have to be placed on large steel foot plates to prevent them from sinking into the ground. The legs are fitted into a circular collar welded onto the upper surface of the foot plates which, for maximum stability, are placed in a slanting position (Figure 61)



Fig. 61 The foot plates of the tripod should be in a slanting position

An easy step-by-step method for the positioning of the foot plates is given below. The numbers of the steps correspond to the circled numbers in Figure 62

- 1 Measure 3.20 m from the place marking the borehole (A) in the direction where the double leg should come. Mark with a peg.
- 2 Measure 1.60 m from A in the opposite direction. This gives point B.
- 3 Measure 2.75 m from B in two directions perpendicular to the line A-B. Mark with pegs. The single legs are placed at these points.
- 4 Check the distance between the pegs for the single legs and the one for the double leg. This distance should be 5.50 m. If it is less or more, change the position of the pegs and check again.
- 5 Place the foot plates at the three points marked with pegs.

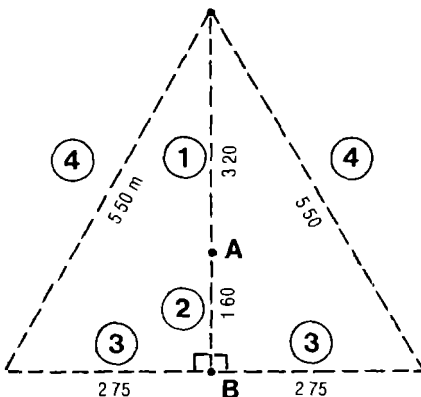

Fig. 62 Measurements for the set-up of the tripod

Note: A simple method of constructing a right angle (90°) is the 3-4-5 rule (Figure 63). If the sides of a triangle are in the proportion of 3 to 4 to 5 (e.g. 1.5, 2.0 and 2.5 m) the angle between the shortest sides will be 90° .

For reasons of stability, all legs should be at the same level. So if the site is located on a slope, it will be necessary to make excavation(s) for one or two foot plates.

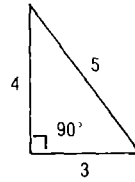

Fig. 63. The 3-4-5 rule.

The tripod is assembled at the site. The legs are laid down as shown in Figure 64. Take care that the winch does not touch the ground because sand might get into the gears. After tightening the top nuts, the tripod should be erected slowly (2 men at each single leg and 3 to 4 at the double leg) and placed on the foot plates. Then the pulleys and cable are attached (see Figure 159 in Appendix D).

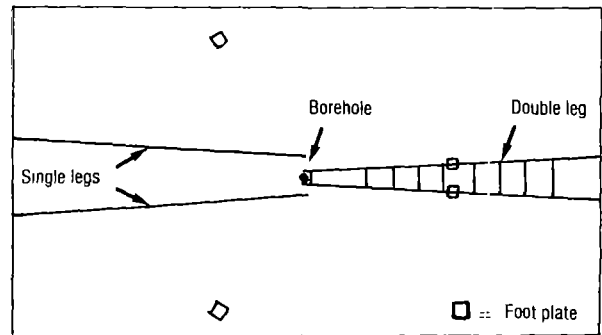

Fig. 64 The position of the tripod legs on the ground, ready for assembly and set-up

7.2 Drilling without a casing

Generally drilling is started with a combination of the ϕ 230 mm auger bit ¹⁾ and the corresponding flight auger (Figure 65). The auger with the crosspiece and extension hanger on top is hung from the pulley hook. The exact location of the borehole will be where the point of the auger touches the ground when it is lowered. The handles should be mounted on the crosspiece, being at a height of 1.7 m above ground level, and drilling can commence.

In this first stage of drilling, it is most important to get a borehole which is as vertical as possible.

¹⁾ If the borehole is constructed by means of the telescopic drilling method, drilling is started with the ϕ 300 mm auger. For further details see Section 7.6.



Fig 65. Drilling of the well is started with an auger bit and the corresponding flight auger. The end of the auger bit blade lines up with the beginning of the flight

A slanting borehole will cause many problems, either when the filter pipe and gravel pack are installed, or when the pump is installed. If the filter pipe is placed vertically in a slanting borehole (Figure 66a), the gravel pack will not be able to surround the pipe completely and the pipe will be in direct contact with the aquifer. If the filter pipe is placed aslant as well (Figure 66b), the whole pump (including the rising main) will have to be installed in a slanting position, causing premature wear of the pump.

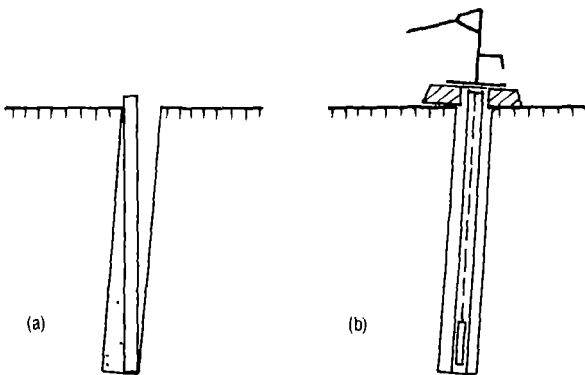

Fig 66. If the borehole is not vertical, either the gravel pack cannot be installed properly (a), or the entire pump must be placed in a slanting position (b)

When the first 2 to 3 metres of the borehole have been drilled vertically, the rest of the borehole will most probably be vertical as well. However, if the first part is not vertical, it will be very difficult or even impossible to correct this afterwards. Some practical methods of obtaining a vertical borehole are listed below

- Put the 3.0 m extension rod on top of the crosspiece and have one man keep it centred at the top of the tripod
- Hold a spirit level along the flight auger and correct the position if the drill of necessary
- Check the vertical position of the drill visually in two perpendicular directions
- Drill with an even number of people, equally divided over the crosspiece handles. Their number can be 4, 6 or 8, depending on the soil conditions

The auger is turned anti-clockwise²⁾ into the ground by 4 men, with all precautions being taken to ensure the drill is in a vertical position (Figure 67). After drilling about 0.5 m, the auger is pulled up with the winch. The auger should still be turned anti-clockwise to reduce the friction between the auger and the borehole wall. The drilling combination is pushed towards the soil dump, at the same time slackening off the cable. There the soil is removed

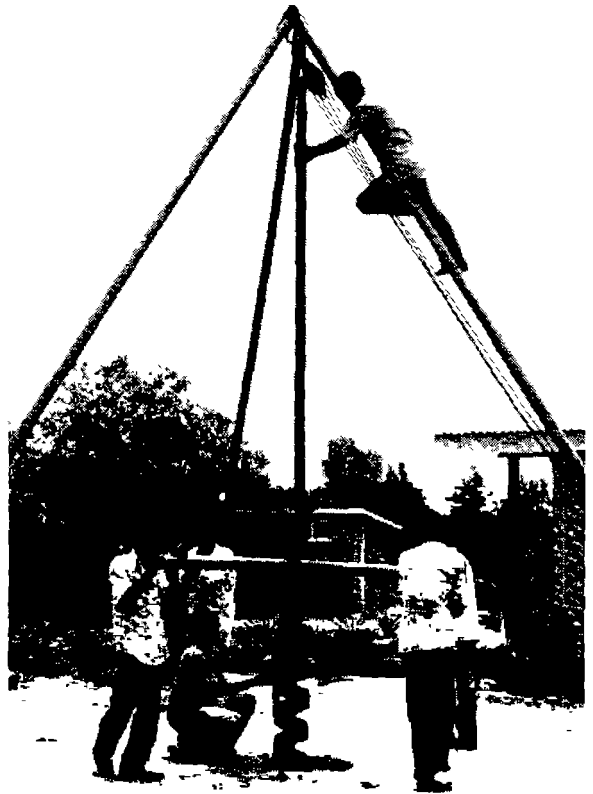

Fig. 67. The drill is kept in vertical position.

¹⁾ Recently the construction of the augers and therefore the direction of drilling has been changed from clockwise to anti-clockwise. Occasionally the clockwise drill loosened the lower section(s) of the casing, due to friction between the filled auger and the casing

with an auger cleaner or a big screwdriver and a soil sample is taken, the characteristics of which are entered on the *Well Description Form* (see Annex 4) The depth of the borehole should be sounded with a water level meter and noted on this form (see also Section 7.7) Then the auger is re-inserted into the borehole and drilling is continued

As the borehole becomes deeper, extension rods have to be added in such a way that the crosspiece handles remain at a suitable height for drilling - between 0.75 and 1.25 m above ground level. Therefore the length interval of successive extension rods should be 0.5 m and the following procedure is used

- 1 An extension rod of 0.5 m is fitted between the auger and the crosspiece.
- 2 When this combination has become too short, the 0.5 m rod is replaced by rods of 1.0, 1.5, and 2.0 m respectively. The 2.0 m rod is kept permanently connected to the auger.
- 3 With increasing depth, further extension rods, or combinations of rods, are added to the drilling unit in the following sequence: 0.5, 1.0, 1.5, 2.0 (1.5 + 0.5), 2.5 (1.5 + 1.0), and 3.0 m.
- 4 When more extension rods are required, the procedure of increasing in 0.5 m intervals is repeated.

The deeper the borehole, the higher the soil stress and the more difficult it becomes to get the auger down. So the number of people in the drilling crew may have to be increased.

However, never work with more than 8 people, otherwise the equipment will be overloaded. For the same reason never drill more than 0.5 m at a time (Figure 68)

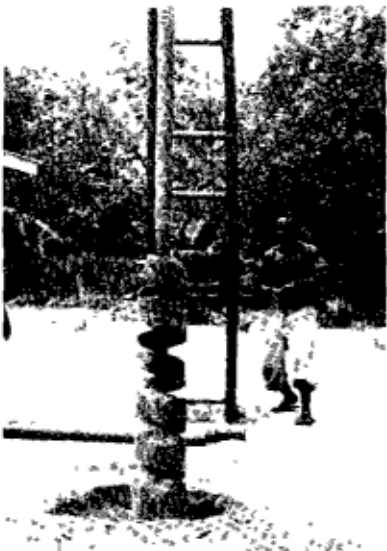

Fig. 68 The equipment will not be overloaded if the flight auger is not filled over more than 0.5 m

If the soil is particularly hard to penetrate with the normal auger, due to stones or a cemented layer, either the conical auger or the riverside bit can be used. Often the alternating use of these drill bits gives the best results.

7.3 Installation of casing and bailing

When the level of the water table is passed and the borehole starts caving in, a casing must be installed. As caving usually occurs in layers of sand - which cannot be drilled up with auger bits - the borehole must be made deeper by means of a bailer. The art of bailing is to get the casing pipe through the aquifer with a minimum of energy. It must be done carefully, paying attention to detail, since small mistakes in the operation may result in wasted effort. Unless the well is to finish half-way through the aquifer (see Section 7.5), bailing is stopped as soon as a more solid layer is reached. Then drilling can be continued with the small size auger or riverside bit.

Inserting the casing

The first casing section, with shoe, is lowered into the borehole until about 30 cm of pipe is left above the ground. Then the casing clamp is fitted and supported by pieces of timber. For additional sections the procedure below should be followed, until the casing has reached the bottom of the borehole.

- 1 The casing hanger, i.e. the female protector, is removed and the following section is suspended directly above the one in the borehole (Figure 69).
- 2 The male protector at the bottom is removed and the new section is carefully screwed onto the previous one, first by hand and then with a chain spanner.
- 3 The clamp is loosened and shifted to the top of the new section.
- 4 The assembly is lowered until the clamp rests on the timber supports again.

Preparations for bailing

After removing the lower pulley, the cable is detached from the upper pulley and connected to the bailer with a D-shackle. The total length of the casing, including the part above ground level, is calculated and this distance is measured on the cable, starting from the bottom of the bailer. This point is marked with a piece of tube or rope tied to the cable. After checking that the foot valve is functioning properly, the bailer is lowered into the casing until it just touches the bottom of the borehole. Then the winch is blocked so that the bailer does not sink into the soft loose sand.

During bailing, one man operates the winch, one or two men do the actual bailing and others lower the casing pipe.



Fig 69 A casing section ready to be screwed onto the previous one

Bailing techniques

The method of bailing will depend on the grain size of the sand. For fine to medium sand a different method is used from that for coarse sand. Whatever method is used, the bailer should never reach below the casing shoe. This would cause extra casing and waste effort. Therefore, the mark on the cable should always be kept above the top of the casing

- a) In fine to medium sand, the bailer is moved up and down quickly in the upper 10 cm of the sand. This will turn the sand into *quicksand*, i.e. the particles will start floating in the water.

One man stands at arm's length from the double leg of the tripod. He pulls the cable towards him with both hands and lets it go again (Figure 70). Thus an up and down movement of ± 10 cm is brought about, with very little effort. After about 10 to 20 strokes the bailer is pulled up a bit higher and is dropped by releasing the cable. Through the force of its own weight, it will penetrate the sand which will be very loose by this time. Then the cable is pulled out a little and the procedure is repeated.

- b) For coarse sand which may also be mixed with gravel the above method does not work well. The particles are too heavy for quicksand to be created. In order to get through such layers, a less subtle technique has to be applied.

One or two men seize the cable at a high point and pull it down (Figure 71). Thus the bailer is pulled up about 50 cm and is then dropped by just letting the cable go. For the next stroke the cable is slackened off a little. When the bailer is approximately half full of sand, it must be pulled up and emptied.

Note. Do not leave the bailer at the bottom of the borehole. It might be very difficult to pull it up afterwards and it would act as a piston, sucking the sand upwards into the casing and spoiling the work done so far.

Lowering the casing

Often the sand is so loose that the casing will sink down through the force of its own weight. Shaking the pipe may also help a great deal, especially in fine sand. If this does not work, the casing is rotated clockwise and pushed down little by little by means of the casing lowering pipe.

The best moment to lower the casing is when the sand is in its most loose condition, i.e. when the bailer is lifted.

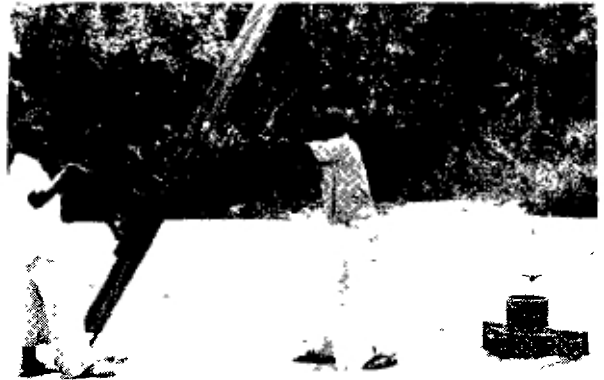

Fig. 70 Bailing in fine sand. Note the rope on the cable just above the casing.



Fig 71. Bailing in coarse sand or gravel. The winch operator should exactly follow the instructions of the person who is bailing.

Thus every time the cable goes up, the casing pipe should be pushed further down (Figure 72). The workers on the lowering pipe must be given proper instructions about this

Note: Sometimes the casing cannot go down any further. If there is a stone underneath, rooting up the sand with the small size auger should help



Fig. 72 While the bailer is lifted, the casing is pushed further down into the borehole.

Pulling up the bailer

As already explained in Section 4.3 pulling up the bailer without care can cause a flow of sand into the borehole, particularly if the bailer is pulled up quickly. Therefore the procedure below must be followed.

- 1 The bailer is hoisted up quickly while it is still below the water level.
- 2 Hoisting is stopped as soon as the top of the bailer becomes visible.
3. Two buckets of water are emptied into the casing, if water is available.
4. The bailer is pulled up slowly until it is completely out of the water
5. The hoisting speed is then increased and the bailer is pulled out of the casing
- 6 The cable is slackened off and the bailer is pushed to the soil dump, where it is emptied and a soil sample is taken.

Note: Never hold the bailer directly above your feet. If the winch operator makes a mistake, the sharp rim will definitely cause some painful injuries

7.4 Drilling inside the casing

Often the intake of the well is planned for a second or even third aquifer so that intermediate, more solid layers have to be passed through. If these layers are not too thick, for

example 2 or 3 m, the casing can easily be pushed through in order to reach the next aquifer

Drilling is then continued inside the casing with the ϕ 180 mm drill bits. They are designed to fit inside a ϕ 200/220 mm casing.

The most effective method is to drill 15 to 20 cm ahead of the casing

Then the auger is pulled up a little and the casing is pushed down, turning clockwise. The borehole is reamed by the teeth on the casing shoe so that the friction between the casing and the soil is reduced

The flight auger helps to keep the drill bit vertical in the borehole. A second means of keeping the auger in vertical position is the use of the extension rod with a disc (see also Figure 165). This should be connected at a point above the auger which is approximately one third of the total length of the extension rods (Figure 73).

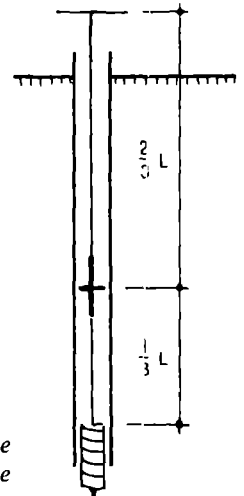

Figure 73. The position of the extension rod with disc in the borehole.

The horizontal soil pressure on the casing - and thus the frictional force - normally increases with time.

Therefore, the intake of the well must be constructed as soon as possible after completion of the borehole so that the casing can be removed.

This is especially true for deeper wells. Furthermore, the work should be planned in such a way that the casing is not left in the borehole for any length of time, such as over the week-end.

7.5 Completion of the borehole

How the borehole is completed, depends on the thickness of the aquifer and the design of the intake.

- a) If the aquifer is of limited thickness and lies above a layer of clay for example, the simplest method is to ensure that the casing has penetrated the lower layer to prevent any further caving. The casing has to be set at least 20 to 30 cm into the clay and this last part of the borehole is drilled with the ϕ 180 mm bits.

Note: If the aquifer lies immediately above the bedrock, the casing is obviously put on top of the bedrock and does not penetrate it

- b) If the aquifer is very thick and the groundwater level and its fluctuations are favourable, it could be decided to finish the borehole half-way into the aquifer. In this case caving has to be halted in a different way. Bailing is continued for 50 to 70 cm beyond the design depth of the well and the casing is also lowered to that depth. This 50 to 70 cm is then filled with layers of coarse sand and gravel of increasing grain size, with some heavy stones on top (Figure 74). Such a filter prevents sand from entering the borehole and the PVC pipe can be placed on top of it without any difficulty

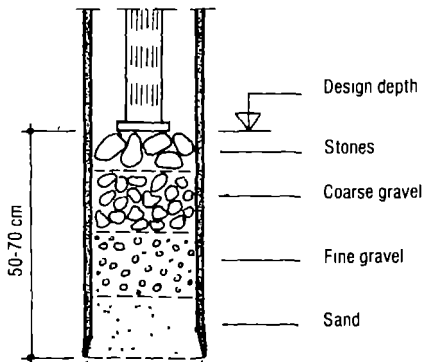

Fig 74 If the borehole is finished half-way into an aquifer, a proper filter must prevent the sand from entering before the PVC pipe is installed

7.6 Telescopic drilling

If the intermediate layer between two aquifers is of considerable thickness and the soil is stiff or sticky, such as swelling clay, it can become very troublesome to get the casing through and possibly even more difficult to get it out again. In this case *telescopic drilling* can be adopted to overcome the problem

Two telescoping sets of casing pipes (Figure 75) are used instead of one and the purpose of the first casing is simply to seal off the top aquifer. The second casing is only inserted after the intermediate layer has been drilled through. The part of the borehole below the first aquifer can be drilled using the standard procedure as described in the previous sections.

Figure 76 shows the successive steps in telescopic drilling as described below

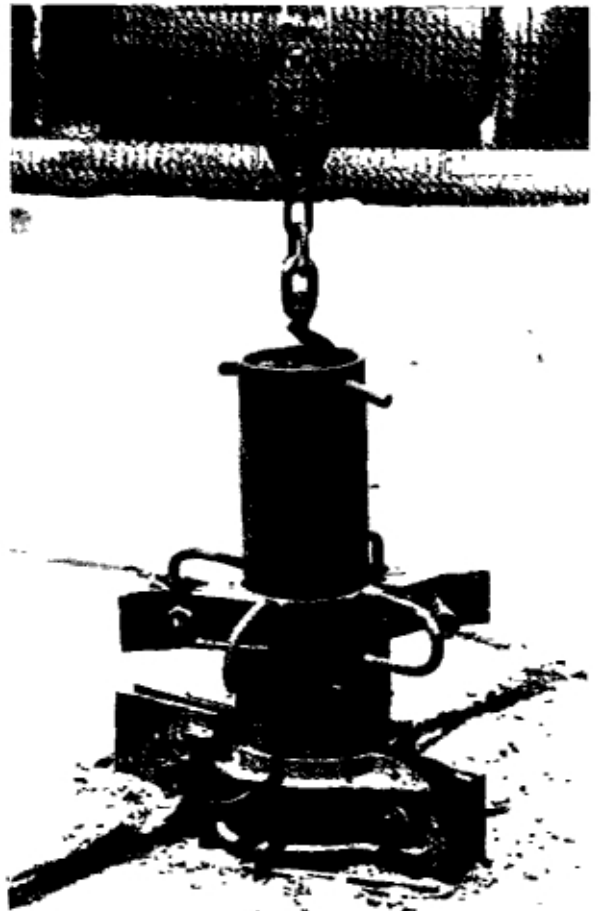

Fig. 75. With telescopic drilling a smaller size casing is inserted into the outer one, which seals off the upper aquifer.

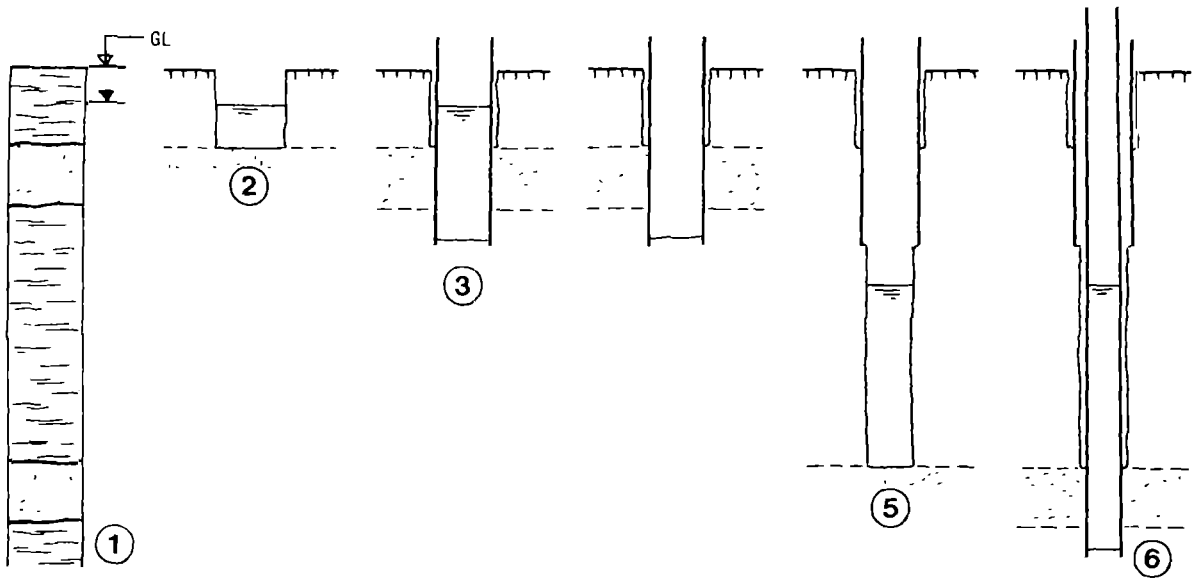

Fig 76 The successive stages of telescopic drilling. The circled numbers correspond to the text

- 1 The soil profile shows a thick clay layer between two aquifers. The well intake is to be constructed in the lower aquifer.
2. The first clay layer is drilled with ϕ 300 mm drill bits.
3. A ϕ 250/275 mm casing is inserted and bailing is carried out through the top aquifer. The casing is further lowered into the second clay layer for complete seal-off of the top aquifer.
4. The water is pumped out of the casing with a membrane pump.
5. Drilling is continued with ϕ 230 mm drill bits all the way through the thick clay layer.
6. A ϕ 200/220 mm casing is inserted into the borehole and bailing is carried out through the second aquifer. The casing is sunk into the underlying clay layer with ϕ 180 mm drill bits. The borehole is now completed.

To facilitate drilling operations afterwards, the first casing is pushed into the clay layer until there is just enough space above ground level (30 cm) to fix the casing clamp. When the ϕ 230 mm drill bits are used inside the first casing, care should be taken that they do not get stuck underneath the casing, when they are pulled up.

7.7 Borehole description

Although the surveyor has already made a borehole description, the construction team should also do so for reasons of comparison. Differences might be found in the profiles because the borehole for the well is drilled at a short distance from the survey borehole. If differences are found, the design should be adapted to the actual situation.

Generally samples are only taken from the lower part of the drill bit, unless more soil types are clearly visible. They should be described on the *Well Description Form* (see Annex 4) where all the data about the construction of the well are recorded. First general data are entered, such as well number, name of village, ward, division, and district, the date when construction was started and the name of the foreman. Then the soil samples are described in the same way as for the survey borehole description (see Section 4.5) and, in addition, the types and diameters of the drill bits used are indicated. The back of the form is reserved for data about the filter pipe, gravel pack, pump test and pump installation.

Installation of Filter Pipe and Gravel Pack

After drilling the borehole, the actual construction of the well can start which means the installation of the filter pipe and the gravel pack, together called the *intake* of the well. The function of the filter pipe is to provide a safe housing for the pump cylinder and the rising main. The part that is installed in the aquifer is provided with narrow openings or *slots*, through which the water can enter. The space between this *screen* and the borehole wall is packed with a relatively coarse and highly permeable material. The gravel used has the following functions.

- * It acts as a filter between the aquifer and the screen: the grains of the gravel pack form a physical barrier against the transport of soil particles from the aquifer so that the slots cannot get clogged.
- * It increases the permeability of the area immediately surrounding the intake, thereby contributing to a higher yield of the well.

At the same time as the gravel pack is installed around the screen, the casing has to be removed from the aquifer.

8.1 The gravel

Grain size

The gravel must have the following characteristics

- it should be coarse enough to let the finer particles from the aquifer through, when the well is developed (for development of a well, see Chapter 9),
- it should be fine enough to retain the rest of the aquifer material,
- it should be homogeneous so that the permeability is high

Experiments with filters have shown that gravel with grain sizes between 1 and 5 mm, will retain about 60% of the most common aquifer materials such as fine, medium and coarse sands. However, gravel collected from natural sources such as rivers, river-banks, streams, beaches, etc generally has a wide range of grain sizes and has to be sieved in order to obtain grains of the required dimensions. The most practical, and cheapest, way is to use hand operated sieves made from these materials which are currently available in Tanzania.

- mosquito gauze with a mesh width of 1.0 mm,
- coffee tray wire with a mesh width of 4.5 mm.

A gravel sieved between these limits (1.0 - 4.5 mm) will fulfil all the requirements mentioned above

Sieving is done as follows

- 1 Sieve the unsorted gravel with the coarse sieve first and allow the grains of less than 4.5 mm to fall through onto the fine sieve (Figure 77)

- 2 Shake the fine sieve so that the grains which are less than 1.0 mm fall through. The gravel remaining on this sieve is then within the range 1.0 to 4.5 mm (Figure 78)

Note: The gravel should be dry when it is sieved, otherwise very fine particles will stick to larger ones and a gravel of inferior quality will be obtained



Fig 77. Sieving gravel.



Fig. 78. The result of sieving. proper gravel in the middle; too fine and too coarse fractions on the sides.

Thickness of the gravel pack

In theory the thickness of the gravel pack only needs to be 2 to 3 times the size of the largest gravel particle, which means a thickness of 10 to 15 cm. This would be sufficient to guarantee a good filter action. However, in practice, it is impossible to install such a thin layer. On the other hand, the layer of gravel should not be too thick. Experiments with wells in the United States have shown that very thick gravel packs can cause serious problems during development of the well: the fine particles from the aquifer cannot pass through the gravel or only at a very slow rate, ultimately resulting in a low yield.

The optimal thickness for gravel-packed wells which are developed by manual power (hand pump and surge plunger) lies somewhere between 5 and 8 cm. How thick the gravel pack is when using different combinations of casing and filter pipe, is shown in Table 8.1.

Quantity of gravel

The volume of gravel required for a well is calculated as the design height of the gravel pack in metres, multiplied by the required quantity per metre of height. These quantities - shown in Table 8.1 - are safe estimates, since it has been assumed that the gravel will also fill the space which is cleared when the casing is pulled out. In these figures an extra amount which is required due to settlement of the gravel during development and pump test, has also been included.

For example, the gravel pack for well no 186/3-20 in Chamazi village (see Section 6.3 for the design) was installed from 10.5 m up to 7.5 m -GL. This is a height of 3 m. A filter pipe of ϕ 103/110 mm was installed and a ϕ 200/220 mm casing was used in the borehole. Thus, according to Table 8.1, the required quantity of gravel for this well was $3 \times 35 = 105$ litres.

8.2 The filter pipe

The filter is made of PVC (polyvinyl chloride). The obvious advantages of this material are

- it is resistant to corrosion,
- it has a low weight, making transport and installation easy,
- it can easily be cut to any desired length;
- it is cheap

PVC pipes must be stored in a vertical or horizontal position in a shaded place, even in the field, since they will warp when exposed to the sun.

Dimensions

The diameter of the filter pipe should take account of

- the size of the casing, the space in between should be sufficient for a proper gravel pack;
- the size of the cylinder, it should fit in the pipe.

Most commonly used in combination with the ϕ 200/220 mm casing is a filter pipe with a diameter of 103 mm inside and 110 mm outside (ϕ 103/110 mm). A ϕ 3" cylinder fits easily in such a pipe and the gravel pack will be 5.5 cm thick, which is adequate. If a ϕ 250/275 mm casing is used, a filter pipe of ϕ 117/125 mm is recommended. See also Table 8.1 below.

Both screens and plain pipes are available in standard lengths of 3 m as longer pipes would make storage, transport and handling more difficult. The pipes are provided with a socket at one end. They fit together forming a joint approximately 10 cm long which is completely watertight (Figure 79).

Note: These sockets can also be made locally. One end of a straight pipe is immersed in hot oil for some time, until the PVC becomes soft and flexible. It is then pushed over a wooden mould, the PVC expands and the socket is formed. Upon cooling with water, the PVC hardens again.

Table 8.1 Combinations of casing and filter pipe

Casing diameter (mm)	PVC diameter (mm)	Gravel pack thickness (cm)	Required gravel per m of height (litres)
200/220	103/110	5.5	35
250/275	117/125	7.5	50
250/275	147/160 ^{a)}	5.5	40

^{a)} This combination to be used when a ϕ 4" cylinder is installed

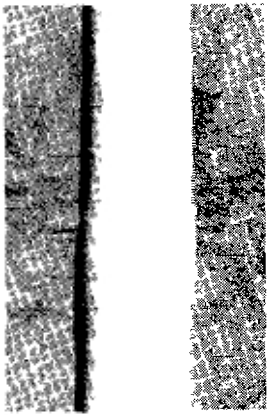

Fig 79 A joint of PVC pipes No glue is required

Size and number of slots

It is a common rule that the size of the smallest gravel particles should be at least 1.5 times the width of the slots in the screen to ensure that the gravel cannot pass through or clog up the slots. Since the gravel varies in grain size from 1.0 to 4.5 mm, the width of the slots should be $\frac{1.0}{1.5} = 0.7$ mm

This gravel will also allow particles from the aquifer smaller than 0.2 mm, to pass through during development of the well and slots of 0.7 mm will be wide enough to let these particles through

Note: It is advisable to check the slots from time to time with a feeler gauge (Figure 80). It has occurred that the yield of a well was very low even after development, although the yield of the survey pump test was fairly high. The slots appeared to be clogged by fine particles but closer inspection revealed that the slot size was only 0.3 mm, indicating that the saw blades of the slotting machine were worn out.



Fig 80. Checking the slots of a screen with gauge no. 70 (thickness 0.7 mm).

The length of the slots is mainly determined by the strength requirements of the screen: the pipe should have enough resistance to bending. Those described here have a length of 5 cm.

The number of slots must be sufficient to keep the entrance velocity of the water into the well low. When the groundwater has a particular chemical composition or when certain bacteria are present, a crust, either hard or soft, can be formed on the surface of the screen and in the pores of the gravel pack. These deposits can clog up the slots quite rapidly. This process - called *incrustation* - is accelerated with increasing velocity of the water. Experiments in the laboratory and in the field have demonstrated that, if the entrance velocity of the water is less than 3 cm/sec, the rate of incrustation is minimal. The entrance velocity is calculated as the pumped yield divided by the total open area of the screen. So the larger the open area, the lower this velocity.

The maximum hand pump capacity is approximately 3,000 l/hr, corresponding to:

$$\frac{3,000}{3,600} \times 1,000 = 840 \text{ cm}^3/\text{sec}$$

Given the maximum allowable entrance velocity of 3 cm/sec, the total open area should be

$$\frac{840}{3} = 280 \text{ cm}^2.$$

Since a single slot has an area of $0.07 \times 5 = 0.35 \text{ cm}^2$, the minimum number of slots should be

$$\frac{280}{0.35} = 800$$

The screens have slots varying in number from 1,500 to 2,000, which is amply sufficient, even if a length of only 2 m were used.

8.3 Installation of the filter pipe

Generally the entire pipe is assembled above the ground and then inserted into the borehole. First a wooden plug is knocked into the lower end of the screen (Figure 81), so that sand cannot enter the well from underneath. Then the following sections, according to the design, are succes-



Fig 81 A hardwood plug seals off the bottom of the screen.



Fig. 82 Two filter pipe sections are joined together. Note the piece of timber to prevent damage by the hammering.



Fig. 83 Sawcuts at the top of the filter pipe allow trapped air to escape and the plug will prevent the gravel from falling into the pipe.



Fig. 84. Three centering devices fixed to the screen with iron wire.

sively rammed into the sockets of the previous ones (Figure 82), until the pipe is long enough. The sections should be checked to see that they are in a straight line. The pipe is then cut to the correct length with a hacksaw.

The total length of the filter pipe must be equal to the depth of the borehole + 15 cm, i.e. the top of the pipe should be above ground level, but not above the 20 cm high concrete cover.

A second, temporary, wooden plug is put on top to facilitate pushing the pipe down against the upward pressure of the water in the borehole. Some sawcuts are made at the top of the pipe (Figure 83) so that trapped air can escape when the pipe is pushed down below the water table.

As the thickness of the gravel pack must be the same in all directions, the pipe must be installed in the very centre of the borehole. A simple means of achieving this is to fix three small wooden blocks or centering devices (Figure 84) to the pipe at both the top and bottom of the screen. If the pipe is very long, a third point should be fitted with blocks. The blocks should be so small that they will not obstruct the gravel when it is poured in.

The whole assembly should be carefully erected along the top of the tripod, where one man holds it in position (Figure 85). Take care that the pipe does not bend in the wind. The depth of the borehole is measured once more and, if necessary, it is cleaned for the last time with the bailer. Then the filter pipe is slowly lowered into the casing and is pushed down to the bottom of the borehole.

If the borehole is deeper than 12 m, the filter pipe cannot be installed as a complete unit because the full length of the pipe would bend too much when erected. In this case it is assembled in sections with the aid of a special type of clamp (Figure 86).

8.4 Installation of the gravel pack

Immediately after the installation of the pipe, the first gravel is poured in to ensure its stability.

Since the final performance of the well is highly dependent on the correct construction of the intake, the installation of the gravel pack and the removal of the casing have to be carried out with all possible care.

Precautions

If all the gravel were to be installed at once, there is a fair chance that - due to friction - the filter pipe and the gravel would be lifted up together when the casing is pulled out.

Therefore pouring in the gravel and removing the casing has to be done step by step.

The gravel must be poured in slowly - 1 mortar pan (karai) at a time (Figure 87) - and definitely not by the wheelbarrow-full! This is to prevent the formation of bridges which might block the way down

Note: The filter pipe must be kept in the centre and the gravel must be spread equally around it, for otherwise the pipe may bend



Fig. 85. The filter pipe erected along the tripod, ready for installation.



Fig 87 Gravel is poured into the borehole. The top of the filterpipe is kept in the centre with a steel pipe.



Fig 86. In relatively deep boreholes the filterpipe can be assembled in the borehole by means of this special clamp which is fixed just below the socket.

Most importantly, the casing should never be pulled up above the top of the gravel during this process!

If this happens, the surrounding aquifer material immediately fills the gap (Figure 88) As a result, the well would probably have to be re-drilled because the effect would be to produce sand in the water, especially if the aquifer consists of fine sands. A simple method of avoiding this is the following

- 1 Calculate the total length of the casing, including the casing hanger, and measure this distance on the rope of the water level meter. At this point tie a knot in the rope.
- 2 Every time the casing is pulled up, the depth of the gravel is sounded with the water level meter. As long as the knot remains about 10 cm above the top of the casing, there is no danger.
3. When a casing section is removed, the knot in the rope is moved according to the new length

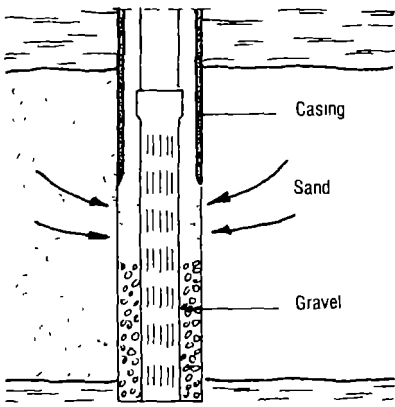

Fig. 88 The casing is pulled up too far during installation of the gravel pack. sand from the aquifer fills the gap!

Installation procedure

- 1 Three to four mortar pans (30 to 40 l) of gravel are poured in and the casing is pulled up a short distance, using the method given above to ensure that it is not pulled up too far
- 2 This procedure is repeated until the gravel has come close to the design level which must be measured carefully
- 3 Casing sections are unscrewed as soon as there is enough space to fix the clamp onto the next section (Figure 89)
- 4 The last step is to add more gravel so that it reaches approximately 25 cm above the design level as the level will drop during well development and the pump test

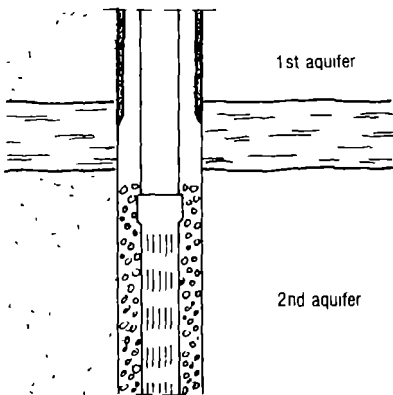

Fig. 90. The bottom of the casing should remain in the clay layer until a clay seal has been installed.

When the screen has been placed in a second, deeper aquifer, the casing should only be partly pulled up so that it remains in place in the clay layer between the two aquifers (Figure 90) Otherwise the sand from the top aquifer will fill the borehole and there will be no opportunity left for installing a clay seal (see Section 9 6)

If telescopic drilling was used sealing off the top aquifer by means of the outer casing, the inner casing can of course be removed entirely The outer casing is only removed after a clay seal has been installed

Particulars about the installed filter pipe and gravel pack are filled in on the back of the Well Description Form (Annex 4).

8.5 Methods of removing the casing

The force required to pull out the casing depends on the depth of the borehole since the friction of the soil on the outside of the casing increases with depth Furthermore, some types of clay - when exposed to water - have a tendency to swell, which creates extra pressure on the casing

If the borehole is not particularly deep, only 10 m or so, the casing can usually be hoisted up by means of the winch with double pulley The casing must always be vibrated and rotated clockwise with the casing lowering pipe because otherwise there is a chance of unscrewing a lower part of the casing Vibrating or shaking the pipe helps to reduce the friction



Fig. 89 Casing sections are unscrewed by means of a chain spanner.

For deeper boreholes however (deeper than 10 m), a force of up to 25 tons may be required to get the casing moving. The tripod, cable, winch and pulleys are definitely not designed to bear such an enormous force. If the casing were to be hoisted by means of the winch, the tripod legs might buckle, the cable and/or the pulley wheels might break, and serious injuries to operating personnel might occur. In order to prevent such damage, two 10 ton jacks should be used instead, one on each side of the casing, placed under the casing clamp (Figure 91). The winch is then only used to bear the weight of the casing. In fact, it is advisable to use the jacks even if the borehole is not particularly deep, since the amount of force cannot be predicted exactly and a tripod leg can buckle very suddenly.



Fig. 91. Overloading of the tripod can be avoided by pulling up the casing with jacks.

Development, Pump Test and Backfilling

Before the borehole is backfilled up to ground level, the well has to be *developed* and a pump test has to be carried out. The reasons for this working sequence are as follows.

- * During these operations the gravel pack around the screen will settle and become compact and therefore gravel has to be added up to the design level, before any other backfill is put into the borehole.
- * If the yield of the well proves to be insufficient, the filter pipe can still be removed easily. This would be virtually impossible if the borehole had been backfilled completely.

9.1 Objectives of development

The main objective of developing a well is to remove finer material from the aquifer. During this process the passages in both the gravel pack and the aquifer are cleaned and opened up so that the water can flow into the well more easily. It develops the well to its maximum capacity.

As we have seen in the previous chapter, the gravel pack is designed in such a way that small particles from the aquifer can pass freely through the pores of the gravel. When these particles have been removed (Figure 92), the effective porosity and the permeability of the aquifer are increased and the result is a higher yield. A second effect of removing the fine particles is that the aquifer is "stabilized". This means that no further transport of sand and silt will occur with the result that the pumped water remains free of any particles.

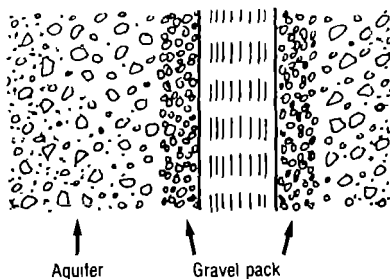

Fig 92 By developing the well the fine particles from the aquifer are removed so that the permeability is increased

When the casing is driven through a clay layer, some clay will stick to it. This clay is easily scraped off again by sharp sand when the casing is pushed further down into the aquifer. Thus when the casing is removed, a thin layer or *skin* of clay or silt is left behind between the gravel pack and the aquifer (Figure 93). Such a skin will reduce the

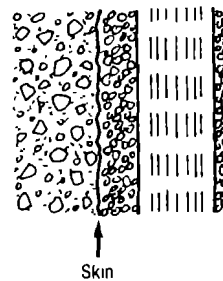

Fig 93 The "skin" between gravel pack and aquifer has to be removed

capacity of the well and consequently must be broken up and removed. This can be achieved by pushing water with force through the gravel into the aquifer.

Two simple and cheap methods can be used to develop the well: overpumping and surging. Both methods are described in more detail in the following sections but it should be noted that the best results are obtained by the alternating use of both methods. After pumping for a while, the well is surged, pumping is continued, then the well is surged again, etc.

9.2 Overpumping

This is the easiest method of removing fine particles from the aquifer. *Overpumping* means pumping the well at a higher rate than it will be pumped under normal operating conditions. A disadvantage of this is that water flows in one direction only, namely towards the well.

Equipment

The pump used for this purpose is a high-capacity membrane hand pump (Figure 94), which is of very sturdy construction and cannot be damaged by sand transport. This makes it very suitable for well development. The

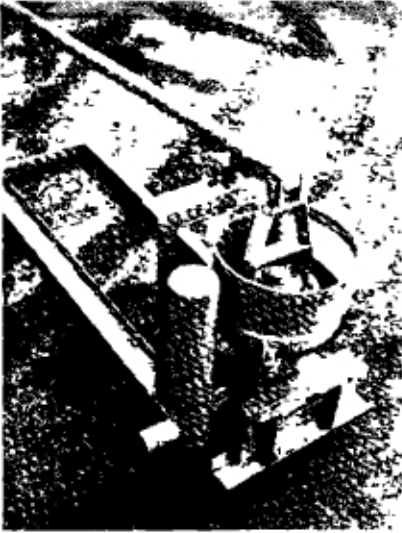

Fig 94 This membrane pump is produced in Tanzania

actual capacity of this pump is dependent on the efforts of the operators and on the water level in the well. With a water level of about 4 m -GL, the pump can produce approximately 10 to 15 m³/hr

Note: A membrane pump is a suction pump and therefore can only be used if the water level is higher than 7 m -GL. For lower levels either the survey pump, or the pump to be installed, should be used. The capacity of these pumps is much lower and the method can hardly be described as "overpumping" in this case. Still, the results obtained with these pumps are generally satisfactory, if the method is combined with surging.

Procedure

A flexible $\phi 2\frac{1}{2}$ " hosepipe is connected to the pump and is lowered into the filter pipe until it reaches the bottom. Pumping is started slowly. As soon as water appears, the pumping speed is gradually increased. If the well runs dry, some time should be allowed to elapse until the water has risen again when pumping can be resumed. If the water does not return to the original level, the screen has probably become clogged. Surging is then the only way to open up the screen again.

A good check on the effect of development is the decreasing turbidity and the increasing quantity of pumped water. Pumping is continued until the water is reasonably clear.

9.3 Surging

By surging the water, the direction of flow is reversed, namely from the well into the aquifer. This is achieved by moving a *plunger* up and down in the filter pipe, like a piston in a cylinder. It is a good method of breaking the skin and of moving the fine material through the screen into the well. This occurs on the up-stroke.

Equipment

The plunger is a piston-like tool which fits exactly into the filter pipe. It consists of 2 leather discs between metal plates with a rubber flap on top, held together by a central bolt with M16 nuts (Figure 95). Extension rods of 2 m length ($\phi \frac{1}{2}$ " GS pipe) can be connected to the bolt so that the plunger can be operated by hand.

Four holes have been drilled through the metal plates and the leather discs, with the lower plate having a special arrangement of holes (Figure 96). Thus, by turning this plate, the number of openings can be adjusted from 0 to 4. The rubber flap on top acts as a valve on the down-stroke some water can flow through and on the up-stroke the maximum possible force is used to suck the particles into the well.



Fig. 95 The surge plunger is an essential tool for the development of a well. The leather discs fit exactly in the filter pipe.



Fig. 96. By turning the bottom plate of the plunger, the impact of surging can be regulated.

Procedure

The plunger is lowered into the filter pipe until it is a few metres under water, but it should be kept above the top of the screen. If, after pumping, the water does not return to its original level, more water should be added to the pipe. Surging should be started slowly with all four holes in the plunger open. Gradually the speed is increased and the number of openings is reduced so that the surging action becomes stronger.

After 5 to 10 minutes of surging, the plunger is pulled up from the filter pipe and the sand is removed from the well by means of the membrane pump. Then the plunger is inserted again and the procedure is repeated until the amount of sand to be removed has become very small.

Note: If the water level is too low for the membrane pump, a survey bailer can be used to remove the sand. In this case some minutes should elapse until the sand has settled at the bottom of the well.

One of the reasons why the gravel pack should not be too thick, should now be clear. Since gravel is very permeable, during surging the water would only move up and down in the gravel pack instead of moving sideways into the aquifer.

9.4 Pump test

When the well has been developed and the pumped water is clean, a pump test is carried out. Like the survey test, this is not a true pump test. It would be better to call it a *well test*, because the aim of the test is to see if the yield of the well is sufficient for the use of a hand pump, thereby checking the construction of the well. If it is less than 1,000 l/hr, other measures have to be taken which will be explained in the following section.

The equipment required for this test consists of

- membrane pump with hose pipe,
- water level meter,
- measuring tape,
- bucket;
- watch or alarm clock

The same restrictions apply for the pump test as for the development of the well. If the water level is below 6 to 7 m -GL, the membrane pump cannot be used. Either the survey pump or the pump to be installed should then be used.

The test procedure is the same as for the survey pump test (see Section 4.4), except that the duration of the test is only half an hour and the number of buckets and the water level are recorded every five minutes.

Note: The extrapolation from the yield per half hour to the yield per hour is quite realistic because generally after only 5 or 10 minutes the variation in the number of buckets and drawdown is small.

The data obtained from the pump test provide information about the yield of the well, the drawdown during pumping and the recovery of the water level, which are important for judgment of the quality of the well (see also Section 5.3). This data should be entered on the Well Description Form. If the pump test failed or if specific data could not be obtained, the reasons should be written on the form.

9.5 What to do if the pump test fails

If the yield of the well appears to be inadequate, i.e. less than 1,000 l/hr, the first question should be to decide whether this is due to a poor aquifer, a construction failure or bad quality materials, i.e. filter pipe and gravel. The survey description and pump test may provide some answers.

If the survey yield was high and other wells nearby show good results, there is a fair chance that a mistake was made during construction and in this case the following steps should be taken:

- First try to improve the yield by further development
- If there is no improvement, make a new borehole at a distance of some 2 m from the old one.

If the borehole has to be abandoned, the filter pipe can be recovered as follows. A retriever (Figure 97) is connected to a strong rope and is lowered in the pipe down to the lowest section of plain PVC. Do not let the retriever down into the screen because the screen will break easily when

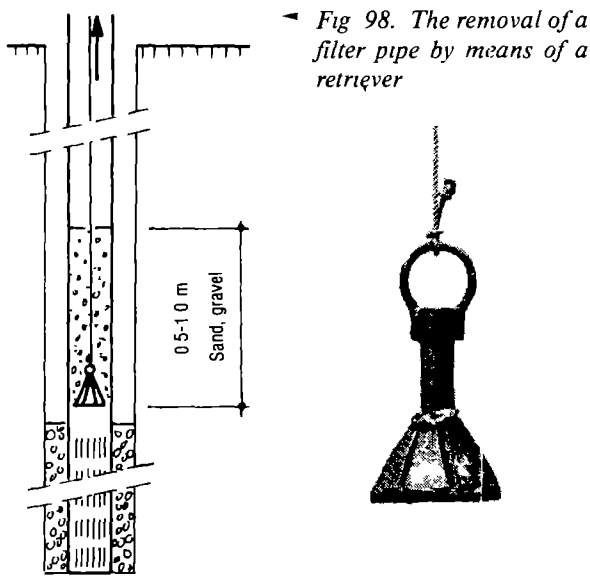

Fig. 98. The removal of a filter pipe by means of a retriever

Fig. 97. A PVC retriever

force is applied. The rope is connected to the hook on the cable. Then coarse sand and gravel (grainsize 1 to 2 cm) are poured into the pipe to a height of 0.5 to 1.0 m (Figure 98) and the cable is pulled up abruptly so that the retriever becomes firmly fixed in position. The whole pipe can then be pulled up slowly with the winch, up to the top of the tripod. The rope is then untied and further removal is done

either by hand or by fixing the cable to the outside of the pipe with a piece of rope

A close inspection of the screen may reveal the reason why the yield was low. It may be that the slot size is too small or that the slots are clogged up, which generally means that the gravel pack was not installed properly. After cleaning the screen, the filter pipe can be used again and all that is lost is the gravel and a few days work.

If, on the other hand, the survey yield was also rather low and the survey in the whole area was troublesome, then a second question - whether the villagers would accept a well with a low yield, which would mean long queues - must be decided. This can only be solved in cooperation with the village authorities. Usually the villagers will accept such a well because areas where these difficulties occur will probably have a long history of water supply problems. One solution might be to construct a second well nearby so that the waiting time is reduced, although this will raise the cost per head of population.

9.6 Clay seals and backfill

Whenever possible, the intake of the well is placed in a confined aquifer, which is protected by an overlying impermeable layer. When such a layer is perforated by drilling the borehole, it partly loses its protective function. *Clay seals* should thus be installed in the borehole wherever they can help to prevent leakage of possibly polluted water into the aquifer (see also Chapter 6).

Principle of a clay seal

Since the diameter of the filter pipe is smaller than the diameter of the borehole, there will be a space in between. This space must be backfilled to support the pipe. If the backfill consisted of permeable material only, water from the surface, such as dirty spill water, or water from an upper aquifer which might be salty or polluted, could flow down easily and contaminate the tapped aquifer (Figure 99a).

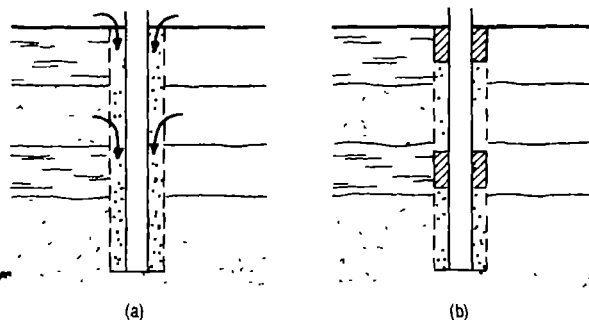

Fig 99. In order to prevent leakage from the surface or from other aquifers (a), clay seals are installed at the level of impermeable layers (b)

The only way to prevent this leakage is to install a watertight concrete or clay seal at the same depth as the clay layer(s). This acts as a kind of plug and stops leakage (Figure 99b). Clay is the most suitable material for this purpose as it is usually readily available in the form of drilled up soil.

The minimum thickness for a good clay seal is 0.50 m, but to avoid any risks, a thickness of 1 m is used wherever possible.

The drilled up soil can be used for the further backfilling of the borehole, unless top layers caving in have filled the borehole already after removal of the casing. The clay seals and the backfill must be thoroughly compacted in order to avoid cracks between the slab and the concrete cover afterwards.

Installation procedure

The clay seal should be as watertight as possible. This can be achieved by using small pieces of plastic clay which are compacted in small layers at a time. However, clay is usually drilled up from the borehole in big lumps which then lie in the sun for several days. Such dried up lumps do not compact well and water would still find its way through large openings. The clay must therefore be broken up into small pieces which are then put into water the day before use. The following day they will be moist and plastic so that they can be moulded (Figure 100). Then the pieces are put into the borehole in layers of about 20 cm (Figure 101), which are compacted with a *clay rammer* (Figure 102).



Fig 100. The clay to be used for a clay seal must be "plastic".

HAND DRILLED WELLS

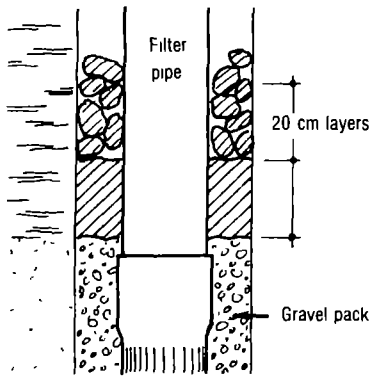

Fig 101. Clay seals must be installed in small layers at a time

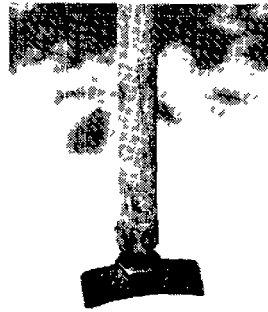

Fig 102 A clay rammer with extension rod.

A step-by-step procedure follows for the installation of a clay seal and backfilling. The numbers of the steps correspond to the circled numbers in Figure 103

- 1 If an upper aquifer is present, pull up the casing until it is still just in the clay layer, so that the borehole does not collapse before the clay seal is installed.
- 2 Check, by measuring, whether the gravel pack has reached the design level. If it is below this level, add gravel.
- 3 Install the clay seal using small quantities of plastic clay and compacting each small layer at a time, as described above
4. Measure the level of the clay and check if the seal has reached its design level.
- 5 Remove the casing completely
6. Install the backfill and compact it
- 7 Install the top clay seal up to ground level and compact it thoroughly

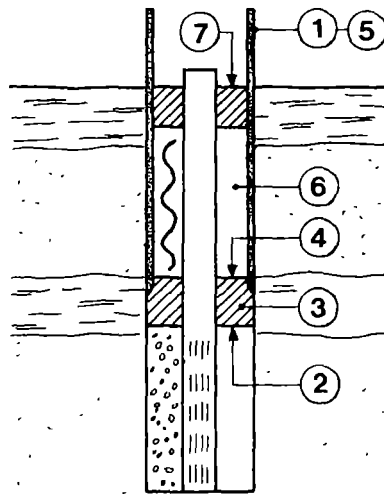

Fig 103 The procedure for installing clay seals and backfill. The circled numbers correspond to the text.

Construction of the Slab

A hand or foot pump needs to be installed on a stable base and the immediate surroundings of the pump must be protected against the adverse effects of spill water. A muddy wet place around the pump not only guarantees quick collapse of the pump foundations but also provides an excellent breeding place for mosquitoes and other harmful organisms. Moreover, the foul water can easily flow back and contaminate the well. So, for both structural and hygienic reasons, a slab must be built at the pump site to prevent these problems.

10.1 Design of the slab

The following requirements have served as a guideline for the design of the slab.

- * The part on which the pump is fixed must be stable and the filter pipe should be covered completely so that splashed water cannot flow into the well from above
- * The slab should be large enough that all pumping, bucket cleaning and filling can be done on the slab
- * The slab must be strong enough that it can bear its own weight and that of a number of people, without cracking.
- * As much spill water as possible must be allowed to flow towards a drainage area, without creating muddy places

The design shown in Figure 104 is the result of many years of experimenting in the field and appears to be very satisfactory. The advantage of this design over previous ones is that 99% of the spill water runs off through the drainage outlet. This slab essentially consists of three parts

- a concrete cover on which the pump is mounted,
- a circular platform with outer rim,
- a spill water outlet with guiding rims

Concrete cover (Figure 105)

This is the central part of the slab. A hole in the 20 cm high cover enables it to fit over the filter pipe. The pump (SWN or Kangaroo, see Section 11.1) can be fixed on top by means of 4 M16 anchor bolts, cast-in at 33 cm distance from one another around a square

Note: For the NIRA pump a slightly different model is required because the distance between the anchor bolts is smaller

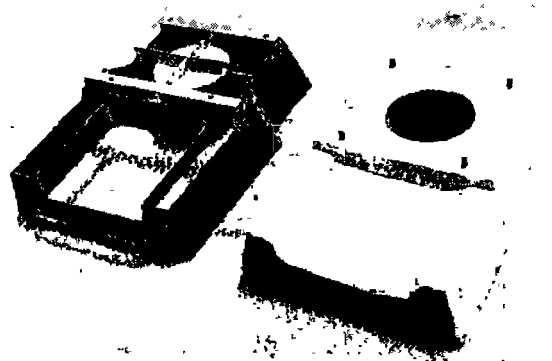

Fig 104 A concrete well cover with mould.

Buckets can be placed under the pump spout on a lower part of the cover, which is provided with a rim. This also serves as the first part of the spill water outlet. Because of its complex shape, the cover is pre-cast in a steel mould (Figure 105) and since it has to be very strong, it should be at least one month old at the time of installation. The strength of concrete increases with time.

Platform

The platform around the concrete cover slopes slightly towards the pump and the spill water outlet. The rim of sand-cement blocks, which is a few centimetres higher, prevents spill water from flowing over the sides. Experience has shown that the diameter must be approximately 3 m. If smaller, the surroundings easily become dirty whereas if larger, people tend to use the slab as a washing place.

The reasons why the platform is built as a hard-core structure, rather than concrete, are that:

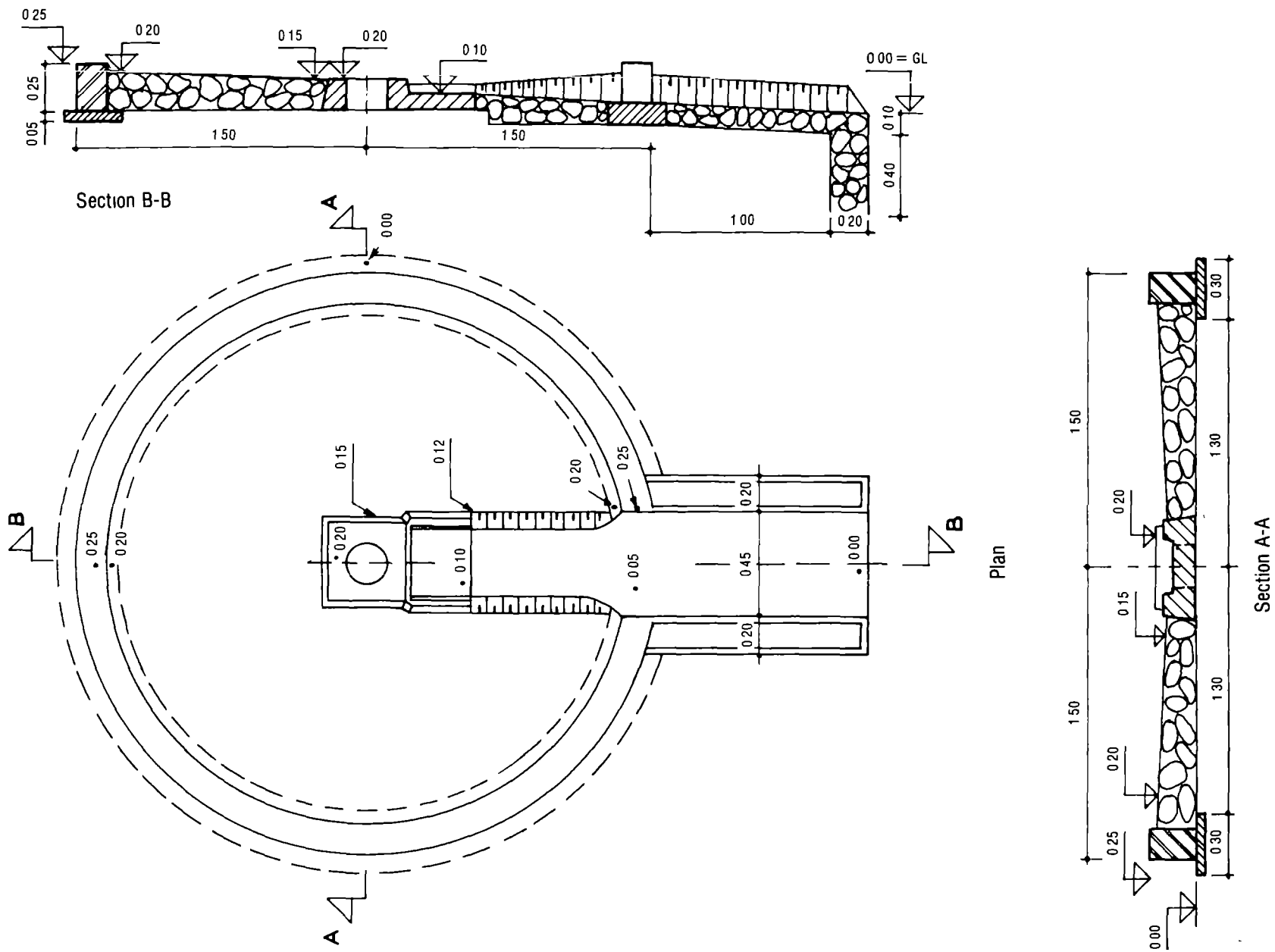

Fig 105. Design of the slab. Measures are given in metres.

- less cement is required,
- stones are often more easily available than gravel

If the mortar is carefully mixed and compacted, the strength and durability of hard-core is similar to that of concrete.

When a Kangaroo pump is to be installed, small steps made of 3 sand-cement blocks are built just behind the concrete cover (see also Figure 119)

Spill water outlet

A 45 cm wide trench runs from the concrete cover across the slab with a 1 to 2 m long extension beyond the slab itself. From the rim of the platform, two 10 cm high rims guide the water to the end of the outlet which has an extra deep footing to prevent undermining

10.2 Building materials

For this type of slab, the following quantities are required.

- 9 to 10 bags (50 kg) of cement,
- 0.6 to 0.8 m³ of sand;
- 0.6 to 0.8 m³ of stones;
- 20 sand-cement blocks

In a hard-core structure the mortar forms the "glue" between the stones. This mortar is composed of cement and sand, mixed in certain proportions with the addition of water. The mixture then hardens into a stony mass

Cement

When cement comes into contact with water, it sets hard after some time (*binding*) and *hardens* into a stony material. This hardening process can continue for months. For normal portland cement the time of hardening is about 4 weeks, but the mortar will already have reached 70% of its strength after only 1 week.

Sand and stones

The sand used for the mortar should be sharp and not rounded. Sharp sand has a rough surface which improves adhesion. It should also be clean. Clay and silt in particular, are very harmful to the density and strength of the mortar. In addition, there should not be too many fine particles in the sand, otherwise the mortar will become brittle.

The stones for the hard-core should be free of clay particles as far as possible and it may even be worth the trouble of washing them. They should be 10 to 20 cm in size.

Composition and mixing of mortar

The slab must be strong and watertight and the surface must be highly wear-resistant. Therefore the mortar for the hard-core must be dense.

A mixing ratio of cement to sand of 1 to 3 will give the best results

This ratio is determined by volume, not by weight. So for every 50 kg bag of cement with a volume of 40 l, $3 \times 40 = 120$ l of sand are required.

The quantity of water added to the mixture largely determines the final quality because although a certain amount of water is necessary for hardening and workability, a surplus will be counterproductive to the strength of the slab, as shown in Figure 106. Exactly how much water has to be added is hard to specify, since the sand may already contain some water.

In practice, only just enough water to enable the mortar to be processed is added and the product is called a *moist mortar*.

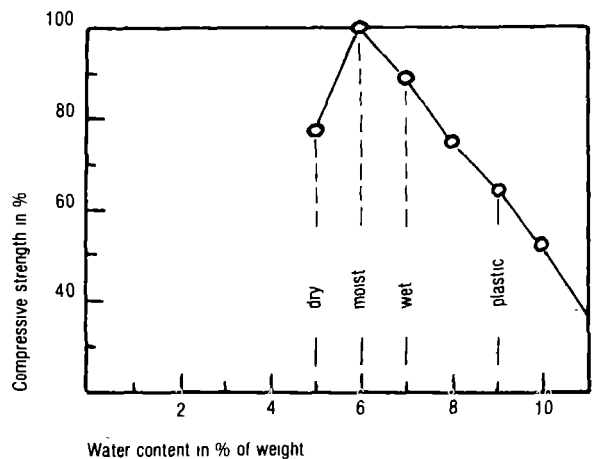

Fig 106 The strength of concrete as a function of the water content

The mortar is prepared as follows

1. An iron or wooden mixing plate of 1.5 × 3 m is laid on a flat area near the building site. The plate must be clean before mixing is started.
2. A heap of approximately 20 mortar pans (karais) of sand is put on the plate and 2 bags of cement are emptied into a hollow on top of the heap.
3. The cement and sand are mixed with a shovel, until the colour of the mixture is uniform.
4. Then water is added slowly and mixing is continued until the mortar has the required moist consistency.

Ensure that not too much mortar is prepared at a time, because after a short while processing may become difficult as cement sets hard fast in high temperatures.

Sand-cement blocks

The mixing ratio for the blocks should be at least 1 : 4, that means at least 1 part of cement to 4 parts of sand. Since the blocks are rather porous, they should be thoroughly wetted before building, otherwise they will absorb all the moisture from the fresh mortar.

10.3 Building the slab

The slab is built in two stages. On the first day the site is prepared, i.e. the area is cleaned and the soil is compacted, the concrete cover is installed, the rim of the platform is built and the trench for the foundation of the outlet is dug. On the second day, after the rim and its foundation have set hard, the platform itself and the spill water outlet are constructed and the surface is finished off. After construction, two or three days must pass before the pump is installed. During that time the slab - if cured properly - builds up in strength.

For the construction of the slab, common masonry tools are used: trowels, floats, spirit level, hammer, chisel, measuring tape, rope, iron pegs, two 1 m planks, mixing plate, wheelbarrow, mortar pans, buckets, shovels and hoes. If no clean water is available in the neighbourhood, a pump (membrane or other type) is used to draw water from the well under construction.

Preparations

The foundation area must be clean - plants and roots which may rot afterwards have to be removed and if necessary muddy top soil too. Then, in order to avoid settlement and cracks in the slab, this area has to be stabilized as follows.

1. The soil is compacted with a heavy flat tool, e.g. the casing retriever. The site for the concrete cover in particular needs to be compacted very thoroughly.
2. A thin layer - 2 to 3 cm - of wet, sharp sand is spread over the area and is compacted. Sand is a good stabilizing and foundation material because it has a high angle of internal friction.

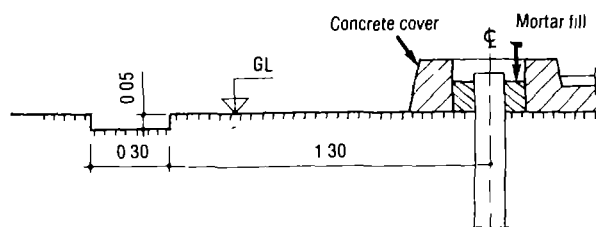

Fig 107. Excavation for the foundation of the rim (measures in m).

Installation of the concrete cover

After the soil has been compacted, the concrete cover is placed over the filter pipe, in the direction of the drainage area. Attention must be paid to the following points:

- The top of the cover must be perfectly horizontal to prevent bending of the rising main and friction between the pump-rod and the rising main. To achieve this, the horizontal position should be checked with a spirit level in two perpendicular directions.
- The filter pipe must be in the very centre of the cover, otherwise the pump will not fit over the anchor bolts.

The space between the cover and the filter pipe is filled with mortar (Figure 107) so that it can be cleaned easily during maintenance. Moreover, filling this space with mortar secures the position of the cover. In order to ensure a good bond between the concrete cover and the hard-core platform, the smooth sides of the cover are roughened by chipping with a chisel. Finally, a thin layer of mortar is applied (mixing ratio 1 : 6).

Construction of platform rim

First a shallow circular trench is dug for the foundation of the rim. The width should be 30 cm and the depth 5 cm (Figure 107). A simple method of pegging out the trench is the following:

1. One end of a rope is held at the centre of the cover and at the required distance a wooden or iron peg is tied to the rope.
2. With the rope kept taut, the peg is then drawn around the site, marking out a circle at the correct distance on the ground.

After the floor of the trench has been compacted, it is filled with mortar (mixing ratio 1 : 3) up to ground level. When the mortar has set a little, the sand-cement blocks are laid onto the foundation (Figure 108). At the site of the spill water outlet, a space of 45 cm is left open. Make sure that the blocks are wet before brick-laying starts.

Construction of platform and outlet

A trench is excavated for the spill water outlet according to Figure 109. The first part - from the concrete cover to the platform rim - has a width of 45 cm and the floor is at the same level as the foundation of the rim, i.e. 5 cm -GL. The second part - from the rim 1 m outwards - runs down a slope of 1 : 20 to a depth of 10 cm -GL and should be 95 cm wide. The end of the trench is deepened to 50 cm -GL.

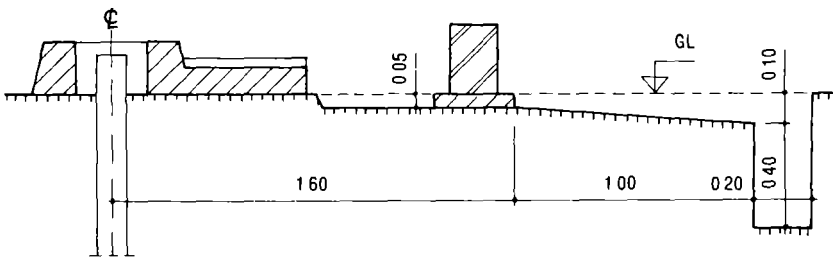

Fig 109 Excavation for the foundation of the rim (measures in m).

The building procedure is then as follows

- 1 Spread a 5 cm thick layer of mortar over the area of the slab (Figure 110).
- 2 Wet the stones in order to prevent absorption of water from the mortar
- 3 Push the wet stones into the mortar about 2 to 5 cm apart (Figure 111).

Note. In the deep footing of the outlet, mortar and stones should be placed in layers

- 4 Pour mortar with a slightly higher water content between the stones. Ensure that the mortar really fills the spaces!
- 5 Compact the mortar by pressing down with a peg or trowel, making sure that the stones do not protrude above the surface
- 6 Make the top layer of mortar slope down towards the concrete cover and the outlet
- 7 Use some planks as a mould for the rims bordering the spill water outlet (10 cm high)
8. Build steps (if necessary) using 3 sand-cement blocks. These are positioned 5 cm behind the concrete cover, opposite to the spill water outlet.

Construction details can be found in the design drawings (Figure 104).



Fig 108 The rim slab is made of sand-cement blocks.



Fig 110 Laying a foundation of mortar for the hard-core



Fig. 111 Stones are broken down to the proper size
Note the opening in the rim for the spill water outlet.

Finishing the surface

In order to get a highly resistant surface, the mortar should be worked over with a wooden float (Figure 112) without any additional cement. This must be done quite soon after pouring the mortar onto the stones. In this way a smooth and dense surface will be obtained which will last for years.



Fig 112. The surface of the slab is finished off with a float



Fig. 113. Construction of the spillwater outlet.

Note: It is sometimes suggested that a special top layer of mortar with a mixing ratio of 1 : 1 will give the required protection. In fact, a smooth surface will be obtained but such a top layer will crumble and come off easily.

The surface of the platform rim, and the steps, must be rendered to prevent crumbling of the sand-cement blocks. For this, a mortar composition of 1 : 3 is used, but some more water is added to improve the workability.

Curing

In the first stage of hardening, water is needed to ensure the strength of the cement. Therefore the slab must be kept wet for 2 to 3 days and this is known as *curing*.

Measures must be taken to prevent evaporation of moisture from the mortar, especially if the slab is exposed to high temperatures. If the moisture is retained and not allowed to evaporate, shrinkage will also be minimal and no cracks need be expected. The structure will thus become denser and more wear-resistant.

The easiest way to keep the slab wet is to cover it with wet sand, banana leaves, old cement bags, and so on. Covering the slab with plastic sheets is even better since evaporating water will condense on the inside of the sheet and drip back onto the surface of the slab.

Drainage of spill water

From the end of the outlet, a sloping gutter is dug towards the drainage area, which should be at least 5 m away from the slab. The first part of this gutter can be concreted (Figure 113) or filled with gravel to prevent erosion at the end of the outlet.

In many cases the surplus and/or spill water will be used for irrigating a small vegetable or fruit garden (see also Figure 135). However, if it is not going to be used for this purpose, and the terrain around the well is relatively flat, it will inevitably create a muddy place with dirty standing water at the end of the gutter. In order to prevent such an unhygienic situation, a provision should be made for the spill water to infiltrate into the subsoil. Most effective would be a soak-pit of at least 75 cm depth, filled with stones or coarse gravel (Figure 114).

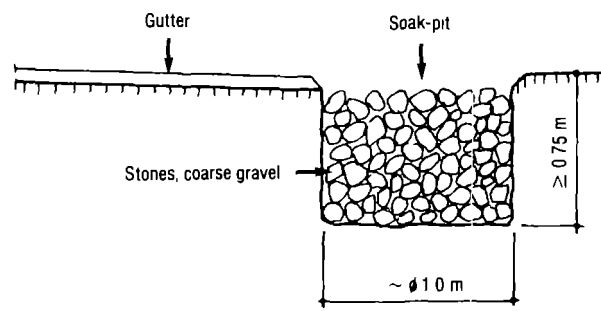

Fig 114 Section of a soak-pit

Hand Pumps and their Installation

According to estimates of the International Reference Centre for Community Water Supply (IRC), approximately 6 million hand pumps will have to be installed in the world in order to reach the Drinking Water and Sanitation Decade's target. Given this enormous future demand, it is not surprising to find booming activity and increased competition among pump manufacturers all over the world. A glance at the advertisements in an international journal such as "World Water" (Figure 115) is sufficient to learn about the struggle for this market.

As a result, the designs of existing hand or foot operated pumps have been improved and many new types of pumps have been, and still are being, developed. It is generally inefficient and uneconomical for a country to have more than 2 or 3 different types of pumps installed on a large scale. Therefore, some criteria have been indicated for making a rational choice from the large variety of pumps offered on the market. The most frequently installed pumps in Tanzania have been described in this chapter. The choice of these pumps has been mainly determined by donor agencies executing well construction programmes in the country.

Engineered for excel
Built for lasting valu

INALSA

INDIA MARK II DEEP WELL HAND P



VLOM claims to new handpump

The INALSA India Mark II Deep Well Hand Pumps are your guarantee for reliable water supply for up to 25 years.

- Operational capability of drawing water from 16 metres depth with normal yield up to 1,000 litres per hour.
- All steel construction to withstand rough handling commonly use fully galvanized for additional protection.
- Totally sealed from external contamination.
- Easy to install, operate & maintain at village level.
- Tested and certified for use by an international engineering organization.
- Over 75,000 Pumps are proving their worth in 110 and 28 other countries.

The INALSA India Mark II Deep Well Hand Pumps are suitable for bore holes in 100 mm ID. We also offer cylinders which facilitate installation in holes of 80 mm.

The pumps can be suitably adapted to metalled or well operation with minor modification. Also available for operation depths less than 10 metres.

INALSA also offers all fabricated Shallow Well Hand Pumps. Ideal for community use. Contact your nearest INALSA representative for further details.

INDUSTRIAL & ALLIED SERVICES PRIVATE LIMITED
Sunder Road, 18th Floor, South Block, New Centre, 110001 (INDIA)
Cable: INALSA India 21-35358
Telex: 352237

DEPLECHIN - DU TROPIC PUMPS

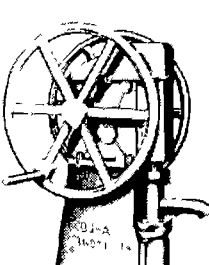

THE TRUE SOLUTION FOR THE INTERNATIONAL DRINKING WATER

LET THE WATER PUMP

- Are designed to give a minimum of 25 years continuous operation.
- Have been sold world wide for 35 years.
- Capacity up to 3,200 litres per hour lift up to 80m.
- Parts below ground level PVC coated against corrosion.
- Manual operation, easily modified for water.

THE TRUE SOLUTION FOR THE INTERNATIONAL DRINKING WATER

LET THE WATER PUMP

LUISA S.A. DEPLECHIN S



Hand operated

Construction is easy for the same people to install and operate.

Van Reekum Materialen B.V.
P.O. Box 98
7310 AB APELDOORN, HOLLAND
Phone 95 21 22.41 telex 36150



VERGNET HYDROPUMP

Installed in a trice

Specialized designed for countries where water is scarce and deep lying.

It gives years of trouble free service.

It is a VLOM pump (village level operation and maintenance).

Its hydraulic drive circuit with high density polyethylene hoses allows the pump to be installed in less than one hour without lifting equipment.

Actually more than 12000 VERGNET hydro-pumps are running in West African countries.

S.N.E. MENGIN S.A. (FAMILY OF THE BELL MONTAGNE GROUP)

Hand operated



Kangaroo No. II

The success of the Kangaroo No. II is due to its simple design, its light weight and its ease of operation. It is ideal for use in areas where water is scarce and deep lying. It is also ideal for use in areas where water is abundant and deep lying.

FLD

WATER

- No oxygen
- One flex
- No motor
- Virtually maintenance free
- Installable even underground
- True village maintenance
- Double pump of 1200 litres per hour
- Can be used for irrigation

FLD

CONSALLEN

Hand pumps for wells and boreholes



Consallen pumps are built to last. They are made of high quality materials and are designed to give you years of trouble free service.

Consallen pumps are available in a wide range of capacities and are suitable for use in a wide range of conditions.

Consallen pumps are built to last. They are made of high quality materials and are designed to give you years of trouble free service.

CONSALLEN PUMPS LTD.
281 High Street, Brighton, Sussex BN1 1US, U.K.
Phone 01273 765765

Fig 115 Advertisements for handpumps: promises, promises

11.1 Choosing an appropriate pump

Making the most appropriate choice from the available pumps is not an easy task, if one has to rely on manufacturer's advertisements and brochures alone. For example, a pump which is advertised as having proved its merits in a certain country, may not be at all suitable for other countries. It has often happened only after installing hundreds of a certain type of pump that their performance was found to be unsatisfactory. The main difficulty, however, is to find an acceptable compromise between the investment and maintenance costs and it is the latter which is generally not known in advance. For example, some manufacturers claim their pumps have many years of maintenance-free operation. What exactly does "many years" mean: 25, 10, 5 or even less than 5 years? And in the case of a breakdown, which parts are most likely to need repair or replacement?

It will be clear that such statements do not guarantee anything at all and are just too vague to base any decisions upon them. Therefore a set of more objective criteria is needed in order to assess the qualities of a pump. The criteria listed below are mainly based on the currently widely advocated "Village Level Operation and Maintenance" (for more details see Chapter 12)

- The pump should be as maintenance-free as possible
- The construction of the pump should be such that maintenance at village level with a few simple tools is possible
- Pumps and spare parts should be cheap and easily available at village level and should preferably be manufactured locally
- The pump should be easy to operate by the users, also small children

One could argue that the whole problem could be solved by installing extremely sturdy pumps such as *Climax*, *Duba* or *Monolift* pumps, which are known to require virtually no maintenance at all. In Tanzania they have an excellent record of service installed in the colonial days and they are still operational without any major repairs being necessary. Installation of such pumps in remote areas might be worthwhile indeed, but for installation on a large scale, the investment cost becomes a prohibitive factor: the pumps are 10 to 20 times as expensive as for example the *SWN* or *NIRA* pumps. Besides, local production would still be prohibited by the patents on the pumps and/or the high-precision technology required for manufacture, and therefore import would remain necessary.

On the other hand, installation of very cheap pumps of which it is known or can be expected beforehand that they will require regular repairs, is also not the solution to this problem. Which pump will be the best in a certain country under certain conditions, can only be established by

checking a number of pumps on the criteria mentioned above, by means of carefully set-up and monitored laboratory and field tests. Worldwide efforts are at present being made by the World Bank to collect and compile objective information from several test programmes for hand pumps in different parts of the world. One of these programmes is being carried out in Mtwaru Region, where five different types of pumps - including those described in Section 11.2 - are being tested.

11.2 Pumps in Tanzania

After the Morogoro Wells Construction Conference in 1980, a technical committee was formed in the Ministry of Water and Energy to put forward recommendations for a national policy on wells and pumps. The final report of this *Shallow Wells Technical Committee* is expected soon and undoubtedly recommendations resulting from the World Bank field testing programmes will be incorporated in this report.

In the meantime, the pumps being installed on shallow to medium depth wells in Tanzania are mainly the

- *SWN 80* and *SWN 81* hand pumps,
- *NIRA* hand pumps,
- *Kangaroo* foot pumps

SWN 80 and SWN 81

These lever type pumps (Figure 116) were developed by the Morogoro Wells Construction Project. They are made of steel and the originally imported variety was dip-galvanized. At present, however, the pumps are assembled in Morogoro at the MWCP workshop (Figure 117), as a first step towards complete local manufacturing, and this variety is painted.

The *SWN 80* is standard for shallow to medium depth wells with water levels down to 25 m -GL. The capacity depends on the size of the cylinder as shown in Table 11.1 below.

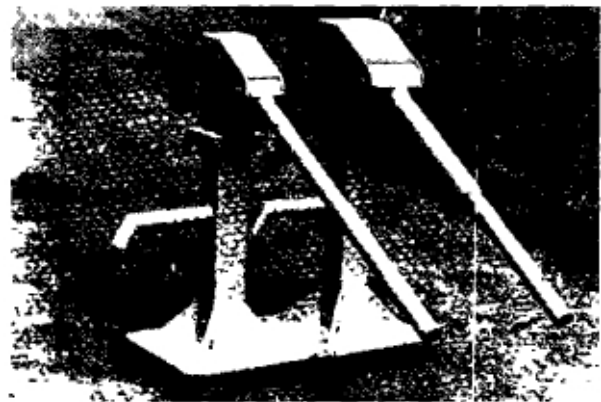

Fig 116. *SWN 80* and *SWN 81* handpumps



Fig 117 Assembly of the SWN 80 pump head in Tanzania. Photo Morogoro Wells Construction Project.

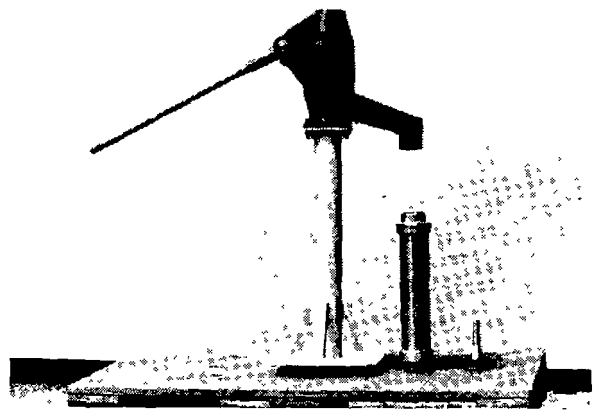

Fig 118 NIRA hand pump with cylinder and piston.

Table 11.1 Capacity of SWN 80 and 81 pumps

Cylinder diameter (")	Capacity ^{a)} (l/hr)
4	2,500
3	1,400
2½	1,000
2	600

^{a)} Based on 30 strokes per minute

The much heavier pump head and lever arm of the SWN 81 have been designed for extremely severe conditions and for use with very deep boreholes. This pump is claimed to be able to pump water from 100 m depth, if equipped with a ϕ 2" cylinder and a counter-weight on the lever arm. For further details and special attachments such as pump stands for ring wells, units for pressure or suction pumps, dewatering pumps, see Reference [7].

NIRA

This Finnish made hand pump (Figure 118) was especially designed for the water supply projects in Mtwara/Lindi Regions. The pump head is made of cast iron covered by a protective coating. The pump is considered to be strong and vandal resistant. It has a maximum capacity of 600 to 1,000 l/hr, when using a ϕ 3" cylinder. The installation procedure is similar to that of the SWN pumps.

Kangaroo

The Kangaroo pump was developed by the Shinyanga Shallow Wells Project in an attempt to replace the wooden "Shinyanga" pump by a steel one with considerably fewer moving parts, bolts, nuts and hinges, thus reducing the maintenance problems. The result was a foot operated pump which basically consists of two telescoping square

pipes, the inner one - the pump stand - welded onto a foot plate, and the outer one - the pump head - connected directly to the pumprod. The pump is operated by pushing down the step plate (Figure 119), whereupon the pump head returns to the original position through the force of a built-in spring.



Fig 119 A Kangaroo pump in action.

In the meantime the design has been further improved by the Morogoro Wells Construction Project and this pump is also assembled at the project's workshop. The main advantages of this pump are

- the long stroke of 40 cm, resulting in a high yield,
- lack of vulnerable journal or ball bearings;
- the pump remains operational even if the spring breaks because it can still be operated by pulling the pump head up by hand

The limited, invariable spring load, however, makes this pump suitable for relatively shallow groundwater only as indicated in Table 11.2

Table 11.2 Recommended size of cylinder and capacity of Kangaroo pump

Water level (m -GL)	Cylinder diameter (")	Capacity ^{a)} (l/hr)
0 - 6	3	3,500
6 - 10	2½	2,500
10 - 15	2	1,500

^{a)} Based on 30 strokes per minute

When equipped with a ϕ 4" cylinder, the pump is very suitable for small-scale irrigation but in that case the water level should not be lower than 5 m -GL

11.3 Cylinder, rising main and pumprod

All the pumps described in the previous section are *lift pumps* provided with a *deep well cylinder* below the water table in the well. This cylinder is the actual pump and is operated by the up and down movement of a *piston* inside the cylinder. The piston is moved by a *pumprod* which is connected to the lever arm of the pump or to the pump head in the case of a Kangaroo pump. The pumped water is transported through a *rising main* from the cylinder to the pump spout.

Items described in this section are all available from the Morogoro Wells Construction Project, unless indicated otherwise.

Operating principle

The principle of the *single-action cylinder* is quite simple and is schematically drawn in Figure 120

On the up-stroke (Figure 120a), the *piston valve* (A) is closed by the force of gravity and by the pressure of the water above it. Water cannot flow back into the cylinder and is forced to move upwards into the rising main. This upward movement of the piston causes a reduction in pressure below the piston so that water flows in through the *foot valve* (B).

On the down-stroke (Figure 120b), pressure above the foot valve (B) increases causing the valve to close. The

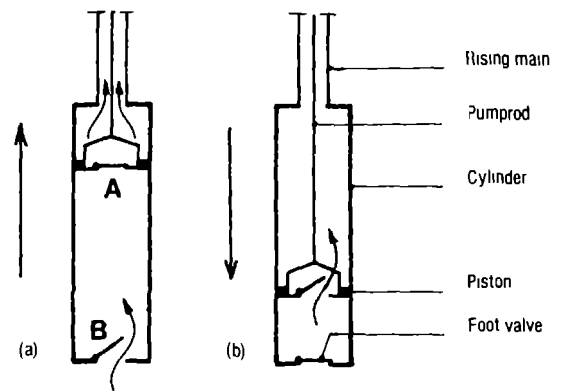

Fig 120 The principle of a single-action cylinder. (a) up-stroke, (b) down-stroke

downward movement of the piston causes the piston valve (A) to open, allowing water to flow in which, on the next up-stroke, becomes trapped inside the cylinder and is again lifted towards the pump spout.

Cylinder

Cylinders are available in four sizes 2", 2½", 3" and 4" internal diameter (Figure 121), with a standard length of 0.75 m. All these cylinders fit into ϕ 103/110 mm PVC filter pipes, except the ϕ 4" cylinder, for which a larger size PVC pipe is required such as ϕ 147/160 mm. The cylinders are made of thick-walled PVC piping and all but the ϕ 2" one are provided with thick nylon threaded discs at the top and bottom into which the rising main and foot valve assembly fit. The smaller size cylinders are provided with tightly fitting brass collars at the ends (Figure 121), in order to prevent leakage caused by very high pressure.



Fig. 121 Deep well cylinders. The smaller diameter cylinders are provided with brass collars. Note the two holes in the nylon discs.

when used in deep wells. The cylinders can be opened by means of a special spanner with pins which fit into two holes drilled in the nylon discs (Figure 122)



Fig. 122. A cylinder is opened.

Note: Very recently cylinders of 1 m length (see also Figure 121) have been introduced to allow for a length increase in the rising main, which is caused by the visco-elastic behaviour of the PVC

- The true length of PVC pipe will increase under a continuous tensile force, i.e. the weight of the pipe and cylinder, and the weight of the water column in the pipe. Therefore the cylinder will reach a lower position in the well in the course of time
- Due to the pumping action an elastic movement will occur in the pipe and the cylinder will move up and down slightly in the well

The length of the stainless steel pumprod, on the other hand, hardly increases at all under a load due to its being made of a stiffer material and the piston might thus knock the top of a short cylinder

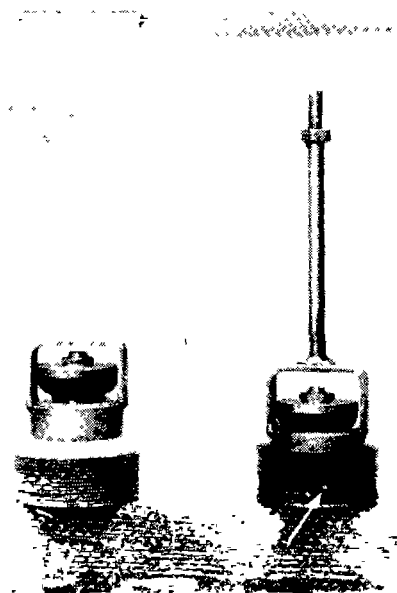

Fig. 123 Foot valve and piston with valve. Note the small hole in the piston rubber.

The piston and valves (Figure 123) are made of corrosion resistant materials such as brass, stainless steel or synthetic rubber and are extremely resistant to wear and tear. Maintenance work on a cylinder is therefore an exceptional occurrence, provided no sand, silt or other abrasive particles flow into the well. The piston is provided with a small drilled hole (see arrow in Figure 123) to prevent the piston from getting stuck to the cylinder wall.

In Mtwarra/Lindi Regions cylinders of a slightly different construction are used, but they are based on the same operational principle. The cylinder itself is made of brass and the piston and valves are of bronze and rubber (Figure 118). These cylinders are shorter since they are designed for use with hand pumps with a short stroke and a GS rising main.

The proper functioning of a cylinder is checked as follows.

- 1 Connect a pumprod hanger (Figure 128) to the piston
- 2 Put the cylinder in a bucket of water and move the piston up and down. Water should appear at the top (Figure 124); if not, one of the valves is leaking
- 3 If water does appear, stop pumping and take the filled cylinder from the bucket. The water should remain in the cylinder, if it flows out underneath, the foot valve is leaking

Usually cleaning of the valves is an adequate remedy for any possible malfunctioning.



Fig. 124 Checking a cylinder.

Rising main and pumprod

The function of the *rising main* or *riser* is to conduct the pumped water from the cylinder to the pump head. Impact resistant PVC pipes of 1½" diameter are in standard use and they are connected by means of ϕ 1½" sockets. Note

that the risers used for the NIRA pumps are made of $\phi 2''$ GS piping.

Inside the riser a *pumprod* transmits the movement from the pump, i.e. the lever arm or pump head, to the piston in the cylinder. The pumprods are made of $\phi 10$ mm stainless steel and are provided with M10 nuts and threaded ends for coupling (Figure 125). A polyethylene (PE) hose is fitted around the pumprod in order to protect the rising main from being scraped or scratched by the pumprod connecting nuts.



Fig. 125. A riser/pumprod section of 0.75 m

Riser and pumprod sections are available in standard lengths of 0.75, 1.5, 2.0, 3.0 and 4.0 m. Desired lengths, at intervals of 0.25 m, can be obtained through combinations of these elements.

Note: The use of galvanized steel pipes for the riser and pumprod has been abandoned because of serious corrosion problems. Two additional advantages of PVC risers over GS ones are the much lower weight and the greater ability to absorb water hammer impacts.

Length of the rising main

The cylinder has to be installed as low as possible in the well, since the water level may drop considerably due to – drawdown during pumping, – seasonal fluctuations.

However, it should not reach the very bottom of the well because in the course of time sand may collect there and may cause problems in the valves or piston. Furthermore, the PVC riser may slightly stretch, particularly in deep wells. Therefore, the bottom of the cylinder should be about 0.5 m above the bottom of the well (Figure 126). Since the length of the cylinder is either 0.75 or 1.0 m, the following rule is applied:

The length of the rising main (L) is found by subtracting
 – 1.25 m (if cylinder length = 0.75 m), or
 – 1.5 m (if cylinder length = 1.0 m)
 from the total well depth (D)¹⁾ rounded off to the nearest 0.25 m interval²⁾

An example of such a calculation is given below.

The depth of well no. 186/3-20 in Chamazi village is 10.7 m, as measured from the concrete cover. A cylinder of 0.75 m length is being used. The required length of rising main for this well is $10.7 - 1.25 = 9.45$ m, rounded off 9.5 m. Thus, the riser is composed of the following sections: 2×4.0 m and 1×1.5 m.

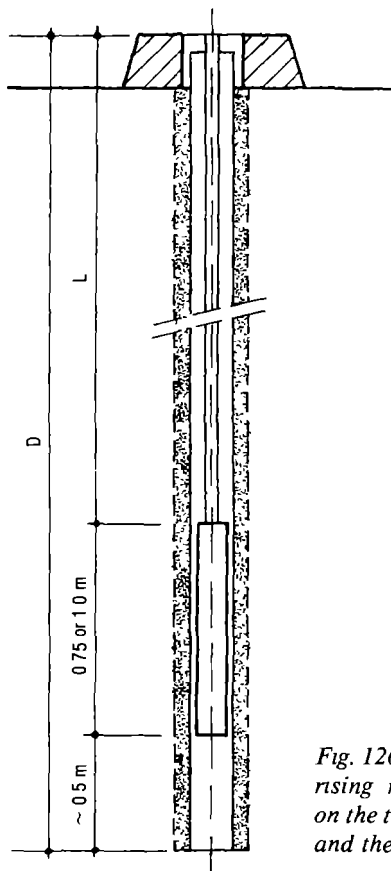

Fig. 126. The length of the rising main (L) depends on the total well depth (D) and the cylinder length.

11.4 Installation of the pump

Manpower and equipment

A trained pump fitter needs no more than one hour to install any of the types of pumps described in Section 11.2, if assisted by two or three workers from the village.

Note: Make sure that the future well caretaker and village pump attendant are present and cooperate in the installation of the pump. This is part of their training¹⁾

For the installation of the SWN and Kangaroo pumps the tools listed in Table 11.3 are required.

¹⁾ The total well depth is measured from the top of the concrete cover (Figure 126).

²⁾ Rounding off because of the standardized riser sections.

Table 11.3 Installation tools for SWN pumps

Qty	Tool	Purpose
1	Pipe vice ½" – 2", preferably on installation jack	Hold rising main and support pump temporarily
2	Open-ended spanner no 17	Connect pumprods
2	-,,- no 19	Fix pump head
2	-,,- no 24	Fix pump stand
2	-,,- no 30	Tighten main bearing bolts
2	Pumprod puller	Pull up the pumprod
2	Pumprod catcher	Prevent pumprod from falling
1	Spirit level	Check position of cover
1	Water level meter	Measure total well depth and water level
1	Measuring tape	-,,-

Most of these tools are commercially available, except for the installation jack (Figure 127) which can be made in a workshop, and the pumprod puller and catcher (Figure 128) which are special tools available from the MWCP

The equipment for the installation of a NIRA pump only differs in that certain other spanners are required

- 24" and 36" pipe wrenches;
- open-ended spanners nos 11, 14, 17, 19 and 24.

Installation procedure

Since the SWN 80 is the most frequently installed pump in the country at present, the installation procedure for this pump is given below. The procedures for the other pumps are quite similar and differ only in detail.

1. Check with the spirit level that the concrete cover is in a horizontal position. If not, it must be adjusted with good mortar
2. Measure the total well depth and select the required riser/pumprod sections as shown in Section 11.3
3. Check that the cylinder is functioning properly, according to the method described in Section 11.3
4. Connect the first sections of the pumprod and riser to the piston and the cylinder head respectively (Figure 129)
 - Use 2 no. 17 spanners for the pumprod.
 - Slide the PE protecting hose over the connector
 - Use *teflon* tape to seal the thread of the rising main. Note that any other tape is too thick and prevents the thread from fitting fully, causing unacceptable variations in length.
5. Fix the pumprod puller, lower the assembly into the well and hold it with the pipe vice.
6. Connect as many riser/pumprod sections as required, meanwhile lowering them into the well.
 - Use the pumprod puller and catcher.
 - Slide down the PE hose every time

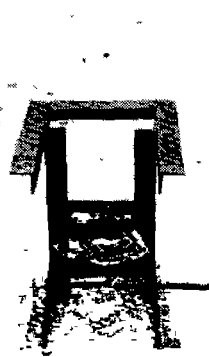

Fig 127. Installation jack with pipe vice

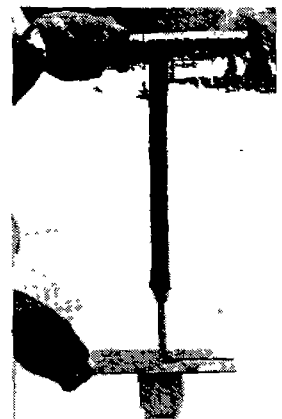

Fig 128. Pumprod puller and catcher.

7. Connect a pumprod of 0.75 m, place the pumpstand over this rod and fix the rising main to the bottom of the pump stand
 - For easier installation and for prevention of damage to the thread of the riser, a $\phi 1\frac{1}{2}$ " union could be used (male/female or female/female plus nipple)
8. Remove the pipe vice and install a flexible gasket or *compriband* around the anchor bolts (Figure 130). More details about the gasket follow in the next section.
9. Fix the foot plate to the concrete cover and tighten the nuts with a no. 24 spanner (Figure 131)
 - Remove any sand from the bolts and smear them with grease
 - Use plain M16 washers under the nuts
10. Connect the nut of the rod-end bearing in the pump head to the pumprod, keeping the lever arm in an upright position.
 - For easier installation, a special union could be used (Figure 132)
11. Lower the pump head onto the flange of the pump stand and tighten the nuts securely with a no. 19 spanner (Figure 133). Check the main bearing bolt and nut with a no. 30 spanner.

The pump is now ready for use and the only action remaining for the installation crew is to fill out the particulars of the pump on the back of the Well Description Form For an example of this see Annex 4 (well no. 186/3-20 in Chamazi)

The use of gaskets

A gasket between the foot plate of the pump and the concrete well cover is generally considered to be an essential means of preventing possibly polluted water from splashing into the well

Since the foot plate of SWN and Kangaroo pumps is flexible to some extent, the gasket for these pumps should be solid but yielding A number of gasket types have been tried out in the field

- Sisal rope soaked in bitumen, which started rotting after some time and did not seal off the foot plate completely
- Roofing compound mixed with some cement, which became too hard or too brittle and was difficult to remove.
- A rubber plate, which did not function properly because of the foot plate not being stiff enough.

At present, strips of bituminized foam plastic or *compriband* are being used The sealing function is complete, but a disadvantage is that it has to be replaced every time the pump is removed from the cover

In fact, no satisfactory solution has yet been found for this problem, if it should be considered a problem after all Some people say that the chance of splashed water becoming polluted on the concrete cover in such a short time is so small that actually no gasket is required at all However, there are other reasons for installing a gasket. One of them is that small organisms such as worms, insects, little frogs, and so on might creep into the well and end up in the water, thereby possibly contaminating it.

Note: A more permanent gasket made out of a rubber plate is only feasible if the foot plate is extremely stiff and really can be pressed onto the rubber, as is the case with the NIRA pump Here, however, the gasket is reported to have a quite different function, namely that of shock-absorber for the movements of the pump superstructure



Fig. 130. A flexible gasket under the foot plate seals off the well completely



Fig 131. The pump stand is fixed onto the concrete cover The pumprod is prevented from falling by a catcher.

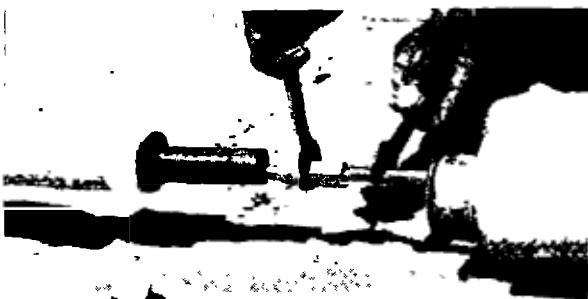

Fig. 129 The first section of riser and pumprod is connected to the cylinder and the piston



Fig 132. Connection of the pumprod to the rod-end bearing by means of a union



Fig 133 The pump head is bolted to the flange of the pump stand

Maintenance of Pumps and Wells

In the past 10 years some 3,500 hand drilled and dug wells equipped with hand or foot operated pumps have been installed in the country, the largest part of these by donor agencies and on a regional basis. While donor agencies have mainly concentrated on the construction of wells, MAJI has remained responsible for their operation and maintenance. However, the financial facilities extended to MAJI - particularly foreign funds for spares - are no longer sufficient to operate and maintain these water supply systems properly. Moreover, the costs of transport and manpower for a central organization, even at District level, are no longer in reasonable proportion to the costs of the spares and maintenance itself.

Given the growing interest in this low cost technology and the hydrogeological feasibility of large parts of the country for its application, it is anticipated that the number of wells to be constructed yearly, will increase rapidly. The maintenance costs of all these wells, however, will increase cumulatively and it will be clear that the financial and organizational problems for MAJI will become overwhelming, if no change in the approach towards the operation and maintenance of wells takes place, in the direction of:

- * a larger contribution to the maintenance by the actual beneficiaries of the wells, i.e. the villages, within the policy of self-reliance;
- * an increased donor involvement with the provision of inputs for this maintenance, especially in the field of local production of spares with emphasis on the use of local materials.

12.1 Towards village level operation and maintenance

The situation described above not only prevails in Tanzania, but in many other countries where rural water supply schemes have been constructed in a relatively short period of time. In an attempt to solve this global problem, the United Nations Development Programme (UNDP) recently launched a strategy termed *Village Level Operation and Maintenance (VLOM)*, which in brief is aimed at full responsibility of the village for the operation and maintenance of its own water supply and should eventually result in a reduction of Government expenditure.

Conditions for VLOM

It will be obvious that the communal sense of responsibility required for "VLOM" cannot be brought about from one day to the next. It is part and parcel of the process of community development, and the readiness of villagers to really take care of and pay for the maintenance of their wells will largely depend on factors such as

- the extent to which the village is involved in all phases of the water supply project,
- a sense of ownership of the wells,
- an awareness of the importance of sufficient and clean water for human health and well-being,

- the possibility of additional benefits from the wells;
- the availability and cost of spare parts

Consequently, for a proper functioning of VLOM, the technical execution of village water supply programmes should go hand in hand with.

- o increased village participation,
- o intensive health education and sanitation programmes;
- o promotion of the productive use of wells,
- o training of well caretakers and village pump attendants,
- o ease of access to and guaranteed availability of tools and spare parts,
- o supply and preferably local production of pumps and spare parts which are suitable for operation and maintenance at village level (as discussed in Section 11.1)

Village participation

Active participation by the village members in the planning and realization of their water supply, is a primary condition for generating the sense of responsibility which

is so important for successful maintenance at village level. Therefore, the village should be involved in all the successive stages of this process - allocation, planning, siting and construction

Allocation

Before any allocation of wells by the District is made, the village should have shown its sincere wish for an improved water supply by making a formal request according to the existing procedures. Furthermore, the village should elect a *Village Water Committee* to represent the village in all matters concerning the water supply and to take care of water-related developments in the village.

This committee should have the following tasks

- to locate the wells in cooperation with MAJI or the executing agency,
- to select suitable well caretakers for each well,
- to select 1 or 2 suitable persons (preferably with technical skills) for training as village pump attendants and to arrange for their remuneration,
- to arrange for the mobilization of self-help labour as required by the water project;
- to advise the village authorities on the allocation of sufficient funds for the maintenance of the wells.

Priorities of allocation should, in principle, be based on the objective need for water - walking distances, quality of existing sources - and should be discussed with the governments of the villages concerned

Planning

During the planning stage the villagers should assist MAJI in recording the village settlement pattern, future expansion areas, existing water sources and their use, and so on, in order to assess the required number of wells. After agreement has been reached about the water project (number of wells, self-help labour, well caretakers, pump attendants), the responsibilities and rights of both parties (MAJI and the village) should be stated in a formal working document

Siting of the wells

As stated above, location of the wells should take place in close cooperation with the village water committee and the committee should organize the required self-help labour for assistance in test drilling. Paid self-help labour should only be acceptable when paid for by the village

Construction

The village should agree to carry out all the unskilled work for the construction of the wells on a self-help basis. Training of selected well caretakers and pump attendants should be started at this stage. After construction, the wells are officially handed over to the village authorities, together with a document of formal ownership stating the exact responsibilities of the village with respect to the operation and maintenance of the wells

Health education and sanitation

In order for people to appreciate and eventually demand a permanent supply of sufficient and clean water, they should be aware of the benefits of such a supply for their health and the dangers inherent in the use of most traditional sources. This health and water education which is a major condition for the success of any health-related programme, should be started in the earliest stages of the project and should involve all the community, not only the people who happen to visit the dispensary. It should be the task of District or Regional Community Development workers to mobilize the local health staff and the village water committee to organize health education programmes and action plans.

In order not to become a frustrating and senseless exercise, health education should be a dialogue between users and authority, and not just a matter of lecturing the public. It should therefore make use of discussions, demonstrations and small projects, where the users are active participants, rather than formal meetings where they are simply an audience. For example, some of the well caretakers' tasks e.g. daily cleaning of the slab, spill water outlet and surroundings, could be taken over by primary school children (initially supervised by the well caretaker, later as an independent routine), and at which on-the-spot health education could be given by the dispensary staff.

Note: Posters can be a good educational aid if used for group discussions, instead of just being stuck up on the walls of village buildings. Annex 6 shows the posters available from the Morogoro Wells Construction Project. They are printed on A3 size paper.

At the same time, a sanitation programme should be started in the village, since water, sanitation and health education should complement each other if health benefits are to be realized. Such a programme, aimed at proper disposal of excreta, could start off with the provision of concrete slabs for pit latrines and, at a later stage, could help the villagers to build proper super-structures for these latrines.

Productive use of wells

Village wells are generally not used continuously throughout the day for the purpose of domestic water collection, but only during certain peak hours in the morning and in the afternoon. During the remaining hours the wells could be used for productive development projects and thus the income of the village can be raised. In this way the maintenance costs, or at least part of them, could be covered. Some examples of productive use of surplus water are:

- irrigation of fruit or vegetable gardens (Figure 134),
- irrigation of tree nurseries (Figure 135),
- poultry keeping,
- livestock feeding,
- production of sand-cement blocks



Fig 134 Small-scale irrigation of a private garden



Fig. 135 A tree nursery can increase the village income.

Training of well caretakers and pump attendants

In order for the villages to become technically self-reliant, village well caretakers and pump attendants should be properly trained for the tasks described in the following section. Training to be organized by MAJI should be started during the construction of the wells and where necessary be supplemented by special training courses.

The well caretakers - one for each well - should be

appointed by the village water committee. They should preferably be elected from among well-respected men or women living close to the wells, leading a regular life in the village and being able to use their authority to instruct the users of the well.

The pump attendants - one or two for each village or group of villages - should be responsible for the technical maintenance. They should be appointed by the District and be remunerated by the village(s) on the basis of well-defined contracts.

Tools and spare parts

For villages just embarked on self-reliant maintenance, and for trained pump attendants, lack of tools and spare parts cause the greatest frustration and demotivation. Therefore an adequate and prompt supply of these items is a must for the functioning of VLOM.

Villages authorized by the District should be able to buy spare parts and tools from an official distribution centre, either for the purpose of immediate repairs or for the creation of a village stock. Worn-out or broken parts, if repairable, should be delivered through the distribution centre to an authorized workshop and, after repair, could be offered back to the village against the cost of reconditioning.

12.2 Village maintenance tasks

In broad outline, the maintenance of a well at village level can be divided into

- a) *Preventive maintenance*, which is basically aimed at preventing the installation from breaking down and is achieved through daily care and the timely reporting of cases of any malfunction or breakdown
- b) *Remedial maintenance*, which is the diagnosis and repair of technical defects, as the need develops at the site

In the ideal situation these tasks would all be carried out at village level. However, this approach to maintenance has not been officially institutionalized yet and therefore, in most cases, for "village pump attendant" read "MAJI maintenance officer".

Preventive maintenance by the users

The water users should be responsible for proper and careful operation of the pump, observing the following rules.

- * To move the pump lever slowly over the full stroke,
- * Not to bang the lever (or pump head in the case of a Kangaroo pump) against the stroke limiters;
- * To prevent children from playing with the pump it is not a toy

They should also share a communal responsibility for the hygiene and cleanliness of the well site and, to prevent conditions dangerous to public health (see also Appendix A), the users should

- * throw away any waste water (e.g. for cleaning buckets) in the spill water outlet only,
- * wash clothes, or bath children, away from the well (construction of a special washing slab is recommended).

Preventive maintenance by the well caretaker

The responsibilities of the well caretaker should be well established in an agreement with the village authorities. In principle they should comprise the following activities.

- * Day to day supervision of water collection at the well and prevention of the misuse of pump and well site: this implies regular instruction of the users on the strict observation of the rules mentioned above
- * *Minor mechanical adjustments* such as lubrication and tightening of bolts and nuts (foot plate, pump head, main bearing).

- * Regular checks on the functioning of the pump, such as whether the foot valve is leaking, whether the pumping action is too heavy, etc.
- * Regular cleaning (and repair, if necessary) of the spill water outlet and the drainage ditch in order to prevent standing water near the well (Figure 136)
- * Proper upkeep of the surroundings of the well, e.g. filling in muddy places with sand or gravel, trimming the hedge or repairing the fence around the well, etc
- * Reporting to the village water committee if any major repairs are required or anticipated so that the pump attendant can be warned in time.

For these activities, only a few implements are required: spanners nos. 19, 24 and 30, oil, grease, a hoe and a broom. The water committee should issue these to the well caretaker.

Remedial maintenance by the pump attendant

Technical servicing of pumps and wells should take place at least twice a year (preferably once at the end of the dry season) and, of course, whenever defects in the installation



Fig. 136. An excellent breeding place for mosquitoes

HAND DRILLED WELLS

are reported by the well caretaker. The first task of the pump attendant upon his arrival at the well site, should always be to interview the well caretaker. Since his visits to a particular well may be infrequent, it is important for him to learn from the well caretaker - who checks that well day by day - whether any significant changes in pump operation, well yield, and so on, have occurred since the last maintenance visit

Technical servicing

- * In the case of malfunctioning of the pump, the pump attendant tries to detect its cause, bearing in mind the observations of the well caretaker, and carries out the necessary repairs. For this job the detailed checklist and instructions as described in Appendix F can be used. Parts which cannot be repaired on the spot are replaced with spares and delivered to the repair workshop for overhaul. If the entire pump has to be overhauled and the necessary spare is not immediately to hand, the well should temporarily be covered with a steel plate which fits over the anchor bolts (Figure 137)
- * The slab and spill water outlet have to be checked for possible cracks and cavities, which should be repaired by reaming with a chisel and then filling with mortar with a mixing ratio of 1 : 4. Moreover, the slab and outlet have to be checked for the efficiency with which they drain away the spill water and slopes should be adjusted wherever necessary
- * Loose, broken or worn-out anchor bolts should be removed and replaced with new ones, embedded in mortar of the above mixing ratio



Fig 137 During repairs the well must be covered

Maintenance report

The pump attendant should always prepare a maintenance report for every well visit. This should be submitted to the village water committee, with a copy to the District Water

Engineer. The report should clearly state which checks and/or repairs have been carried out and which parts have been renewed, with reference to the possible cause of the defects. Village, well number, water level, name of the pump attendant and date of maintenance should of course be mentioned. Annex 5 shows a possible layout of such a maintenance report

Equipment

Besides the pump installation equipment listed in Table 11.3, the pump attendant should have the following tools and materials at his disposal:

- 24" pipe wrench
- cold chisel for concrete
- hammer
- hacksaw frame + blades
- steel brush
- file, half-round
- keys for cylinders
- grease, oil
- teflon tape
- compriband gasket
- paint
- cement
- assortment of bolts, nuts and washers

12.3 The role of MAJI in well maintenance

Village level operation and maintenance of wells equipped with hand or foot pumps, will never succeed without the active support of the District or Regional MAJI offices. Training and supervision at village level and assistance in specialized maintenance jobs are one part of the MAJI tasks. Apart from preventive and remedial maintenance, two other types of maintenance should be distinguished for which a central organization is required

- a) *Corrective maintenance*, which includes any repair which cannot be done at village level and the complete overhaul of pumps and cylinders. Both require a proper workshop
- b) *Predictive maintenance*, which - through monitoring and analysis of data - is aimed at technical and organizational improvements

Direct assistance to the village

The role of MAJI in technical maintenance in the village will be restricted to the training of well caretakers and pump attendants, and to checking and supervising their work. For this purpose, regular visits to the village - twice a year is a reasonable frequency - should be scheduled

during which refresher training courses can also be given

In addition, the MAJI technician will assist in maintenance tasks which require more specialist skills, such as water quality control and disinfection of wells

Water quality control

A deterioration of the water quality usually finds its expression in complaints of the villagers about taste, smell, colour, turbidity, staining of washed clothes, etc. In such a case, a water sample should be taken for chemical and physical analysis in the laboratory and, if the results of the analysis require it, corrective measures should be taken

Disinfection

An increase in the reporting of water-borne diseases might be an indication of the presence of pathogenic organisms in the drinking water. If any particular well is suspected, it should be closed immediately and a bacteriological analysis of the water should be made. If faecal bacteria are found, the well should be disinfected as soon as possible (for a step-by-step procedure see Appendix G) and adjustive measures should be taken to prevent re-contamination of the well in the future

Corrective maintenance and distribution of spare parts.

For the repair and overhaul of pumps and spare parts from the villages, workshops should be established by MAJI at Division or District level, depending on the number of wells to be serviced in an area. For this purpose existing workshops could be authorized or new ones set up. These workshops should be equipped for repairs such as welding, thread cutting, cylinder overhaul, etc

It is recommended that, at the same time, the workshops function as distribution centres, where the villagers can purchase tools and spare parts required for those repairs which can be done at village level. Records of sales and types of repairs should be passed to the District or Regional MAJI office in order to facilitate the establishment of required stocks at, and timely delivery to, the distribution centres.

It should be the responsibility of the Region to hold a large enough stock for sale to the distribution centres and to purchase the items from suppliers in or outside the Region. Furthermore, the Region should make proper agreements with the workshop annex distribution centre about prices, and their adjustment, for both spares and repairs

Predictive maintenance

With a properly organized maintenance system, both at village and District level, a regular flow of data concerning the performance of pumps and wells will arrive at the District or Regional MAJI office, namely.

- maintenance reports from the pump attendants,
- interviews, observations and measurements by the MAJI technicians during their visits to the villages,
- records of repairs and sales at the workshops/distribution centres

By careful analysis and evaluation of these data, it will be possible to detect weak points in the construction of the pumps and wells, and in the organization and execution of the maintenance itself. Based on these findings modifications could then be made in

- the design of pump and well,
- the training of well caretakers and pump attendants,
- the frequency of maintenance visits

References

1. Cairncross, S. and Feachem, R G. (1978), *Small Water Supplies* Ross Bulletin No 10. Ross Institute of Tropical Hygiene, London
2. CBA (1978). *Coast - Dar es Salaam Regions Water Masterplan*. CBA Engineering Ltd., Vancouver
3. Davis, S N. and De Wiest, R J.M. (1966) *Hydrogeology* John Wiley, New York
4. DHV (1979) *Shallow Wells*, 2nd edition Part 2 of the final report on the Shinyanga Shallow Wells Project DHV Consulting Engineers, Amersfoort
5. DHV (1980) *Morogoro Domestic Water Supply Plan*. DHV Consulting Engineers, Amersfoort.
6. DHV (1983). Lake Basin Shallow Wells Pilot Project. Third progress report. DHV Consulting Engineers, Amersfoort.
7. DHV (1983). *Low Cost Water supply, part 2. Pumping Equipment*. DHV Consulting Engineers, Amersfoort
8. DHV (1978-1983) *Morogoro Wells Construction Project*. Progress reports. DHV Consulting Engineers, Amersfoort.
9. Feachem, R.G et al Ed (1977) *Water, Wastes and Health in Hot Climates* John Wiley, New York.
10. Feachem, R.G et al (1978) *Water, Health and Development: an interdisciplinary evaluation*. TriMed Books Ltd , London
11. Feachem, R.G et al. (1980). *Health Aspects of Excreta and Sullage Management* Volume 3 of the series Appropriate Technology for Water Supply and Sanitation. World Bank, Washington.
12. Finnwater (1977). *Mtwara - Lindi Water Masterplan* Finnwater, Helsinki
13. Hickman, G.M and Dickins, W.H.G (1973) *The Lands and Peoples of East Africa*. Longman, Dar es Salaam
14. Johnson Division, UOP Inc. (1972) *Groundwater and Wells* Edward E Johnson, St. Paul, Minnesota.
15. Ministry of Lands, Housing and Urban Development (1983). *Catalogue of Maps Tanzania* Ministry of Lands, Housing and Urban Development, Surveys and Mapping Division, Dar es Salaam
16. Ministry of Water and Energy (1980) *Morogoro Conference on Wells*. Proceedings of a conference held at Mikumi Lodge, 18-22 August 1980 Ministry of Water and Energy, Dar es Salaam.
17. Pacey, A (1977) *Hand-pump Maintenance in the Context of Community Well Projects*. Intermediate Technology Publications Ltd , London
18. Pannekoek, A J et al. (1973) *Algemene Geologie*, 2nd edition. Wolters Noordhoff, Groningen.
19. Rural Water Supply Health Standards Committee (1974) *Temporary Standards of Quality of Domestic Water in Tanzania*. In MAJI Review Vol 1 no 1 Ministry of Water and Energy, Dar es Salaam.
20. Todd, D K (1980) *Groundwater Hydrology*, 2nd edition. John Wiley, New York.
21. USAID (1979). *Health in Tanzania*. United States Agency for International Development, Health Nutrition and Population Office, Dar es Salaam
22. Watt, S B and Wood, W.E (1976) *Hand dug Wells and their Construction*. Intermediate Technology Publications Ltd., London.
23. WHO/IRC (1977). *Handpumps*. World Health Organization/International Reference Centre for Community Water Supply, The Hague.
24. Wood, C.H , Vaughan, J P. and de Glanville, H. (1981). *Community Health* African Medical and Research Foundation, Nairobi.

Appendices

- A Prevention of water-related diseases
- B Surveying equipment
- C Water quality standards
- D Well drilling equipment
- E Topographical maps
- F Checklist for pump maintenance
- G Disinfection of a well

Annexes

- 1 Village Sketchmap
- 2 Situation Sketchmap
- 3 Survey Borehole Description Form
- 4 Well Description Form
- 5 Maintenance report
- 6 Educational posters

Index

Appendix A

Prevention of Water-Related Diseases

Communicable diseases are caused by *pathogenic organisms* such as bacteria, viruses, worms, etc., most of which are microscopic in size. They are transmitted from one infected person to another, either by direct contact or indirectly through the air, water, soil or food, or through insects and other animals. With regard to the improvement of water supply conditions, we are especially interested in the *water-related diseases*: diseases which in one way or another are related to water or to impurities in the water.

Statistics from the Ministry of Health for the period 1974-1977 show that water-related diseases feature prominently among the most common diseases in the country and Table A 1 gives a summary of these findings

Table A.1 Reported hospital^{a)} cases of water-related diseases

Admissions	15%
Death cases	10%
Out-patient visits	10%

^{a)} Government and missionary hospitals
Source Reference [21]

Large variations in figures occur both between and within regions. For example, a survey carried out in regional health centres by the Morogoro Domestic Water Supply Plan in 1978, revealed that water-related diseases accounted for from 30 to 80% of all diseases reported. The actual prevalence, however, is definitely higher due to ignorance of the seriousness of the diseases or to long distances from health facilities.

If rural water supply by means of wells is to help prevent or combat these diseases, it should be understood how these are transmitted and to what extent the water is a medium in these processes. There are four mechanisms by which water-related diseases can be transmitted, each of them requiring a different preventive strategy as shown in Table A 2

These mechanisms are described in more detail below and the preventive strategies appropriate to each transmission mode have been "translated" into practical guidelines for the siting, construction and maintenance of wells.

a) Water-borne mechanism drinking water is contaminated by pathogens present in excreta of infected people or animals. If such water is used by other individuals, they may become infected as well and in

this way intestinal diseases such as cholera, typhoid, dysenteries, infectious hepatitis and diarrhoeas are spread

Obviously in order to prevent such diseases the wells should be bacteriologically safe. This implies that

- they should be located at a certain minimum distance from latrines, cattle pools, and so on;
- the well should preferably be installed in a confined aquifer, protected by an overlying impermeable layer,
- the use of clay seals in the borehole should minimize the risk of contamination by infiltrating polluted surface water;
- the pump should be completely closed (except for the spout of course) and a proper gasket should be installed between its footplate and the slab,
- where necessary, a fence should be built around the well to keep cattle away.

Education on the use of simple domestic methods of water treatment, such as sedimentation, filtration and disinfection, should further diminish the chances of infection. After all, water may also become contaminated during transport or storage in the house!

b) Water-washed mechanism. lack of water is the important factor in the spreading of diseases here. Many intestinal, and skin and eye infections and louse-borne diseases such as diarrhoeal diseases, scabies, trachoma and louse-borne typhus are caused by poor domestic and personal hygiene. This is of course greatly influenced by the availability of sufficient water for washing, cleaning, cooking, etc. The reason for the lack of water can be that either no or little water is available or that the water has to be collected (very) far from the home.

Table A.2 Mechanisms of water-related disease transmission and appropriate preventive strategies

Transmission mechanism		Preventive strategy
a. Water-borne	infections spread because pathogens are present in drinking water	Improve water quality Prevent use of unimproved sources
b. Water-washed	infections due to lack of water for personal and general hygiene	Improve water quantity Improve water accessibility Improve hygiene
c. Water-based:	infections transmitted through an aquatic invertebrate animal	Decrease need for water contact Control snail populations Improve quality
d. Insect-vector	infections spread by insect vector that depends on water	Improve surface water management Destroy breeding sites of insects Decrease need to visit breeding sites

Source Reference [9]

Note: All water-borne diseases can also be transmitted in any other way in which faecal material can be ingested, i.e. by the water-washed mechanism. Noteworthy in this respect is the cholera epidemic of 1979 in the Rufiji Delta which travelled upstream. It appeared that the disease was not spread by the river water, but through the handling of victims and food in Muslim funeral ceremonies.

Emphasis should be on quantity and availability of the water, rather than on quality and thus

- o the aquifers should yield sufficient water throughout the year (note that pump test results should be judged according to the time of the year in which the survey takes place),
- o confined aquifers are preferred because of their generally smaller seasonal water level fluctuations,
- o the number of wells should be sufficient for the local population's need and each well should be at a reasonable walking distance from the homesteads

Secondly, health education to improve the personal and domestic hygiene by increasing the water consumption is required

c) Water-based mechanism the pathogenic organism spends part of its life-cycle in animals which live in the water. For example, eggs of the worms which cause bilharzia develop into larvae inside specific snails that live in the water. The larvae return to the water and can then penetrate the skin of a person entering the water. In the human body the larvae develop into worms. The eggs of these worms leave the body via urine or faeces and if these contaminate water in which snails are living, the cycle repeats itself

Wells should be located in such a way that there is no need for people to come into contact with the water. Consequently,

- o the sites should be safe from flooding,
- o crossing of open water in order to reach the well should be avoided.

d) Insect-vector mechanism: diseases are spread by insects which either breed in water or bite near water. For example, malaria, yellow fever and river blindness are transmitted by insects breeding in water, whereas sleeping sickness is spread by the tse-tse fly which bites in the vicinity of water

First of all, wells, should be sited well away from possible breeding places such as cattle pools, ponds, and so on. Secondly, standing water near the well should be prevented. This can partly be achieved by a good design and construction of the slab:

- o the slab should be sufficiently large and be saucer-shaped in order to collect the spill water,
- o the slab should have a proper spill water outlet,
- o the connecting drainage ditch should be long enough to take the spill water clear of the well site;
- o at the end of the drainage ditch a soak-away should be dug, which is backfilled with gravel and stones

Just as important, however, is proper upkeep of the surroundings, which means that

- o the ditch should be kept clean,
- o muddy places and depressions near the well should be filled in,
- o washing of clothes on or near the slab should be prohibited.

Appendix B

Surveying Equipment

With the hand drilling equipment described in this appendix (see Table B.1 for a complete list), test boreholes can be drilled to a depth of over 20 m in unconsolidated sediments. This equipment basically consists of various types of drill bits of 70 and 100 mm diameter with extension rods, and a set of casing pipes of 75/90 mm diameter. Detailed workshop drawings of all the items of the survey drilling and test pumping equipment have been prepared and an example of these has been included in this appendix (see Figure 157). Further construction details can be obtained from the Morogoro Wells Construction Project¹⁾ where most of the equipment is manufactured.

B.1 Light-weight drilling equipment

This equipment originates from sampling tools for agricultural purposes and has been further developed for drilling to greater depth - 20 to 25 m in unconsolidated sediments

It must be operated by one man only, otherwise overloading and damage may occur

It will be obvious that different types of augers should be used for different soil types. For each auger, a short description with instructions for application, operation and maintenance is given below. All drill bits - except the flight auger, spiral auger and bailer - are manufactured in two diameters 100 mm and 70 mm, for drilling without and inside a casing respectively. They have a standard length of 0.5 m - only the bailer is 1 m long - which makes recording of the drilling depth very easy.

Combination auger

The body of the auger (Figure 138) consists of two blades, the ends of which are forged into a spiral-shaped point. This point acts as a corkscrew which forces the auger downwards. The blades, which diverge upwards to the desired diameter, cut the soil and push it into the auger body.

Application

This bit can be used for many types of soils, clay, silt or sand, provided that they are reasonably solid.

Operation

When drilling through loose soil, the combination auger must be filled completely in order to keep the material in

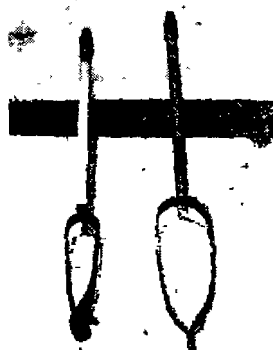

Fig 138 Combination augers

the auger. In clays, the auger should only partly be filled because a completely filled auger would smear the borehole when pulled up. In 1 to 1½ revolutions, the auger cuts through approximately 15 cm of soil.

Riverside auger

The auger body is a tube with two spoon-shaped blades welded at the bottom. The sharp ends of the blades (A in Figure 139) point downwards and are located a little outside the tube. They break up the soil, whereas the sides B cut the soil and lift it into the tube.

Application

The riverside auger is very suitable for drilling in hard, stiff soils, in sand and in soils mixed with gravel.

Maintenance

The blades of this type of auger wear out relatively fast, particularly the points A. Continuous friction with the soil

¹⁾ Morogoro Wells construction Project,
P O Box 261, Morogoro, Tanzania

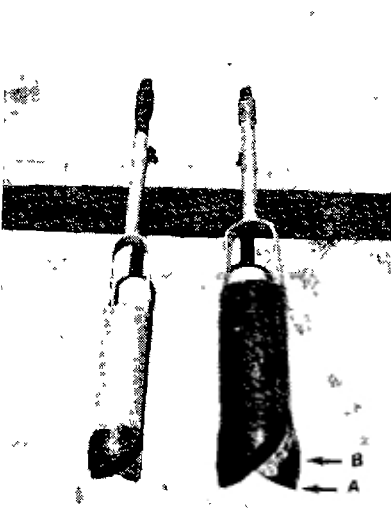

Fig. 139 Riverside augers.

will result in the blades being worn down to the profile shown in Figure 140. In this condition the blades will no longer cut but merely ride on the edges, despite pressure applied by the operator

Since this is one of the most frequently used augers, it is advisable to have a spare set of blades in stock.

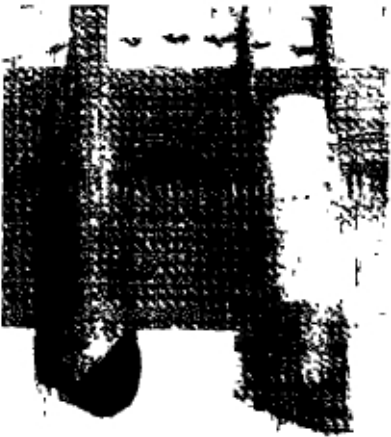

Fig 140. From time to time the blades of the riverside auger have to be replaced

Stone auger

This auger consists of two long blades, pointing slightly outwards (Figure 141) Although the auger is of very sturdy construction, the blades are fairly flexible so that stones can be loosened and lifted up

Application

The stone auger can sometimes be used in very gravelly soils instead of the riverside auger, where use of the latter is rather slow and inefficient. This auger enables large stones to be removed which would otherwise hamper drilling or bailing operations



Fig. 141. Stone augers.

Operation

Force should be applied with care This type of auger is not designed to break up rocks, but to bring them up to the surface

Stone catcher

This auger is made from a round steel bar, forged in the shape of a corkscrew (Figure 142)



Fig 142 Stone catchers

Application

The stone catcher can be used to remove large stones from the borehole and also as a "fishing tool" for items of equipment which have fallen into the borehole.

Flight auger

This is an auger with flights wound over its full length and a specially hardened bit (Figure 143). It has the same shape as the construction flight auger, but has a diameter of only 70 mm and is provided with extra reinforcing side walls

Application

The flight auger is suitable for pre-drilling in cemented soils such as calcrete and laterite and in weathered bedrock.

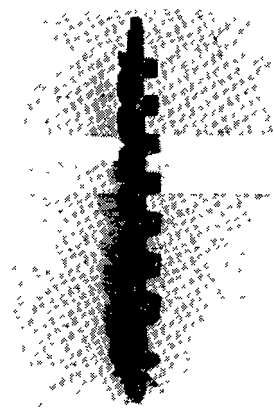

Fig. 143 Flight auger



Fig 144 Spiral auger.

Spiral auger

This bit is made from a flat steel bar, forged into a spiral form (Figure 144) It has a diameter of only 40 mm.

Application

With the spiral auger, hard layers can be broken up and the loosened material can be brought up with other types of augers afterwards

Bailer

The bailer is a tube of 2" inside diameter provided with a valve at the lower end which opens inwards only (Figure 145) The bottom rim has been sharpened for easier penetration

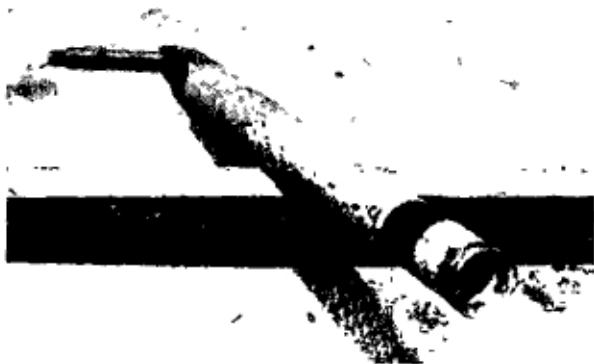

Fig. 145. Bailer

Application

The bailer is used inside the casing for penetrating water-saturated sand or silt layers

Operation

The bailer should be moved rapidly up and down in the sand, with a movement of not more than 10 cm, so that a kind of "quicksand" is developed, i.e. sand floating in the water. This facilitates the flow of sand into the tube

Maintenance

The foot valve should open and close properly and the bottom rim must be sharp. There should not be too much play in the top hinge

Extension rods

All extension rods are made out of $\phi \frac{1}{2}$ " GS piping, have a length of 1 m and are provided with male and female conical thread connectors at top and bottom respectively One of the rods is equipped with handles at the top for operation of the drill bits (Figure 146). Slots close to the threaded ends allow the use of a special extension catcher or no 24 open-ended spanner for the connection and disconnection of the rods (Figure 147)

Note: The performance of the bayonet-type couplings (Figure 148) used in earlier days proved to be unsatisfactory. The welded-on pins broke too often and the sleeves wore out too fast

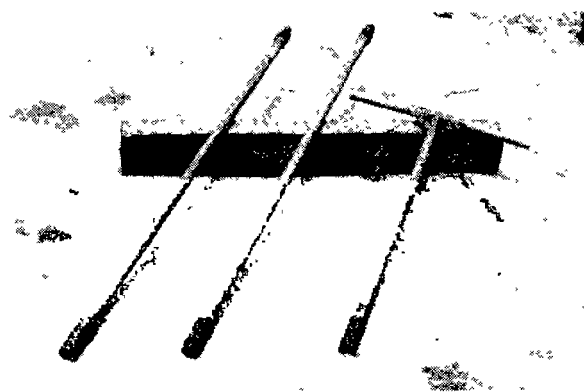

Fig. 146. Extension rods and handle.

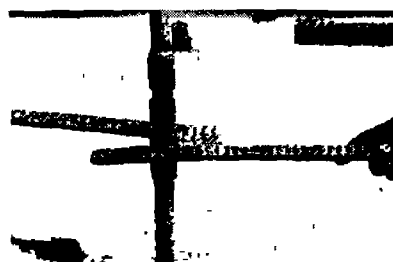

Fig. 147 The coupling of extension rods with conical thread connectors.



Fig. 148. Bayonet-type coupling.



Fig 149 Heavy-weight test drilling equipment. From left to right: combination auger, riverside augers, extension rod, kelly bar with crosspiece, handles

B.2 Heavy-weight drilling equipment

The main differences from the light-weight equipment are

- the drill bits and extension rods are of stronger and heavier construction,
- it is operated by four men instead of one

Since their purpose is mainly to penetrate hard, compacted layers, stony layers or weathered bedrock, only a few of the augers have been modified, namely the riverside auger and the stone auger (Figure 149)

The action of these augers is the same as that of the light-weight equipment. The diameters are also the same - 70 mm and 100 mm - and no different casing pipe is required. The augers are provided with a square, male connector. Extension rods are made out of $\phi 1\frac{1}{4}$ " GS piping with square connectors (40 x 40mm) at the ends. The top-most extension is always a kelly-bar to which a crosspiece with 4 handles can be attached at any desired height (see also Figure 45)

If the drilling depth exceeds approximately 10 m, the equipment has to be lowered and raised by means of a tripod with pulleys

B.3 Casing pipe and accessories

Whenever a loose sand layer below the water table has to be passed, a casing pipe has to be inserted in order to prevent caving of the borehole. The same casing can be applied with both the light-weight and the heavy-weight equipment. The casing pipes described here can last for a very long time as long as they are not operated by more than one man. They are the result of many field tests with all kinds of materials (ABS, GVK, thin-walled steel) and connector types (ABS, steel, glue, screw, etc.)

One metre long sections of ABS pipe (Acrylonitrile Butadiene Styrene, a type of plastic) of 75/90 mm diameter (75 inside, 90 outside) are used as standard casing pipes (Figure 150). One of the pipes has a length of 0.5 m in order that the height of the casing top above ground level can be adjusted for easier execution of the pump test. The sections are provided with steel male and female threaded connectors, permanently fixed (screwed and glued) into the ABS pipe.

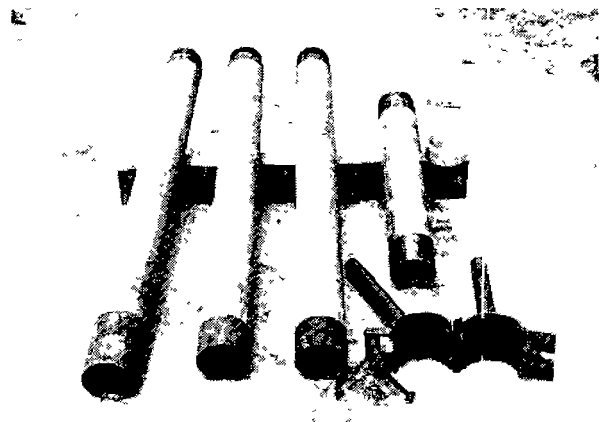

Fig 150. ABS casing pipes with steel connectors. slotted with shoe, slotted, plain, plain 0.5 m, protectoring. In the foreground a casing clamp

The threads are vulnerable and should be completely clean before connection. Cleaning should be done with a soft brush and water and not with a steel brush

Two or three sections are slotted, with saw cuts at regular distances. These form the lowermost part of the casing and permit water to flow into the casing during a pump test. A *casing shoe* (Figure 151) is screwed onto the lowest slotted section. It has a sharp rim and is slightly tapered in order to reduce the friction between casing and borehole.



Fig. 151. A casing shoe with sharp tapered rim

A *casing clamp* is used for rotating and pushing the casing down into the soil. It can be tightened around the casing at any desired height, but preferably around the metal connectors. Two of these clamps are used when the pipes are being disconnected (Figure 152). The use of pipe wrenches for this purpose is strongly discouraged as they easily damage pipes and threads.



Fig. 152. Disconnection of a casing section

The casing pipe should always be rotated clockwise (also when being removed), otherwise there is a chance of the pipe becoming disconnected somewhere below ground level.

If the casing is completely stuck in the ground and removal by hand is impossible, a *casing retriever* can be used of the same type as the PVC retriever shown in Figure 97, but of smaller diameter. However, this requires the use of a tripod with winch and cable. For a description of the procedure to be followed, see Section 9.5.

B.4 Pump test equipment

Hand pump

The pump (Figure 153) essentially consists of a $\phi 1\frac{1}{2}$ " GS pipe with a ball valve at the bottom and an outlet at the top. The pipe is moved up and down with two handles and slides inside a short piece of $\phi 2$ " GS pipe, which is connected to a foot plate. Two springs are mounted around the $\phi 1\frac{1}{2}$ " pipe. The long top one serves to push the pump back upwards and the short one underneath serves as a shock absorber. The foot valve can be lowered into the borehole to any desired depth and is connected to the pump by means of 1 m long $\phi 1\frac{1}{2}$ " PVC extensions (rising main), joined with sockets. A flexible $\phi 2$ " hose pipe can be fixed to the outlet. Under favourable conditions, i.e. high groundwater level, fast recovery and considerable effort on the part of the operator, the pump can have a capacity of about 3,000 l/hr.

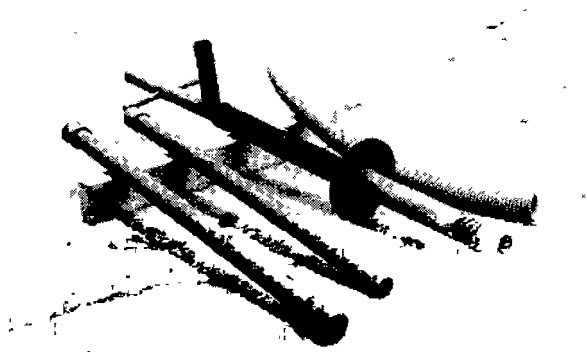

Fig. 153. Disassembled survey test pump. rising mains (one with ball valve), superstructure and hose. Note the two springs in the pump.

Principle of the pump

The pump works on the principle of inertia of the water column in the rising main. When the pump head together with the rising main is pushed down, the foot valve opens and water enters the rising main. The heavy spring makes the pipe automatically "jump" up to the original position.

It comes up so fast, that the ball in the foot valve is pressed into its seat and most of the water is trapped and prevented from flowing out. On succeeding strokes, the mass of the water in the rising main remains static whilst the pump and rising main are pushed down quickly. More water then flows in through the foot valve and a column of water builds up in the rising main which eventually reaches the outlet and flows out.

Maintenance

From time to time the springs should be greased lightly to ensure smooth operation. Cleaning can be done with diesel oil. After using the pump the threads of the rising main and the sockets should be cleaned with water and a soft brush.

Water level meter

For sounding, a water level meter (Figure 154) is used. This is a small brass or steel tube on a thin chain or nylon rope. It is closed at the top and it makes a 'clucking' sound when it touches the water surface. It has a small outer diameter - max 1.5 cm - in order not to get stuck between the casing and the sockets of the rising main of the test pump.



Fig. 154 A water level meter on a chain.

Electrical conductivity meter (E.C. meter)

Conductivity meters are available in many types and sizes. A small battery powered instrument, for example the one shown in Figure 155, serves the purposes of field work best. Electrical conductivity (E.C.) is a measure of the salt content or total dissolved solids (T.D.S.) in the water: the higher the salt content the more easily an electric current is conducted by the water.

Principle

With the battery connected, an electric current is passed through the water between the two electrodes in the test

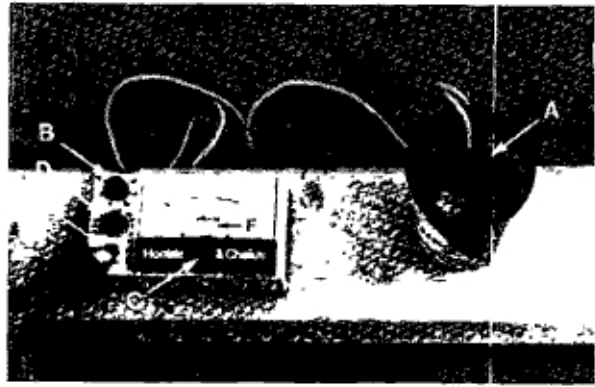

Fig. 155 An electrical conductivity meter

probe. From the voltage difference, the instrument measures the specific resistance of the water. This is converted by an internal circuit into the specific electrical conductivity, the value of which is read on the scale.

Operation

The test probe (A in Figure 155) is immersed in the water sample after checking that there is no dirt in the probe. The temperature correction button B is set at the estimated groundwater temperature, about 20 to 25 °C in Tanzania. If necessary, the pointer is set to zero with screw C on the dial. Then the selector switch D is set to its highest range, i.e. 0 - 10,000 $\mu\text{S}/\text{cm}$ and the E.C. value is measured by pushing button E. If the pointer F deflects only very little, the range is changed until a proper reading is possible. If the pointer does not deflect at all, most probably a new battery is required.

Units

Specific resistance is expressed in [ohm cm]. Since conductivity is defined as the reciprocal value of resistance, the E.C. is expressed in [1/ohm.cm], also written as [mho/cm] or Siemens per cm [S/cm]. However, for practical use this unit is much too large and a smaller unit is generally used: micro-Siemens per cm [$\mu\text{S}/\text{cm}$] (micro = one millionth part).

Fluoride test kit

This kit, shown in Figure 156, is listed as optional in the equipment list, since the fluoride content of the groundwater may be very high and requires testing in only a few regions, particularly in the northern part of the country.

A simple method has been developed by DHV Consulting Engineers¹⁾ to measure fluoride in the field. It is based on colour change in the sample, following titration. The method has an accuracy of approximately 1 mg/l, which is adequate for field work, provided that the sample is clean, i.e. no suspended matter, and that the reagents have not aged too much.

1) DHV Consulting Engineers, P.O. Box 85, Amersfoort, the Netherlands



Fig 156 With this test kit the fluoride content of the water can be determined

Table B.1 Surveying equipment^{a)}

Item	Size in mm	Recommended quantity
<i>1 Light-weight drilling equipment with conical thread connectors</i>		
Handle	$\phi 22 \times 600$	2
Extension rod,	$\phi 22 \times 1000$	20
Combination auger	$\phi 70$	2
Combination auger	$\phi 100$	2
Riverside auger	$\phi 70$	1
Riverside auger	$\phi 100$	1
Spare bit for riverside auger	$\phi 70$	2
Spare bit for riverside auger	$\phi 100$	2
Stone auger	$\phi 70$	1
Stone auger	$\phi 100$	1
Stone catcher	$\phi 70$	1
Stone catcher	$\phi 100$	1
Flight auger	$\phi 70$	1
Spiral auger	$\phi 40$	1
Bailer	$\phi 63$	1
Spare set conical thread connectors (male/female)		3

2. Heavy-weight drilling equipment with square connectors

Crosspiece		1
Handle for crosspiece		4
Kelly with pin, square	40 × 1000	1
Extension rod	∅ 30 × 1000	15
Combination auger	∅ 100	1
Riverside auger	∅ 70	1
Riverside auger	∅ 100	1
Spare bit for riverside auger	∅ 70	2
Spare bit for riverside auger	∅ 100	2
Stone auger	∅ 70	1
Bolt + nut	M12 × 50	25
Spare set square connectors (male/female)		3

3 Casing ABS with steel connectors

Pipe plain + thread protector	∅ 75/90 × 500	1
Pipe plain + thread protector	∅ 75/90 × 1000	18
Pipe slotted + thread protector	∅ 75/90 × 1000	3
Steel head	∅ 75/90	2
Casing shoe	∅ 75/90 × 100	1
Casing clamp	∅ 90	2
Retriever for casing ∅ 75/90	∅ 60	1

4. Test pumping and water quality control equipment

Test pump, head		1
Riser PVC with steel socket	∅ 1½" 500	1
Riser PVC with steel socket	∅ 1½" 1000	20
Foot valve	∅ 1½"	1
Hose	∅ 2"	1
Water level meter		1
Electrical conductivity meter		1
Fluoride test kit (optional)		1
Watch or alarm clock *		1
Bucket *		2

5 Additional tools

Compass		1
Pipe wrench	24"	2
Spanner for conical thread connector		2

a) All items in this table - except those marked with an asterisk [*] - can be purchased from the Morogoro Wells Construction Project. An up-to-date price list is available upon request.

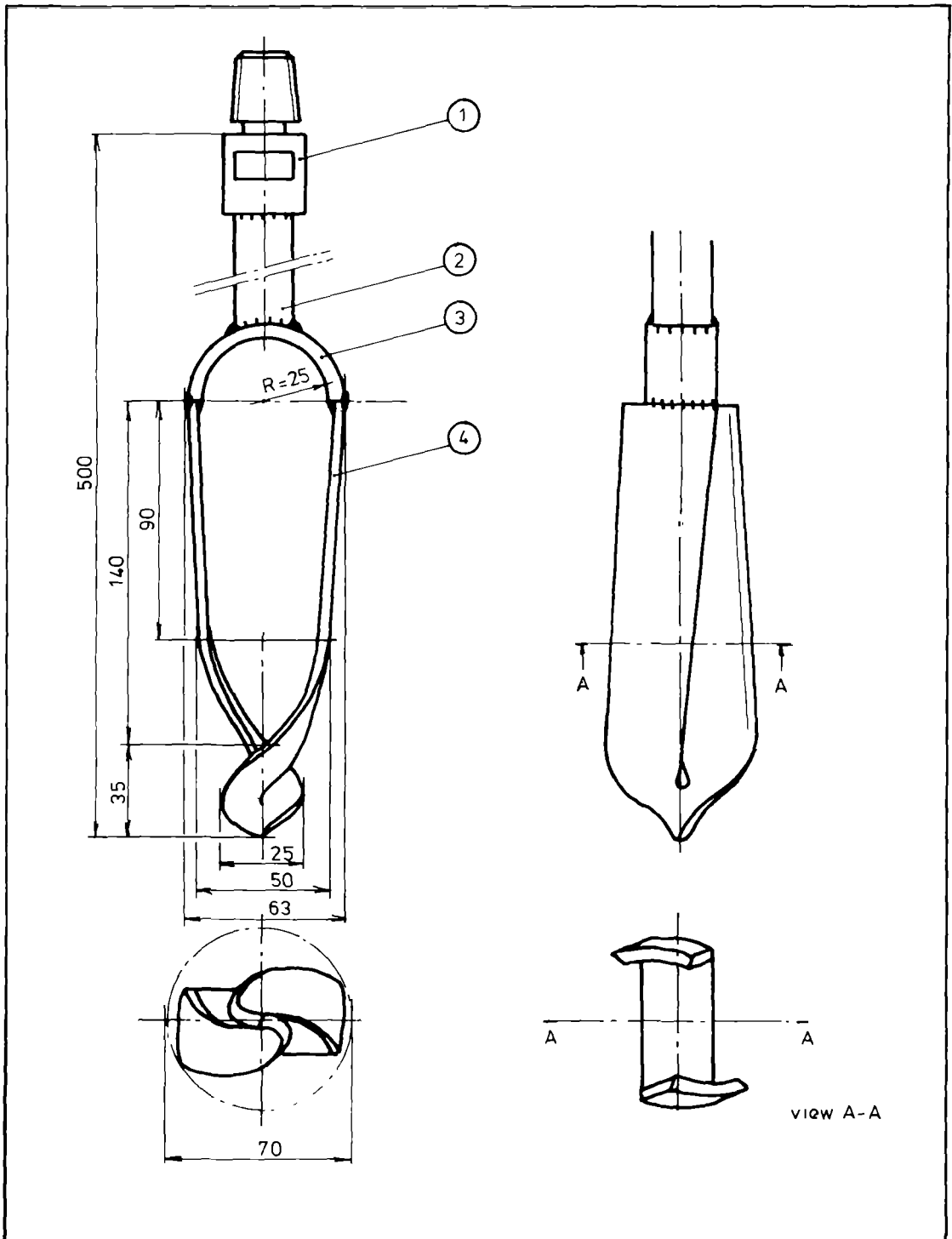

4	1	bit for combination a $\phi 70$	toolstaël (pe 35MnV7)	\neq	70 x 75 x 4	LDD 5
3	1	bracket	st 370	\neq	25 x 6 x 86	
2	1	pipe	st 370	o	1/2" x 265 mm	
1	1	conical connector male				
COMBINATION AUGER $\phi 70$				schaal 1 2	get	datum
				maten in mm	gez	
				dossierr	LDD 4	

Fig 157 Workshop drawing of a combination auger

Appendix C

Water Quality Standards

For village water supplies, i.e. systems serving a population of less than 5,000 people, the *Temporary Standards of Quality of Domestic Water in Tanzania* are applicable. These standards were drawn up in 1973 by the Rural Water Supply Health Standards Committee. They are comparable to the International Standards of the World Health Organization (WHO), except for some alterations to allow the use of groundwater for water supply systems in large parts of the country. This policy has not endangered public health so far.

C.1 Bacteriological quality

According to the Temporary Standards, drinking water should in all circumstances be free from pathogenic organisms, which may be of faecal origin. Since it is virtually impossible to do tests on all the different types of these organisms in a water analysis, it is better to look for the presence of specific bacteria which

- are only ever found in the intestines of man,
- are easy to detect and to count

If such *indicator bacteria* are found, it is certain that the water has been polluted by faecal material and that it may contain harmful organisms.

Therefore the condition that no pathogenic organisms should be present, is normally replaced by the condition that none of a limited number of indicator bacteria should be found in the sample. The most sensitive and frequently used test is that on *E. coli* bacteria. Their count is given as MPN per 100 ml of water (MPN = Most Probable Number).

The Temporary Standards for the bacteriological

Table C.1 Standards of bacteriological quality of drinking water

Bacteria	Standard
Coliforms	MPN 3/100 ml
<i>E. coli</i>	MPN 0/100 ml

Source: Reference [19]

quality are shown below in Table C.1 and they are the same as those of WHO.

These standards however are too stringent for hot climates. The application of somewhat relaxed standards based on recent studies in tropical epidemiology, has been shown to be appropriate, particularly if the high incidence of water-washed diseases in the country is taken into account. A current, widely-accepted proposal is shown in Table C.2.

Table C.2 Proposed procedures for the supply of drinking water of different bacteriological quality.

<i>E. coli</i> [MPN/100 ml]	Procedure
< 10	Supply untreated
10 - 100	Treat if possible; if not, supply without treatment
100 - 1000	Treat if possible, if not, supply without treatment or abandon, depending on various other factors ^{a)}
> 1000	Treat if possible; if not, abandon or supply without treatment, depending on various other factors ^{a)}

^{a)} These factors mostly refer to the availability of alternative sources and technical/economical feasibility of their exploitation.

Source: Reference [9]

C.2 Chemical and physical quality

Water is a very good solvent for all kinds of substances. Some of these are toxic (poisonous) and, if present in concentrations above the permissible level, can be an acute and serious danger to health. Some examples are arsenic, lead, phenols, pesticides.

Other substances of mineral or organic origin can affect human health after prolonged periods of ingestion. For example, a very high fluoride content may result in damage to teeth and bones. Nitrates may have an adverse effect on the health of small babies.

A third group can make the water and its use unpleasant. For most of these substances the Temporary Standards only give tentative figures: it is mainly the consumer who judges whether the water creates discomfort or a nuisance. For example, water with iron in concentrations higher than 1 mg/l is completely harmless to health but it can give an unusual taste to the water and laundry washed with such water may become stained. The salinity of water also cannot be prescribed by rigid limits and standards for the physical quality (colour, turbidity, taste, odour, pH) are only given as tentative figures. Table C.3 shows the Tanzanian Temporary Standards and a comparison with the WHO Standards.

C.3 Environmental criteria

The Temporary Standards give guidelines for the sanitary protection of the water intake and surrounding land. The intake of a water supply system should be at a minimum distance of:

- 50 m from pit latrines, septic tanks, sewers,
- 100 m from borehole latrines, soak pits, trenches and sub-surface sewage disposal,
- 150 m from cesspools, sanitary land field areas and graves.

These criteria are partly based on the rate of movement of bacteria and viruses through soils and on their survival period. Although bacteria and viruses are largely retained by the first metre of soil around the sanitary and other installations listed, there have been actual recordings of them travelling the distances mentioned as a minimum. In cases of doubt, it is up to the water or health authorities concerned to decide whether or not an intake site should be abandoned. In addition, the following precautions are recommended:

- livestock must be kept away from the intake by fencing the area (minimum radius 50 m);
- defecation and urination in the area must be prohibited by law,
- drainage and run-off water should be led away;
- soil erosion should be prevented.

Table C.3 Standards for the chemical and physical quality of drinking water.

No.	Water Classification and Substances	Units	Standards of water		
			International (a)		Tanzanian (b)
			Acceptable	Allowable	
1	Water causing toxic effects				
1 1	Lead, Pb	mg/l	n m	0 05	0 10
1 2	Arsenic, As	mg/l	n m	0 05	0 05
1 3	Selenium, Se	mg/l	n m	0 01	0 05
1 4	Chromium (b+), Cr	mg/l	n m	0 05	0 05
1 5	Cyanide, CN	mg/l	n.m.	0 20	0 20
1 6	Cadmium, Cd	mg/l	n m	0 01	0 05
1 7	Barium, Ba	mg/l	n m	1 00	1 00
1 8	Mercury, Hg	mg/l	n m	n m	n m
1 9	Silver, Ag	mg/l	n.m.	n m	n m
2	Water affecting human health				
2 1	Fluoride, F	mg/l	n m	1 5	8 0
2 2	Nitrate, NO ₃	mg/l	n m	30 0	(100)
3	Water for general domestic use				
3 1	Water being organo-septic				
3 1 1	Colour	mgPt/l	5	50	50*
3 1 2	Turbidity	mgSiO ₂ /l	5	25	30*
3 1 3	Taste	—	n.o	n o	n.o *
3 1 4	Odour	—	n.o	n o	n o *
3.2	Water of salinity and hardness				
3 2.1	pH	—	7 0–8.5	6.5–9 2	6 5–9 2 ^a
3 2 2	Total filtrable residue	mg/l	500	1500	2000*
3 2 3	Total hardness	mgCaCO ₃ /l	n.m	n m	600*
3 2 4	Calcium, Ca	mg/l	75	200	n.m
3 2 5	Magnesium, Mg	mg/l	50	150	n.m.
3 2 6	Magnesium–Sodium Sulphate	mg/l	500	1000	n.m
3 2 7	Sulphate, SO ₄	mg/l	200	400	600*
3 2 8	Chloride, Cl	mg/l	200	600	800*
3.3	Water with non toxic metals				
3 3.1	Iron, Fe	mg/l	0 3	1 0	1.0*
3 3 2	Manganese, Mn	mg/l	0.1	0.5	0 5*
3 3.3	Copper, Cu	mg/l	1.0	1 5	3.0*
3 3 4	Zinc, Zn	mg/l	5.0	15 0	15.0*
3 4	Water with organic pollution of natural origin				
3 4.1	BOD 5	mgO ₂ /l	n m	6 0	6 0
3 4 2	PV (Oxygen abs KMnO ₄)	mgO ₂ /l	n m	10	20
3 4 3	Ammonium, NH ₃	mg/l	n m	0.5	n.m
3 4 4	Total Nitrogen, exclusive Nitrate	mg/l	n.m	0 1	1 0
3 5	Water with organic pollution introduced artificially				
3.5.1	Surfactants ABS	mg/l	0.5	1 0	2.0*
3 5 2	Organic matter as carbon in chloroform extract	mg/l	0 2	0 5	0 5
3 5 3	Phenolic substance as phenol	mg/l	0.001	0.002	0.002

Notes:

n m = not mentioned

n o = unobjectionable

(a) = Intern Standards for Drinking Water, WHO, Geneva, 1963

(b) = Proposed temporary standards for Rural Water Supplies by RWSHSC, 1973

* = tentative figures

Source Reference [19]

Appendix D

Well Drilling Equipment

Boreholes for wells of shallow to medium depth - maximum 20 m - can be drilled in unconsolidated soils by manual labour with the equipment described below.

- * Tripod with winch and pulley system.
- * Drill bits of 180, 230 and 300 mm diameter.
- * Extension rods with accessories.
- * Casing pipes of 200 and 250 mm internal diameter with accessories.
- * Various special and general tools.

A comprehensive list of the equipment - including that for further construction of the well and installation of the pump, described in detail in the relevant chapters - is given in Table D.1 at the end of this appendix. As with the survey drilling equipment, fully detailed workshop drawings of all the items of the construction drilling equipment have been prepared. An example of such a drawing is shown in Figure 169.

D.1 Tripod and accessories

The three legs of the tripod which are made out of $\phi 2''$ GS pipe, have a length of 6 m each. One of the legs is made with a double strut for extra strength. On this double leg a two-speed winch (Figure 158) is mounted, from which a cable is led to a pulley system, hung from a hook at the top of the tripod (Figure 159) Both winch and pulley system greatly reduce the manual force required for hoisting and lowering the drill bits

At the top, the legs are kept together by means of a bolt with wing nuts. The upper pulley is attached to the tripod with a D-shackle. One end of the steel cable - 30 m long,

10 mm diameter - is provided with an eye and is attached with a D-shackle to the upper pulley. The other end of the cable is slid over the pulley wheel and wound up onto the drum of the winch. The lower pulley with flap-door and swivel-eye is hung in the loop of the cable.

The moving parts of the winch must be greased regularly by filling the grease-cups (Figure 158). When too much old grease has accumulated between the gear-wheels, the winch should be taken apart with allen keys, cleaned with diesel oil and greased anew. The pulley wheels must be lubricated regularly with a small amount of grease.



Fig 158 Two-speed winch on the double leg of the tripod. The grease-cups are indicated by arrows.



Fig 159. Pulley blocks and cable arrangement. By using the second pulley wheel of the upper block as well, the required force can be further reduced

D.2 Drill bits

The standard hand drilling equipment consists of a bailer and the following drill bits: auger bits, conical auger bits, continuous flight augers and riverside augers. All drill bits are available in three standard sizes: 180, 230 and 300 mm diameter. They are provided with a male hexagonal connector for the extension rods. Normally drilling is started with the ϕ 230 mm bits. The small size - ϕ 180 mm - is used when drilling is continued inside a casing. The ϕ 300 mm bit is only needed when the telescopic drilling method is used (see Section 7.6) or when a larger than normal filter pipe is to be installed, e.g. for a pumped supply system with submersible pump or for a ϕ 4" cylinder. The drill bits are made for anti-clockwise rotation, in order to avoid unscrewing a lower part of the casing, when drilling inside it.

Auger bit

This bit has two spiral shaped blades around a short ϕ 2" pipe, ending in a twisted point (Figure 160). The lower parts of the blades are reinforced and are provided with cutting edges of tool steel. Auger bits are made in the following lengths: 190, 220 and 275 mm.



Fig 160. An auger bit
Note the teeth at the lower part of the blades.

Application

This type of bit is particularly suitable for moist clay, silt, sand and also for gravel. It is normally used in combination with a continuous flight auger to increase the soil storage capacity of the auger.

Maintenance

The cutting edges must be kept sharp and the cutting angle must be correct (15°), so that the edges do not slide. As this is the bit that is used most frequently, it is advisable to have a spare in stock.

Conical auger bit

The blades of this auger bit are conically shaped, ending in a narrow cutting point with a width of 80 mm (Figure 161). The top diameter is one of two standard sizes: 180 or 230 mm.

Application

This bit is mainly used to break up stony layered soils. The sharp central blade can penetrate into such layers, where the cutting edges of the normal auger would slide. When the soil has been loosened, it can be removed with the normal auger. This bit is also used in combination with a flight auger for support in the borehole.

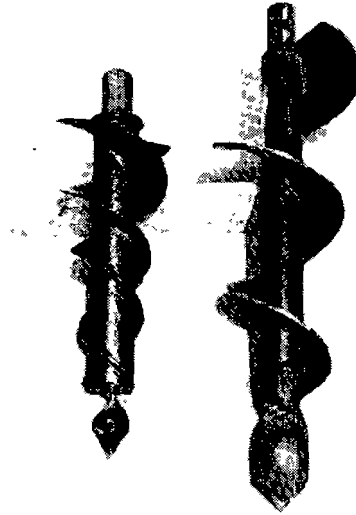

Fig 161. Conical auger bits

Continuous flight auger

The flight auger consists of a ϕ 2" pipe with a single blade welded around it in a spiral. The outer edge of the blade has a 6 to 8 cm welded lip (Figure 162). The top is fitted with a male connector and the bottom with a female connector. The total length of the auger is 1 m.

Application

The flight auger is only used in combination with a normal or conical auger bit. It increases the storage capacity, helps to keep the drill centered and reduces possible damage to the borehole. The flight should never be filled up by more than 0.5 m, otherwise the friction between the drilled-up soil and the borehole may become too high.

Note: Take care that the beginning of the flight auger blade lines up with the end of the blade of the normal or conical auger bit.

Riverside auger

The riverside auger is a 1 m long heavy steel tube with spoon shaped cutting blades welded at the bottom (Figure 163). The blades only cut on the outside so that soil which collects inside the tube is practically undisturbed. The tube is provided with an opening for easy removal of the soil. It can be opened and closed by means of a locking bar and handle.

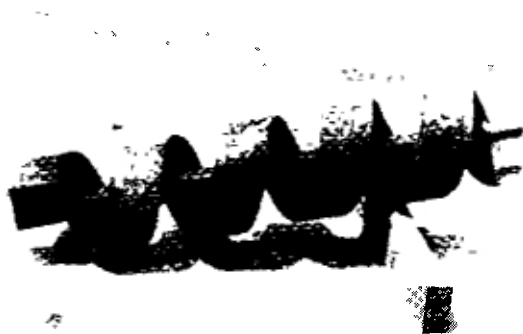

Fig. 162. A continuous flight auger which is to be connected to the normal or the conical auger bit.

Application

This bit is used successfully in semi-cemented layers such as laterite and calcrete, and in weathered bedrock, but can also be used in hard dry clay and in gravelly soils. The drilling speed however will be low in such hard soils

Maintenance

Although the cutting blades are made of tool steel, they quickly wear out when frequently used. The sharp teeth especially need regular checking.

Bailer

The bailer is a sharp-rimmed steel tube of 1 m length, provided with a hinged bottom valve (Figure 164). An eye is welded at the top to which the winch cable is attached with a D-shackle. The outside diameter of the bailer is



Fig. 163. A riverside auger with door and locking bar

180 mm which is small enough to prevent it from acting as a piston in the casing. Recently bailers of ϕ 130 mm have been introduced, because of stones getting stuck between the bailer and the ϕ 8" casing

Application

The bailer is used for the removal of wet sand or silt, i.e. below the water table. The process of bailing takes place inside a casing pipe to prevent caving of the borehole. When the bailer hits the sand, the valve opens and sand enters the tube. When lifted, the valve closes and the sand is trapped.

Maintenance

The cutting rim can easily be damaged when the bailer is used in sandy soils containing gravel. In such cases it must be sharpened in the workshop. The valve and the hinge must always be checked to ensure that they function properly and they should be cleaned regularly with water.



Fig. 164. A bailer hanging from the cable with a D-shackle

D.3 Extension rods

With increasing depth of the borehole, extension rods (Figure 165) have to be added to the drill bits. These rods - pipes of $2\frac{1}{2}$ " diameter - are available in lengths of 0.5, 1.0, 1.5, 2.0, and 3.0 m. They are provided with female and male hexagonal connectors, which are strong enough to withstand the torque created during drilling.

The drills are rotated with a crosspiece, a special rod of 0.8 m length, onto which 4 ϕ $2\frac{1}{2}$ " pipes of 1.25 m can be mounted. Each of these handles can be operated by two men.



Fig 165 Different types of extension rods. From left to right crosspiece, normal rod of 1 m and rod with disc

In order to keep the drill bits centered inside the casing, one of the extension rods of 1.0 m is provided with a disc of 180 or 230 mm diameter

A number of accessories (Figure 166) is required for connecting and disconnecting the extension rods

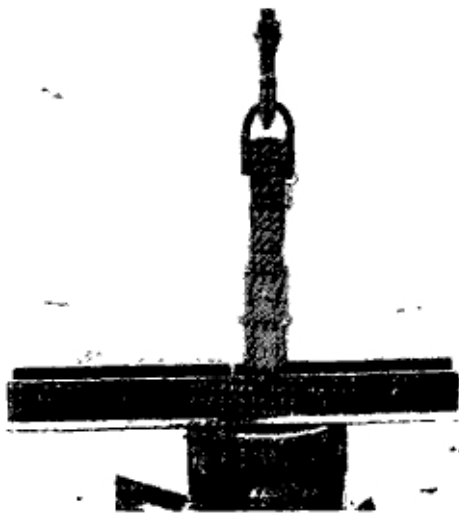

Fig 166 The drilling unit is hung from the hook by means of an extension hanger, locked by a bolt with R-spring. The ring on the extension rod will rest on the catcher when a new section is added



Fig. 167. Two slotted casings with shoe one with teeth, the other one tapered

- * The joints of all male and female connectors are fixed by means of an M16 × 80 bolt which is locked with an R-spring through a hole in the bolt.
- * The extension hanger is a female connector with a steel eye welded to the top. It is used to hang the drilling assembly from the hook of the hoisting system
- * The extension catcher prevents the drilling assembly from falling into the borehole while connecting and disconnecting the extension rods. It is made of two angular irons, welded at such a distance that the rods will slide through, but not the ring which is welded around near the top of the rods

D.4 Casings

The casing pipe is built up in sections, each 1.25 m long. The sections are made out of steel piping of 200/220 mm (8") or 250/275 mm (10") diameter. The casings are provided with clockwise or right hand thread - male at the top, female at the bottom.

Casing shoe

The first section to be inserted is fitted with a welded on casing shoe of 0.25 m in height (Figure 167). This shoe is either tapered or provided with teeth of manganese steel welded on the outside, the purpose of which is to ream the borehole in advance of the following sections, thereby reducing the friction between casing and soil. This section is also provided with slots which allow water to flow into the borehole when the bailer is pulled up.

Note. The large diameter casing section fitted with a casing shoe, which is used for telescopic drilling, is not provided with slots. Its purpose is to prevent water from an upper aquifer from entering the borehole during deeper drilling.

Accessories

During transport and when the casings are not in use, the threaded ends are protected by female and male protector rings. The female protectors are provided with two diametrically opposite holes through which a steel bar, the casing hanger bar, can be passed so that the casing can be hung on the hook (Figure 168).

When connecting and disconnecting the sections, a casing clamp will prevent the casing pipe from falling into the borehole. It consists of two flanged semi-circular clamps which are bolted together around the casing. The side of the clamp is provided with two welded eyes through which the 3 m long casing lowering pipe can be inserted. This is a $\phi 2''$ GS pipe with a $\phi 1\frac{1}{2}''$ pipe welded inside for extra strength. By means of this pipe the casing can be agitated and rotated clockwise during lowering and hoisting. The casing sections are tightened and loosened by means of chain spanners.



Fig 168 The casing hanging from the hook. Note that for this heavy job both pulley wheels of the upper block are used (compare with Figure 159).

For medium depth boreholes (> 10 m), the casing has to be lifted with two 10 ton jacks. Otherwise the tripod may be overloaded and serious accidents may happen as a result of a leg buckling or the cable breaking.

A casing retriever (diameter 180 or 225 mm) can be used if by accident a part of the casing has been disconnected below ground level. The procedure to be followed is similar to that of the PVC retriever (see Section 9.5).

Maintenance

The threads of the casing are very vulnerable. Carelessness during transport, loading and unloading, can cause damage to the threaded ends, which is virtually impossible to repair.

If in continuous use, the casing threads and protectors must be cleaned with diesel oil and very slightly greased every 2 to 3 weeks. The same applies to the casing clamp bolts.

The slots in the casing must be cleaned thoroughly with a hacksaw and water.

The manganese teeth or the tapered end of the casing shoe must be sharpened in the workshop when they become worn out.

Chain spanners should be lightly oiled from time to time.

Table D.1 Well construction equipment ^{a)}

Item	Size in mm	Recommended quantity
<i>1 Tripod and accessories</i>		
Tripod, complete		1
Foot plate	300 × 300	2
Foot plate	400 × 400	2
Pulley, double	ϕ 5"	1
Pulley, single with flap-door and hook	ϕ 5"	1
Winch, two-speed + handles		1
Cable	ϕ 10 × 30 m	1
Thimble for cable ϕ 10		1
Clamp for cable ϕ 10		2
D-shackle	1 3/4"	2
<i>2. Drill bits (clockwise)</i>		
a) For standard drilling with ϕ 8" casing		
Auger bit	ϕ 180 × 350	1
Auger bit	ϕ 230 × 350	2
Conical auger bit	ϕ 180 × 350	1
Flight auger	ϕ 180 × 1000	1
Flight auger	ϕ 230 × 1000	1
Riverside auger	ϕ 180 × 1000	1
Riverside auger	ϕ 230 × 1000	1
Bailer	ϕ 130 × 1000	1
b) Extra for telescopic drilling with ϕ 10" casing		
Auger bit	ϕ 300 × 350	1
Conical auger bit	ϕ 230 × 500	1
Flight auger	ϕ 300 × 1000	1
Riverside auger	ϕ 300 × 1000	1
Bailer	ϕ 180 × 1000	1
<i>3 Extension rods and accessories</i>		
Crosspiece	ϕ 65 × 800	1
Crosspiece handle	ϕ 65 × 1250	4
Extension rod	ϕ 65 × 500	1
Extension rod	ϕ 65 × 1000	2
Extension rod	ϕ 65 × 1500	4
Extension rod	ϕ 65 × 2000	2
Extension rod	ϕ 65 × 3000	2
Extension rod + disc ϕ 180	ϕ 65 × 1000	1
Extension hanger		2
Extension catcher		1
Bolt + chain + R-spring	M16 × 80	15
<i>4. Casing, all steel</i>		
a) For standard drilling		
Pipe plain + thread protectors	ϕ 200/220 × 1250	15
Pipe slotted with shoe	ϕ 200/220 × 1250	1
Casing hanger bar	ϕ 34 × 800	1
Casing clamp + lever	ϕ 220	2
Casing lowering pipe	ϕ 38/50 × 3000	2
Retriever for casing ϕ 200/220	ϕ 180	1
Chain spanner	2" - 12"	2
10 ton jack *		2

b) Extra for telescopic drilling

Pipe plain + thread protectors	∅ 250/275	5
Casing clamp + lever	∅ 275	2
Retriever for casing ∅ 250/275	∅ 220	1

5 Equipment for completion of the well

Membrane pump + handle		1
Hose	∅ 2½" × 20 m	1
Hose clamp	∅ 75	2
Spare membrane for pump		1
Water level meter	20 m	1
Sieve 1 0 mm + frame		2
Sieve 4 5 mm + frame		2
Surge plunger	∅ 103	1
Surge plunger	∅ 117	1
Clay rammer		1
Retriever for PVC ∅ 103/110	∅ 90	1
Retriever for PVC ∅ 117/125	∅ 110	1

6 Masonry tools *

Trowel		2
Float, wooden	2	
Spirit level	500	1
Mixing plate, steel or triplex	1500 × 3000	2
Mortar pan		4
Cold chisel		1
Sledge hammer		1
Shovel		3
Wheelbarrow		2

7 Pump installation/maintenance equipment

Pipe vice on installation jack *	½" - 2"	1
Open-ended spanner *	no. 17	2
Open-ended spanner *	no 19	2
Open-ended spanner *	no 24	2
Open-ended spanner *	no 30	2
Pumprod puller	∅ ½" × 200 (M16)	1
Pumprod puller	∅ ½" × 600 (M10)	2
Pumprod catcher		2
Pipe wrench *	24"	2
Steel brush *		1
File, half-round *		1
Keys for cylinders	2", 2½", 3", 4"	1

8 Additional tools

Auger cleaner		2
Hacksaw with blades *		1
Measuring tape *	3 m	2
Rope nylon *	20 m	1
Peg, steel or wooden *	300	10
Screwdriver *		1
Hoe *		2
Bucket *		2

a) All items available from Morogoro Wells construction Project, except those marked with asterisk [*]

One of the blades no.4 to be cut in 3 pieces .

1/2 rev. for 2 cutting edge

2 x 1/4 rev. for reinforcement of both cutting edges

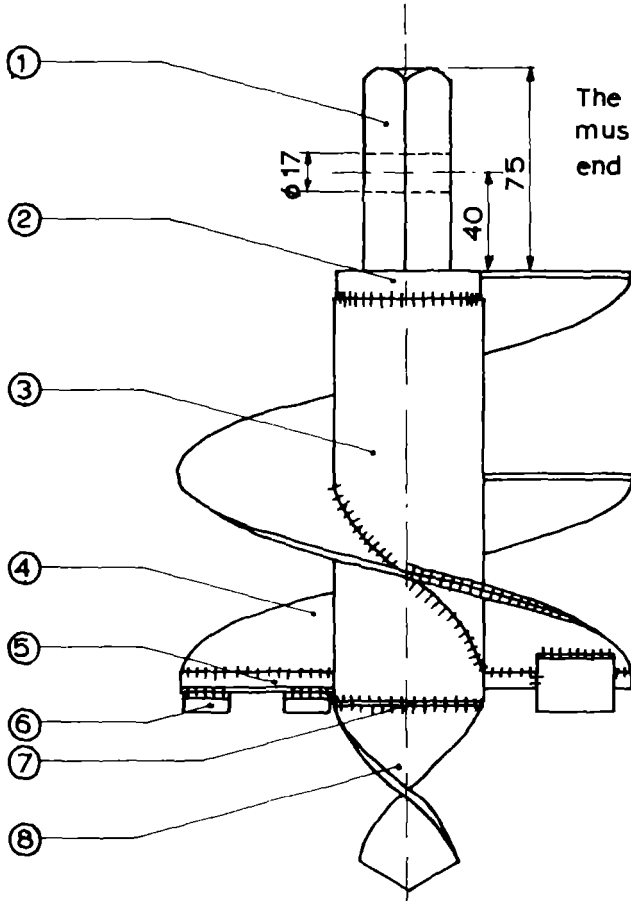

	a
φ 300	265
φ 230	210
φ 180	180

8	1	flatbar	toolsteel	60 x 6 x 80
7	1	plate	steel	φ 61 x 5
6	3	knife	toolsteel	
5	2	flatbar for knives	toolsteel	
4	2	blade for flight auger	steel	
3	1	pipe	steel	2" x a (table)
2	1	plate	toolsteel	φ 61 x 10
1	1	hexagonal bar	steel	38 x 100
NO	QUAN	NAME	MATERIAL	DIMENSIONS
		AUGERBIT φ 180, 230, 300		HDD 12

Fig. 169. Workshop drawing of auger bits

Appendix E

Topographical Maps

A topographical map is a representation of the surface of the terrain on a reduced scale, on which recognizable points and objects as well as the shape of the terrain are indicated. Thus, contours, roads, tracks, rivers, villages, land-use, vegetation and many other features are marked. Topographical maps at the scale of 1 : 50,000 are essential for a proper groundwater survey and they are indispensable in the field.

The topographical maps of Tanzania are published by the Surveys and Mapping Division of the Ministry of Lands, Housing and Urban Development¹⁾. It has issued a catalogue which describes all the available maps, including not only the 1 : 50,000 maps, but also smaller scale maps, regional, district, township and urban maps. Maps are for sale in the main office in Dar es Salaam and in several regional offices.

E.1 Preparation of the maps

The basic topographical maps at the scale of 1 : 50,000 are compiled from aerial photographs. A part of such a map is shown in Figure 173. The photographs are taken from an aeroplane flying in straight lines and at a fixed height over the terrain. They are taken a very short time intervals so that they overlap each other. The centres of the successive photographs are printed on the map as crosses with a number referring to the flight details (circled in Figure 173). In Tanzania, a print of each photograph is filed in the Air Photo Library in Dar es Salaam.

By means of a *stereoscope* a three-dimensional picture is obtained of every two overlapping photographs. Contour lines (see Section D 3) are then measured from these pictures and plotted on the map. The maps are completed with additional data from field surveys.

At present, approximately $\frac{3}{4}$ of the country is covered by 1 : 50,000 map sheets, though they are of varying quality. Each sheet covers an area of approximately 30 × 30 km and has its own number, e.g. 181/4 in Figure 173. Adjoining sheets are indicated in a diagram on the map (Figure 170).

Each map sheet is also provided with a *sheet history* (Figure 171), which gives a summary of how, when and by which institutions the map has been prepared. A small

INDEX TO ADJOINING SHEETS

181/1 KIDETE	181/2 MUNISAGARA	182/1
181/3 LUMUMA	181/4 KILOSA	182/3
199/1 LEDINGOMBE	199/2 ULAYA	200/1

Fig 170 Diagram showing the numbers of adjoining map sheets.

diagram beside the map (Figure 174) indicates when the air photography of different parts of the map took place. This is important information since it determines the reliability of the map, some of the older maps are based on photographs taken in 1947¹⁾. Existing roads may have been re-routed and new ones constructed and the location of settlements has changed drastically since the villagization

¹⁾ Ministry of Lands, Housing and Urban Development, Surveys and Mapping Division
P O Box 9201, Dar es Salaam

SHEET HISTORY

Second Edition prepared by the British Government's Ministry of Overseas Development (Directorate of Overseas Surveys) under the Special Commonwealth African Assistance Plan, 1966 (D O S 422)
First Edition constructed, drawn and photographed by Directorate of Overseas Surveys 1960, (D O S 422)
Field Survey Data supplied by Ministry of Lands and Surveys and D O S
Air Photography by R A F, May-June 1950, August 1952 and Ministry of Lands and Surveys, August 1955
Second Edition reconstructed, drawn and photographed by D O S 1966, (D O S 422)
Air Photography by Air Survey Division, Tanganyika, June 1963 and June and October 1964
Contoured by D O S from control supplied by D O S
Additional information supplied by Ministry of Lands, Settlement and Water Development, Tanganyika 1964

Fig 171 The sheet history of a topographical map

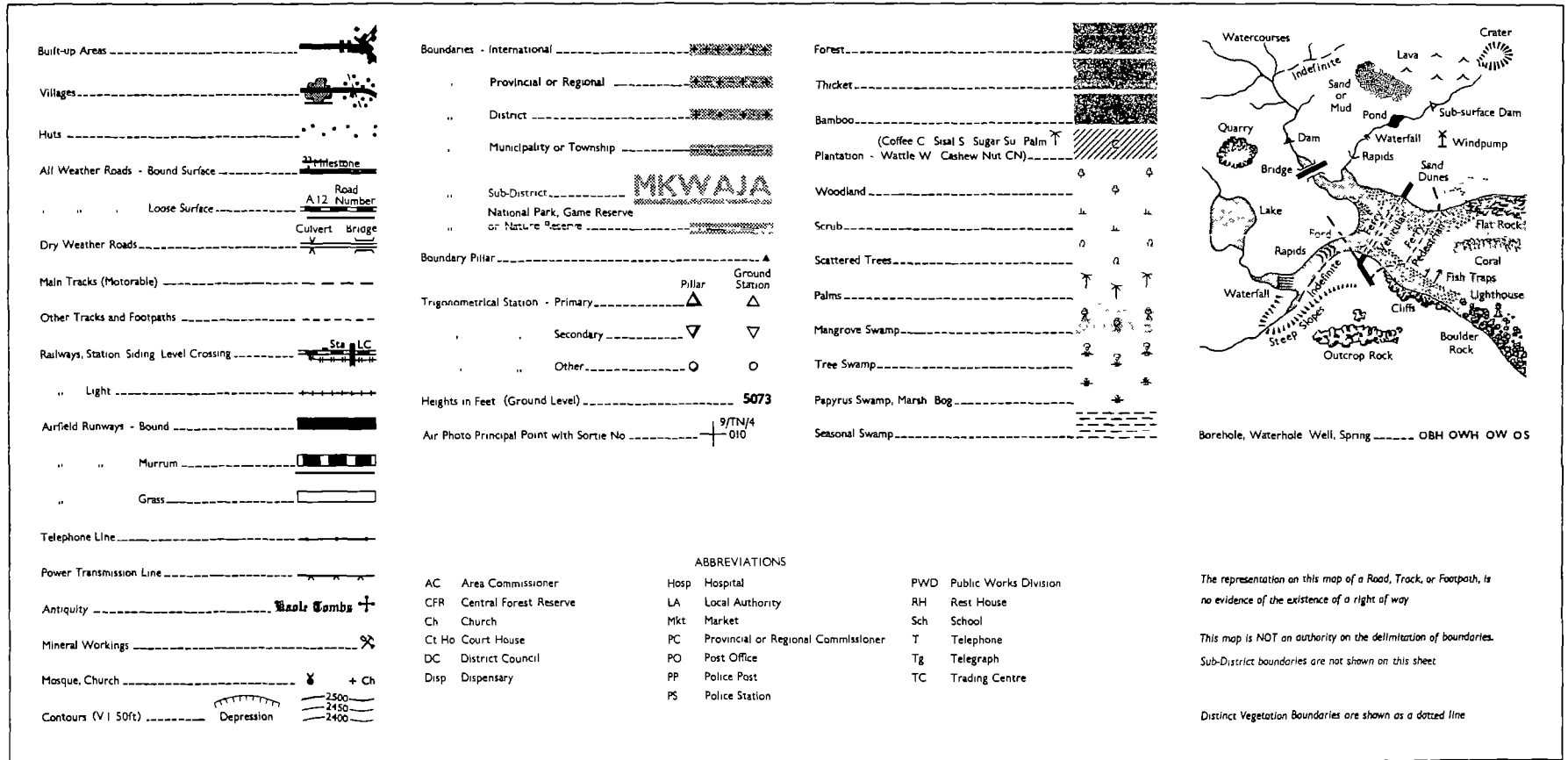

Fig. 172 The legend to a topographical map

Sheet 181/4

Refer to this map as -	Series Sheet Edition	Y742 181/4 2-D.O.S.
------------------------------	----------------------------	---------------------------

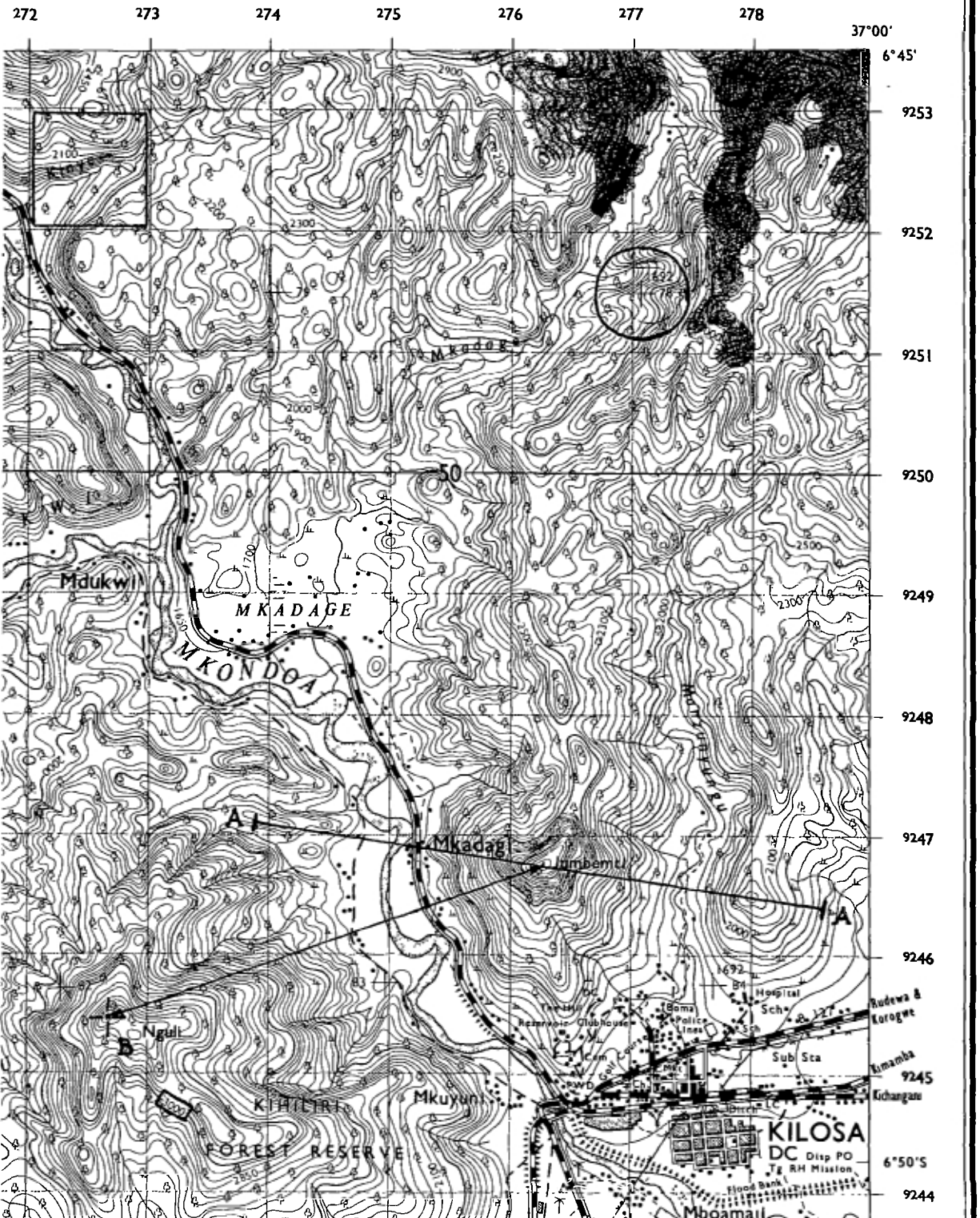

Fig 173 A part of topographical map sheet no 181/4

operation started in the early 1970s. Some caution should therefore be exercised when consulting these maps. However, most other features of importance for the siting of wells (landscape, rivers, etc.) scarcely change at all in such a relatively short time.

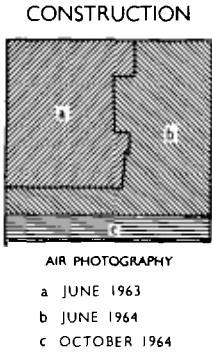

Fig 174. Diagram showing the dates of air photography for different parts of the map

E.2 Scales

The concept of *scale* can best be illustrated by a simple example. The map of the entire continent (Figure 175a) fits on the same piece of paper as the map of Tanzania (Figure 175b) since they were drawn to different scales. The map of Africa has been drawn to a smaller scale than the one of Tanzania.

The scale of a map is the ratio of the distance between two points on the map and the corresponding points in the field. It is used to convert distances on the map to distances

in the field and vice versa. Map scales can be expressed in different ways.

- as a statement, e.g. one centimetre to one kilometre;
- as a drawn linear scale,
- as a ratio, e.g. 1 : 25,000

The latter two notations are most commonly used. The topographical maps discussed in this appendix have a scale of 1 : 50,000, i.e. one unit of length on the map corresponds to 50,000 of the same units in the terrain.

Example 1: What is the actual distance in kilometres between the tops of the Nguli and Jumbemti hills in Figure 173?

The distance on the map (measured with a ruler) is 7.7 cm. The scale is 1 : 50,000 and therefore the actual distance is $50,000 \times 7.7 = 385,000 \text{ cm} = 3,850 \text{ m} = 3.85 \text{ km}$

Example 2: The trip-counter of a car indicates 8.4 km for a certain distance in the field. How many cm on the map does this correspond to?

First the kilometres have to be converted to centimetres. $8.4 \text{ km} = 8,400 \text{ m} = 840,000 \text{ cm}$. The distance on the map is thus $840,000 / 50,000 = 16.8 \text{ cm}$

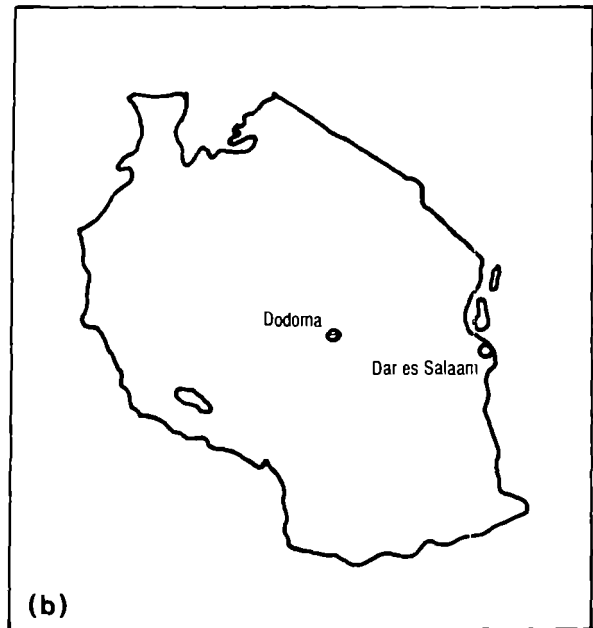
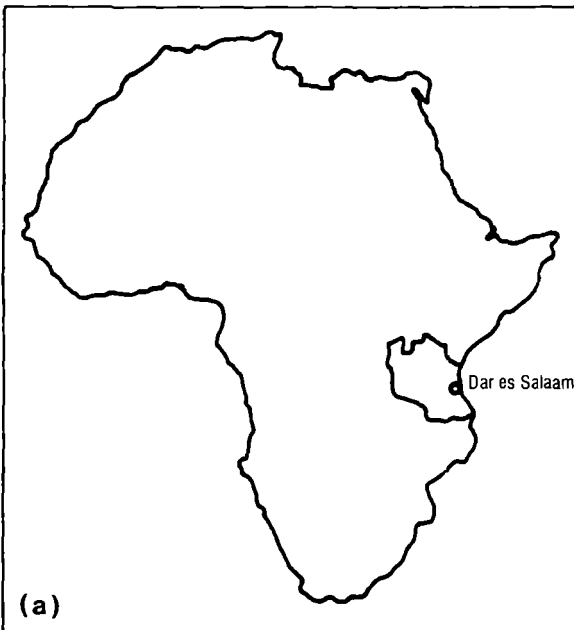

Fig. 175. The map of Africa (a) is drawn to a smaller scale than the map of Tanzania (b).

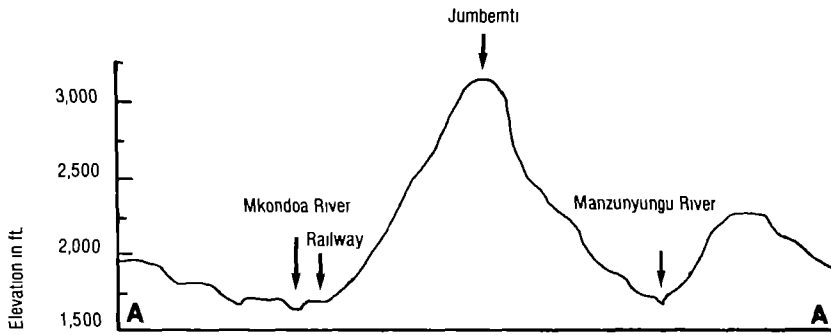

Fig 176 Section A-A from the map in Figure 173

E.3 Legend

Every map sheet is provided with a *legend* (Figure 172), which explains the meaning of the different symbols used on the map. Most of these symbols are self-explanatory: settlements, prominent buildings, railways, roads, tracks, boundaries, vegetation, surface water, etc. Only the brown-coloured *contours* require some further explanation.

A contour is a continuous line which connects points at the same altitude. They are imaginary lines (not visible in the field) and enable the reader of the map to get a better understanding of the relief of the terrain: the height of the hills or mountains, the depth of the valleys, the steepness of the slopes. Contours are drawn on the map at altitude intervals of either 20 m or 50 ft, depending on the year of the preparation of the map. In the example in Figure 173, the interval is 50 ft. These contours are fine and coloured brown and the lines at 500 ft intervals are drawn slightly thicker. The figures (also in brown) indicate the absolute altitude above Mean Sea Level. They are written "slope upward" contours above the figures have a greater altitude.

Example 3: What is the altitude of point B in the bottom left-hand corner of Figure 173?

The nearest contour with an indicated height is the 3,000 ft contour. From the way this figure is written, we can tell that point B must be higher than 3,000 ft. Between this contour and point B there are 8 more lines, each representing a 50 ft difference in altitude. Therefore the altitude of point B is $3,000 + (8 \times 50) = 3,400$ ft.

E.4 Sections

A section is an imaginary vertical cut along a line drawn on the map. Usually the horizontal scale of a section is the same as the scale of the map. The vertical scale, however, is generally exaggerated, e.g. 5 or 10 times, in order to present the topography more clearly. An example is given in Figure 176. It shows a section along the line marked A-A in Figure 173. Certain features have been clearly indicated. The left-hand side of a section always represents the west (or south-west, or north-west) and the

right-hand side the east.

A section is prepared as follows (Figure 177). Firstly, the distances between the points where the contour lines and the section line on the map intersect are transferred to the base line of the section. For this base line, any altitude can be chosen. Then the altitudes corresponding to the successive contours are plotted on a suitable scale and a line is drawn connecting these points.

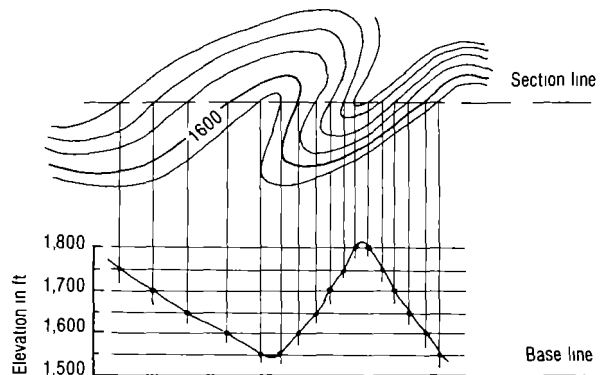

Fig 177. How a section is drawn.

E.5 Indicators of groundwater

Topographical maps at 1:50,000 can be of great help to the surveyor during his initial search for suitable test drilling sites. Quite a lot of information on the likely presence or absence of shallow groundwater can be derived from these maps. Some examples are given below.

- * Boreholes, water holes, wells and springs are direct indications of groundwater. They are indicated on the map by means of a small blue circle, followed by BH, WH, W and S respectively.
- * Certain types of vegetation, such as papyrus and mangrove, which only grow where the groundwater level is close to the surface, are indicated on the map. The same applies to a cash crop like sugar cane.

- * Swamps and marshes generally indicate a direct connection to shallow groundwater.
- * Rivers and streams, marked as blue lines on the map, do not directly indicate groundwater, but they always flow in the lowest parts of the terrain, where groundwater is likely to be closest to the surface
- * Of particular importance are the width and gradient of river valleys, features which can be derived from the contour lines. In wide valleys with small gradients, river sediments and possibly good aquifers are more likely to occur than in narrow, steep valleys. Compare, for example, the valleys of Mkondoa and Manzunyungu rivers in Figures 173 and 176
- * Probable locations of alluvial fans, often containing suitable aquifers, can easily be determined from the configuration of the contours, see for example the outlined square in the top left-hand corner of Figure 173

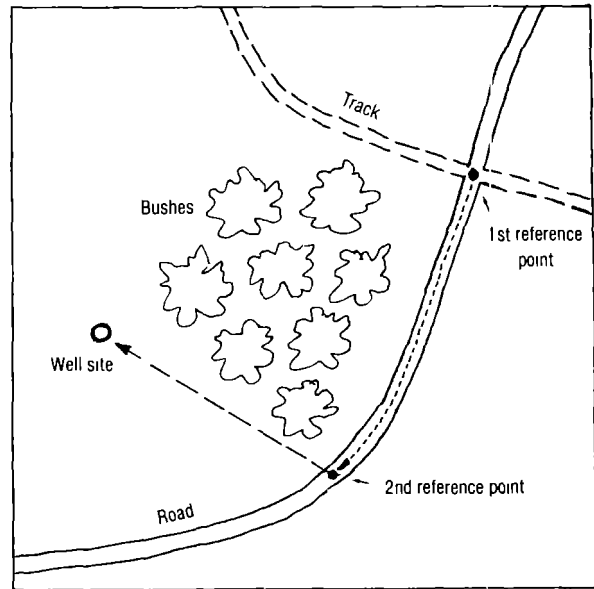

Fig 179 Sometimes a second reference point is required for plotting a well site on the map

E.6 Plotting field points on the map

After the surveyor has completed his work in a village, he should plot certain field points, usually well sites and the extent of villages, on the topographical map. A simple method is described below and is illustrated in Figure 179

1. Orientate the map by means of a compass. The vertical lines on the map (directed north-south) should be parallel to the needle of the compass, which always points north (Figure 178)

Note: Make sure there are no metal objects nearby which may upset the needle
2. Find a nearby reference point in the field and locate the corresponding point on the map (or vice versa). Good reference points are road crossings, sharp bends in roads, power lines, prominent buildings, etc

3. If the field point that is to be plotted, e.g. a well site, cannot be seen from the reference point, choose a second reference point which is closer to the field point and from where it can be seen. Measure the distance in paces of 1 m between the first and second reference points (for longer distances the trip-counter of a car can be used). Convert the distance in the field to that on the map and plot the second reference point
4. Re-orientate the map, as described in Step 1, and determine the direction of the field point from the new reference point. Draw a line on the map in the same direction
5. Measure the distance from reference point to field point, convert it to scale and plot the point on the map

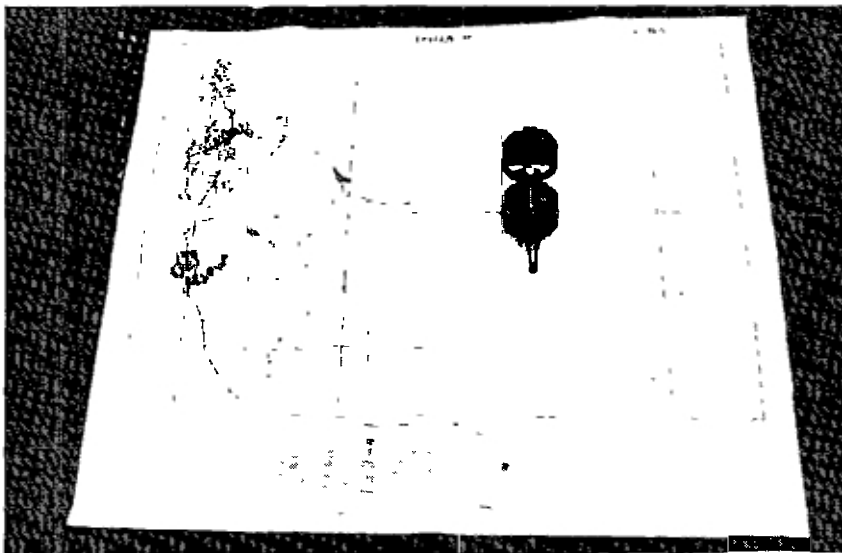

Fig 178 Orientation of the map by means of a compass.

E.7 Coordinates

A literal description such as: "The site is located 160 m east of the market, close to the house of the chairman, etc", is not very accurate and also not very reliable. The chairman may move to another house, and even the entire village may be moved one day. Such a description only causes confusion and makes retracing of the location in the field complicated. Therefore a system based on measurements on the map and describing the position of a point in a more mathematical way is used. For this purpose the *grid reference system* is the most convenient.

Most topographical maps at 1:50,000 are provided with a printed network or *grid* of horizontal and vertical lines. These lines are drawn at distances of 2 cm (Figure 173), representing exactly 1 km in the field. All the lines have their own number indicated in the margin of the map. All vertical lines are numbered from west to east, they are called *eastings*. All horizontal lines are numbered from south to north and are called *northings*.

Note: The grid also allows a quick approximation of distances in the field. Just by counting the squares, the distance in km can be obtained.

Each point on the map can now be described by its *coordinates*—a unique cipher-code based on the numbers of the grid lines. A step-by-step method of determining the coordinates of a point is given below.

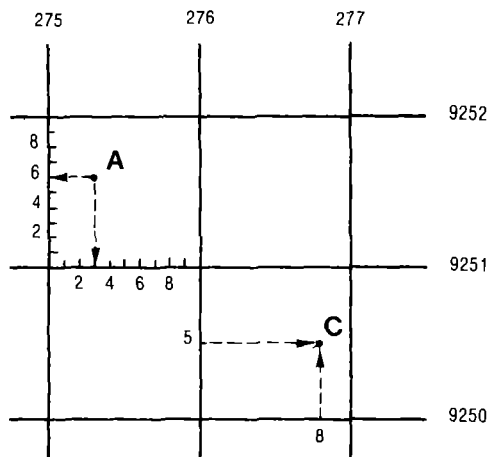

Fig. 180 How to determine the coordinates of a point

To determine the coordinates of point A (Figure 180)

- 1 Use the bottom left-hand corner of the square in which point A lies, as a reference point.
- 2 The numbers of the grid lines intersecting at this point are the basic coordinates. First comes the easting, then the northing: 275/9251
- 3 Divide the sides of the square into 10 equal parts of 2 mm

- 4 Draw from point A a vertical and a horizontal line, which intersect the subdivided grid lines.
- 5 Read the number of tenths, first eastwards, then northwards.
- 6 The coordinates of point A are the basic coordinates, followed by the tenths behind the decimal point: 275 3/9251.5

Example 4: The coordinates of the top of Nguli hill (point B in Figure 173) are 272 7/9245 5. Check this!

It will be clear that this method can also be used to work out the location of a particular point and to plot it on the map, if the coordinates of the point are given.

Example 5: Plot the location of point C which has the following coordinates 276 8/9250 5 (Figure 180). This is done as follows:

- 1 Find the intersection of the 276 easting and the 9250 northing.
- 2 Measure from this point $8 \times 2 = 16$ mm in an easterly direction and draw a vertical line.
- 3 Measure $5 \times 2 = 10$ mm in a northerly direction and draw a horizontal line.
- 4 Point C is located at the intersection of these lines.

E.8 The need for situation sketchmaps

The maximum accuracy with which a point can be described in this system of coordinates, is 2 mm on the map. This corresponds to $2 \times 50,000 = 100,000$ mm or 100 m in the field. It will be clear that an individual test borehole (diameter 0.1 m) can never be plotted accurately on the topographical map since the scale of the map is just too small for this purpose. With no further indications it would also be very difficult to find again an approved borehole in the field just by reading the map because an area of 100×100 m would have to be searched. Therefore only well sites, which usually include a number of boreholes, are indicated on the topographical map, and detailed situation sketches of every site are required to indicate the exact location of the individual boreholes.

Appendix F

Checklist for Pump Maintenance

For lever-type pumps

Symptom	Possible cause	Action
1 Normal pumping action, but no water flows on the first few strokes	Rising main leaking Foot valve leaking Piston rubber worn out	Check rising main connections and check for possible holes, replace if broken Check and clean cylinder ¹⁾ , replace if not repairable
2 Normal pumping action, but reduced yield.	See 1	See 1
– If combined with large drawdown	Screen clogged	Use surge plunger to develop the well
– If combined with low water level	Aquifer over-exploited	Accept lower yield until recharge takes place
3 Very easy pumping action and no water	Pumprod loose or broken	Tighten connectors if loose, replace if broken
4 Heavy pumping action	Bearing worn out Piston stuck in cylinder Mud or sand in cylinder	Check bearing and replace if necessary Check piston rubber and replace if necessary. Check cylinder and continue at 5 or 6
– If only on the up-stroke, and combined with low water level.	Cylinder size too big	Try smaller size cylinder
5 Fine sand or silt in the pumped water	Gravel pack not properly installed	Measure well depth and compare with original depth Clean well with membrane pump
6 Gravel in the pumped water	Screen damaged	See 5 If gravel continues to appear, either repair by installing a smaller diameter filter pipe or abandon the well

¹⁾ Where there are problems with the cylinder either with the valves or the piston, always check on the spot what the reason for the malfunction is. It may be that sand or gravel has collected in the well without showing in the pumped water

Additional for Kangaroo pumps

Symptom	Possible cause	Action
1. Pump head does not return to original position	Spring broken or worn out	Install another pump and have spring replaced in workshop
2. Pump head does not return fully	Cylinder size too big	Try smaller size cylinder.
3. Heavy pumping action	Dirt collected on spring See also 4. above	Clean and grease the spring See 4. above.
– If combined with scraping noise	Dirt collected on inner square pipe Pump not vertical	Clean the pipe and grease it lightly. Adjust well cover

Each time the cylinder has to be removed from the well, the installation procedure as described in Section 11.3 is followed in reverse order. Make sure that during re-installation the PE protecting hose is slid down and that new teflon tape is put on the threads of the rising main.

Each time the pump is removed from the concrete cover, the "compriband" gasket should be renewed, and the anchor bolts greased. Renewal of the gasket is not necessary if a rubber plate is used as with the NIRA pumps.

Appendix G

Disinfection of a Well

Although tube wells by their siting and design are less liable to bacterial contamination, it can always happen that through some unforeseen cause a well becomes polluted. This is easily recognized, if *E. coli* bacteria are detected in a bacteriological water quality check.

The water in the well should then be disinfected or sterilized by applying a bactericide like chlorine. The procedure below is recommended.

1. Pump 2 buckets of water
2. Add 1 litre of household bleach such as "Clorite" to each bucket (Figure 181), mix thoroughly
3. Remove the anchor nuts and raise the pump on blocks or on an installation jack
4. Pour the content of the buckets into the well by means of a hose about 10 m long and a funnel, leave about 2 litres in the bucket.
5. Remove the hose and funnel
6. Attach a short hose about 2 to 3 m long to the pump spout and run the other end into the well (Figure 182).
7. Let the water and chlorine circulate by pumping slowly for about 10 minutes. Then remove the short hose.
8. Wash the top of the concrete cover and the foot plate of the pump, both top and bottom, with the remaining 2 litres of chlorine solution.
9. Put a new gasket around the anchor bolts and re-install the pump on the concrete cover.
10. Block the pump so that it cannot be operated, explain this to the well caretaker and let him inform the villagers.
11. Allow the chlorine to remain in the well for a period of at least 12 hours.

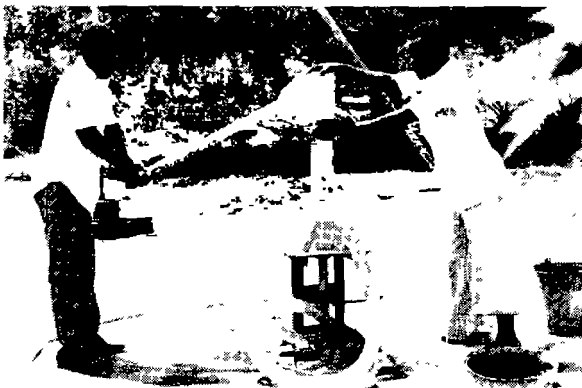

Fig. 182 For the disinfection of a well the pumped water is recirculated into the well

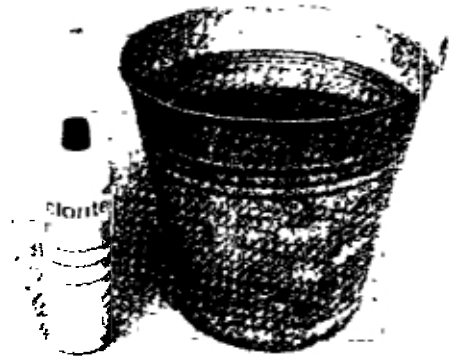

Fig. 181 One litre of bleach per bucket of water

12. Pump water until the odour of chlorine can no longer be detected.
13. Take a water sample 1 to 3 days after disinfection for a bacteriological test ¹⁾
14. Repeat this sampling and testing after 3 months.

Remember however that disinfection of a well fights the symptoms, rather than the cause of the pollution. Therefore, always try to find out what exactly caused the contamination.

The most common causes and their remedies are as follows:

- * A latrine has been located too close to the well. The groundwater flowing towards the well may have become contaminated by faecal bacteria.
Remedy: have the latrine filled in and dug somewhere else at least 50 m from the well.
- * Cattle have been allowed to come too close to the well. Their excreta may have polluted the groundwater.
Remedy: have a fence of thornbushes, for example, built around the well and make sure that watering of cattle takes place away from the well.
- * The gasket is leaking or absent. Dirty water can then splash back into the well in between the concrete cover and the foot plate of the pump.
Remedy: check if the foot plate and cover are still flat and install a new seal.

¹⁾ The sample should be taken in a wide-necked sterilized glass bottle. If analysis is done in the laboratory, the sample should be transported within a period of 2 hours, or within 6 to 7 hours in the case of transport in a cooler. For this reason, the use of a portable *E. coli* test kit such as a "Millipore" kit, is strongly recommended.

CHUD CHA MAJI - DAR ES SALAAM

Village Sketch - Survey Section

Date	22-6-83
Surveyor	JOHN SAMBU

Village **CHAMAZI**
 Ward **MSUFINI**
 Division **NBAGALA**
 District **TENEKE**

Appr number of people	nr 3070
Planning/Review of sites	nr

Approved well sites	186/3 - 11, 15, 20, 21, 24	Disapproved well sites	186/3- 10, 12, 13, 14, 16, 17, 18, 19, 22, 23
---------------------	----------------------------	------------------------	---

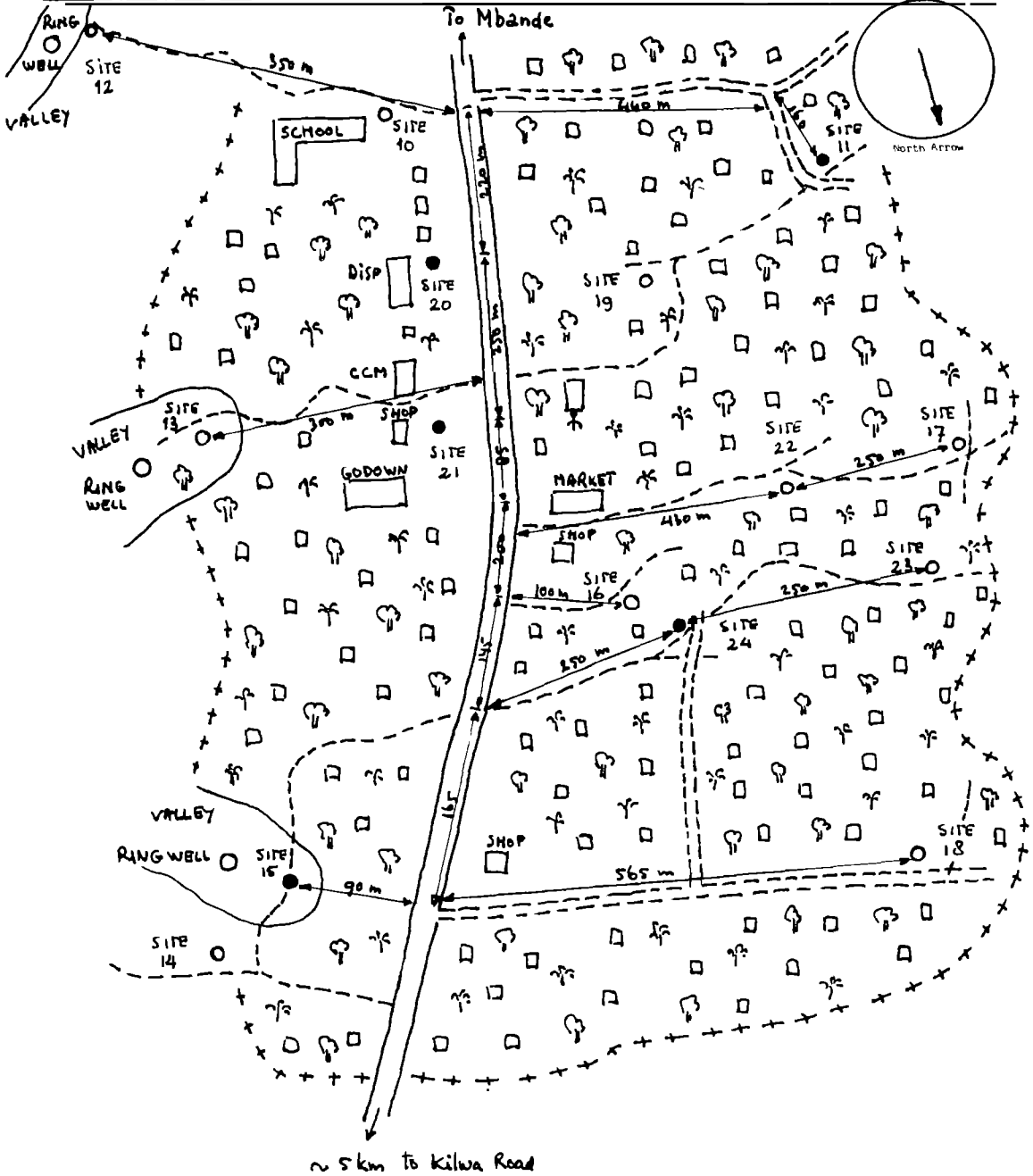

Mark subvillages, important buildings, main roads with destination, approved sites, disapproved sites

For legend see situation sketch forms

CHUO CHA MAJI - DAR ES SALAAM

Situation Sketch - Survey Section

Date	20-6-83
Surveyor	J. SAMBU

Village CHAMAZI
 Ward MSUFINI
 Division MBAGALA
 District TEMEKE
 Co-ordinates S25.1 - 9232.0

Site number(s)	186/3-20
Number(s) of approved Borehole(s)	1

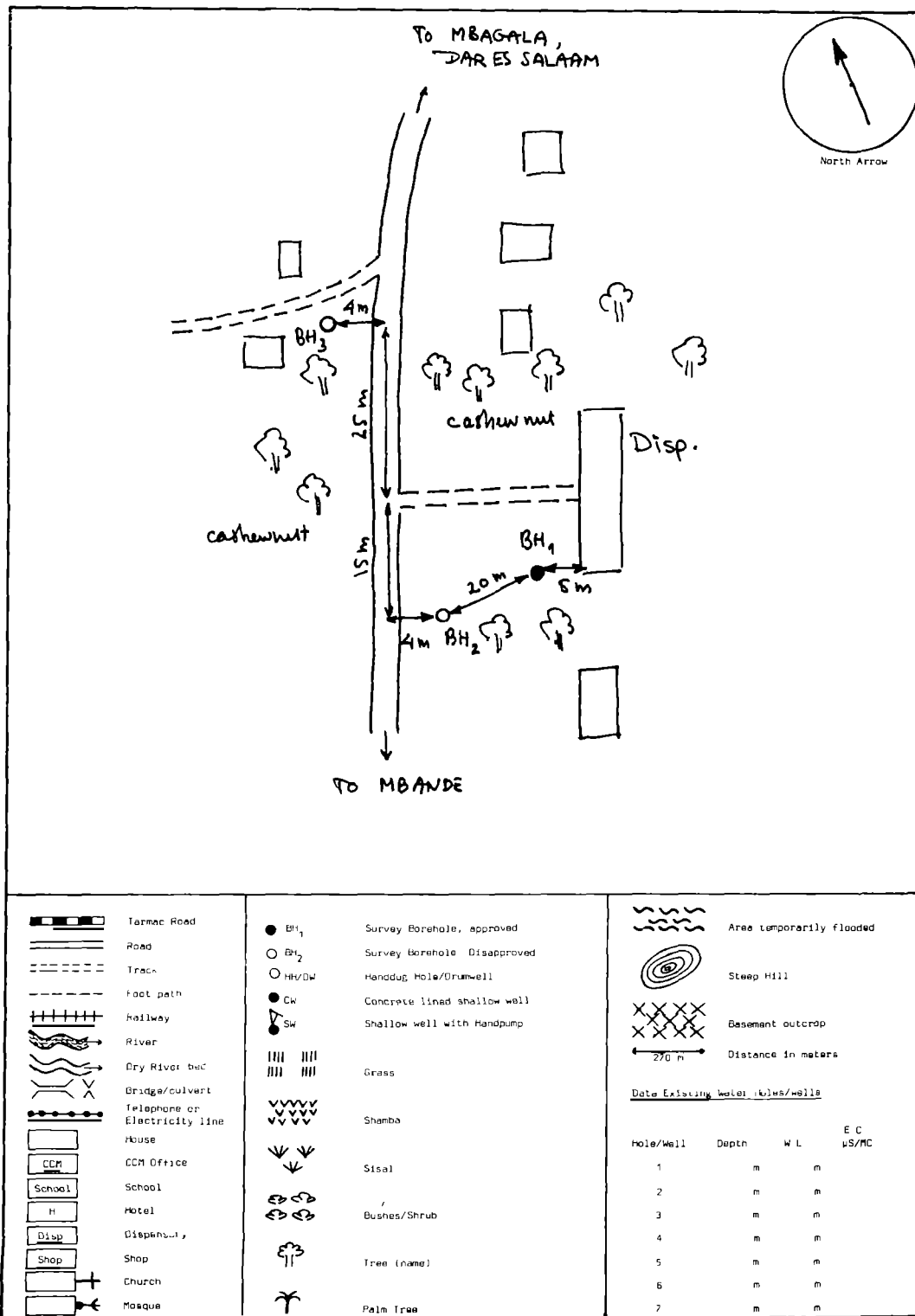

CHUO CHA MAJI - DAR ES SALAAM

Borehole Description - Survey Section

Date	15-6-83	
Drill Equip	LSD	HSD
Surveyor	J. SAMBU	

Village CHAMAZI
 Ward MSUPINI
 Division MBAGALA
 District TEMEKE
 Co-ordinates S25.1 - 9232.0

Borehole number	186/3-20-1
Disapproved	Approved
Checked by	

Depth m-GL	Major Parts		Minor Parts		Consistency	Colour	Wat cont				EC µS/cm	Kind of auger	Profile m-GL	
	lithology	gradation	lithology	gradation			dr	m	w	wb				
0.00-0.40	sd	fn	li silt		ls	blk	x						cl	0
0.40-2.20	sd	fn	silt		ls	l-br	x						"	2
2.20-2.40	sd	fn	silt		sft	L-br		x					"	4
2.40-2.80	silt		sd	fn	sft	L-br			x	640			"	6
2.80-4.40	silt		sd	fn	sft	br/gy		x					"	8
4.40-5.40	sd	fn	li cl		ls stlk	gy	x						vi	10
5.40-5.60	cl		sd	fn	ls stlk	gy/red	x						"	12
5.60-7.30	cl		-		stlk	red/gy	x						"	14
7.30-8.30	sd	fn	li cl		ls stlk	gy/red	x						"	16
8.30-8.50	sd	fn	-		ls	wh		x					"	18
8.50-8.80	sd	fn	li cl		ls	wh/gy			x	340			ba	20
8.80-9.00	sd	fn	li cl, gr		sft	gy		x					"	22
9.00-10.00	sd	cs	li cl, gr		ls	wh/gy			x	340			"	24
10.00-10.30	sd	cs	li cl, gr		ls	red/gy		x					"	26
10.30-11.00	sd	fn	cl		ls stlk	red	x						cl	28

INDEX		
Lithology	Gradation	Colour
clay = cl	fine = fn	black = blk
silt = silt	medium = me	brown = br
sand = sd	coarse = cs	gray = gy
gravel = gr		blue = bl
stones = st	soft = sft	green = ga
sandstone = sd.st	sticky = stk	yellow = ye
laterite = lat	loose = ls	white = wh
calcrete = cal	weathered = wed	red = red
mica = mi	hard = hd	orange = og
basement = bn		dark = d-
very = ve	Kind of auger	light = l-
much = mu	clay = cl	mottled = mot
little = li	riverside = rf	
layers = lay	bailey = ba	

Total drilling depth 11.0 m-GL
 Aquifer(s) depth(s) 2.4 - 2.8 m-GL
 8.5 - 8.8 m-GL
 9.0 - 10.0 m-GL
 Water level 8.0 m-GL
 Tested yield 1037 l/h
 Max draw-down 1.0 m
 EC at T₀ 340 µS/cm
 EC at T₆₀ 300 µS/cm
 Screen depth 8.0-11.0 m-GL
 Pump intake depth 10.2 m-GL

water bearing water level Ground level = GL
 liters/hour = l/h

Remarks

RECOMMENDATIONS FOR CONSTRUCTION

Total Well Depth 10.50 m-GL
 Depth(s) of Screen(s) 7.50 - 10.50 m-GL

Watersample 108 no

Pump Test

Borehole number **106/3-20-1**
 Date **15-6-83**

Water level **8.0** m-GL
 Screen depth **8.0 - 11.0** m-GL
 Pump intake depth **10.2** m-GL
 Content 1 bucket **17** liter

Before starting the pump test, slowly pump 2-5 buckets to develop the borehole!

Time minutes	Number of buckets	Water level m-GL	EC $\mu\text{S/cm}$
T ₀	X	8.0	340
T ₁₀	10	8.70	300
T ₂₀	12	8.90	300
T ₃₀	10	9.00	280
T ₄₀	10	8.85	300
T ₅₀	9	8.90	300
T ₆₀	10	8.80	300

If pump test fails, give the reasons!

.....

Yield = **61** x **17** liter (content of 1 bucket) = **1037** liter/hour

Number of buckets	T ₁₀	T ₂₀	T ₃₀	T ₄₀	T ₅₀	T ₆₀
1	X	X	X	X	X	X
2	X	X	X	X	X	X
3	X	X	X	X	X	X
4	X	X	X	X	X	X
5	X	X	X	X	X	X
6	X	X	X	X	X	X
7	X	X	X	X	X	X
8	X	X	X	X	X	X
9	X	X	X	X	X	X
10	X	X	X	X		X
11		X				
12		X				
13						
14						
15						
16						
17						
18						
19						
20						

Physical Quality of Groundwater		
odour	good	bad
Taste	good	bad
Colour (t60)	none	
Colour (t65)	none	

Recovery Test

Time minutes	Water level m-GL
T ₆₁	8.65
T ₆₂	8.50
T ₆₃	8.40
T ₆₄	8.30
T ₆₅	8.25

2 P.V.C. Installed

Diameter	103 / 110 mm
Slet size	0.7 mm
Screen	1 x 3 00 m + - m
Casing	2 x 3 00 m + 1.95 m
Sockets	-
Cover	WOODEN (1)

3 Sketch P.V.C

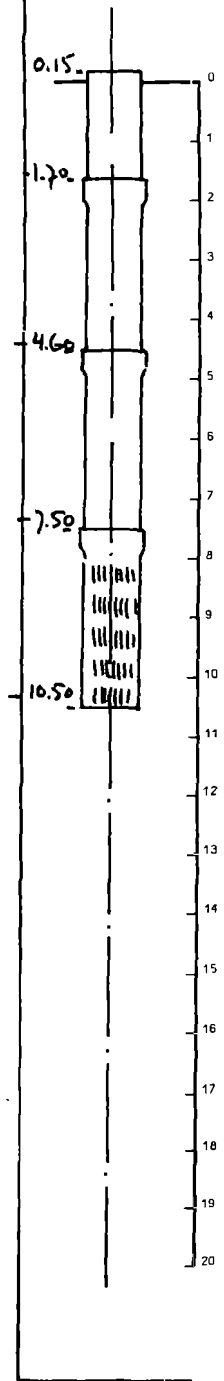

4 Gravelpack

Size	- mm
Kerel	11 (110 litres)
Depth	From 10.50 to 7.30 m-GL

5 Pumptest

time minutes	Water level m-GL	Drawdown m	Number of buckets
T ₀	8.40		
T ₅	8.55	0.45	5
T ₁₀	8.80	0.70	7
T ₁₅	8.70	0.60	6
T ₂₀	8.85	0.75	6
T ₂₅	8.75	0.65	5
T ₃₀	8.80	0.70	7

6 Recovery test

Time minutes	Water level m-GL
T ₃₁	8.60
T ₃₂	8.45
T ₃₃	8.35
T ₃₄	8.50
T ₃₅	8.25

Content of 1 bucket in litres:

36	+
17	x
612	
	² x
1224	

Yield in L/hr

Type of pump **SWN 80**

If pump test fails, give the reasons

8. Slab construction

Material	Unit	Number
Cement	bog	9
Sand	m ³	0.7
Stones	m ³	0.7
Cement block	-	20

7 Pump installation

Date	Pump type	Cylinder		Rising main							Socket	
		Diam	Type	4 00	3 50	3 00	2.50	2 00	1 50	1 00		0 75
1-3-84	SWN 80	2 1/2"	PVC	2					1			2
Pump attendants												

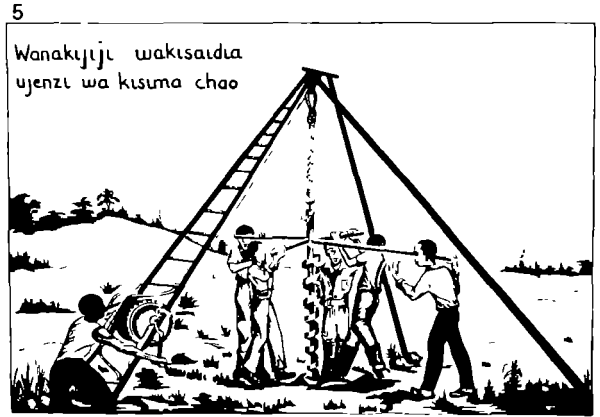
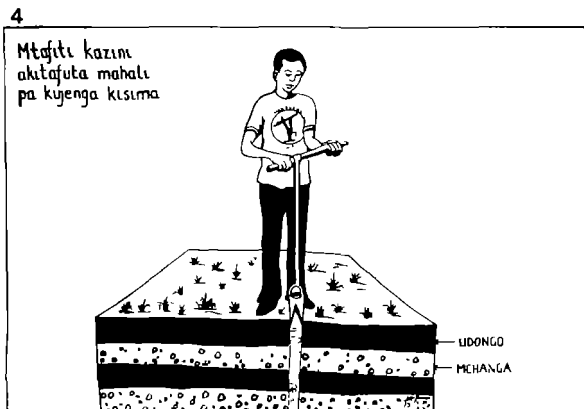
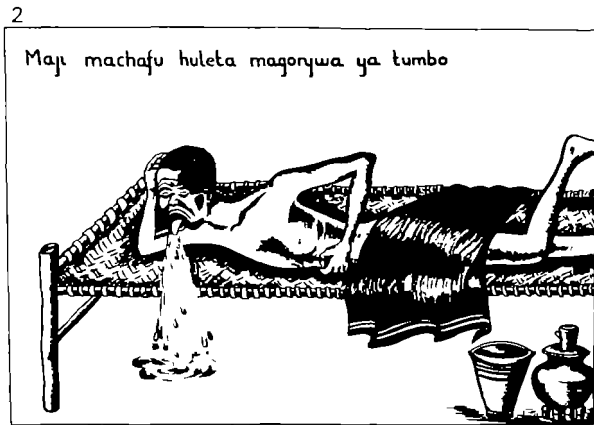

Index

- ABS, 26, 90
- Aerial photograph, 22, 107, 110
- Alluvial fan, 16, 17, 112
- Alluvial plain, 18
- Analysis
 - bacteriological, 34, 116
 - chemical, 34
- Anchor bolts, 61, 80
- Anti-clockwise rotation, 43, 100
- Aquifer
 - characteristics, 6-8
 - choice, 11, 37-39
 - confined, 6, 86
 - definition, 6
 - extent, 29, 35
 - search for, 17-20
 - thickness, 3, 9, 39
 - unconfined, 6
- Auger bit, 42, 100

- Backfill, 37, 59
- Backward erosion, see Erosion
- Bacteria, 51, 85, 97
 - E coli, 96-97, 116
 - indicator, 96
- Bailer
 - construction, 44, 101
 - survey, 25, 58, 89
- Bailing
 - construction, 44-46
 - survey, 25
- Basalt, 13
- Bayonet coupling, 89
- Beach ridge, 19
- Bearings, pump, 73
- Bedrock, 17, 18, 28, 29, 30, 47, 88, 101
- Benchmark, 27
- Borehole
 - criteria for approval, 33-36
 - location, 41, 42
 - number, 31-32
- Buried river-bed, 19

- Capacity
 - hand pumps, 23, 69, 70
 - membrane pump, 57
 - survey test pump, 91
- Casing, construction, 44-46, 47, 102-103
 - lowering pipe, 45, 54, 102
 - removal, 54-55
- Casing, survey, 25-26, 90-91
- Caving, 25, 44-45
- Centering device, 52
- Chain spanner, 103

- Characteristics
 - aquifers, 6-7
 - sediments, 8
 - soil types, 28
- Checklist pump maintenance, 114-115
- Chlorine, 116
- Clamp
 - casing, 25, 44, 91, 102
 - filter pipe, 52-53
- Clay rammer, 59
- Clay seal, 37, 54, 85
 - function, 59
 - installation, 59-60
 - thickness, 59
- Clockwise rotation, 25, 26, 43, 45, 54, 91
- Coastal plain, 19
- Combination auger, 24, 87
- Community development, 22, 77
- Compass, 112
- Compriband, 73
- Concrete cover, 52, 73
 - design, 61
 - installation, 64
 - mould, 61
- Cone of depression, 8-9
- Conical auger bit, 44, 100
- Conical thread, 89
- Consistency of soils, 28
- Contamination of a well, 2, 3, 11, 23, 36, 37, 39, 59, 61, 73-74, 79, 81, 85, 97, 116
- Contour, 111
- Coordinates, 31, 113
- Corrosion, 34, 50, 71
- Cracks in concrete
 - prevention, 66
 - repair, 80
- Criteria
 - borehole approval, 33-36
 - choice of pump, 68
 - environmental, 97
 - hydrogeological, 35
 - site location, 36
 - test yield, 33-34
 - water quality, 34-35
- Crosspiece, 42-43, 90, 101-102
- Cunning, 66
- Cutting angle, 100
- Cylinder
 - checking, 71
 - combination with filter pipe, 70
 - connection with riser/pumprod, 73
 - position in the well, 72
 - principle, 70
 - size, 70

- Darcy's law, 8
- Development of a well, 49, 56-58
- Disinfection, 81, 116
- Drainage of spillwater, 23, 66, 86
- Drawdown, 8, 35, 58, 72

- Easting, 113
- E C meter, 26, 92
- Electrical conductivity (E C), 10, 26, 34, 35, 92
- Equilibrium profile, 14
- Equipment
 - pump installation, 72-73
 - pump test, 26, 58, 91-93
 - slab construction, 64
 - surveying, 87-95
 - well drilling, 41, 99-106
 - well maintenance, 80
- Erosion
 - backward, 14, 15
 - by rivers, 13-16
 - slope, 13
 - soil, 13
- Evaporation, 5
- Evapotranspiration, 5, 11
- Extension catcher, 102
- Extension hanger, 42, 102
- Extension rod, construction, 102
 - use of 3 m rod, 43
 - with disc, 46, 102
- Extension rod, survey, 89-90

- Feeler gauge, 51
- Filter pipe, 37, 49, 64
 - diameter, 50
 - installation, 51-52
 - length, 50, 52
 - retrieval, 58-59
- Flight auger
 - construction, 44, 100
 - survey, 88
- Flooding, 18, 23, 86
- Fluoride
 - content, 34, 97
 - test kit, 92
- Foot plate
 - pump, 69, 73
 - tripod, 41
- Foot valve, 70, 71

- Gasket, 73, 74, 115, 116
- Geological map, 21
- Gradation, 28
- Gradient, 8
- Grain size, 6-8, 49
- Granite, 13, 18
- Gravel, 49-50, 66
- Gravel pack, 37, 56
 - installation, 52-54
 - thickness, 50
- Grid reference system, 113
- Groundwater
 - exploration methods, 21
 - flow, 6, 8-9
 - indicators, 22, 111-112
- Groundwater level fluctuation, 4, 9-11, 21, 31, 72
 - influence on water quality, 10, 34
 - influence on yield criterion, 34

- Hand drilled wells
 - comparison with dug wells, 3-4
 - short description, 2
- Hand dug wells, see also Ring wells
 - comparison with drilled wells, 3-4
 - literature, 3
- Hard-core, 61
- Hardening, cement, 63, 66
- Health education, 2, 77, 85-86
- Heavy-weight test drilling equipment, 24, 90
- Homogeneous, 7, 49
- Hydrogeological criteria, 35
- Hydrogeology, 17, 21, 34, 35
- Hydrological cycle, 5-6

- Immunity, 2
- Incomplete well, 39, 47
- Incrustation, 51
- Indicator
 - bacteria, 96
 - of groundwater, 22, 111-112
- Infiltration, 5
- Installation jack, 73
- Installation
 - clay seal, 59-60
 - concrete cover, 64
 - filter pipe, 51-52
 - gravel pack, 52-54
 - hand pump, 72-75
- Investment costs
 - hand drilled wells, 4
 - hand dug wells, 4
 - hand pumps, 68
 - water supply systems, 2
- Iron, content, 97
- Irrigation, 66, 70, 77

- Jack, 10 ton, 55, 103

- Kangaroo pump, 61, 63, 68, 69-70
- Kelly bar, 90

- Landslide, 13
- Laterite, 3, 13, 34, 88, 101
- Latrine, 23, 77, 116
- Layout
 - construction site, 41
 - village, 22, 23, 32
- Legend of topographical map, 108, 111
- Light-weight test drilling equipment, 24, 87-89
- Lithology, 28
- Livestock, 34, 77
- Location
 - borehole, 41, 42
 - criteria for site -, 36

Maintenance

- checklist, 80, 114-115
 - costs, 1-2, 76
 - equipment, 80
 - frequency, 80
 - report, 80, 81, 125
- Maintenance, types of
- preventive, 79
 - remedial, 79-80
 - corrective, 80-81
 - predictive, 80-81
- MAJI, 1, 22, 23, 68, 76, 77, 78, 79, 80, 81

Major part, 28, 29

Manufacturing, local

- pumps, 68-69, 76
- spare parts, 68

Meandering river, 15

Membrane pump, 56, 58

Micro-Siemens per cm, 92

Minor part, 28, 29

Morogoro Wells Construction Project, 3, 68, 70, 87, 94, 105

Mortar, 63, 66

Most Probable Number, 96

NIRA pump, 61, 68, 69, 73, 115

Nitrate, 97

Nothing, 113

Number of wells, see Wells

Overloading of equipment, 26, 44

Overpumping, 56-57

Pathogenic organism, 85

Pediment, 17-18

Pediplain, 17

Percolation, 5

Permeability, 3, 28, 49, 56

- definition, 7

- secondary, 7

Percolation, 5

Piezometric surface, 6

Pipe vice, 73

Piston, 70-71

Planning

- survey, 10-11, 21, 31, 34

- village water project, 77

Plunger, 57-58

Porosity, 6-7, 28

Posters, 77, 127

Profile

- river, 14-16

- soil, 29-31

Progressive sorting, 14

Public health, 2, 79, 85-86

Pulley, 42, 44, 99

Pump

- Kangaroo, 61, 63, 68, 69-70

- membrane, 56, 58

- NIRA, 61, 68, 69, 73, 115

- suction, 2, 57

- survey test, 26, 91-92

- SWN 80 & 81, 61, 68-69, 73-75

Pump attendant

- selection, 77

- tasks, 79-80

- training, 78

Pumping level, 8

Pump installation, 72-75

- equipment, 72-73

Pump operation, 79

Pumprod, 71-72, 115

- catcher, 73

- PE hose, 72, 73

- puller, 73

Pump stand, 73

Pump test

- construction, 58

- survey, 26-27, 91-93

PVC, 49, 71

Quicksand, 25, 45

Radius of influence, 8-9

Recharge, 6, 35

- area, 6

Recovery, 9, 35, 58

Retriever

- casing, construction, 103

- casing, survey, 91

- PVC, 58

Rift Valley, 17

Right angle, construction of, 42

Ring well, see also Hand dug well

- test yield criterion, 33

Rising main, 70, 71-72, 73

- length, 72

- of test pump, 91

River profile

- "ideal", 14-15

- deviations from regular -, 15-16

Riverside auger

- construction, 44, 100-101

- survey, 24, 87-88

River terrace, 18-19

Sample

- soil, 27, 48

- water, 27, 34, 116

Sand-cement blocks, 64

Sanitation, 2, 77

Saturated zone, 5

Scale, 31, 110

Screen, 37, 49, 50

Seasonal fluctuations, see Groundwater level fluctuations

Section

- hydrogeological, 29-31

- of topographical map, 111

Sedimentation, 13-16

Sediments, types of, 14

Self-help labour, 22, 77

Shallow well, 1

- definition, 2

- Sieving of gravel, 49-50
- Site investigation, 21-32
- Site number, 31
- Site selection, 23
 - criteria for, 36
- Situation sketchmap, 27, 31, 113, 119
- Slab
 - construction, 64-66
 - design, 61-63
 - functions, 61
- Slope erosion, 13
- Slots
 - in construction casing, 102
 - in PVC pipe, 37, 49, 50, 51, 59
 - in survey casing, 91
- Soak-pit, 66, 86
- Soil
 - description, 28
 - profile, 29-31, 37
 - recognition, 27
 - symbol, 29
- Soil erosion, 13
- Soil moisture, 5
- Spare parts, 68, 76, 78
- Specific yield, 6-7, 35
- Spillwater outlet, 63, 64, 79, 80, 86
- Spiral auger, 89
- Spirit level, 43, 64, 73
- Spring, 19-20
- Standardization, 37, 72
- Stone auger, 88
- Stone catcher, 88
- Storage capacity, 3
- Storage coefficient, 7
- Storage of survey data, 32
- Strength of mortar, 63
- Suction pump, 2, 57
- Surging, 57-58
- Survey Borehole Description Form, 27, 28, 29, 31, 121
- SWN 80 & 81 pumps, 61, 68-69, 73-75
- Symbol. soil, 29

- Tectonic valley, 17
- Teflon tape, 73, 115
- Telescopic drilling, 42, 47-48, 54, 100
- Terrace, river -, 18-19
- Test drilling
 - equipment, 24, 87-89, 90
 - operations, 23-26
 - patterns, 17-20
- Topographical map, 21, 107-113
 - legend, 108, 111
 - plotting on -, 32
 - sheet history, 107
 - sheet number, 31, 32, 107
- Tor, 13
- Total Dissolved Solids (T D S), 34
- Total well depth, 72, 73
- Transpiration, 5
- Tripod, 41, 42, 52, 55, 99
- Tube well, see also Hand drilled well
 - components, 37
 - design, 37-39
 - example of a design, 40
- Unconsolidated sediments, 8, 12-20
- Union, 73
- United Nations Development Programme (UNDP), 76

- Valley, 17, 18, 20
- Vegetation, 22, 111
- Vertical drilling, 24, 42-43, 46
- Village layout, 22, 32
 - influence on number of wells, 23
- Village Level Operation and Maintenance (VLOM), 1, 68, 76
- Village participation, 76
- Village sketchmap, 22, 23, 31, 117
- Village Water Committee, 22, 77, 78

- Water and Sanitation Decade, 1, 67
- Water-bearing, 28
- Water collection hours, 23
- Water consumption, design criterion, 23
- Water content
 - mortar, 63
 - soil, 28
- Water level, static, 8, 35
- Water level meter, 92
- Water masterplan, 21, 22
- Water quality
 - control, 81
 - criteria, 34-35
 - standards, 96-98
- Water-related diseases, 1, 2, 96
 - prevention, 85-86
 - transmission mechanisms, 85-86
- Water supply systems, 1-2
- Water table, 6
 - perched -, 6
- Water treatment methods, 85
- Weathered, see Bedrock
- Weathering, 12-13
- Well caretaker
 - selection, 77
 - tasks, 79
 - training, 78
- Well depth, total, 72, 73
- Well Description Form, 44, 48, 54, 58, 74, 123
- Well drilling
 - equipment, 41, 99-106
 - operations, 41-48
- Well number, 32
- Well yield, 9, 33, 58-59
- Wells, see also Hand drilled & Hand dug wells
 - allocation, 77
 - disinfection, 81, 116
 - ownership, 77
 - productive use, 77
 - required number, 22, 23, 86
- Winch, 44, 99
- Workshop drawings, 87, 95, 99, 106
- World Bank, testprogramme, 68
- World Health Organization (WHO), Standards, 96

- Yield
 - test, 27, 33, 58
 - well, 9, 33, 58-59



A publication of the
Rwegarulila Water Resources Institute
Dar es Salaam Tanzania