

230

75FA

1) bibl
2) Hof

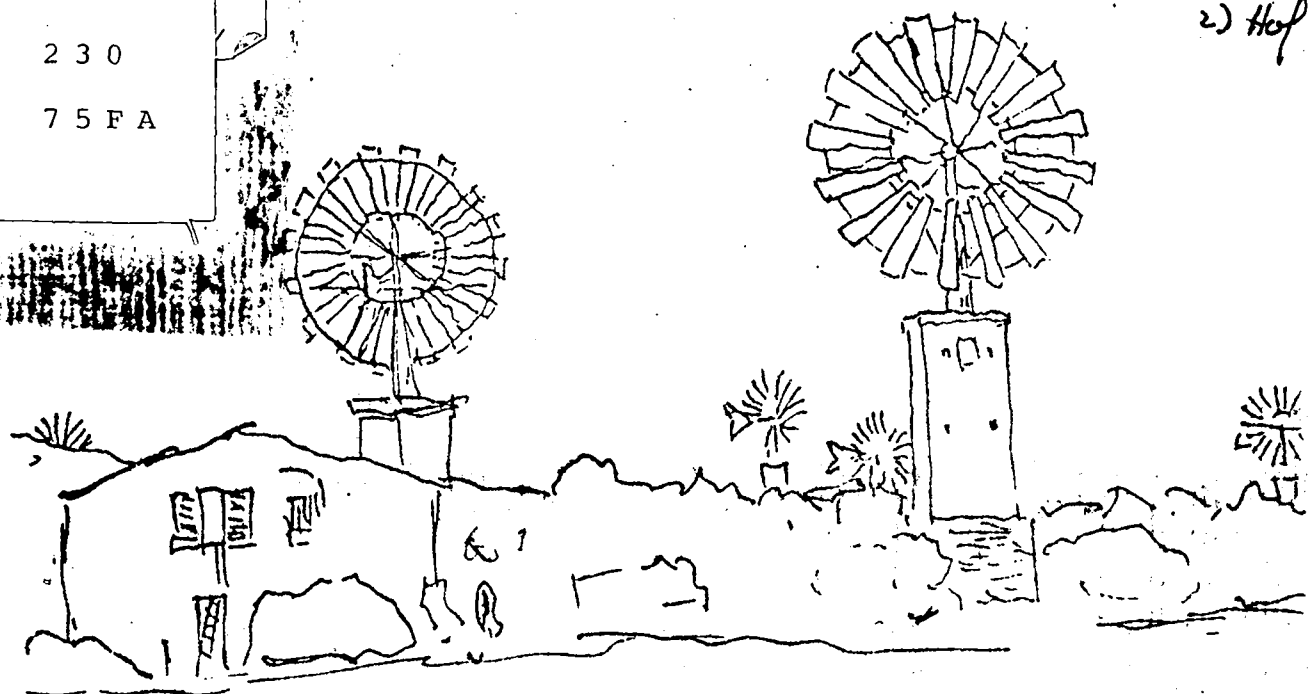

FAO

SKETCH-BOOK

**WATER^{on}-LIFTING
DEVICES**

by

THORKILD SCHJÖLDER

**Rome
1975**

230-75FA

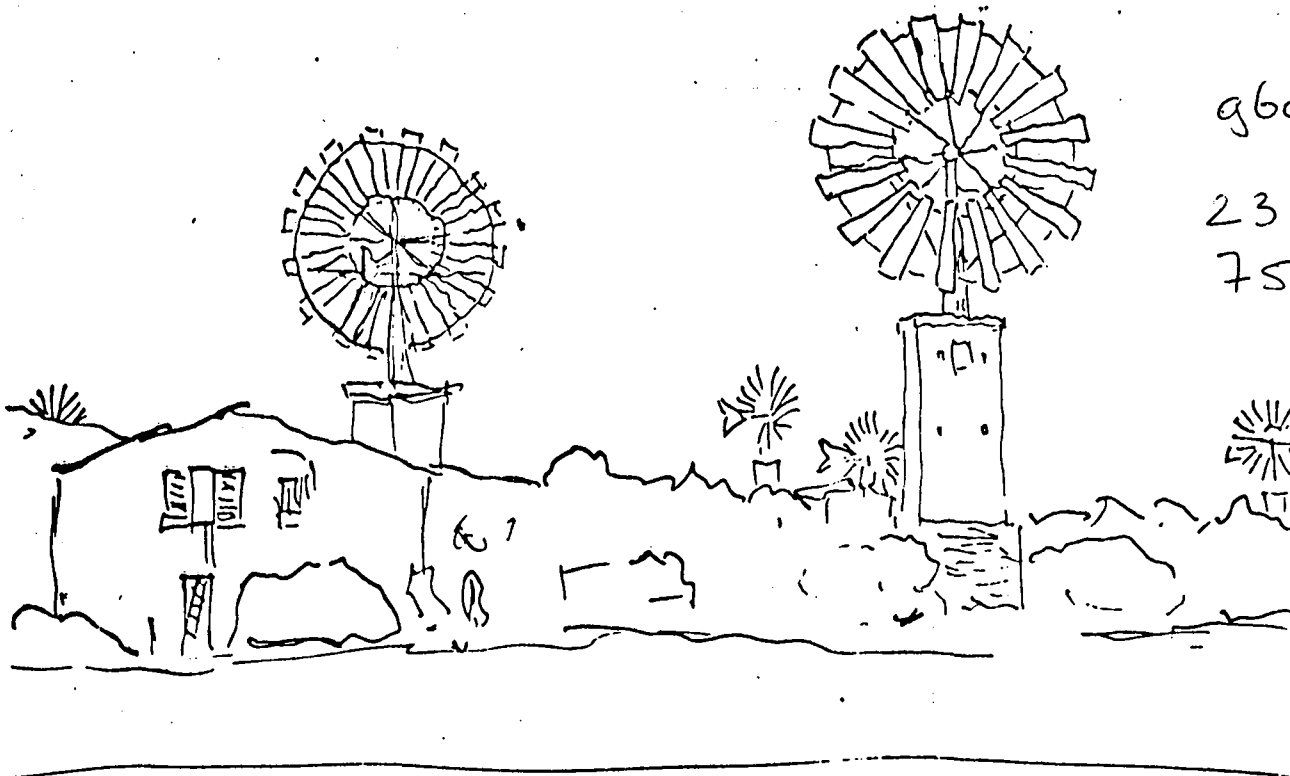

g600

230

7SFA

FAO

SKETCH-BOOK

on
WATER-LIFTING

DEVICES

by

THORKILD SCHJÖLDER

Rome

1975

FAO Centre

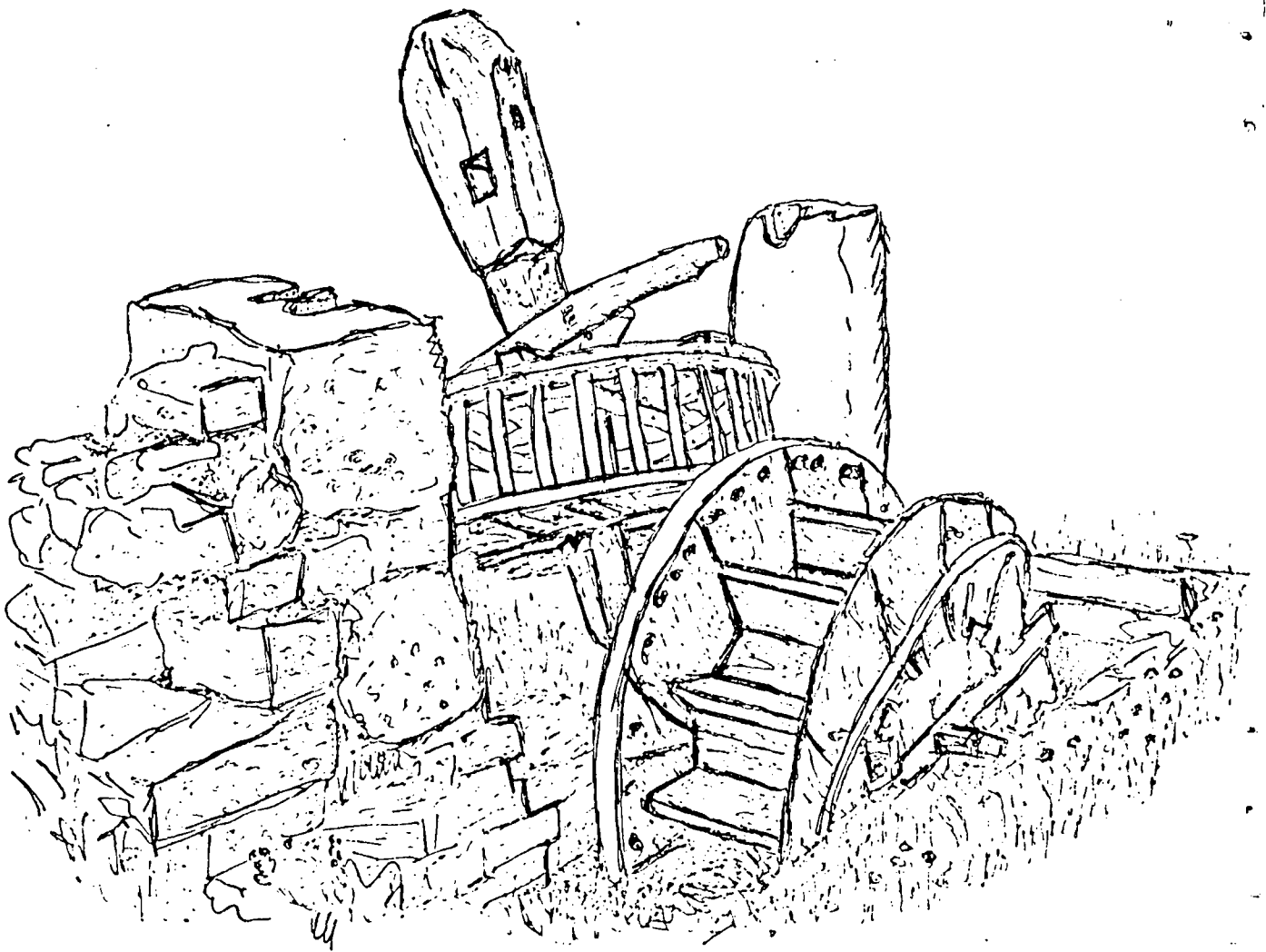

FOREWORD

In the future the Land and Water Development Division is going to make a new edition of the old book Water Lifting Devices for Irrigation.

To introduce such a work which needs a good deal of field work, this little sketch-book has been made.

It is my hope that it will result in a great number of personal contacts.

Thorkild Schioler

Rome 1975

Address:

Th.Schioler Ph.D.

Schweizerdalstien 10

DK- 2610 Copenhagen

Denmark

telephone Copenhagen 70 97 93



This is a very simple, cheap device still used in a few places in the delta of Iraq until some twenty years ago. It is capable of lifting the water about a metre in height and although its flow is rather small it does have the advantage that the basket is immediately repairable.

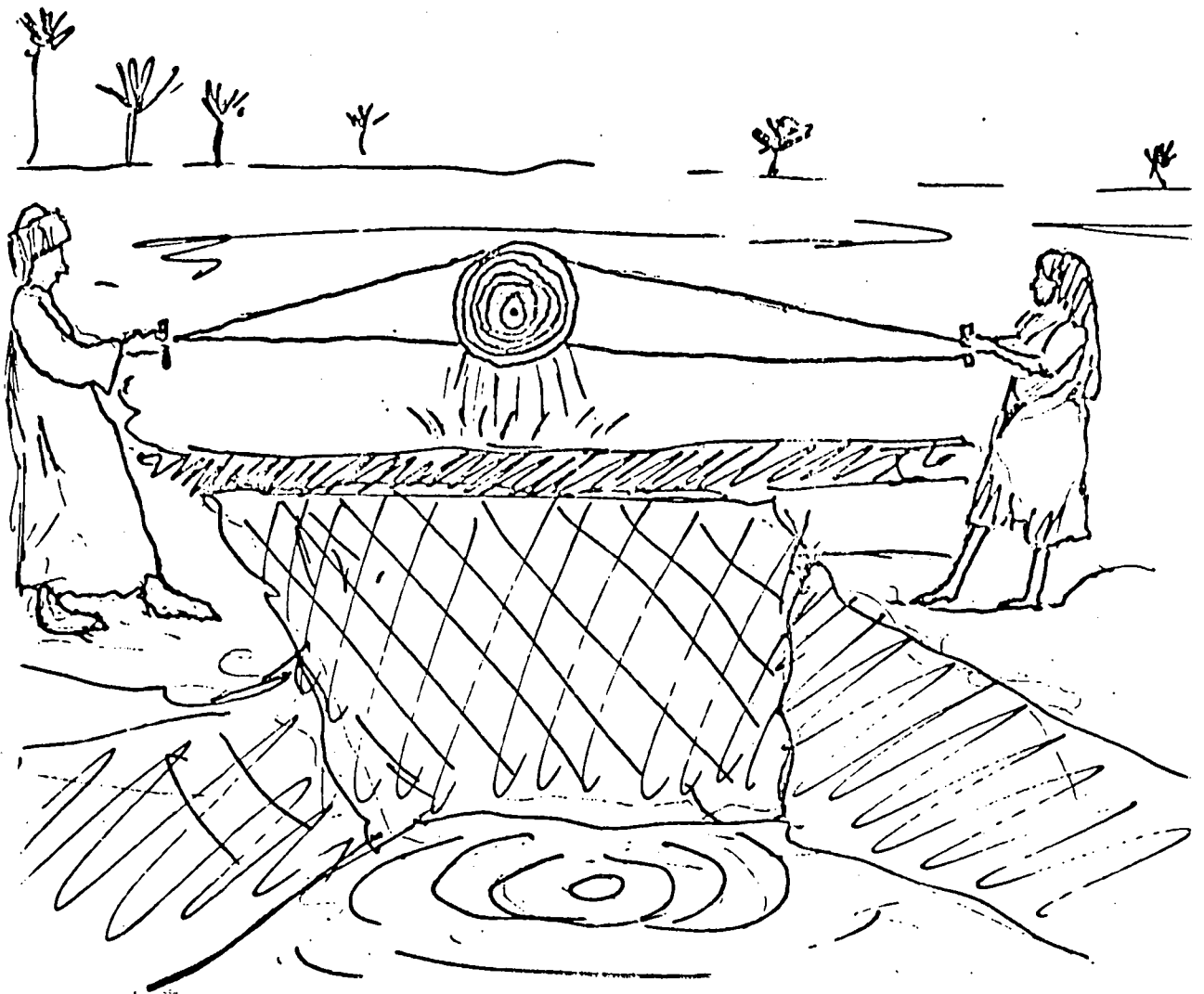

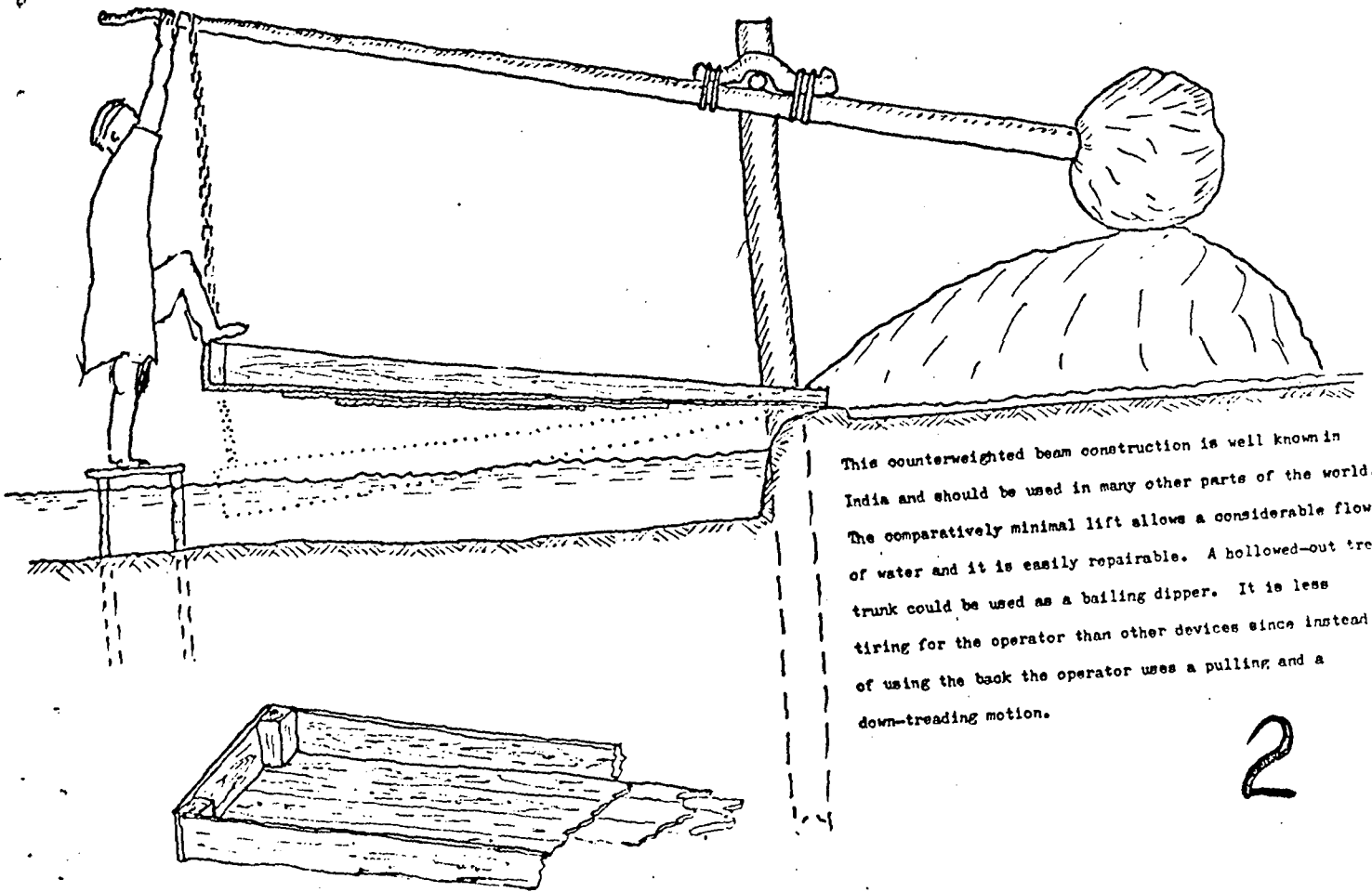

This counterweighted beam construction is well known in India and should be used in many other parts of the world. The comparatively minimal lift allows a considerable flow of water and it is easily repairable. A hollowed-out tree trunk could be used as a bailing dipper. It is less tiring for the operator than other devices since instead of using the back the operator uses a pulling and a down-treading motion.

2a

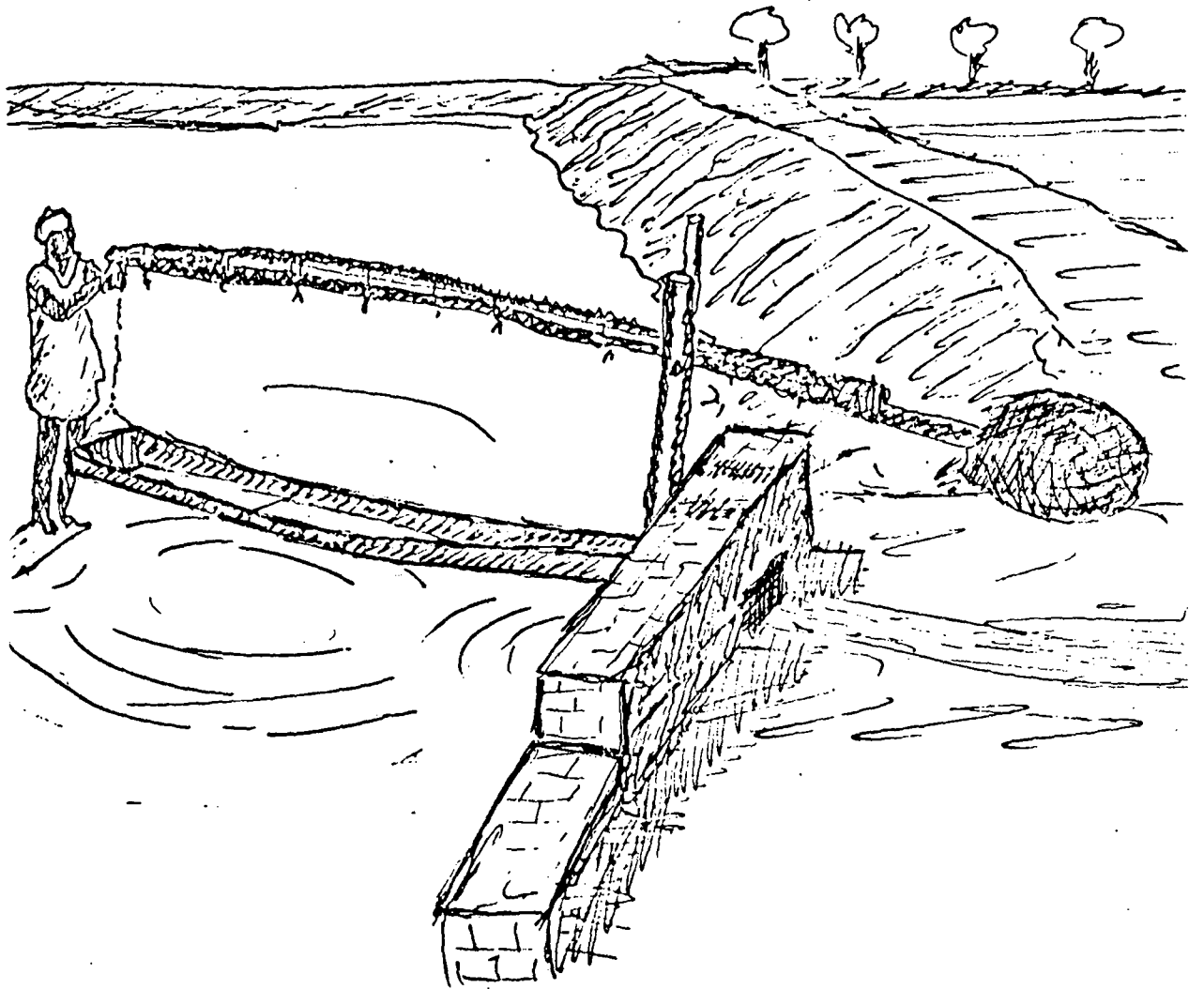

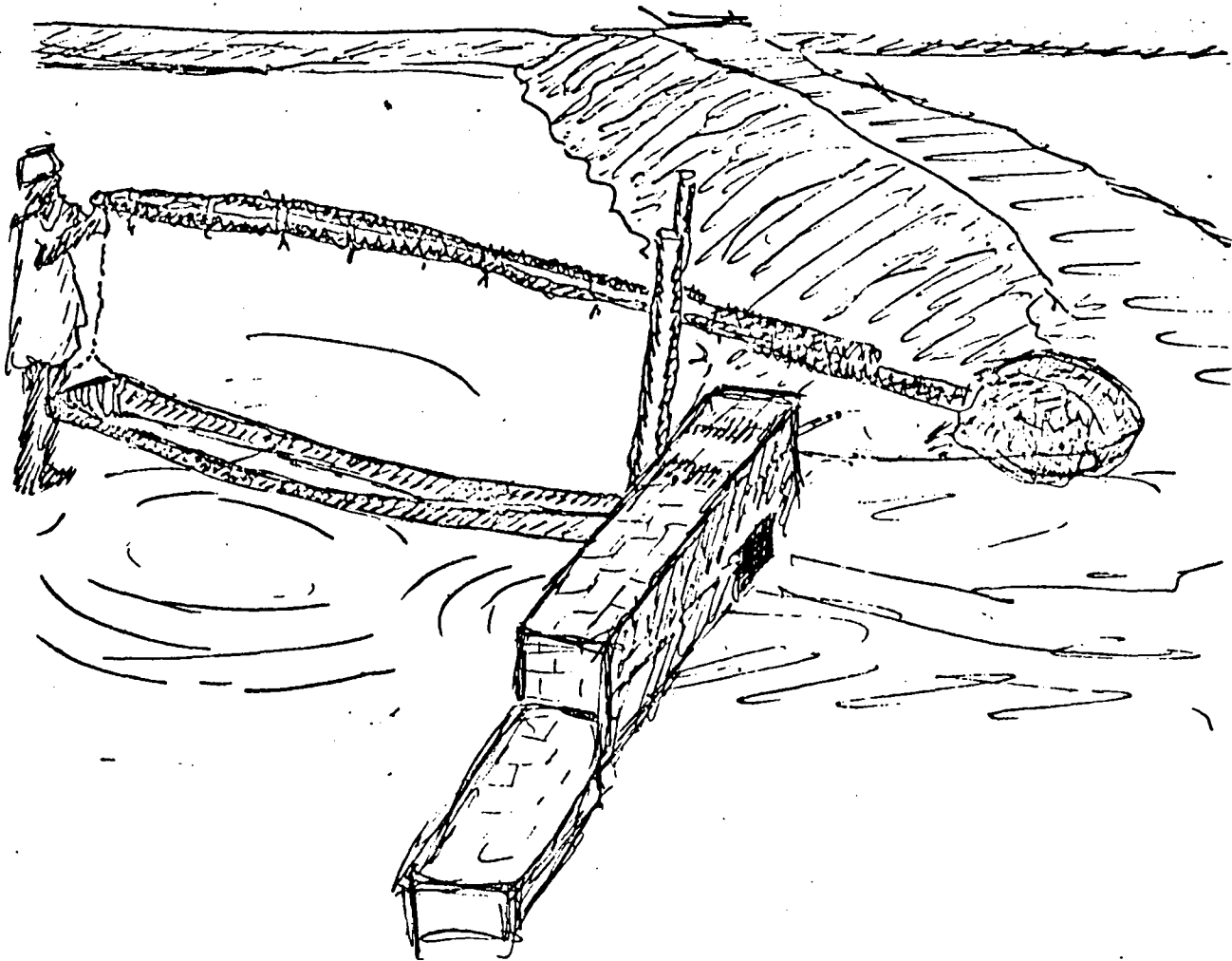

This is a modification of the preceding construction whereby a petrol-can provides the upthrust to lift the wooden dipper, thus eliminating the necessity for a counterweighted beam.

2b

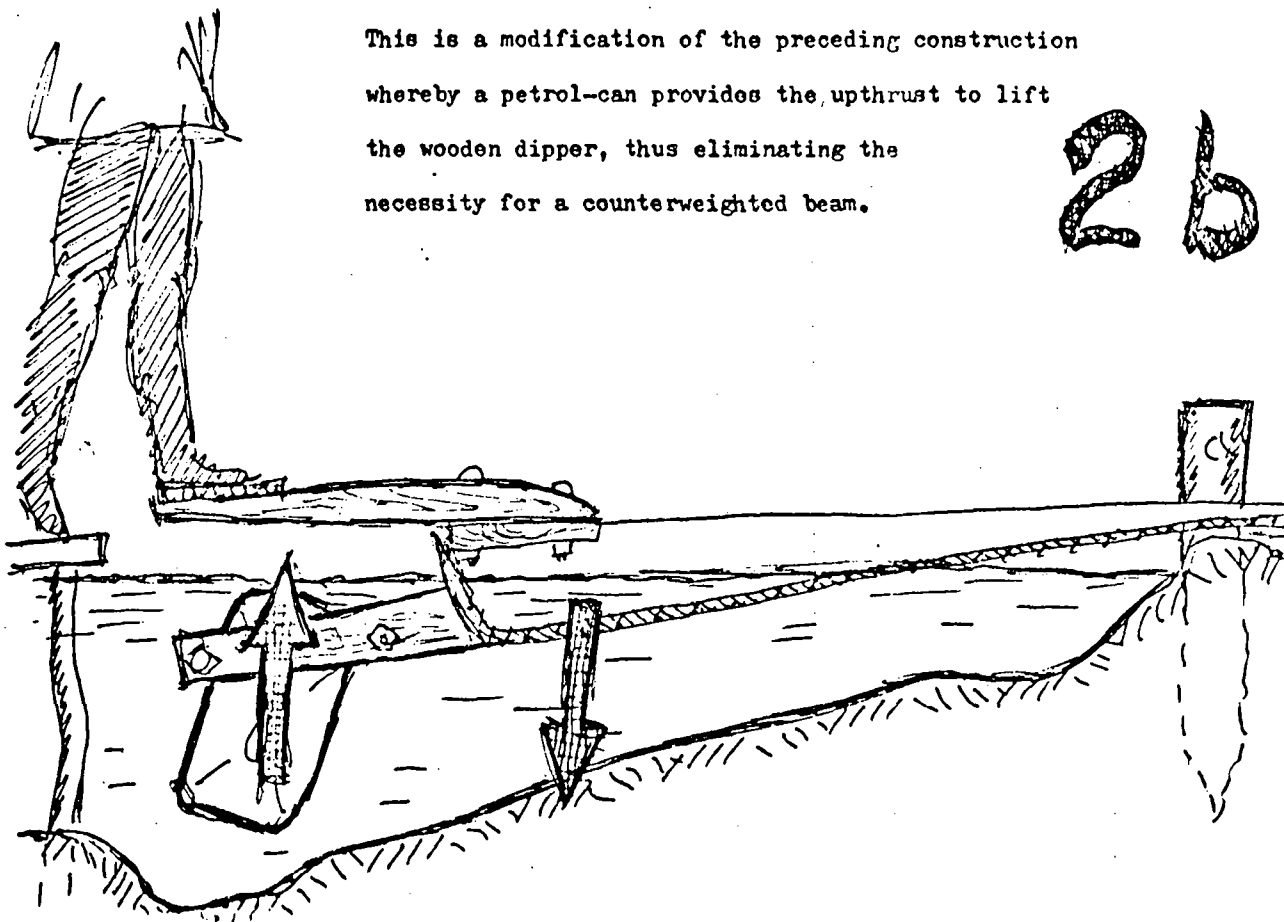

This pivoted beam allows considerable vertical movement with minimum muscular effort. Provided there is no lack of manpower this system is perhaps the cheapest way of raising water if, say, the lift is about

3

7 metres.

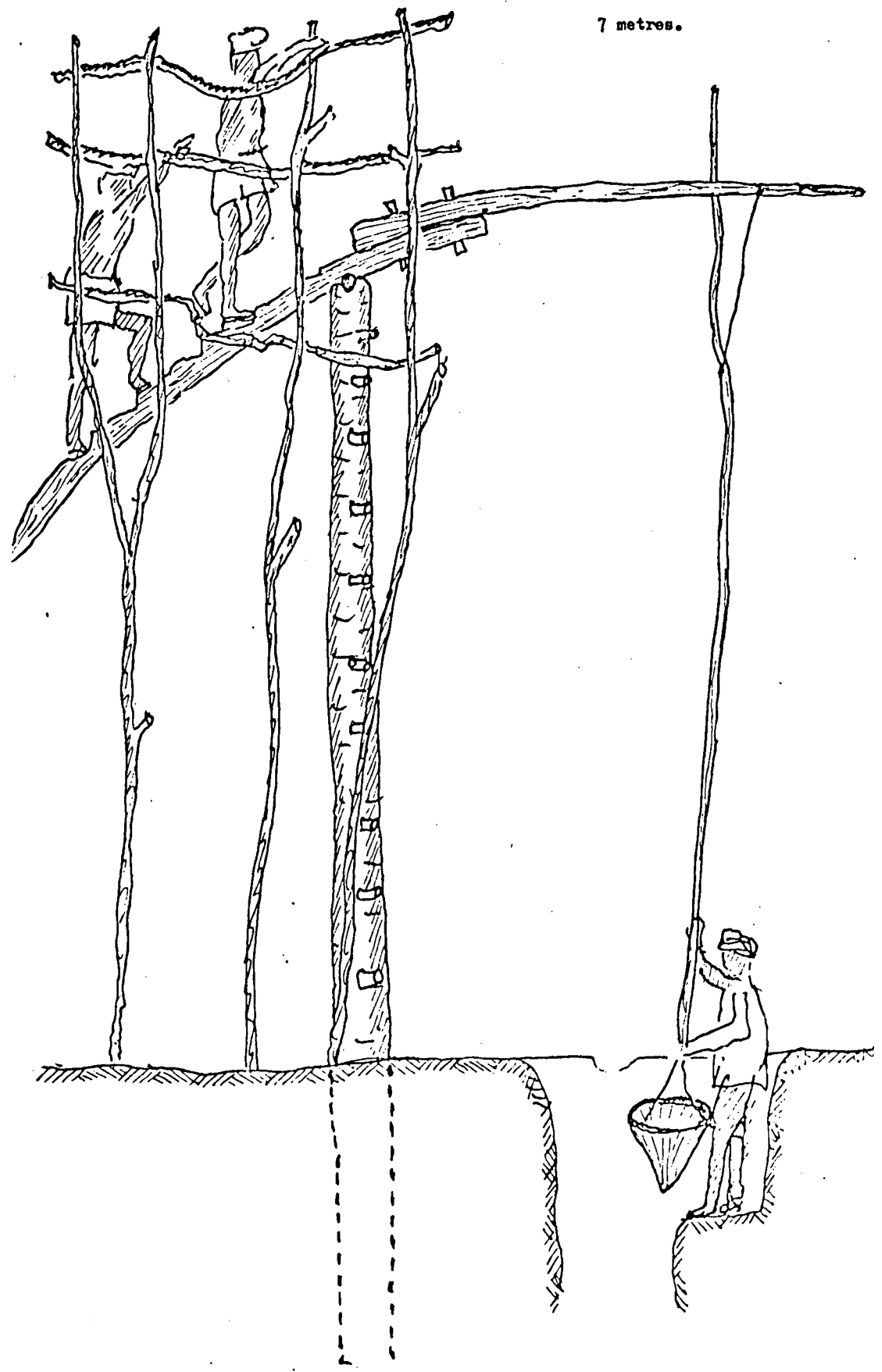

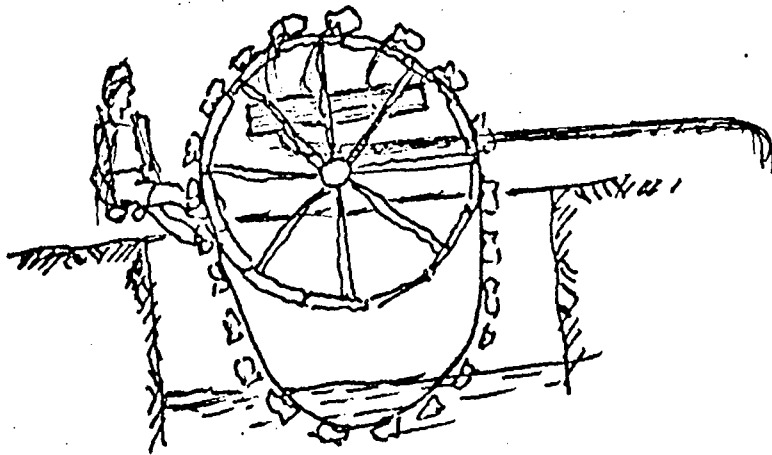

This foot-operated wheel construction should have wide application. It is an excellent carpentry construction in which the rim is comprised of many wooden pieces and the wheel has many thin spokes instead of a few clumsy ones.

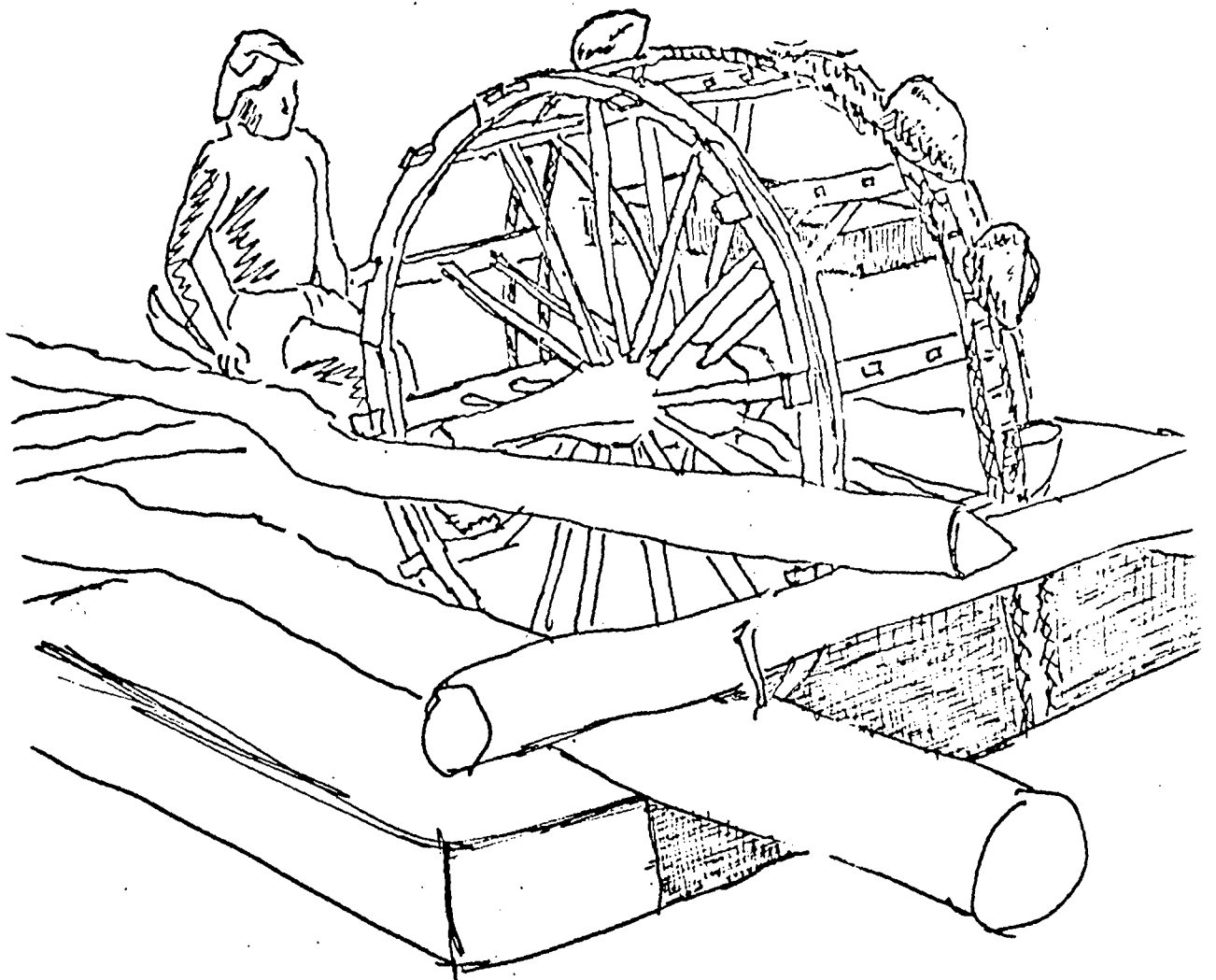

A similar construction is also a potgarland, worked by the feet but here the operator walks rather than treads. This construction is very little used but it must be the best way to transmit manpower into rotation. The operator uses the weight of his body more than his muscular strength.

5

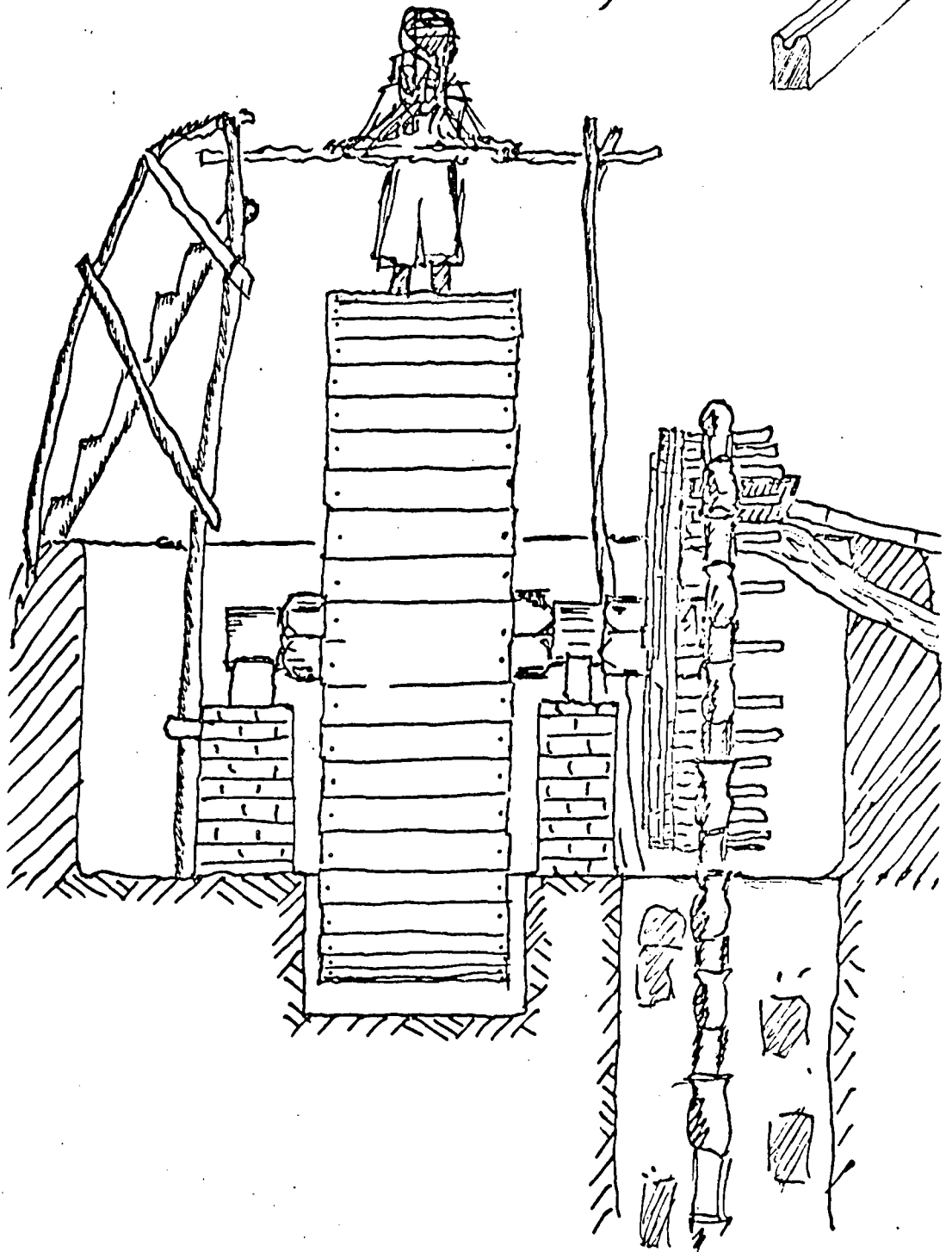
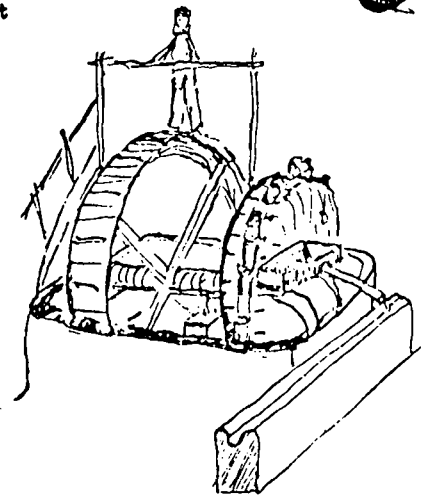

This water-lifting wheel can be traced back to the II century and it is still an effective method of raising water to a high level channel.

6

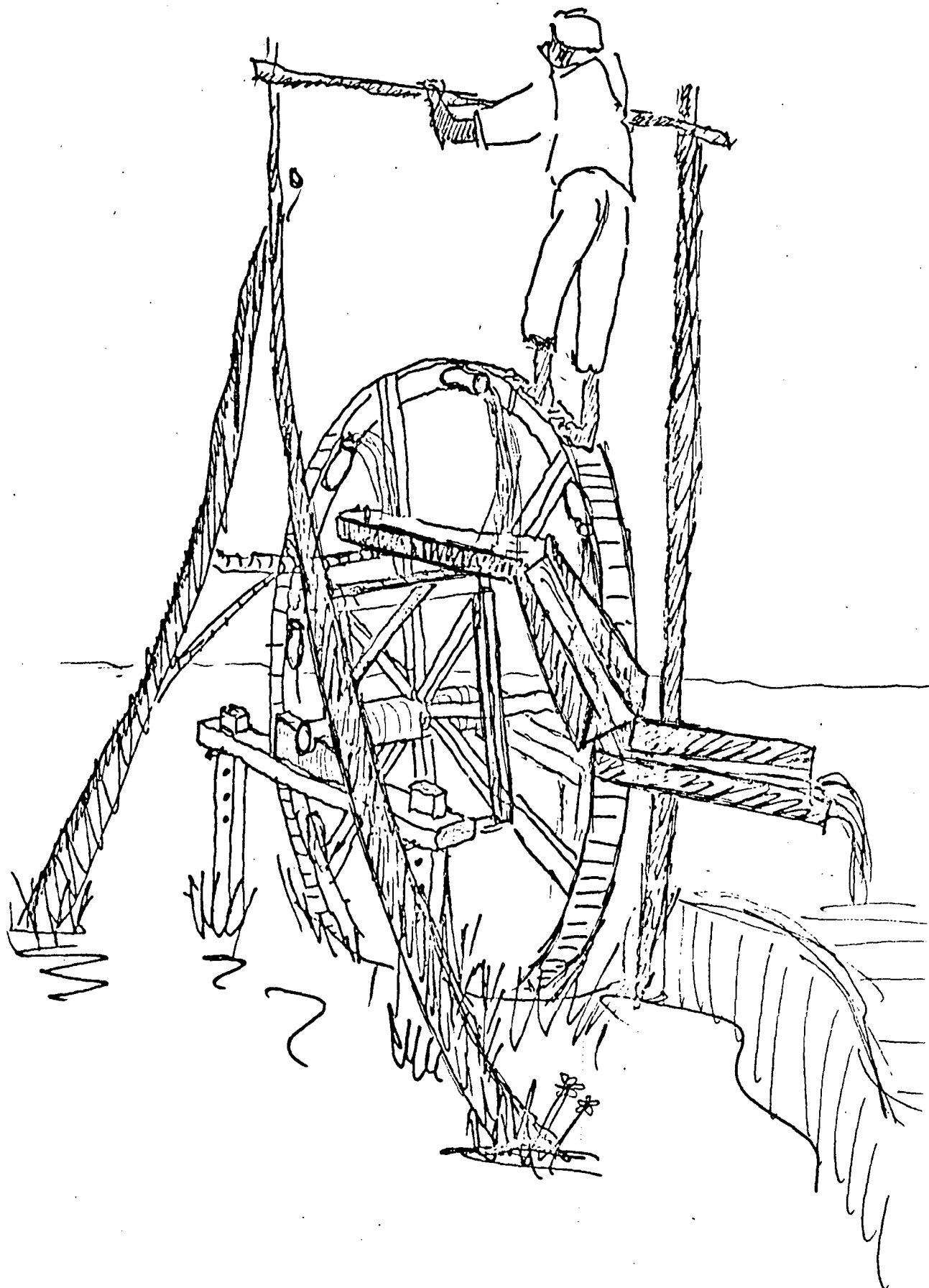

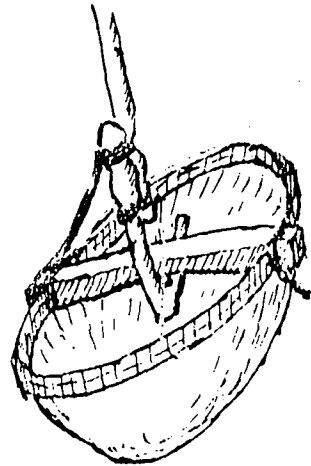
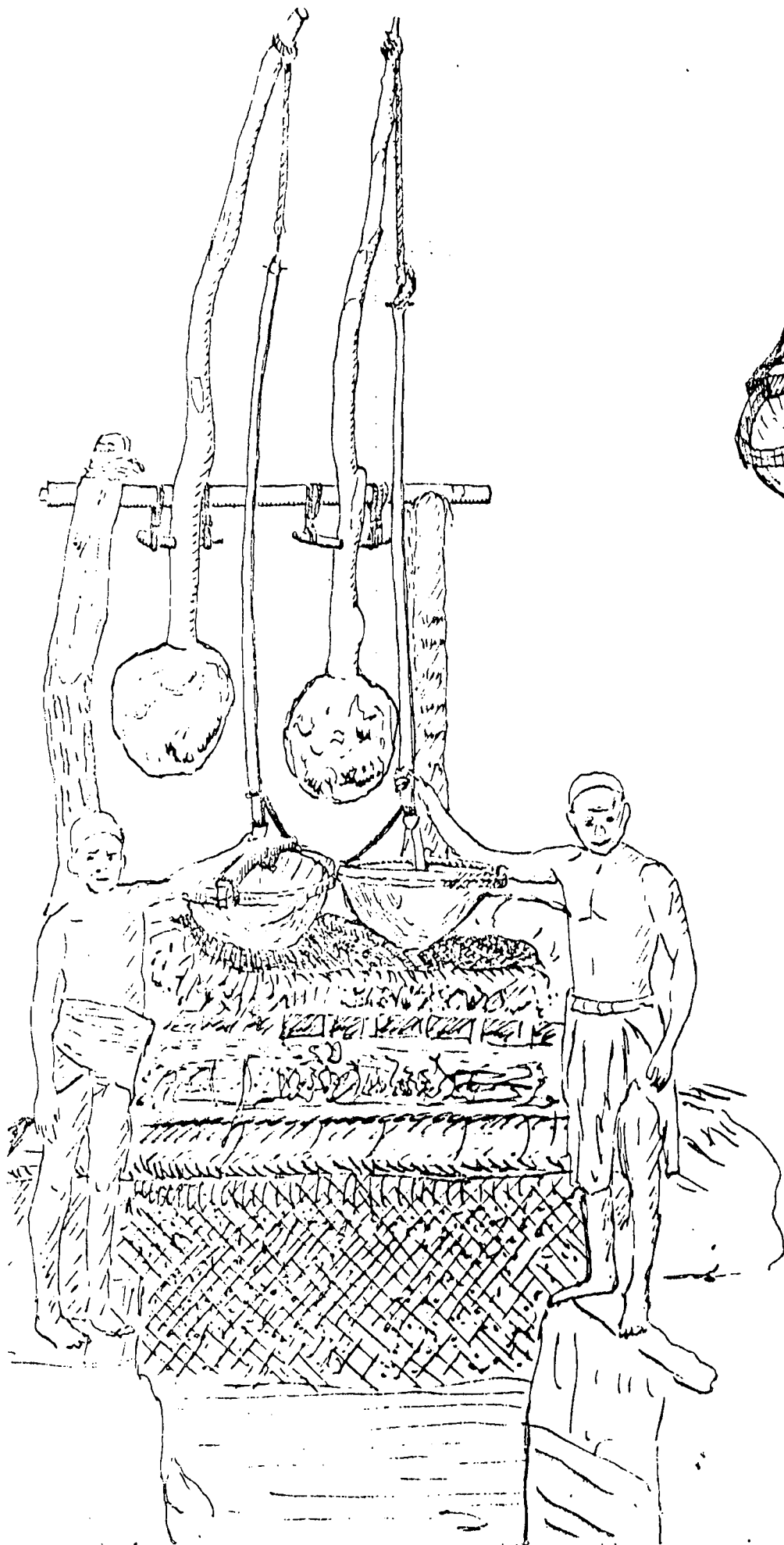

The shaduf is more than 4 000 years old and it is still a cheap, reliable device. It should be remembered that the perpendicular rod should be a rod and not a rope. The two pillars should be built up of straw and clay to form a solid mass.

7

From an engineering view-
point it is interesting that
the beam and mass compose a
forced oscillating motion.

Should something fail in
the construction it could
be repaired at once.

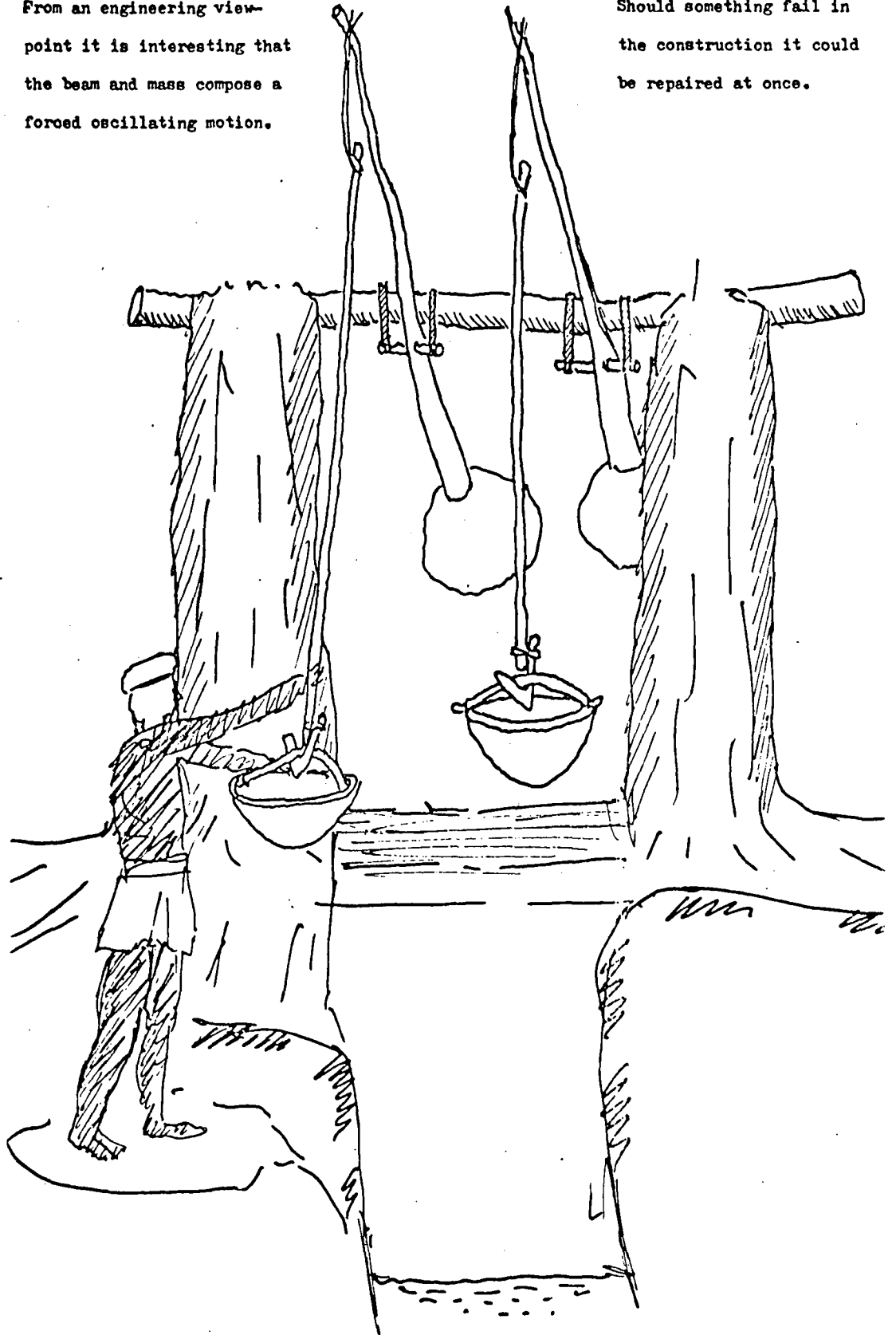

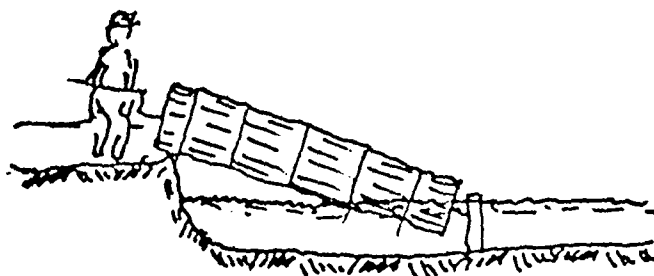

The Archimedean screw is well known in Egypt but should find its way to other parts of the world. The screw is easy to construct. First, about 70 blocks measuring 35 x 65 x 430 millimetres are cut and a 15 millimetre hole is drilled through the middle of each. The blocks are then slipped onto a 14 millimetre diameter rod and arranged round this in the form of a spiral staircase.

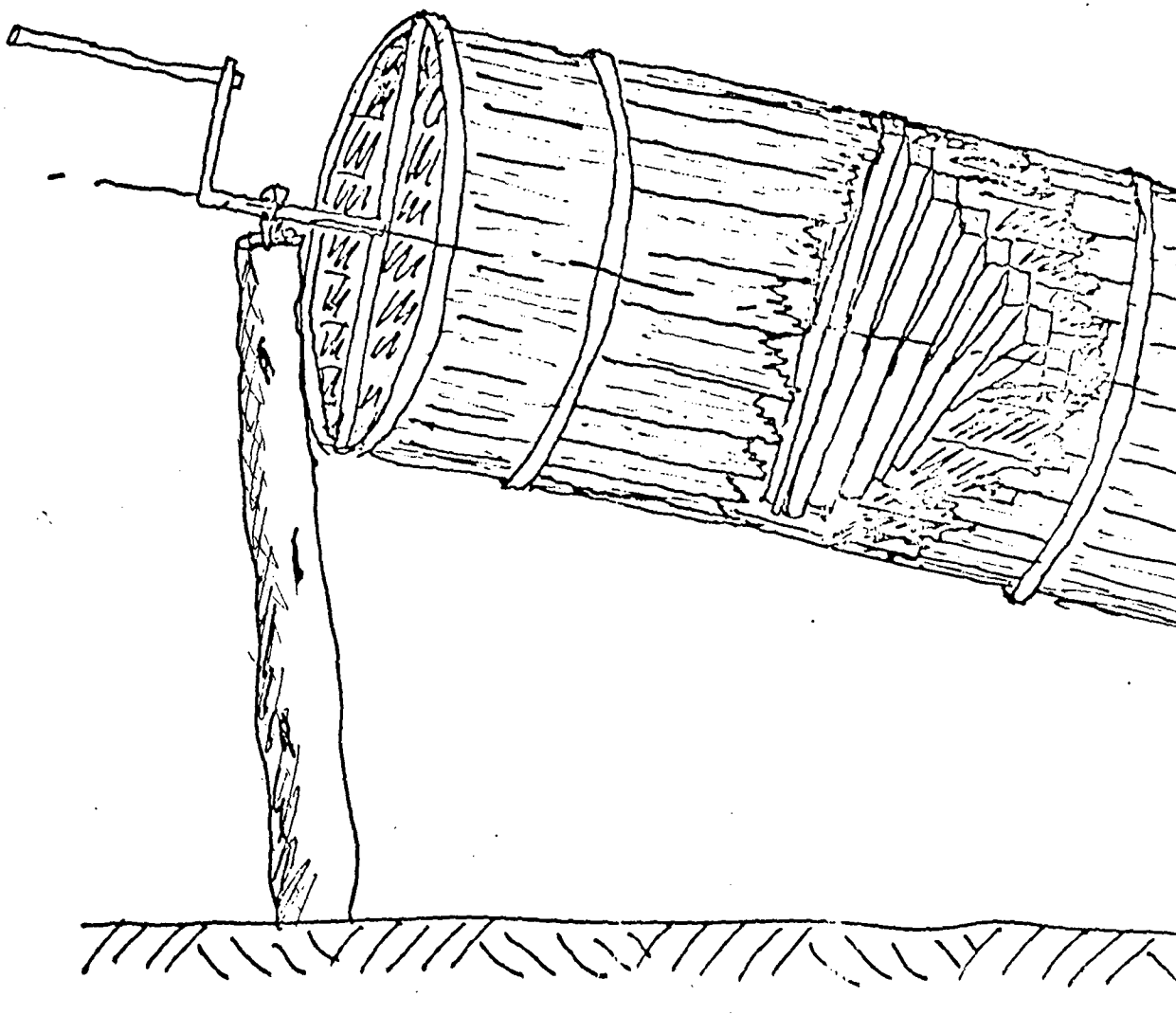

8b

Instead of a crank another construction should be suggested. A gear should be made and the shaft should be operated on a treadle system. It is slightly more complicated but less tiring.

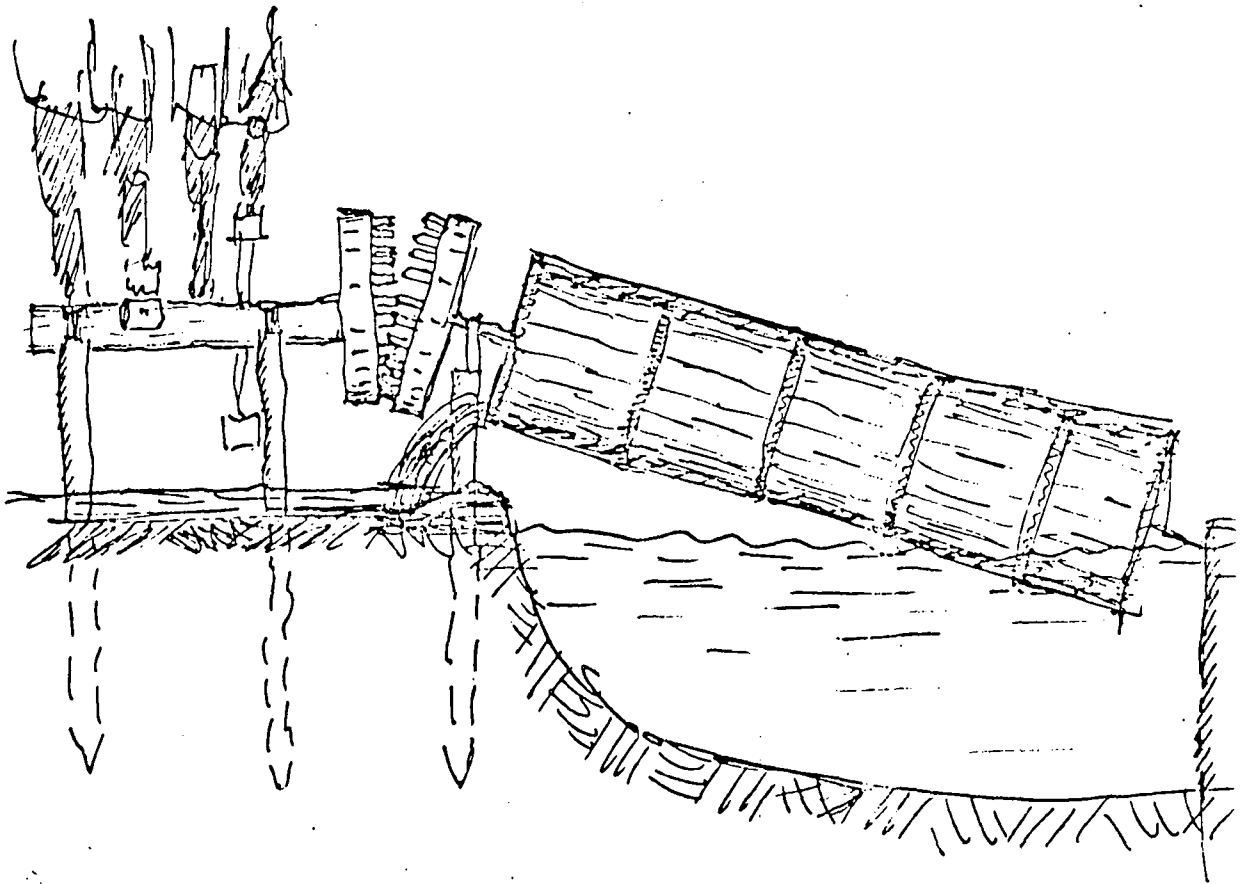

THE DEVELOPMENT OF MECHANISMS IN ANCIENT CHINA

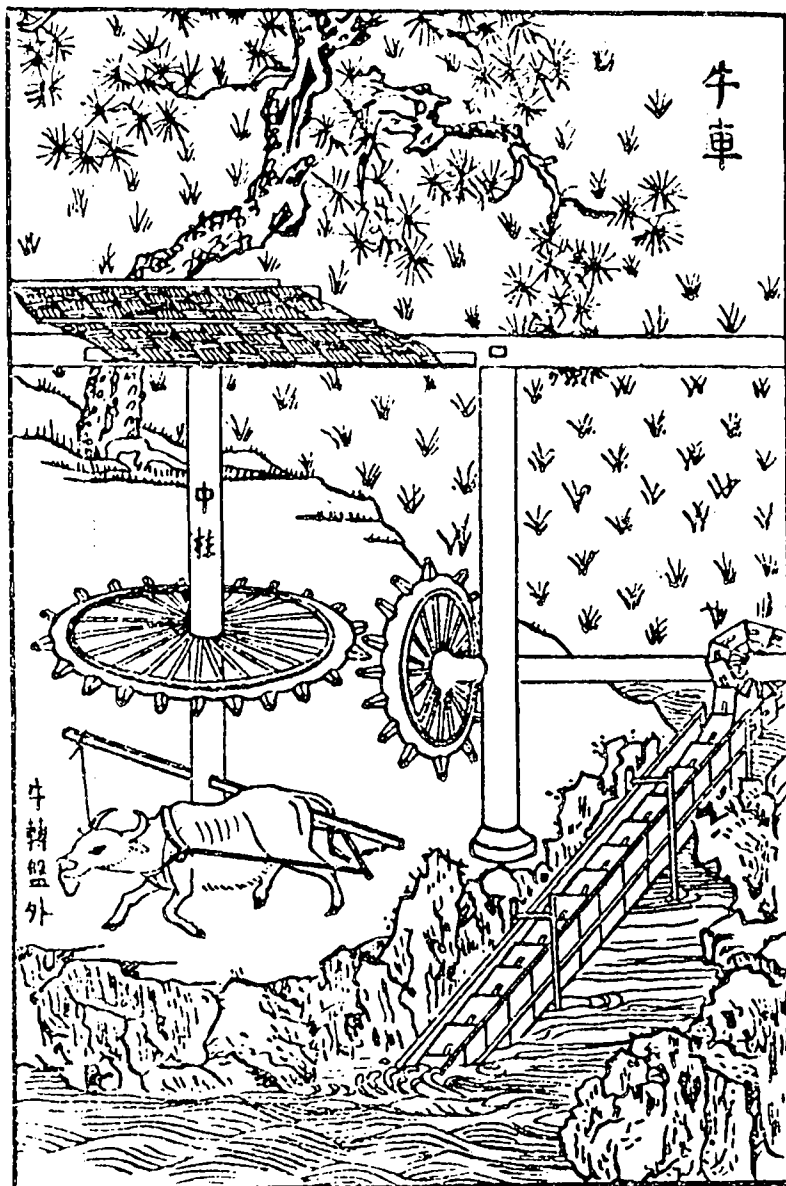

第七圖

Fig. 49. CHAIN PUMP WORKED BY OX-DRIVEN GEAR.

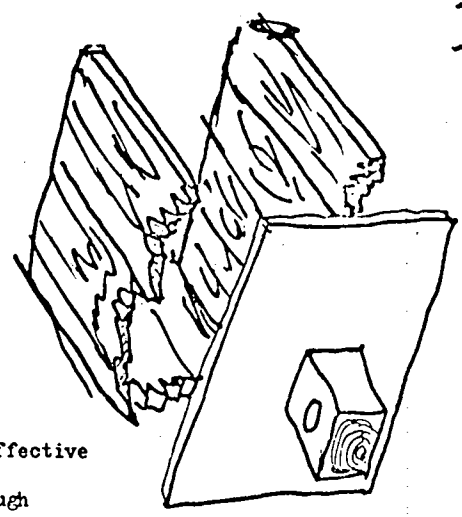
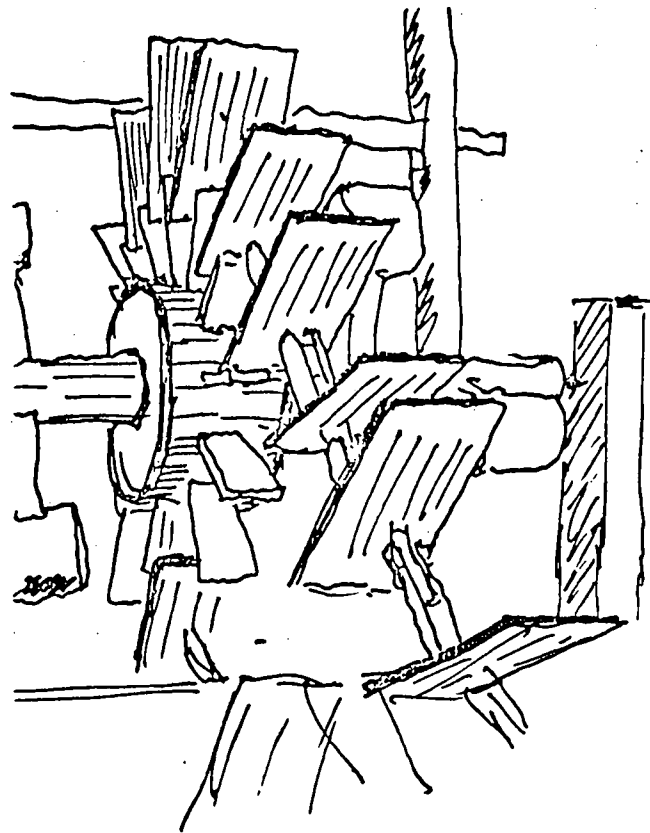

This is a fairly effective device which although comprised of over 200 pieces in the event of failure it could be repaired by the local carpenter.

It can be operated from a sitting or standing position. In other cases the device is turned by hand or even over an angle-gear by a pair of bullocks.

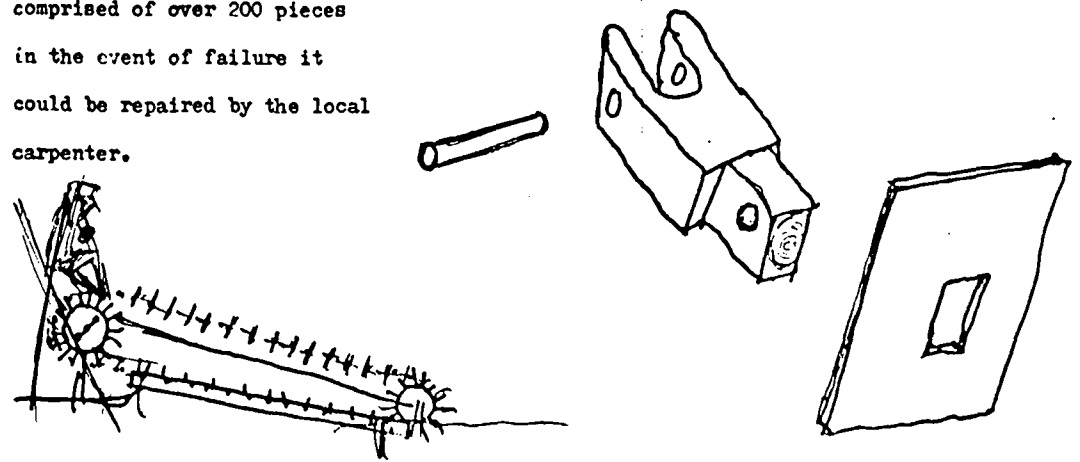

This hand-operated piston pump with its clack valves is not recommended for irrigation. Although the girl is sitting the work must prove arduous on the foot. The bamboo rod serves as a spring to facilitate the up-stroke.

10

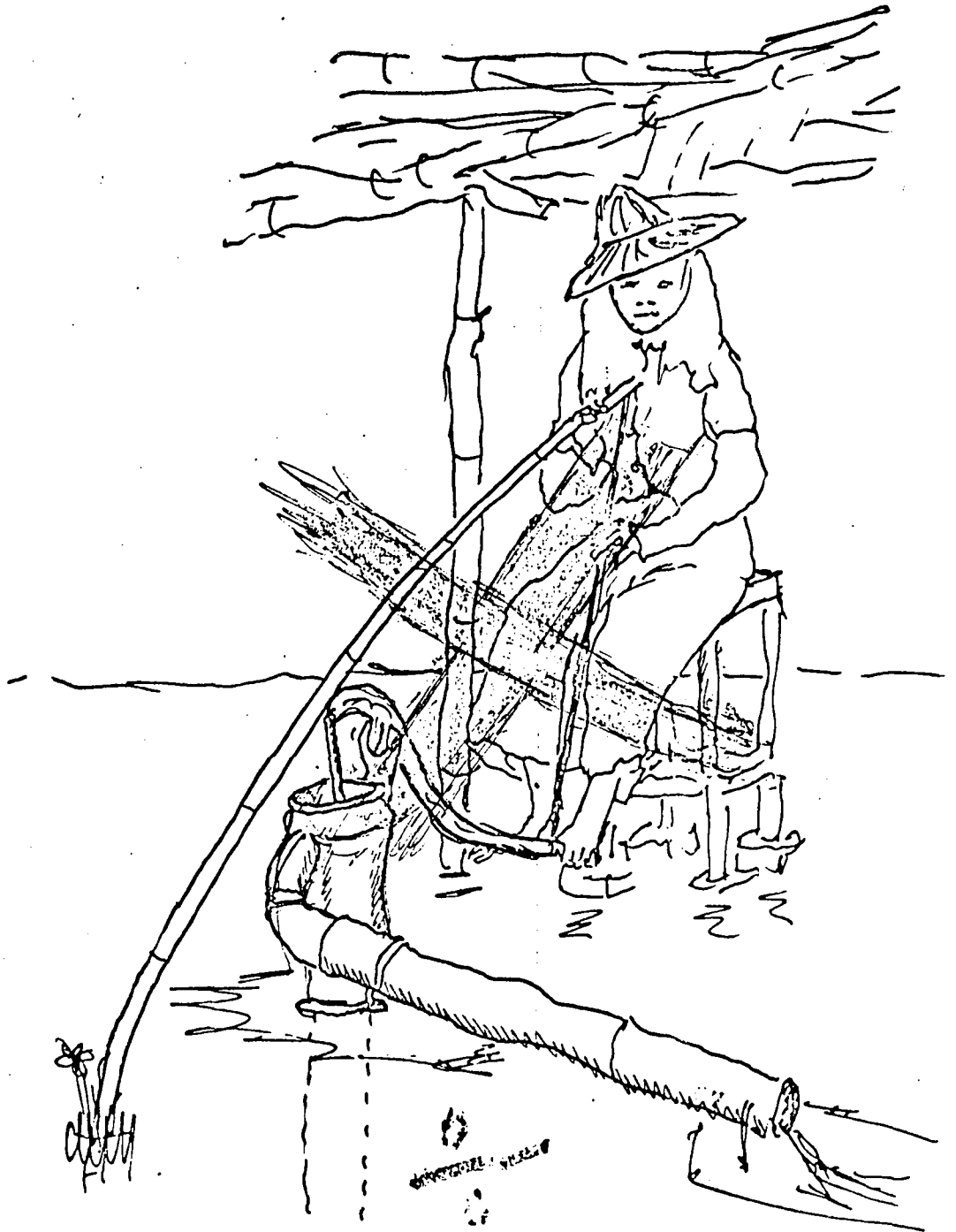

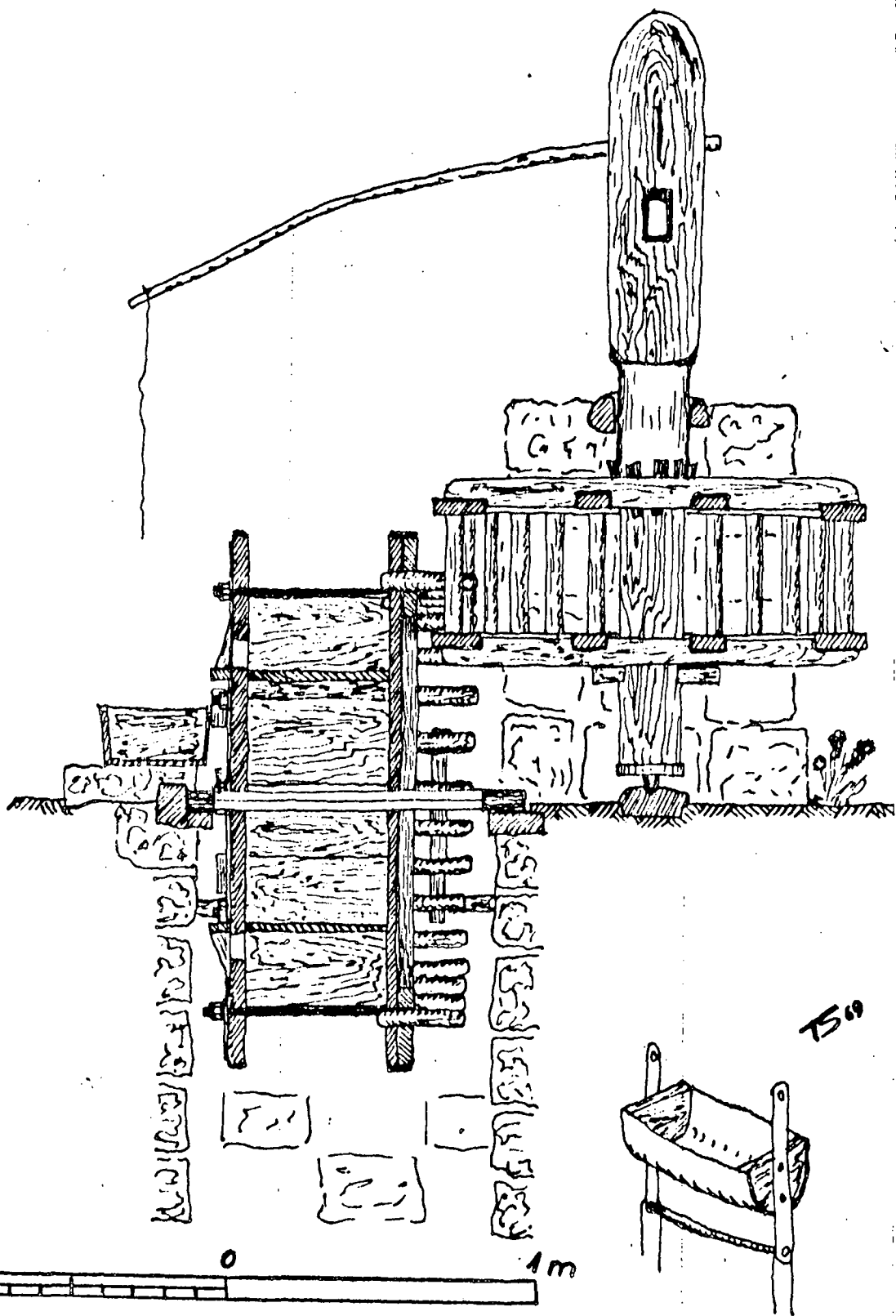

750

For lifts of even up to 30 metres there is no doubt that the Persian wheel is the best solution even compared with the electric centrifugal pump.

The only problem is to change the carpenter's traditional work. In some parts of the world the construction has remained unchanged for 2 000 years.

The tooth wheels should be of a light framework construction; the buckets should be made of plastic or wood, small and numerous rather than large and few; and the overall construction should be made of dried wood in some way protected against rot. The animal should be protected from the sun, flies and hunger.

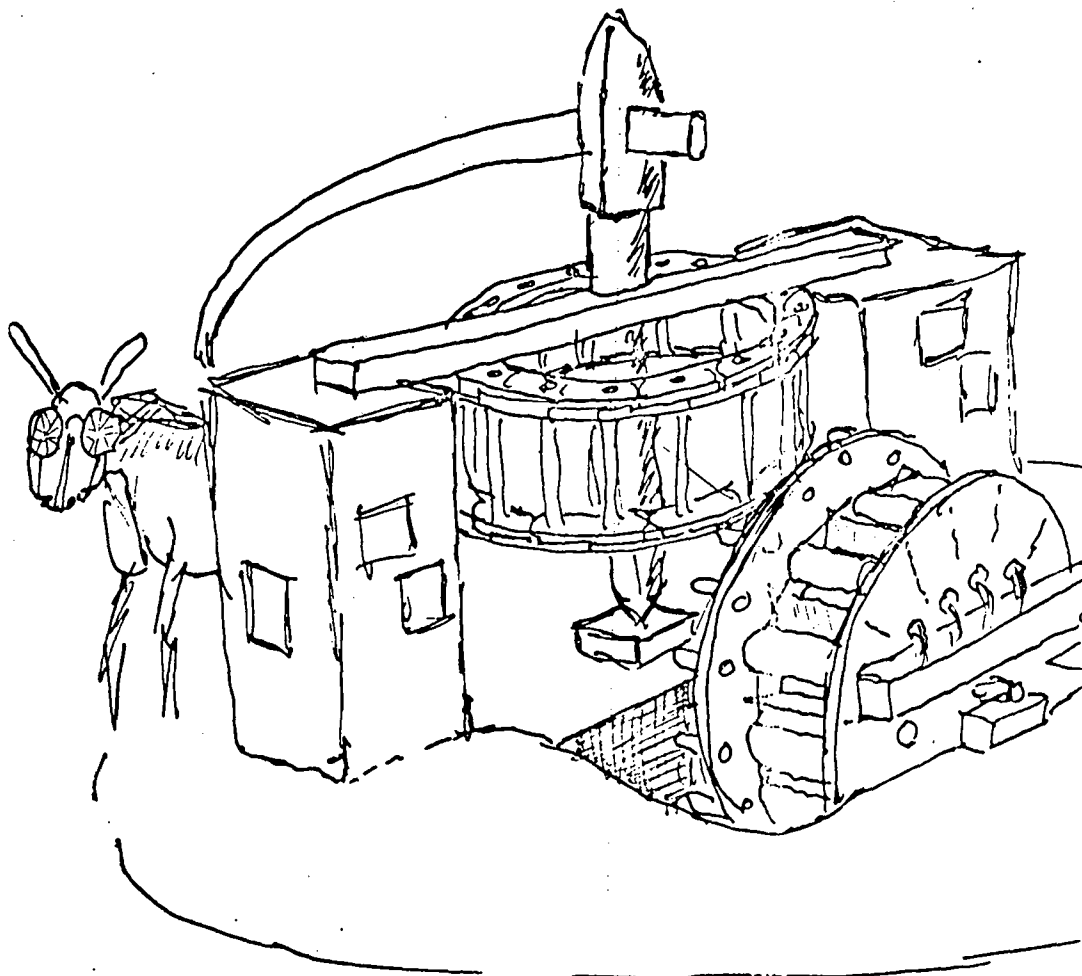

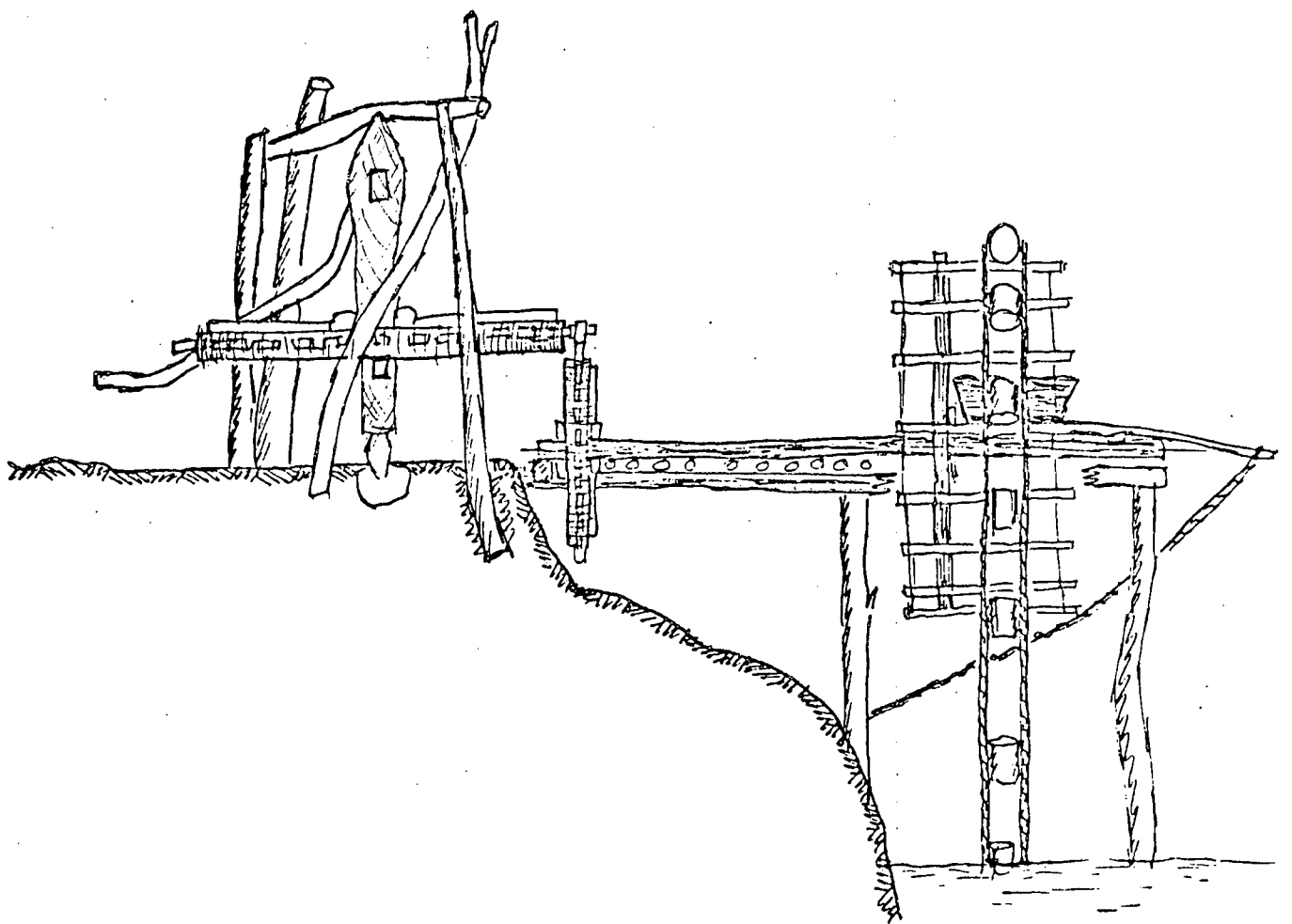

There is no proportion between the heavy wheels and the low power involved in this machine. Too much of the available power is lost by friction. The input power is probably about 50 watts of which no more than 10 are used for lifting the water.

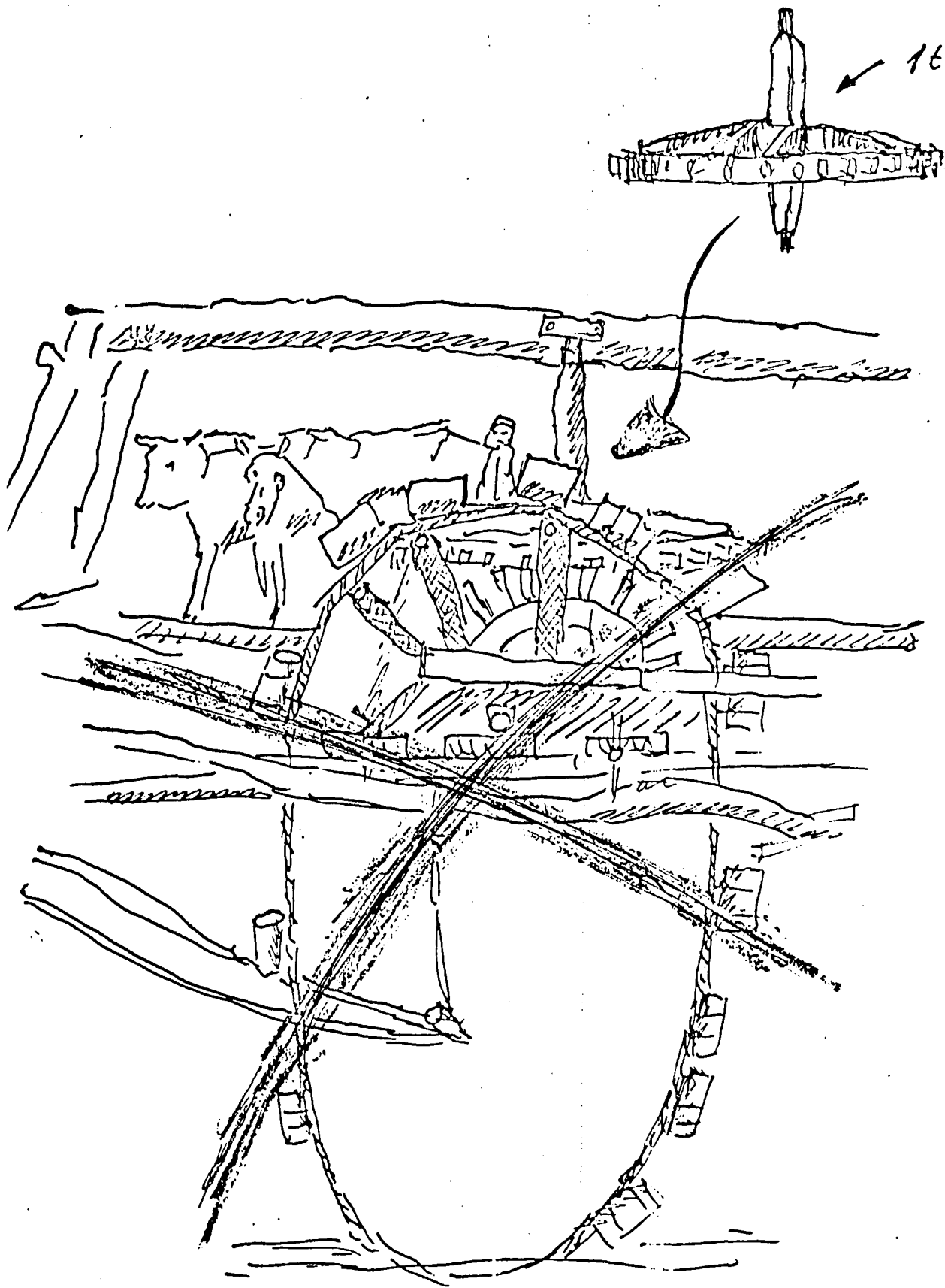

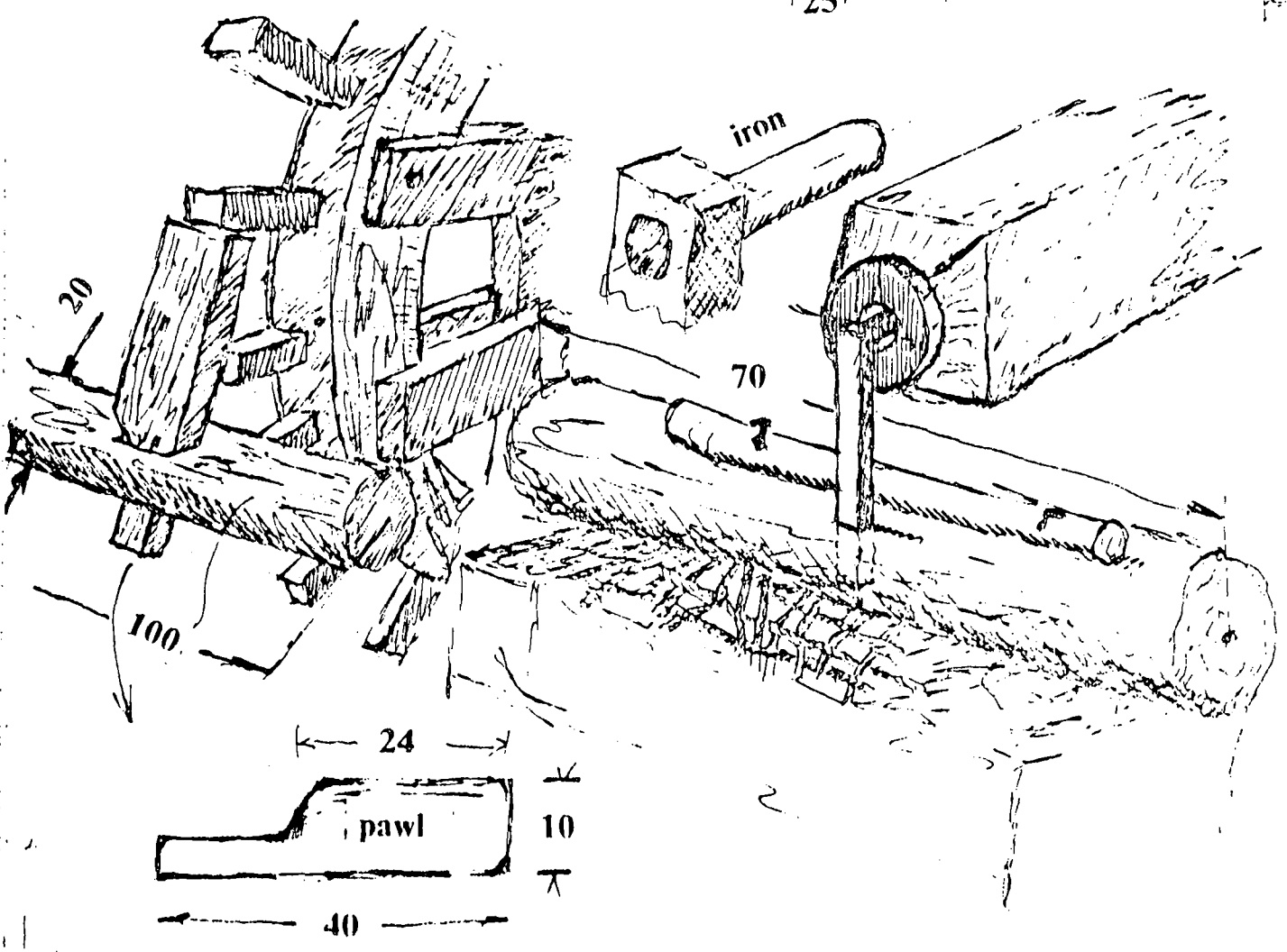
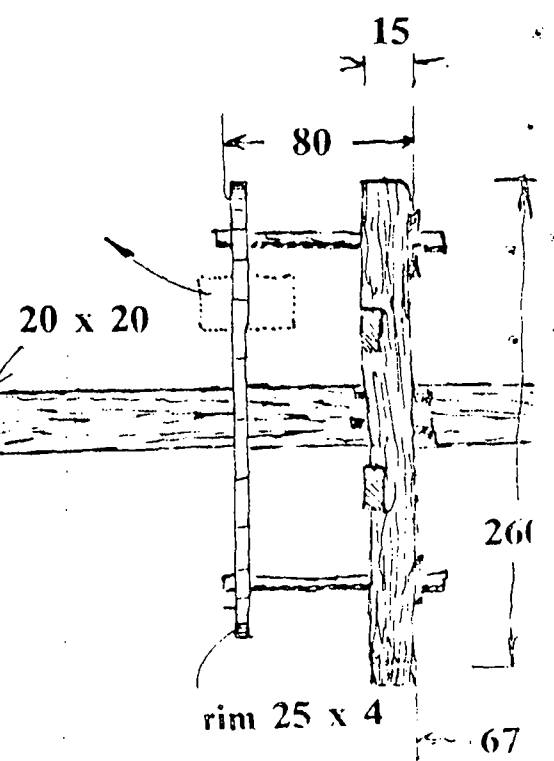
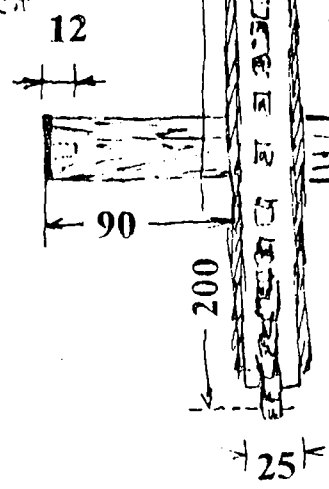
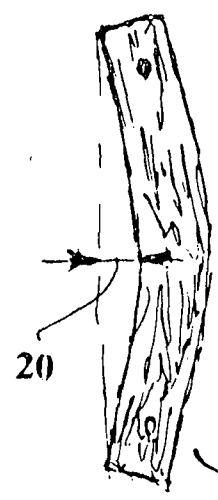
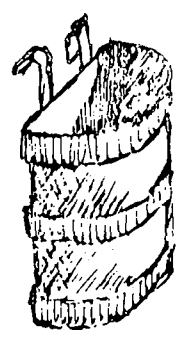
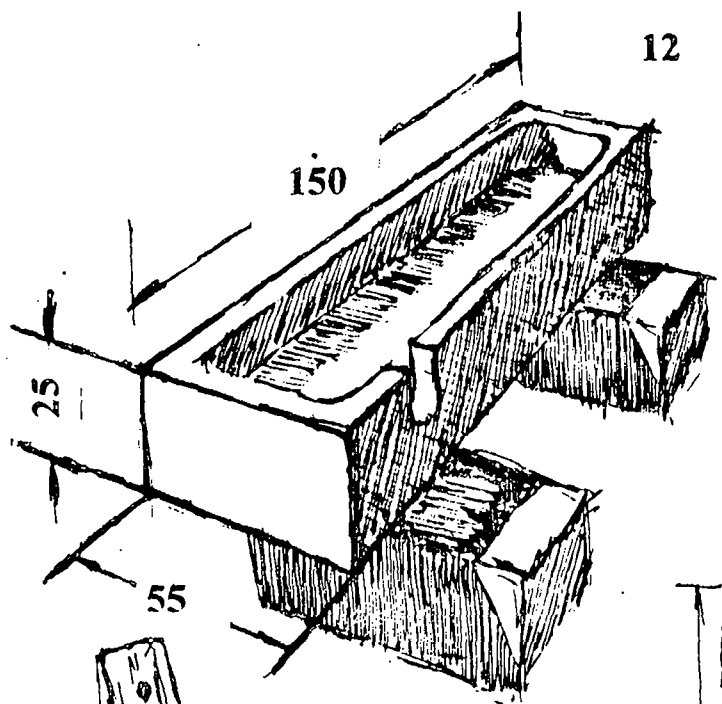

For small lifts requiring a heavy flow this is the best solution. Although it is recorded in the 12th century its application has not spread to many countries, possibly because of the complicated spiral scoop wheel. If this could be manufactured cheaply it would be most valuable.

The shape of the spiral curve has been studied and made in model form in The Hydraulic Research and Experiment Station at the Delta Barrage in Egypt, about an hour by taxi north of Cairo.

13

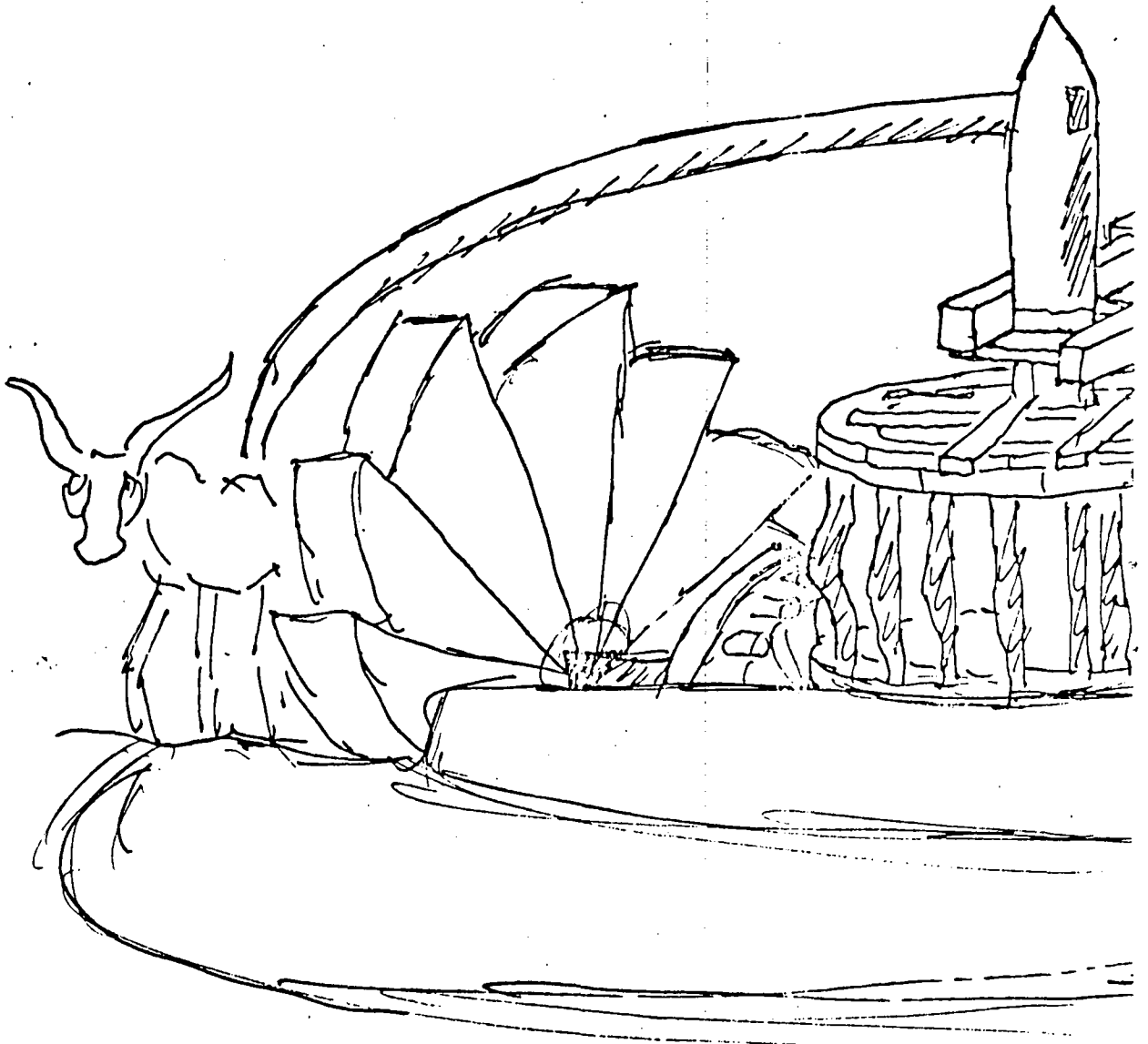

In northern parts of Europe the donkey-wheel has been well known and it is therefore surprising that this machine has not found its way to small scale irrigated farms. The input required is rather small and a man could easily replace the donkey in performing the same function.

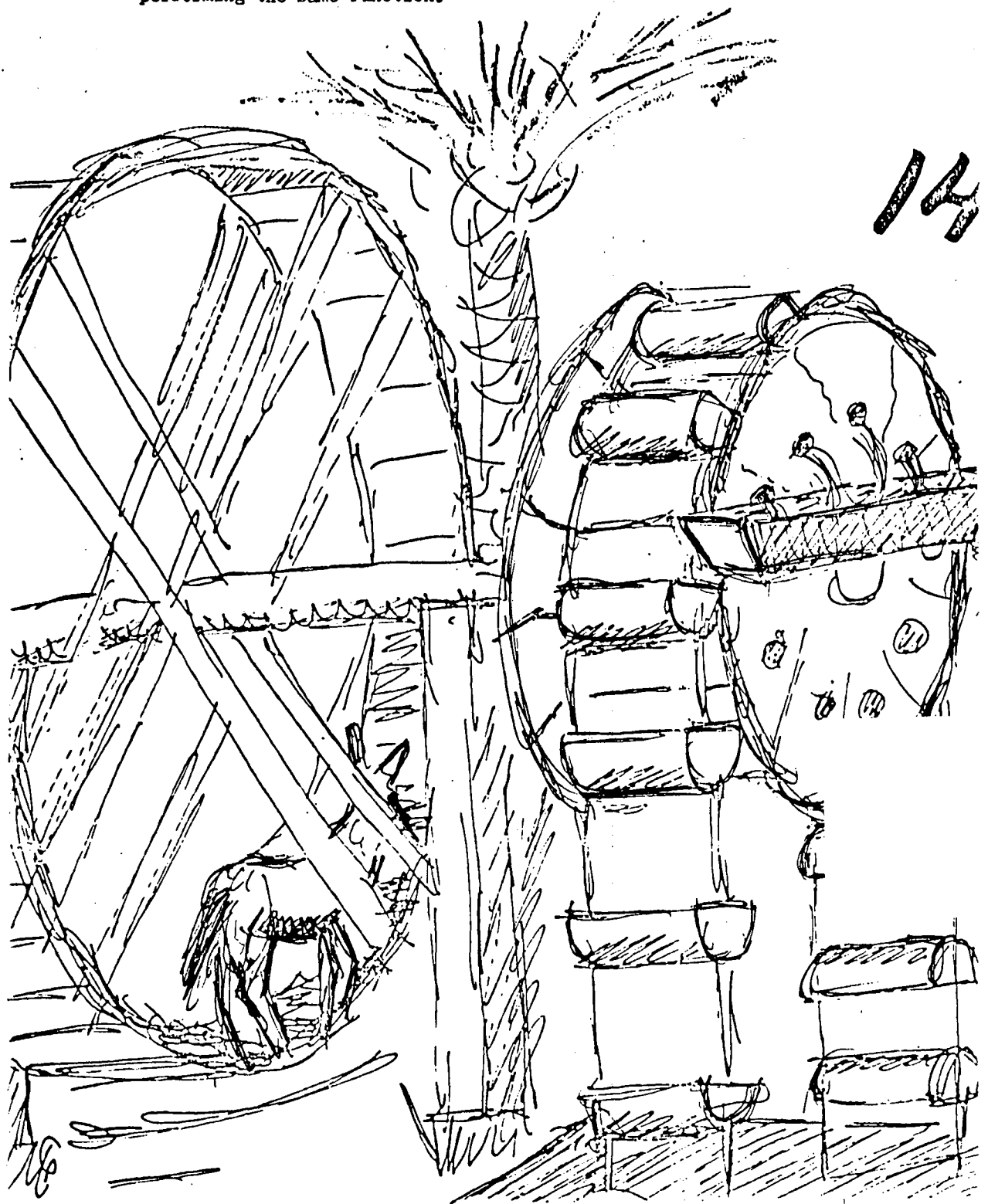

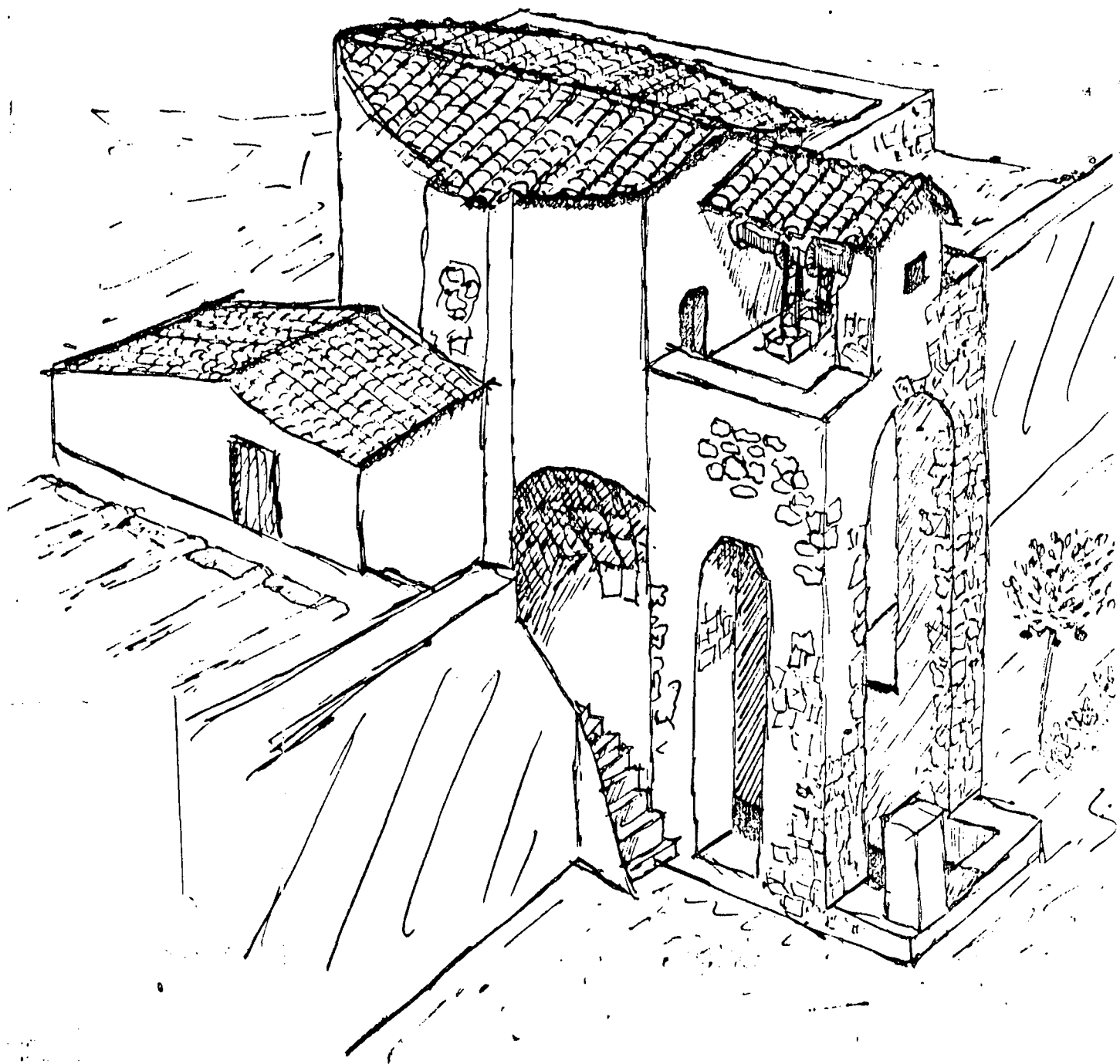

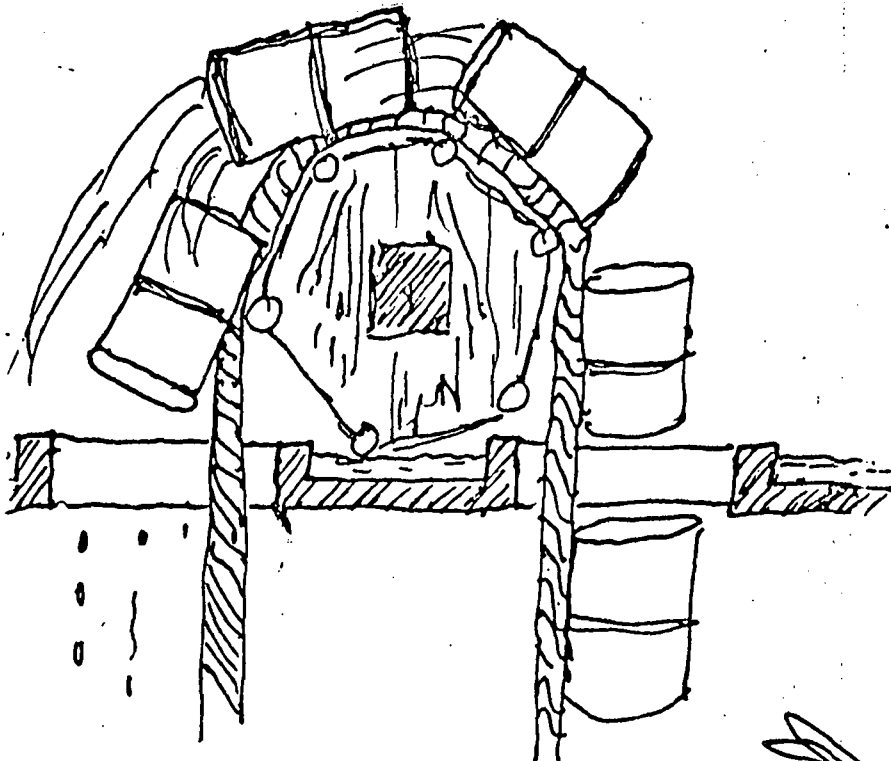

This sketch is given to present a solution to the problem of having a potgarland in a slender well.

This system was known in Italy and Syria.

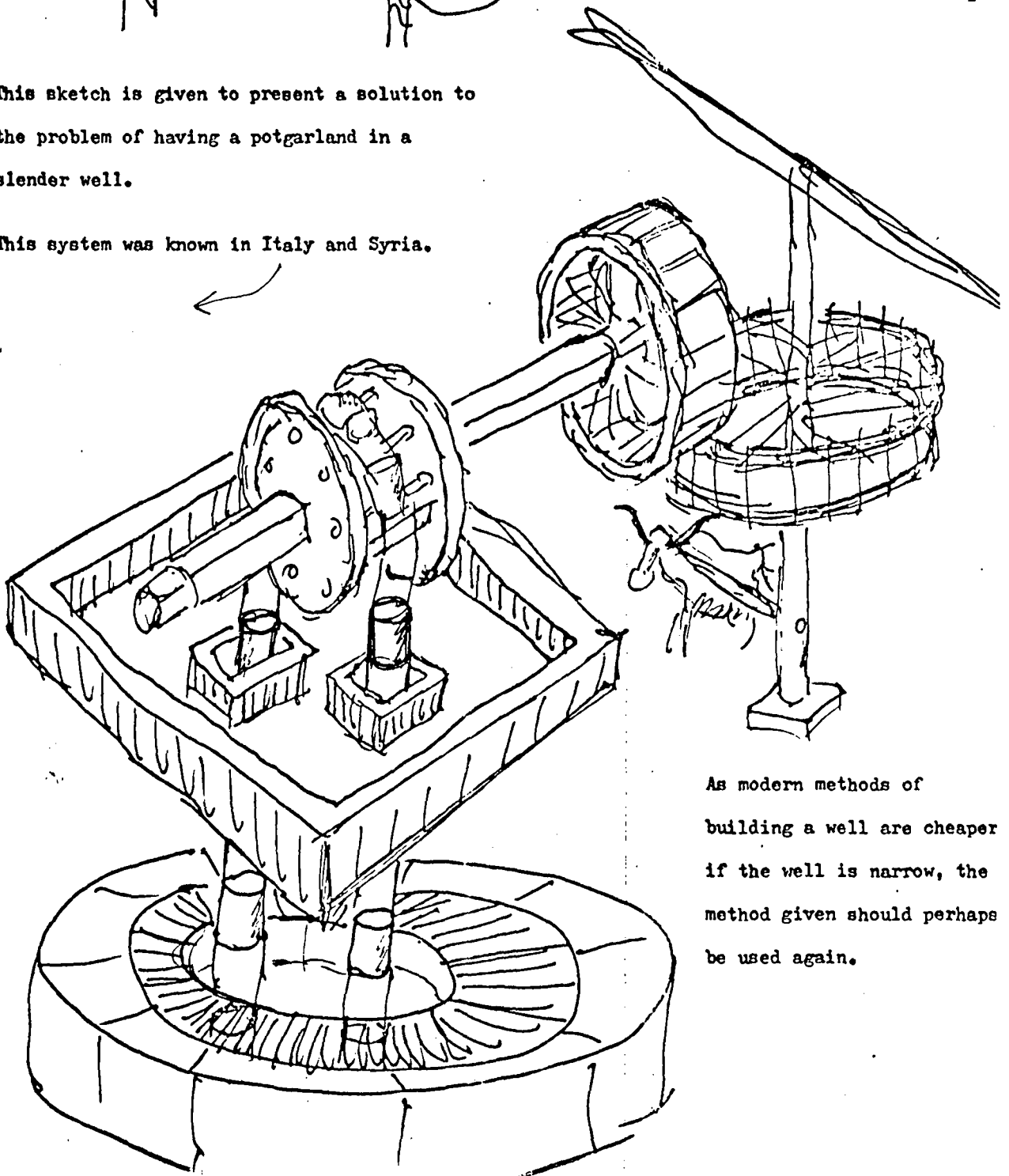

As modern methods of building a well are cheaper if the well is narrow, the method given should perhaps be used again.

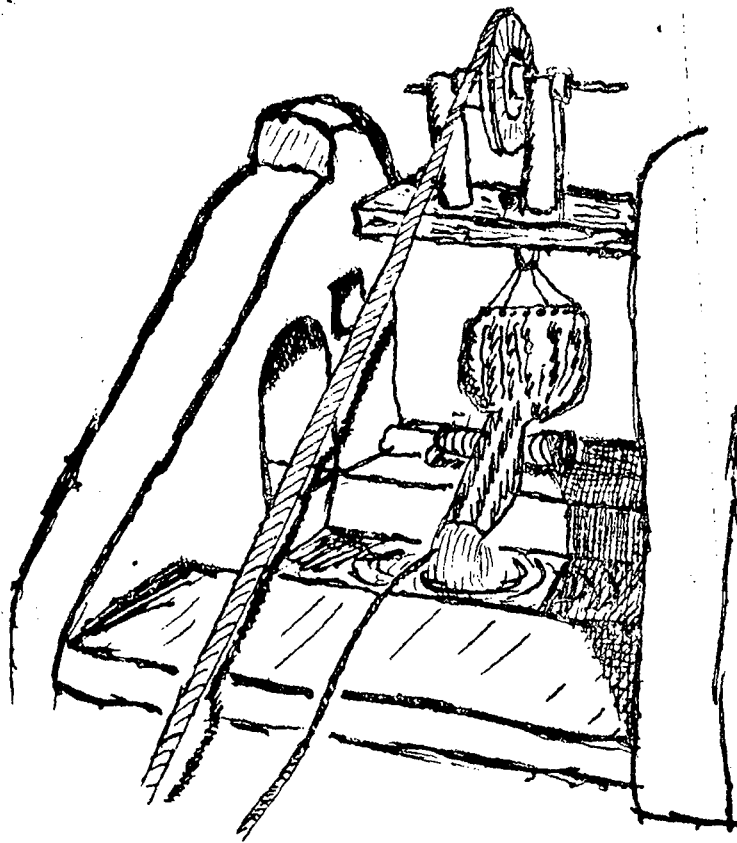
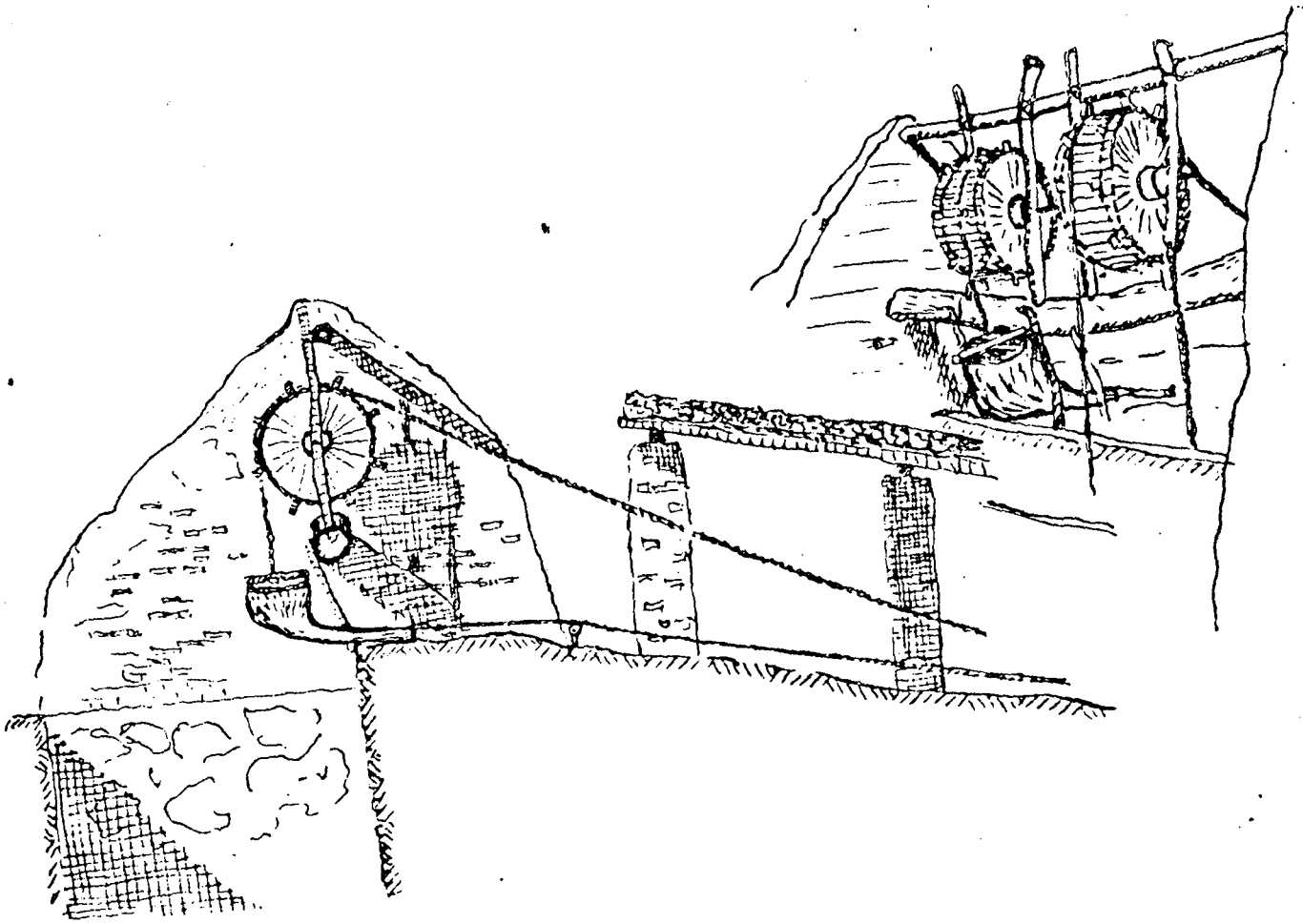

FAD

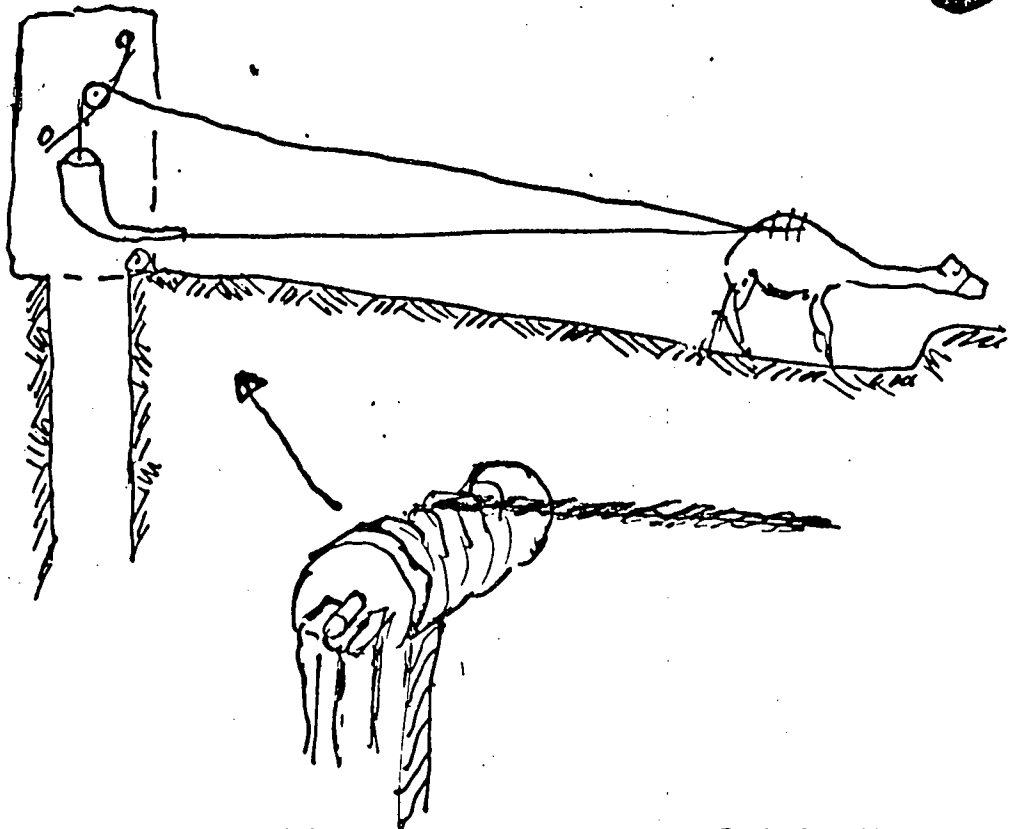

The self-emptying sack method is well known from Algeria to India but it is rather an ineffective device. The drawing given shows the moment when the animals turn around. This is a most unproductive operation. There is no doubt that the Persian wheel with the camel could do the same work alone without the cow and two donkeys depicted in the drawing.

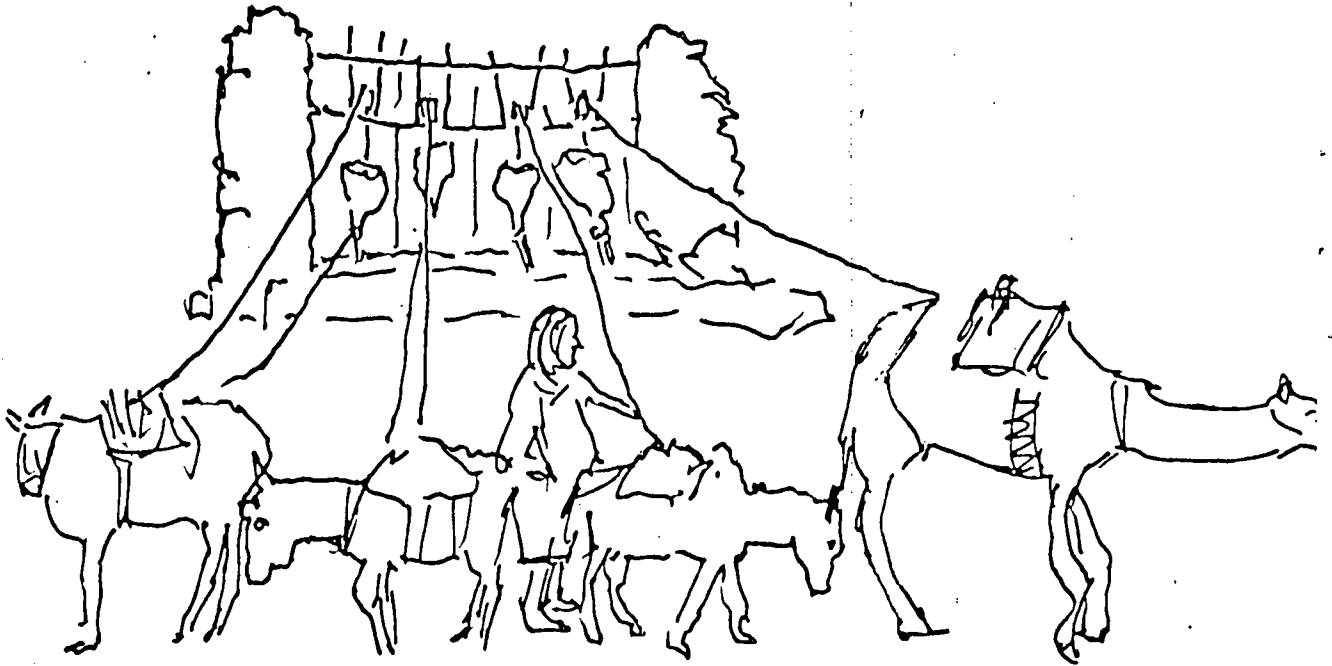

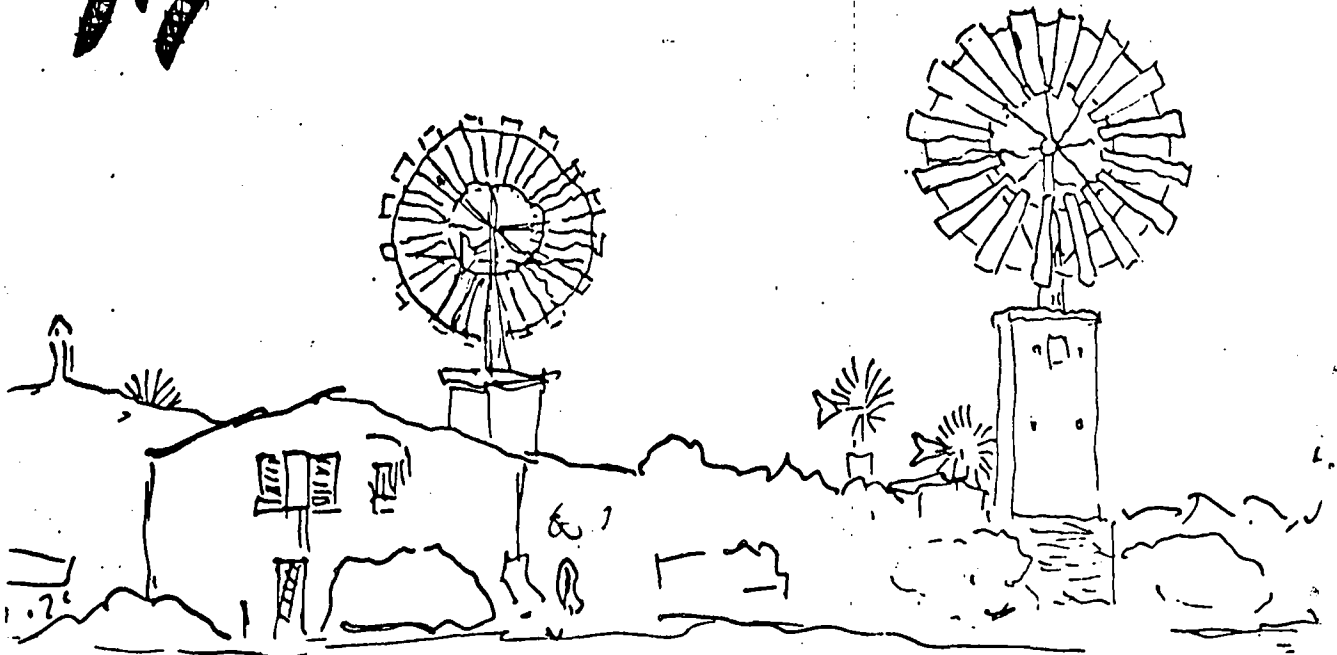

Wind should of course replace the animal but very few places have this power available at the time of need for irrigation. The upper drawing is a view from Majorca. The lower is the valley of 10 000 windmills in Crete. However, there are windmills in all flat coastland areas of the Mediterranean. The upper windmill is industrially made, the lower is homemade.

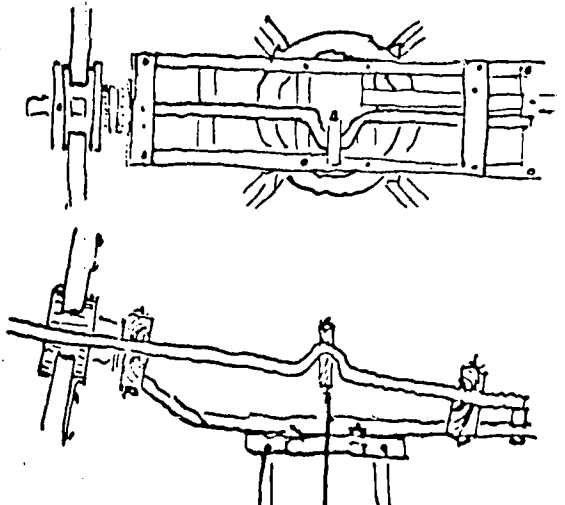
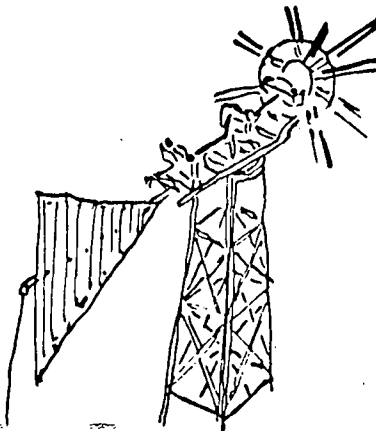
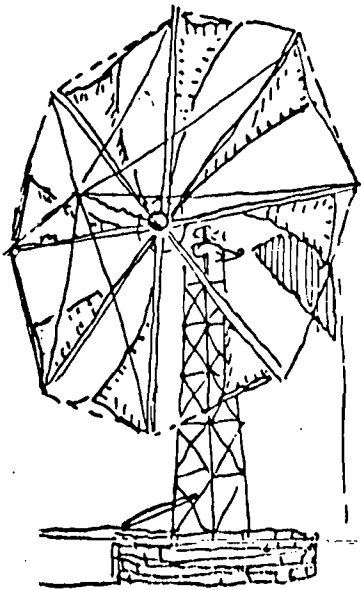
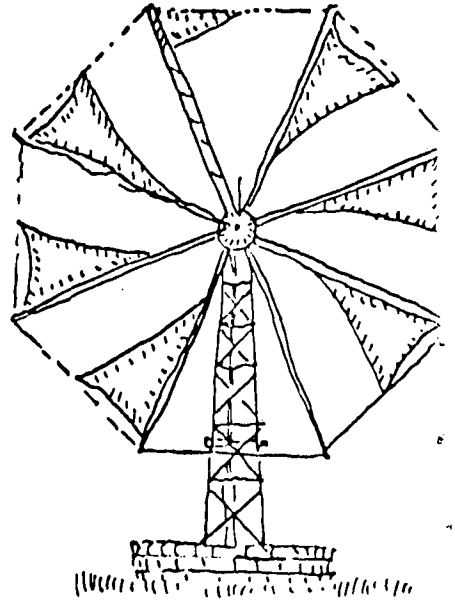
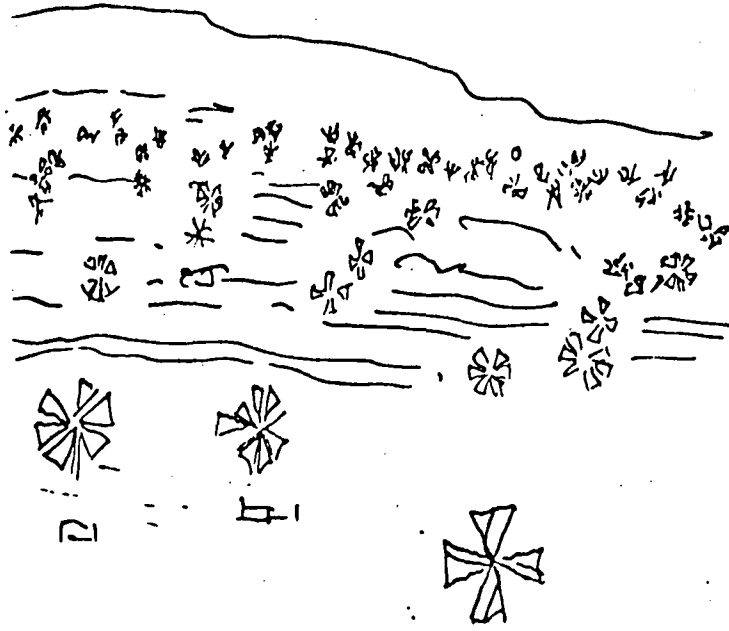

18

In Thailand south of Bangkok this propellor engine spins. From an aerodynamic point of view this is a far better solution than the windmills illustrated in No. 17.

The given arrangement assumes that the wind always blows from the same direction, within about 45 degrees. If some sort of angle-gear is used the wind may come from any direction.

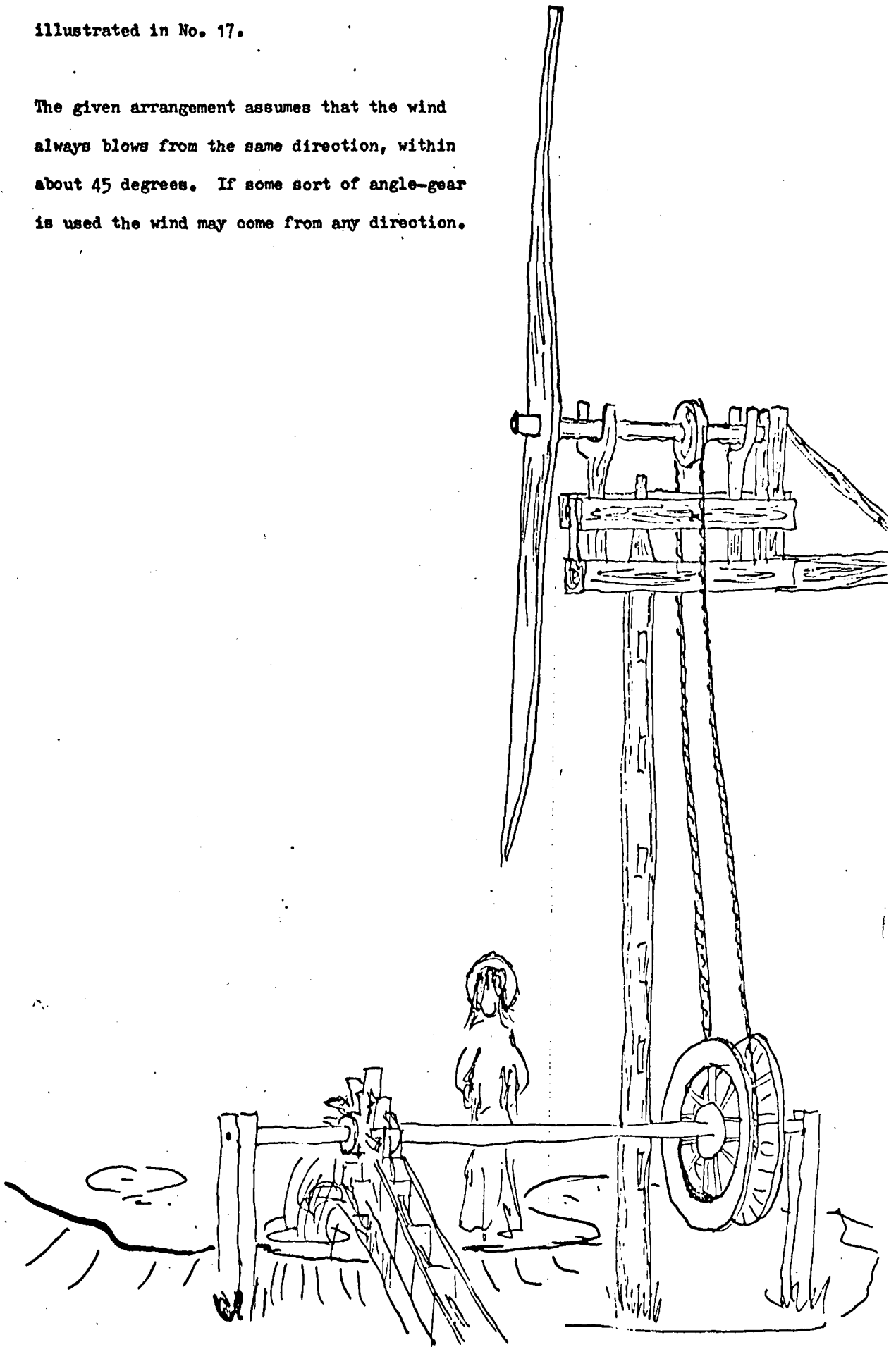

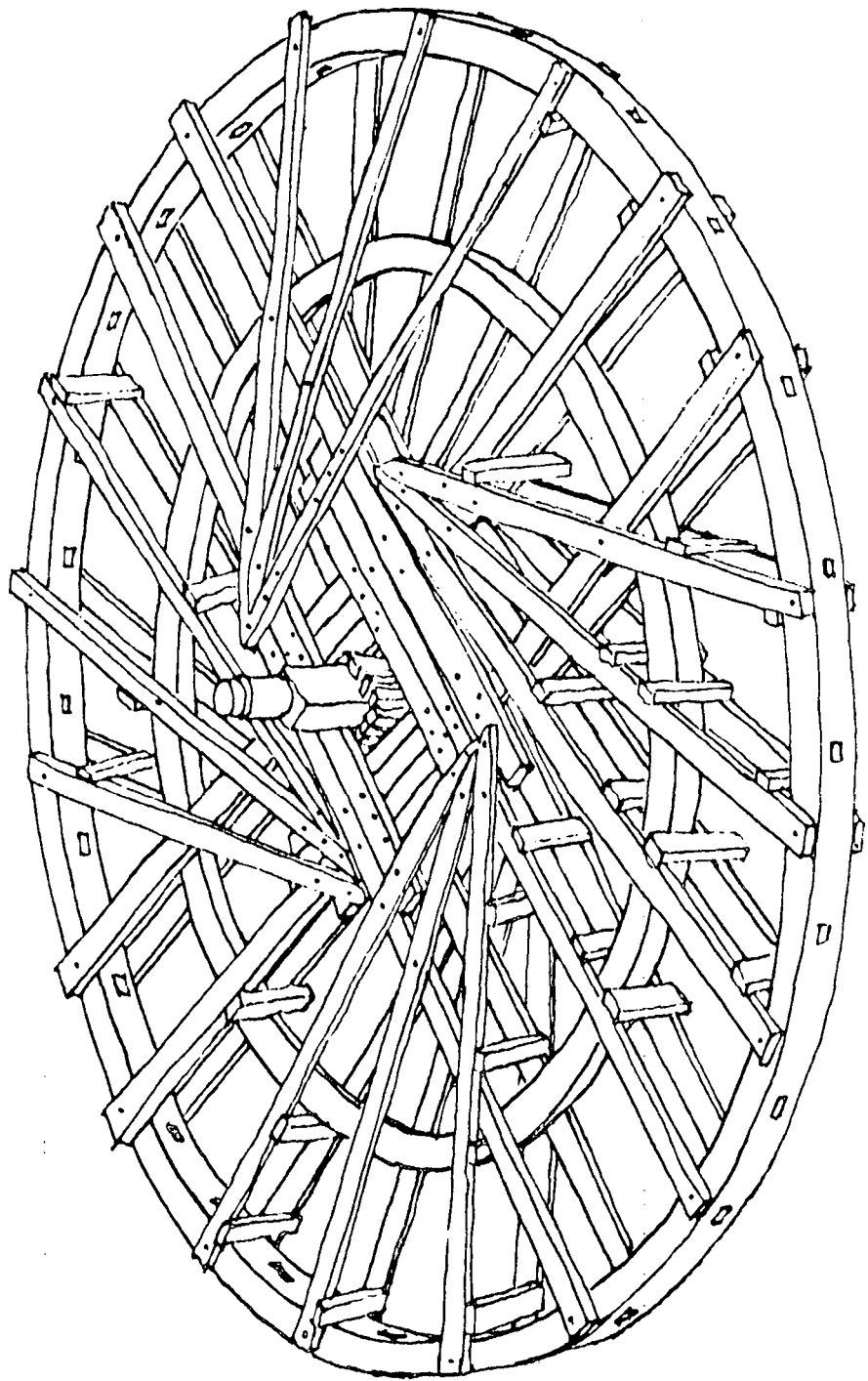

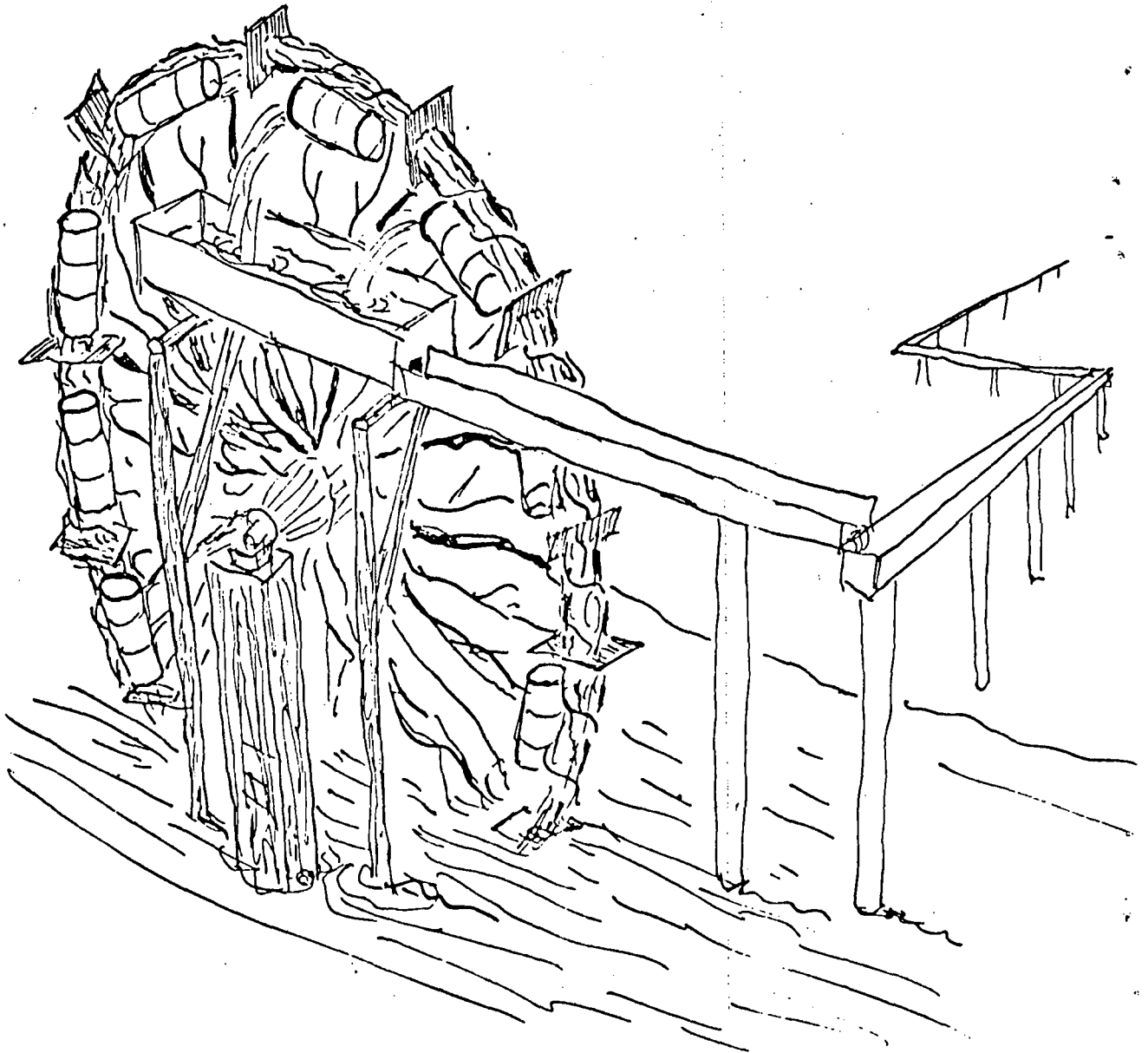

Another cheap source of power is the river flow.

There are wheels of a high standard of workmanship, but because the shape of the wheel will change due to swelling on entering the water, this is not always an important criteria. In fact a wheel made of branches tied together is less sensitive.

It should be remembered that the bucket should be slender in shape as this lifts more water to the top of the wheel. A low, fat bucket will waste most of its content long before passing the top of the circle.

This device has only been described to me and I think it is a new invention. If so this is the path we should follow in the future.

As the idea is of a rather pure form the whole construction could be treated with the theory of dynamics and hydro-dynamics. The shape of the dipper may then be optimized by computation.

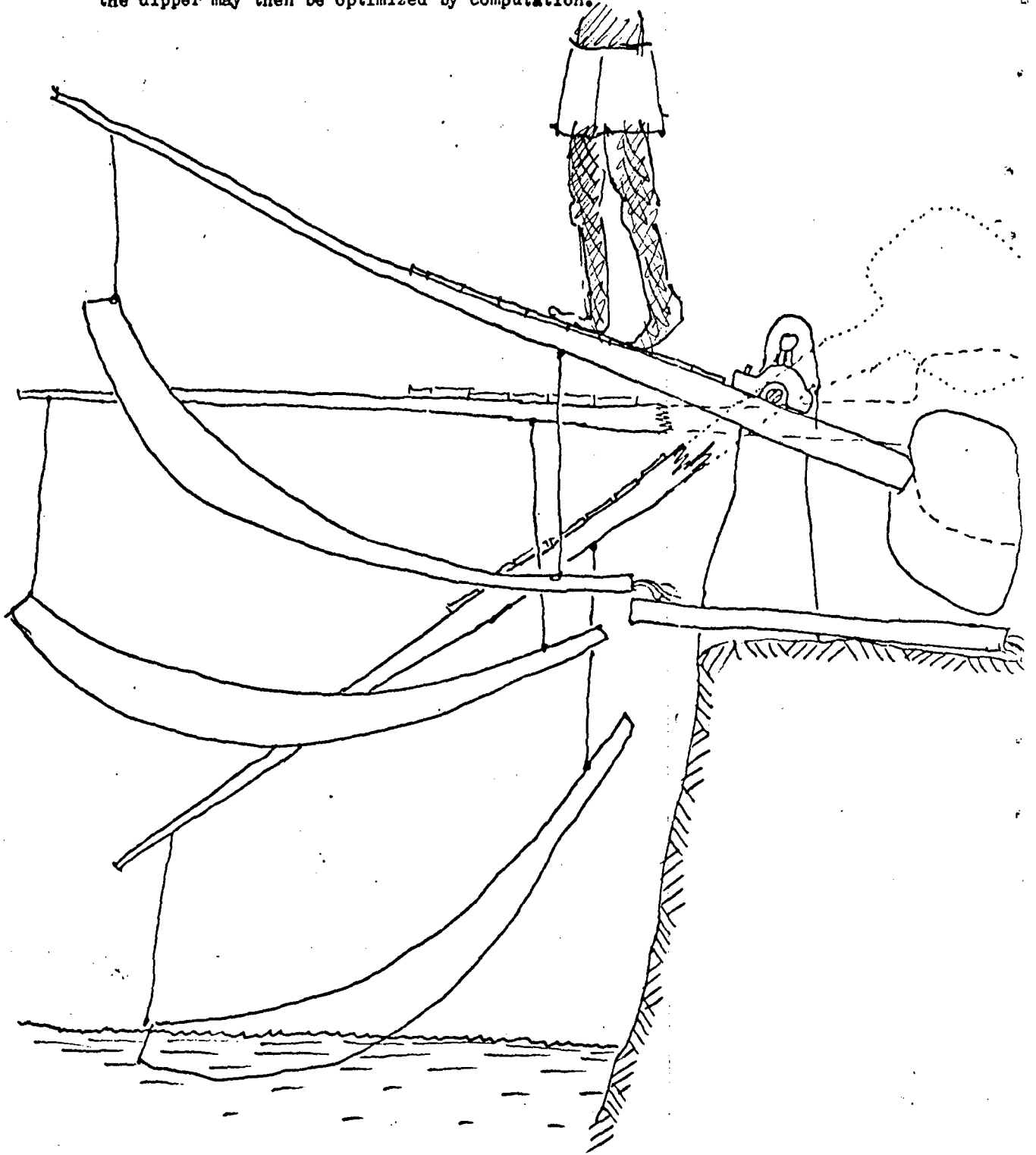

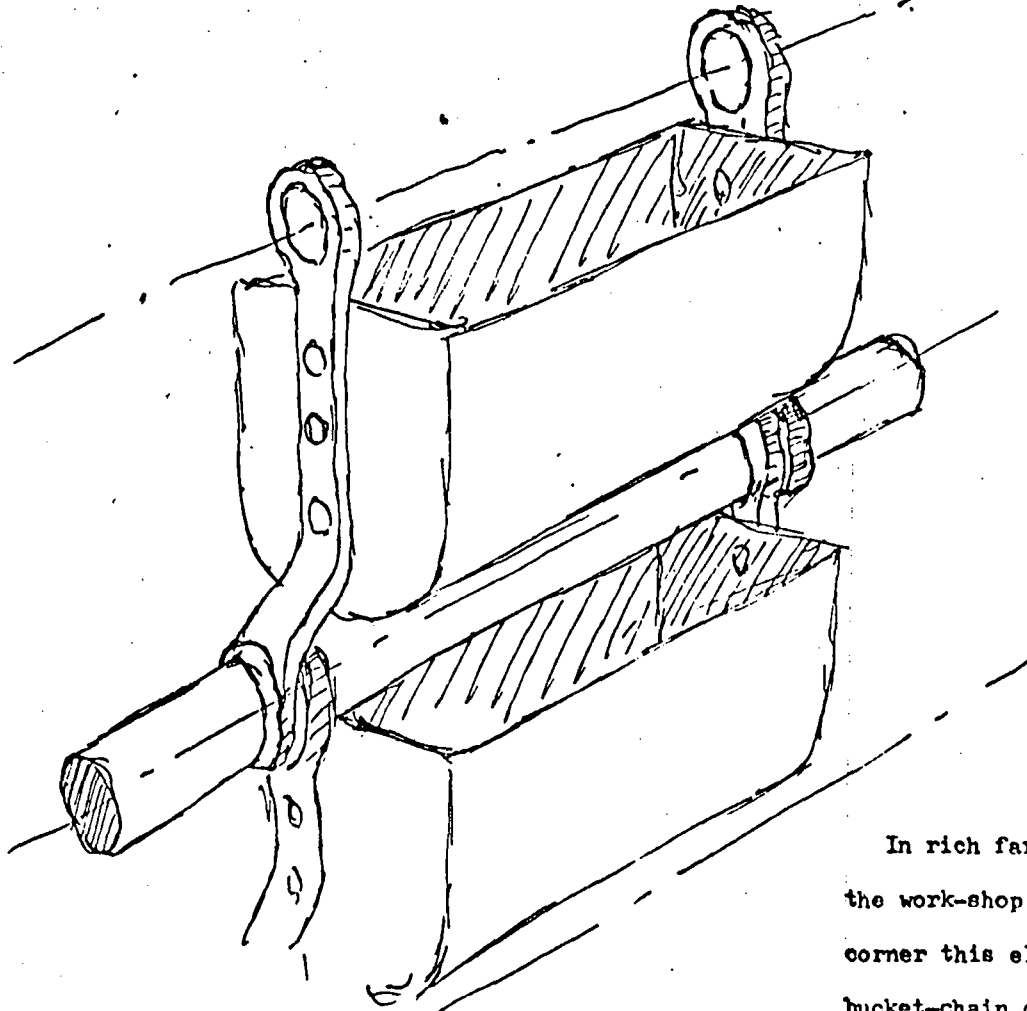

In rich farmland areas where the work-shop is just around the corner this electric powered bucket-chain construction is the solution for the small scale irrigation plant. It surpasses the centrifugal pump which is subject to leakages or can become silted up with sand.

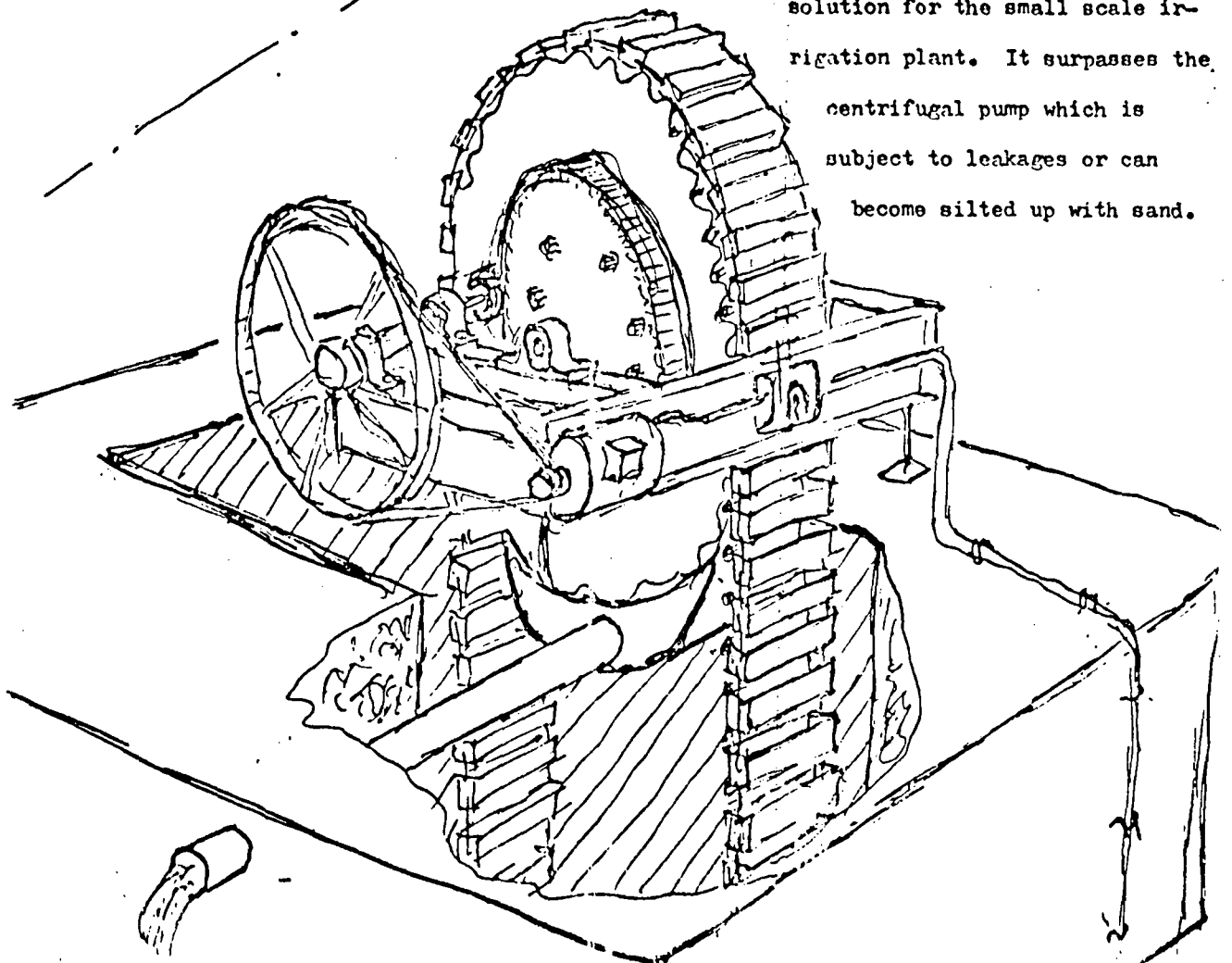

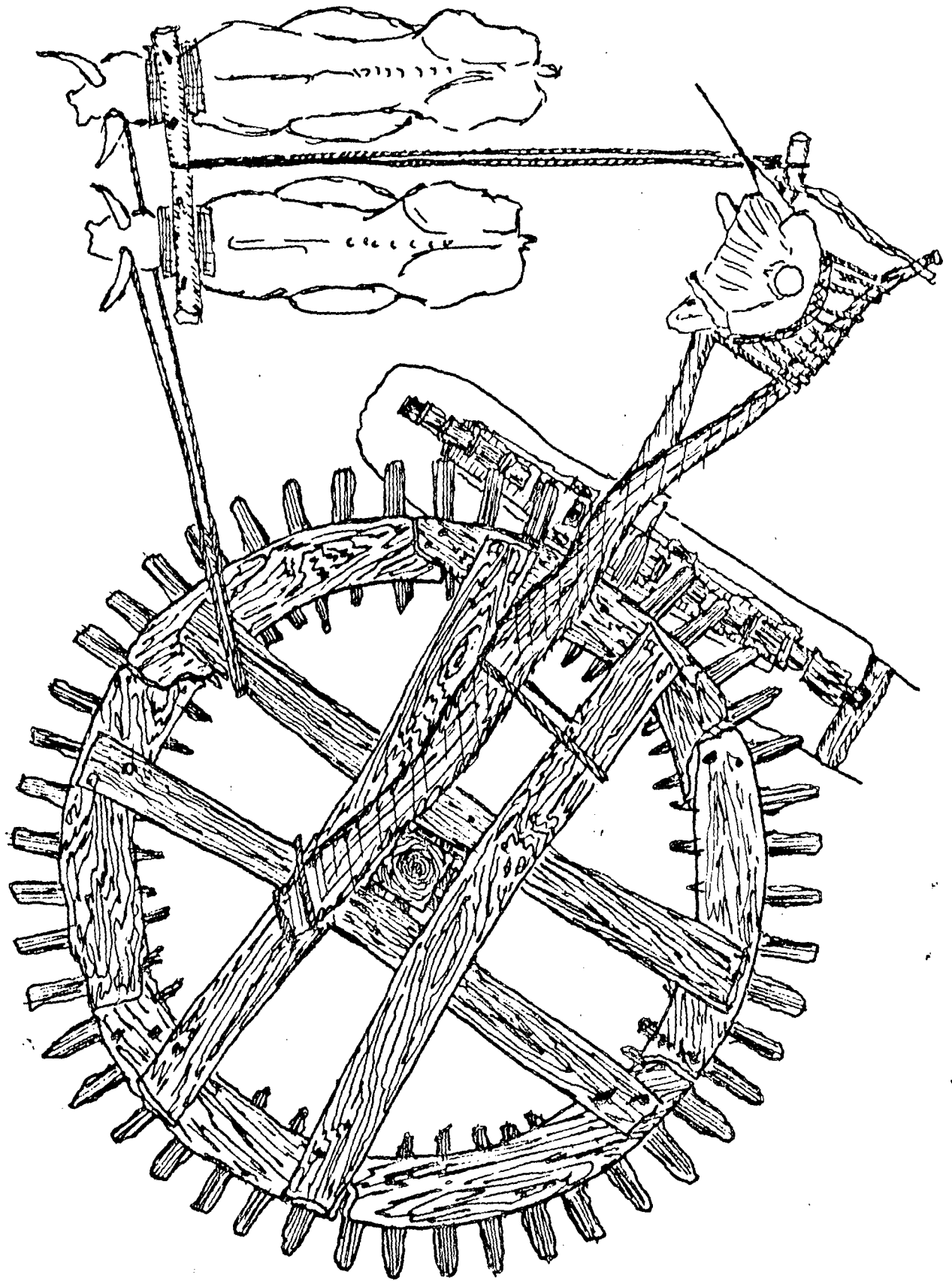

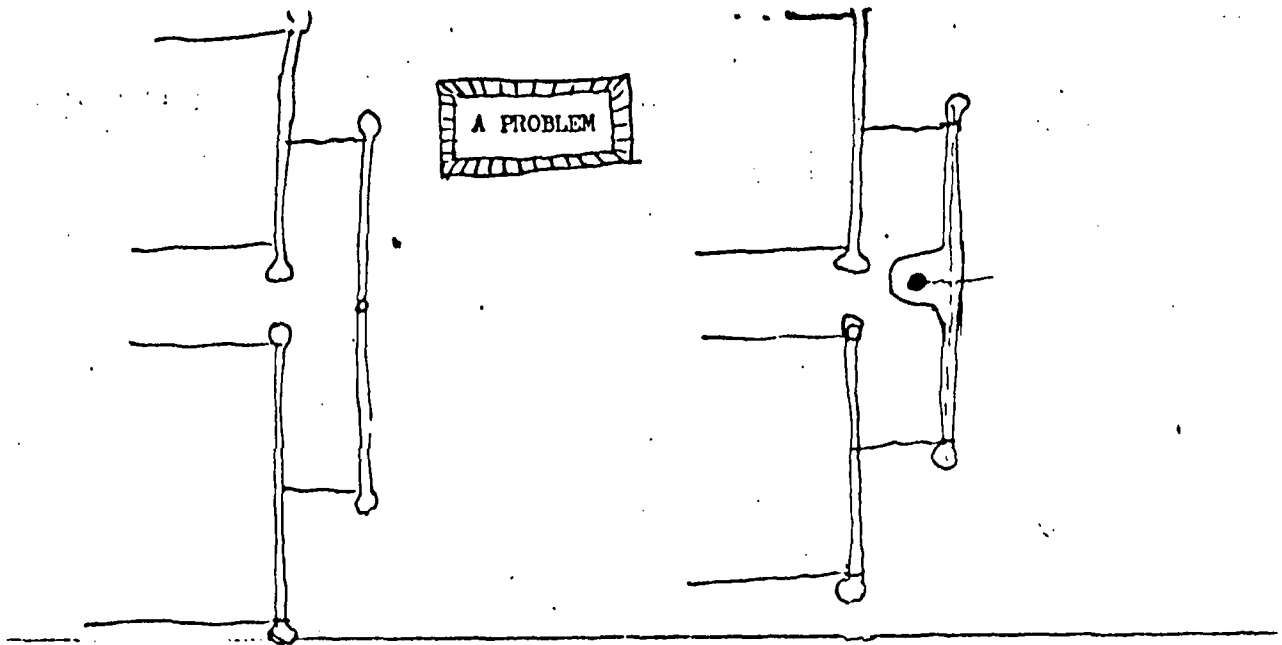

The pair harness substituted by a double arrangement.

Hard-working horse

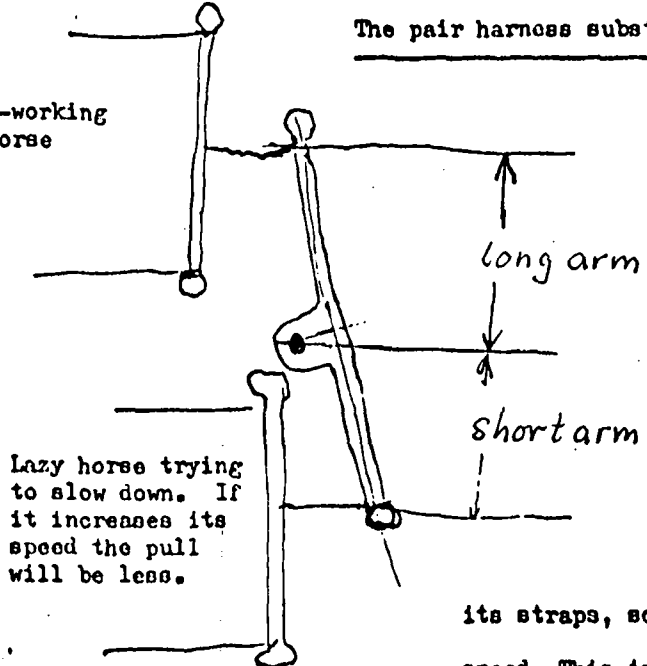

Lazy horse trying to slow down. If it increases its speed the pull will be less.

22

If two horses are drawing a carriage their traction is transformed to one force by the swingletree. If one of the horses becomes lazy it should be punished in some way, usually by increasing the tension of

its straps, so that it will return to its original speed. This is effected by using a singletree whose

pivoting point is outside the connecting line which could be drawn between the two points where the forces are acting. The Persian wheel has no such solution. Here the two bullocks are as a pair and impede each other. They are walking at different speeds and the neckyoke is newer in balance. The situation would be improved if the bullocks

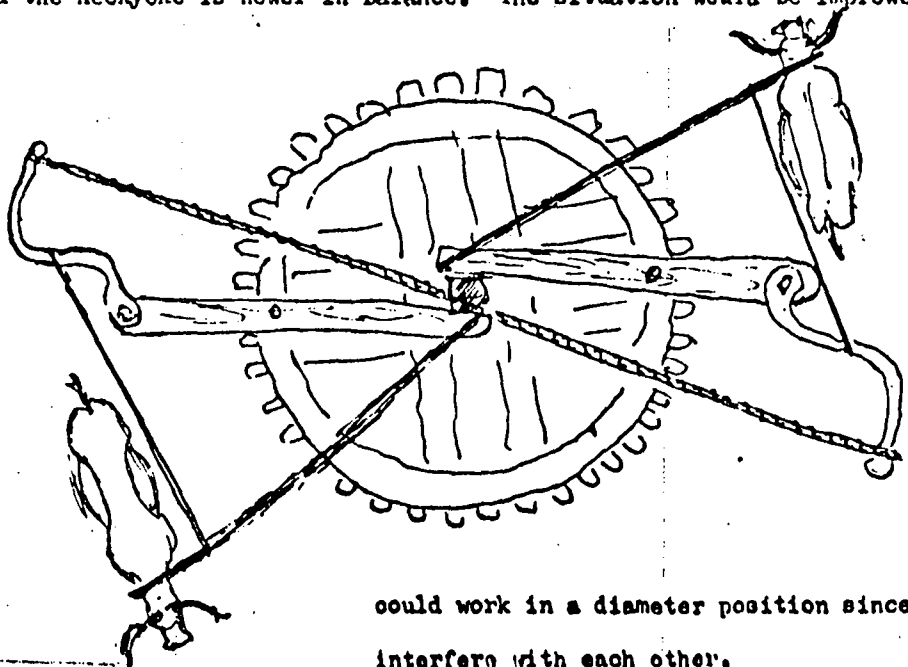

could work in a diameter position since they would not interfere with each other.

JORGE DIAS

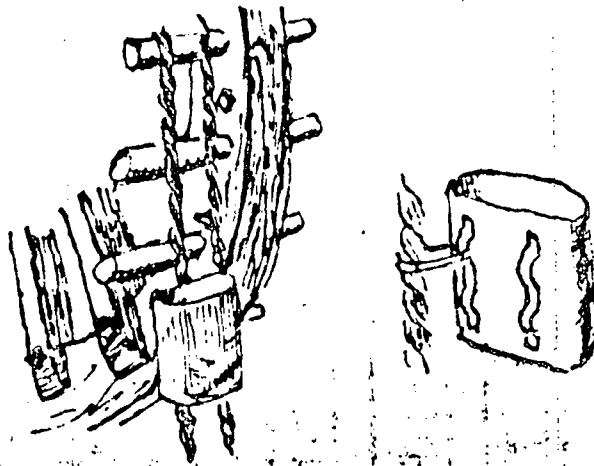
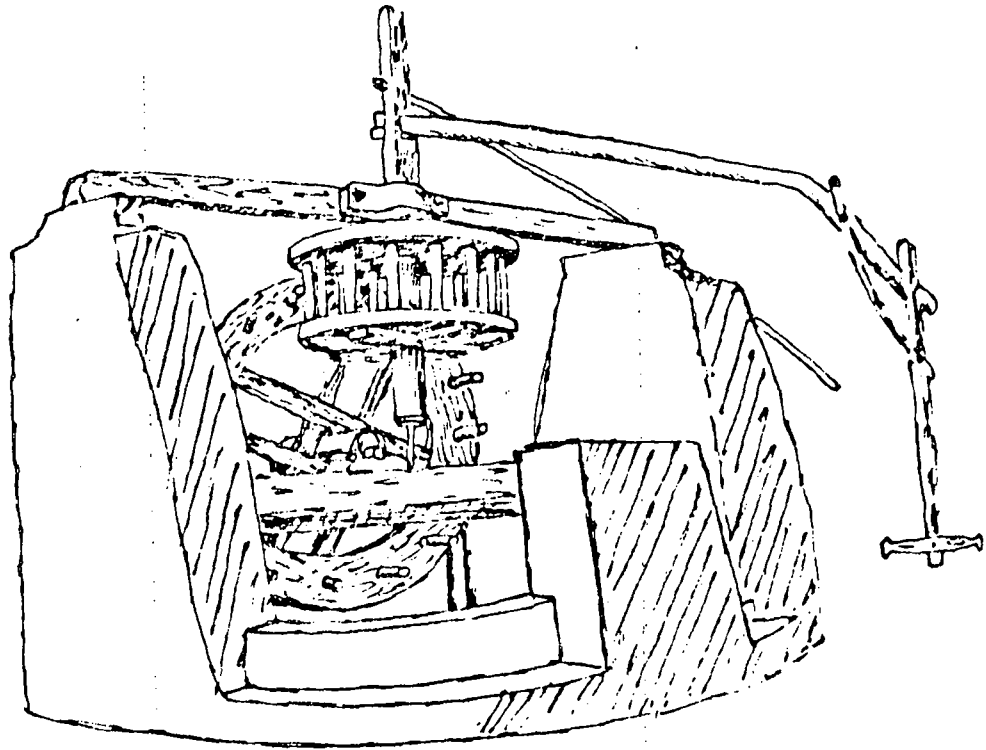

NED

IMPORTANT REFERENCES not mentioned in the FAO publication of 1956.

Jorge Dias (died in 1974) y Fernando Galhano: Aparelhos de elevar a água de rega (Water-lifting devices for irrigation). Porto 1953 (Portugal)

This is the most important book on the subject and there is a gap between this book and all the others mentioned.

Julio Caro Baroja: Norias, azudas, aceñas. To be found in Revista de dialectologia y tradiciones populares, vol X, (Madrid 1954) pp.29-160.

Julio Caro Baroja: Sobre la historia de la noria de tiro (History of the animal-powered noria). In same Revista as above but in vol. XI pp 15-79.

Joseph Needham: Science and Civilisation in China. Vol. 4 Part II. Cambridge University Press 1965 pp. 330-362.

Those who are interested in the history of these machines may wish to consult:

Thorkild Schioler: Roman and Islamic Water-lifting Wheels. Odense University Press 1973. 200 pages and more than 100 drawings.



۱۹۸۰.۰۲.۰۲

موسسه تحقیقاتی کشاورزی
تهران

۶۶