

UNDP Project GLO/78/004

Executed by  
The World Bank

2 . 4  
S M

SMALL-SCALE  
SOLAR-POWERED  
IRRIGATION PUMPING SYSTEMS  
TECHNICAL AND ECONOMIC REVIEW

Sir William Halcrow and Partners  
in association with the  
Intermediate Technology Development Group Ltd.

September 1981

(232.4-015M )

232.4  
81 SM



# SIR WILLIAM HALCROW & PARTNERS

CONSULTING ENGINEERS

BURDEROP PARK SWINDON WILTSHIRE SN4 0QD

HEAD OFFICE: SHORTHANDS LONDON W6 8SH

TELEPHONE 0793 812479

CABLES PROPRIETORS SWINDON WILTS

TELEX 44044 CA BHAI WIL G

OUR REF WE/SSP/6/A125 YOUR REF

Dr E Mitwally  
World Bank  
1818 H Street  
Washington DC 20433  
USA

LIBRARY KD 4100  
International Conference Centre  
for Community Water Supply

Dear Dr Mitwally

UNDP/GLO/78/004  
SMALL SCALE SOLAR POWERED IRRIGATION PUMPING SYSTEMS

I have pleasure in enclosing ten copies of the second part of our Final Report on Phase I of the UNDP Project under the title "Small Scale Solar Powered Irrigation Pumping Systems: Technical and Economic Review". This document supersedes the State of Art Report first submitted to you under cover of our letter dated 21 January 1980.

The final text is based closely upon a draft prepared for and circulated at the UNDP/World Bank Workshop on Solar Pumping in Developing Countries held in Manila, Philippines in June 1981. It has been extensively edited since then to take account of points made at the Workshop, in discussion with yourselves and your colleagues at the Bank, and our own advisors.

As agreed with you and Mr Dosik the Review includes an extensive section on System Economics which in view of its importance has been placed in a separate chapter in the final text, under the title "Economic and Technical Feasibility".

For the convenience of readers the Executive Summary of the Phase I Project Report is included as an Appendix.

I believe that this Technical and Economic Review will provide a valuable reference for all those concerned with solar powered water pumping and trust it satisfactorily fulfils your requirements.

Yours sincerely

A M Muir Wood

MANAGER	A M MUIR WOOD	M J DE BEAUFORT	J J FARRE	J LEE WOOD	J A CHAMMAN
	P J D MANSFIELD	D B BIRCHALL	D J EDWARDS	H S DARTER	B K HARTSHORN
	A J TAYLOR	R G CAYLER	R K HAYWARD	A J ROOPER	John Scott W BOWWELL
	C J ARNOLD	A J HOBBS			
ENGINEER	D B DE BEAUFORT	H G HOBBS	M A HAYWARD	J METCALF	ENGINEER A J APPS
ASSISTANT	P J TASHLY	R A HAYWOOD	M J HAYWARD	H S GRAY	A J CHAMMAN
ASSOCIATE	R J CAMACHO	R J CHAMMAN	F M GIBSON	F J BURGESS	D J FLOYD
	C SUMMERS	Z E CLIFFORD	H E DAVISON	H G JOHNSON	P A S FERGUSON
	W F GALLAGHER	H B SINCLAIR	N A DREIFUS	D HURLEY	J C THORNTON
	C J KIRKLAND	C BUSWELL			
CONSULTANTS	F B ANDERSON	R DE HALGON	P B RAY	G M ROBERTS	



## **TECHNICAL AND ECONOMIC REVIEW**

This Volume was prepared during the UNDP Project GLO/78/004 to test and demonstrate suitable small-scale solar-powered pumping systems. It reviews the use of solar pumps for the irrigation of crops on small land-holdings in developing countries and examines the technical and economic criteria which have to be satisfied if this pumping technology is to be adopted.

This Volume supersedes the State of Art Report completed in December 1979 and submitted to the World Bank on 21 January 1980 (Ref. 1).

A companion Volume "Small-Scale Solar-Powered Irrigation Pumping Systems Phase I Project Report" summarises the work undertaken from July 1979 to May 1981 on field trials, laboratory tests and system design studies which were carried out as part of the UNDP Project. For the convenience of readers the Executive Summary of the Project Report is included in the Review as Appendix 3.

Both Volumes are available from the World Bank.

## **NOTICE**

This report was prepared as part of a project financed by the UNITED NATIONS DEVELOPMENT PROGRAMME and executed by the WORLD BANK. Neither the UNDP nor the WORLD BANK makes any warranty, express or implied, or assumes any legal liability or responsibility for the accuracy, completeness, or usefulness of any information, apparatus, product, or process disclosed, or represents that its use would not infringe privately owned rights. Reference herein to any specific commercial products, process, or service by trade-name, mark, manufacture, or otherwise, does not necessarily constitute or imply its endorsement, recommendation, or favouring by either the UNDP or the World Bank. The views and opinions of authors as expressed herein do not necessarily state or reflect those of the UNDP or WORLD BANK.

## CONTENTS

	Page No.
<b>Executive Summary</b>	(i)
<b>1. Introduction</b>	<b>1</b>
1.1 Background to Review	1
1.2 UNDP/World Bank Project	1
1.3 Context of Review	2
1.4 Scope of Review	3
<b>2. Role of Small-Scale Solar Pumping for Irrigation</b>	<b>4</b>
2.1 The Increasing Importance of Irrigation	4
2.2 The "Energy Crisis" and Irrigation	4
2.3 Small-Scale Irrigation	6
2.4 Power Requirements for Irrigation	7
2.5 Pumping Methods Available	12
2.6 The Suitability of Solar Pumps for Irrigation	16
2.7 Size and Efficiency Considerations for Solar Pumps	17
2.8 Alternative Applications for Solar Pumps	26
<b>3. Economic and Technical Feasibility</b>	<b>30</b>
3.1 Introduction	30
3.2 System Economics	30
3.3 Technical Requirements	50
3.4 The Importance of Local Manufacture	55
<b>4. Solar Pumping Technology – Photovoltaic Systems</b>	<b>58</b>
4.1 Photovoltaic Cells	58
4.2 Existing Photovoltaic Pumping Installations	64
4.3 Photovoltaic Pumping Systems	64
4.4 Photovoltaic Arrays	67
4.5 Electric Motors	78
4.6 Batteries	80
4.7 Pumps	81
4.8 Mechanical Transmissions	90
4.9 Photovoltaic Pumping System Optimisation	91
4.10 Power Conditioners and Maximum Power Point Trackers	95
4.11 The Project Design Study Mathematical Model	99
4.12 Results obtained from Model Testing	103

	<b>Page No.</b>
<b>5. Solar Pumping Technology - Thermal Systems</b>	<b>110</b>
5.1 History	110
5.2 Existing Solar Thermal Pumping Installations	113
5.3 Thermal Efficiency of Heat Engines	113
5.4 Solar Thermal Collectors	114
5.5 Rankine Cycle Engines	118
5.6 Stirling Cycle Engines	124
5.7 Transmissions and Pumps	127
5.8 Laboratory Testing of Thermal Systems	127
5.9 Thermal System Design Studies	130
<b>6. Other Solar Pumping System Options</b>	<b>145</b>
6.1 Introduction	145
6.2 Thermo-electric Generators	145
6.3 Thermionic Generators	146
6.4 Brayton (Gas Turbine) Solar Thermal Systems	146
6.5 Photochemical Systems	146
6.6 Improved Efficiency Photovoltaic Technology	146
6.7 Memory Metal Heat Engine	147
6.8 Osmotic Pressure Engines	147
<b>7. References</b>	<b>149</b>
<b>Appendices</b>	
1. Preliminary estimates of costs of solar pumping systems in developing Countries	A1
2. General Recommendations for the development of Small-Scale Solar Pumping Systems	A7
3. Executive Summary of Project Report	A15
4. Objectives of and Preparation for Phase II of the Project	A31

## LIST OF TABLES

Table	Title	Page No.
1.	Irrigated Areas of the World in 1972	5
2.	Irrigation Water Demand and Solar Energy Availability for Cotton-Wheat Cropping Pattern (Lake Chad Region)	10
3.	Comparison of Principal Methods of Irrigation Pumping	13
4.	Parameters for Baseline Model	32
5.	Comparison Between Computed Costs of Solar and Engine Pumps (Baseline Model)	36
6.	Results of Sensitivity Analysis	38
7.	Small-Scale Solar Pumping Installations	61 - 63
8.	Results of making Improvements to a PV Pumping System by using the Mathematical Simulation Model	109
9.	Large-Scale Sofretes Solar Thermal Pumping Installations	111
10.	Solar Collector Types used in Thermal Design Studies	133
11.	Example of Thermal System Costing	134
12.	Results of Thermal System Mathematical Modelling	137

**Appendix 3 includes the following tables:**

I	Field trials - solar systems costs and data collected
II	Summary of system field performances
III	Laboratory tested systems and components
IV	Sensitivity analysis for pumping systems
V	Results of making an improvement for pumping system by using the mathematical simulation model



## LIST OF FIGURES

Figure	Title	Page No.
1.	Solar Energy Availability and Crop Irrigation Water Demand (Lake Chad region)	11
2.	Feasible Options for Solar-Powered Pumping Systems	15
3.	Power Output Requirements for Various Heads and Delivery Rates	19
4A	Variation of Irradiance Level Received by a Fixed Collector at Optimum Inclination	22
4B	Variation of Irradiance Level Received by a Sun-Tracking Collector	22
5A	Variation of Irradiance Level Received by Collector Repositioned Once per Day	24
5B	Variation of Irradiance Level Received by Collector Repositioned Twice per Day	24
6.	Losses in a Typical Solar Photovoltaic Pumping System	27
7.	Losses in a Typical Solar Thermal Pumping System	28
8.	Effects of Inflation and Discount Rate on Annual Cash Flows 1981-2000	40
9.	Results of Sensitivity Analysis on Solar Pumps	41
10.	Effects of Pumping Head on Water Unit Costs	43
11.	Effects of Water Demand on Water Unit Costs	45
12.	Photovoltaic Module/Array Price Goals and History (in 1980 \$)	59
13.	Schematic Arrangement of a Photovoltaic Solar Pumping System	65
14.	Silicon Solar Cell	66
15.	Voltage - Current and Voltage-Power Characteristics of a Silicon Solar Cell	66
16.	Dependence of Efficiency, $I_{SC}$ and $V_{OC}$ on Cell Temperature	68
17.	Effect of Cell Temperature on V-I Characteristic	68
18.	Effect of Change in Irradiance on V-I Characteristic	68
19.	Cadmium Sulphide Solar Cell	73
20.	Shottky Barrier (MIS) Solar Cell	73
21.	Gallium Arsenide Solar Cell	73
22.	Methods of Concentrating Sunlight on Photovoltaic Cells	75
23.	Typical dc Permanent Magnet Motor Performance	79
24.	Typical Centrifugal Pump Performance	82
25.	Centrifugal Pump Performance with Flat Speed Characteristics	83
26.	Regenerative Centrifugal Pump Performance	84
27.	Typical Positive Displacement Pump Performance	85
28.	Typical Rotary Positive Displacement Pump Performance	86
29.	Free Diaphragm Pump Performance	87
30.	Performance Characteristics of Photovoltaic System Components	92
31.	Performance of Pompes Guinard System in Mali v Irradiance	94
32.	Daily Output of Pompes Guinard System in Mali	96
33.	Performance of Arco Solar System in Sudan v Irradiance	97
34.	Daily Output of Arco Solar System in Sudan	98
35.	Block Diagram for Photovoltaic System Model	100
36.	Validation of Photovoltaic System Model (Pump Output)	101
37.	Variation of Daily Overall System Efficiency with Head for Array Optimised System	104
38.	Variation of Output with Head for Photovoltaic Systems	105

<b>Figure</b>	<b>Title</b>	<b>Page No.</b>
39.	Variation of Daily Overall System Efficiency with Head for System with Maximum Power Point Tracker	107
40.	Effect of Pipework Changes on Specific Capital Cost	108
41.	Comparison of Theoretical Carnot Efficiency with Efficiencies Obtained in Practice ( $T_c - 25^\circ$ )	112
42.	Schematic Arrangement of a Thermal System	115
43.	Comparison of Solar Collector Performances	117
44.	Simple Rankine Cycle	119
45.	Rankine Cycle with Intermediate Heat Exchanger	119
46.	Hindustan - Brown-Boveri Mark 1 Liquid Piston Rankine Cycle System	121
47.	"Camel" Gravity Operated System	123
48.	Principle of Fluidyne Pump	126
49.	General Arrangement of Sunpower Inc. Stirling Engine	128
50.	Schematic of Solar Pump Corporation Solar Pump	129
51.	Examples of Solar Collector and Engine Efficiency	139
52.	Effect of Optimum Operating Temperature on Costs of Thermal Systems	140
53.	Effect of Optimum Operating Temperature on Collector Areas of Thermal Systems	141

## SMALL-SCALE SOLAR-POWERED PUMPING SYSTEMS

### TECHNICAL AND ECONOMIC REVIEW

#### EXECUTIVE SUMMARY

This report reviews the use of small-scale solar powered pumping systems for the irrigation of crops in small land-holdings in developing countries (i.e. of the order of 1 ha).

The introductory chapter places this Review in the context of the wider UNDP funded project GLO/78/004, which also involved practical testing of systems.

This is followed by a discussion of the principal prime-mover power options available for small-scale irrigation pumping and how they compare, followed by general discussion of the appropriate sizing of systems, engineering requirements (to suit the operational environment) and the importance of local manufacture of systems within developing countries.

The main body of this Review then consists of a technical assessment and appraisal of the principal types of solar pumping system available and the apparent merits and demerits of numerous subsystem and component choices. A brief historical outline of the development of these technologies is included, with information on currently operational systems and some assessments of possible future trends. This technical assessment and appraisal is subdivided broadly into three sections, dealing with (i) photovoltaic, (ii) thermal and (iii) unconventional systems that may have a future role.

Finally, there is a brief section which attempts to compare the relative efficiencies and hence the relative costs of the subsystems that comprise the principal small-scale solar pumping system options that are currently available. This section is necessarily speculative, being based on the very tentative cost data associated with today's immature technology in this field, but it does indicate that it should be possible to achieve acceptably low capital costs for future systems once technical maturity and full scale production are achieved.

## 1 INTRODUCTION

### 1.1 Background to Review

The direct use of solar power may in future find widespread application by farmers in developing countries for the small-scale pumping of irrigation water. The technical feasibility of solar powered pumping has been demonstrated using several different methods of energy conversion, but up to the present it has generally appeared that the technology is too expensive to be economically viable when compared with conventional alternatives, such as diesel or mains electric pumps. Furthermore, the equipment is often not sufficiently simple and robust to be appropriate for use and upkeep by farmers in developing countries nor has it yet been developed to the stage of being a mature product. With few exceptions, all the solar pumping equipment available at present is of prototype status, few models having been manufactured in any quantity.

The present Project has been specifically restricted to the testing and demonstration of small-scale solar-powered pumping systems capable of providing a flow of not less than one litre per second, primarily for irrigation purposes. To be economically attractive, the World Bank/UNDP considered that the pumping systems would ultimately need to deliver water at a cost not exceeding US \$ 0.05 per cubic metre (1979 prices). As the power requirement and hence the unit cost of water pumped increases in direct proportion to the total head against which the water is pumped (for a given flow), a point must obviously be reached at which it becomes uneconomic to pump through greater heads. The combination of head and flow at which pumping becomes uneconomic is site specific and depends on costs of the pump and maintenance, crop water requirement and the extra income expected to accrue from improved irrigation. No universally applicable value for this limiting head can be cited, but it is almost certain to be less than 10m.

It was the informal but considered judgement of irrigation advisers to the World Bank and others that for the purposes of this Project attention should be concentrated on pumps in the hydraulic power output\* range of 100 to 500 watts, although systems up to 2000 watts should not be excluded. Considerably larger power outputs are technically possible, but the size restriction adopted for this Project is appropriate to the needs of many millions of family farms and small holdings in the developing world. In particular, the small-scale approach keeps the capital cost down and avoids the problems of multiple uses, with the associated costs of water distribution and control.

The importance of the small-scale approach is fully discussed in the Project Report and in this Review, and endorsed by many other references, (e.g. Ref. 2).

### 1.2 UNDP/World Bank Project

As stated in the Project Document signed by the World Bank and UNDP in June 1978, this Project forms part of an overall search to develop small-scale pumping systems for water supply and irrigation applications in developing countries which:

---

\* 'hydraulic power output' means pumped water output calculated on the basis of the product of flow and total (pumped head).

- a) are based on renewable energy sources;
- b) are decentralized;
- c) have costs low enough for small farmers;
- d) have minimal and simple operation and maintenance requirements; and
- e) have good prospects for local manufacture and/or assembly.

The UNDP and World Bank decided that the work should first concentrate on the use of solar energy and investigate its application to irrigation pumping. The first phase of the Project was mounted with the overall objective of advising the UNDP and World Bank on whether solar pumping technology was in a position such that it would be worth promoting its development to make it appropriate for pumping water under the conditions that prevail on small farms in the developing world and, if so, what steps should be taken. The enquiry was thus open, although it was expected that the potential of the technology would be recognised and that further development would be recommended.

The main activities in Phase I included field trials of possible systems, laboratory tests on principal components and system design studies. In undertaking this work the importance of the potential manufacture (or at least assembly) of systems in developing countries themselves was recognised.

At a very early stage in project preparation (before the Consultants were involved) discussions were held under UNDP auspices to decide on the locations of the field trials. Agreement was reached in principle for the participation of India, Mali, Philippines and Sudan but in the event India did not participate in the field trials which were, therefore, hosted by and carried out in Mali, Philippines and Sudan.

### 1.3 Context of Review

This Review is submitted to the World Bank at the conclusion of the Phase I of a UNDP Project to test and demonstrate small-scale solar pumps.

During this Phase, which commenced in July 1979 and ran until May 1981, the Consultants completed an initial State-of-Art Report (Ref. 1) in December 1979; this Review is intended to supersede the earlier Report and therefore repeats many sections from it.

Subsequently, after gaining the approval of the World Bank for their recommendations, the Consultants purchased a selection of the more credible photovoltaic and thermal small-scale solar-pumping systems available in early 1980 for field testing in Mali, Philippines and Sudan, in collaboration with the energy research agencies in those countries. Four systems were tested in each country; of these eleven were photovoltaic (PV) powered and one was thermal.

Samples of the motors and pumps used in the field-tested photovoltaic systems were subjected to a parallel programme of laboratory testing in the U.K, principally to determine their performance characteristics. Sample PV modules from their arrays were performance tested in the UK and in the USA by independent testing authorities and the modules were subsequently subjected to intensive environmental testing in the USA.

Finally, the data produced from these test programmes were utilised in computer-based mathematical models of PV and thermal small-scale pumping systems. The purpose of the modelling exercise was to allow the rapid evaluation of the relative merits of the many different system options that are possible in making up a solar pump, as part of a design study aimed at identifying the most promising technical approaches to pump design for low head irrigation applications.

Since the ultimate criterion for “goodness” of a solar pump is the actual cost of the useful pumped output it produces over its lifetime, an attempt was made to introduce the relative costs of different system components and subsystems into the modelling process and a parameter to assess cost-effectiveness was adopted.

This Review necessarily draws on the general conclusions reached in Phase I of the Project and for the convenience of readers the Executive Summary of the Project Report is included in the Review as Appendix 3.

It is hoped that the Report and Review together will provide guidance to governments and agencies about the performance and cost-effectiveness of many solar pumps and the desirable features which they should possess.

#### **1.4 Scope of Review**

This Review discusses the general technical and power requirements for small-scale irrigation and reports on a study of system economics, reviewing the effects of variation in the major influences on solar pumping and the differential movement in prices. The principal photovoltaic and thermal prime-mover power options available for small-scale irrigation pumping and the engineering requirements for this type of system are described. A technical assessment is made of the main types of solar pumping system available and information is given on possible future trends. The Review concludes with a comparison of the relative efficiencies and costs of the main system options which are currently available and with an estimate of the costs for which it may be possible to produce these systems in the future.

## 2 ROLE OF SMALL-SCALE SOLAR PUMPING FOR IRRIGATION

### 2.1 The Increasing Importance of Irrigation

As the end of this century is approached, feeding the world's population (which is expected to increase by 50% by the year 2000) will prove an increasingly difficult and challenging problem, and nowhere more so than in the poorer, less fertile or densely populated regions of the developing countries.

Irrigation is widely perceived as one of the key components in improving food production; there is no readily identifiable yield-increasing technology other than the improved seed-water-fertilizer approach. Further, it is expected that in the next two decades about three quarters of all the increases in the output of basic staples will have to come from yield increases, even though during the past decade yield increases have only supplied half the increase in output, (Ref.3). This is largely because there is less and less uncultivated, but fertile, land available in the more densely populated regions; hence irrigation will be important not only to increase the yield from existing cultivated land, but also to permit the cultivation of what are today marginal or unusable areas of land.

Table 1 indicates the irrigated areas in the world (Ref.4), together with the principal developing countries where irrigation is practised. The majority of the land brought under irrigation since 1972 is mainly in countries where irrigation has traditionally been practised.

It is apparent from this Table that only a limited number of countries have significant areas of land under irrigation, and that two of the largest countries in Asia, China and India, account for half the world's irrigated land. It is also interesting to note that nearly half the irrigated land in the whole African continent lies in the Nile delta region of Egypt.

These relatively densely populated, intensively cultivated regions almost certainly practise today what many other regions, with increasing population pressures on the land, will have to practise in the future, if sufficient food production is to be assured. Farming in Asia today is perhaps the most realistic model of the kind of farming that will need to be practised in Africa and Latin America tomorrow.

### 2.2 The "Energy Crisis" and Irrigation

A large proportion of the world's traditionally irrigated land is commanded by gravity-fed water obtained by controlling the flow of rivers and providing suitable canal distribution systems. This is evidently a desirable method since there are little or no energy costs associated with distributing the water once the scheme has been completed. However, there are limits to the amount of land that can readily be commanded by gravity-fed water, and many populations and the land they require to cultivate cannot benefit from such schemes, now or in the future.

REGION & principal irrigation countries	IRRIGATED AREA million hectares (Mha)	% of total
<b>1. SOUTH &amp; SOUTH EAST ASIA</b>		
China	74	
India	33	
Pakistan	12	
Indonesia	4	
Taiwan	2	
Thailand	2	
Philippines	1	
Korea	1	
(others)	<u>(3)</u>	
	132	66
<b>2. NORTH AMERICA</b>	17	9
<b>3. EUROPE</b>	13	7
<b>4. MIDDLE EAST</b>		
Iraq	4	
Iran	3	
Turkey	2	
Afghanistan	1	
(others)	<u>(1)</u>	
	11	5
<b>5. U.S.S.R.</b>	10	5
<b>6. AFRICA</b>		
Egypt	3	
Sudan	1	
Malagasy	1	
Algeria )		
Libya ) (combined)	1	
S. Africa )		
(others)	<u>(1)</u>	
	7	3
<b>7. CARIBBEAN &amp; CENTRAL AMERICA</b>		
Mexico	4	
Cuba	0.5	
(others)	<u>(0.5)</u>	
	5	2
<b>8. SOUTH AMERICA</b>		
Argentina	1.2	
Chile	1.3	
Peru	0.9	
(others)	<u>(0.9)</u>	
	4.5	2
<b>9. AUSTRALASIA</b>	<u>1.4</u>	1
<b>World Total</b>	<b>201.9</b>	<b>100</b>

TABLE 1 - IRRIGATED AREAS OF THE WORLD IN 1972



During the 1950s and 60s, the cost of petroleum-based energy tended to fall in real terms, which encouraged the increasing use of engine-driven irrigation pumps (and also the spread of rural electrification, and hence electrically energised irrigation pumps). In fact the area of irrigated land in the world has been estimated (Ref.4) as having increased by about 70% in the period from 1952 to 1972, and much of this will have been through engine or electric-motor driven pumping.

Although mechanised irrigation continued during the 1970s, since 1973 the great increases in real terms of petroleum costs (and hence electricity costs) have reduced the margin to be gained by farmers from irrigation, because food prices cannot and have not been allowed to increase in line with energy costs.

The high cost of oil, in addition to putting an increasing burden on those farmers who already practise mechanised irrigation, severely discourages farmers from bringing new land under irrigation. A further problem in recent years has been the availability of diesel fuel. Supplies of fuel in many countries and particularly in remoter and poorer regions have become increasingly unreliable even for those with the resources to purchase them. This is a further inhibiting factor which worries many farmers who often depend on a supply of fuel to prevent the total loss of a crop.

Some governments attempt to mitigate the situation by subsidising oil and rural electricity for use in agriculture, but many of these governments are the very ones that can least afford such a policy which incurs balance of payments deficits, largely because of the increasing cost of oil imports. There is a pressing need therefore in many developing countries to discourage the increased use of oil even though there is an equally pressing need to increase food production, and mechanised irrigation is a widely recognised means to do this.

Thus, it is becoming most important to find new methods for energising irrigation pumps that are independent of oil or centralised rural electricity. The latter is almost always generated from oil and the poor power factors, high infrastructural costs and peaky demands make it an unpromising source of energy for large, poor, rural communities.

### 2.3 Small-Scale Irrigation

Small-scale irrigation (sometimes known as micro-irrigation) is certain to become an increasingly important and widely used agricultural technique during the next few decades, particularly in developing countries. This is because the majority of land holdings in the poorer, more densely populated parts of the world are small, often a hectare or less. Studies have shown that these numerous and small land holdings are in fact more productive than larger farming units. An Indian farm management study (Ref. 5), indicated that small family-run land-holdings are consistently more productive than larger farm units in yield per hectare, although the small units are more demanding in terms of labour inputs. A survey conducted in Brazil (Ref. 5) also illustrated the better land utilisation of small farms, but family-sized land holdings only achieved this through applying 5 to 22 times as much labour per hectare as large farms.

Small land holdings also generally achieve better energy ratios (i.e. energy value in the food product/energy inputs to produce it) in their crop production than is achieved by large-scale mechanised agriculture. This is discussed in detail in Ref.6 which indicated that typical energy ratios for tropical subsistence and semi-subsistence agriculture are in the range 10 to 60, while mechanised large-scale commercial agriculture generally has energy ratios of from 4 to less than unity. Hence, in a world with diminishing availability of commercial fuels, there appears more scope for significantly increasing food production through encouraging labour-intensive small-scale units which are likely to produce more from a given land and energy investment.

Investment in irrigation also has a positive effect in terms of alleviating poverty; for example, irrigation schemes can double the amount of labour required per hectare of land (Ref.5) and raise the incomes of landless labourers, even though the farmers of course derive the greatest benefit. The same reference gave details of surveys of average percentage increases in household income for farmers practising irrigation, compared with those who do not. The increases obtained were 469% in Cameroon, 75% in South Korea, 90% in Malaysia, and 98% in Uttar Pradesh State, India. In the Malaysian case, the benefit, on average, accruing from irrigation to landless labourers was 127%.

The Asian Development Bank is assisting in the improvement of 12,000 sq.km of land through irrigation schemes, which are expected to benefit 5.7 million people and create 400,000 man years of work. When the potential of these current projects is realised, they are expected to create an annual increase of 3.2 million tonnes of unmilled rice: the per capita income for families which benefit directly is expected to increase from 92 to 227 US dollars, nearly 150% (Ref. 7).

The scope for gaining improved yields through small-scale irrigation is substantial; for example the average rice yield in South and South East Asia is about 2t/ha, while in Japan, with sophisticated small-scale irrigation and land-management, yields are typically 6t/ha (Ref.7). The Asian Development Bank has reported that a doubling of rice production per hectare should be possible in the region within 15 years (Ref.7) and is considering a programme with this target. 304,000 sq. km of rainfed and 175,000 sq. km of inadequately irrigated land is to be converted to adequately irrigated land through an investment of 540,000 million US dollars (1975 prices), which is an average investment of about 11,000 US dollars per improved hectare (Ref.7).

#### 2.4 Power Requirements for Irrigation

The minimum power requirement, (P), to lift irrigation water is directly proportional to the product of the total static head (H), (or height through which the water must be lifted from its source in order to flow onto the fields, plus pipe friction energy and other energy losses), and the flow rate of the water at any given moment (Q).

$$\text{i.e. } P = k.H.Q \quad (\text{where } k \text{ is a constant})$$

Generally, for economy, the system will be designed so that the static head will comprise a large proportion of the total head, so that losses are kept reasonably small. The cost of pumping water is closely related to the rate of power usage (i.e. the energy requirement in a given time period). Hence the higher the static head or the larger the quantity of water to be pumped, the greater the resulting costs.

The static head is a function of the vertical distance from the surface of the water source to the surface of the field. However, higher heads and consequently more power for a given flow rate are normally needed in order to distribute the water from the pumping system delivery pipe to the plants. The simplest method is for the water to be distributed by gravity, which means that it has to be pumped to an elevation high enough for it to flow effectively across the land area to be irrigated. The outlet for a gravity distributed irrigation system may need to be typically 1m above ground level; while this is low in absolute terms, for low lift irrigation from a source say only 3m below ground level, this extra metre of head requires 33% more energy (and similar associated costs) to move a given quantity of water.

Pumping water through distribution pipes also implies adding to the effective head, due to friction in the pipes. The use of pipes of too small a diameter can have a profound effect on the energy requirements (and consequent costs) of low head pumping systems. Sprinkler irrigation and most drip feed irrigation systems, although economising effectively in the water quantities needed, generally require quite high operating pressures, and are therefore expensive in terms of energy requirement at low static heads.

So the effective head through which water must be pumped depends on the total static head, the losses in the pipework linking the pump to the source and delivery point, and on the additional head necessary for the water distribution system.

The quantity of water needed to irrigate a given land area depends on a number of factors, the most important being:

1. nature of crop
2. crop growth cycle periods
3. climatic conditions
4. type and condition of soil
5. land topography
6. field application efficiency
7. conveyence efficiency
8. water quality

Many of these vary with the seasons and the quantity of water required is far from constant. The design of a small irrigation pump installation will need to take all these factors into account and include consideration of the economics of providing storage.

The estimation of overall irrigation water requirements starts with the water requirement of the crop itself. Calculation begins with a standardised criterion known as the "reference crop evapotranspiration" ( $ET_0$ ): this is the rate of evapotranspiration from an extended surface of actively growing tall green grass completely shading the ground and not short of water. It depends on temperature, humidity, wind and cloud cover (or sunshine hours).  $ET_0$  is the water demand of the reference crop itself and if water is available from no other source represents the quantity which has to be supplied by irrigation.  $ET_0$  can be computed by a number of internationally accepted methods using standard meteorological data (e.g. Ref 38) or estimated from pan evaporation data. Since  $ET_0$  depends on climatic factors it varies from month to month, sometimes by a factor of 2.

The evapotranspiration of a particular crop ( $ET_{\text{crop}}$ ) is of course different from that of the reference crop and is determined from the equation.

$$ET_{\text{crop}} = ET_0 \times K_c$$

$K_c$  is a "crop coefficient" which varies with the type of crop, stage of growth, growing season and prevailing weather. It commonly varies from about 0.3 during initial growth to as much as 1.0 during the mid-season growth period. Thus the actual crop water requirement  $ET_{\text{crop}}$  can (& does) vary quite considerably during the growing season.

The nett irrigation requirement over a specified time period is the depth of water required to meet the crop evapotranspiration demand, less any contributions from rainfall, groundwater or stored soil water. (Some rainfall is lost to the crop by surface runoff, deep percolation and evaporation and the rainfall is factored to obtain the 'effective rainfall' available for crop use). Allowance also has to be made for the water needed for preparation of the land - this can be significant, particularly in the case of rice. The nett irrigation requirement then has to be increased to allow for losses which occur during conveyance and application in the field to obtain the gross irrigation requirement.

Table 2, adapted from Ref. 8, illustrates typical irrigation water requirements for cotton and wheat in the vicinity of Lake Chad in central West Africa. The estimated availability of solar energy, on average, for the various months is also given. The Table illustrates a typical irrigation pattern to be expected in a semi-arid tropical region and shows clearly how the actual irrigation demand varies substantially with the growing seasons. The Table also shows that if solar energy is to be used to power a pump, the sunniest months do not necessarily coincide with the months of maximum demand. The same information is presented graphically in Figure 1.

A constant field application efficiency of 60% is assumed in Table 2: this is the proportion of water applied to the field which actually contributes to the nett irrigation requirement and is a function of the method of water distribution and of the farmer's water management abilities. Surface (flood) irrigation is typically 30 to 60% efficient, while sprinkler irrigation systems can be 60 to 80% efficient. Certain new systems of irrigation, such as trickle or drip irrigation or under-soil irrigation can be better than 80% efficient.



Typical figures for other crops and regions are in the range from about 4,000 cu. m./ha per crop (using an efficient distribution system and good water management) to as much as 13,000 cu.m./ha per crop in the Sahel dry season, i.e. 400 to 1300mm of water per crop. (Refs. 2, 8, 9, etc.). Typical growing cycles are of the order of 120 days under tropical conditions; the average daily requirement is thus in the range 35 to 100 cu.m./ha. Assuming an average of 8 hours pumping per day is possible (as would apply with solar pumps without any energy storage), then the average flow required is in the range 1.2 to as much as 3.5 litres/sec per hectare. For solar pumps, the flow under peak sunlight conditions (of around 1000W/sq.m) is likely to be about 25% above the average, so peak flows in the range 1.5 to 4.3 litre/sec are likely to be needed for solar-powered irrigation systems to service one hectare of land.

	NOV	DEC	JAN	FEB	MAR	APR	MAY	JUN	JUL	AUG	SEP	OCT	TOTAL
Reference crop evapotranspiration ( $ET_o$ )	179	146	144	142	208	228	227	185	181	148	151	199	2138
Average rainfall	0	0	0	0	0	0	8	9	69	142	43	9	280
Effective rainfall (ER)	0	0	0	0	0	0	0	0	35	71	22	0	128
Groundwater contribution (GE)	0	0	0	0	0	0	0	0	73	31	0	0	104
Cropping pattern	(((-----WHEAT-----))) ((-----COTTON-----)))												
Crop coefficient ( $K_c$ )	0.6	0.8	1.0	0.7	--	0.6	0.6	1.0	1.0	0.9	--	--	--
Crop Water requirements $ET_{crop} = ET_o \times K_c$	107	117	144	99	0	137	136	185	181	133	0	0	1239
Net irrigation requirement ( $ET_{crop} - ER - G_e$ )	107	117	144	99	0	137	136	185	73	31	0	0	1029
Gross irrigation requirement (Nett x 1.67)	179	195	240	166	0	228	227	308	122	52	0	0	1717
Gross irrigation requirement	cu.m/ha	1790	1950	2440	1660	0	2280	2270	3080	1220	520	0	17,170
Mean flow rate/hectare	(litre/s)	2.1	2.2	2.7	2.0	0	2.6	2.5	3.6	1.4	0.6	0	0
Volume required/hectare (assuming pumping for 8h/day)	$m^3/d$	60	63	77	59	0	76	73	103	39	17	0	0
Average solar energy per day	$kWh/m^2$	6.1	5.6	5.6	6.4	7.0	7.3	6.9	6.4	6.2	5.5	5.8	6.4

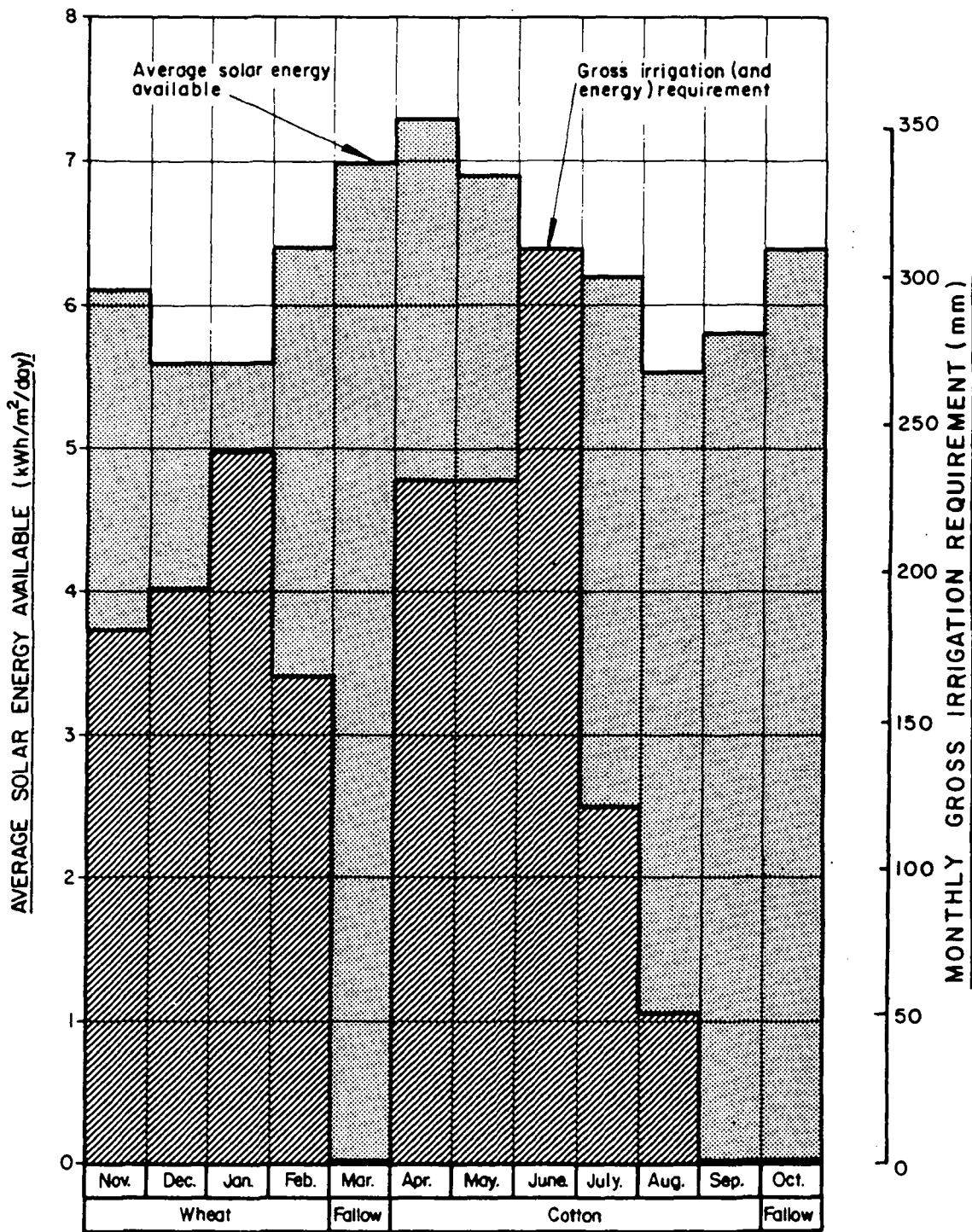
TABLE 2 – IRRIGATION WATER DEMAND AND SOLAR ENERGY AVAILABILITY – LAKE CHAD REGION FOR COTTON AND WHEAT CROPPING PATTERN (After Reference 8)



**LEGEND**

-  Average solar energy availability for month.
-  Gross irrigation requirement (proportional to energy demand and drawn so as to indicate relation between energy demand and energy available)

**FIGURE 1 – SOLAR ENERGY AVAILABILITY AND CROP IRRIGATION WATER DEMAND (LAKE CHAD REGION)**

Assuming, for example, a water-table 5m below the pump discharge level and distribution thereafter by gravity, then the peak hydraulic power output corresponding to the range of flow rates given above will be 73 to 210 W/ha. Slightly different numerical assumptions can yield hydraulic powers of up to 300W/ha, for a 5m lift. Input power requirements will be considerably higher depending on the system efficiency, as will be discussed in more detail later.

Power requirements are directly proportional to the actual head across the pump. This consists largely of the static head through which the water is lifted, but also includes the pipe friction and associated energy losses. The friction head can be a significant proportion of the total head, particularly with low head systems of 5m or less or with systems having a significant length of delivery pipe. The velocity head is normally small unless water distribution is by spraying. Hence it is important to take the head losses in the pipework into account as part of the system design.

Since water for irrigation has a finite value, related principally to the marginal value of the extra crops gained, and the cost of water increases with increases in head, it becomes decreasingly profitable to irrigate as the pumping head increases. There will be a certain static head above which it will be uneconomic to irrigate, as the costs will exceed the benefits.

Similarly, transmitting the water long distances will increase the power requirements because of the extra energy required to overcome pipe friction\*. If pipe friction is avoided by distributing the water through channels by gravity, extra head has to be provided to obtain a sufficient hydraulic gradient in the channel. Also, in the latter case, evaporation losses will increase in relation to the surface area of water in the channels and unless the channels are totally impervious (i.e. concrete, steel or plastic), losses due to seepage are also possible, all incurring a power demand.

It follows from this that the losses (either by leakage and evaporation, or by an effectively increased pumping head) will increase in relation to the area of land to be commanded by the pumping system, and any economies of scale obtained by using a larger pumping system will be countered by extra costs of distribution.

From the foregoing description, it will be appreciated that careful system design is necessary if solar pumps are to be used effectively in irrigation applications.

## 2.5 Pumping Methods Available

### 2.5.1 General

The principal traditional methods for lifting irrigation water in the tropics have been (and in many areas still are):

1. human labour, (e.g. using a Shaduf water crane)
2. draught animals, (e.g. using a Persian Wheel or Noria)

---

\* The head loss in the pipework due to friction is a function of the resistance coefficient, the size of the flow rate, the length of pipe and the inverse of the fifth power of the pipe diameter. The resistance coefficient is related to Reynolds number and the relative roughness of the pipe surface.

Power Source	Advantages	Disadvantages
1. Human Labour	Readily available. Low investment costs. Can be flexibly deployed.	High feeding costs and associated costs (wages). Very low output. Diverts a valuable resource from more productive activities.
2. Draught animals	Readily available. Medium investment costs. Convenient power output for small-scale irrigation. Can be flexibly deployed.	High feeding costs involving extra food production. Feed required even at times when no power can usefully be employed.
3. Petrol or diesel fuelled small engines	Widely available technology. High outputs possible on demand. Portable. Low initial capital investment cost per unit of output.	Fuel costs dominate and are increasing in real terms. Fuel shortage common in many areas. Spare parts often hard to obtain. Good maintenance difficult. Relatively short useful life. Breakdown common. High imported element involving scarce foreign currency in most countries.
4. Centralised rural electrification	Low marginal investment cost for prime mover (electric pump) if transmission lines installed. Pump sets are reliable provided supply is guaranteed. Can be low cost depending on power source and system.	Electricity supply often unreliable in Third World due to peaky demand, low load factors, sparse consumer population. Very high system investment cost and high generating and distribution costs. Extended power failures could cause widespread crop loss.
5. Wind pumps	Relatively mature renewable energy technology, when used for stock watering. Low cost in areas with adequate wind regimes. Zero fuel costs. Low maintenance needs.	Not yet well developed for irrigation purposes. Moderate output fluctuates with wind. High investment costs.
6. Water wheels, turbines, ram pumps and current turbines	Low cost, long-life, low maintenance, fuel-free power source if suitable site conditions are available to exploit water power.	Depends on relatively rare site conditions which limit the areas that could benefit from this type of prime mover.
7. Steam engines	Potentially low cost renewable energy technology, especially if agricultural waste can be used as fuel.	Fuel requires land use or transport of coal. Steam engine technology generally obsolete so modern equipment not readily available. Safety problems with boilers. Constant or frequent attendance needed.
8. Biogas fuelled small engines	Allows advantages of small engines given above but independent of supply of petroleum fuel. Immature technology for biogas production, but has low-cost potential. Fertiliser produced as a by-product from digester.	Includes most disadvantages of small engines (spares and maintenance). High water requirements for digester. Feedstock for digester may be scarce, particularly in arid regions. Fairly high labour needs for digester. Quite high investment costs in digester and gas storage.
9. Solar radiation (converted directly)	Energy resource almost universally available in areas where irrigation is useful. High correlation between energy availability and needs. Zero fuel costs. Long life and low maintenance are possible.	Immature technology with high investment cost at present. Diffuse energy resource compared with most alternatives will ensure fairly high investment cost at best, even after development. Output subject to solar insolation variations.

TABLE 3 - COMPARISON OF PRINCIPAL METHODS OF IRRIGATION PUMPING



Since the 1960's, relatively prosperous farmers in many areas have made increasing use of the following forms of mechanised pumping:

3. diesel, gasoline or kerosene fuelled internal combustion engines
4. mains electricity energised electric pumps

Water power has been used traditionally in hillier regions to command land not accessible through contoured gravity fed canals; the main techniques using this resource are:

5. water wheel powered Persian Wheels
6. hydraulic ram pumps
7. water turbine driven centrifugal pumps (mainly in China)

Other technologies not generally used as yet, but which may have future potential, are:

8. biomass (or coal/lignite/peat) fuelled steam engines
9. biomass (biogas/alcohol/plant oil) fuelled i.c. engines
10. windpumps (widely used at present for livestock but not much for irrigation)
11. water current turbines (under development)
12. solar radiation, directly converted (which is the subject of this Review)

The main advantages and disadvantages of these methods are outlined briefly in Table 3.

### 2.5.2 Solar Pumping Options

There have been a number of books and papers published recently which include reviews of the present state of the technology of solar-powered pumping (see for example References 16 to 24 inclusive). The information given in these publications has been supplemented and updated by the extensive enquiries to manufacturers and research institutions made under this Project with a view to purchasing equipment for testing under Phase I.

The most feasible options for solar-powered pumping systems for the power range under consideration, with the present state of development of solar power technology, are illustrated schematically in Figure 2.

At present, none of these alternative systems has a clear overall advantage although some options appear to be better than others. Their various advantages and disadvantages are discussed in detail in later chapters. Examples of all of these systems (with almost every permutation of engine and transmission illustrated) are currently being developed but few are commercially available; the majority of those on the market consist of fixed photovoltaic flatplate arrays powering a d.c. electric motor/pump unit. The systems and components which are commercially available today are reported on separately in the Project Report.

In addition to the main options for solar pumping referred to above, a number of further technical options which may possibly have a future role are reviewed in Chapter 6.

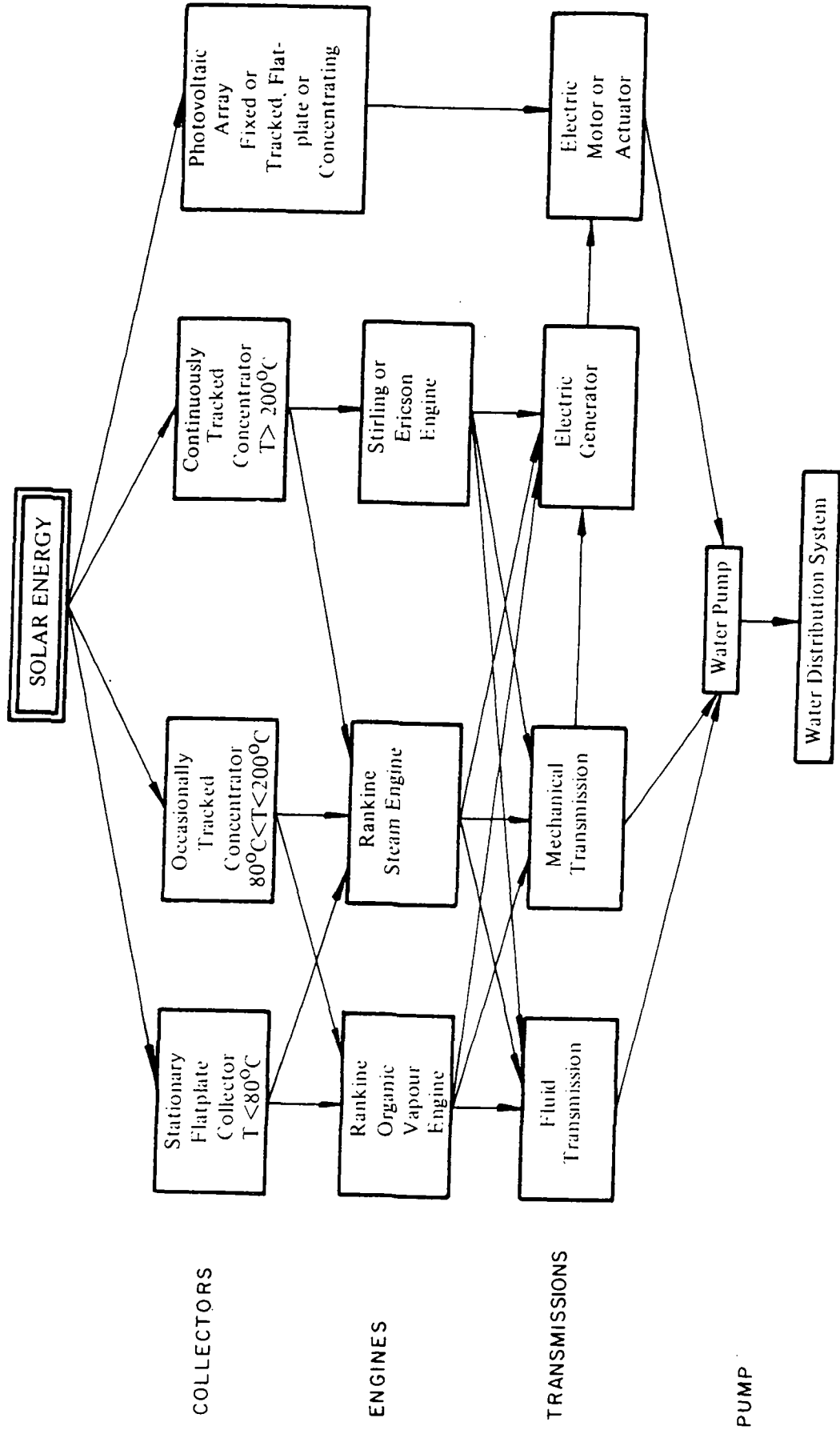

FIGURE 2 -- FEASIBLE OPTIONS FOR SOLAR -- POWERED PUMPING SYSTEMS

## 2.6 The Suitability of Solar Pumps for Irrigation

The main advantage of using direct solar radiation as a power source for irrigation pumping is that it is the only energy resource that is almost universally available both when and where it is needed. Most of the countries where irrigation is necessary have high levels of solar irradiation and the availability of sunlight does correlate at least partially with the crop water demand.

The correlation is often not perfect, in the sense that the time of the year when most solar energy is available often does not exactly coincide with periods of maximum irrigation water demand, (this is illustrated by the example in Table 2 and by Figure 1 derived from it). However, the period of least availability of solar energy is normally coincident with the period of least or zero irrigation water demand, being invariably the rainy season.

A solar pump, once installed, is clearly independent of fuel supplies or other external constraints and, in effect, runs on the same energy resource as the plants it serves to water. However, most of the lifetime cost of a solar pump has to be met at the time of purchase, since the main cost element is inherent in the first cost, operating and maintenance costs being very low for a successful solar pumping system design. The provision of finance to assist the poorer farmers to meet this first cost is an important aspect of the transfer of this technology that will have to be addressed once it is clear that solar pumps provide genuinely economic means of raising water. Government backed agricultural credit schemes have been in operation in a number of developing countries and it is not thought that this represents an insuperable problem. The economics are discussed in Chapter 3.

In addition, the high cost of present day solar pumping systems can be expected to fall substantially through improvements in performance and design, and through economies resulting from an increasing scale in manufacture.

On the national level, the widespread deployment of solar pumps would help to improve food production (and alleviate rural poverty in the process) largely through the better use of local resources of land, labour, ground water and sunlight. This would be achieved without the increases in petroleum imports (with consequent balance of payments problems), which would be needed if conventional oil fuelled engines or rural electrification were used.

The maximum benefits on the national level would be obtained if a high level of local added-value can be introduced into the manufacture of solar pumping systems to minimise the foreign currency requirements associated with the introduction and subsequent widespread use of the technology, as discussed in section 3.4.

Further possible advantages of solar pumps are that they are potentially long lasting and reliable, if the technology is developed to maturity, compared with small engines, and the maintenance, servicing and repair skills should be less demanding and more easily taught than those needed for engines. Hence they are particularly well suited for use in remote areas where communications and access are difficult so that a system that is relatively independent of external supply lines has a significant advantage.

Also, for small-scale irrigation pumping duties, most land-holdings are sufficiently small to demand no more than a few hundred watts of pumped output power at low heads. Small engines do not scale down well to this power level, being inherently inefficient and lacking in durability when rated at much less than 1 or 2kW; also the maintenance costs of small engines are a major factor and there are no significant economies to be found in these when comparing say a 2kW engine with a 5kW one. Therefore, for very light pumping duties it is hard to use a small engine effectively; usually a larger than necessary machine must be used, while solar pumps on the other hand do scale down without serious diseconomies. Hence solar pumps are likely to be more competitive with internal combustion engines for small-scale applications and this is confirmed by analysis of available data. For example Ref. 8 finds that a 1 ft<sup>3</sup>/s solar pump would be more competitive against a similar output engine than a 2 ft<sup>3</sup>/s unit (= 56.6 litre/s) which is substantially larger than the systems under investigation for this Project.

Some of the main disadvantages inherent in solar pumps, are:

- o that they represent unfamiliar technology.
- o they are still, in the main, immature and therefore of high unit cost (due to the present limited scale of production).
- o that standards of reliability, efficiency and longevity are in general not yet at the level that is required for their widespread adoption.
- o although efficiency will improve with development, and costs will come down, solar-powered systems will inevitably remain large in relation to their power rating due to the low power density of sunshine and the relatively low efficiency with which it can be converted to shaft power for pumping. Thus they are likely to involve more materials and take up significantly more land area than engines powered by fuels, or even than windpumps in areas with sufficient wind to make the latter viable.

## 2.7 Size and Efficiency Considerations for Solar Pumps

### 2.7.1 Size Considerations

For a constant flowrate, irrigation becomes more uneconomic as the head increases due to the corresponding increase in power demand and hence unit cost of water. The terms of reference of this Project assumed that the likely head for irrigation pumping would be in the range 5 to 10m as there is much land available having a water table as close as this to the surface.

The majority of farms in developing countries are less than two hectares in area, and a large proportion are under 1 ha. As discussed in section 3.2. this is precisely the size range where engine powered pumps are generally oversized and too expensive, and hence this is the best opportunity for solar pumps to prove competitive (see Figure 9). Individual solar pumping systems, and particularly photovoltaic (PV) systems, do not exhibit marked economies of scale, but economies may be found in the volume of production. Hence by manufacturing larger numbers of small units, costs are likely to come down faster, and if this happens it is possible that the unit costs for small PV systems will be lower than for larger ones simply due to the scale of manufacture.

Further benefits from the development of small solar pumps would also be found because:

- o larger land holdings can make use of several such units (while still benefitting from the low costs resulting from mass production for a large market).
- o average distances water has to be transmitted would be lower, and consequently the average total pumped head, and water losses through seepage or evaporation would be reduced. Hence the power requirements and the unit cost of water would be reduced.
- o smaller solar pumping units could be introduced progressively, thereby reducing the capital sums to be raised to several smaller amounts rather than one large sum.
- o a number of smaller units will have a higher reliability, since a failure would not be so serious as when only one pump was in use.
- o the task of water management is substantially easier with a number of small units, so overall water usage efficiency could possibly be improved.

Small land holdings of less than 0.5ha are expensive to irrigate, but solar pumps offer a better prospect than engine pumps. This is shown in Figure 11 and discussed in detail in Chapter 3.

If solar pumps are to be successful, they will require reasonably efficient water distribution and management, which implies a peak water demand probably in the 40 to 80 m<sup>3</sup>/day range per hectare. In practice, and especially while the technology remains expensive, it will be important to hold the water requirement at the bottom of this range if irrigation is to be economically viable. Most water management techniques or improved distribution systems are likely to be cost-effective if they significantly improve water application efficiency and hold down the water requirement. One point in favour of small land holdings is that field losses are likely to be smaller (as a percentage of water pumped) and water management is likely to be easier.

Figure 3 illustrates the relationship between head, flow rate and pumped power output and indicates the requirements of a typical 1.0ha land holding.

### 2.7.2 Water utilisation efficiency

A solar pump has to be sized to be able to satisfy the peak irrigation demand for a given area and these conditions may only last for a relatively short time: thus at other times of the year the pump is likely to have excess capacity. Figure 1 illustrates this using the example from Table 2 of energy availability and irrigation water demand, for two crops per year

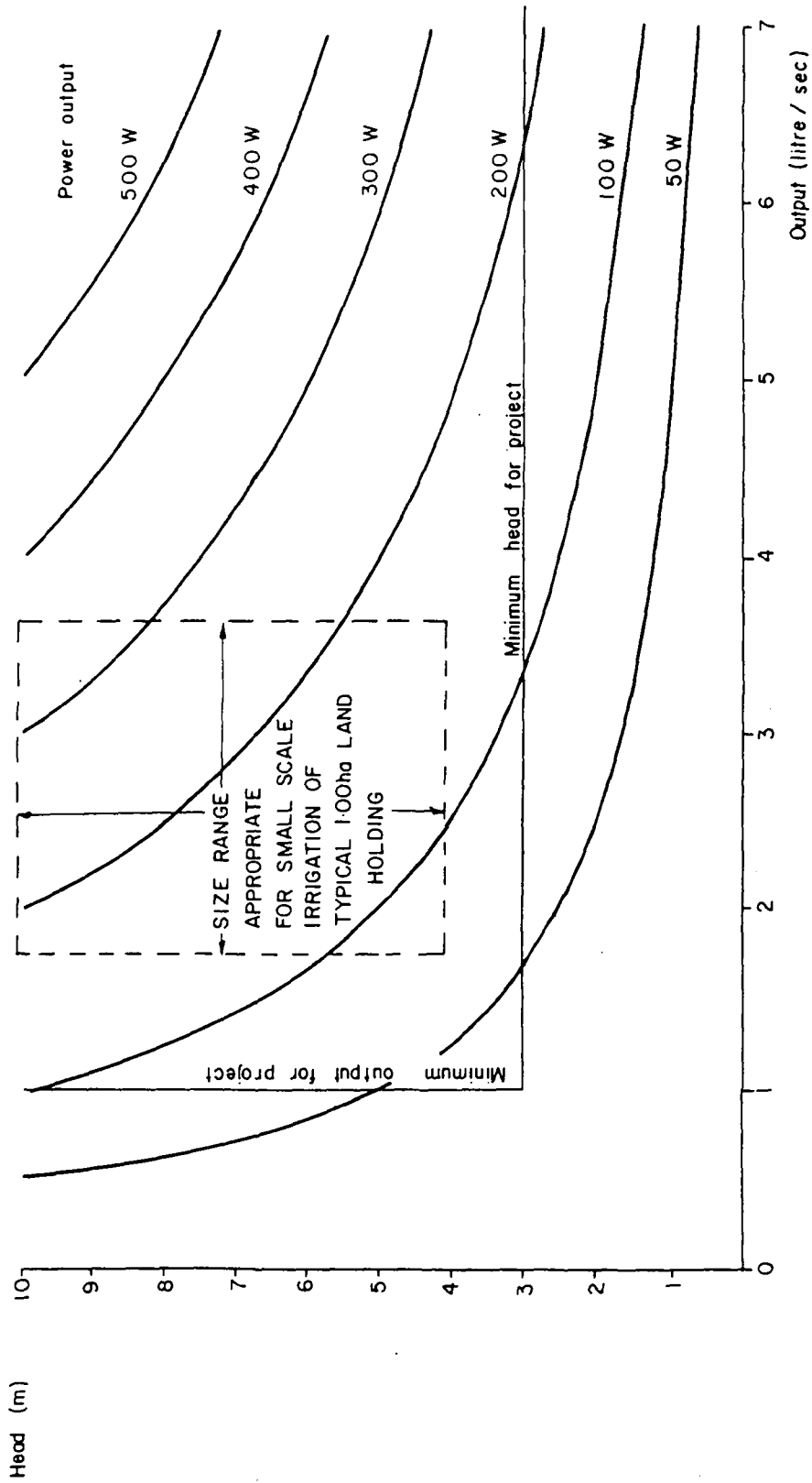

FIGURE 3 - POWER OUTPUT REQUIREMENTS FOR VARIOUS HEADS AND DELIVERY RATES

(wheat and cotton) in Chad. It should be noted that the area chosen as an example is likely to be more favourable than most for the use of solar pumps due to its low rainfall and high irradiation levels.

It is noticeable in this example that if a solar pump is sized so as just to satisfy the demand for irrigation water in the month of maximum demand (June in this example), then considerable surplus capacity will be available in most other months. This is due in part to:

- o variation in crop water demand during the growing cycle.
- o the changeover between crops (when no irrigation water is required).
- o rain supplementing or replacing irrigation water

The nett result of this mismatch between power availability and demand is that (in this example) only about 40% of the solar energy available can usefully be applied for irrigation. This example is likely to be reasonably typical; the situation would be better in terms of percentage water utilisation when there is a shorter time between changeover of crops or when there is less rain to supplement the irrigation water.

The situation could be even worse since the systems will have to be oversized even for the month of maximum demand to allow for:

- o years with less than average solar energy availability.
- o the farmer being unable to be present to make effective use of all available solar energy in the month of maximum demand.
- o solar pumping systems being unable to use the proportion of solar energy received with a power level lower than that needed for pumping to commence.

The proportion of available solar energy that can be used will be dependent upon the climate, crop cycles chosen, type of solar pump and effectiveness of the water management practised by the farmer, but it will never be possible to use all the water that can be pumped with the available energy for an application such as irrigation.

Factors that will increase the proportion of solar energy that can be used include:

- o the use of storage to improve ease of water management and reduce the peak flow requirements of the pump.
- o multiple cropping
- o use of water for other purposes in addition to irrigation.
- o operation in arid regions with even less rainfall than in Chad.

A further possibility would be to find an alternative use for any surplus electrical or shaft power.

As the cost of solar pumps falls, the degree of oversizing that can be tolerated will become greater, but initially it seems that if they are to be successful it will be in areas where serious oversizing due to extreme variation in irrigation water demand can be avoided.

Although it was beyond the scope of Phase I of this Project to consider in detail the utilisation of irrigation water after it leaves the pumping system, it must be emphasised that the detailed development and subsequent introduction of small-scale solar pumps in realistic pilot projects cannot be conducted without consideration of this vital issue.

The way the water is used can have a profound effect on the size of solar pump required for a particular duty, and hence on the cost; there are indications that an efficient distribution system coupled with careful usage could very likely halve the size and cost of pumping system required.

Both time and money should therefore be invested in field water storage and distribution systems aimed at improving water application and utilisation efficiencies, as well as in providing the necessary training for at least the first groups of farmers to use this technology. Such investments are likely to earn a good return in terms of reducing the sizes of solar pumping systems needed to perform a given duty as well as ensuring that the practices learnt by those farmers who pioneer the use of the technology are the most appropriate.

### 2.7.3 System efficiency

The complete "system" for the purposes of analysis includes:

- o the solar resource (incoming solar radiation)
- o the solar pumping system hardware
- o the distribution system "hardware" and water management "software"

The contribution of each to overall system efficiency is discussed below

#### a) The solar resource

As explained in section 2.7.2 it is not possible to utilise more than a proportion of the solar energy resource that is available. There are two principal methods for reducing the proportion of solar energy received which is so diffuse as to be below the system starting threshold; these are to reduce the threshold or to extend the period in the day when the irradiation received by the collector is above the threshold.



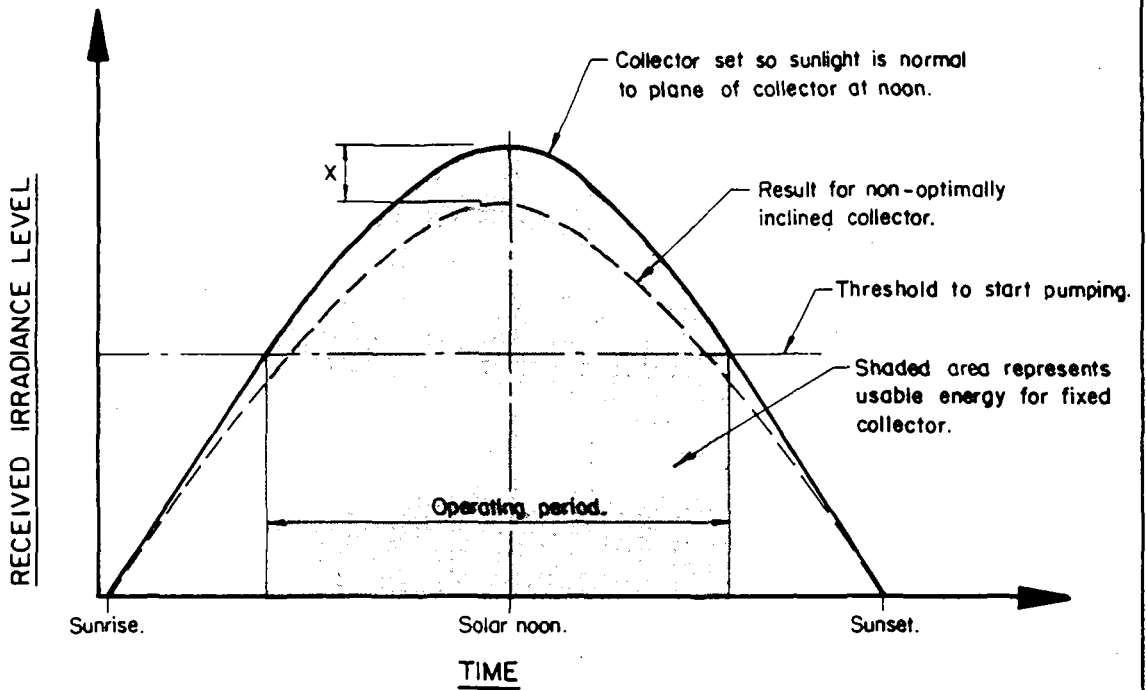

FIGURE 4A - VARIATION OF IRRADIANCE LEVEL RECEIVED BY A FIXED COLLECTOR AT OPTIMUM INCLINATION

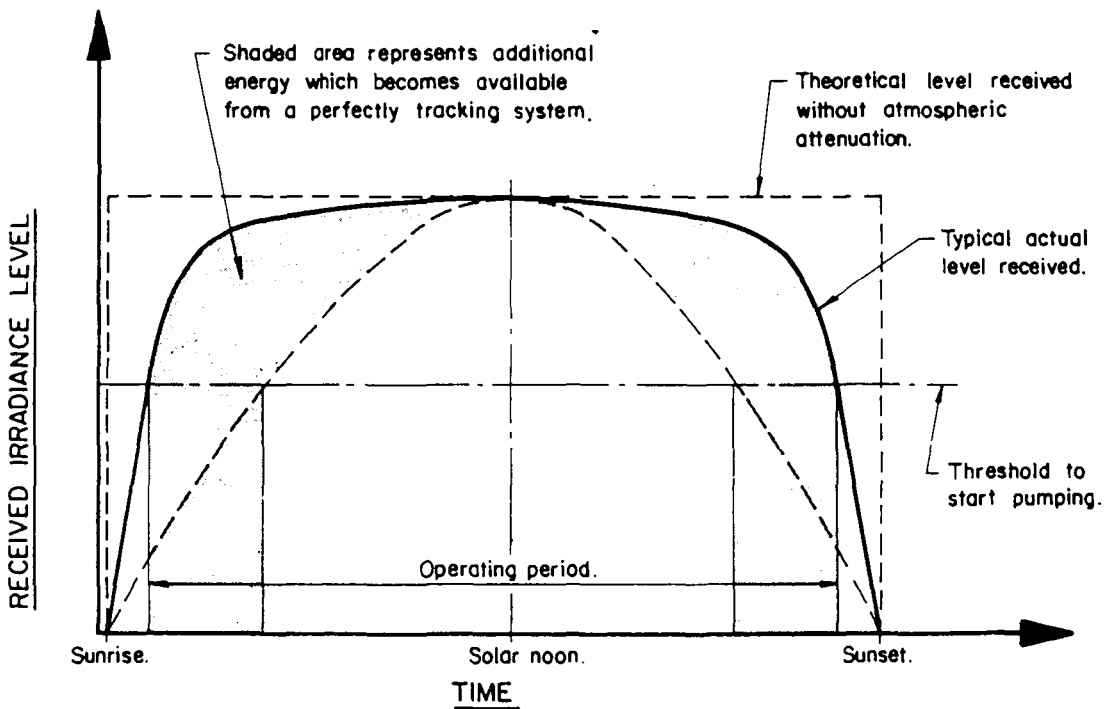

FIGURE 4B - VARIATION OF IRRADIANCE LEVEL RECEIVED BY A SUN-TRACKING COLLECTOR

To reduce the starting threshold involves making the system more efficient and avoiding any hysteresis in the system, such as might be caused by static friction. For this reason, low static heads centrifugal pumps are attractive as their starting torque can be less than their running torque.

Although attempts have been made to maximise the use of available solar irradiation, most manufacturers (whether of small photovoltaic or of small thermal solar systems) have favoured a fixed array for simplicity of manufacture and operation. However, Figure 4A shows that this arrangement produces a variable irradiance level through the day closely approximating a cosine curve. This curve is such that a considerable period of sunshine in the early morning or late afternoon can be lost so far as a solar pump is concerned, because the attenuation due to misalignment of the collector with the sun's rays reduces the available power below the starting threshold.

For example, when the array is more than 60 degrees from normal to the sun, sunlight is attenuated in power density by 50%, ( $\cos 60^\circ = 0.5$ ). Figure 4A also shows how if the collector is not normal to the sun's beam radiation at mid-day, there is a further attenuation.

Usually such a collector is fixed facing south in the northern hemisphere or facing north in the southern hemisphere with its plane inclined at an angle to the ground equal to the latitude of the location. This places the plane of the collector parallel to the axis of the Earth so that it receives solar radiation exactly normal to its surface at noon on the equinoxes which is the fixed position which maximises the solar energy received over a whole year (in theory, neglecting seasonal weather effects). This presents problems near the equator, where the collector ideally should be set horizontally, since it should also be set at a sufficient angle for rain water run-off to wash away dust and dirt from the collector surface.

At noon in mid-winter and mid-summer, the array will be approximately 23 degrees away from normal, to the sun's ray, which is the equivalent of about 1 h 30 min before or after noon at the equinoxes: this represents an additional attenuation factor of around 8%.

The problem of attenuation of received irradiation can be largely corrected through the use of an appropriate design which permits the collector angle to be adjusted seasonally; it is fortunate that cosines of small angles are quite close to unity; 10 degrees lack of normality represents only 2% attenuation and it takes a full 37 degrees of divergence from the normal to attenuate the received irradiance by even 10%.

A substantial increase of usable solar energy can be gained by arranging for a flat plate solar collector to be movable so as to track the sun. If the array is tracked from east to west, following the sun so that the array is always normal to the sun's rays, then in theory the full intensity of sun light can be experienced (of around  $1000\text{W}/\text{m}^2$ ) from the moment the sun is above the east horizon until it starts to go below the western horizon at dusk, (which is the broken rectangular outline indicated in Figure 4B). In

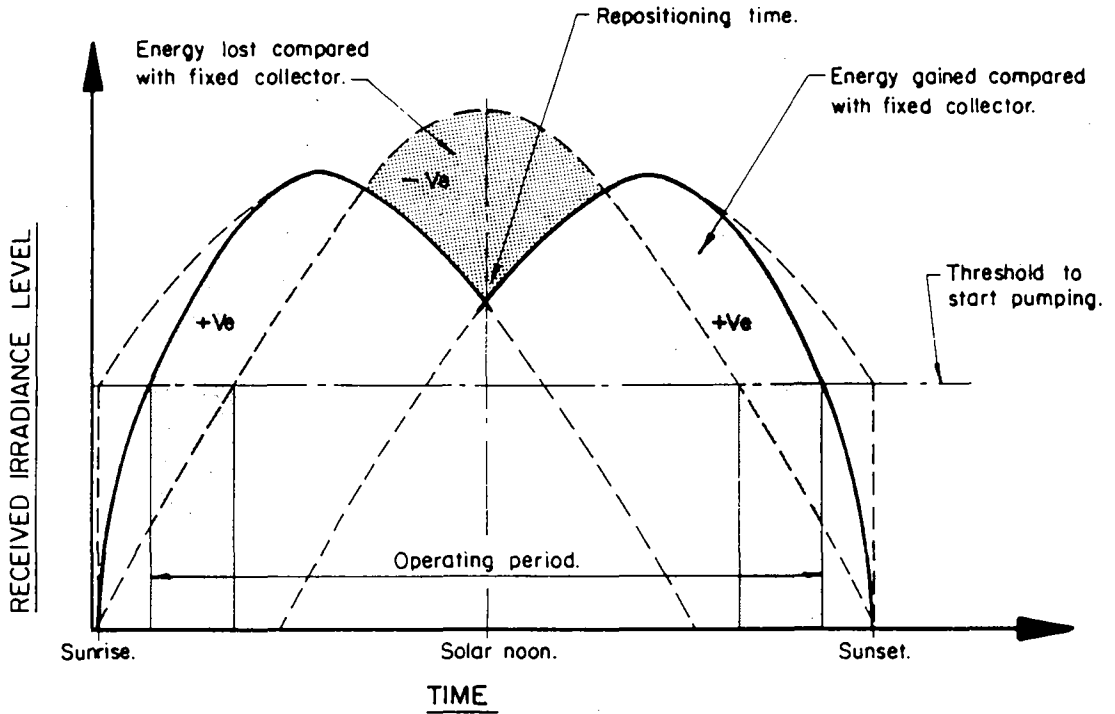

FIGURE 5A - VARIATION OF IRRADIANCE LEVEL RECEIVED BY COLLECTOR REPOSITIONED ONCE PER DAY

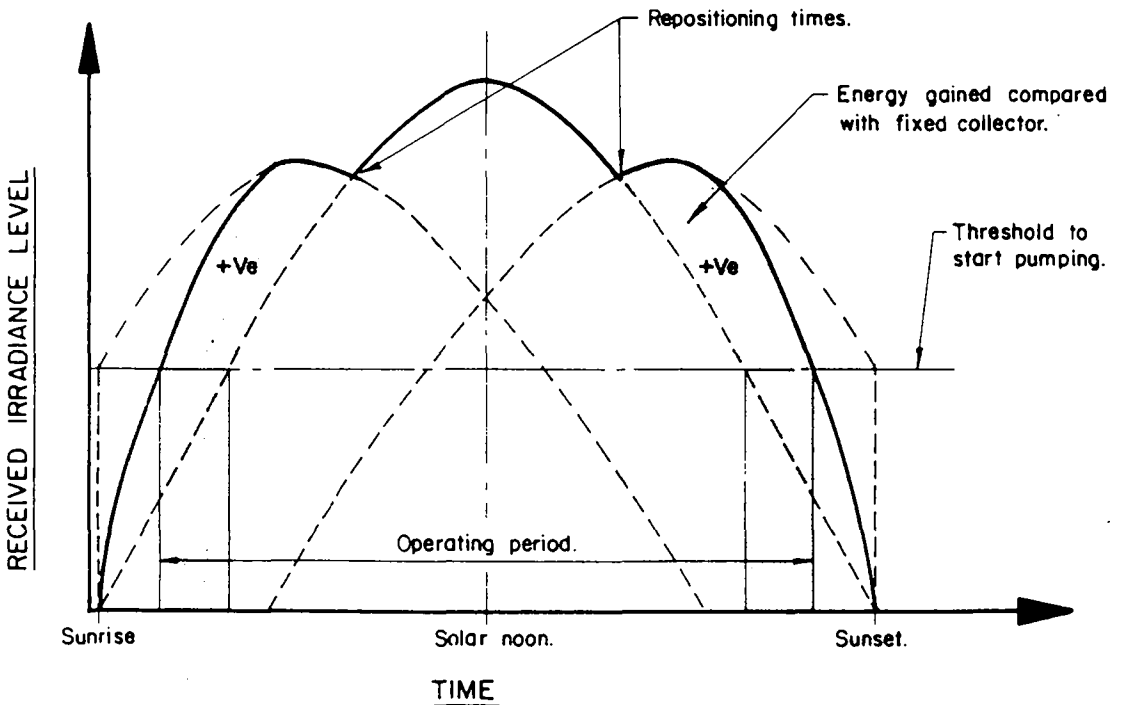

FIGURE 5B - VARIATION OF IRRADIANCE LEVEL RECEIVED BY COLLECTOR REPOSITIONED TWICE PER DAY

practice, even in very clear desert climates, the considerably increased thickness of atmosphere traversed by sunlight in the periods immediately after dawn and before sun-set serve to attenuate the level of radiation received, even normal to the sun's rays. As a result the solid curve in Figure 4B indicates the typical variation in irradiance level through the day if measured normal to the sun. Obviously climatic conditions can greatly modify these curves, but given clear conditions, they are close to reality.

By comparing Figures 4A & B, it can be seen that a perfectly tracking collector will achieve a given threshold irradiance level earlier in the day and permit a longer running time for a solar pump compared with one having a fixed collector. Also, extra energy can be collected due to the greater power density available in the sunlight normal to a collector. In simple geometric terms the extra energy gained by perfect tracking can be 50% or more. The gain can be greater in certain areas where it is commonly more cloudy in the middle of the day. In addition certain solar systems can achieve a higher average conversion efficiency if the input energy variation, between the starting threshold and the maximum, is kept small.

Perfect solar tracking is difficult to achieve, as it requires that the collector be driven with precision through 180 degrees in 12 hours, and that it varies in inclination as well as in azimuth due to the seasonal motion of the sun's apparent path across the sky. It is possible to maintain close to the optimum orientation of a collector by tracking it in a single plane normal to the earth's axis, (i.e. by rotating it about an axis inclined to the horizontal at an angle equal to the local latitude). Occasional seasonal adjustment increasing the inclination by up to 23 degrees in mid-winter and reducing it by the same in mid-summer can marginally improve the collection of irradiation. As will be explained later, really accurate tracking is only necessary where concentrating collectors with high concentration ratios are used, in order to keep the focussed image of the sun on the absorber area.

The provision of automatic and continuous tracking can greatly complicate what otherwise would be an extremely simple, fixed system, and introduce both extra costs and a lower level of reliability. Therefore, it is interesting to consider a useful compromise involving the occasional reorientation of a movable "fixed" collector, by hand. Figures 5A and 5B show the effect of moving such a collector, once per day and twice per day, respectively. In both cases it is assumed that the collector is optimally orientated and that it is moved at the correct times.

It is clear that moving such a collector once per day extends the running time for a solar pumping system having a given starting threshold to almost the same period as with continuous tracking: early morning and late afternoon performance gains would also be expected. However, a certain proportion of the peak mid-day irradiance that would be picked up by a fixed array is lost.

Figure 5B shows that moving a collector twice per day even allows the mid-day peak irradiation to be collected and results in about 95% of the irradiation available with continuous tracking to be received. Clearly there is substantial potential in tracking, either continuously or occasionally. At least 40% extra energy can become available through the use of some form of collector reorientation or tracking.

b) Solar pumping "hardware" efficiency

The main objective is to achieve the most cost-effective rather than the most efficient system. Efficiency, however, is crucially important in order to minimise system costs, providing it is not pursued so far that diminishing returns set in. Certainly, the more efficient systems field tested under this Project also tended to be the most cost-effective.

Figures 6 and 7 illustrate the instantaneous power flow through a typical PV and a typical thermal small pumping system. With PV systems most of the losses occur at the cells in conversion of light to electricity, while in thermal systems most of the losses are shared between collector heat losses and the rejected heat and other losses from the heat engine. In either case, only about 4% of the input energy appears in the form of hydraulic output.

c) Distribution losses in irrigation

As previously explained, the distribution system will involve losses, either due to water that fails to reach the roots of the crop (through leakage, percolation into the soil or evaporation) or due to the energy used in providing the extra head necessary to distribute the water. With very low static heads, this latter loss can be substantial.

Bad management can result in further losses, through water not being directed correctly and running to waste, or through the system not being used at times when it could be, thereby losing solar energy that could have been usefully applied.

## 2.8 Alternative Applications for Solar Pumps

There are two major problems in applying solar pumps for irrigation applications:—

- o the low cost for which water must be delivered (less than 6 US cents (1981) per cubic metre).
- o the relatively variable demand for water, often with high but brief peak demands and long periods with no demand at all.

Both of these require a lower cost system than can readily be manufactured at present and either subsidies or large and speculative investments are needed to produce the breakthrough to high volume manufacture and low unit costs that is needed.

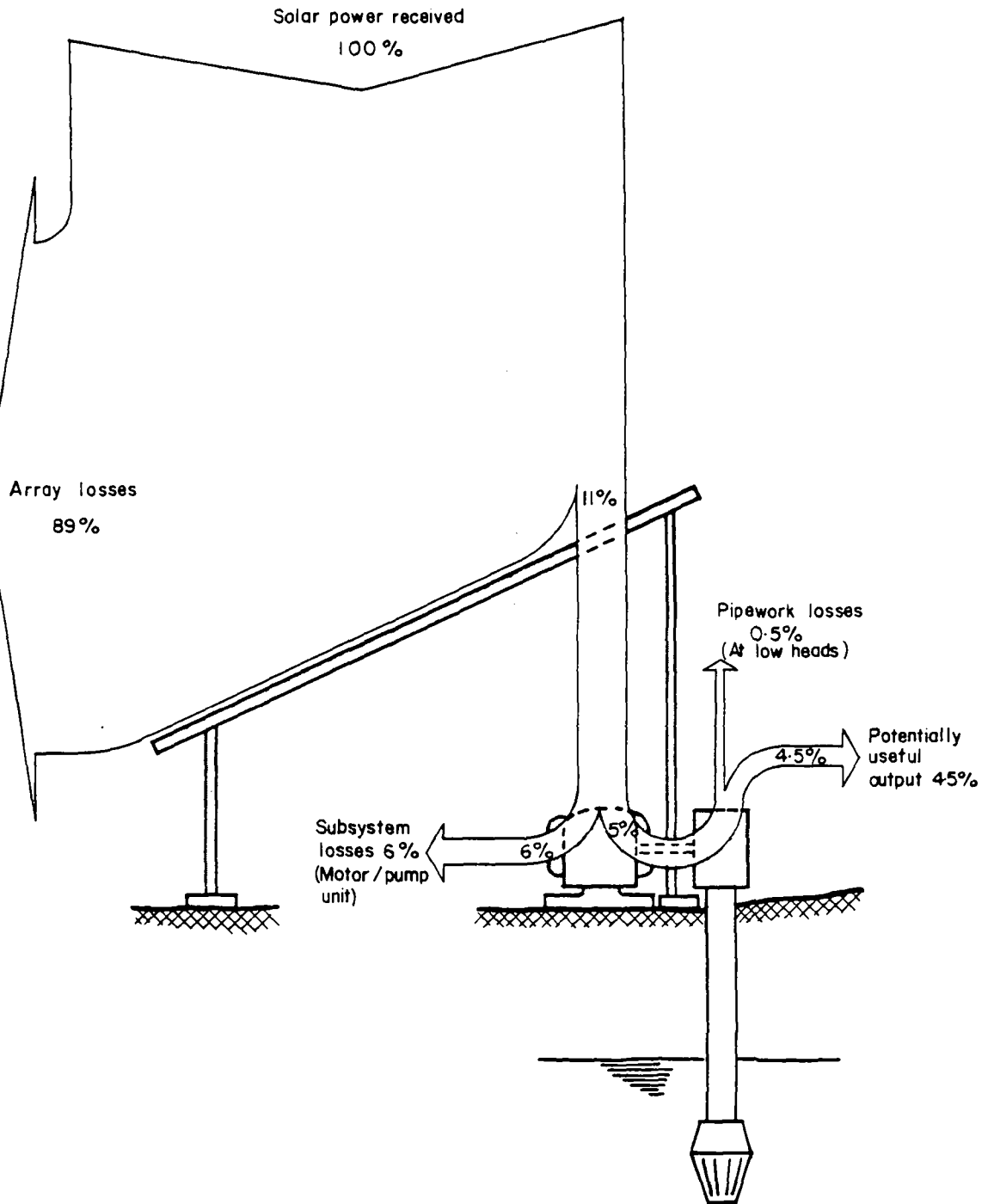

FIGURE 6 – LOSSES IN A TYPICAL SOLAR PHOTOVOLTAIC PUMPING SYSTEM

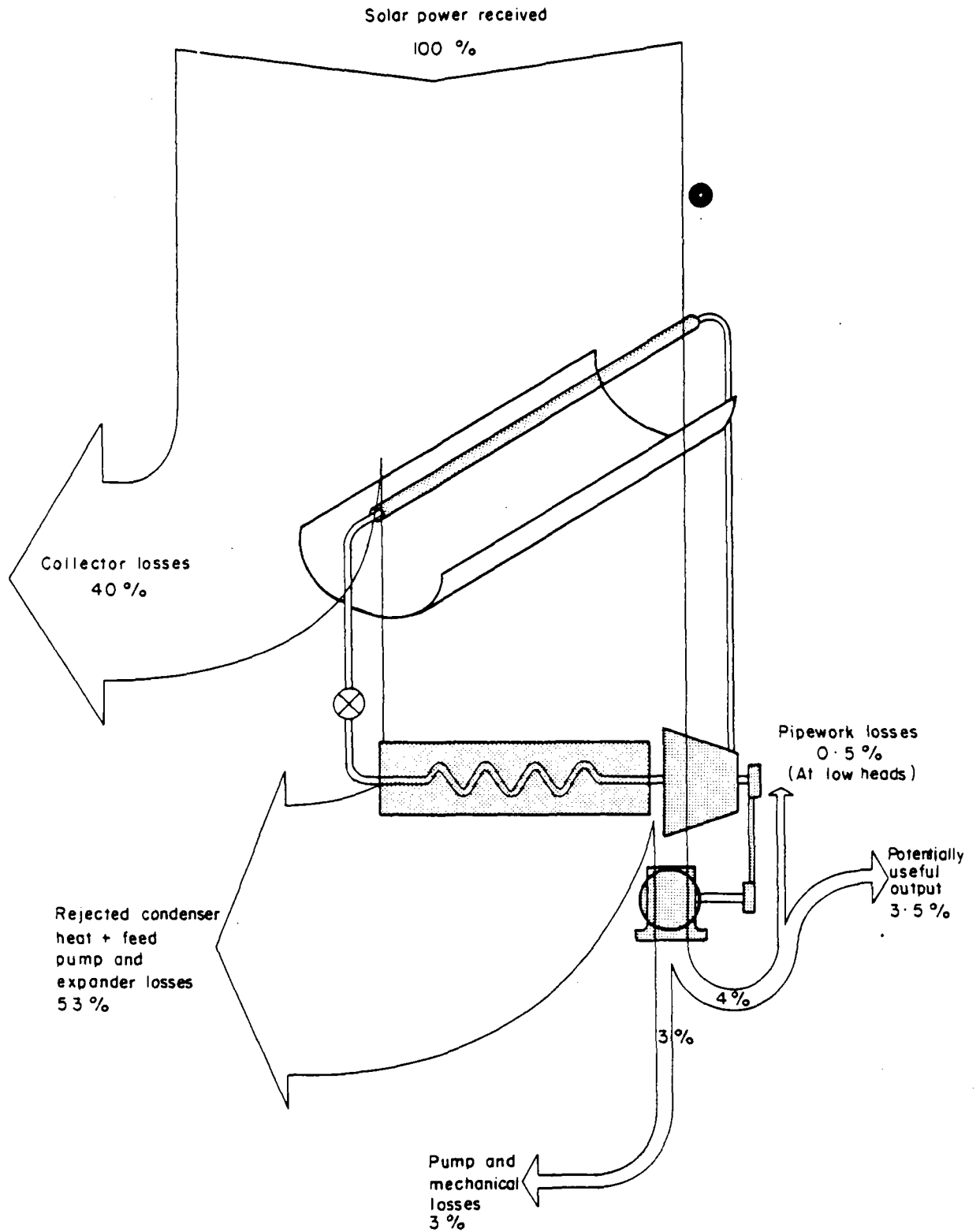

FIGURE 7 - LOSSES IN A TYPICAL SOLAR THERMAL PUMPING SYSTEM

However, the provision of pumped water supplies from boreholes or wells in remote and arid or semi-arid regions will tolerate rather higher investment costs (and unit water costs) than irrigation and also tends to be an end-use with a steadier year-round water demand. It is likely that solar pumps, even at current prices, might be at or close to economic viability for such applications, providing the pumping head is not too great. It is precisely for this kind of application that the autonomy of a solar pump is a valuable asset; the low level of maintenance that is (at least in principle) possible coupled with long life and no fuel requirements makes the technology potentially attractive to those institutions responsible for maintaining remote water supplies.

It was beyond the scope of Phase I of the Project to look at applications other than irrigation, but these will be considered in the future phases of the Project.

It may be that through the initial use of solar pumps for premium applications like water supply, the scale of manufacture will develop to a level where prices drop and the prospects for using solar pumps for irrigation substantially improve. However, most water supply applications will be through high pumping heads (greater than 10m) with the consequent deployment of positive displacement pumps, whereas centrifugal pumps are more appropriate for the low pumping heads (up to 10m) which are generally required for economic irrigation pumping. Therefore, although there is considerable overlap in the technical requirements for both end-uses, there are also some significant differences.

Another important possible application for small-scale solar pumps is to provide water for cattle and other livestock in semi-arid regions from boreholes. Again, a higher unit water output cost is tolerable and the demand is steadier than for irrigation.

A possible virtue of small-scale solar pumps for this application, in addition to the obvious ones of needing little in the way of external supplies or maintenance, is that they can be sized economically to produce a much smaller output than is readily possible with engines. A major problem with the provision of water for livestock in developing countries is overgrazing that can result from excessive concentration of animals around large-output watering points. The provision of a greater number of smaller watering points would mean that herds could be limited in number and hence more efficient use made of the available grazing.

Pumping with a small flow rate over a longish time period, as with a solar pump may also have advantages in areas where there is a large draw-down on the well at higher flow rates, or where the well may even be pumped dry when using an engine (which can cause severe damage to the well and pump).

It is worth noting that to achieve the declared goals of the current UN International Drinking Water Supply and Sanitation Decade, new water supplies will have to be commissioned to provide for the needs of an average of half-a-million people every day of the decade until 1991. There seems little doubt that solar pumps could and will play a useful part if a programme as ambitious as this is to succeed.



### **3. ECONOMIC AND TECHNICAL FEASIBILITY**

#### **3.1 Introduction**

The previous chapter has reviewed the potential role of small solar pumps in irrigation practice and deliberately avoided more detailed discussion of the economic, technical and developmental questions which need to be resolved if solar pumps are to be used successfully in practice.

This chapter is in three parts:

- o system economics
- o technical requirements
- o importance of local manufacture

In the section on system economics a description is given of an economic evaluation of and comparison between solar pumps and engine pumps designed to irrigate 0.5 ha. A baseline model was first developed and run, and a sensitivity analysis was then performed to test the way in which the economic picture was affected by variation of the more important assumptions implicit in the model.

The section on technical requirements is based on the experience of the Consultants on the Project with the systems undergoing field tests. It illustrates that attention to practical design points, simplicity of operation and reliability is as important as high efficiency.

The final section in the chapter discusses the critical role of local manufacture of part assembly in the introduction of a new technology into a developing country and the difficulties of implementing such a policy.

#### **3.2 System Economics**

##### **3.2.1 An economic model for sensitivity analysis**

It is difficult to make absolute economic judgements on small-scale solar pumps because not only is the technology immature but also evaluation is made difficult by the variability and uncertainty of many parameters that affect the pump system economics.

One of the economic guidelines proposed by the World Bank for the Project was that the cost of irrigation water delivered to the field should not be more than \$0.05 per cubic metre (1979; the equivalent figure for 1981 may be taken as \$0.06 per cubic metre). This was taken to be a globally representative figure which, if attained, would mean that the extra income obtained from the additional crops would yield a reasonable return. The adoption of this figure does not imply either that in certain areas pumps providing water at a greater cost will not be viable or that, if the cost is lower the pump will necessarily be economic.

Despite such uncertainties it is possible to set up a plausible "baseline" economic model and use this as a tool to investigate the sensitivity of solar pumping system costs to variation of different parameters. Such a model can also be used to indicate the relative costs of a solar pump compared with alternative and competitive options.

The analysis was conducted in purely economic terms and in principle considered all the costs to the economy regardless of who incurs them. Financial costs, e.g. subsidies and taxes, were excluded because these represent a transfer of money within the economy rather than a cost to it. In many cases there may be no truly economic means to produce increased food crops, in the sense that for social reasons food needs to be underpriced, particularly in countries with poor populations. So the fact that in many cases neither engines nor solar pumps appear to be economically viable needs to be viewed in that context.

The economic analysis was based on 1981 US dollars prices for present day costs, allowing for inflation at a rate appropriate to each of the individual inputs to the projected cash flows, rather than differential inflation.\* A real discount rate of 10% was assumed when compared to the general rate of inflation.

While the absolute cost figures in the model will only be indicative, they can be used to draw helpful comparisons on the costs of delivered water, as well as on their relativities, and their sensitivity to alterations in key state variables or design parameters. This model has been used to compare the effects of varying different key parameters on the relative costs of small-scale solar pumps and small engine driven pumps. The reason for comparing solar pumps with engine driven pumps is that much of the current interest in solar-powered pumping stems from the substantial increase in petroleum-based fuel costs during the last decade; hence such a comparison gives an indication of the soundness (or otherwise) of substituting solar pumps for engine-driven pumps, but in itself will not demonstrate the economic soundness of either alternative.

For the purposes of examining the general parameters that affect solar-pumping system costs, the model considers one of the most cost-effective PV systems, representative of best current practice, and applies suitable assumptions as to the likely future inflation rate that will affect replacement systems and maintenance costs. Any radical technical developments that could affect the economics through step changes in typical performance or costs are not considered; such possibilities are discussed in following chapters and would of course make solar pumping that much more viable.

### 3.2.2 "Baseline" Model Assumptions

The analysis for the model was run on a computer which was programmed with the parameters indicated in Table 4. These parameters are solar pump related or engine related or external parameters which are independent of

---

\* It is appreciated that it is more usual to make economic analyses at constant (1981) prices, allowing only for differential movement in prices, but in this case which involved inflating different cash streams at different rates it was more convenient to do the calculations in the way described.

**BASE-LINE MODEL: 0.5 ha****SOLAR PUMP PARAMETERS**

System Unit Cost Period for Economic Analysis of Solar Pump	\$ 10 /W Peak
Annual Maintenance Costs Year 1	= Computed System Life in Years
Design Operating Life	\$ 100
Av. Subsystem Efficiency	15000 hr
Overall System Efficiency	40%
	4.4%

**ENGINE PARAMETERS**

Engine Rated Power	3 kW Peak
Derating Factor	0.667
System Unit Capital Cost	\$ 600 /kW
Period for Economic Analysis of Engine Pump	= Computed System Life in Years
Annual Maintenance Costs Year 1	\$ 0.50 /h run
Estimated Operating Life	2000 h or up to 7 years maximum
Engine Efficiency	15%
Subsystem Efficiency	40%
Overall System Efficiency	6%

**EXTERNAL PARAMETERS**

Discount Rate	20%
Ave. General Inflation Rate (including engines)	10%
Ave. Fuel Price Inflation Rate	15%
Ave. Solar Pump Inflation Rate	5%
Ave. Water Delivery Head	5 m
Water Del. Head at Pk. Demand Time	5 m
Ave. Daily Water Demand for 0.5 ha.	20 m <sup>3</sup> /day
Peak Daily Water Demand	50 m <sup>3</sup> /day
Ave. Daily Irradiation	6.1 kWh/m <sup>2</sup>
Ave. Irradiation at Peak Water Demand	6.4 kWh/m <sup>2</sup>
Fuel Cost at Year 1	\$ 0.4/litre

**COMPUTED RESULTS**

Actual Annual Energy Demand	99 kWh
Required Array Peak Rating	319 W
Solar System Capital Cost	\$ 3193
Solar Pump Utilisation Factor	0.4
Solar Pump System Life	11 Years
Engine Capital Cost	\$ 1800
Engine Fuel Consumption	165 Litres/Year
Engine Running Time Per Year	124 Hours
Engine Operational Life	7 Years
Cost of Water in Year 1 : Solar Pump	11.46 c/m <sup>3</sup>
Cost of Water in Year 1 : Engine Pump	8.58 c/m <sup>3</sup>

**TABLE 4 – PARAMETERS FOR BASELINE MODEL**

the type of pumping system.

A 1981 system unit capital cost of US dollars \$10/W peak was assumed, where peak watts correspond to the array rated electrical output in an irradiance of 1000W/m<sup>2</sup> with a PV system. Prices of the most cost-effective systems currently available are in fact approximately twice to three times this level but it would not be realistic to use prices relating to systems that are manufactured in the small individually hand-assembled quantities currently applicable for solar pumps, and then to compare the apparent economic costs with such a mature product as a mass-produced diesel pumping system.

The price of \$10/W pk is used because that appears to be the economic price of a small-scale solar pump (of around 200-300W array output in peak sunlight conditions) if it is manufactured and shipped in quantity. The breakdown is approximately \$7/Wpk for the array and \$3/Wpk for the Balance of System (BOS). The latter consists of a motor at typically \$300, a pump at \$250, and it is assumed that the packaging, electrical connections and pipework plus the array support structure could be provided for no more than around \$200, giving a total of \$750 or \$3/Wpk with a 250W system. It is also assumed that various optimisations discussed in the companion Project Report, which can improve the system cost-effectiveness will have been successfully implemented to achieve the performance/cost requirements necessary for \$10/W pk. There is obviously some uncertainty about this assumption, but the value of a sensitivity analysis is that if the baseline assumptions are thought to be wrong, the effect of changing them can readily be assessed (see example of Figures 9, 10 and 11).

In the analysis, the system life is calculated from the assumed operating life and the calculated number of hours per year of running time required to meet the water demand. In the baseline model an operating life of 15000 hours is assumed; there is no guarantee any present-day system will actually achieve this, but a life of this order is necessary if reasonably low costs are to be achieved. Motor brushes (if fitted), motor and pump bearings, and almost certainly the pump impeller will have to be replaced during this period, but an average annual maintenance cost of \$100 is assumed to allow for this. Also the array, which is a major cost element, will quite probably exceed the life-time requirement assumed.

Finally, the solar pump subsystem (motor and pump) is assumed to have an overall efficiency of 40% (on average) which is in line with the best small subsystems currently available. It is assumed that the baseline system efficiency is at the highest level currently achieved by the best small-scale solar pumping systems (4.4%), since any production model will require to be well optimised if it is to succeed.

The period used in the economic analysis to calculate the system annualised capital cost was taken as equal to the system life.

The baseline engine is assumed to be the smallest diesel type generally in widespread use, i.e. of about 3kW rated power. However, it is derated to 67% of peak power (this is the average running power assumed, including idling time) and the average engine shaft output efficiency is taken as 15%. Various references were consulted for costs and the consensus arrived at was about \$600/kW (rated). Useful references for this and other parameters were (8), (9), (10), (11), (12) and (13). As with the solar pump, the life of the engine is calculated from its estimated operating life (typically 2000 hours for a small diesel in tropical field conditions).

Maintenance costs are taken as \$0.50 per hour, which is a reasonable average figure especially as they do not greatly influence total annual cash flows (see the sensitivity analysis curves of Figure 9).

The value of 40% assumed for the engine subsystem efficiency includes the pump, pipework losses (at low heads the pipe friction and related losses can be a large proportion of the total head for engine pumps) plus any mechanical transmission if the engine is not directly coupled to the pump. This is not a best, but an average efficiency, and is in line with the practical results such as reported in Reference 15 with regard to kerosene-fuelled irrigation pumps in Sri Lanka.

The external parameters consist of economic assumptions on discount and inflation rates, together with information on the water demand, head and the two energy resources - irradiation per day and fuel costs. It is worth emphasising that the assumptions on discount rates and inflation are not generally applicable but are simply taken as reasonable economic values to test the sensitivity of the costs of the two systems to variations in them.

The overall period taken for the baseline analysis should be a whole multiple of the lives of each of the capital items which require replacement: in this case 11 years for the solar pump and 7 years for the engine. The baseline analysis was done for a period of 22 years, allowing for one solar pump replacement and two engine replacements. The eight year life of the second replacement engine will have negligible effect on the figures.

The discount rate should be real (i.e. in a model using inflated cash flows greater than the inflation rate by the discount rate chosen) and reflect the opportunity cost of capital. Therefore, for the baseline model, the differential between the discount and general future inflation rate is taken as 10%. Fuel price inflation, which has risen substantially more than that (of the order of 25% per annum in the last few years) is taken as 15%.

Because solar pumps are an immature technology, with falling costs in real terms anticipated as the production volume of solar PV cells in particular increases, the inflation rate applicable to them will be lower than the general rate of inflation, and substantially lower than the likely inflation rate for petroleum-based fuel costs. The inflation rate applicable to the replacement costs of solar pumping systems has been assumed to be 5% i.e. at half the general inflation rate. This is an unavoidable weakness in the analysis as it certainly would not be correct to assume that solar pump costs will increase in line with general inflation, but there is no certain way of judging whether the average rate chosen for the baseline model is realistic, although it is believed that it is not seriously incorrect.

The pump operating head for the baseline model is taken as 5m as a representative value. At lower heads the application will be more economic, but the costs of irrigation at higher heads may not make it a widely applicable technology for some time.

The land area to be commanded by the baseline model was taken as 0.5ha, as this requires a solar-pumping system capable of being portable, of a not unreasonable capital cost and which would compete particularly well with engine powered pumps as they are least competitive for such small, but common land holdings. The market for a system of this size would appear to be sufficiently large to permit significant economies to be made through mass production.

The model's irrigation water demand and its variability are for a mean water requirement (over the year) of  $20\text{m}^3/\text{day}$  ( $40\text{m}^3/\text{ha. day}$ ) and a maximum of  $50\text{m}^3/\text{day}$  ( $100\text{m}^3/\text{ha.day}$ ). This compares with 47 and  $103\text{m}^3/\text{ha.day}$  for the Chad example previously used by way of illustration (see Table 2). The Chad data are of interest as they represent an area which should be favourable for the use of solar powered pumps due to its low rainfall and high irradiance levels. The baseline data are representative of a slightly less, but still favourable area.

As indicated in Figure 1, only a fraction of output can usefully be applied to the crops; this is the Utilisation Factor, (given in the "computed results" of Table 4). The size of system needed to meet the specified maximum monthly water demand is calculated for the irradiation conditions specified for that month. From this, the Utilisation Factor is calculated by dividing the average water demand specified for the year by that for the month of maximum demand. This factor gives a measure of the oversizing of a solar pumping system required to cater for the variability of irrigation water demand. With the baseline example the Utilisation Factor is 0.4 (i.e. the average water demand over the year is 40% of that in the peak month); in the Chad example, the Utilisation factor works out at 46% and there are probably few places where a more favourable factor than this might be found.

The baseline engine fuel costs were set at \$ 0.40/litre, which is a reasonable economic cost for 1981 but which makes no allowance for inland transport (to deliver fuel in the field) and storage costs that will possibly add substantially to this figure in remote areas. Shortages of diesel fuel in many developing countries cannot be addressed by this simple economic model.

However Figures 8 and 9 allow the effect of higher fuel costs to be taken into account and are not large for such a lightly used engine as in the baseline model. These costs have no bearing on solar pump economics per se.

Subsequent runs varying the parameters to allow an assessment to be made of what would happen with a different baseline from that chosen are described later.

Year	SOLAR PUMP					ENGINE PUMP				
	Water Target Unit Cost (cents /m <sup>3</sup> )	Equiv. Annual Cost of Capital (n=11 i = 20%)	Annual Maint. Cost (\$)	Annual Total Cost (\$)	Avg. Water Unit Cost <sup>1</sup> (cents /m <sup>3</sup> )	Equiv. Annual cost of Capital (n=7 i = 20%)	Annual Maint. Cost (\$)	Annual Fuel Cost (\$)	Annual Total Cost	Avg. Water Unit Cost <sup>1</sup> (Cents /m <sup>3</sup> )
1981	6	737 <sup>2</sup>	100	837	11	499 <sup>4</sup>	62	66	627	9
1982	6	737	110	847	12	499	68	76	643	9
1983	7	737	121	858	12	499	75	87	661	9
1984	8	737	133	870	12	499	83	100	682	9
1985	8	737	146	883	12	499	91	115	705	10
1986	9	737	161	898	12	499	100	133	732	10
1987	10	737	177	914	13	499	110	153	762	10
1988	11	737	195	932	13	973 <sup>5</sup>	121	176	1269	17
1989	12	737	214	951	13	973	133	202	1308	18
1990	14	737	236	973	13	973	146	232	1351	19
1991	15	737	259	996	14	973	161	267	1401	19
1992	17	1262 <sup>3</sup>	285	1547	21	973	177	307	1457	20
1993	18	1262	314	1576	22	973	195	353	1521	21
1994	20	1262	345	1607	22	973	214	406	1593	22
1995	22	1262	380	1642	22	1782 <sup>6</sup>	235	466	2483	34
1996	25	1262	418	1680	23	1782	258	537	2577	35
1977	27	1262	459	1721	24	1782	284	617	2683	37
1998	30	1262	505	1767	24	1782	313	710	2805	38
1999	33	1262	556	1818	25	1782	344	816	2941	40
2000	37	1262	612	1874	26	1782	379	939	3100	42
2001	40	1262	673	1935	27	1782	417	1080	3279	45
2002	44	1262	740	2002	27	1782 <sup>7</sup>	459	1242	3483	48

<sup>1</sup> Calculated on a basis of an average of 20m<sup>3</sup>/day

<sup>2</sup> Equivalent to a capital sum of 3193 \$;

<sup>3</sup> Equivalent to a capital sum of 5461 \$;

<sup>4</sup> Equivalent to a capital sum of 1800 \$;

<sup>5</sup> Equivalent to a capital sum of 3508 \$;

<sup>6</sup> Equivalent to a capital sum of 6836 \$;

<sup>7</sup> Discounted over eight years

#### A. PW of Cash Flows over 22 Years

with: Average General Inflation Rate = 10%  
Average Fuel Cost Inflation Rate = 15%  
Average Solar Pump Cost Inflation Rate = 5%  
Average Discount Rate = 20%

##### (a) Solar Pump:

Solar Capital Cost (PW) = 3928 \$  
Solar Maintenance Cost (PW) = 1022 \$  
Total Solar System Cost (PW) = 4950 \$

##### (b) Engine Pump:

Engine Capital Cost (PW) = 3311 \$  
Engine Fuel Costs (PW) = 963 \$  
Engine Maintenance Costs (PW) = 634 \$  
Total Engine System Costs (PW) = 4908 \$

#### B. Ratio of solar System PW/Engine system PW = 1.01

TABLE 5 – COMPARISON BETWEEN COMPUTED COSTS OF SOLAR AND ENGINE PUMPS (BASELINE MODEL)

### 3.2.3 Baseline Model Results

Various key properties of the resulting system were calculated and these appear as “computed results” at the foot of Table 4. The annual cash flows of the solar and engine pumps for every year from 1981 to 2002 comprising the sum of the uniform equivalent annual costs of capital, annual maintenance costs and annual fuel costs, are shown in Table 5. The World Bank’s figure of 5 c/m<sup>3</sup> (1979) for water has been inflated at the general rate for comparison with an average unit cost of water calculated from the annual cash flow for each year on the basis of a daily volume of 20m<sup>3</sup>.

It must be appreciated that the annual cash flows (and the derived figures for average unit cost of water) depend on maintenance of the 22 year perspective for the economic analysis; if a 5 year or 10 year period were taken the results would be different. Steps in the equivalent annual cost of capital occur at years when replacement systems are required and the capital sums for replacements have been increased at the appropriate inflation rate.

The model calculates the Present Worth (PW) for each of the cash flows for the two options over the 22 year period of the analysis. The PW assessment enables an economic comparison to be made of the two sets of cash flows, each of which contains different patterns of expenditure over time. The results are given at the foot of Table 5.

For the baseline assumptions, over the 22 year period, the solar pump option has a PW just greater than that for the engine. In the view of all the uncertainties inherent in such analysis this slight difference is of no significance and on the basis of these assumptions there is nothing to choose between the systems on economic grounds.

The average unit cost of water each year is indicative of the way in which the economics of the two systems are moving relative to the target cost of water (inflated at the general level of 10%). As will be seen the trend is for the solar pump economics to improve while the economics of the engine pump deteriorates. If the analysis had been conducted over a shorter period the PW of the engine pump annual costs would have been lower than those for the solar pump, and if it had been taken over a longer period (ignoring the great uncertainties in so doing) the PW of the solar pumps would have had a more marked advantage over the engine.

### 3.2.4 Sensitivity Analysis

Key parameters in the baseline model were systematically varied to investigate the sensitivity of the comparison between solar-powered and engine-driven pumps to such variations. A programme of 28 such variations was completed, as indicated in Table 6. In all such computer runs, the key factors outlined in the column headed “description” in Table 6 were changed, although in some cases several parameters had to be changed to make the new model realistic.



Run No	Description	Actual Energy Demand kWh/yr	Solar Pump Utilisation Factor	Target		Unit Water Costs (1981) US Cents per m <sup>3</sup>		Engine	Ratio of PW (1981) of Solar and Engine Annual Total Costs for period 1981 - 2000		System Capital Costs (1981) US \$ Purchased in 1981		Engine Ratio a/b
				1981	2000	1981	2000		Solar	Engine	1981	2000	
1	Baseline* solar pump capital cost \$ 10/Wpk	99	0.41	6	37	11	26	9	49	1.01	3193	1800	1.77
2	Fuel cost inflation increased from 15% to 20%	99	0.41	6	37	11	26	9	65	0.93	3193	1800	1.77
3	Pumping head halved to 2.5m	49	0.41	6	37	6	17	8	40	0.71	1596	1800	0.89
4	Pumping head reduced from 5m to 3m	59	0.41	6	37	7	19	8	42	0.78	1916	1800	1.06
5	Lower discount rate (10% instead of 20%)	99	0.41	6	37	8	20	7	41	0.80	3193	1800	1.77
6	Higher discount rate (30% instead of from 20%)	99	0.41	6	37	15	33	11	58	1.21	3193	1800	1.77
7	Fuel cost inflation high at 25% & Solar pump inflation at 10%	99	0.41	6	37	11	40	9	99	0.89	3193	1800	1.77
8	Improved solar subsystem (50% instead of 40% efficient)	99	0.41	6	37	9	22	9	49	0.85	2554	1800	1.42
9	Water demand halved for 0.25 ha	49	0.41	6	37	13	34	15	80	0.71	1596	1800	0.89
10	Water demand doubled for 1 ha	198	0.41	6	37	11	22	5	33	1.41	6386	1800	3.55
11	Peak water demand reduced to 30m <sup>3</sup> /day	99	0.69	6	37	9	24	9	49	0.81	1916	1800	1.06
12	Peak water demand increased to 70m <sup>3</sup> /day	99	0.29	6	37	14	38	9	49	1.24	4470	1800	2.48
13	Solar pump life reduced by 50% to 7500 hr	99	0.41	6	37	16	43	9	49	1.47	3193	1800	1.77
14	Solar pump life increased by 50% to 22500 hr	99	0.41	6	37	11	30	9	49	0.93	3193	1800	1.77
15	Solar pump maintenance costs increased by 100%	99	0.41	6	37	13	34	9	49	1.21	3193	1800	1.77
16	Fuel costs in year 1 increased to 60c/litre	99	0.41	6	37	11	26	9	55	0.93	3193	1800	1.77
17	Fuel costs in year 1 at 60c/litre and 20% fuel inflation 10% solar pump inflation	99	0.41	6	37	11	40	9	79	0.90	3193	1800	1.77
18	Kerosene engine of reduced efficiency and cost	99	0.41	6	37	11	26	6	42	1.16	3193	800	3.99
19	System cost \$ 20/Wpk for 0.5 ha land area (20m <sup>3</sup> /day average)	99	0.41	6	37	22	44	9	49	1.84	6386	1800	3.55
20	Solar pump capital cost reduced to \$ 5/Wpk & Solar Pump inf. rate = 10%	99	0.41	6	37	6	24	9	49	0.65	1596	1800	0.89
21	Capital cost \$ 20/Wpk water demand increased to suit 1 ha land holding	198	0.41	6	37	21	40	5	33	2.69	12773	1800	7.10
22	Capital cost \$ 20/Wpk water demand reduced to suit 0.25 ha land holding	49	0.41	6	37	23	53	15	80	1.20	3193	1800	1.77
23	Capital cost \$ 20/Wpk pumping head doubled to 10m	198	0.41	6	37	42	80	10	67	2.69	12773	1800	7.10
24	Capital cost \$ 20/Wpk pumping head halved to 2.5m	49	0.41	6	37	11	26	8	40	1.20	3193	1800	1.77
25	Capital cost \$ 20/Wpk peak water demand reduced to 30m <sup>3</sup> /day (from 50)	99	0.69	6	37	16	40	9	49	1.44	3832	1800	2.12
26	Capital cost \$ 20/Wpk low discount rate (subsidised) at 10%	99	0.41	6	37	15	32	7	41	1.38	6386	1800	3.55
27	Capital cost \$ 20/Wpk low discount rate at 10% and high fuel inflation at 20%	99	0.41	6	37	15	32	7	57	1.17	6386	1800	3.55
28	Capital cost \$ 20/Wpk kerosene engine with fuel inflation at 20%	99	0.41	6	37	22	44	6	66	1.81	6386	800	7.98

\* For Baseline assumptions see Table 4

TABLE 6 — RESULTS OF SENSITIVITY ANALYSIS

Some of the changes investigated in the sensitivity analysis meant that the system lives of the solar pump and engine pump (consistent with operating hours of 15000 and 2000 - see Table 4) would not be 11 years and 7 years, as in the baseline analysis. To simplify the sensitivity analysis a uniform period of 20 years was adopted: even though this may not correspond with whole multiples of the lives of the two pumps, the error will be very small and make no difference to the conclusions.

Some key results of these runs are summarised along with the descriptions in Table 6.

### 3.2.5 Discussion of the Indications from the Economic Model Analysis

#### a) General

The absolute values obtained from the model can only be regarded as indicative, due to the large number of assumptions made, but the trends indicated by varying individual parameters are generally fundamental to the economics of small solar and small engine-powered pumping systems and are of potential significance in evaluating such systems under different conditions.

Table 6 provides a useful summary of key indicators that vary with the changed parameters. For example, factors that change the actual energy demand (i.e. changes in head or gross water demand) cause significant changes in solar pump capital cost and in engine fuel costs. This is a fundamental difference between the two systems; the solar pump only has a finite daily energy input per unit area of collector, so changes in demand require changes in size and hence capital cost, but the engine can run more or less to suit demand and simply uses more or less fuel in proportion\*. A second-order effect for the engine is that maintenance costs and the periods between replacement engines are a function of the average number of operating hours per day, which varies with demand. Large variations in demand will dictate the need for a larger or smaller engine, as is discussed in more detail in the analysis of the results that follow.

The effects of varying key parameters are perceivable from Figure 8, which shows the annual operating costs of selected systems. Figure 8 also illustrates the effects of different assumptions on inflation and discount rates on the unit water costs.

Some of the more significant influences on the unit cost of water, revealed by the analysis, for solar pumps are set out in the form of a sensitivity diagram in Figure 9 and these are discussed in turn in the sub-sections below.

---

\* This is the case for the comparison made in the analysis because the minimum practicable size of the engine (3kW) was still much more powerful than needed for the duty proposed. If it had been technically feasible to adopt an engine size which required it to run for 24 hours, the economic analysis would have demonstrated that installed power and capital cost were material factors.

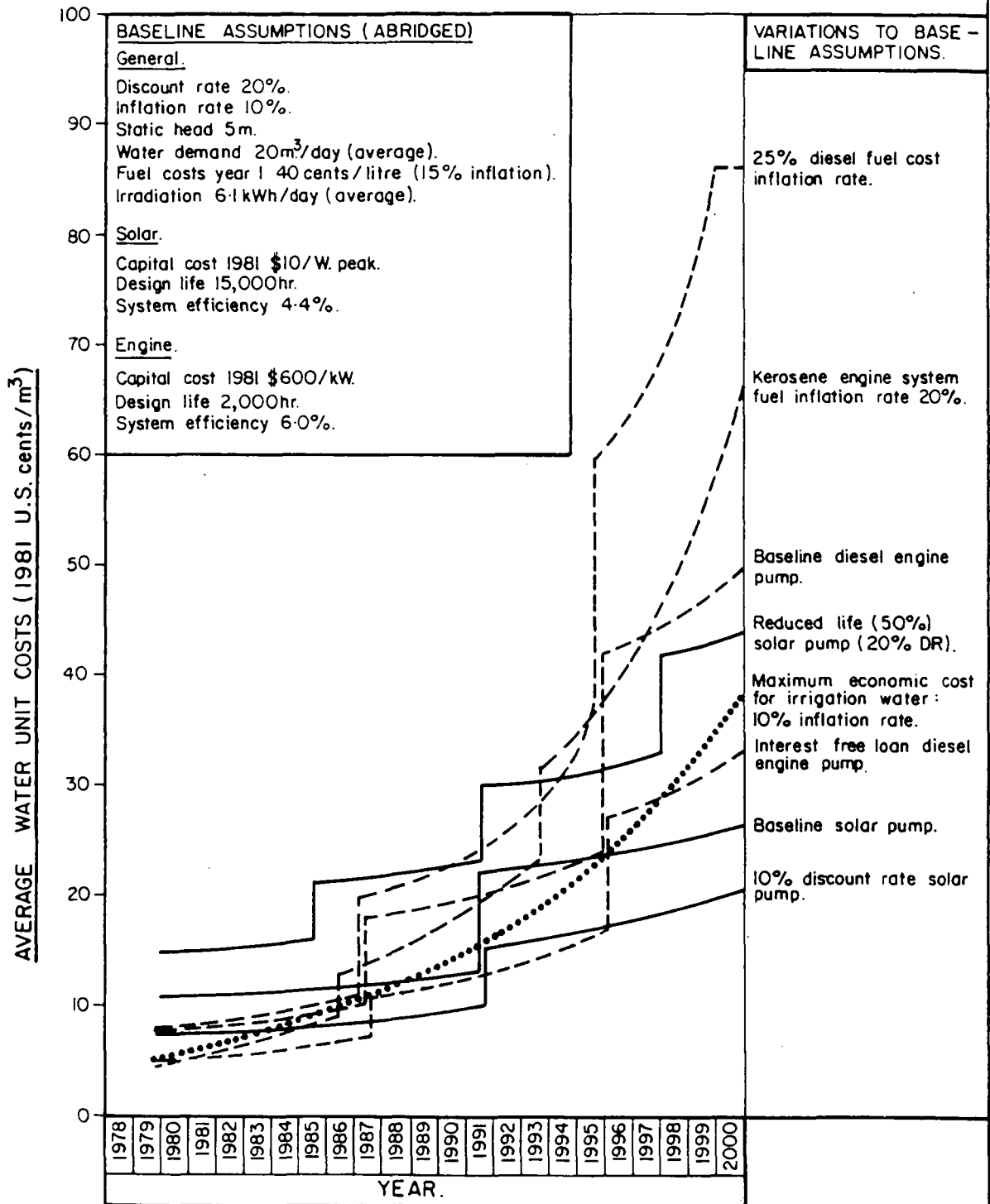
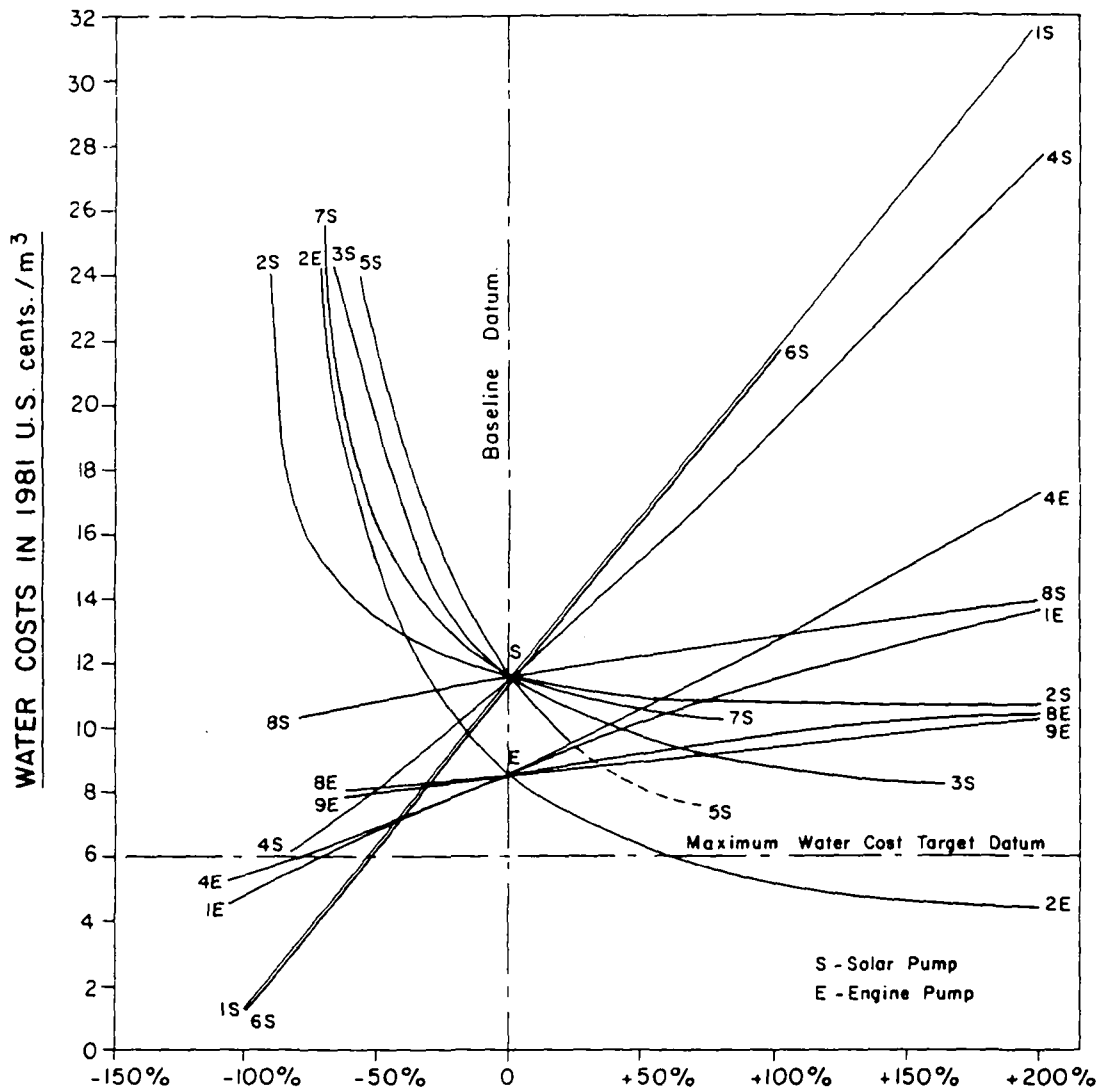

FIGURE 8 – EFFECTS OF INFLATION AND DISCOUNT RATE ON ANNUAL CASH FLOWS 1981-2000 (expressed in terms of average unit cost of water)



#### BASELINE MODEL ASSUMPTIONS;

##### General.

Discount rate 20 %  
 Inflation rate 10 %  
 Static head 5m.  
 Water demand 20m<sup>3</sup>/day.  
 Fuel cost 40cents /litre.  
 Irradiation 6-kWh/day.

##### Solar.

Capital cost \$10/WPK.  
 Maintenance cost \$100/yr.  
 Design life 15,000hrs.  
 System efficiency 4.4 %.  
 Rated power 320 W.

##### Engine.

Capital cost \$600/kW.  
 Maintenance cost 50cents/hr.run.  
 Design life 2,000hr.  
 System efficiency 6 %.  
 Rated power 3kW.

#### EFFECTS OF CHANGES IN ;

- 1 - 1. Head.
- 2 - 2. Water demand (land area commanded)
- 3 - 3. Solar pump utilisation factor (ratio peak to mean water demand).
- 4 - 4. Discount rate.
- 5 - 5. Solar pump system efficiency.
- 6 - 6. Solar pump system cost per peak Watt (of array output).
- 7 - 7. Operating life.
- 8 - 8. Maintenance costs.
- 9 - 9. Engine fuel costs.

FIGURE 9 – RESULTS OF SENSITIVITY ANALYSIS ON SOLAR PUMPS

b) Variations in Pumping Head

The solar system capital costs and the engine system fuel costs are directly proportional to head, all other things being equal.

Engine maintenance and capital costs are sensitive to head variation, as the higher the head the longer it has to run per year and it therefore requires more maintenance and more frequent replacement. By contrast, solar maintenance costs are a fixed sum and independent of head.

However, the solar pumping system has to be resized if the head is changed, but the engine need not be (it can simply run longer per day), so the capital cost ratio of solar pumps to engines increases with head. In other words, a "baseline" solar pump at 2.5m head is less than the 1981 capital cost of the baseline engine, but one for 10m has to be nearly four times the baseline engine cost.

Variation in the head also effects the Present Worth ratio, (i.e. life-time operating costs ratio), and the unit water costs of solar compared with diesel, year by year. Increasing the head, according to the model, makes solar increasingly uncompetitive with the engine mainly because the engine has to be worked harder, so its "load factor" improves.

Figure 10 shows how variations in head affect the unit water costs and how these relate to the assumed unit capital cost of the solar pumping system. It shows that for a solar pumping system to achieve the required 6 c per cu.m. at 5m pumping head, a unit capital cost of only \$5/W pk is required if all the other baseline system assumptions apply. Presently available systems costing over \$20/W pk can only be economically viable (on the 6c/m<sup>3</sup> assumption) for heads of little more than 1m.

c) Variations in Gross Water Demand

This has a similar effect on the relative capital costs of the baseline systems as varying the head, since it also causes a pro-rata change in energy requirement. i.e. the water demand for 1 ha requires four times the size of solar pump and four times the fuel for an engine pump as for 0.25 ha. Hence the capital cost ratio between solar and engines diverges with increasing land area or water demand.

The effects of water demand (or area of land commanded) on unit water costs are shown in Figure 11, for various assumptions on solar system unit capital costs and for the baseline and the baseline doubled engine fuel costs.

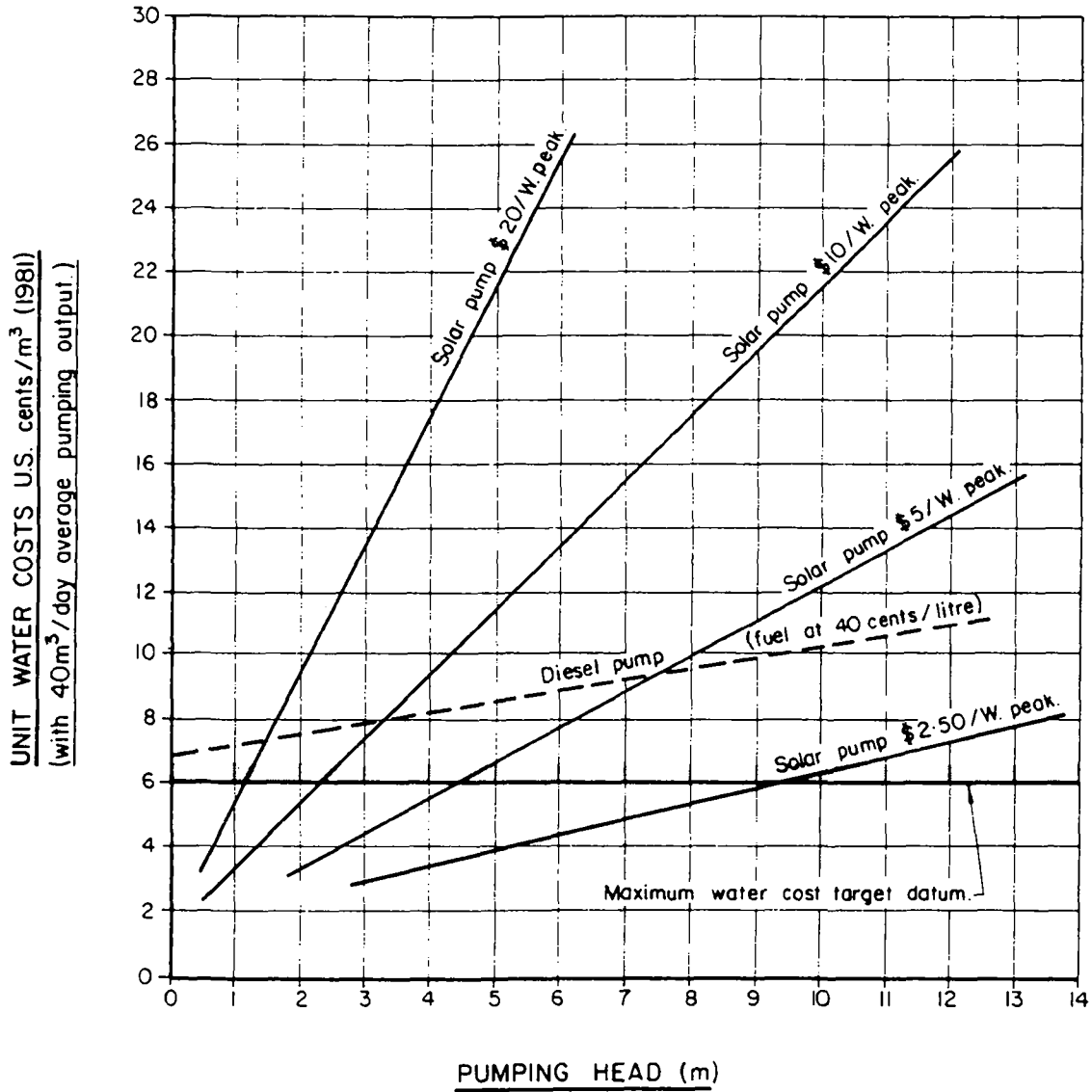

FIGURE 10 – EFFECT OF PUMPING HEAD OF WATER UNIT COSTS

It is clear that unit water costs for the engine begin to increase substantially for water demands of less than 40 m<sup>3</sup>/day. This probably represents the lower limit at which diesel engines can be effectively applied (the baseline engine represents about the smallest type of engine having reasonable efficiency and durability). This is because the engine is considerably oversized in terms of its capital cost and diesel fuel costs are not significant; doubling the fuel costs has only small effect on unit water costs in the baseline example. A kerosene or gasoline engine of lower capital cost and shorter life would probably have lower operating costs for such small land-holdings.

Conversely, if a diesel is used for larger land holdings of several hectares, then a larger unit of 5 to 10kW can be used, which in turn would be more efficient than the baseline example and would return lower unit water costs. However, there would be problems in sharing the water and the costs if such an engine were used for several small land holdings, and water distribution may also be difficult.

The unit water costs for solar pumps do not vary much with water demand, since the dominant cost is the array which increases almost pro-rata with demand. However, maintenance costs assumed to be \$100 regardless of size for solar pumps, have a significant affect on unit water costs for systems sized to deliver less than about 20 m<sup>3</sup>/day on about 0.5 ha or less.

The main conclusion is that solar pumps tend to be more competitive with engines for quite small daily water demands than for larger ones and, on the baseline assumptions, are most competitive for water demands in the 15 to 30 m<sup>3</sup>/day range (to suit about 0.3 to 1 ha).

If significantly larger solar pumps are considered, then the efficiency will improve but this will not greatly reduce unit water costs and it is possible that water distribution losses will outweigh any such minor gains.

Figure 11 also shows that for solar pumps coinciding with the baseline assumptions, the unit capital cost must come down to about \$5/W pk before they can produce water within the 6c/m<sup>3</sup> limit whatever area they irrigate. If their cost should ever fall to near \$2.50/W pk (and this is perhaps the lowest conceivable cost of current technology which could apply if PV arrays fall to 50c/W pk and the BOS to \$2/W pk), then solar pumps would be competitive with engines for all scales of usage and would appear to be economically viable for water demands as low as 10 m<sup>3</sup>/day.

Finally, it should be noted that the capital cost ratio between solar pumps and engines becomes increasingly unfavourable to solar pumps with increasing land area commanded; another

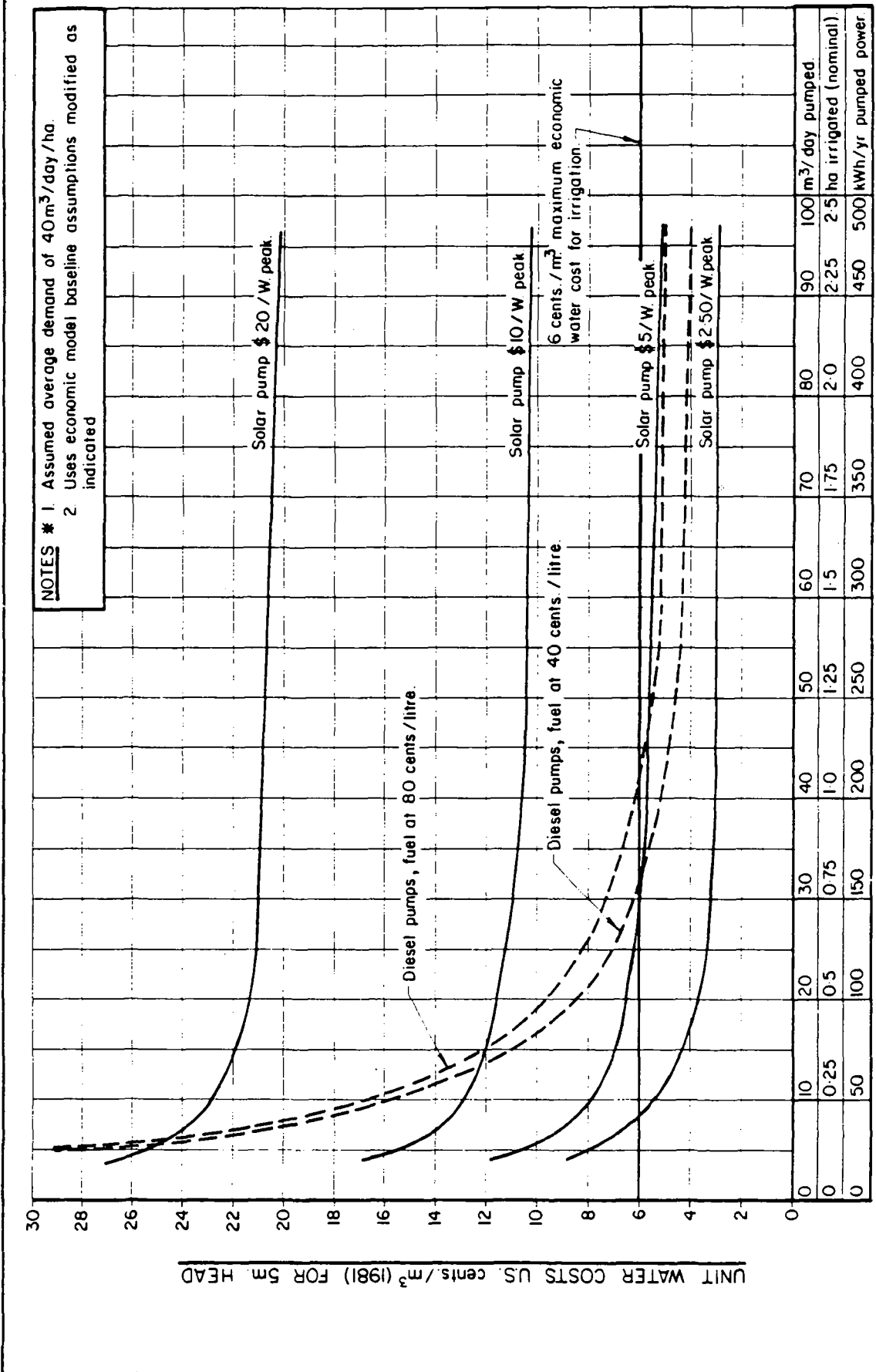

FIGURE 11 - EFFECTS OF WATER DEMAND ON WATER UNIT COSTS



reason to consider the use of solar pumps for small land holdings rather than large ones, (see Table 6). The capital cost ratio virtually increases pro-rata with land area, from about unity at under half a hectare to 3.55 at 1 ha (and 7 for 2 ha, and so on).

d) Variations in Utilisation Factor

The sensitivity diagram, Figure 9, indicates how increasing the solar pump Utilisation Factor by smoothing demand variations will significantly reduce unit output costs. A doubling of the Utilisation Factor reduces water costs by 17% (either by requiring a smaller system or by making a given system more productive), while halving it will increase unit costs by 70%. It is of great importance with solar pumps to achieve a good Utilisation Factor through applications with as consistent as possible year round water demand.

Engines on the other hand do not cost so much when they are not in use, and so poor Utilisation Factors do not significantly affect their water costs as much as solar. Therefore, solar water pumps become decreasingly competitive with engines in situations where the demand radically varies through the year e.g. where there is an extensive rainy season.

e) The Effect of Different Inflation and Discount Rates

Figures 8 and 9 show that the annual cost of solar pumps are highly sensitive to discount rate assumptions. Figure 8 indicates that halving the baseline discount rate gives a 30% reduction in annual costs, while doubling it gives a 70% increase. Halving the discount rate from 20% to 10% effectively means a nil return on capital invested since the general inflation rate is 10%. Although this is unlikely to occur it is valid for the purposes of sensitivity analysis and shows how the economics of solar pumps become more favourable compared with engines if the opportunity cost of capital is low.

As noted in section 3.1, it was not within the scope of the economic analysis to consider the financial strategy required to make the pumps affordable in the context of the introduction of new technology to a developing country. Such a financial strategy would consider reducing the financial cost to the farmer by subsidised capital costs or interest rates and would represent a transfer of resources within the economy: this would only be considered once the basic economic viability of the pumps had been established.

Figure 8 also indicates the substantial effect different fuel price inflation rates have on engine annual operating costs: an increase from the baseline assumption of 15% fuel price inflation to 25% causes engine annual operating costs virtually to double by the

year 2000, by which time the engine operating costs would be over four times the baseline solar pump costs, and three times the acceptable level for irrigation pumping.

The effect of assuming different fuel costs at year 1 has less significance for engine pumping system output costs in year 1 than might be expected due to the very small demands on the engine which result in fuel being only a small proportion of costs. In year 1, with the baseline example, fuel is only 13% of total engine running costs, although by 2000 it is over 30% even with only a 5% differential between fuel and general inflation. With kerosene or gasoline engines, which are of lower capital cost but lower efficiency, fuel would account for a considerably greater percentage of total costs.

f) Solar Pump System Operational Life Assumptions

Reducing the working life of the solar pumping system has a major influence on costs. This is shown in Figure 8 where a system with an assumed life of "only" 7500 hours running time (cf. the baseline at 15000) will have been replaced twice as often and amortized over half the period, resulting in annual operating costs approximately twice those of the baseline system. 7500 hours is actually quite a respectable life for most machinery and 15000 hours is exceptionally long for small machines, (for example, cars typically have an operating life of the order of 2500 to 5000 hours). Therefore a lot of attention to detail will be required from solar pumping system designers if such long lifetimes are to be reliably achieved.

Figure 9 illustrates what will happen if such long lifetimes are not achieved: for example a reduction to "only" 6000 hours results in a 70% increase in unit water output costs: the same as increasing the baseline solar pumping system unit capital costs from \$ 10 to \$ 17. In practice, it seems likely that the array could last much longer than the motor and pump unit, (possibly with a life of 20 years or more). This could be offset against subsystems with a shorter life than that indicated desirable by the present analysis.

Attempting to increase the operational life from 15000 hours, which would be technically difficult, appears to give diminishing returns.

Solar pumping irrigation systems should be designed and constructed for a life in excess of 10000 hours if they are to have the best prospects of becoming economically viable.

## g) Solar Pump System Efficiency

Varying the subsystem efficiency has the same effect as varying the solar pumping system overall efficiency by the same proportion. Any technical improvements which affect system efficiency will have a similar economic effect, whether they involve just the subsystem (motor and pump) or whether they include the PV array.

For one model run an improvement in average subsystem efficiency from 40 to 50% was tried which yielded a 17% improvement in costs. This is just technically feasible through good design, but must be close to the upper limit for such small motors and pumps.

More profound are the negative effects of worse than the baseline system efficiency. A 20% reduction in efficiency, from 40% to 32% (typical of many current solar pumping systems) results in a 26% increase in unit costs. Some of the poorest subsystems tested under the UNDP Project field test programme were only around 25% efficient; these would have unit output costs over 90% greater than for the baseline model. Lower efficiencies than this would be quite catastrophic to the economics.

## h) Solar Pumping Systems Considered as a "Mature Product"

If the unit capital cost of solar pumps falls substantially due to mass production, then the opportunities for further price reductions will become less marked and solar pumps will begin to increase in cost more in line with the general rate of inflation; in other words they will have become a "mature product".

In one run a higher inflation rate of 10% was envisaged for the solar pump replacement costs to emulate the effect. This is what would happen if solar pumps ceased to get any cheaper in real terms than £ 10/W pk in 1981. The result is a 110% increase in solar pump Present Worth which makes the solar pump just fail to deliver water within the 6c/m<sup>3</sup> limit for most of the period considered.

A more likely scenario if solar pumps ever develop to maturity is that their costs might drop to around \$ 5/W pk (in 1981 real terms) and then cease to get lower in real terms compared with the general inflation rate. Under this condition (run 20 in Table 6), a favourable Present Worth ratio is also obtained against the engine pump and even the solar pump first-cost is lower than that of the engine.

## 3.2.6 Conclusions from the Baseline Model Analysis

It appears that solar pumps will need to satisfy a number of economic and technical requirements if they are to pump water at an economic unit cost. Key requirements are:-

- a) solar pumping system capital cost down to be under \$5/W pk (in 1981 real terms) when product achieves maturity (full volume production).
- b) solar pumping system life to average in excess of 10000 hours (preferably about 15000 hours) before any major replacement costs are incurred.
- c) solar pump subsystem efficiency to be at least 40% and preferably better (giving an overall efficiency of at least 4.5%) over a reasonable range of operating conditions.

Until solar pump capital costs fall in real terms to less than about \$5/W pk, solar pumps will generally only be economically preferable to diesel pumps for small land-holdings having average water demands in the 10 to 30 m<sup>3</sup> per day range.

It is possible to combine features identified by the model as helping to reduce the costs of solar pumps to achieve earliest utilisation. For example, improved system efficiency, combined with increased life and offered at a subsidised price or with a soft loan in the interests of producing cheap food; if in addition the technology is initially popularised in very low head applications in small land-holdings where the water demand is relatively steady, then further cost reductions may be expected.

### 3.2.7 The Capital Cost Barrier to the Introduction of Solar Pumps

From the point of view of the economy of the country as a whole, the criterion for choice of solar powered pump or engine pump should be the PW of the annual cash flows over the twenty year period. These are given in Table 6 for each of the sensitivity analyses: any PW ratio (solar/engine) of less than unity means that a solar-powered pump represents the more economic option. This condition occurred for higher fuel costs, lower pumping heads and water demands, lower discount rates, more efficient solar subsystems, increased solar pump lives and lower solar pump capital costs.

However the capital costs of solar-powered pumps are a crucial factor in their adoption by farmers, since the capital cost is the predominant influence on the average unit cost of water delivered. For this reason the capital costs of solar pumps and engines were compared for each of the sensitivity analyses in the last three columns of Table 6. The first cost of the solar pumps was lower than that of the engine in only three instances: when either the pumping head was halved (to 2.5m), the water demand was halved (equivalent to an irrigation area of 0.25ha) or the capital cost of the solar pump was halved to \$5 per peak watt; the first two of these analyses were equivalent of course to the halving of pump capacity and first cost.

This capital cost barrier is one that can only be overcome by action taken by the Government or related national institutions. Farmers of small land-holdings in developing countries are very poor and possess no capital resources of their own, nor do they have ready access to private institutional finance. As was noted in section 2.6 once Governments are convinced that solar pumps represent a genuinely economic means of pumping water, consideration can then be given to providing the finance necessary for the purchase of the pumps on terms which the farmers can accept. This will probably mean a subsidy of one kind or another, implying a transfer of financial resources within the economy of the country: the acceptability and extent of such subsidy will depend on the policies of the Government towards the agricultural sector, the improved agricultural yields that may be obtained, the energy situation of the country and any reduction in oil imports which may result. Government backed agricultural credit schemes have been in operation for a number of years and their extension to the provision of solar pumps would not involve any change in principle.

However, it is not yet certain that the various technical and economic barriers to solar pump usage for irrigation will necessarily be overcome. Solar pumps are probably already economic for certain more remote water supply applications (as distinct from irrigation applications) where higher unit water costs are acceptable; it may be that the necessary boost to their development through quantity production will come initially through their wider use for water supplies in developing countries rather than immediately for crop irrigation.

### 3.3 Technical Requirements

#### 3.3.1 General

The detailed aspects of solar pumping system design are covered more fully in the companion Project Report and in the sections that follow, but certain general points are worth making at this stage.

Any pumping system for general use by farmers in developing countries (or for that matter by farmers anywhere) must be capable of reliable operation with minimal maintenance under harsh operating conditions. All equipment must therefore be constructed to the standards required for a long and reliable life under agricultural field conditions and major system components should achieve a useful life of the order of 10,000 hours or more. To do this requires robustness and high quality of construction.

In addition to all the normal hazards of general wear and tear and corrosion faced by machinery, solar pumping systems (in particular PV arrays) are likely to be subjected to rough treatment and careless operation: also, there is no guarantee that the operator will respect manufacturers' instructions, so the system should be effectively fail-safe; there should be no modes of self-destruction due to possible operator error.

It should be remembered that the points made in this section refer to equipment purchased in late 1979 and early 1980. Many manufacturers are of course aware of the need for improvement to their products and future progress will be considerably aided by collaboration between them and the users of their products, and the international agencies and their consultants employed on projects of this type.

### 3.3.2 General Limitations of Current Equipment

During the course of the Project the Consultants purchased and assessed the performance of a number of small-scale solar pumping systems under field conditions (in association with leading local institutions) in Mali, Philippines and Sudan.

As expected this work indicated that solar pumps can be an attractive technology, with few mechanical components to go wrong and needing little maintenance. However several problems were encountered in installing and commissioning the systems, and some of these point to ways in which the technology might be improved. Also a few of the systems performed badly or unreliably due to either conceptual or detail design errors.

It should also be added that both the Consultants and the various host country institutions involved provided professional engineers to supervise the assembly, commissioning and running of the systems (the Consultants' Resident Engineers also visited the relevant manufacturers' factories to witness the systems being tested prior to shipping). Despite the well trained personnel involved and the close connection to the supplier, many systems presented difficulties in commissioning of one kind or another – most were minor, but in one or two cases it proved possible to get the systems to run only after modifying them in the field, and then with difficulty and with performance below specification. In view of these problems the Consultants believe that some improvements are necessary before such systems can be assembled and successfully operated by small farmers in developing countries, although the potential for achieving the necessary degree of reliability and simplicity is certainly there.

All but one of the systems field tested were solar photovoltaic (PV), the only thermal system field tested was relatively immature and suffered a number of teething troubles that made the results of the tests inconclusive. This imbalance does not necessarily imply that PV systems are inherently superior to thermal systems, rather that it is more difficult to improvise a thermal system from off-the-shelf components because virtually all components require to be purpose-designed. Thus most of the first-hand practical observations which can be made at this stage refer to PV systems (although some would be common to either type).

### 3.3.3 Technical Concepts

Some examples follow which illustrate that there are likely to be good and bad conceptual approaches to small-scale solar pumping system design.

For example, a large proportion of the systems tested in the Project used surface-mounted suction-pumps, possibly because the specification was for low head applications (in line with the needs of small-scale irrigation), often pumping from surface water or from open wells. It appears more straightforward to design a suction pump system for such installations and also, it is easier to construct such a system by combining off-the-shelf components (this may have more to do with the manufacturer's convenience than with the needs of the final user).

However, a problem with suction pumps is priming them and maintaining their prime. This proved difficult and compromised the performance of at least two of the PV surface-mounted centrifugal suction pumps. Loss of prime can readily occur through a leaking footvalve. It only needs a particle of grit to lodge between the footvalve and its seat for all the water to drain back from the system as soon as the pump slows down or stops due to the sun being obscured briefly by a cloud, or at night.

Some of the pumps that more readily held their prime and avoided associated cavitation problems were vulnerable to damage in the event of running dry through loss of prime. One otherwise satisfactory pump burnt out its gland packing through running dry and thereafter leaked quite badly until a new seal was fitted, and another got so hot that it caused plastic pipe fittings to soften and distort. Only one manufacturer attempted to make their suction pump fail-safe by supplying a float switch to cut off the system if the water level fell too far but which would not cut off the system in the event of simple loss of prime. The only precaution another manufacturer took was to attach a label to the pump to warn against running the pump dry.

Although the positive-displacement surface-mounted suction-pumps that were supplied self-primed more effectively and tended to maintain their prime, they are inefficient at low heads and also relatively large and expensive.

Only three of the PV systems tested incorporated submerged pumps but in the Consultant's view these are the only options for this application. This was confirmed in practice, as the two best performers proved to be submerged pumps.

One other element of system design which needs more attention from system suppliers, is the type of installation envisaged; is everything to be bolted down on concrete foundations or is it possible to make a portable system that can easily be carried into place and quickly installed. Only

one supplier, provided the latter type of system, which was more straightforward to assemble and commission as a result. All the others required the casting of concrete foundations which may be needed if a considerable length of piping full of water has to be supported or where the stability of arrays under high winds has to be considered. Bolted down equipment may be more secure from theft, but on the other hand a portable system can be taken into the farmer's courtyard at night for safekeeping.

Solar-powered systems are commonly specified by their power rating under peak sunlight conditions (usually given as  $1000\text{W}/\text{m}^2$ ) and a number of manufacturers compromised the performance of their systems under the more common irradiance levels of about half peak sunlight conditions. The problems of system optimization are discussed in detail in the relevant chapters, but it would seem better if the trend of rating systems under peak sunlight conditions were changed to specifying the daily pumped output, perhaps under a standard solar day of say  $6\text{kWh}/\text{m}^2$  of received solar energy. In the end it is the volume of water that is pumped in a day, rather than the flow rate under peak sunlight conditions, that matters.

A number of systems were supplied with inadequate instructions, components missing and components assembled incorrectly by the manufacturer. This was partially due to the prototype status of some of the systems tested, and the relatively short delivery time allowed.

The needs and problems of the manufacturer still appear to weigh heavier at this early stage in the development of the technology than those of the end-user. For systems to be tailored more to the end-user will demand less reliance on "off-the-shelf" construction and more emphasis on the "purpose designing" of components, a trend which may even make such systems initially more expensive due to the component development costs that will be incurred coupled with the small initial volume of production that is likely.

In the meantime, the use of "off-the-shelf" components will no doubt have an important role to play in to popularising the technology and in gaining further field experience, providing serious conceptual errors that could bring the technology into disrepute are avoided.

#### 3.3.4 Detailed Design Points

One problem requiring further attention is the vulnerability to damage of PV arrays and solar collectors for thermal systems, particularly in transit from the factory. The array is the most expensive single subassembly for a PV system, and it generally uses a glass cover. In the case of thermal flat plate systems breakage need involve no more than the cost of replacing the glass, but with PV systems a broken cover generally means an



unusable module. Some of the modules used were rated at as much as 100W peak, which implies a replacement cost of around \$ 1,000. A number of breakages of this kind were experienced during the first Phase of the Project, both during delivery and in the field.

Two simple solutions to this problem might be the wider use of high quality plastic module covers (such as polycarbonates), which would perhaps mean a marginal loss of performance, and a marginal increase in cost, but a large improvement in durability. Alternatively, instead of the toughened glass used by several PV manufacturers which crazes if impacted, laminated automobile glass might prove superior (it is already used in one or two cases for this purpose). Another improvement would be the use of smaller and more numerous modules; this would have the disadvantage of involving more external electrical connections, but a single breakage would be less serious because the proportion of power loss would be small and the module would be cheaper to replace. Smaller units are cheaper to pack and transport and less likely to suffer damage in the first place. Such an arrangement would also allow more flexibility in the choice of array voltage-current combinations, giving a better chance of optimising the system performance more closely for different conditions.

No concentrating solar collector systems were tested during Phase I (none was available to suit our specification), but the same observations would of course apply to systems involving glass mirrors.

There was a lack of consensus by manufacturers as to the correct inclination for optimum performance from the system. There are problems in the tropics at equatorial latitudes due to the shallow almost horizontal positioning that is optimum for solar energy collection, but bad for rain-water run off and self-cleaning. Here an adjustable array has obvious benefits, especially if it could be calibrated with recommended positions for different seasons for the region in question. In addition, some arrays were too close to the ground, making them prone to collect dust and also more likely to be damaged by people or animals.

Wiring presented numerous problems, with badly (or in some cases wrongly) prepared wiring harnesses, poor instructions and it was often difficult to connect terminal blocks to connectors. No detailed analysis has yet been completed on wire losses, but it is believed these may be significant in many cases. Blocking diodes were another serious energy drain in some cases (and in two examples the systems were supplied with some or all diodes connected back to front). It follows that system arrays should ideally:

- o be adjustable in inclination and azimuth (or be fully portable)
- o have simple foundation requirements allowing for imprecise positioning with the array held well clear of the ground. Where loading conditions permit arrays should be fully portable and should not require any foundations.
- o have clear and simple instructions

- o have generous wiring and effective mechanical terminal grips to ensure good electrical contact. If possible blocking diodes should be avoided or be sized for low losses.

One system was supplied with a length of 25mm diameter hosepipe at the delivery of the pump. If this had not been changed to 50mm, a significant loss of performance would have resulted due to pipe friction.

Systems with suction centrifugal pumps can incorporate almost unclearable airlocks in the suction pipe-work due to poor design; one was partially cured by inverting the pipe and filling the space where an air bubble had been. However, this is not the kind of modification that ought to be required.

Another system was marred by a series of failures of electronic components in the electric motor commutation and in the power conditioner due either to overheating or to excessive transient voltages or currents. The system in question appeared sound in concept, and the circuits that gave trouble are worth including in the design - if they can be made reliable. The faults have been corrected but clearly electronic circuits incorporated in solar pumping systems need to use components with a tolerance of high ambient temperatures. They will also benefit from a degree of inbuilt protection from excessive temperature, voltages or currents which should trip-out the system if it overheats.

Operating voltages were generally around 60V. Lower voltages are undesirable, as they require a low-voltage high-current array with consequent greater resistive line losses, or the need for heavier and more expensive cabling to compensate. However, d.c. voltages greater than about 80V present an electrocution hazard (dc is more dangerous than ac) and for safety reasons are to be avoided; one system tested used 120V dc, but it is understood the manufacturer is changing this to a lower voltage. Hence it appears that systems optimised at about 80V would achieve the best cost-effectiveness without introducing any serious hazard.

Generally, it seems that there is a need for manufacturers to pay more attention to detail and to increase the level of quality control, inspection and pre-despatch testing that seems to have been applied to most of the systems purchased during the course of the Project.

### 3.4 The Importance of Local Manufacture

An important consideration, if small-scale solar pumps are to be used in large numbers, is their suitability for local manufacture or at least part-manufacture and local assembly. This is because one of the primary motivating forces in seeking

alternatives to engines for water pumping stems from the high cost of importing oil and the difficulty many developing countries are having with their balance of payments due to the oil price increases of recent years. Clearly if solar pumps are imported, then similar problems arise in finding the foreign currency to pay for them as for importing oil. However, if a significant proportion of the capital cost of solar pumps originates within the local economy, then they would be attractive in terms of import substitution and reduced foreign currency requirements.

Additional benefits from local manufacture would be:

- o shorter supply lines from manufacturer to user, resulting in:
  - a) more accurate system specification to suit local conditions
  - b) reduced shipping costs
  - c) minimisation of import formalities, and duties and the costs of intermediaries
  - d) more rapid and responsive spare-parts availability and after-sales service
- o job creation within the local economy
- o enhancement and upgrading of technical skills and capabilities within the country
- o reduced dependence on imported fuels (and a greater level of national self-reliance)
- o if lower pumping costs are achieved, then improved agricultural productivity and cheaper food may result with allied economic benefit to the rural population

Therefore, the question of local manufacture or part-manufacture is important when considering the merits of specific small-scale solar pumping systems for use in developing countries.

It can be expected that there will be a number of barriers to the development of the technology relating to the local manufacture requirement. A key one is that the large international manufacturers who might be expected to take an initiative in commercialising the technology are inhibited by a number of factors, such as:—

- o the potential market, although extremely large, consists mainly of poor farmers lacking capital resources. Therefore even when the technology is shown to be economic, the eventual market size will be dependant on intervention by governments and/or agricultural credit banks to set up suitable financing facilities. The consequent need for independent assurance is one of the main reasons why the UNDP/World Bank programme is of such importance.

- o unit costs, which are a key factor in achieving economic viability, are closely related to the scale of manufacture (particularly for photovoltaic cells). A commitment to a large scale of manufacture (a large investment) or heavy subsidies appear to be essential at an early stage to bring system costs down.
- o decentralised manufacture within individual developing countries, with minimised external costs to the local economy, is against the shorter term commercial interests of many large transnational commercial interests, since such companies would seek a good return in hard currency. Thus some companies capable of promoting the technology will have short term constraints which effectively militate against such development.
- o the engineering industries in developing countries, on the other hand, generally lack the research and development capability to develop new products. Sometimes they actually have the capability but simply lack experience and hence the confidence necessary to embark on technical innovation. Research institutions, many of which are associated with universities or government, often have the capabilities but lack adequate contact with the commercial sector to convert experimental prototypes effectively into commercially viable products.

There is a school of thought that technology that is both technically and economically feasible will develop in response to market pressures. However, there is no real evidence that this assumption always holds true - many potentially valuable inventions have not been exploited and developed. Also technical solutions are urgently required to the anticipated demand for a future expansion of food production which demands a strategic rather than an ad hoc approach from international agencies and governments.

If solar pumps appear to be essential to the improvement of food production, then resources for their future development may have to be provided from development funds. There are many pressing demands for such funds, so any large investment should not be made until it is clear that solar pumps are more worthwhile than other types of renewable energy pumping system. It was beyond the scope of this phase of the Project to make any in-depth comparison between solar and other renewable energy resources for pumping, but it is hoped to look at this question in future phases.

## 4. SOLAR PUMPING TECHNOLOGY – PHOTOVOLTAIC SYSTEMS

### 4.1 Photovoltaic Cells

#### 4.1.1 Basic Technology

Converting solar radiation directly to electricity is a comparatively new technology which grew from the semi-conductor revolution in electronics of the 1950's. Photovoltaics were initially extremely expensive for power applications and their use was restricted to powering space satellites. However during the late 1960's, improvements in manufacturing techniques combined with increased manufacturing volumes led to a steady decline in their unit cost and they began to be used for premium terrestrial applications such as powering remote navigational equipment, telecommunication repeater stations and, more recently, for isolated equipment such as railway signals and country telephone boxes. There are now at least 15 manufacturers of silicon solar cells, working in more than 9 countries.

The only type of photovoltaic power cell commercially available so far is the silicon cell, usually in the mono-crystalline form but recently also in polycrystalline form. Before discussing these and their costs in more detail, it is worth outlining the terminology used.

The mono-crystalline silicon solar cell itself consists of a thin slice of highly purified and then chemically doped crystalline silicon (i.e. cut from a single crystal grown from molten pure silicon). Modern commercial cells are generally 100mm (4 in) in diameter (some are cut square or hexagonal to allow closer packing). Metal contacts are applied to the front and rear surfaces. When exposed to sunlight silicon cells develop a potential of 0.6V (at 25°) on open circuit and will deliver around 25mA of current for each square cm of cell surface under an irradiance of  $1\text{kW/m}^2$ , i.e. giving about 2A from a single 100mm diameter cell at 0.5V, which is 1W power rating. Cell efficiencies are typically 10 to 12% at present; i.e. a yield of 100 to 120W can be expected from every square metre of cell area in an irradiance of  $1\text{kW/m}^2$ . Poly-crystalline solar cells are similar except the wafers are cut from cast ingots of pure molten silicon, usually 100mm square in section. Their efficiency is typically about 9 to 10%.

Cells are usually connected in a series "string" (making the cell voltages additive), the string of cells being built into a "module". The module is usually a rectangular panel consisting of a glass (or sometimes plastic) window and a rigid back with the cells laminated between them. The cells are generally encapsulated in a suitable polymerised pottant to protect them from damage. Terminals for the cell string are provided externally on each module. A set of modules is then built into an "array", which generally consists of a frame to carry the modules securely, plus a wiring harness and junction box to allow the modules to be connected electrically in a suitable series/parallel combination to suit the load, and to provide an off-take for their power.

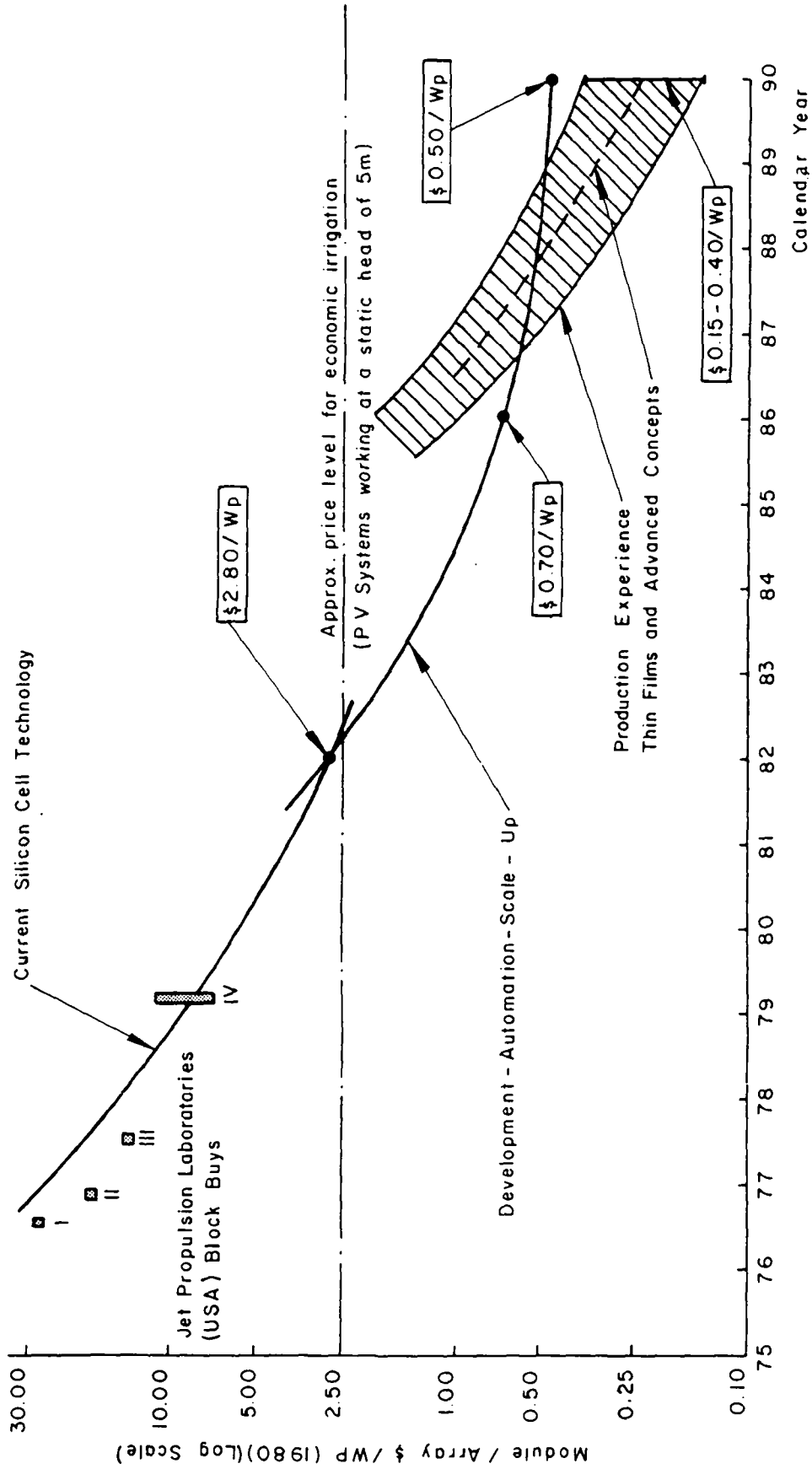

FIGURE 12 - PHOTOVOLTAIC MODULE/ARRAY PRICE GOALS AND HISTORY (IN 1980 \$)

#### 4.1.2 Costs

The cost figures which follow relate to the large quantity purchase of modules (i.e. packaged cells) in 1980 US dollars. Power outputs are generally given for cells exposed to  $1\text{ kW/m}^2$  of sunlight when at a temperature of  $25^\circ\text{C}$ . This is not a realistic operating condition, as they normally run substantially hotter than this which results in reduced performance, but it is an industry standard that coincides with solar cell testing techniques.

The selling price of silicon PV modules has dropped quite dramatically in recent years; from \$ 2000/Wpk in 1958 (when their use for powering space satellites started), to \$ 30/Wpk in 1976 (for terrestrial modules), falling to \$ 11/Wpk in 1979 and to about \$ 9/Wpk in 1980 (from the manufacturer with the largest share of the market). Figure 12 illustrates PV prices since 1976 and some predictions for the future. This diagram is based on the former US Department of Energy published price goals (e.g. Ref 25) which are now almost certainly, over optimistic. The Consultants believe there is some possibility of the price dropping to \$ 7/W pk by 1983-4 and perhaps 1-2 \$/W pk by 1990.

The selling price of solar cells does not necessarily have any close connection with either production costs or their current economic competitiveness with other energy resources, since some manufacturers, particularly in the USA, have been benefiting from the policy of the American government prior to 1981 of encouraging large scale production of PV cells through bulk purchases and various financial incentives for potential end-users. It is widely assumed that some of the lowest selling prices reflect manufacturers' strategies of improving their share of the market and volume of sales by selling "loss leaders" now, with the expectation of reducing their production costs and seeking profitability later on. Hence the selling price of PV cells is significantly affected by the marketing strategies of those manufacturers holding the largest current share of the market, and the losses some are prepared to accept.

The trend over the last year has been for the price of solar cells to level off; the lowest prices in 1981, at around \$9/Wpk were similar to those in 1980, which, allowing for inflation, implies a small decrease in real costs. The range of prices from different manufacturers has also narrowed. Changes of policy are being introduced by the new US Administration which may be causing manufacturers to rethink their pricing policies. There was a shortfall in the production of solar cells in 1980 when the price reached a low level, possibly due to higher than anticipated demand, which may have also influenced pricing policy.

Current mono-crystalline silicon cell technology still relies on a considerable element of hand assembly. It is expected that if there is an increase in the present market size, automated production will result in a further growth coupled with, and dependent on, further price drops. The most expensive item in the production of mono-crystalline silicon solar cells at present is the pure silicon raw material, currently costing well over \$ 2/W pk (according to Ref. 27); improved processes, particularly the development of cheaper solar grade silicon and cast ingot techniques coupled with increased production should result in continued price reductions.

LOCATION	YEAR INSTALLED	NO OF UNITS	PHOTOVOLTAIC POWER W	DAILY OUTPUT m <sup>3</sup>	HEAD m	APPLICATION OR AGENCY	MANUFACTURER/SUPPLIER
<b>ABU DHABI</b>							
Al Ain		1	600	40	15	livestock	PG
?		1	600	16	25	livestock	PG
<b>ALGERIA</b>							
Bou Saada		1	600	46	15	Agricultural	PG
<b>ANGOLA</b>							
-	1980-81	1	600	13	25	-	PG
<b>BANGLADESH</b>							
Dacca	1980-1	5	250	6+m <sup>3</sup> /hr	~ 5	Machine Tool Factory	PG
Dacca	1980-1	1	250	6m <sup>3</sup> /hr	~ 5	B.C.S.I.R.	SEI
Dacca	1980-1	1	260	6+m <sup>3</sup> /hr	~ 5	Rahman Hug & Co.	PG
<b>BURMA</b>							
Rangoon	1980-1	2	250	6m <sup>3</sup> /hr	~ 5	UNDP	SEI
<b>CAMEROUN</b>							
Douala	1980-1	1	250	6m <sup>3</sup> /hr	~ 5	King	PG
<b>ECUADOR</b>							
Quito	1979-80	2	600	50	10		PG
<b>EGYPT</b>							
Cairo		1	250	6m <sup>3</sup> /hr	~ 5	Catholic Relief Serv	SEI
Cairo		2	250	6m <sup>3</sup> /hr	~ 5	Nimos Agriculture	SEI
Sadat City	1981	1	3200	60	~ 40	demonstration	Arco Solar
<b>FIJI</b>							
-	1980-1	1	250	6m <sup>3</sup> /hr	~ 5		PG
<b>FRANCE</b>							
Corsica	1975	1	600	16	25	irrigation	PG
Corsica		1	600	16	25	irrigation	PG
Tours	1974	1	400	15	20	demonstration	Briau
<b>INDIA</b>							
Orissa	1979	2	240	~ 5m <sup>3</sup> /h	~ 5	irrigation	SEI
Hyderabad	1979	2	240	~ 5m <sup>3</sup> /h	~ 5	demonstration	SEI
Delhi	1979	2	240	~ 5m <sup>3</sup> /h	~ 5	demonstration	SEI
Sahibabad	1979	1		~ 2m <sup>3</sup> /h		demonstration	CEL
<b>INDONESIA</b>							
Bandung	1980-1	1	250	6m <sup>3</sup> /hr	5	/Waco	SEI
<b>IRAN</b>							
Tehran	1976	1	800/1000	10-12	43		Briau
Tehran	1976	1	800	10	39		Briau
Tehran	-	1	200W (Thermal)	-	-	demonstration	Mabosun
<b>IVORY COAST</b>							
Kokumbo		1	400				Briau
Yamoussokro		1	900	19	35	college	PG
<b>JAMAICA</b>							
Kingston	1980-1	1	250	6m <sup>3</sup> /hr	5	Ministry of Agriculture	SEI
<b>KENYA</b>							
(Various)	1980-1	12	250	6m <sup>3</sup> /hr	5	NCC, UNICEF, NORAD	SEI
<b>LIBYA</b>							
Tripoli		1	1300	34	30	) farm	PG
Tripoli		1	1800	42	40	) equipment	PG
Tripoli		1	1300	34	30	) supplier	PG
Benghazi	1978	1	800	15	18		Briau

TABLE 7 – EXISTING SMALL-SCALE PUMPING INSTALLATIONS  
(Sheet 1 of 3)



LOCATION	YEAR INSTALLED	NO OF UNITS	PHOTOVOLTAIC POWER W	DAILY OUTPUT m <sup>3</sup>	HEAD m	APPLICATION OR AGENCY	MANUFACTURER/ SUPPLIER
<b>MALI</b>							
Koni	1977	1	900	40	18	irrigation	PG
Mopti		1	2600	24	30		
Wabasso	1977	1	900	30	24	village	PG
San	1979	1	1800	25	30	hospital	PG
Tominian	1977	1	1300	70	25	village	PG
Yangasso	1979	1	1300	56	25	village (MAV)	PG
Bamako	1980	1	250	~ 5m <sup>3</sup> /hr	~ 4	Solar Energy Lab/ UNDP/World Bank	SEI
Babougou	1980	1	316	~ 3m <sup>3</sup> /hr	~ 7	" " "	Briau
Korofina	1980	1	275	~ 3m <sup>3</sup> /hr	~ 5	" " "	Photowatt
Dire	1980	2	250	~ 5m <sup>3</sup> /hr	~ 5	USAID/Action B/e	SEI
Tion	1980-1	2	600	16	20	-	PG
Koyban (Nara)	1980-1	1	600	25	15	-	PG
<b>MARTINIQUE</b>							
-	1980	1	250	~ 7m <sup>3</sup> /hr	~ 4	-	PG
<b>MAURENTANIA</b>							
Gavak		1	3900	600	7	) food	PG
Nltakat		1	900	58	15	) co-operative	PG
<b>MEXICO</b>							
-		1	1800	29	50		PG
-		1	1800	29	50		PG
-		1	600	29	12	irrigation	PG
Guerrero		1	600	25	18		PG
-		1	120				PG
-		1	120	3m <sup>3</sup> /h	1	university	PG
-		1	120	3m <sup>3</sup> /h	1	demonstration	PG
<b>MONGOLIA</b>							
-	1980-1	1	618	-	-	-	PG
<b>NEW CALEDONIA</b>							
Anse Vata	1980-1	1	100		10		PG
<b>NIGERIA</b>							
Konso		1	600	24	20	irrigation	PG
<b>OMAN</b>							
Muscat		1	320	10	15		Briau
<b>PAKISTAN</b>							
Islamabad	1979	1	240	5m <sup>3</sup> /h	5	demonstration	SEI
-	1981	18	250	~ 5m <sup>3</sup> /hr	~ 5	ADB/ITDG	SEI
-	1981	2	300	~ 5m <sup>3</sup> /hr	~ 5	ADB/ITDG	Lucas
<b>PHILIPPINES</b>							
Manila	1980	1	250	~ 8m <sup>3</sup> /hr	4.5m	CNED/UNDP/World Bank	SEI
Talaksan	1980	1	600	~ 7m <sup>3</sup> /hr	4m	" " " "	Briau
Talampas	1980	1	600	4m <sup>3</sup> /hr	12m	" " " "	PG
Talampas	1980	1	200	4m <sup>3</sup> /hr	5m	" " " "	Omera-Segid
<b>POLYNESIA</b>							
Bora Bora	1980	1	160		15		PG
<b>RWANDA</b>							
-		1	600	120	5	village	PG
<b>SAUDI ARABIA</b>							
-		1	600	18	25	village	PG

TABLE 7 – EXISTING SMALL–SCALE PUMPING INSTALLATIONS  
(Sheet 2 of 3)

LOCATION	YEAR INSTALLED	NO OF UNITS	PHOTOVOLTAIC POWER W	DAILY OUTPUT m <sup>3</sup>	HEAD m	APPLICATION OR AGENCY	MANUFACTURER/SUPPLIER
<b>SENEGAL</b>							
Babak		1	1300	65	20	village	PG
Bambey		1	900	100	10	irrigation	PG
Dakar	1975	1	400	10 - 15	20	university	Briau
Dakar	1975	1	360	12 - 18	15 - 20	university	Briau
Dakar	1980	1	250	~ 6m <sup>3</sup> /hr	5m	Sofica	SEI
-	1980-1	1	250	~ 8m <sup>3</sup> /hr	4m	Caritas	PG
-	1980-1	1	600	25	15	Ag. Centre of Offinuan	PG
<b>SOMALIA</b>							
Hargeisa	1980-1	21	250	-	-	Oxfam	SEI
Hargeisa	1980-1	5	250	-	-	Agro-Action	SEI
-	1981	2	250	-	-	Save the Children	SEI
<b>SPAIN</b>							
-	1980-1	1	250	~ 8m <sup>3</sup> /hr	4	-	PG
<b>SUDAN</b>							
Butri	1980	1	530	~ 5m <sup>3</sup> /hr	~ 10	IER/NCR/UNDP/World Bank	Arco Solar
Butri	1980	1	530	~ 3m <sup>3</sup> /hr	~ 10	" " "	ITC/Solar Corp.
Butri	1981	1	480 (tracking)	-	~ 10	" " "	Soterem
Soba	1981	1	100W (thermal)	-	18	" " "	SPC
Khartoum	1981	1	250	-	-	Animatics	SEI
<b>TANZANIA</b>							
Dar es Salaam	1980-1	1	250	-	-	Animatics	SEI
<b>THAILAND</b>							
Bankok			250			Population & Community Development Assoc.	Briau
Bankok	1980-1	4	250	-	-		SEI
<b>TUNISIA</b>							
Beidizeitoun	1980-1	1	600				PG
<b>TURKEY</b>							
Ankara	1980-1	1	250			KSB Temsulilige	SEI
<b>UNITED STATES</b>							
El Monte Ca		1	2400			foundation	Arco Solar
2 Isletta Pueblo NM	1976	1	375			livestock	Arco Solar
Navajo Az		1	1500	39	12		Arco Solar
Schuchuli Az	1978	1	3500	4.3m <sup>3</sup> /h		village	NASA-Lewis
Gainesville Flo	1980-1	1	250			Univ. of Florida	SEI
Davis, Ca	1980-1	1	250			Univ. of CA/PG&E	SEI
Roswell NM							
Sabta Rosa, Ca	1980-1	1	250			OCLI	SEI
Cleveland, Ohio	1980-1	1	250			NASA	SEI
Touson Ariz	1979-80	1	Thermal			Univ of Arizona	SPC
<b>UPPER VOLTA</b>							
Kamboinse	1977	1	760	15	27		Briau
Karbo	1977	1	840/1000	10	40		Briau
Mogtedo	1977	1	600	10	28		Briau
Ougadougou		1	600	24	20	engineering village	PG
Tangaye	1979	1	1800	water pumping and other applications		village	NASA-Lewis
Ouagadougou	1980-1	1	250	6	5	Iwaco	SEI
<b>VENEZUELA</b>							
Caracas	1976	1	120	15	12		Briau
Caracas	1980-1	1	250		4		PG

PG = Pompes Guinard (France)  
SEI = Solar Electric International (USA)  
CEL = Centaal Electronics Limited (India)  
ITC = Inter Technology Corporation (USA)  
SPC = Solar Pump Corporation (USA)

All Systems are Photovoltaic except where indicated.

TABLE 7 - EXISTING SMALL-SCALE PUMPING INSTALLATIONS  
(Sheet 3 of 3)

It is expected that other PV cell technologies will be commercially used within the next two years; these include thin film cadmium/copper sulphide cells and amorphous silicon cells. Both of these are "behind schedule" if the claims of their adherents made only two or three years ago were believed; but there is good reason to believe that some of the technical problems facing these technologies are being overcome and that they may well be competitive with crystalline silicon, but probably not until the end of the decade. In theory, thin film cells of these kinds could become significantly cheaper than crystalline silicon, once a high volume of production is achieved, so the price levels predicted in Figure 12 for the end of the decade are feasible.

Although it appears that PV cells are still too expensive to allow solar pumps to be viable for irrigation, a further price reduction of 50% would make them potentially useful under carefully chosen conditions, while a 60-70% reduction would probably make them economically viable for very low head pumping (around 3m).

Also, they probably are already viable for certain water supply duties in remote areas at moderate or low heads, but it was beyond the scope of the first phase of this Project to investigate this application.

#### **4.2 Existing Photovoltaic Pumping Installations**

Unlike solar-thermal power systems, photovoltaics are now being widely installed in practical and economically viable applications, notably for remote telecommunications systems.

There are currently at least 60 small photovoltaic water pumps in operation around the World. Most of these are being used for demonstration purposes and probably only those systems used for water supplies are economically viable as yet. The majority of these have been installed by the French company Pompes Guinard and the US company Solar Electric International (SEI). They all use flat plate silicon solar cell arrays but the type of motor/pump set and control system varies between the manufacturers and particular applications. Table 7 presents details of some existing installations.

#### **4.3 Photovoltaic Pumping Systems**

The main components of a photovoltaic pumping system are illustrated schematically in Figure 13. Components indicated in solid outlined boxes are essential to any photovoltaic system, whereas the components indicated within broken line boxes are options that have been offered by some but not all system suppliers. The energy flows (and losses) through a basic PV solar pumping system are shown in Figure 5.

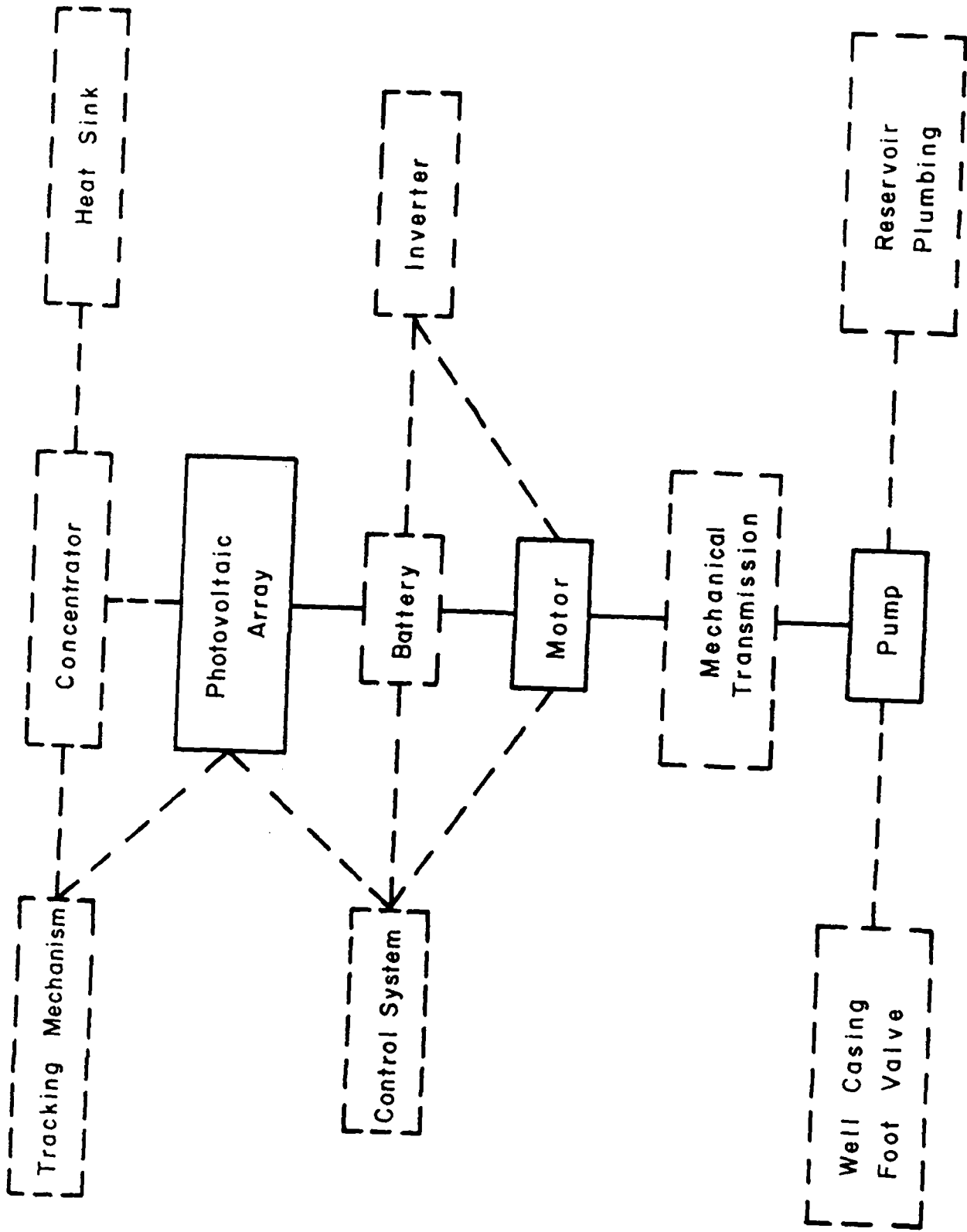

FIGURE 13 - SCHEMATIC ARRANGEMENT OF A PHOTOVOLTAIC SOLAR PUMPING SYSTEM

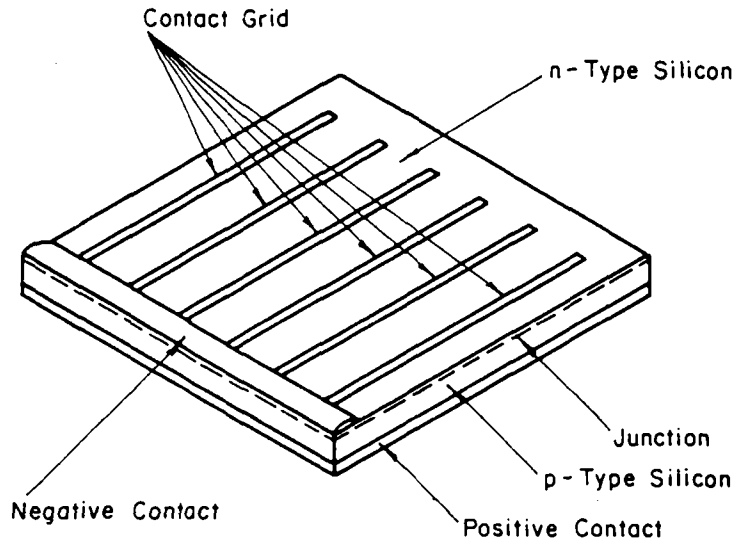

FIGURE 14 - SILICON SOLAR CELL

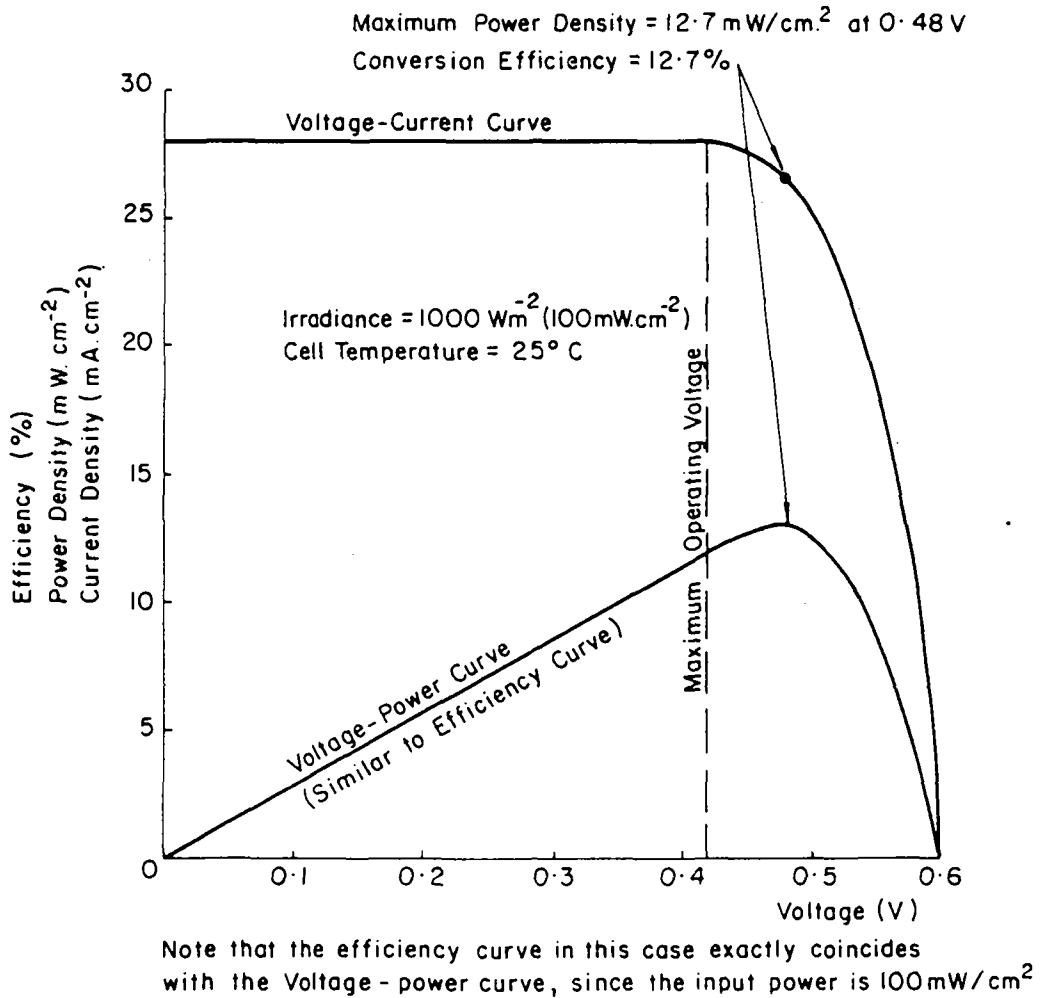

FIGURE 15 – VOLTAGE-CURRENT AND VOLTAGE-POWER CHARACTERISTICS OF A SILICON SOLAR CELL

## 4.4 Photovoltaic Array

### 4.4.1 Mono-crystalline Silicon Arrays

The key component of any photovoltaic system is the array, which converts sunlight directly to direct-current electricity.

The basic element is the solar cell, of which there are several types. However, the only type commercially available at present is the mono-crystalline silicon cell, which has the considerable advantage of being based on well-known semi-conductor technology. Its mode of operation is well understood and it has been manufactured in large quantities. One version is shown in Figure 14, consisting of a thin slice of specially-doped single-crystal silicon, commonly 50mm to 100mm in diameter or, more recently, square, with metal contacts on the front and back surfaces. The surface is often treated so as to minimise the amount of light reflected and thereby improve the efficiency.

Figure 15 shows the voltage-current and voltage-power characteristics of a modern silicon cell at 25°C in sunlight at an irradiance of 1000W/m<sup>2</sup> – the so-called “peak” conditions. The short-circuit current (at zero voltage) is directly proportional to the cell area and the irradiance, while the open-circuit voltage (at zero current) is independent of cell area and is logarithmically related to the irradiance. The maximum power delivered is represented by the area of the largest rectangle than can be fitted under the curve (being the product of voltage and current). In this case, maximum power of 12.7mW/cm<sup>2</sup> is produced at a voltage of just under 0.5V. The maximum conversion efficiency is the maximum output power expressed as a percentage of the input power (irradiance x cell area), in this case 12.7%. However, if the cell is operated at voltages away from about 0.45V, the power and the efficiency decline to zero at 0 or 0.6 V.

The maximum operating voltage is normally fixed so as to be slightly less than the voltage for maximum power; i.e. just to the left of the “knee” of the curve. It should be noted that the current from a good cell is almost constant over the voltage range up to the operating point.

An increase in cell temperature causes a slight rise in short-circuit current  $I_{SC}$  but a sharp fall in open-circuit voltage  $V_{OC}$ , as shown on Figure 16. As a result the maximum power and efficiency fall by about 0.5% per degree C rise.

Because of the loss of power at high temperatures, it is important in array design and installation to ensure that the cells run at as low a temperature as possible.

Figure 17 shows the effect of a temperature rise from 25°C to 60°C on the voltage-current characteristic. The voltage for maximum power also falls with increasing temperature. However, providing the cell operating temperature does not exceed that corresponding to the voltage for maximum power at the highest operational temperature, the output current is only slightly affected by changes of temperature.

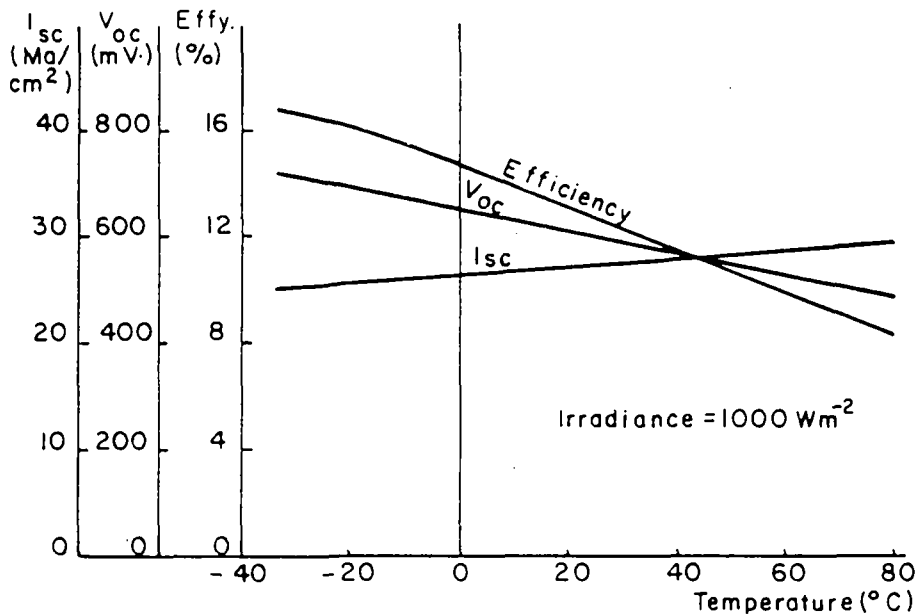

FIGURE 16 – DEPENDENCE OF EFFICIENCY,  $I_{sc}$  AND  $V_{oc}$  ON CELL TEMPERATURE

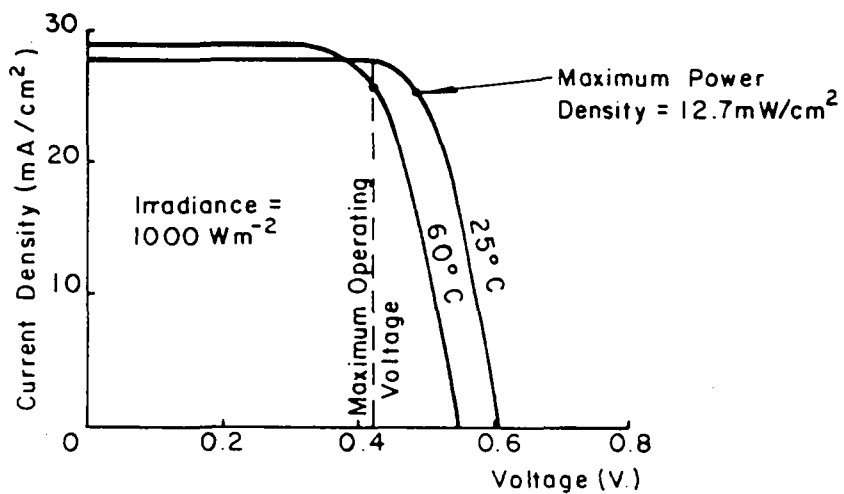

FIGURE 17 – EFFECT OF CELL TEMPERATURE ON V-I CHARACTERISTIC

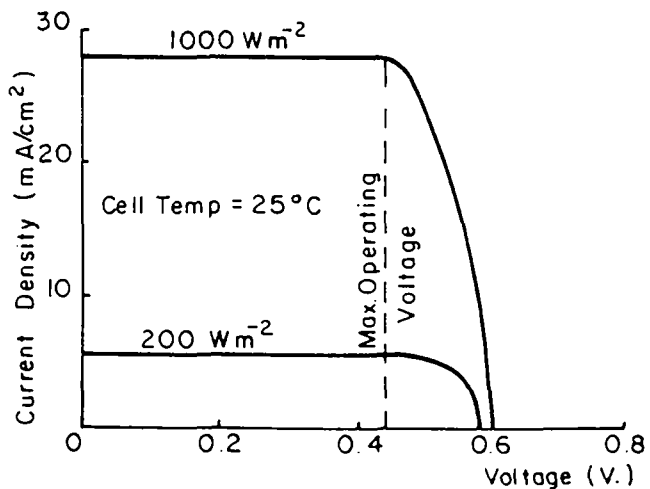

FIGURE 18 – EFFECT OF CHANGE IN IRRADIANCE ON V-I CHARACTERISTIC

Figure 18 shows how the characteristic changes in cloudy conditions, when the irradiance might fall to  $200\text{W}/\text{m}^2$ . Power at the operating voltage falls roughly in proportion to the irradiance but is still available at this voltage down to a very low light threshold. This is an important feature of photovoltaics. In concentrated sunlight, the short-circuit current increases proportionally to the irradiance up to extremely high levels (providing the cell temperature is kept constant) and the open-circuit voltage increases logarithmically, so one might expect the conversion efficiency to improve. In practice, however, the series resistance of the cell has a progressively flattening effect on the voltage-current characteristic, so higher efficiencies are not achieved unless steps are taken in the cell design to reduce series resistance. This feature and the provision of adequate cooling are the main technological problems in developing cells for high concentration.

Silicon solar cells, in contrast to thermal collectors, respond very rapidly to changes of irradiance, their time constant being about 20 microsecond.

The photovoltaic module, the basic building block of a flat plate array, consists of a number of interconnected cells, usually in a single series string, encapsulated behind a transparent window to protect the fragile cells from mechanical damage and the weather. The number of cells in series is chosen to ensure that the module will produce power at the desired working voltage at the highest expected operational temperature. In most commercial designs, an element of redundancy is introduced in the inter-connections between cells so that a single broken or bad connection does not cause a complete failure of the module.

To achieve the long working life that is required, the module must be rugged, capable of resisting ultra-violet radiation, thermal cycling, thermal shock, moisture ingress, fungi growth, sand, dust, hail, salt spray, wind loading, wind-induced vibrations and rough handling. A number of special hazards are also likely in the environment expected for irrigation systems, for example obscuration and damage by bird guano and damage by animals (goats have even been reported trying to eat the encapsulant), plus the possibility of theft or vandalism.

Glass is usually used as a window material in current designs and synthetic resins such as silicon rubber or polyvinylbutyral (PVB) as encapsulants. However, the Consultants' experience in the field trials has shown glass to be vulnerable to breakage, both in transit and on site. Polymerised resins and polycarbonate plastics have been used in the past, but proved to be excessively pervious to moisture and prone to deterioration from dust. Possibly a laminated glass and plastic window cover would offer the virtues of both materials without their disadvantages.

As a certain amount of space has to be allowed between the cells, the conversion efficiency of a module, based on the gross area it occupies in an array, is less than that of individual cells. Figures for commercially-available modules range at present from 5 to 8% for those embodying circular cells and 8 to 11% for those with square cells. The trend is to



increase the packing density of modules by using squared off cells in order to reduce the size and the cost of modules of a given power rating. In general, PV array efficiencies are quoted as a function of complete array area rather than cell area, and supplier and designers should always be careful to define efficiencies in quoted specifications.

Modules are rated in terms of "peak power", that is to say, the power they should produce at a specified working voltage and temperature (usually 25°C) in sunlight at an irradiance of 1000W/m<sup>2</sup>. Because of the diurnal cycle and variations in atmospheric attenuation due to weather conditions, the average output is considerably less than the rated peak value. For instance in some parts of India, Australia, the Middle East and Africa, where the mean global irradiance averaged over 24 hours is 250W/m<sup>2</sup>, a module rated at 10 peak watts could in theory produce 2.5W on average, or 60Wh/day. However in practice the operating temperature will be higher than 25°C and will result in a reduction of output of typically 7½% at 40°C. In addition, attenuating effects due to dirt accumulation and ageing of the encapsulation and window surface may further reduce output by 5 to 10%. Hence a module rated at 10W peak may only yield say 50Wh/day rather than the 60Wh/day predicted on the basis of ideal power ratings.

The above analysis assumes that the module is always loaded electrically so as to make it operate at, (or near to) its maximum power and maximum efficiency point. Failure to do this would reduce the daily output further.

A further problem with PV arrays is bad matching of either modules or cells. Inconsistent manufacturing can cause the characteristics of individual cells to vary. A sub-standard cell or module in a series string may, under certain load conditions, be driven into reverse bias, causing power to be dissipated in the affected element. In extreme cases this can cause over heating and eventual failure. A similar effect can be caused by a fault such as a cracked cell or by the shadowing of certain cells or modules.

With badly-matched modules in parallel, certain load conditions can cause a reverse current to flow through modules with low open circuit voltage, again causing power to be dissipated.

Therefore manufacturers are trying to improve the consistency of their products and to identify modules with slight variations so that they can be matched with similar ones when assembling an array. It is possible that, in future, mass production will result in more consistent products from the industry than at present.

Field experience with photovoltaic arrays in a variety of applications extends over a number of years. One French installation powering a copper electrolysis plant in Chile has been working satisfactorily for 20 years and photovoltaics have been used for educational TV in Niger over the past 10 years. In general, the arrays have functioned with a high degree of reliability and a life of 20 years seems a reasonable goal.

Claims to have achieved this goal already with currently manufactured modules are based on projections from accelerated ageing tests rather than on real experience.

During the laboratory tests conducted in Phase I of the Project, it was found that although the modules tested were adequately reliable in that they almost all survived the testing programme, they all had a number of manufacturing defects. Most of these were minor, but a few were potentially serious. There was some variability in the performance of the modules tested and most of the outputs and efficiencies were below their manufacturers' specification by from 2.5% to 16.5%.

Clearly, the great virtue of flat plate photovoltaic arrays is their ability to generate electricity from the sunlight without moving mechanical parts. The resulting reliability and ease of maintenance will be important considerations in the present application.

The present high cost of photovoltaic arrays is mainly due to the expensive single crystal silicon and the use of labour-intensive batch production methods in the fabrication of cells and modules. However, extensive efforts are being made to reduce the cost of the starting material and to develop automated production processes as the market expands. The US Department of Energy had agreed to help fund a \$6M plant which will use Union Carbide's silane process to produce about 100 tonnes of pure silicon per year and which, it is claimed, should bring the cost of silicon suitable for photovoltaic cells down from well over \$ 2.00 to around \$0.50 per peak watt. Other approaches to cheaper silicon are the heat exchanger method (HEM) being developed by Crystal Systems, USA, cast polycrystalline ingots (Solarex, USA, and Wacker Chemitronic, West Germany), continuous ribbon growth (Mobil-Tyco, USA, and Japan Solar Energy Co., Toshiba and Toyo Silicon Co., Japan), dendritic web silicon (Westinghouse, USA), zone growth by laser beam melting (Motorola, USA), and sheet growth on low-cost substrates (LEP, France and others). The Stanford Research Institute is also understood to have achieved a breakthrough by purifying silicon in one step instead of two, thereby reducing the cost of pure silicon from \$60/kg to under \$ 10/kg.

#### 4.4.2 Other Types of Photovoltaic Cells under Development

Another approach to cost reduction is to replace the silicon cell by a potentially cheaper type. The main contenders are as follows:

##### (a) Cuprous Sulphide/Cadmium Sulphide

This solar cell consists of a p-n junction between two different semiconductors: n-type cadmium sulphide and p-type cuprous sulphide, most of the light being absorbed by the latter. In the "backwall" type, the light enters through the cadmium sulphide, which is deposited on a transparent substrate. In the more common "frontwall" type, the cuprous sulphide layer is illumin-

ated. Figure 19 shows the cross-section of a typical frontwall thin-film cell, which was originally developed for space applications and is now being adapted for terrestrial use.

This cell is potentially cheaper to make than mono-crystalline silicon types and its manufacturing processes are adaptable to mass production. But it is not so well understood and its technology not so well advanced, despite the large sum of money spent on its development in USA, France and other countries. Efficiencies have not advanced beyond the 9% mark and are commonly below 6%. The theoretical maximum has been estimated to lie between 11 and 14%. Cu<sub>2</sub>S/CdS cells are not yet as stable or as reproducible as silicon cells. The main cause of degradation is the oxidation of the cuprous sulphide to the less efficient cupric sulphide. To prevent this, hermetic encapsulation must be employed. Pilot production lines have been set up in USA by SES Inc. (frontwall) and Photon Power (backwall on glass) but neither company has yet been able to offer modules on the market, although SES Inc. claim that they are close to commercialisation. Despite the difficulties, there is still a considerable body of opinion which regards this type as the main contender in the search for a really cheap solar cell.

(b) Schottky Barrier

A metal/semiconductor junction (Schottky barrier) has photovoltaic properties similar to those of a p-n junction and solar cells embodying such junctions can theoretically be made as efficient. This type is suitable for low-cost mass production. The metal can be either in the form of a substrate supporting a thin film of polycrystalline or amorphous semiconductor material or a thin transparent layer over the semiconductor. The cross-section in Figure 20 shows the essential features of the latter version.

Research on Schottky barrier cells is in the early stages at present, although an efficiency of 11.7% has been reported with single crystal silicon as the semiconductor and a possible 15% with gallium arsenide. A key factor, and one that it is proving difficult to control, is the thin oxide layer which it has been found necessary to interpose between the metal and semiconductor to raise the open-circuit voltage to an acceptable level. Because of this insulating layer, some investigators are applying the term "MIS" (metal-insulator-semiconductor) or "AMOS" (anti-reflective-metal-oxide-semiconductor) to this type of cell. The operation of Schottky barrier cells is not yet well understood.

(c) Amorphous Silicon

The optical properties of thin films of hydrogenated amorphous silicon are such that it should be possible to make efficient solar cell from a thickness of only 1 or 2  $\mu\text{m}$ . Since crystalline silicon cells require 300 to 400  $\mu\text{m}$ , this represents a dramatic saving in

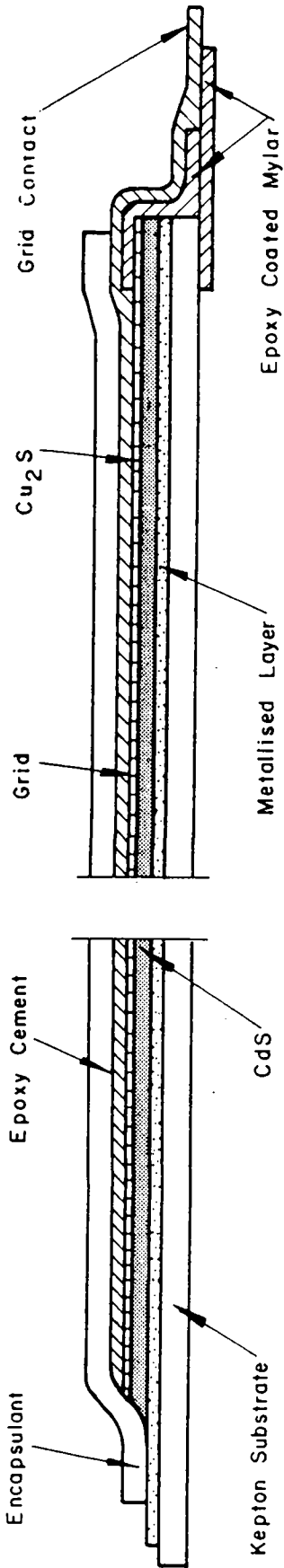

FIGURE 19 - CADMIUM SULPHIDE SOLAR CELL

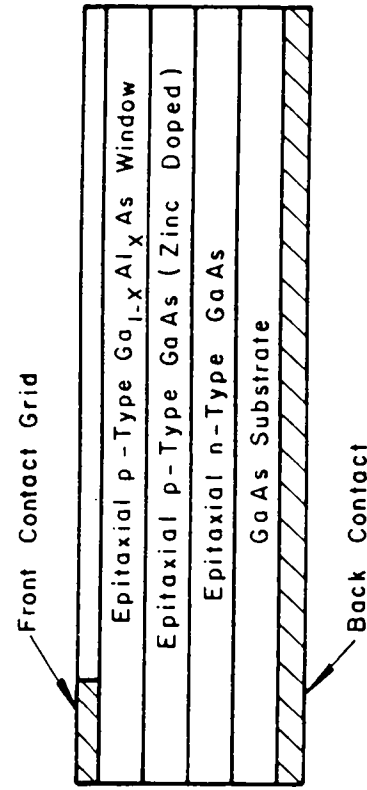

FIGURE 21 - GALLIUM ARSENIIDE SOLAR CELL

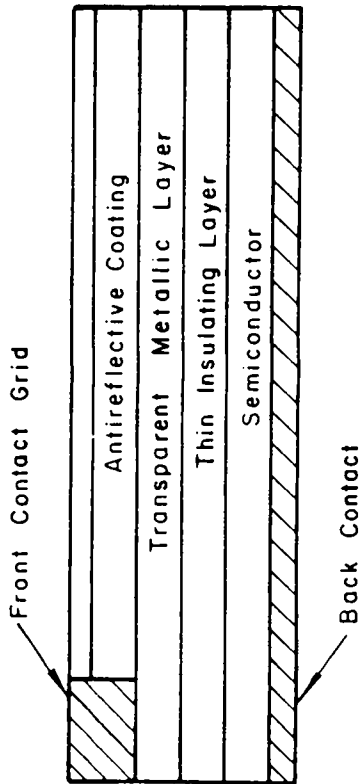

FIGURE 20 - SHOTTIKY BARRIER (MIS) SOLAR CELL

material. Both homojunction and Schottky barrier cells are being developed with amorphous silicon but the work is in its early stages and many problems remain to be overcome. Best performance to date was achieved by RCA, who made a Schottky barrier cell with an efficiency of 5.5%.

(d) Gallium Arsenide

The modern gallium arsenide cell consists of a thin epitaxial layer of gallium aluminium arsenide super-imposed on thin epitaxial layers of p- and n-type gallium arsenide, all on a substrate of single crystal gallium arsenide. Figure 21 shows the construction in cross-section. Its main attraction lies in its ability to operate efficiently in highly-concentrated sunlight, which opens up possibilities for offsetting its cost, which is much higher than that of silicon and likely to remain so. Cells have been operated at concentrations of up to 5000 suns although a more practical limit is 2000. Efficiencies of over 20% have been claimed. However, production has been only on a laboratory scale so far.

#### 4.4.3 Concentrating photovoltaic arrays

Photocells are perhaps the most expensive single element in a PV pumping system. Since their output can be boosted simply by increasing the intensity of illumination, it is possible to reduce the area of cells necessary for a given power output (and their cost) by concentrating sunlight onto them. Reduced overall costs have been claimed for this because the extra sunlight concentrating equipment can cost less than the extra number of cells that would be needed to provide the same output without concentration.

Methods of concentrating the sunlight that are commonly used include focussing mirrors or using Fresnel lenses (usually moulded in plastic). Figure 22 shows the principal methods schematically; the cells can be between or surrounded by reflecting surfaces (top diagram), at the focus of a parabolic reflector, facing away from the sun towards the reflector (centre diagram), or behind a lens, at its focus, (lower diagram). In the latter case a Fresnel lens is usually used as this can be kept quite thin and light in weight and can be mass produced cheaply from clear plastic. By contrast, a normal convex lens would have to be very large and expensive for the apertures involved.

Figure 22 is only two dimensional. In practice any of the concentrating systems shown can be either point focussing or line focussing. In the former case the reflector or Fresnel lens is normally circular (or polygonal) in aperture with the PV cells on its central axis. In the latter case the cross sections illustrated would extend linearly with the cells mounted as indicated as a long narrow strip. The degree of concentration is related to the ratio of the aperture and the area of cells at its focus; so-called "point" focussing results generally in a higher concentration factor, the image being small in area rather than a point.

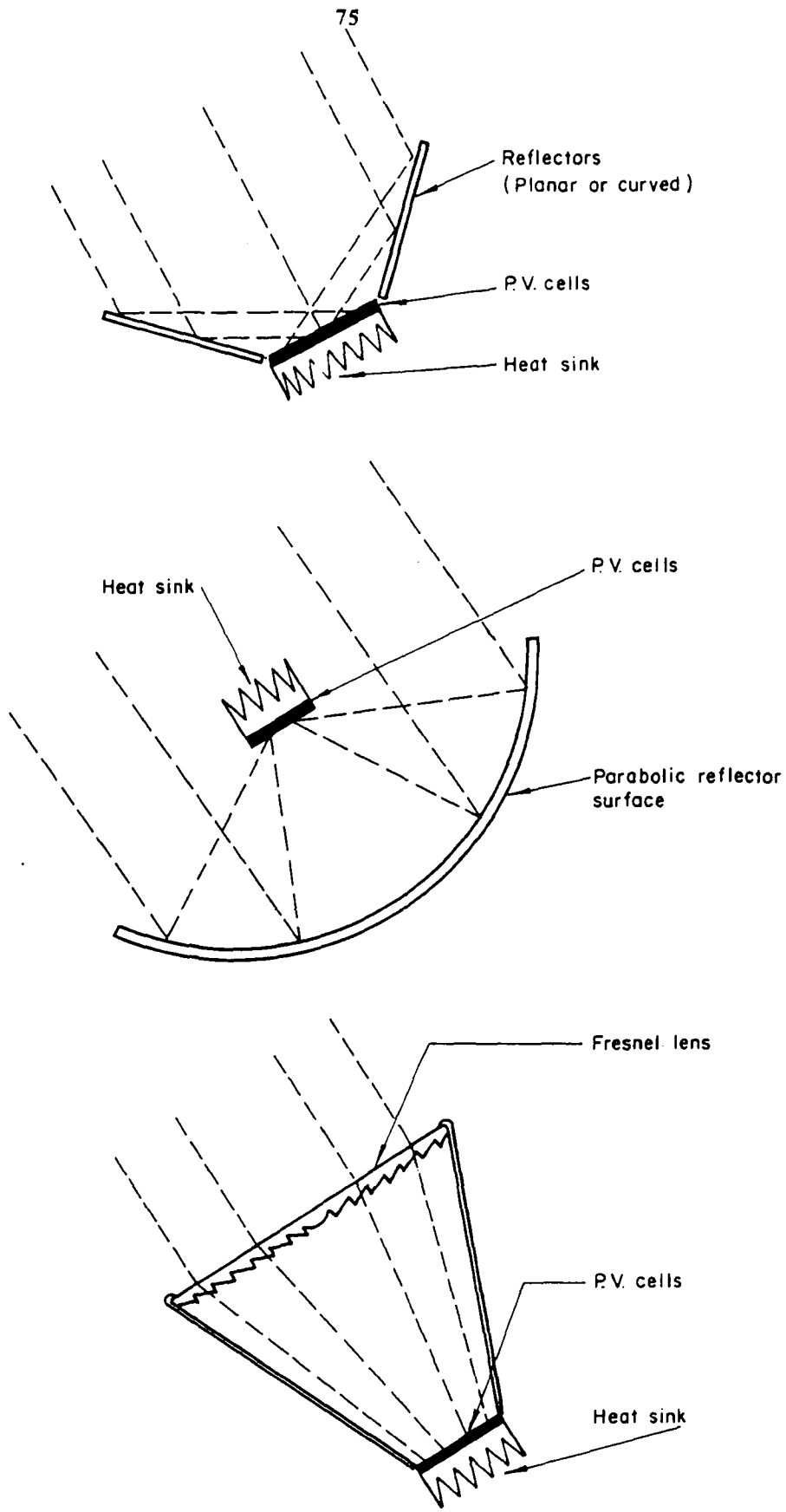

FIGURE 22 – METHODS OF CONCENTRATING SUNLIGHT ON PHOTOVOLTAIC CELLS

Although concentrating systems might save on cell costs, they have a number of disadvantages, which are as follows:-

- (a) Concentrating the sunlight causes the cells to heat up (to potentially very high temperatures at high concentration ratios) and hence cooling of the cells becomes necessary. This can be done passively using air cooled fins as a heat sink (as illustrated) for low concentration ratios, but water cooling is usually necessary for high ratios. Any failure of the cooling could result in destruction of the expensive cells.
- (b) Most types of concentrators need to be tracked in order to keep them correctly aligned with the sun. The higher the concentration ratio, the more accurately must they be tracked; (some very low concentration ratio systems need only be tracked very occasionally such as every few weeks to cater for seasonal changes in the sun's course across the sky). Tracking introduces complication in the form of a mechanism (clockwork, electrical, or powered by solar-heated vapour) and it not only requires the array to move readily in response to the tracker, but also to be rigidly located so as to resist any movement due to wind gusts; hence an expensive support structure may be needed.
- (c) Concentrators can only focus direct beam radiation from the sun, so the diffuse component cannot be used. Therefore concentrators are only likely to be effective in areas with arid climates having a large proportion of direct sunshine with limited haze and cloud. In comparison with fixed flat-plate collectors, this shortcoming is partially compensated for by the fact that in tracking the sun more energy can be collected, as described in section 2.7 and illustrated in Figures 4A and 4B.
- (d) Uneven illumination of the cells is a problem, particularly with low concentration ratio systems when cell strings are in parallel as well as in series, as this can cause internally circulating currents and "hot spots". Uneven illumination can be caused by blemishes or discontinuities in the reflector(s), or by a non-continuously tracked system being misaligned with the incoming beam radiation.
- (e) Reflectors (or lenses) involve a loss due to imperfect reflectivity (or transmissivity); this is at least 10% of the energy flux per reflection (or transmission) and possibly substantially more. A major problem with reflectors, particularly in arid areas where the high proportion of direct to diffuse radiation is to be found, is degradation, either temporarily or permanently, due to dust collecting on the reflecting surfaces. With flat plate arrays this is less of a problem as although the dust scatters the light, much of it still is received by the cells.

When being compared to a flat photovoltaic array, a concentrating array with its associated tracking system can only be justified if the cost saving from using fewer solar cells outweighs the extra cost and complication of

tracking, account being taken of the extra energy gained by tracking and the energy lost through inability to utilise the diffuse component. It should be borne in mind that flat-plate arrays can benefit considerably from occasional tracking, but do not need the expense and complication of continuous tracking. The benefits expected from this and other options are illustrated by Figures 5A and 5B and are quantified later in this chapter.

As the cost of PV cells falls, the balance should move in favour of non-concentrating arrays, especially for small systems. Present lowest costs per peak watt claimed by manufacturers are similar for concentrating and non-concentrating arrays. This suggests that if the price of PV cells falls substantially (which it must do if solar irrigation pumping is to become viable) then, since the price of mirror reflectors and tracking is unlikely to fall as much as the price of cells, it seems unlikely that concentrating systems will prove competitive in the long run.

There are two configurations which might prove to be cost effective.

- o very low concentration by adding small reflectors to the periphery of a flat plate array might well be cost-effective due to the simplicity of such an arrangement and the fact that tracking would not be necessary and much of the diffuse component would still be useful. This implies a reflector area probably less than that of the cells, simply used as a booster.
- o it is possible that systems with very high concentration ratios might be cost-effective through being able to use rather small areas of high cost but high efficiency photovoltaics (such as, for example, gallium arsenide) which would in turn possibly allow a significant reduction in the array aperture required for a given electrical power output. This would be likely to be cost-effective only if substantial gains in cell efficiency prove possible due to the various concentrator losses they must outweigh. However, if gross array efficiencies of over 20% or so prove possible through this approach, it would probably be worthy of serious consideration.

As discussed in Chapter 2, the sizing of a small-scale irrigation pump is critically dependent on the peak irrigation water demand and the solar energy availability in that month - for most months the system will be oversized for the actual water needs. Therefore, manual tracking of the array may be important to minimise this mismatch, since careful tracking during times of peak water demand will go some way towards reducing the required system size and cost while at other times of the year less careful or no tracking may be adequate.

It is open to question whether the extra costs and continuous complication of mechanical automatic tracking systems will be justified, when the benefits will probably only be necessary in the irrigation application during the one month of maximum irrigation water demand. Further investigation of automatic tracking system costs and the actual capabilities of farmers at manual tracking will be essential to clarify this issue.



## 4.5 Electric Motors

Most system suppliers at present favour dc permanent magnet motors. This type of motor, although more expensive than field wound dc motors, offers such a good efficiency, particularly under part-load conditions, that it is virtually the only sensible option.

As described in the Project Report, most of the motors tested were conventional with a segmented commutator and brushes. Such machines generally require new brushes at intervals of the order of 2000 - 4000 hours, and if this is not done, certain models can suffer irreparable damage. Some dc motors are being offered with claimed brush lives of about 10000 hours, and these would be better for this kind of application if these lives were achieved under field conditions. With any brushed machine, fail-safe brush design is essential, so that the machine will stop once the brushes are too worn, rather than damage itself. No investigation of actual brush life was possible under Phase I of the Project. Another problem with brushed motors is the build up of carbon dust that arises from wear of the brushes, which can cause arcing or overheating of the armature or premature wear of the bearings.

An alternative type of permanent magnet motor (one of which was tested during the first phase of this Project) is brushless with the magnets in the rotor and an electronically commutated stator. In principle, such machines seem more attractive than brushed machines for small-scale solar pumping, since their only wearing parts are the bearings and any seals. However, although early problems with the electronics have been corrected, the electronic circuiting is still vulnerable to overheating due to the high temperatures that can be reached when the motor runs for long periods, especially in the tropics. Thus they need effective protection from damage by high current or voltage transients, from external damage (eg by humidity), and from overheating through good heat sink design.

The electronically commutated motor which was tested was slightly less efficient than the best of the brushed dc machines tested. It is likely that the higher power drain from the electronic commutator is inherently the reason for lower efficiency although electronically commutated motors could probably be built which show a less marked drop in efficiency compared with the best brushed machines. Brushes are a source of energy loss due to the resistive losses they imply and due to friction with the commutator surface, all of which can be set against the electronic commutation circuit's parasitic power drain. However, a higher efficiency electronically-commutated motor is likely to cost more to manufacture.

The laboratory testing programme completed during the Phase I of the Project indicated that the better dc permanent magnet motors, in the 250 to 500W range are capable of optimum efficiencies of around 85% and even at half load their efficiencies should exceed 75%. A more detailed description of the testing programme is included in the companion Project Report, but Figure 23 indicates a typical dc permanent magnet motor characteristic obtained during the testing programme. Some of the poorer electric motors were only 75 - 80% efficient. However it is worth noting that an 85% efficient motor requires 9% less array area than one of say 78% efficiency - with a typical 400W array this translates into a capital cost saving at the array of typically one 36W module, worth about \$360 at present day prices.

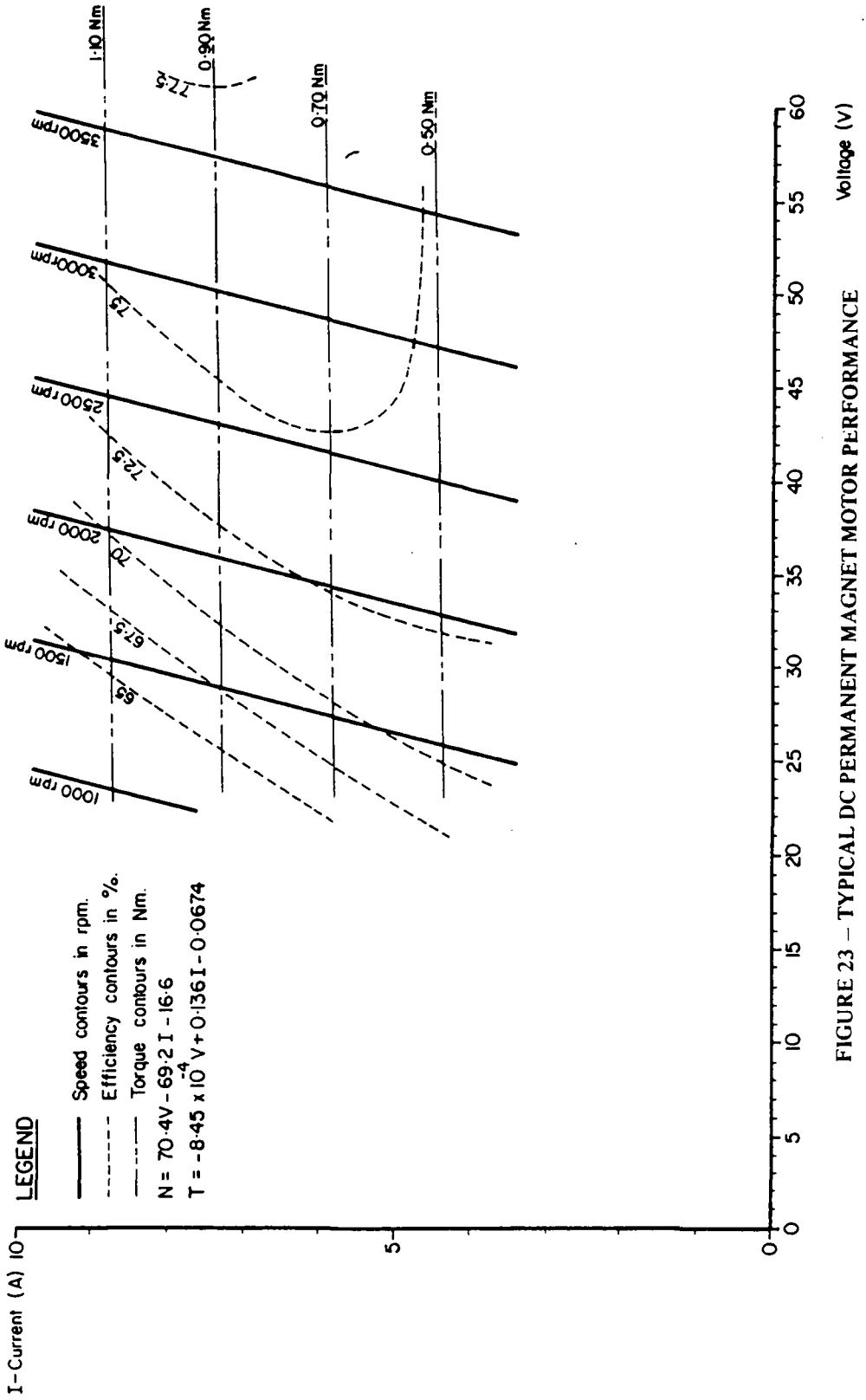

FIGURE 23 - TYPICAL DC PERMANENT MAGNET MOTOR PERFORMANCE

Mass produced ac motors are about half as efficient as dc permanent magnet motors in the small power sizes of interest. In addition, they require the use of an inverter (to convert dc to ac) and, usually, a battery too, both of which imply further losses in efficiency. They are generally inefficient as they were not designed with efficiency as a high priority, (the costs of the electricity used in mains applications for fractional horsepower motors are small) and low unit costs are the main preoccupation of manufacturers of such equipment. Therefore, although they might be half the cost of a dc permanent magnet motor of the same power rating, the lower efficiency will considerably outweigh this benefit through the increased array size required.

A linear actuator was also tested - this is a reciprocating solenoid device, with permanent magnets, but brushless. The assumption was that this might be both efficient, low in cost and simple if coupled directly to a reciprocating pump. Lack of a suitable pump hampered this part of the programme as it became clear that any pump would have to be carefully matched to the actuator so as to achieve a good efficiency at the frequency of vibration used by the actuator. The actuator was designed to operate from 50Hz ac supplies; therefore an inverter or other switching devices would be required to generate a suitable ac current from the dc output of an array. Further investigation might be justified since devices of this kind should be inexpensive and long-lasting although it is not clear whether good efficiency can be achieved in practice from an actuator-pump combination.

#### 4.6 Batteries

The main advantage of using a battery storage in the system, regardless of whether it delivers current via an inverter to an ac motor or direct to a dc motor, is that it can provide a steady electrical output even if the photovoltaic array output fluctuates considerably due to the continuous variation of angle of received radiation and to passing clouds. It also offers a reserve of power to provide the surge of current needed to start most electric motors and pumps, a particularly useful feature if the pump has a high breakway torque, such as with some positive displacement pumps.

In virtually all cases a control system is necessary to regulate the battery charging process and to switch on the motor/pump combination when the battery state-of-charge is adequate and to switch it off when the charge level falls too low.

Batteries however involve a number of significant disadvantages, namely:

- o they are an expensive component;
- o they generally need regular topping up with distilled water (sealed maintenance-free batteries are available, but are considerably more expensive).
- o they give rise to a significant energy loss as the charge-discharge cycle will generally be in the range 50 to 80% efficient, which necessitates a larger photovoltaic array; and

- o the life of conventional lead/acid batteries is limited to about 5 years under field conditions, considerably less than the desirable life of the system as a whole.

It is worth noting that the principal photovoltaic system manufacturers, with experience of solar pumping in developing countries, offer systems without batteries, the dc motors being powered directly from the photovoltaic array. It is not expected that batteries are likely to be cost-effective for small-scale solar pumping systems used for irrigation at low heads, where the pumps need not have a high starting torque.

## 4.7 Pumps

### 4.7.1 General

In the Consultants' view, an essential requirement for any solar pumping system is the use of a pump that will reliably self-prime, even if the foot-valve (where fitted) is imperfect. A large proportion of the low head systems currently commercially available do not meet this requirement.

The self-priming requirement narrows the choice to:

- o submersible centrifugal combined motor/pump units.
- o a centrifugal sump-pump arrangement, with the pump below water, driven by a shaft from a motor above the water
- o self-priming surface-suction centrifugal pumps, with a priming reservoir to keep the impeller and casing flooded even in the event of foot-valve failure.
- o positive-displacement pumps which are inherently self-priming, (eg. piston, plunger, diaphragm or progressive cavity)

However, for the low heads that are appropriate for small-scale irrigation positive displacement pumps seem inappropriate on grounds of efficiency, size and hence cost.

### 4.7.2 Centrifugal pumps

The conclusions from Phase I of the Project were that a simple single-stage centrifugal pump appears to have the merit of adequate performance potential combined with compactness and simplicity as well as having low starting torque requirements. Centrifugal pumps also offer the possibility of achieving a close natural match with a PV array (without recourse to power conditioning) over a broad selection of operating conditions. The importance of power conditioning is explained later under the section on PV System Design.

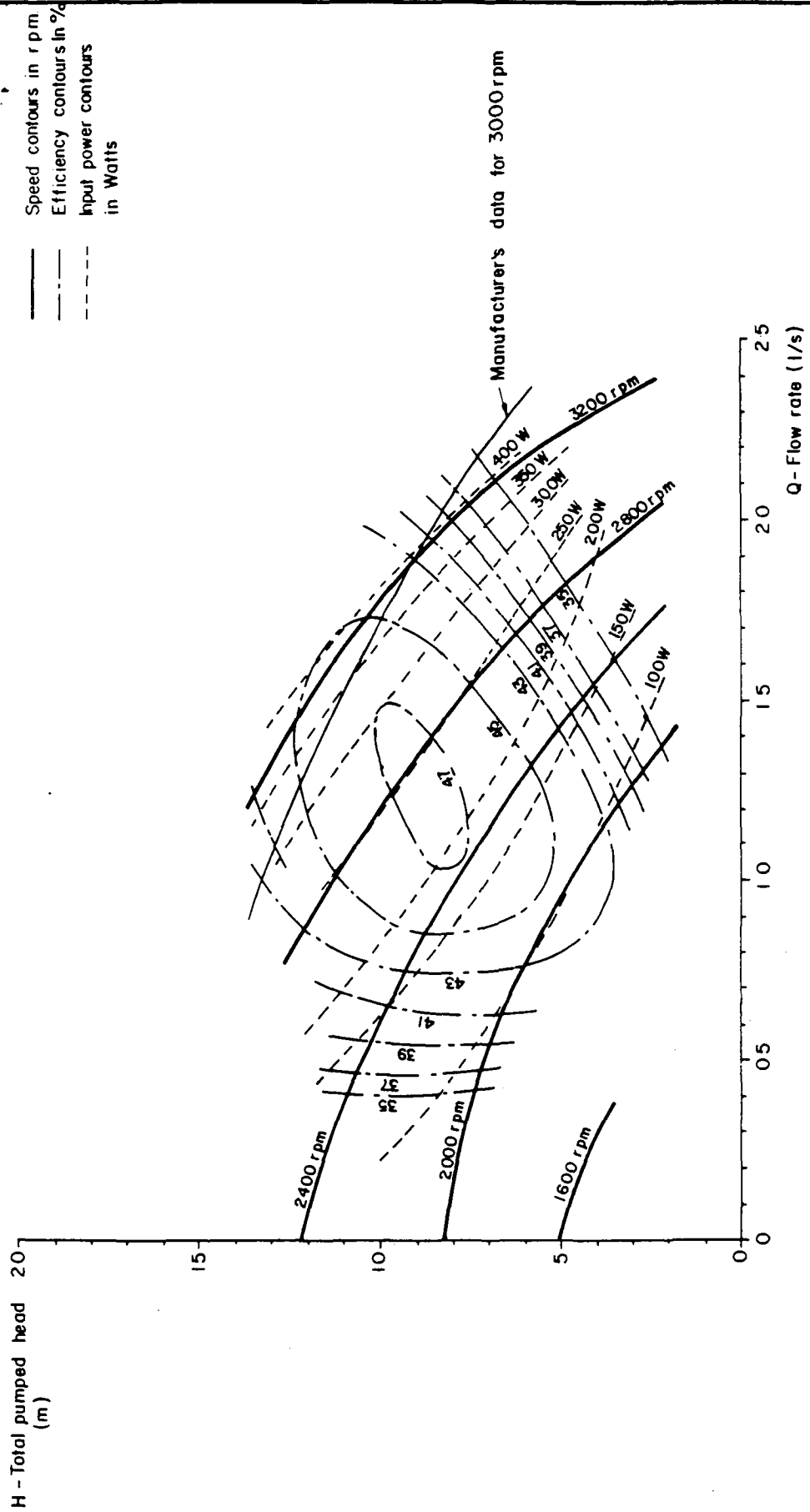

FIGURE 24 - TYPICAL CENTRIFUGAL PUMP PERFORMANCE

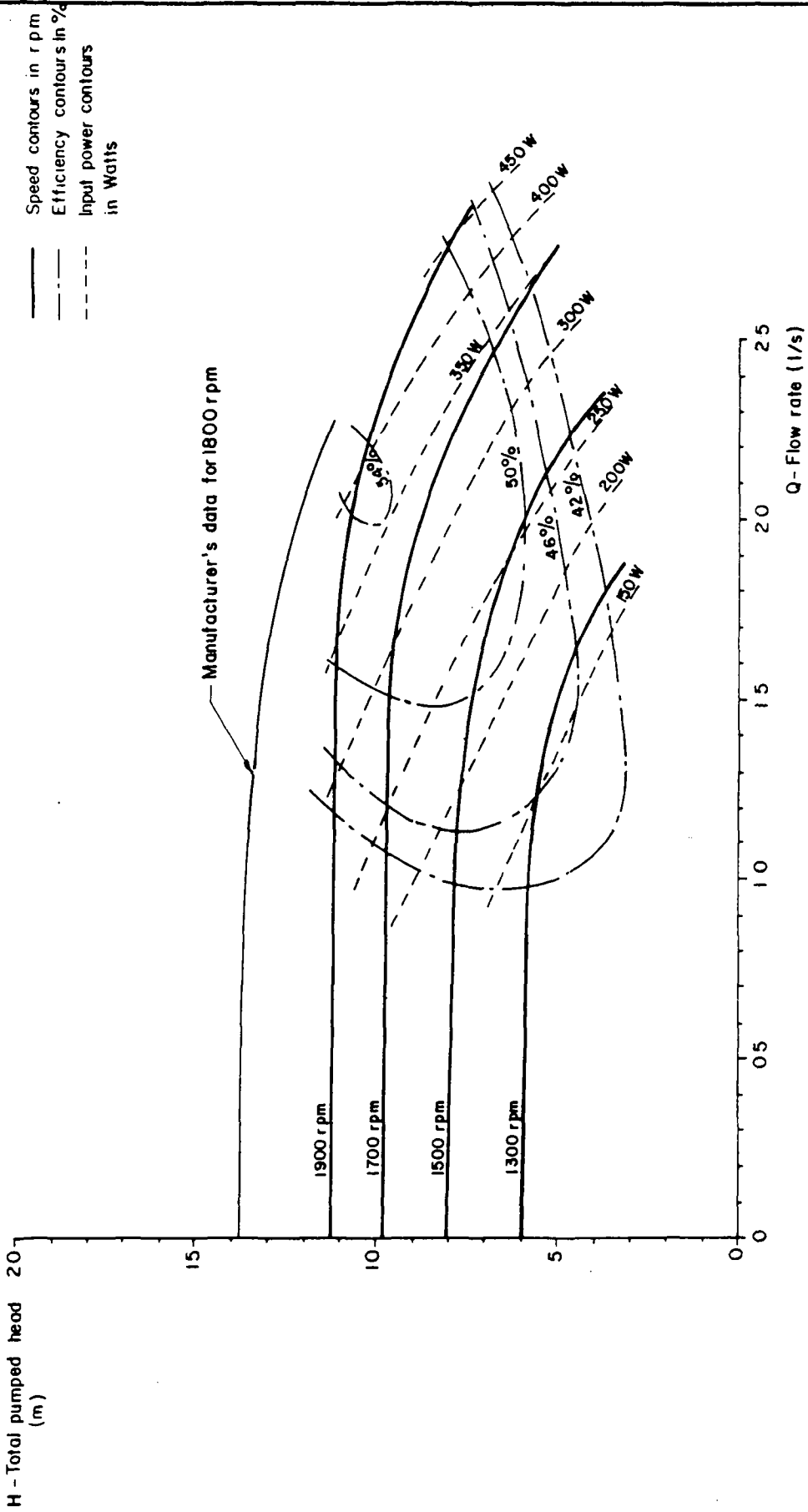

FIGURE 25 - CENTRIFUGAL PUMP PERFORMANCE WITH FLAT SPEED CHARACTERISTICS

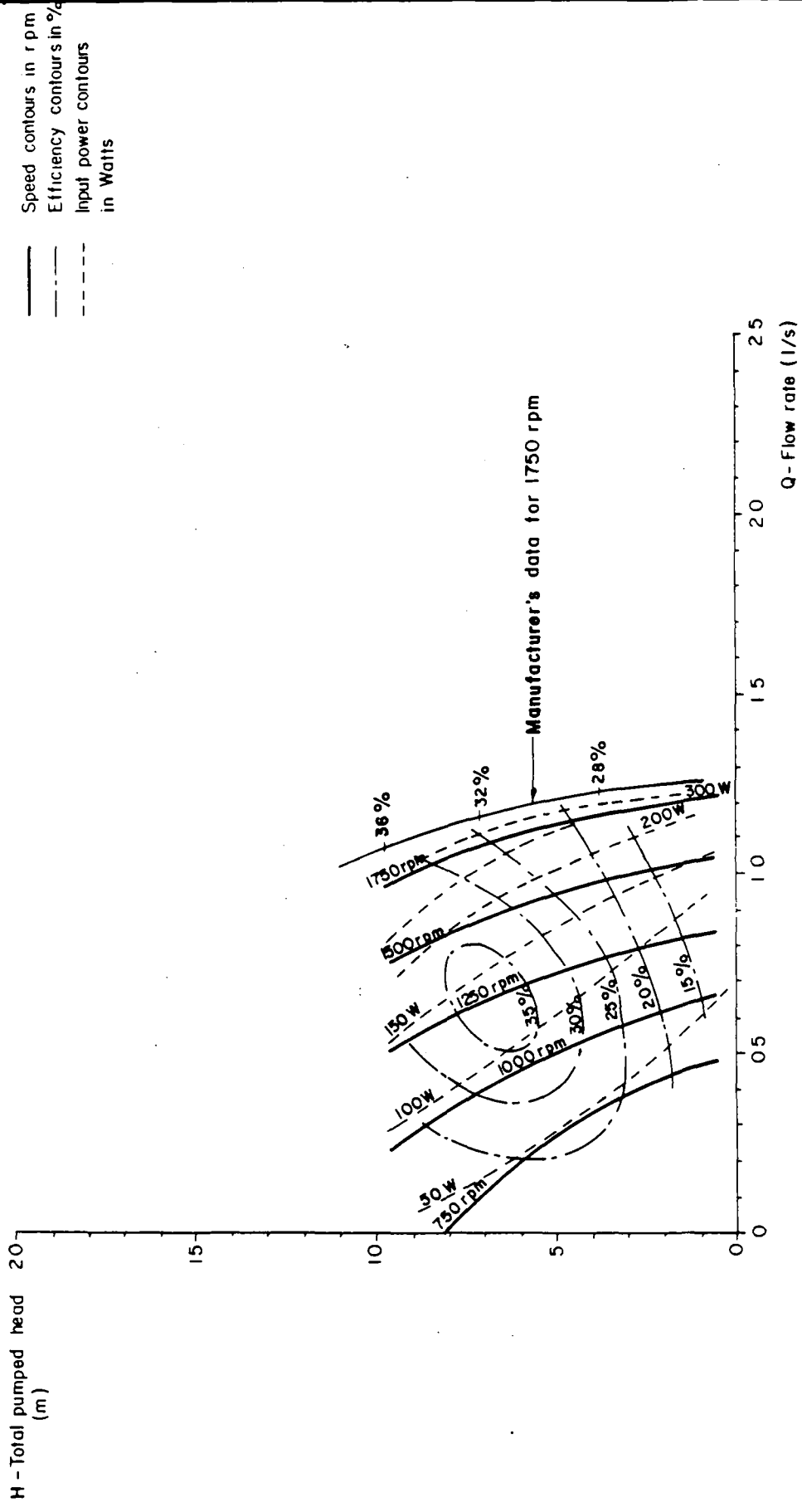
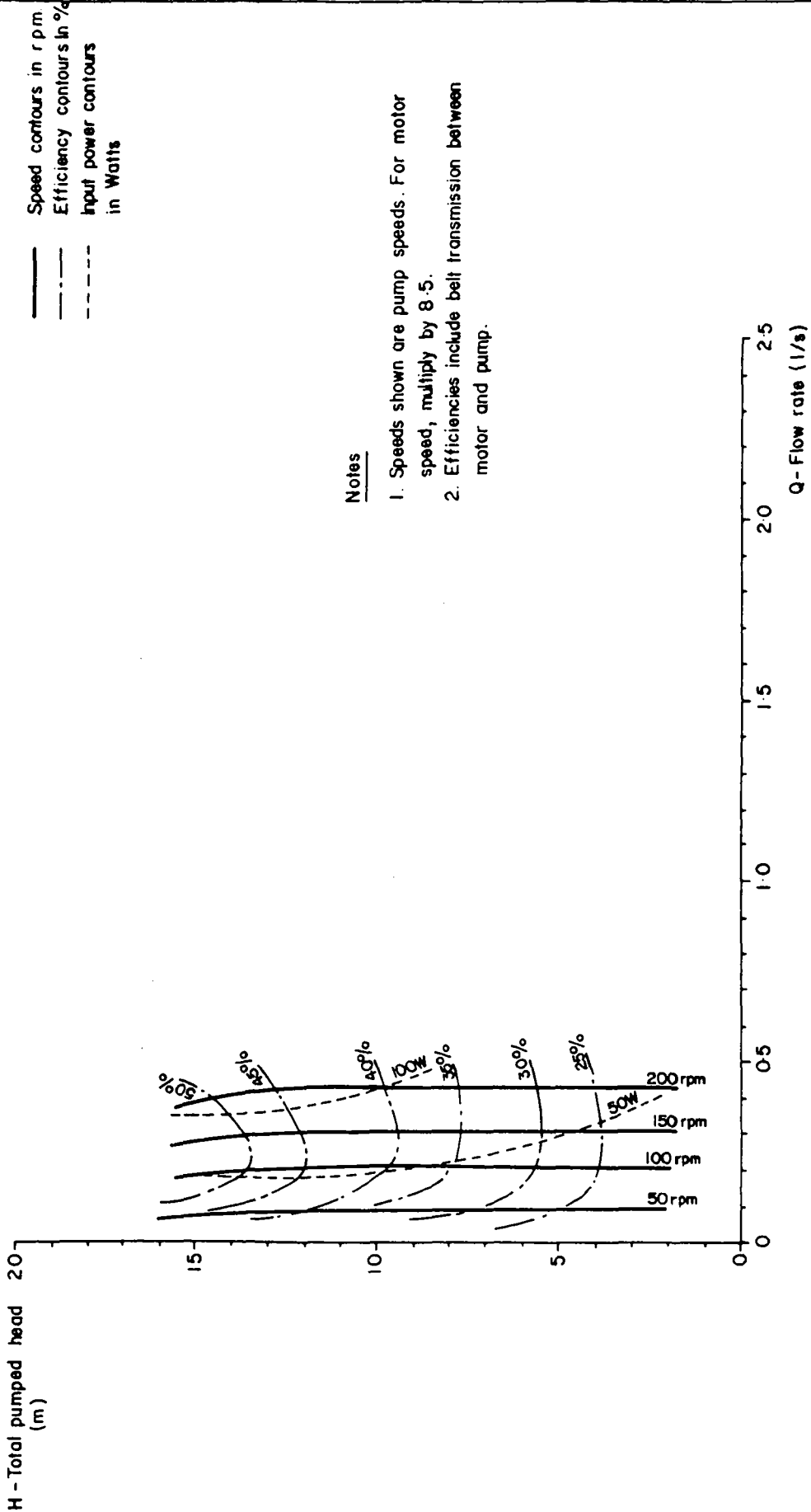

FIGURE 26 - REGENERATIVE CENTRIFUGAL PUMP PERFORMANCE



— Speed contours in rpm  
 - - - Efficiency contours in %  
 - · - Input power contours in Watts

Notes

1. Speeds shown are pump speeds. For motor speed, multiply by 8.5.
2. Efficiencies include belt transmission between motor and pump.

FIGURE 27 - TYPICAL POSITIVE DISPLACEMENT PUMP PERFORMANCE



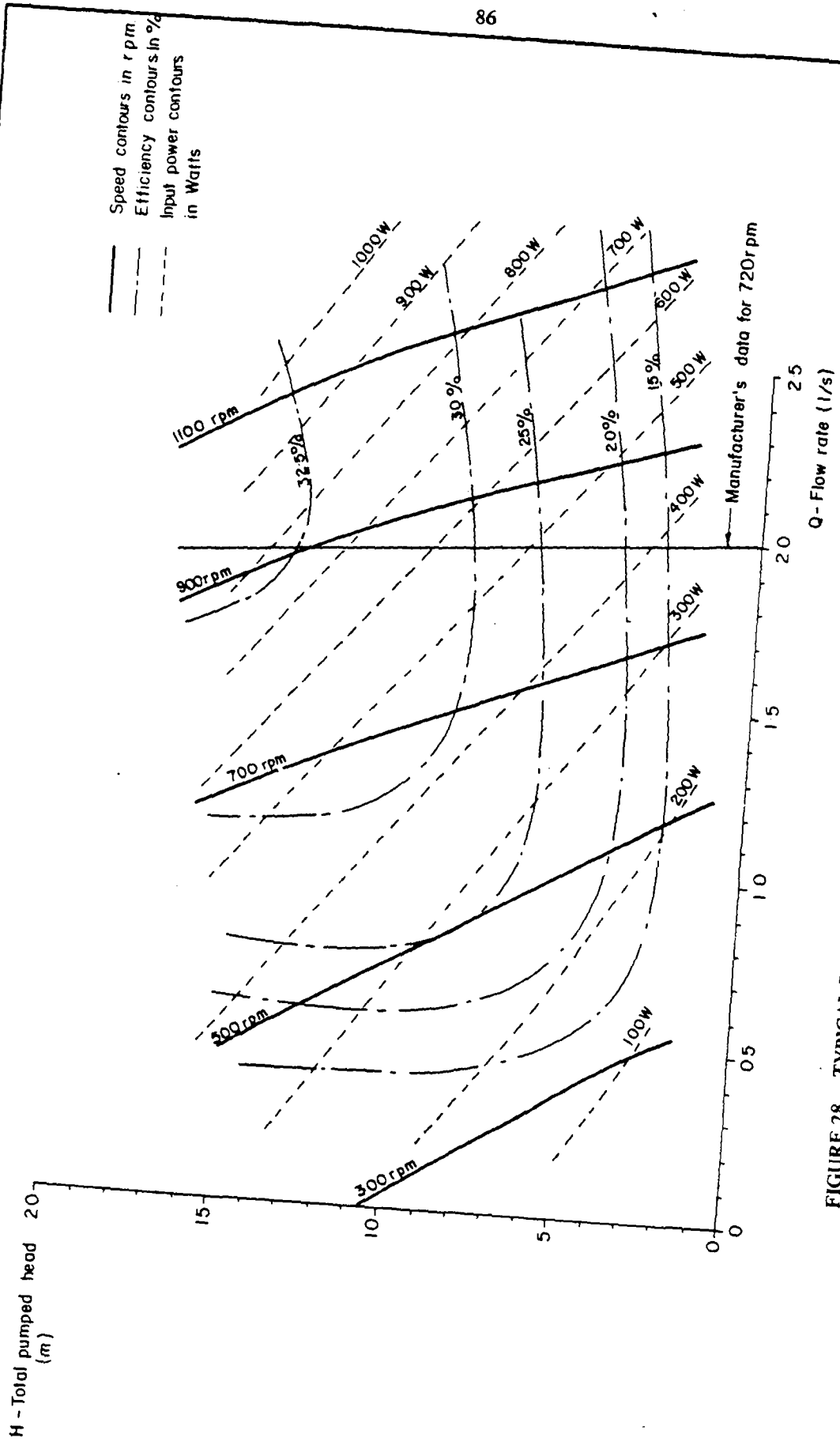

FIGURE 28 - TYPICAL ROTARY POSITIVE DISPLACEMENT PUMP PERFORMANCE

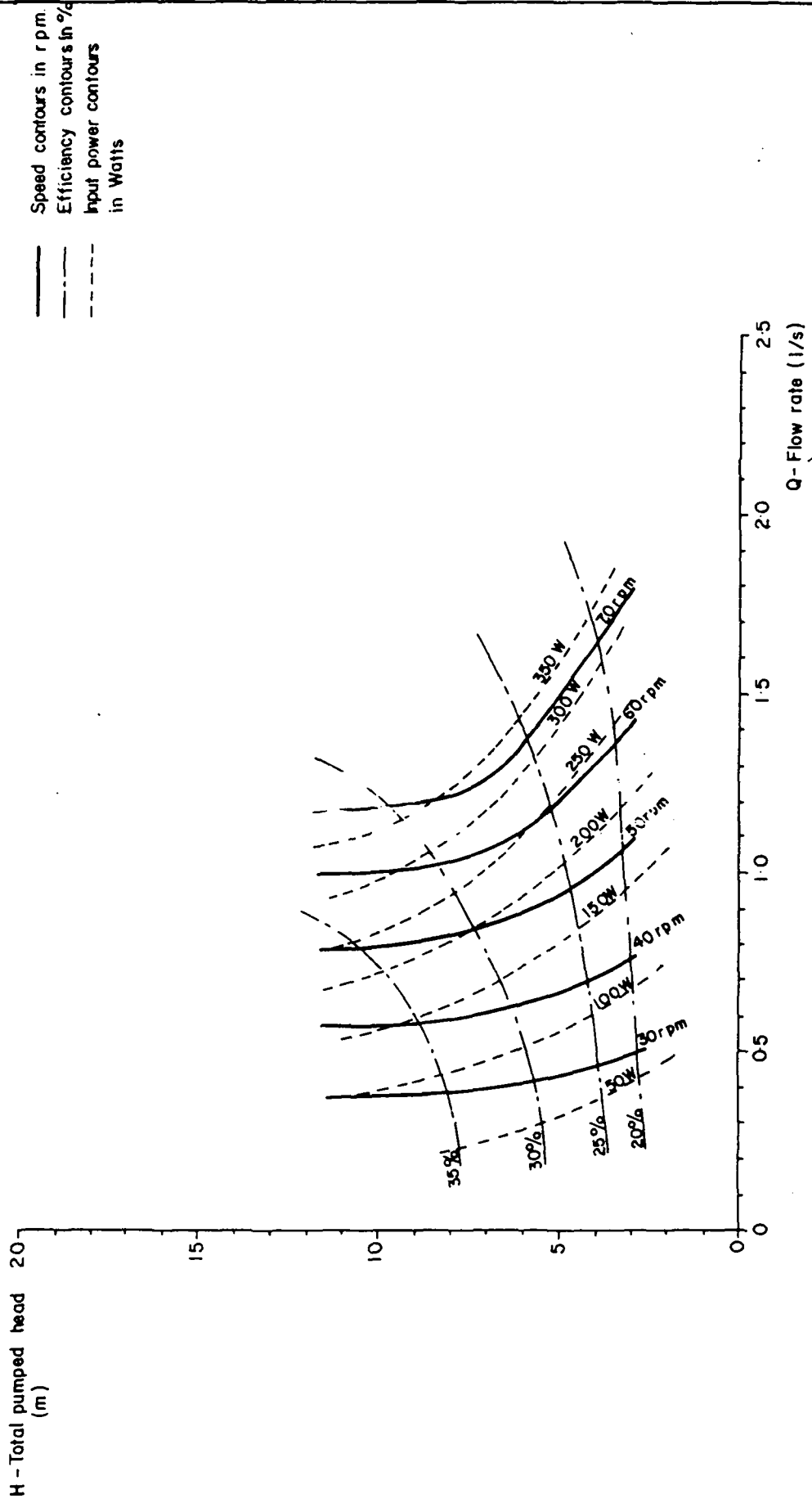

FIGURE 29 - FRIEDLANDER AGM PUMP PERFORMANCE

An interesting example of rotodynamic pump is the regenerative centrifugal, sometimes known as a side-chamber pump. In this pump, the water makes more than one transit through the impeller by being redirected back into the impeller by passages in the casing. The entire impeller does not therefore run full and losses due to water leaking back from the high pressure to the low pressure end are reduced through maintaining small clearances between the impeller and its casing. It has the advantage of being tolerant of considerable speed reduction, and like most centrifugal pumps, it ought to have low starting torque requirements. It can also tolerate a wide variation in head compared with most centrifugal pumps. A performance characteristic for a pump of this type is shown in Figure 26. However, the example tested was of poor efficiency compared with the better centrifugal pumps and was prone to suffer from binding between the impeller and its casing due to the small clearances. It seems likely that these disadvantages are inherent in this type of pump and may make it unsuitable for solar pumping systems where high efficiency is important. Also there is often a need to pump water containing suspended solids, which makes small clearances a serious disadvantage.

#### 4.7.3 Positive Displacement Pumps

Positive displacement pumps can be more efficient than centrifugal pumps, but generally only at higher heads. The characteristic of a typical example is shown in Figure 27, which illustrates some of the differences. It has vertical, rather than horizontal constant speed lines, because flow with a positive displacement pump is essentially a function of speed (whereas head is a function of speed squared with a centrifugal pump). Increasing the head with the positive displacement piston pump increases the power demand and the efficiency, because frictional forces become smaller relative to the hydrostatic forces at higher heads. Since Phase I of this Project was only concerned with low head pumping, positive displacement pumps under optimum conditions of heads in excess of 15m. were not tested.

Therefore, positive displacement pumps of this kind are unlikely to be of much relevance for irrigation applications, but may have an important role for solar water supply pumps.

One type of positive displacement pump is the surface suction pump. A problem associated with this pump is that it can only be used down a large diameter well (on suitable supporting steelwork), or in situations where it can be located within about 5 or 6m of the water level.

An example of a borehole positive displacement pump, which can operate submerged with zero suction lift is the progressive cavity pump. This type of pump is one of the commercially-available rotary positive displacement pumps and has a good reputation for its tolerance of aggressive fluids (be they abrasive suspensions or chemically corrosive) due to its rubber stator. Figure 28 illustrates the characteristic of an example of this type of pump, although the particular model tested was not adequately efficient for heads of less than 15m to compete with centrifugal pumps, but may well be suitable for use with solar water supply pumps supplied from boreholes.

Pump efficiency is critical to the cost-effectiveness of the system and high efficiencies require good design with such small pumps. The indications from our test programmes are that an optimum pump efficiency for small pumps (200 to 500W shaft power requirement) for use at low heads (in the 5 to 10m range), of around 55% is realisable and that consistent efficiency of over 45% at reduced speeds or non-optimum heads should also be achieved. Some systems tested had pumps only half as efficient as this, which effectively doubles the cost of water from them.

What is not yet known with any certainty is the trade-off between high efficiency and the need for an impeller with a long life and a good tolerance of aggressive impurities in the water; good efficiency can be obtained with narrow passages and small clearances which are of course undesirable. Similarly, good efficiency can also be bought with a high speed impeller, which is again counterproductive from the point of view of achieving the longest possible operating life and generous water passage dimensions. Further longer term investigation of pump durability will be necessary to arrive at confident conclusions on the likely performance limits that might reasonably be expected.

A typical pump performance characteristic produced during the Project test programme is given in Figure 24. The sensitivity of this kind of pump to variations in head is clearly shown by the efficiency contours in the diagram. This particular pump, which was one of the more efficient ones tested, was unusual in having quite steeply sloping constant speed contour curves, implying that it is tolerant of a significant percentage reduction in speed before it ceases to deliver water at a given head. Most of the pumps tested had flatter speed contours more like the one whose characteristic is shown in Figure 25. Flat speed curves, imply that a small percentage speed reduction will cause delivery of water to cease. However this was one of the most efficient small centrifugal pumps tested, achieving over 54% efficiency at a remarkably low rotational speed.

Off-the-shelf industrial centrifugal pumps, as are commonly used for small-scale solar pumping systems at present, are generally designed for single speed operation when driven by mains electric motors and hence many are intolerant of any significant speed reduction below the speed for optimum efficiency. Purpose-designed pumps for small-scale solar pumping will no doubt allow significant improvements to be obtained which will be measurable in terms of array size reduction through improved efficiency, as well as greater tolerance of speed and head variation.

Because pumps are less efficient than motors, a ten per cent absolute improvement in a pump from 40% to 50% efficiency results in a 25% reduction in array costs. At present array costs, a one per cent marginal change in pump efficiency, (with good pumps in the 40 - 50% efficiency level), would be worth \$40 for a 200W (electrical) system and \$80 for a 400W system in array savings.

One other generic type of pump tested was the free-diaphragm pump whose characteristics are illustrated in Figure 29. There was some hope at the outset of the testing programmes that diaphragm pumps might, through low internal friction, prove a superior type of positive displacement pump for low head applications. In the event, this particular type proved not to be competitive with the better centrifugals, although testing of one example of one type of pump genre cannot be conclusive. The reason for the lower efficiency than expected is not clear on the basis of the limited testing so far completed, and the original hypothesis has not been totally disproved.

The most well known type of positive displacement pump was also tested - this was in the reciprocating piston pump or "bucket" pump of the kind commonly used as a hand pump. These are well understood and widely applied in agricultural applications, common examples being hand, diesel, electric or wind powered via suitable transmission systems to reduce the input power source to a reciprocating drive in the range 50 to 100 strokes per minute, or sometimes more. However they are not efficient at heads much below 10 or 20m and therefore of little interest for irrigation duties.

#### 4.7.4 Importance of Minimising Pipe Losses

The system design study (see section 4.9) confirmed that lack of care in specifying the delivery pipework associated with the pump can seriously affect system efficiency, particularly with low static heads. This is particularly important in situations where a long pipe is involved. Relevant points are discussed in section 4.12.

## 4.8 Mechanical Transmissions

Since Phase I of the Project was concerned with low head pumping, transmission systems were not considered in detail. A few general points are reviewed below.

Most centrifugal pumps will be direct coupled to a motor, either by a long shaft, or in the case of surface-suction pumps and integrated submersible motor-pump units, close coupled. This is because the speed requirements for economical motors and for economical centrifugal pumps are similar, i.e. typically in the 2000 to 3000 rpm range.

With direct-coupled pumps, it is advantageous (except with integrated motor-pump units) if both motor and pump have completely independent shafts and bearings, (i.e. 2 bearings each) and if the coupling is flexible to allow for a certain degree of misalignment; otherwise premature bearing wear can be expected.

Most positive displacement pumps run at much lower speeds than motors (piston pumps typically at 50 to 150 strokes/minute) and a speed reducing transmission is necessary. But, as already explained, this type of pump is likely to be used for higher head pumping duties than would be appropriate for irrigation.

A critical requirement from any transmission is that it should have high efficiency as well as the necessary robustness and long life required from a solar pumping system. Possibilities for such duties include belts and pulleys (preferably poly-vee or toothed, although the latter can transmit damaging torsional shocks from a reciprocating pump). Various types of gear box and low speed pitman drives would be appropriate for use with slow-speed reciprocating pumps located in deep boreholes.

#### 4.9 Photovoltaic Pumping System Optimisation

The characteristics of PV cells and arrays have been described earlier in section 4.4. To recapitulate; the characteristic of a PV array (such as illustrated in Figures 15, 17 and 18) is unique at a given irradiance level and array temperature. This is further illustrated by Figures 30a and b.

As shown in Figure 15, the maximum efficiency of a cell, or of an array of cells, occurs for the values of  $I$  and  $V$  on the characteristic such that the product of  $I$  and  $V$  is maximised. Since the product of  $I$  and  $V$  for any given point on the  $I$ - $V$  curve is a rectangle of sides  $I$  by  $V$ , the maximum power point on the curve is that which produces a rectangle with the largest area capable of fitting within the curve and it will therefore be on the "knee" of the curve. Clearly it is important to operate any PV system so as to draw a current such that the array will operate at or close to its maximum power point.

Figure 30a shows the maximum power point for three irradiance levels (500, 750 and 1000W/sq.m.) at a temperature of 40°C. A curve m-m can be drawn through these points which is the locus of the maximum power points (or maximum efficiency points) for that temperature. It can be inferred from Figure 30b that changes in temperature will tend to move the m-m locus slightly from side to side.

The  $I$  and  $V$  values for the PV subsystem, or load, at any given instant must be the same as those for the array, so the actual  $I$ - $V$  values that will occur for a given irradiance level depend on the impedance of the electrical load. (Impedance can be quantified as the ratio of  $V/I$ ; with purely resistive loads, the impedance equals the resistance, measured in ohms if  $V$  is in volts and  $I$  in amps). If the impedance is very high, such as on open circuit,  $I$  will be zero and  $V$  will be  $V_{OC}$  (i.e. the point at which the  $I$ - $V$  characteristic cuts the  $V$  axis) and if the impedance is very low, such as a short-circuit,  $V$  will be essentially zero and  $I$  will be  $I_{SC}$ , (where the characteristic cuts the  $I$  axis). Figure 15 shows that the power output and hence the efficiency is effectively zero under the two extreme conditions mentioned.

In order to maximise the output (and the efficiency) of the system under all operating levels of irradiance, the load should be such that its impedance should vary to coincide as closely as possible with the  $I$ - $V$  ratios represented by the maximum power point locus m-m in Figure 30a. In practice, it is common for the load to be correctly matched for just one level of irradiance, such as say 1000W/ $m_2$  but for the subsystem power demand at lower levels of irradiance to cause the array to operate further and further from optimum such as illustrated by locii  $m_1 - m_2$  or  $m_2 - m_2$  in Figure 30a.

Figure 30c shows that, up to the maximum levels of voltage and current the motor can safely bear, there are unique values of torque and speed corresponding to any unique value of voltage and current. If the array characteristic is super-

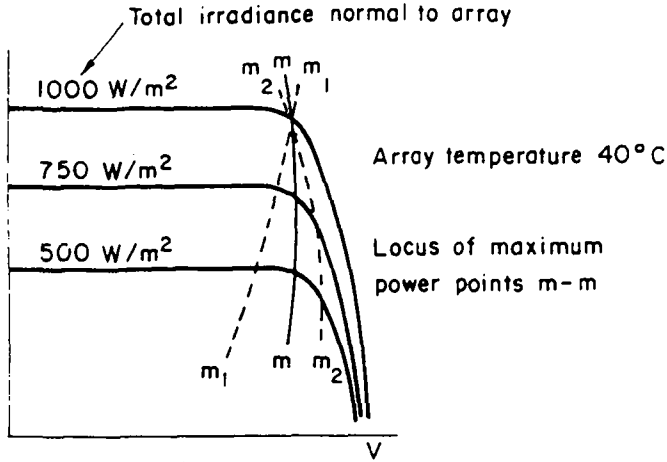

(a) ARRAY CHARACTERISTIC WITH VARYING IRRADIANCE LEVELS

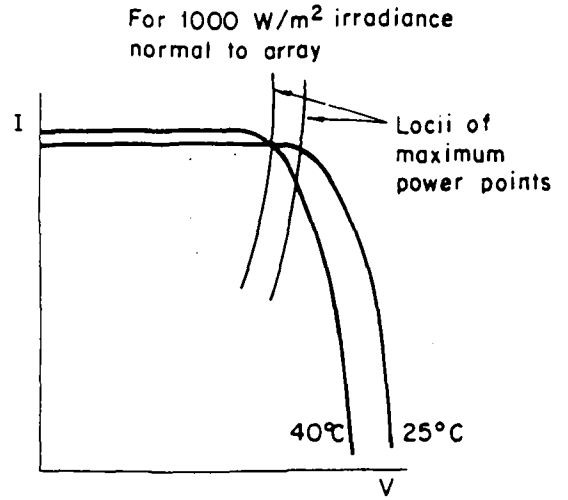

(b) ARRAY CHARACTERISTIC WITH VARYING TEMPERATURES

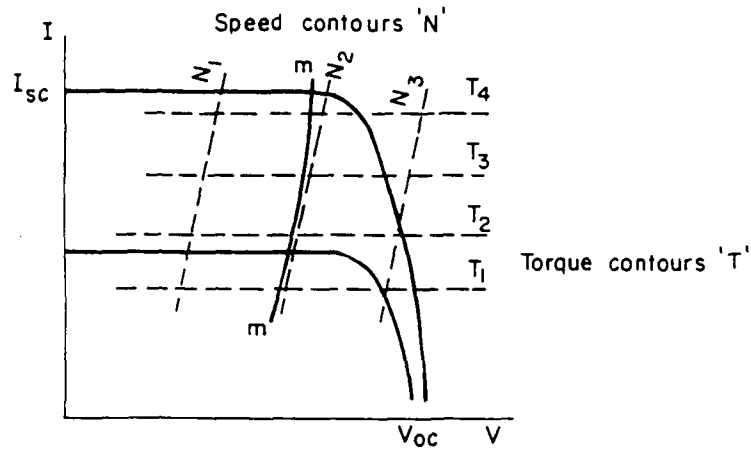

(c) MOTOR CHARACTERISTIC WITH MAXIMUM ARRAY POWER LOCUS SUPERIMPOSED

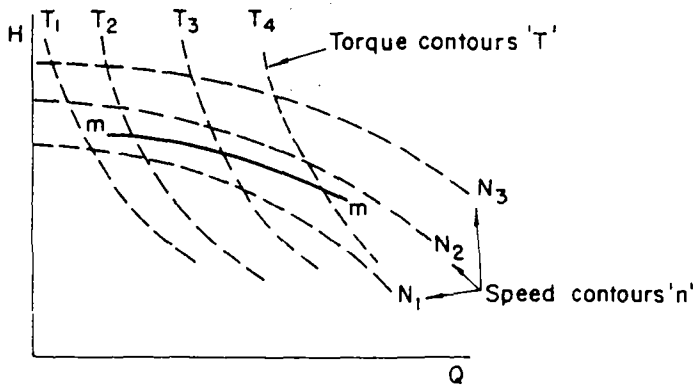

(d) ARRAY MAXIMUM POWER LOCUS TRANSPOSED ONTO PUMP CHARACTERISTIC

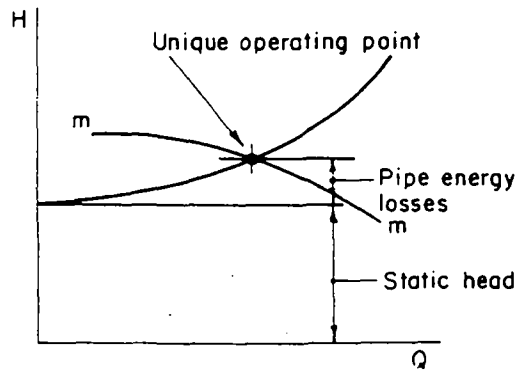

(e) MAXIMUM POWER LOCUS SUPERIMPOSED ON PIPEWORK CHARACTERISTIC

FIGURE 30 – PERFORMANCE CHARACTERISTICS OF PHOTOVOLTAIC SYSTEM COMPONENTS

imposed on the motor I-V plane, it generates a unique set of speed and torque values, as does the maximum power point locus m-m. i.e. for every point on the array maximum power point line there will be a value of motor speed and torque which is required in order to draw the correct current and voltage from the array.

If the motor is direct-coupled to the pump, then the motor and pump speed and torque at any given moment must be coincident; where the pump is driven via a transmission, a fixed ratio will apply together with a small power loss due to the transmission. Pump characteristics are most conveniently represented on a head versus flow plane (H-Q) as shown in Figure 30d. Any value of head and flow for the pump will require a unique pump speed and torque, and these can be superimposed on the H-Q plane as a set of constant speed and constant torque curves as shown in the Figure.

The torque and speed values coinciding with the array optimum power line m-m in Figure 30c can then be transformed into a coincident line on the pump H-Q plane, as indicated in Figure 30d. In other words there is a unique set of head and flow conditions which optimally loads the motor and in turn the array for all levels of irradiance. These are indicated by the curve m-m in Figure 30d.

The pump is connected to pipe-work which will have a characteristic in the H-Q plane of the kind shown in Figure 30e, consisting of the sum of the static head and pipe energy losses. If the curve m-m from the pump H-Q plane is transposed onto the pipework H-Q plane, (since the head and flow experienced by the pipework will coincide with those for the pump), then it can be seen that there is a unique single H-Q point on the m-m system maximum power or efficiency curve where maximum efficiency is obtained from the system. This unique point can be transposed back through the various planes to the array and results in a unique irradiance level, (and array temperature), where maximum efficiency is obtained from the system. This shows that for any PV pumping system there is a unique value of pumping head (total head across the pump) and flow which will optimally load the array at any irradiance level above the system's threshold.

It follows from this that PV solar pumping systems need their components to be carefully matched so that:

- o the motor-pump subsystem loads the array in such a way that as the irradiance varies, the voltage and current requirements remain at or close to the maximum power point locus.
- o the system optimum operating point, which will lie on this locus, should be correct for the head and flow required at the design irradiance level.

Clearly the correct matching of subsystems and arrays is a complex analytical process which is greatly facilitated through the use of a computer model which permits an iterative approach to be used.

Figure 31 shows the measured characteristics of a typical solar PV pumping system (Pompes Guinard borehole system at Yangasso in Mali), and it can be seen from the lowest curve in the Figure that this system is optimised to achieve its maximum efficiency at between 700 and 800W/m<sup>2</sup> of irradiance. It can also be seen that the system requires about 200W/m<sup>2</sup> to start and it achieves a maximum system efficiency of almost 3.5%.



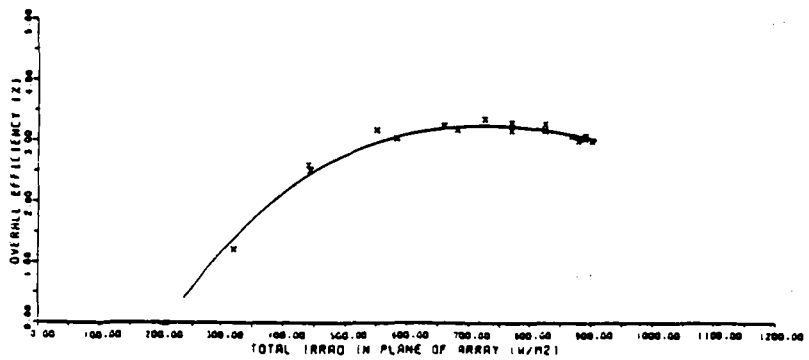
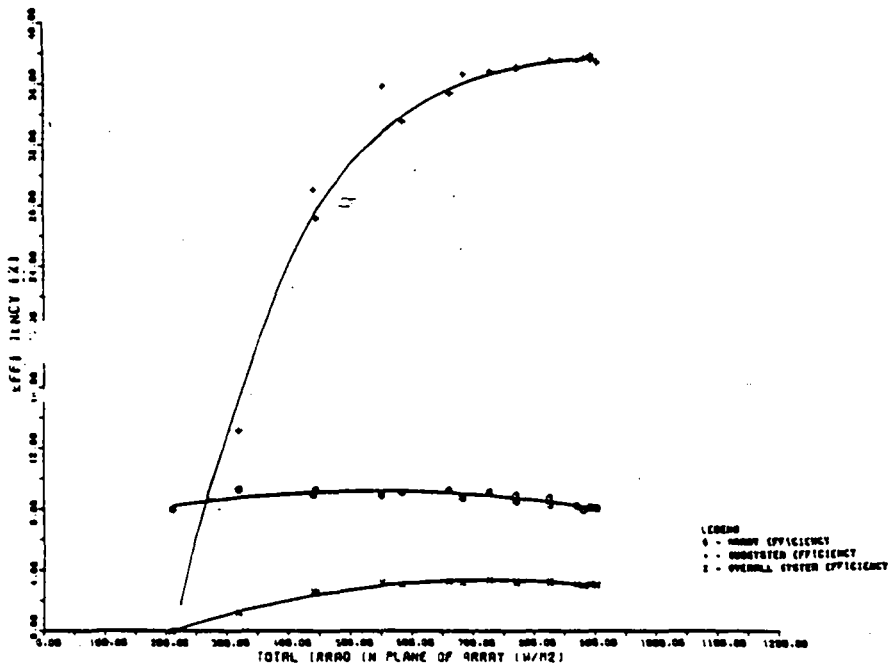
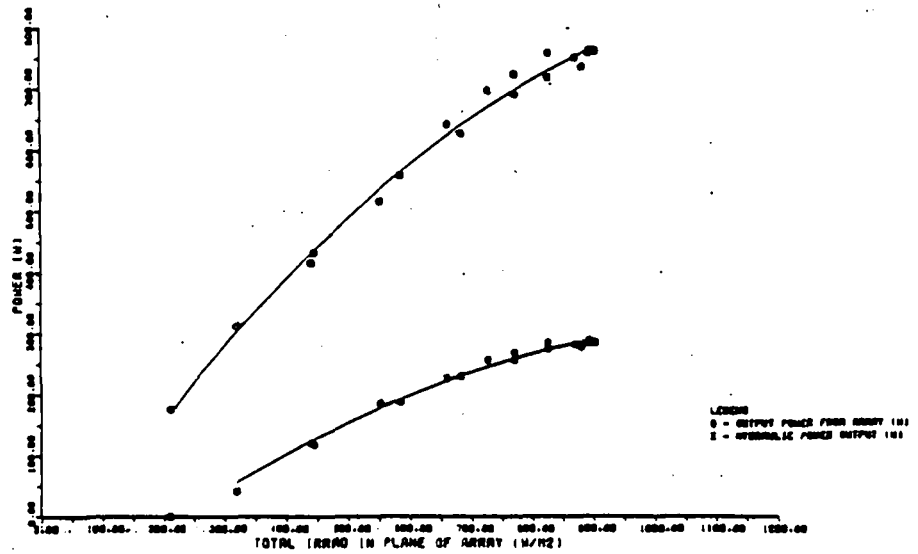

FIGURE 31 - PERFORMANCE OF POMPES GUINARD SYSTEM IN MALI V IRRADIANCE

Figure 32 shows the daily output of the same system recorded over a period of several weeks. There is a lot of scatter because, although two days may have an equal total cumulative irradiation, the cloud patterns and direct diffuse ratios vary all the time, which is why the cumulative daily pumped water output and the overall daily system efficiency are not necessarily the same for a given cumulative energy input. High daily outputs for a given irradiation level imply more hours of sunlight at near the optimum irradiance level for the system, and vice-versa.

Figures 33 and 34 show similar curves as for Figures 31 and 32 respectively, but for the Arco Solar system in the Sudan. This is optimised for a higher irradiance level (which is sensible since Sudan will normally have more direct sunshine than Mali) and this is confirmed by the much lower level of scatter in Figure 34, showing that the solar regime varies much less day by day in the Sudan over the period recorded, mainly due to the rarity of clouds there at that time of the year (the tests in Mali were conducted partially during the rainy season).

#### 4.10 Power Conditioners and Maximum Power Point Trackers

It is possible to install an electronic device between the array and the load or sub-system which will automatically optimise the load on the array. What this device does is to effectively alter the load impedance to match the optimum impedance of the array. It does this by changing the voltage current ratio required by the load through the use of dc-dc voltage transformation; two systems tested (from Solar Electric International and from SOTEREM) incorporated power conditioners for this purpose.

The SEI system uses a maximum power point tracker (MPPT). This monitors the voltage applied to the load at brief time intervals (and hence the power supplied) and uses a logic circuit to control a high-efficiency pulse-width modulated down converter (PWMDC) to match the array operating point to motor demand, (Reference 28). The logic uses a "hill climbing" technique which causes the system to hunt for the maximum power of the load condition, and then to hunt by a small amount (about 1%) either side of the optimum point. If irradiance levels, array temperatures, the pumping head, or any other conditions change, then the logic circuit will seek the new maximum power point.

Significant benefits can be gained from a MPPT of this kind, but ironically, the most benefits would be for a badly designed system with an ill-matched array and subsystem, or one operating well off its design conditions.

However, the MPPT also consumes a certain amount of power (about 4 to 7% according to Reference 28), and thereby represents an energy drain which must be set against the savings it obtains. It also, at present, appears to be an expensive component, costing as much or more than the electric motor, so in terms of cost-effectiveness, the cost has to be set against energy gained.

A good system with a well-matched centrifugal pump can be designed so that it naturally has a close match between the maximum power and efficiency locus of the array, but systems with piston or other positive displacement pumps do not match at all naturally because a positive displacement pump, at a given head, tends to draw an almost constant current (it is a constant torque device). Hence, the voltage needs to be changed to maximise the power drawn, which does not happen

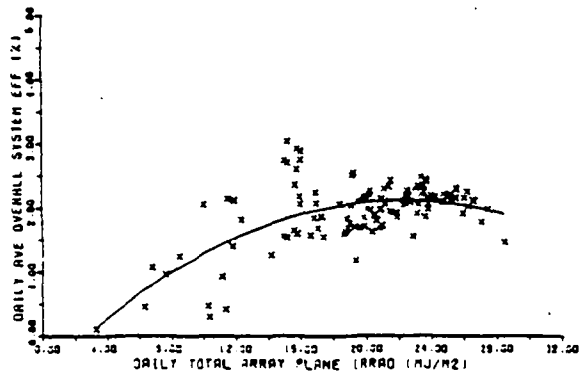
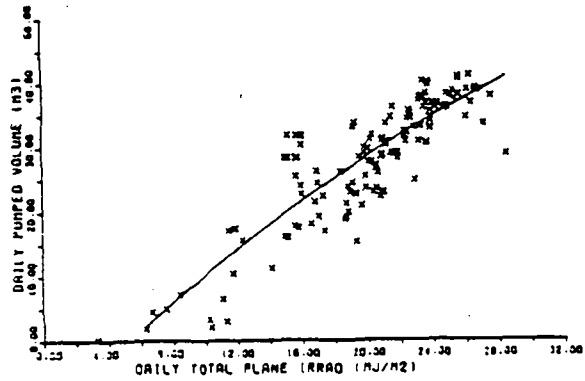

Note: Array and sub-system efficiencies unknown as array energy output not recorded.

FIGURE 32 – DAILY OUTPUT OF POMPES GUINARD SYSTEM IN MALI

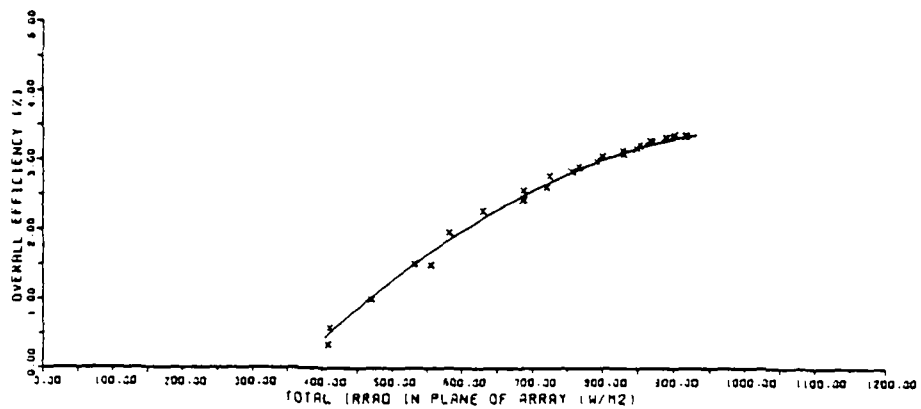
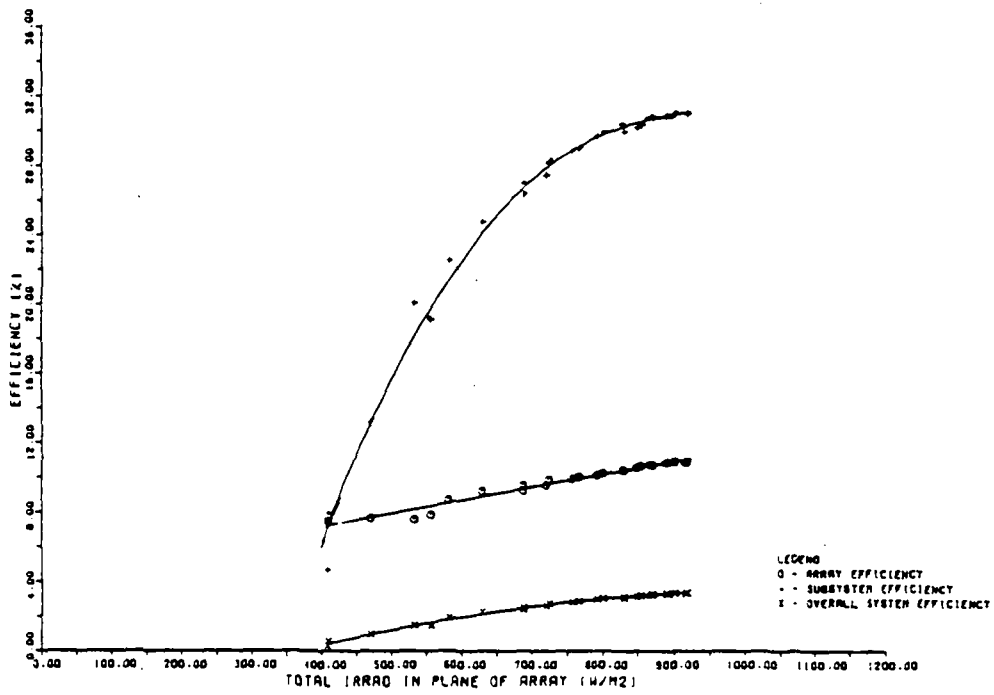
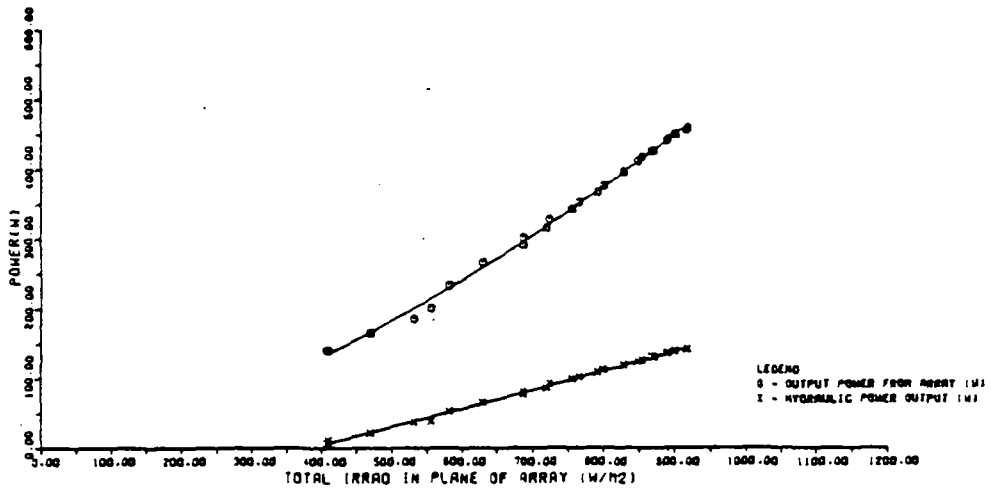

FIGURE 33 - PERFORMANCE OF ARCO SOLAR SYSTEM IN SUDAN V IRRADIANCE

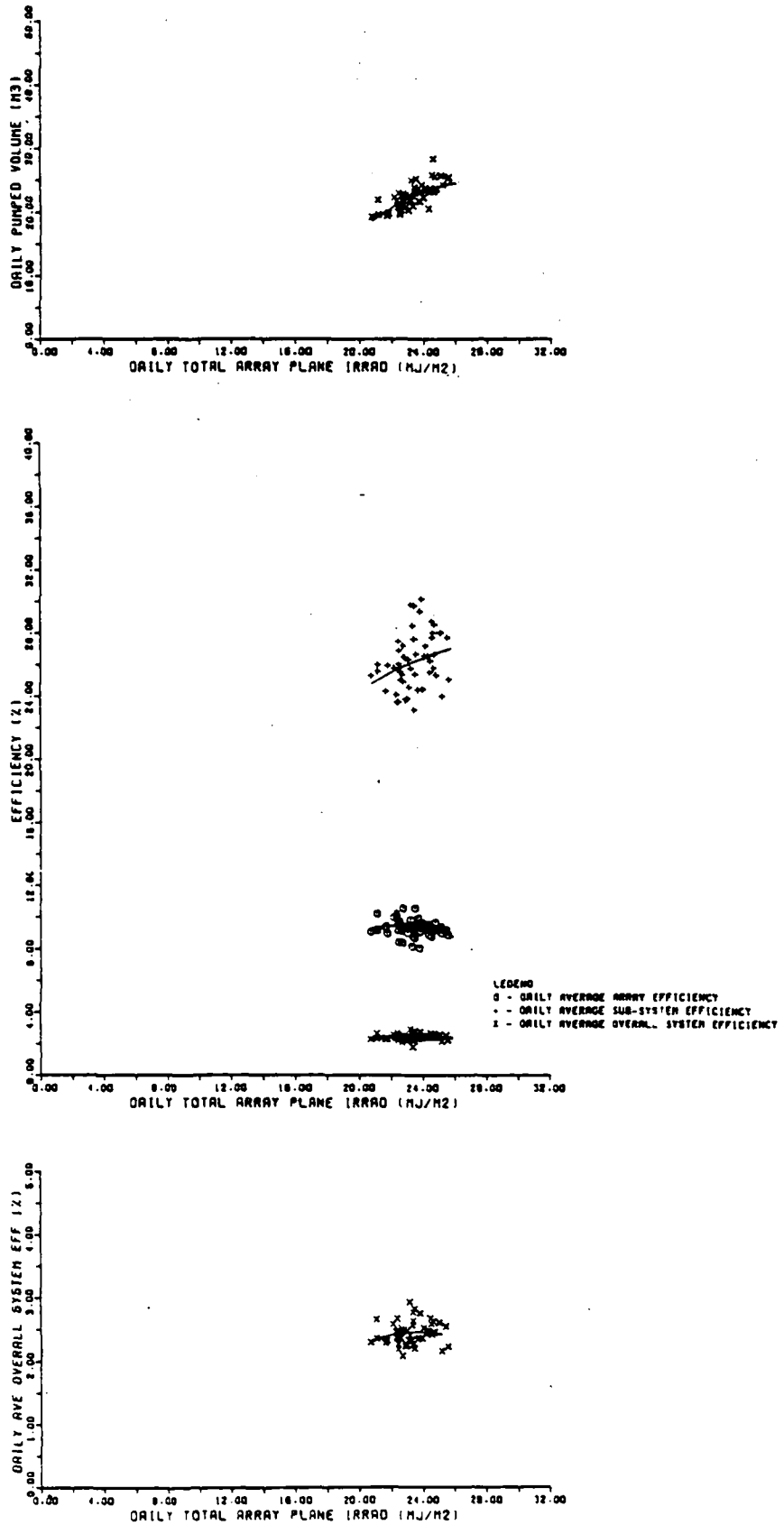

FIGURE 34 – DAILY OUTPUT OF ARCO SOLAR SYSTEM IN SUDAN

naturally with PV arrays under varying irradiance levels. The SOTEREM system uses a form of MPPT to compensate for this and no doubt MPPTs will have a useful role in conjunction with positive displacement pumps.

The use of electrical storage batteries, with a charging circuit to switch off the motor when the battery is discharged and to switch off the array if it is fully charged, offers another form of power conditioning by permitting the motor/pump unit to operate under almost constant and optimised I–V conditions. However, as outlined previously in section 4.6, batteries appear to have so many problems associated with their use under field conditions which apply to micro-irrigation, that it remains to be demonstrated whether they would, on balance, be beneficial in this application.

#### 4.11 The Project Design Study Mathematical Model

To investigate the matching of system components as part of the Project design study described in detail in the accompanying Project Report, the Consultants developed a computer-based mathematical model of a PV solar pumping system with which different component performance characteristics could be simulated and their interactions investigated.

An outline block diagram of the model is given in Figure 35. The model contains the sets of equations which describe the performance of each component and solves them numerically to yield the unique set of H, Q, T, n, I and V values for a given irradiance level and array temperature.

The motor and pump characteristics used for the model were derived directly from the data obtained from laboratory tests of motors and pumps, smoothed by various normalisation processes to eliminate the scatter that results from practical experiment. Typical curves from the laboratory testing programme have been used, e.g. Figure 23 (motor) and Figures 24 to 29 (pumps of various kinds).

The model was validated by making it simulate actual systems tested in the field, (the subsystems of which were laboratory tested). Figure 36 illustrates a validation result comparing actual field results with field simulation results (of the Arco Solar system tested in the Sudan). A sufficiently satisfactory correlation was obtained so that the general conclusions drawn from simulated runs of modified or different systems can be considered as reasonably accurate.

The model has a solar input derived from typical daily recorded irradiance data, and recalculates H, Q, T, n, I and V for the specified system at predetermined intervals through the day. It also calculates the pumped output assuming quasi-steady state conditions during the time interval used and adds the output to those from the previous time intervals to arrive at an integrated value for daily pumped output, as shown by the Total Volume curve of Figure 36.

To allow a useful comparison between system options, two standard “solar days” were used as inputs: one was derived from Sudan data for a typical arid region, with a high proportion of direct radiation and virtually no passing clouds; the other, derived from Philippine data had a higher level of diffuse with intermittent clouds in the afternoon.

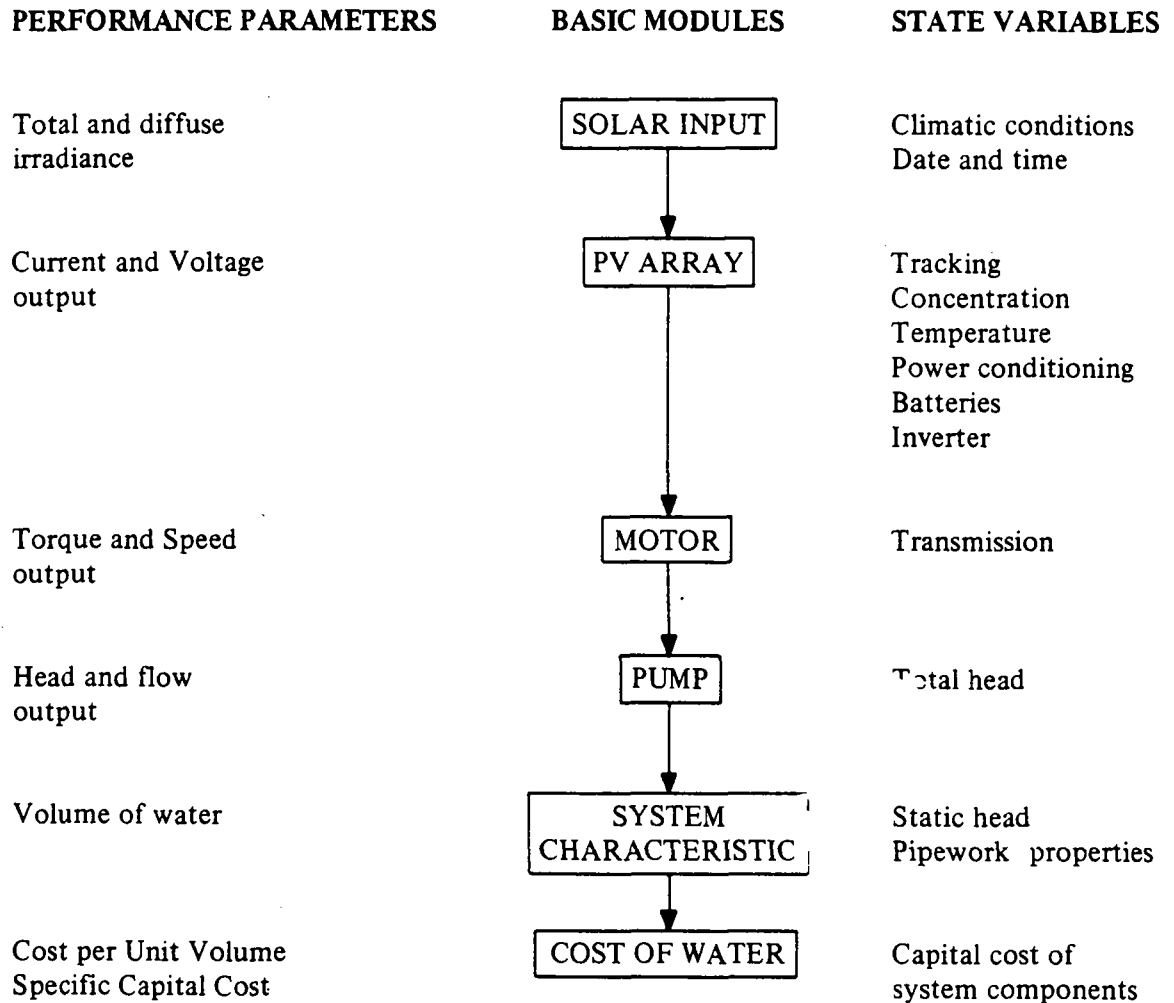

FIGURE 35 – BLOCK DIAGRAM FOR PHOTOVOLTAIC SYSTEM MODEL

System : A  
Supplier : Arco Solar  
Field results for 20 Oct 80

Flow (l/s)

1.0  
0.5

FLOW  
(l/s)

Volume (m<sup>3</sup>)

20  
15  
10  
5  
0

Model results

Field results

Model results

Field results

TOTAL  
VOLUME  
(m<sup>3</sup>)

0  
1.5

Time (hours)

8  
9  
10  
11  
12  
13  
14  
15

FIGURE 36 - VALIDATION OF PHOTOVOLTAIC SYSTEM MODEL (PUMP OUTPUT)

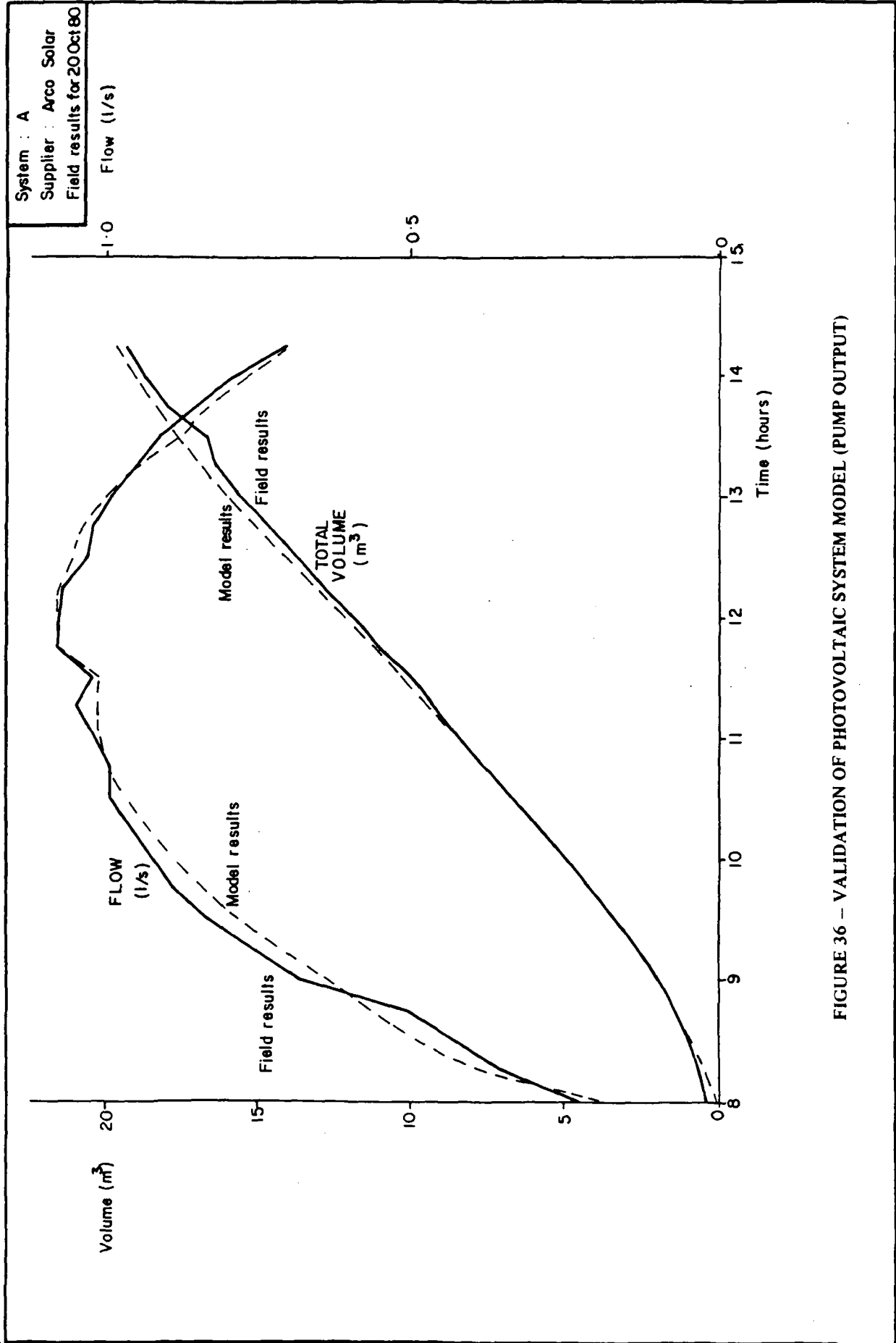



To derive a true cost of unit output of water, it would have been necessary to make a large number of assumptions not directly related to system concepts, such as the pattern of use, solar variation through the year, discount rates, economic lifetimes, etc. To avoid these assumptions a simplification was introduced in which the capital or first cost of the system was related to its expected daily output under the standard solar day in order to express the investment in equipment of a particular type required to produce a given number of kilo-joules of hydraulic pumped energy per standard solar day. This gives a relative measure of output costs from different systems "all other things not related to the system being equal" i.e. a measure of their cost-effectiveness. The parameter used was called "Specific Capital Cost"\* and was computed in units of US\$/kJ per day. The Specific Capital Cost is a reasonable measure of system "goodness" since first cost is in the end the dominant cost for all solar pumping systems and it can fairly be assumed that recurrent costs are independent of the concept used.

The cost data used in the model were prepared on the basis of the cost of components in a typical developing country for large volume orders. Arbitrary factors which enter into the price of particular manufacturers were eliminated by reference to the power, weight and size of the component concerned.

A programme of model runs was conducted, simulating many of the systems tested in the field and then simulating the effects of various modifications on a typical system. The kinds of modifications investigated were:-

- o static head variation, to find the optimum operating head for each system
- o solar day variation, to find if some systems were optimised for hazy rather than direct sunlight conditions or vice-versa.
- o reoptimisation of the PV array to find the best series-parallel mix of cells to minimise the Specific Capital Cost and also, to maximise the output with the original power rating. The conclusions in most cases could only be implemented through the use of modules which are generally available because of the non standard number of cells per module required. However, if the solar pumping system were to be mass-produced, then the production of special modules may be justified.
- o impedance matching, to investigate the use of electronic impedance matching devices which automatically reoptimise the subsystem I-V requirement to match the maximum power locus of the array by in effect acting as a dc-dc transformer. Such devices, however, cost money and absorb a proportion of the power. Therefore the model was used to investigate their cost-effectiveness under different cost and efficiency assumptions.
- o the effect of sun tracking, either continuously or intermittently (manually) was investigated. Continuous tracking is obviously best in terms of maximising the output, but it is much more expensive. Therefore the model evaluated the cost-effectiveness of the different options.

---

\* See Appendix 2, page A8 for definition of Specific Capital Cost.

- o finally, the optimum pipe diameters were investigated by trading off the reduced resistance of larger diameter pipe against its extra cost, for a given length of pipe with different systems.

These represent just a few of the areas that can usefully be investigated with a model of this kind. At the time of preparation of this Report the field and laboratory data have only been available for a short period and therefore the full potential of the model remains to be exploited in future Phases of the Project.

#### 4.12 Results obtained from Model Testing

The Project Report (chapter 4.4) discusses the results obtained in detail so it is only intended here to give an outline description of them in so far as they relate to the general design of solar PV pumping systems.

The Arco Solar system was used extensively as a subject for the model investigations, because it is a simple and conventional design which appeared to be reasonable well but not perfectly optimised because it had a better than average, but not the best, efficiency; and because it seemed to be potentially one of the more cost-effective systems. A well documented and comprehensive data base was also available largely due to the clear sunny conditions that prevail in the Khartoum area where the tests took place. Therefore the examples of what might be possible in the way of improvements use the Arco Solar system as an example, but could equally apply to virtually all the other systems tested.

Figure 37 shows how the efficiency of the system varies with head; clearly the system as supplied was effectively optimised for about 7.5m, and performed reasonably well for heads in the 6 to 10m, range. The array voltage was then "altered" in the model by increasing and decreasing the cell string length by units of 10%, keeping the actual number of cells and hence the power rating constant. To do this in practice would probably need non-standard modules, which would explain why the systems were often not perfectly optimised. A 13% improvement in maximum efficiency was obtained with the model of the Arco Solar system by reducing the array nominal voltage by 20%. A second optimisation exercise was to change the array power (number of cells), keeping to the optimum voltage, to obtain the most cost-effective system; i.e. trading off array cost against output - a smaller array might mean a reduced output, but the cost might also go down by a proportionately greater amount. With the present day array cost assumptions built into the model, the Arco Solar system actually became more cost-effective according to the model with one less module in the array. Clearly as array costs change, the optimum power rating for cost-effectiveness will also tend to change.

Figure 38 shows how the cumulative daily output varies with head using the "Standard hazy day" and the "Standard clear day" solar input. If the system efficiency remained constant at its maximum level, then a hyperbolically increasing output curve would be expected as shown by a broken line in the Figure. But due to declining efficiency at lower heads, the output tends to be almost linearly related to head; this kind of effect will of course apply to most other systems too.

Supplier: Arco Solar  
Standard clear day

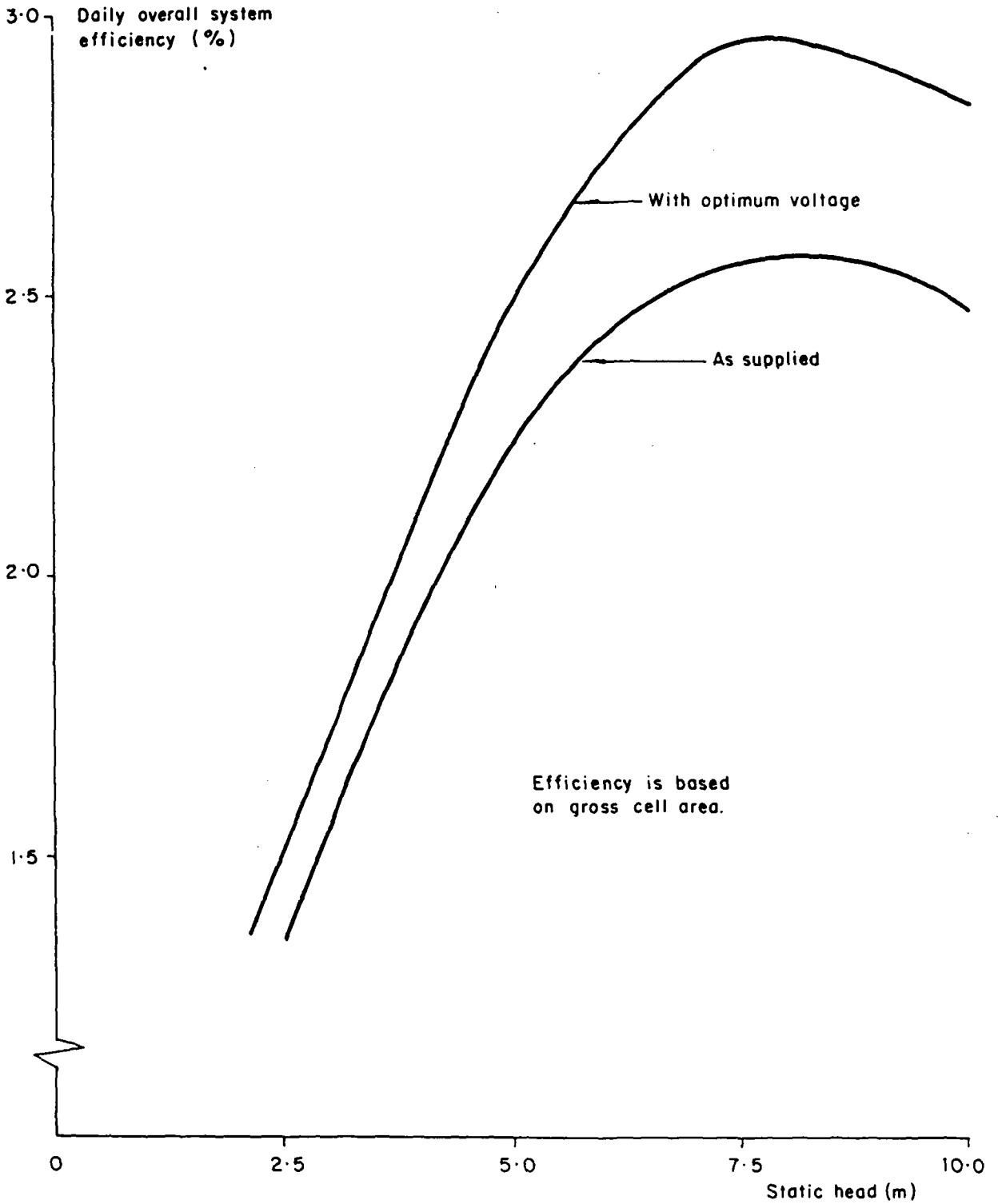

FIGURE 37 - VARIATION OF DAILY OVERALL SYSTEM EFFICIENCY WITH HEAD FOR ARRAY OPTIMISED SYSTEM

System : A  
Supplier : Arco Solar

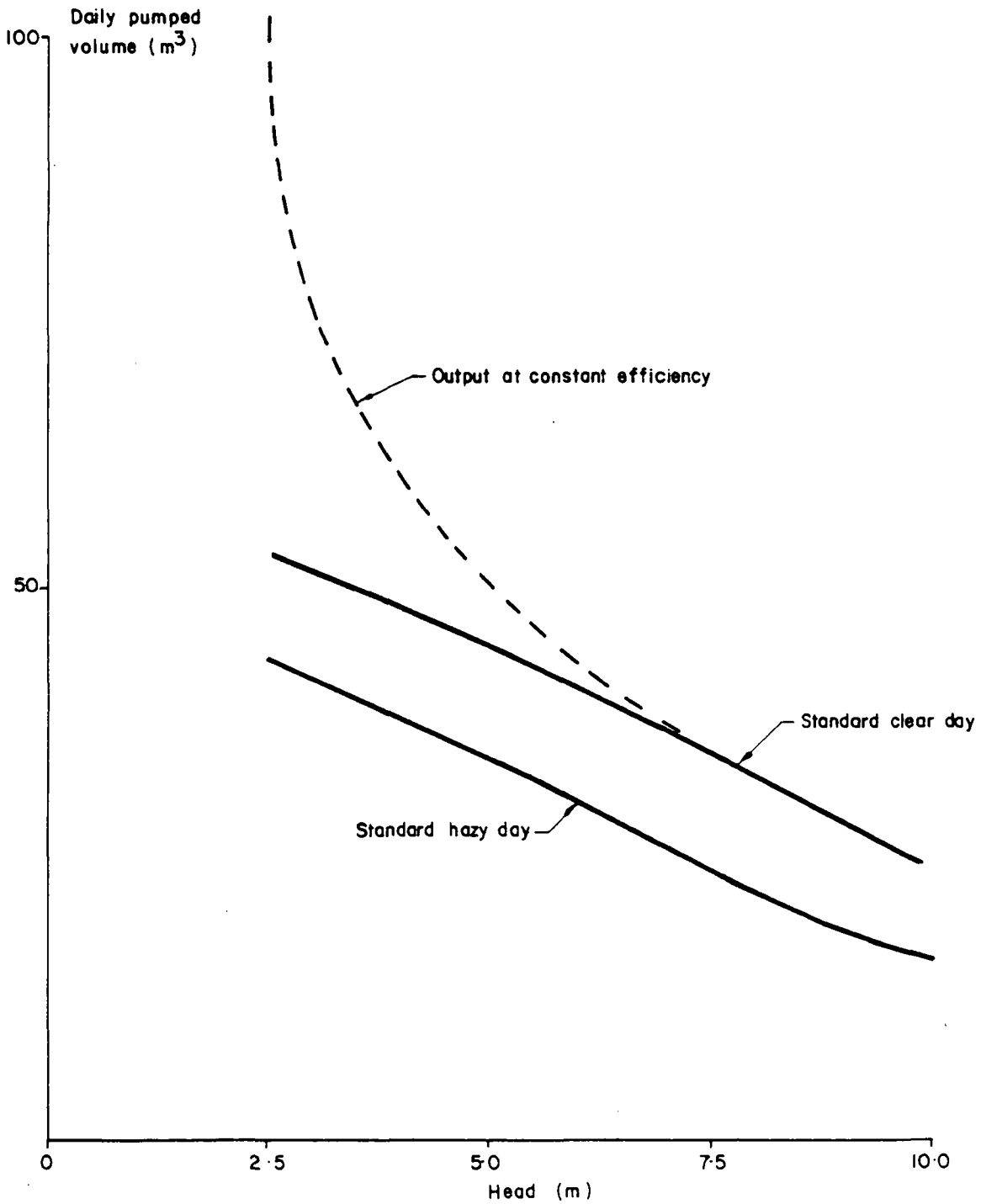

FIGURE 38 - VARIATION OF OUTPUT WITH HEAD FOR PHOTOVOLTAIC SYSTEMS

The use of a MPPT can partially compensate, but not to a great extent. This is because the pump itself varies in efficiency at different heads, (see for example Figure 24), and this affects the system efficiency more profoundly than any impedance mis-match. The effect of applying a MPPT to the Arco Solar system is shown in Figure 39. A MPPT with 10% parasitic power drain is almost equal to simple array voltage and power optimisation (which of course costs much less than the MPPT) although a hypothetical cost-free MPPT does improve the system maximum efficiency, but mainly close to the design head.

One of the most cost-effective ways of improving the daily output (and reducing Specific Capital Cost), was occasional manual tracking. This was discussed in detail earlier in section 2.7.3 under the heading of “system efficiency”.

An initial appraisal was made of the effect of variation in pipework diameter on system economics. The result is shown in Figure 40 and confirms the dramatic importance of not using pipes which are too small. Purchasers might be tempted to save a little on the capital cost by accepting small pipes, but this would be totally vitiated by the cost of the energy consumed in pipe friction. The Specific Capital Cost is sensitive because pipe friction is inversely proportional to the fifth power of diameter whereas pipe costs are related to the square of diameter. Footvalves, sharp bends, kinks, valves and unrecovered exit losses all add to the loss of energy, and attention to detailed design is required if these losses are to be minimised.

Table 8 summarises the main findings in connection with the investigations of the modelled Arco Solar system. It can be seen that voltage and power optimisation can obtain a 12% reduction in Specific Capital Cost. Manual tracking of the sun (two adjustments per day) reduces the SCC by 6%. But the combination of the above two improvements reduces SCC by as much as 32%. The use of a MPPT with manual tracking (with 10% losses) increases the daily output from 32% to 39% but is less effective in terms of reducing the SCC, because of the quite high cost of the MPPT.

It must be stressed that these results are indicative of the relative merits of different options as revealed by the model; they apply only under “Standard solar day” conditions. It remains to be tested under the next Phase of the Project, how well the improvements predicted by the model can be achieved in practice, by making the modifications that appear to be beneficial to actual systems and retesting them.

Supplier : Arco Solar  
Standard clear day  
System with MPPT.

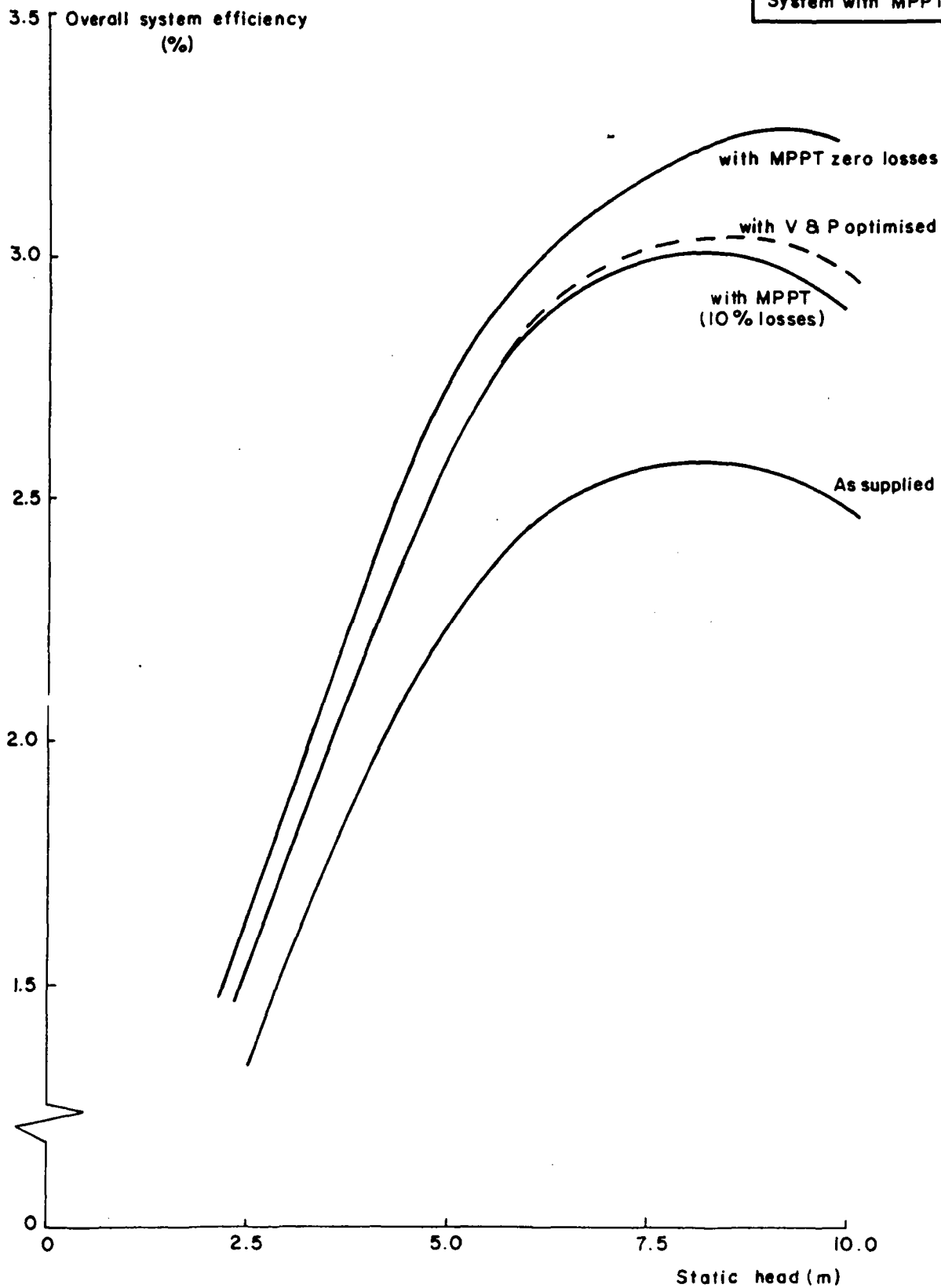

FIGURE 39 – VARIATION OF DAILY OVERALL SYSTEM EFFICIENCY WITH HEAD FOR SYSTEM WITH MAXIMUM POWER POINT TRACKER

Static head = 5 m  
standard clear day

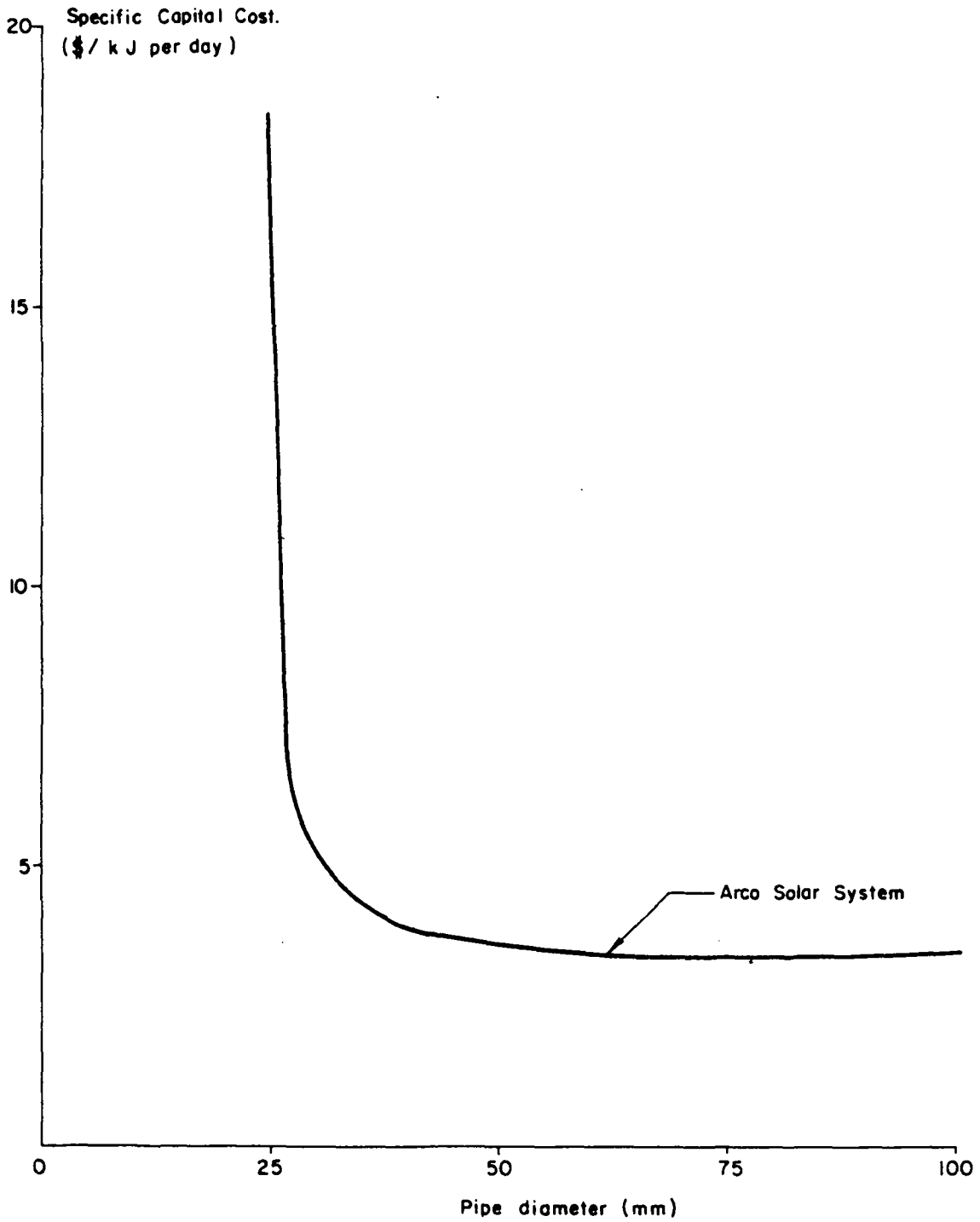

FIGURE 40 – EFFECT OF PIPEWORK CHANGES ON SPECIFIC CAPITAL COST

MODIFICATION	Effective <sup>(1)</sup> Overall efficiency (%)	Specific Capital Cost (\$/kJ per day)	Daily output at 5m head (standard clear day) (m <sup>3</sup> )	Effect compared with basic system, on	
				Volume pumped	Spec. Capital Cost
None - System as supplied	2.2	3.4	44.9	1.00	1.00
Voltage and power optimized by changing array cells series/parallel arrangement	2.6	3.0	46.6	(2)	0.88
MPPT (10% losses) (maximum power point tracker)	2.5	3.1	51.2	1.14	0.91
Manual tracking of sun (2 adjustments of array position per day)	2.9	2.6	57.7	1.30	0.94
Voltage and power optimized plus manual tracking	3.3	2.3	60.3	(2)	0.68
MPPT plus manual sun tracking	3.1	2.5	62.3	1.39	0.74

Notes:

(1) based on irradiation on fixed array (referenced to cell area).

(2) power is reduced and so pumped volume is not comparable  
with basic system.

**TABLE 8 – RESULTS OF MAKING ‘IMPROVEMENTS’ TO A PV PUMPING SYSTEM BY  
USING THE MATHEMATICAL SIMULATION MODEL**



## 5. SOLAR PUMPING TECHNOLOGY – THERMAL SYSTEMS

### 5.1 History

Solar thermal power systems are by no means a new development; a workable solar steam engine of several horsepower, heated from an axicon focusing collector, was developed by Mouchot and Pifre in France during the 1870's. Their engine was demonstrated driving a small printing press at the Paris Exhibition of 1878.

Willsie and Boyle built a number of solar steam engines with outputs in the 6 to 20hp range in the USA between 1902 and 1908, while their contemporary, Shuman, developed the first steam engine to be heated from a flat plate solar collector, also in the USA. In 1913 Shuman and Boys installed a 50hp solar-powered irrigation pumping engine near Cairo in Egypt, using linear parabolic collectors. This pioneering solar irrigation system (and other contemporary systems in the USA) functioned reasonably effectively until after a few years they were all superseded by the introduction of internal combustion engines driving pumps and/or by mains electricity supplies, which at that time were becoming cheaper and more convenient, (see, for example, Reference 30 for a more detailed historical account).

The early solar-powered systems mentioned above generally used steam as a working fluid; therefore concentrating solar collectors with modest concentration factors were usually used in an effort to achieve a reasonable compromise between attaining a sufficient steam temperature for adequate engine thermodynamic efficiency yet retaining a low enough concentration factor to minimise the accuracy needed for solar tracking.

In contrast, the majority of modern small solar thermal powered systems have used heavy organic vapours of the kinds commonly used in refrigeration and air-conditioning systems as working fluids. These boil at a temperature low enough to permit the use of non-tracking, flat plate solar collectors at the expense of greater complexity in the design of the engine expander and rather low thermodynamic efficiency and consequently a larger collector area requirement to achieve a given output. There are difficult technical decisions to be made when defining the design philosophy for solar thermal systems due to the conflicting requirements for achieving good collector efficiency and good engine efficiency.

Experimental work on solar thermal engines continued in many countries, but it was not until the 1960's when it became clear that solar power might have widespread application in arid, sparsely populated regions, particularly for water pumping, that serious attempts to develop viable systems were again made, mainly in France and Israel.

At the present stage of development there has been no clear demonstration that there is any single optimum approach to solar thermal powered system design. In any case, factors such as the size of the system (power output), application and manufacturing environment, must inevitably introduce important constraints.

Despite the long history of solar thermal powered systems, there are still no manufacturers producing systems on a commercial basis in the world market. In the Consultants opinion, none of the systems currently available is as yet sufficiently developed to be viable in comparison with many other energy conversion

LOCATION	POWER (KW)	COLLECTOR AREA (m <sup>2</sup> )	DELIVERY FLOW RATE (m <sup>3</sup> /h)	WATER HEAD (m)	DAILY OPERATING TIME h	AREA IRRIGATED (ha)	APPROX COST (\$)
DIRE Mali	70	3200	1800	8	6-11	150	1,640,000
TABALAK Niger	5	400	150	6	5-6		
KARMA Niger	10	800	300	6	5-6		
BAKEL Senegal(1)	32	1870	600	10	10	100	540,000
SAN LUIS DE LA PAZ Mexico	25 (1)	1500	150	54	5-6		

Note: (1) In association with Thermoelectron Corp (USA)

TABLE 9 -- LARGE--SCALE SOFRETES SOLAR THERMAL PUMPING INSTALLATIONS

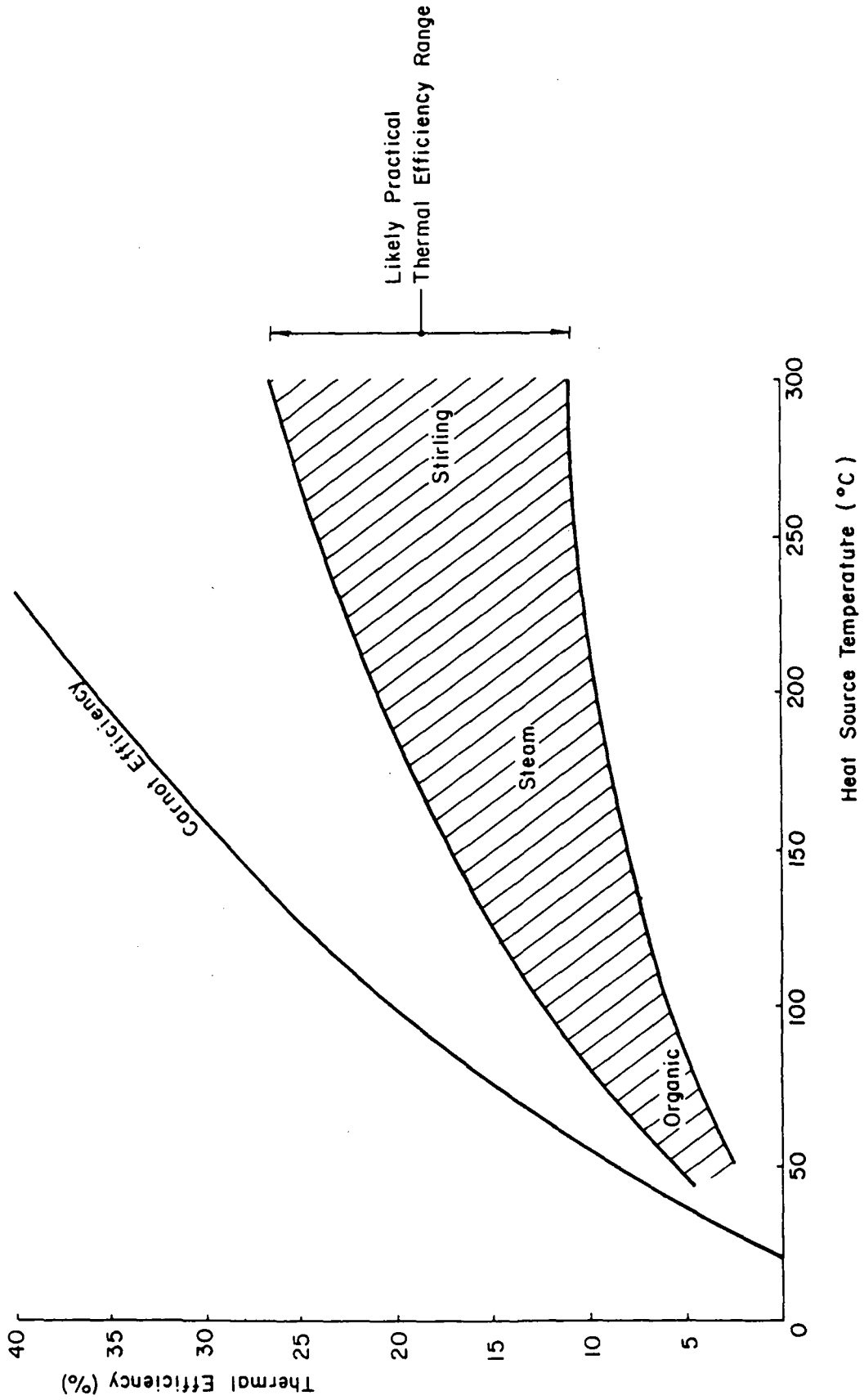

FIGURE 41 – COMPARISON OF THEORETICAL CARNOT EFFICIENCY WITH EFFICIENCIES OBTAINED IN PRACTICE ( $T_C = 25^\circ\text{C}$ )

systems under free-market conditions. Nevertheless there are a number of prototype devices that could possibly offer prospects for development into a viable pumping system.

## 5.2 Existing Solar Thermal Pumping Installations

A number of manufacturers have small-scale solar thermal pumping systems under development and several have prototype field installations under test. The French company, Sofretes, is the only manufacturer however with a significant number of actual field units installed. The units are rated at about 1kW (mechanical power to pump) and employ flat plate solar collectors and a reciprocating organic fluid Rankine cycle engine operating at about 80°C. Overall efficiency is about 1%, (solar energy to shaft power). These systems are elaborate and well-engineered, but it is known that for various reasons many have failed to operate satisfactorily in the field. The capital cost of these systems also appeared to be too high for economic operation and it is understood that the majority was financed as French overseas aid. Pumping systems of this size and type are no longer being manufactured by Sofretes, as the company has decided to concentrate its solar thermal resources on considerably larger systems, of 5 to 100kW rating, and to use photovoltaics for small-scale systems. Some of these larger Sofretes installations are listed in Table 9.

## 5.3 Thermal Efficiency of Heat Engines

The theoretical maximum efficiency for conversion of heat energy to mechanical work was first defined by Carnot as

$$\eta_c = \frac{T_h - T_c}{T_h}$$

where  $T_h$  is the absolute temperature of the heat source and  $T_c$  is that for the heat sink. In practice, even with good design, it is not possible to obtain an efficiency anything like as good as the theoretical Carnot efficiency  $\eta_c$  and in most cases the true thermal efficiency for converting heat to work will be in the range 0.3 to 0.6 of  $\eta_c$ . Figure 41 illustrates this relationship for the temperature range of relevance for solar thermal systems.

To date there are three main types of thermal systems which have shown potential for small-scale solar pumping applications. These are:

- (a) low temperature organic vapour cycle devices (50° - 150°C);
- (b) medium temperature water vapour (steam) cycle devices (140°C - 300°C); and
- (c) gas cycle devices (Stirling cycle), using air, hydrogen or helium as working fluid, requiring input temperatures generally in excess of 300°C.

It should be noted that the vapour or Rankine cycle which applies to organic vapour and steam engines is inherently less efficient (i.e. a smaller percentage of Carnot efficiency) than the Stirling gas cycle which the Stirling engine approximately follows.

In each of these types, the basic principle of establishing a flow of heat and extracting a proportion of this as work will apply, as illustrated schematically in Figure 42. Normally the heat sink will be the water that is pumped from the ground (although in some cases it may be the atmosphere) and the sink temperature is unlikely to be less than about 25°C in the countries of main relevance to solar pumping. The greater the temperature difference between the heat source and the heat sink, the greater will be the thermal efficiency of the heat engine with less solar energy required for a given work output. It would thus appear that a solar thermal system should have as high an input temperature to the expander as possible in order to maximise the temperature difference between source and sink.

Unfortunately, the efficiency of solar collectors decreases as the temperature between their output and ambient increases, because collector heat losses increase in proportion to this temperature difference. Therefore the optimum requirements for heat engine efficiency are opposite to those for solar collector efficiency.

As a result of the conflicting requirements of heat engines and solar collectors, various technical trade-offs are required which result in a number of combinations of different types of solar collectors and engines. There is no obvious, clear cut winning approach and this is the main reason why there is such a variety of different solar thermal systems under development.

#### 5.4 Solar Thermal Collectors

Typical curves showing the variation of collector efficiency with temperature difference for various types of solar thermal collector are given in Figure 43. From these curves, it can be seen that simple single-glazed flat plate collectors become particularly inefficient if expected to produce heat at temperature differences greater than about 75°C. By adding sophistication to a flat plate collector in the form of double glazing and special selective surface finishes that reduce the emission of heat from the absorber surface, acceptable efficiency with temperature differences in the range 80 to 100°C becomes possible. However, to obtain temperature differences in excess of 100°C while retaining acceptable efficiency demands the use of a concentrating solar collector.

A concentrating solar collector must be aligned with sufficient accuracy to ensure that the focus coincides with the heat absorber. The greater the degree of concentration, the more accurately must the concentrator be aligned and of course any such device has to follow the sun during the course of the day to keep the focus coincident with the absorber. This introduces the complication of mounting the concentrating collector in such a way that it may be tracked and an accurate tracking mechanism is also needed. Several methods have been demonstrated for tracking, including electronically controlled electric servo drives (where photo-cells are used to sense the alignment with the sun); clockwork drives timed to follow the sun correctly; and a number of promising devices in which misalignment is detected by a sensor cylinder containing a liquid/vapour combination which is normally just shaded by the concentrator mirror. If the sun illuminates the sensor cylinder, the heat boils the liquid and pressurises the vapour which drives a servo mechanism to move the mirror sufficiently to bring the sensing cylinder back into a shaded position. Some of these tracking methods may also be applied to concentrating and even to flat plate photovoltaic arrays, as discussed in Chapter 4.

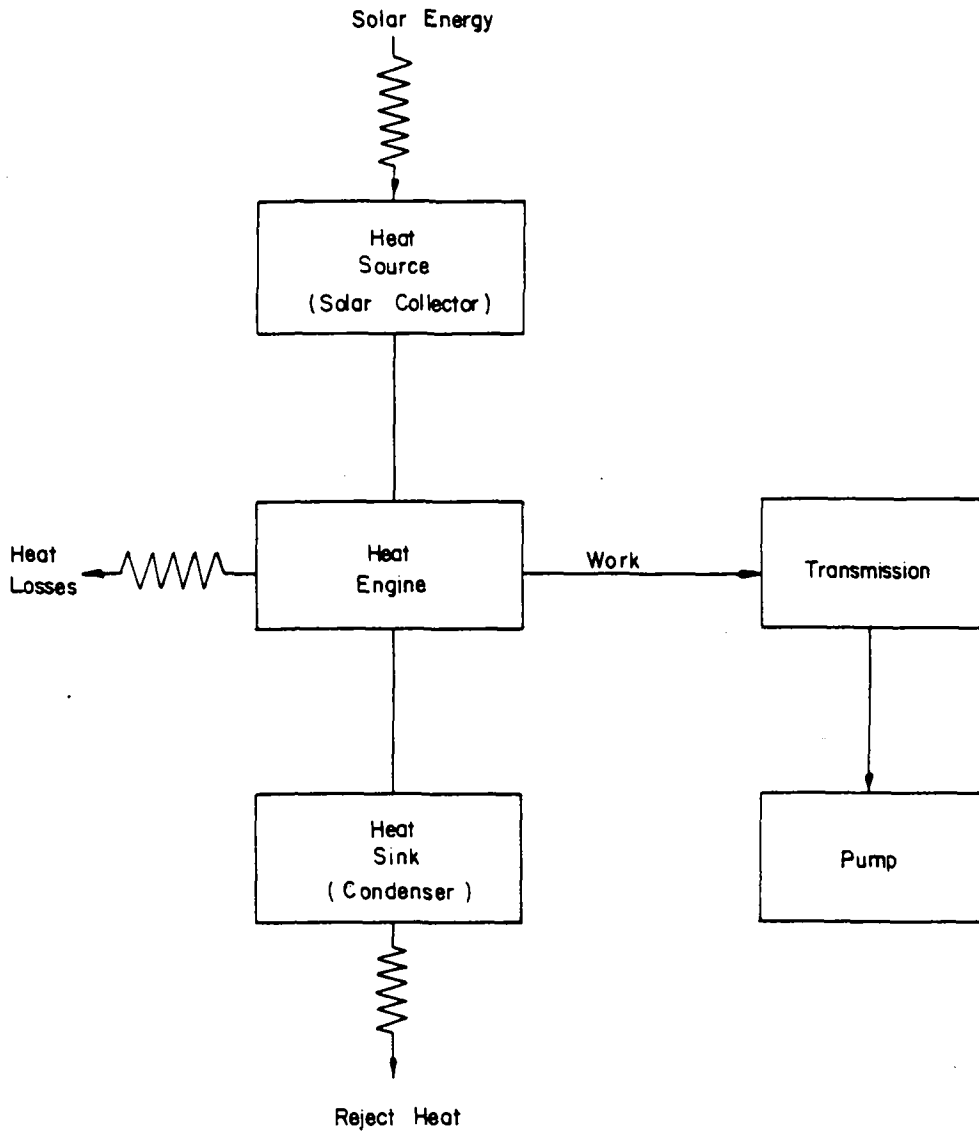

FIGURE 42 - SCHEMATIC ARRANGEMENT OF A THERMAL SYSTEM

Figure 43 shows a comparison of measured performance results from Reference 31, and illustrates that various line focus collectors can achieve efficiencies of around 70% at temperatures of up to 300°C. By comparison, a double glazed selective surface flat plate collector is rather inefficient.

Major technical problems with tracking concentrators lie in obtaining a sufficiently reliable tracking mechanism, in mounting the reflector array in such a way that it tracks easily but is not influenced by strong winds, and in providing a mirror surface which will withstand such effects as rain, dust, bird excrement, ultra-violet radiation, thermal shock and rough handling. It is however important to note that tracking concentrators do have one major advantage over fixed flat plate units in addition to obtaining a higher temperature in that they can receive considerably more solar energy during the course of the day, particularly in early morning and in the evening, as they turn to face the sun (as explained in section 2.7, see Figures 4A and B, 5A and B). The fixed flat plate collector surface will receive attenuated solar energy early and late in the day due to the acute angle of the sun's rays. Theoretically, a tracking collector will receive  $\pi/2$  times the solar radiation per unit area per day than a fixed one. In practice, an even greater gain in output, sometimes exceeding a factor of two, has been observed. This may be accounted for by considering that, in addition to the geometric effects, fixed flat plate collectors have greater reflection losses when receiving solar radiation at an acute angle.

A tracking collector may thus be expected to receive significantly more energy per day per unit area of collector and be able to start up much earlier and keep going much later in the day. If the difficulties of constructing a reliable and robust tracking concentrator can be overcome, there are substantial technical and economic benefits to be gained. Consideration may also be given to mounting flat plate non-concentrating collectors on gimbals to permit approximate manual tracking; by turning the collector eastwards in the morning and westwards in the afternoon significant gains may be expected, (See Figures 5A and B).

Most concentrating solar thermal collectors available today are of the parabolic trough type, achieving temperatures of between 100 and 300°C. Higher temperatures are possible by either using parabolic dish mirror collectors, which have a point focus rather than the line focus of the trough, or by using a field of tracking mirrors individually aimed at a central "power tower" target. Although quite high engine efficiencies could be achieved from systems of this kind, the tracking requirements are more precise which makes these approaches appear difficult for small thermal systems required for this Project.

However one potentially useful application of concentrating collectors is the use of a parabolic dish collector with a Stirling engine system. At least one manufacturer (Sunpower Inc., USA) is developing a system of this kind and it is possible that the gains offered by the use of a Stirling cycle heat engine will compensate for the more rigorous tracking requirements.

For many applications, such as industrial process heat and power generation, concentrating collectors have been shown to be more cost-effective than flat plate collectors. Parabolic trough collectors have been used for relatively large scale water pumping systems in the USA although only one system at Coolidge, Arizona, has performed satisfactorily and is still in operation.

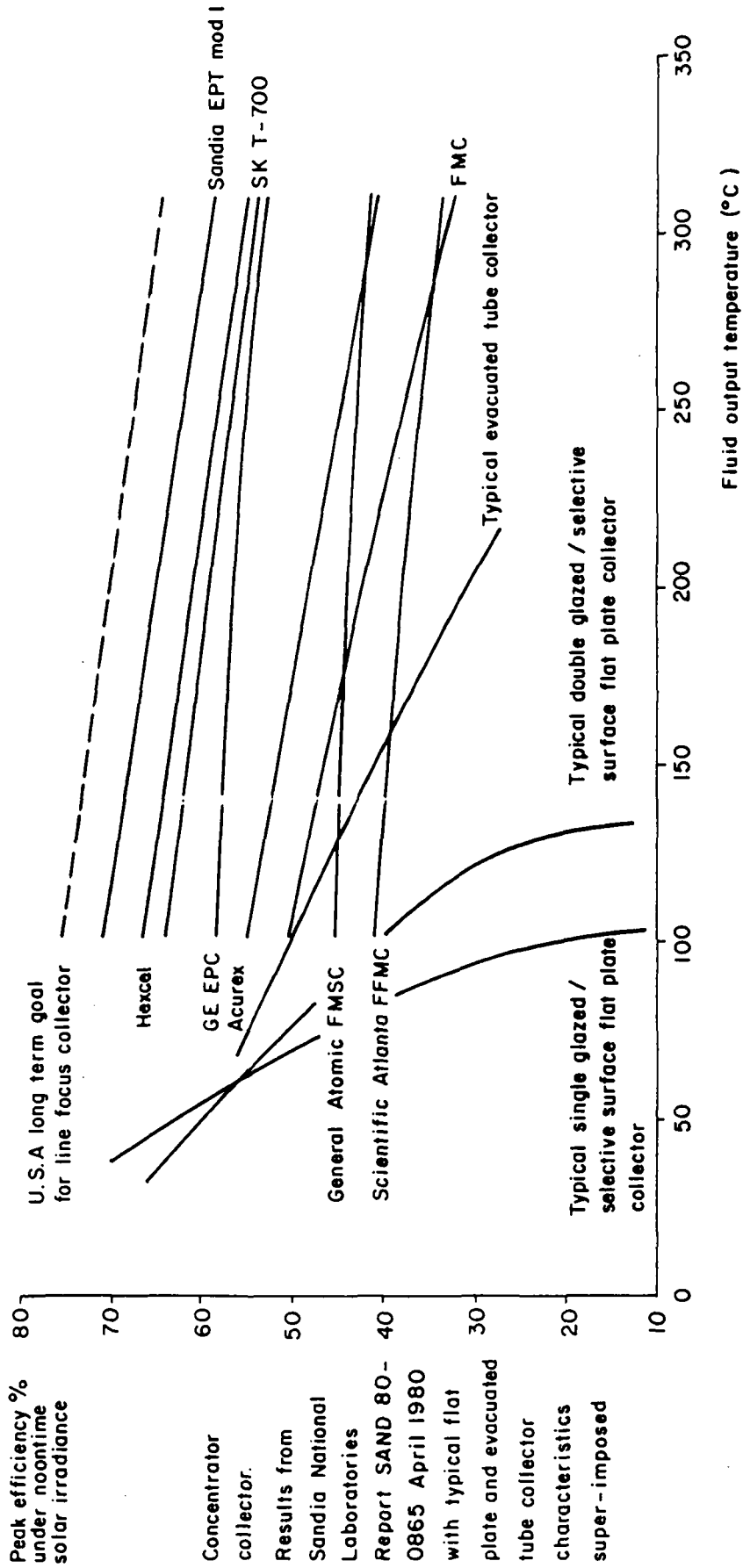

FIGURE 43 - COMPARISON OF SOLAR COLLECTOR PERFORMANCES



Some manufacturers and systems analysts consider that the use of evacuated collectors may prove to be the most cost-effective solution for systems requiring moderately high temperature. They have been shown to have good collection efficiency, derived from their low heat losses, and several manufacturers in various parts of the world have started limited production. No estimates are as yet available of their probable manufacturing costs for large-scale production and for the present they must be regarded as promising but unproven.

In contrast, solar ponds have been proposed as a simple, cheap method of collecting and storing solar energy, potentially on a large scale. Such a pond is a shallow body of water, typically 1 to 2m deep, with a black bottom. When incident solar radiation penetrates the pond, some is absorbed by the liquid and a large proportion reaches the bottom and is absorbed by the black surface which is consequently heated. Thus water at the bottom of the pond reaches a higher temperature than that nearer the surface. Convection currents which would normally develop and equalise this temperature difference are prevented by the presence of a strong density gradient from bottom to top through the use of dissolved salts (or by plastic membranes). Many natural salt water ponds are known which exhibit these properties, and scientific research into their use began in the 1950's in Israel.

The principal aim of research into solar ponds has been concerned with methods of extracting energy from the pond. Success has been achieved by recycling the hot layers through a heat exchanger and temperatures of 90°C have been achieved. Currently a power generation system using an Ormat turbine is operating in Israel. In India solar ponds have been used for the production of salt and for biogas digester heating.

The solar pond could be a useful collector for solar pumping systems but must be designed for a specific location and is as yet inadequately developed. Work is currently in progress in the USA, funded by the Department of Energy (DOE) to establish the feasibility of shallow solar pond-driven irrigation pumping systems (Reference 32). Present indications are that for a large (120kW) system, the shallow solar pond option is less expensive than other DOE funded installations which use concentrating collectors.

## 5.5 Rankine Cycle Engines

Nearly all solar thermal engines available or under development today are based on the Rankine or similar cycle, in which the working fluid undergoes a phase change from liquid to vapour in a boiler, followed by expansion of the vapour through an expander mechanism to extract work, after which the vapour is condensed back to liquid and transferred by a feed pump back to the boiler to be reheated for another cycle.

A typical Rankine cycle system in its simplest form is shown diagrammatically in Figure 44. The working fluid is directly evaporated in the solar collector before passing to the expander which drives the working fluid feed pump as well as the main water pump. The water is used to cool the condenser. The systems being developed for example, by Dornier (West Germany) and Solar Pump Corporation (USA) utilise this cycle, with Freon as the working fluid.

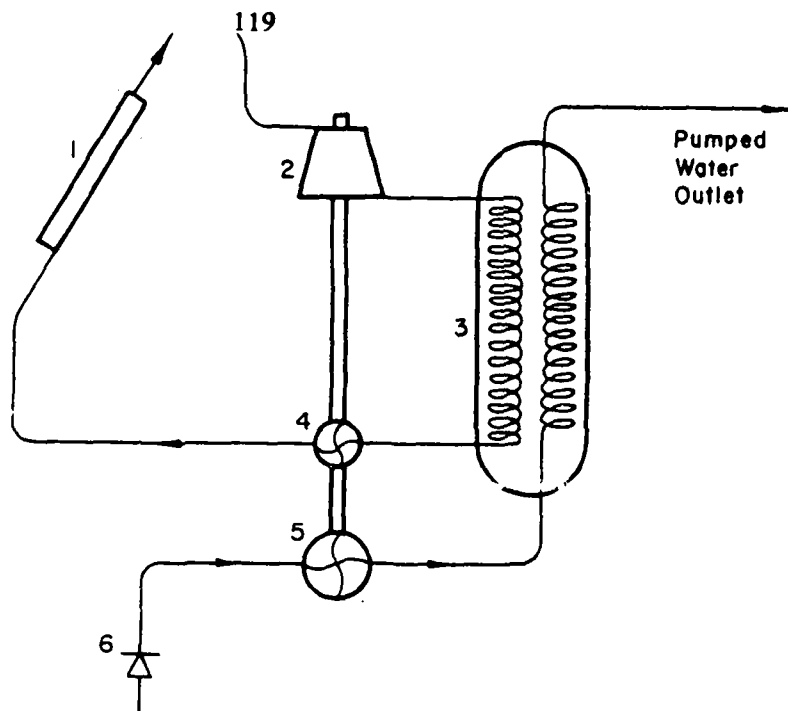
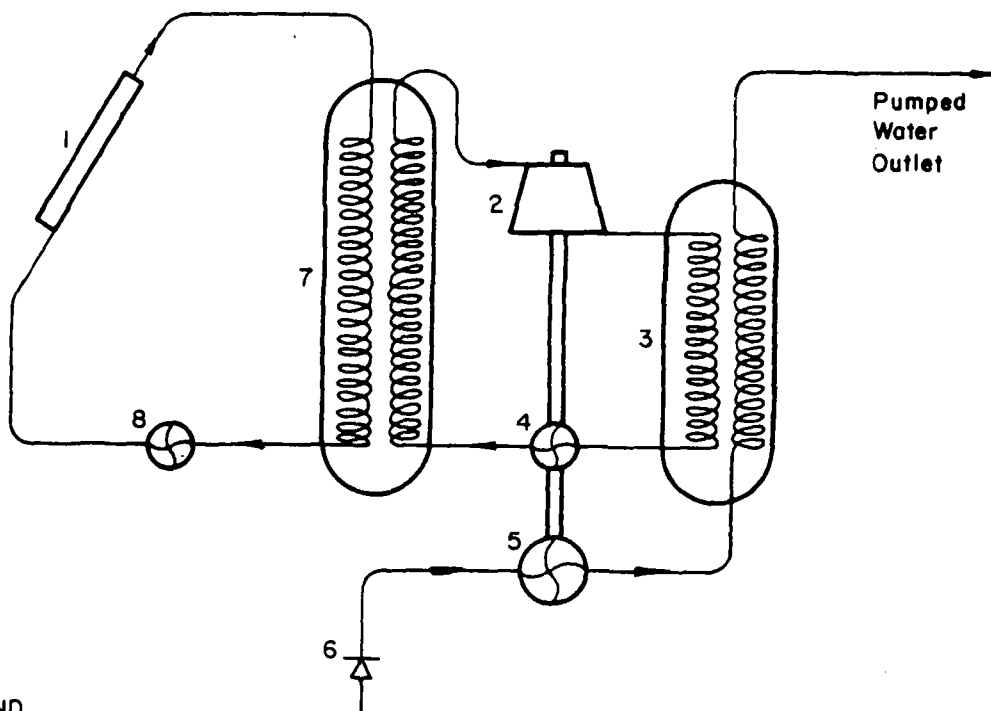

FIGURE 44 – SIMPLE RANKINE CYCLE



**LEGEND**

- |                      |                           |
|----------------------|---------------------------|
| 1. Solar Collector   | 5. Water Pump             |
| 2. Expander (Engine) | 6. Water Foot Valve       |
| 3. Condenser         | 7. Exchanger / Evaporator |
| 4. Feed Pump         | 8. Circulating Pump       |

FIGURE 45 – RANKINE CYCLE WITH INTERMEDIATE HEAR EXCHANGER

The system shown in Figure 45 is similar except that water is used in the solar collectors, with an intermediate heat exchanger transferring heat to the working fluid. This arrangement has been adopted, for example, for the systems developed by Sofretes (France) and Ormat (Israel).

Systems operating at temperatures below about 150°C generally use an organic working fluid, as the use of water presents technical problems. Fluoro-carbons of the Freon type, as commonly used in refrigeration and air-conditioning equipment, have the advantage of lower boiling points at useful pressures and higher vapour densities than steam, thereby permitting more compact systems with higher efficiency.

A few systems have been developed or proposed which use organic hydro-carbon vapours as a working fluid (butane being a commonly applied one). The main objection to the use of this kind of working fluid arises from their high flammability which could prove a serious hazard in the event of a leak developing. Even more hazardous than butane are working fluids such as n-pentane (proposed for one system), which has both a very low flash point and high volatility. The Freons (and other fluoro-carbons) on the other hand are non-flammable and reasonably safe with regard to toxicity.

When any organic working fluid is used, it becomes essential to contain the fluid in the system with 100% reliability since even the smallest of leaks will eventually cause the vapour cycle to cease functioning. Also, these fluids are relatively expensive, so it is worth minimising the quantity required to fill the system.

Some systems have been proposed which incorporate a heat store in the solar collector circuit, introduced between the solar collector and the intermediate heat exchanger. The simplest form of heat store consists of a large water or brine vessel, but some systems involve the transfer of latent rather than sensible heat through the melting and solidifying of waxes or salt mixtures or the evaporation and condensation of a separate vapour. In this way a large quantity of heat can be stored and cycled through quite a small temperature range. It seems that this technology may in some cases be an important adjunct to the use of small solar thermal systems to provide a thermal buffer between the rather variable temperature of the output from the solar collectors and the fixed temperature conditions which are desirable for running a vapour expander. Naturally a heat store involves further complication and expense, and therefore requires thorough evaluation before being incorporated into a small-scale pumping system intended to meet the special requirements of this Project.

An interesting variation of the Rankine cycle system is under development in India by Hindustan Brown Boveri in association with the Indian Institute of Technology, Kanpur, who claim that because of its mechanical simplicity, it is likely to be much less expensive than conventional solar thermal systems. The most basic arrangement they propose is illustrated in Figure 46. A volatile organic fluid is used which is immiscible with water. The fluid is heated to a temperature in the flat plate collectors 1 such that it will flash into vapour in the flash tank 2. When sufficient pressure has developed in the primary system, valve 3 opens and the vapour expands into chamber 4 and displaces water from the chamber via a non-return valve and rising main 5 to tank 6. Some of the water from tank 6 is circulated through heat exchange pipes in expansion chamber 4 and causes the

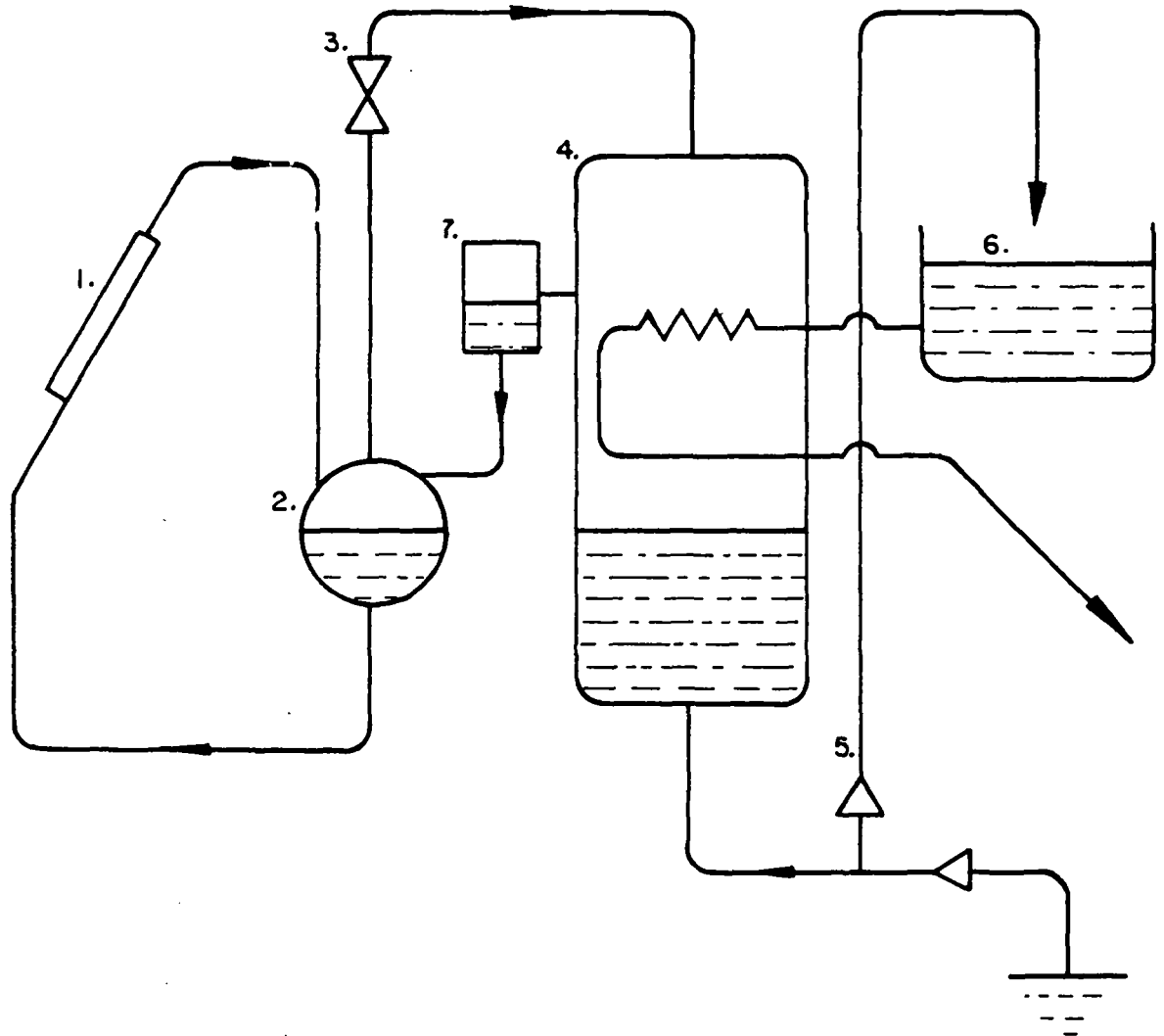

#### LEGEND

- 1. Flat Plate Collector
- 2. Flash Tank
- 3. Valve
- 4. Expansion Chamber

- 5. Rising Main With  
Non Return Valve
- 6. Water Collection Tank
- 7. Condensate Return Tank

FIGURE 46 – HUNDUSTAN - BROWN BOVERI MARK 1 LIQUID PISTON RANKINE CYCLE SYSTEM

vapour to condense and collect on the surface of the water (it is less dense than water and immiscible with water in liquid form). This process draws another supply of water from the well via a non-return valve. The condensed organic fluid is recovered when the water level rises high enough in 4, via a condensate return tank at 7, and returns under gravity to the primary circuit. In practice it appears that rather more complication than this is involved in achieving the full cycle, since the prototype includes a number of further tanks and connections. Although the plumbing appears quite complex, this device is attractive in that it has no mechanical expander and pump, the vapour interacting directly with the water to be pumped, so it should be potentially reliable and long lasting providing the organic working fluid can be adequately contained. This is important since the prototype appears to use n-pentane as a working fluid and this is a dangerously flammable vapour.

The Hindustan Brown Boveri system is still at the prototype state, but was said to be close to being marketed by the manufacturer in 1979. It is not believed to have been launched as a commercially available product at the time of writing.

Another type of low temperature simple device involves the evaporation or boiling of an organic low boiling point fluid, which displaces more liquid fluid to a higher level. The weight of the collected fluid is then used to do work while it is returned to a lower level. Systems of this kind are inherently large in relation to their power rating, but could in theory be reasonably efficient. Two manufacturers are understood to be developing devices of this kind, Sunpower Systems (USA), who offer the "Minto Wheel" and Grinakars (Pty) Ltd., (Johannesburg), who have a rocking device called the "Camel". The latter device appears promising on the basis of the cost and performance figures quoted by the original inventor but unfortunately little or no information has been released by the licensees.

The principle of the so-called "Camel" is believed to be as illustrated in Figure 47. The working fluid, Freon, is evaporated in the flat plate collector (1). The vapour displaces liquid Freon from a reservoir (2), which in turn travels up a flexible pipe to the reservoir (3), where it condenses. When sufficient condensate has collected it over-balances the arm (4), thereby delivering some water as the arm is connected to a piston pump. A valve, (5), then opens automatically and returns the condensate by gravity to a lower reservoir (6), and thence back to the solar collector (1). The consultants have certain reservations about the inventor's original performance claims for this device, but its simplicity, apparent robustness and low cost make it appear potentially attractive for use by farmers in developing countries. The licensee was unable or unprepared to supply us with a system to test to verify the performance that had been claimed.

Unlike photovoltaic systems, where there are not many options for using an electrical output to pump water, there are a great variety of options for using hot vapour or hot gas to drive an engine and pump. In fact many photovoltaic system designers use "off-the-shelf" commercially available motors and pumps, but a thermal system designer generally has to design and develop at least the engine and often the pump and transmission too, which probably accounts for the less advanced level of development of small-scale solar thermal pumping systems, compared with solar PV systems.

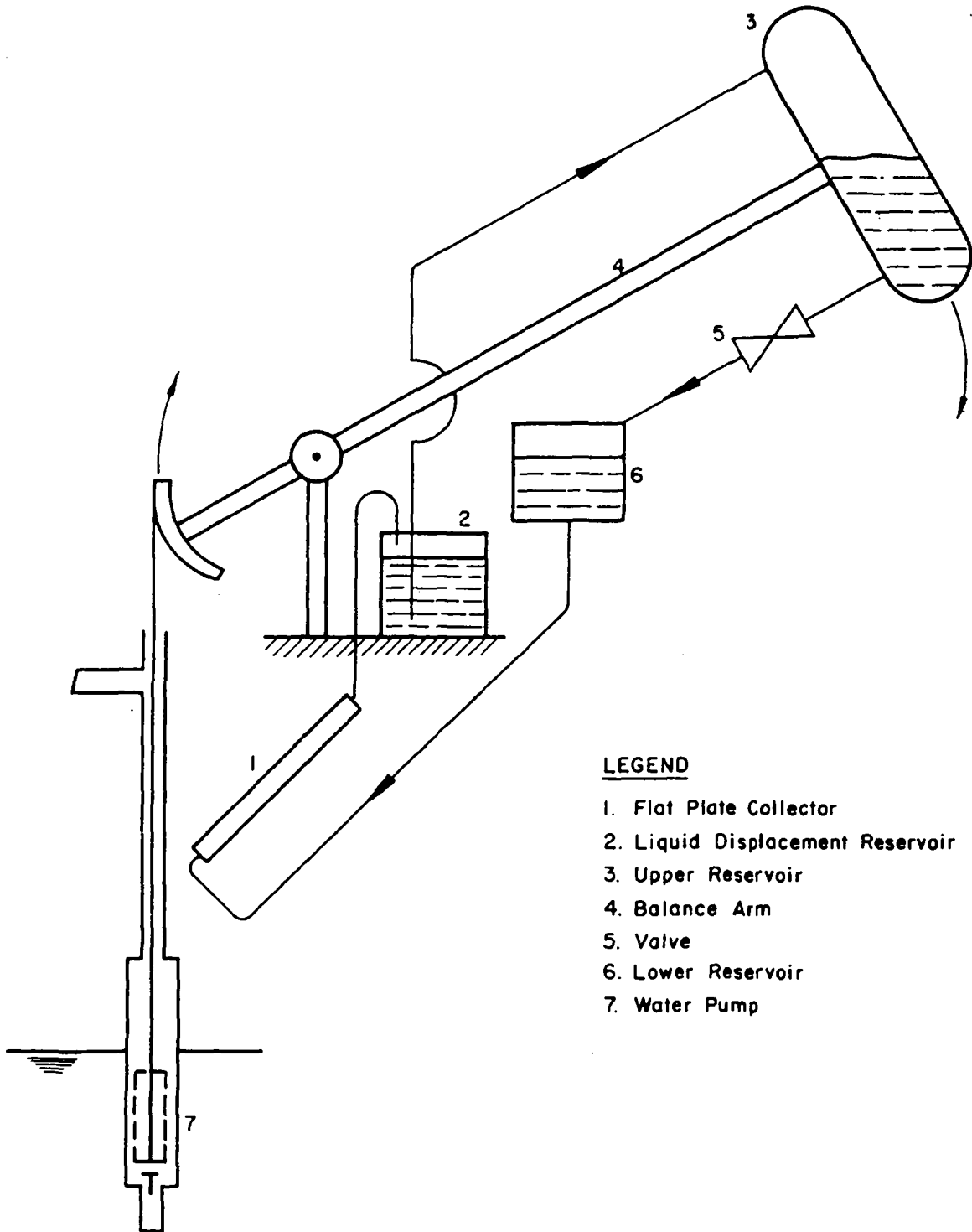

FIGURE 47 – “CAMEL” GRAVITY OPERATED SYSTEM

All Rankine or vapour cycle systems require an expander and there are in effect three broad categories of device which can be used; small turbines, rotary positive displacement expanders and reciprocating positive displacement expanders. In addition to such desirable characteristics as long life and high reliability with minimal maintenance needs, an important expander characteristic is its expansion efficiency (isentropic efficiency) which provides a measure of its effectiveness at converting heat into work. Unfortunately small turbines tend to be inherently inefficient as extremely high standards of surface finish, coupled with very small clearances and high rotational speeds, are necessary if a good isentropic efficiency is to be achieved. Therefore, positive displacement expanders are more common in the size range of interest for this Project.

Rotary positive displacement expanders include vane machines, screw expanders and analogous arrangements to most common types of compressor or blower (e.g. Roots, Centric, Swashplate-axial-piston). Reciprocating devices appear at present to be the cheapest and most reliable option at this scale. They can take the form of the traditional steam engine with a piston in a cylinder, such as the steam system being developed by Jyoti Limited (India), or they can incorporate diaphragms or roll-sock seals (generally preferred for organic vapour working fluids where 100% vapour retention is vital), or they can be liquid displacement devices such as those shown in Figures 46 and 47.

## 5.6 Stirling Cycle Engines

Stirling (or Eriksson) cycle engines use a gas such as air, hydrogen or helium as a working fluid and are generally capable of higher thermodynamic efficiencies than Rankine cycle engines at a given upper operating temperature. Their heat exchange interfaces also can be smaller and therefore cheaper, but in practice Stirling engines require heat inputs at temperatures in excess of about 300°C, so that a solar powered Stirling engine would almost certainly require a high concentration factor point focussing solar collector or power tower which in turn needs accurate solar tracking.

The Stirling engine was patented in 1816 by the Rev. Robert Stirling. John Eriksson patented an open cycle variant during the 1850's. The Eriksson engine became very widely used for fractional horsepower applications (in preference to small steam engines) during the latter part of the nineteenth century, particularly in the USA, and was usually fuelled with wood or coal. An example using a parabolic mirror to focus the sun's rays through a window in its absorber was reportedly demonstrated in 1872 and may have been the first solar powered engine ever. Widespread electrification rendered the small Eriksson engines obsolete during the early decades of this century, when fractional horsepower electric motors took over.

In recent years considerable effort has been made to develop high technology Stirling engines capable of competing with diesel engines for automotive applications (advantages of better efficiency coupled with less noise and less exhaust pollution have been claimed). Another development has been the evolution of the free-piston Stirling engine by Beale and others, (References 33 and 34).

At least two manufacturers are developing devices based on the Stirling cycle which offer promise for small-scale solar pumping applications. Sunpower Inc. (USA) are developing the "Beale engine" and Metal Box (India) Limited in Calcutta are developing the "Fluidyne" pump originally invented by the UK Atomic Energy

Authority at Harwell. Both devices are said by their developers to be close to commercial production; the Beale engine was in fact laboratory tested under this project as explained below but the respective development schedules of Metal Box (India) and the laboratory programme of this Project made it impossible for us to test a "Fluidyne" pump, although a reproduction basin was seen working at the manufacturer's premises in Calcutta, India.

The "Fluidyne" pump in particular is worth describing in more detail. As illustrated schematically in Figure 48, water is caused to oscillate in a U-shaped displacer tube, one end of which is heated and the other cooled. The movement of the water causes air trapped above the U-tube to be displaced through a closed air pipe joining the two sides; the air pipe acts as a regenerator and stores heat from air as it is pushed from the hot side to the cooled side and gives up its heat to the cool returning air. The alternate heating and cooling of a fixed mass of air causes pressure and volume variations which not only excite the displacer water motion in the correct phasing, but are also used to pump water as the pressure alternatively draws water from the inlet valve and expels water through the delivery valve. The original "Fluidyne" pump as reported by Harwell was very inefficient, but we are informed by the Metal Box Company that they have made a significant breakthrough and that an overall efficiency of around 3% has been obtained (with electrical heat input under test conditions the overall efficiency was about 7%). The present pump is designed to be heated by coal wood orges; clearly if reasonable efficiency can be obtained with a direct solar input, the extreme simplicity and lack of moving mechanical components would make this device very attractive for use under agricultural field conditions.

Experimental work involving the use of the traditional mechanically-coupled Stirling engine has been reported by Puri (Reference 35). Also, it is understood that Philips NV, in the Netherlands, have been involved in the development of a small Stirling engine to power an electrical generator for running an irrigation pump, (References 9 and 20), although it is believed this programme is no longer active.

Another interesting type of Stirling cycle device for small-scale solar pumping is the free-piston Stirling engine, or Beale engine, under development by Sunpower Inc. (USA). This device was tested under the Project, and is illustrated in Figure 49. The thermodynamic working fluid is helium gas pressurised to about 5 bar; low atomic weight gases like helium have particularly good thermal conductivity, especially when pressurised. The Figure illustrates the version tested which had an electrical heater; when solar-powered, the hot end of the engine would be mounted at the focus of a point focusing parabolic collector, (or it could be installed in a power tower).

The principle of the free-piston Stirling engine is complex and depends on interactions between vibrating components constrained by springs. The stainless steel displacement piston and the brass working piston are interconnected by springs and by the viscosity of the working fluid in such a way that they vibrate (with critical damping) 90° out of phase with each other. This shifts the working fluid (helium gas) from the hot space above the displacement piston, through the annular wire matrix regenerator, (which takes heat out of the gas), to the cool space between the displacement and working pistons. The gas cools and reduces in pressure as a result, which draws up the working piston and the connected pump diaphragm.



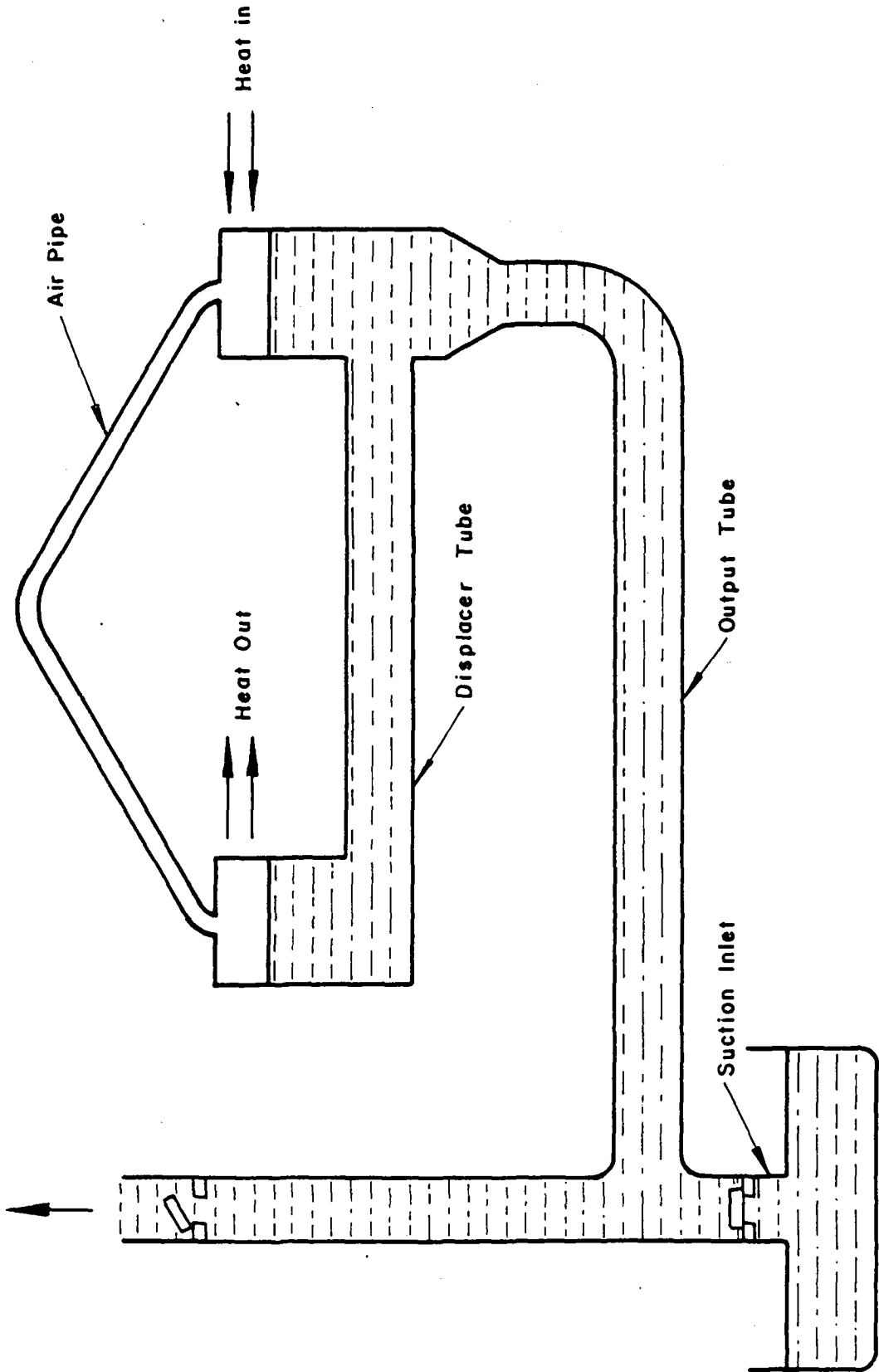

FIGURE 48 — PRINCIPLE OF FLUIDYNE PUMP

The displacer then moves back downwards through its natural vibrations and the working piston moves up and the working fluid is displaced back through the regenerator, where it picks up stored heat, to the hot space. The working fluid then reaches the peak pressure of the cycle and drives the working piston and the pump diaphragm downwards and the cycle repeats itself.

## 5.7 Transmissions and Pumps

All mechanical expanders (engines) will provide either a rotating shaft output or a reciprocating shaft output. The former can be coupled to a rotary pump in much the same way as described for photovoltaic pumping systems using a mechanical transmission; hydraulic drive or direct drive being used where a suitable rotary pump to match the output speed is available. It is also possible to drive an electrical generator and transmit the output electrically to a suitable electric pump unit, in which case the comments on the relative efficiency of different electrical machines as given in section 4.5. will also apply. Most of the comments in section 4.7 on pumps also apply with equal validity here too. Reciprocating output expanders offer a convenient possibility of coupling directly to the pump, provided the frequency matches that required for efficient pump operation, but for the reasons given in section 4.7 such systems are more likely to be appropriate for medium or high rather than low lift pumping.

## 5.8 Testing of Thermal Systems

Perhaps because thermal systems are more complicated to design and assemble than PV systems (with most, if not all, components requiring to be purpose-designed) only one solar thermal small-scale pumping system was available for purchase on a commercial basis and delivery within the timescale of the first Phase of the Project (compared with 10 different PV Systems).

This sole thermal system, by Solar Pump Corporation of Las Vegas, Nevada, USA, is illustrated schematically in Figure 50.

It consists of a simple, single-glazed flat-plate collector, (2), fixed to a support frame (1). The design working fluid is R11 (Freon 11) which is boiled in the collector absorber (3), the hot liquid Freon flashes into vapour through a control valve (6), to the expander (7). The expander is located in the centre of the collector, which is a good design feature to keep it warm; it consists of a reciprocating diaphragm with linked valves and looks rather akin to the vacuum servo units used to boost automobile or truck brakes. The expander directly works a lever arm (8), which carries the pump rod connected to the well pump cylinder assembly (12). The same lever arm (8) works a small feed pump which returns condensed Freon from the condenser (9), built into the support frame, to the solar collector. The condenser is cooled by water lifted from the well, which is delivered directly from the condenser water outlet, (13). The whole unit is compact and well integrated, being 2.7m wide by 2.0m from front to back and 1.8m high.

The Solar Pump Corporation system was installed near Khartoum in the Sudan for testing, but due to delays and problems in commissioning this system, (as more fully explained in the Project Report), it was not possible to conduct more than superficial testing during the first Phase. However, it demonstrated a

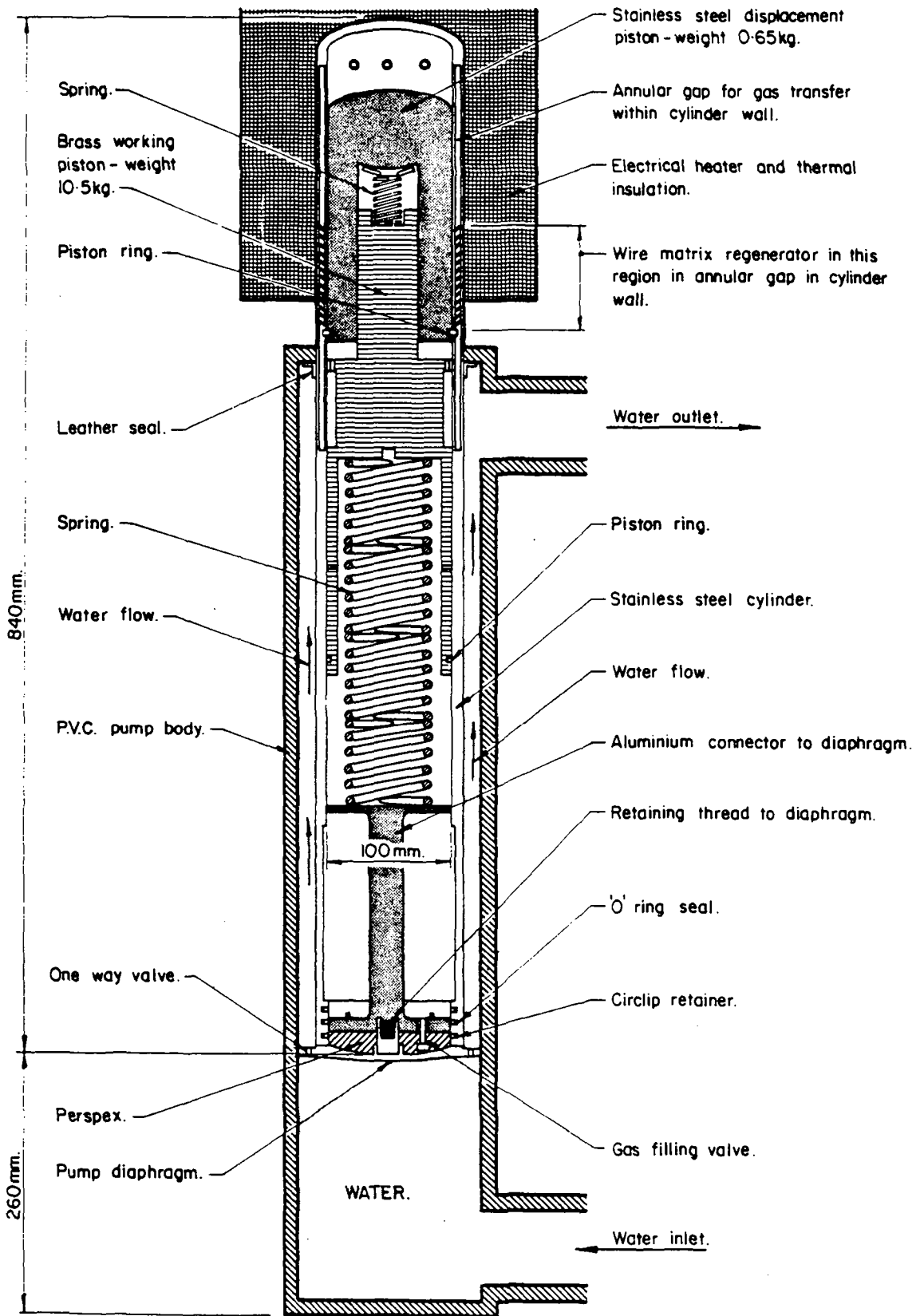

FIGURE 49 - GENERAL ARRANGEMENT OF SUNPOWER INC. STIRLING ENGINE

KEY

- 1 Support frame
  - 2 Collector frame outside
  - 3 Freon boiler
  - 4 Freon liquid distributor header
  - 5 Freon vapour header
  - 6 Vapour pressure control valve
  - 7 Freon engine and valve
  - 8 Lever arm
  - 9 Condenser
  - 10 Freon liquid pump
  - 11 Pump operating lever arm
  - 12 Well pump cylinder assembly
  - 13 Water discharge
  - 14 Arrows indicating water flow
- Height : 1.8 metres  
 Width : 2.7 metres  
 Length : 2.0 metres

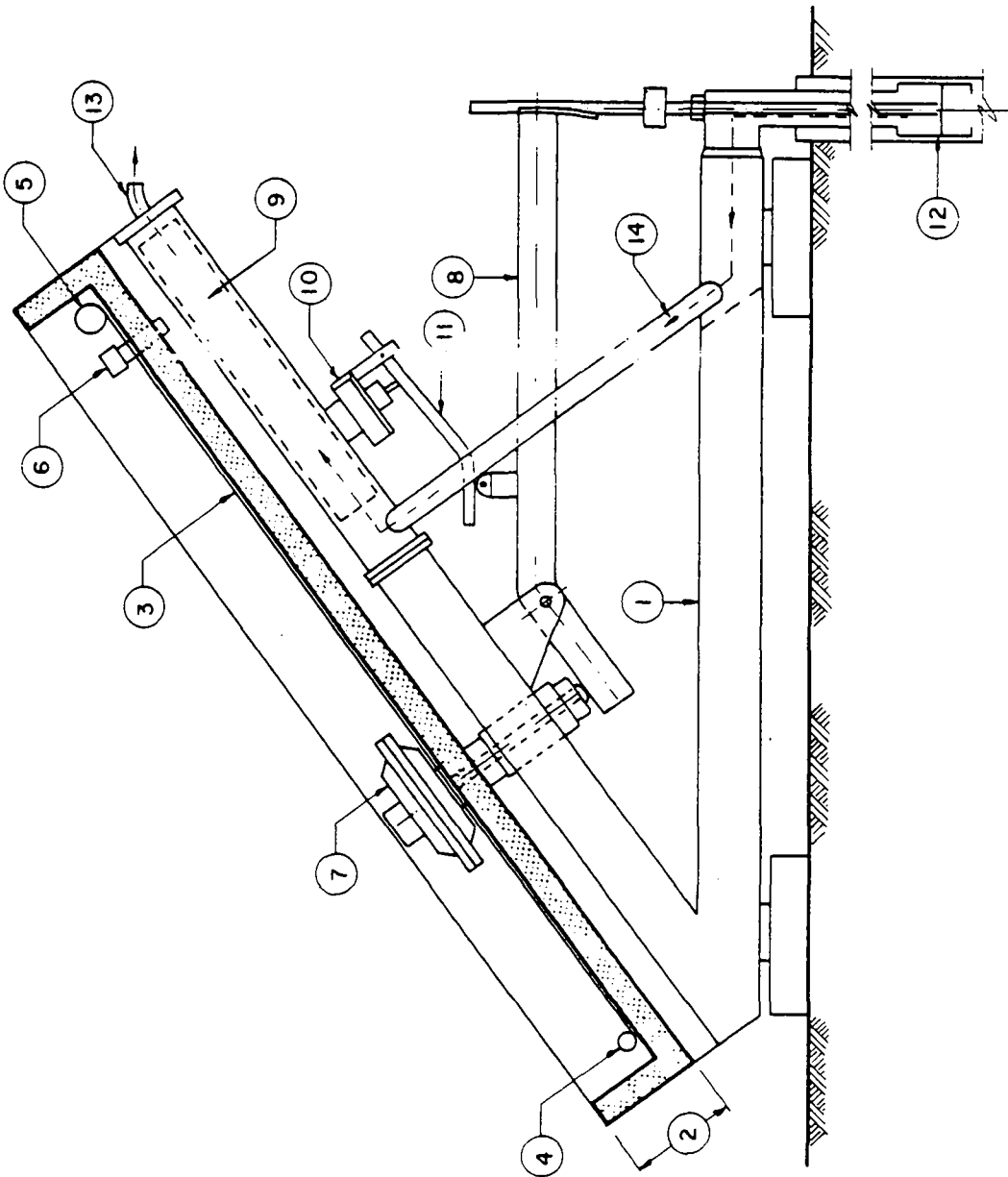

FIGURE 50 - SCHEMATIC OF SOLAR PUMP CORPORATION SOLAR PUMP

hydraulic pumped power output of 45W and an overall system efficiency of 0.9%. The price of the unit was competitive with many of the PV systems tested and the Consultants believe that the output and efficiency quoted above are not necessarily optimum and that there is some scope for design improvement. The system was also given brief tests at the manufacturer's works.

The Project also gained first-hand experience with solar thermal systems by arranging for tests to be carried out on prototype systems at their manufacturers' works at Ormat Turbines Ltd. (Israel) and Dornier System GmbH (W Germany). In addition, a small Stirling engine pumping system by Sunpower Inc., (USA) was tested for the Project at the University of Reading in the UK. This work is described in detail in the Project Report.

The Ormat system was just outside the scope of this Project, having a turbine using Freon as a working fluid, driving an electrical generator with a maximum rating of 4.7 kW. The engine and generator efficiency was 6%, implying a system efficiency of about 2.2% if a collector efficiency of 60% is assumed with a similar pump efficiency.

The Dornier system had a maximum hydraulic (pumped) power output of about 230W. The engine/pump efficiency was measured at 3.5%, implying a likely system efficiency of about 2.0%.

The Sunpower Stirling engine pump unit (See Figure 49) failed to perform to its manufacturer's specification and then suffered a component failure which damaged it and cut short its test programme. It is believed that it may have been damaged in transit, which would account for its worse than expected performance, even before the component failure. Under test at Reading University it only developed a hydraulic pumped output of 23.5W with an engine/pump efficiency of 1.8% (implying an overall system efficiency with a point-focusing concentrator of about 1.2%). The manufacturers claimed a hydraulic output of about 80W, which implies an engine/pump efficiency of about 8% or an overall efficiency of about 5% with a point focusing solar concentrator; this claim appears plausible for a device of this kind operating at temperatures of between 500 and 600°C.

However, this free-piston Stirling engine prototype is a piece of precision engineering which is vulnerable to damage due to the close fits and quite thin-walled components contained in it. Nevertheless, once fully developed, it may well be a compact and efficient small-scale solar thermal pumping system.

## 5.9 Thermal System Design Studies

### 5.9.1 Introduction and Scope

The Project thermal design studies inevitably were much more tentative in their approach and conclusions than were those for photovoltaic systems, because there has been very little experience with workable small-scale solar thermal systems, despite their long history. However, some interesting and perhaps significant conclusions have come out of the study which is described in the comparison Project Report, and these are outlined below.

Most of the earliest work on solar pumping was concerned with the use of heat engines; indeed some of the first achievements in the use of solar energy in the early part of this century were with thermodynamic pumps. In spite of this previous experience it became clear during the early part of this Project that small solar thermodynamic water pumps have not been developed to the stage where reliable systems can be obtained commercially.

It was not possible therefore to obtain much first hand experience with, or data from, working solar thermodynamic pumping systems. Data were obtained from only one complete system operating from solar power, that of the Solar Pump Corporation system, when tests were performed on the system at the manufacturer's premises. Accordingly it was agreed that the Consultants would undertake the necessary design studies in order to:

- (i) determine whether it is feasible that solar thermodynamic pumps could compete with photovoltaic systems
- (ii) identify directions in which technical developments can be made

taking particular account of what could be manufactured within developing countries rather than what could be achieved with advanced technologies. It was further agreed that a mathematical model should be constructed and used to achieve these objectives.

### 5.9.2 The Model

- (i) Approach

The operating characteristics of solar collectors and heat rejection systems are very sensitive to temperature, and will vary depending on the way the components interact. This means that successful operation of a solar thermodynamic pump is critically dependent on close matching of the components.

Comprehensive mathematical modelling of the performance of a solar thermodynamic pumping system was beyond the scope of this study. Indeed this could not be possible because insufficient data are available to validate such a model.

It was thought, however, that it would be feasible to use a simple model to compare the likely performance and costs which might be achieved from different combinations of solar collectors and engines.

The limited validity of this approach is clearly recognised; in particular the dynamic behaviour of thermal systems is of great importance but resources were not available to study this.

Modules for solar collectors, engines and heat rejection systems were developed and these have been used to compare a variety of possible pumping systems under the same steady-state conditions

ii) Principal Components

a) Solar Collectors

The types of solar collectors considered in the study are given in Table 10.

The thermal performance of solar collectors has been the subject of intense study and operating characteristics are now well understood and there are plenty of data available, so they can be modelled with precision. However, insufficient data were available for a solar pond to be reliably modelled as a component.

b) Engines

A number of different engines can be employed in solar-thermal systems. Only those which apply the Rankine and Stirling cycles are sufficiently well developed and understood to be considered seriously at present for use in small-scale solar water pumps. The engines considered were:

- o Rankine cycle using Refrigerant 11, (otherwise known as R11 or under its trade name of Freon 11).
- o Steam engine
- o Stirling engine

c) Costs

The component costs used are based on the current prices of solar collectors, as indicated in Table 10. Other costs are based on the Consultants' judgement of what they would be if manufactured in quantity in a developing country. An example of the costing for a flat plate collector based system similar to the Solar Pump Corporation system is given in Table 11.

The cost of a sun-tracking system has been taken as \$ 250\* for the high concentration point focus system. Engine costs are based on the swept volume and condenser cost on the amount of copper pipe required. The cost of the pump well head assembly and piping has been taken as \$ 600.

It should be stressed that the thermal system costs used are in the opinion of the Consultants the lowest that could reasonably be expected.

\* this assumes a simple, low cost mass produced and reliable tracking system is produced. No such product is generally available yet.

1. flat plate, single glazed (1)	Matt black non selective absorber, single glass aperture covers, conventional construction	110	Various published test results and mathematical modelling
2. flat plate, double glazed (1)	Matt black, non-selective absorber, two glass aperture covers, conventional construction	130	Various published test results and mathematical modelling
3. evacuated tube (1)	Selective surface absorber in evacuated tube with reflective backing	230	Results of independent tests on collectors manufactured by Sanyo (Japan) and Owens (USA). Manufacturers' data from Philips (Europe) and Ormat (Israel)
4. compound parabolic (2)	Deep parabolic trough reflectors which reflect direct and also diffuse radiation from the general direction of the sun onto the absorber. Single sheet aperture cover. Sun tracked	120	Calculated performance from mathematical modelling
5. East-west low concentration trough (2)	Low concentration cylindrical parabolic trough reflector with absorber tube in glass receiver. Does not require continuous tracking if axis aligned East-West but occasional repositioning required	120	Derived from mathematical modelling
6. North-South trough, unglazed absorber (3)	Glass parabolic trough reflector, unglazed non selective absorber tube, aligned N-S single axis sun tracking	110	Derived from mathematical modelling
7. North-South trough, glazed absorber (3)	As collector type 6 but with absorber tube in glass receiver cover.	120	Derived from mathematical modelling
8. North-South trough, Manufacturer A. (3)	Commercially available collector. Metallized acrylic reflector, steel absorber tube with black chrome reflective surface and glass receiver cover. Single axis sun tracking	140	Results of tests by Sandia National Laboratories, USA
9. North-South trough, Manufacturer B. (3)	Commercially available collector. A luminized reflector, black chrome selective surface on absorber tube, glass receiver cover. Single axis sun tracking	140	Results of tests by Sandia National Laboratories, USA
10. Linear Fresnel lens Concentrator (3)	Commercially available collector, black chrome selective surface on copper absorber tube, in steel trough fibre glass insulated and with acrylic Fresnel lens concentrator/cover. Single axis sun tracking	140	Manufacturer's data
11. Point focus parabolic dish - type A (4)	Existing design. Mirror glass mosaic parabolic dish reflector of concentration ratio 40 non-selective absorber. Two axis sun tracking	190	Determined by mathematical modelling and designers data
12. Point focus parabolic dish - type B (4)	Commercially available parabolic dish mirror reflector of concentration 200, non-selective spherical surface copper absorber. Lower dish reflectance - receiver absorbance product than collector 11. Two axis sun tracking	190	Based upon manufacturer's data
13. Central receiver - power tower (4)(5)	Array of coupled reflectors focussing onto a stationary central receiver. Concentration ratio of 50. Two axis sun tracking	120	Determined by mathematical modelling and designers data

## NOTES:

- (1) Not normally tracked (cost refers to fixed configuration)
- (2) Needs only be occasionally re-orientated so tracking mechanism operational
- (3) "North-South" or "equatorial" single axis tracking
- (4) Precise two-axis sun tracking generally necessary
- (5) Low cost due to relatively small number of reflectors that can be driven by a single heliostat (two-axis) drive.

TABLE 10 - SOLAR COLLECTOR TYPES USED IN THERMAL DESIGN STUDIES



System Option	Flat plate solar collector		
	Freon organic Rankine cycle engine		
	Non-tracking		
	2kWh/day engine output		
Solar Collector	Area required	: 36.3m <sup>2</sup>	
	Cost basis	: \$108/m <sup>2</sup>	
	Component cost	:	\$ 3920
Engine	Equivalent swept volume	: 1.11 litres	
	Cost basis	: \$ 525/litre	
	Component cost	:	\$ 580
	Additional fixed costs	:	\$ 690
Condenser	Equivalent tube length	: 50.7m	
	Cost basis	: \$7/m	
	Component cost	:	\$ 355
Pump (10m depth)	Fixed cost	:	\$ 400
Well head assembly and piping	Fixed cost	:	\$ 200
		Total cost	\$ 6145

TABLE 11 – EXAMPLE OF THERMAL SYSTEM COSTING (1981)

### 5.9.3 Function of the Thermal Systems Model

The model takes the performance characteristics of known solar collectors and thermal engine types and combines them. Figure 41 shows how the efficiency of engines improves with increasing temperature, while Figure 43 indicates how thermal collector efficiencies decline with temperature.

When collectors are combined with engines, an optimum operating temperature exists, where maximum system efficiency is obtained, which represents the best trade-off between the conflicting requirements. Figure 51 indicates the effects on the efficiency of R11 (Freon 11) Rankine cycle systems using a) a single-glazed simple flatplate solar collector and b) using a line-focusing moderate concentration factor collector. This latter example is about the upper temperature limit at which R11 can be used.

Reference to Figure 6 in section 2.7 gives a useful indication of where the principal losses occur on a complete small-scale solar thermal pumping system. It must be remembered that the overall efficiency figures of Figure 51 refer only to the collector and Rankine engine prime mover; a water pump plus the transmission and pipework associated with it will, as shown in Figure 7, introduce further losses so that the "overall efficiency" of Figure 51 needs to be reduced by from 40 to 80% for a complete small-scale pumping system.

For comparison, Rankine water-based (steam) systems using the same kind of line-focus collector are also indicated. In one case the steam is condensed at atmospheric pressure, (i.e. 100°C, as in an open cycle system exhausting to atmosphere) and in the other case, sub-atmospheric pressure condensing is assumed, at 55°C.

Lower temperature condensing has the same effect as higher temperature boiling in widening the temperature difference between the heat source and sink and thereby improves the thermal efficiency. Both water based options would have an optimum operating temperature above 200°C, but for the purposes of the modelling exercise it was assumed that this is the upper temperature limit for reasonably simple line-focus collectors and tracking systems as well as in relation to the pressures and conditions that would apply in the engine. This is bearing in mind that very small systems for use by farmers in developing countries are being considered.

The comparatively flat curves for concentrating linear focus collectors in Figure 43 might appear to suggest they are radically superior to flat plate collectors, but it must be remembered that the main case for the use of flat plate collectors is on account of their relative simplicity and therefore alleged low costs compared with tracking systems.

It is also worth noting that so far as concentrating, tracking systems are concerned, their cost and complexity increase considerably as a function of the concentration factor (i.e. operating temperature) due to the need for more precise focusing and tracking and to greater difficulties inherent in avoiding excessive heat losses when transmitting the working fluid from the absorber tube(s) to the engine.

Therefore the relatively high efficiencies obtainable from certain linear focus tracking systems at temperatures as high as 250 to 300°C may only be bought at a considerable cost both in terms of complexity and actual collector cost; however, with clever design it may also be possible to achieve such temperatures efficiently, reliably and at competitive costs.

The modelling exercise attempted to introduce various cost assumptions in assessing the relative merits of different systems. This is vital, since a purely technical assessment will inevitably simply prove that higher temperature systems are both more efficient and (consequently) much smaller; it would not say whether the greater efficiency and reduced size results in greater or lesser cost-effectiveness or how the apparent cost-effectiveness appears to compare with small-scale solar photovoltaic pumping systems.

The results of the modelling exercise were presented in terms of Specific Capital Cost, in exactly the same way as for the PV system cost analysis; a value of this is to allow direct comparison with solar PV pumping system costs as discussed in the preceding chapter. Specific Capital Cost is a measure of the investment required to install a system capable of producing a given hydraulic pumped energy output under a standard daily irradiation regime.

The input/output requirement used as a basis for comparing a variety of collector and engine combinations was:

- o solar input 6kWh/m<sup>2</sup> per day (same pattern as for the PV model analysis described earlier).
- o engine output, with the above input required to be 2kWh of shaft energy per day (which would represent 600Wh of pumped output per day if a 30% efficient pump were used. This is typical of the low head efficiency that would have to be expected using a positive displacement pump best suited for use with a Rankine engine; at higher heads the pump efficiency might reach 60% or more, giving 1200Wh/day of output from the same size system).

Since thermal systems are more likely to improve in efficiency if their size is increased, an analysis was also initiated into the likely costs of a system designed to deliver 10kWh/day of shaft power under similar input conditions.

There were many assumptions that necessarily had to be made as to the effects of economies of scale on the system components, many relating to the pump, rather than the engine itself. The result is the product of multiplying these assumptions together and in many ways indicated little more

## 2kW ENGINE DAILY OUTPUT (NOTE 2)

SYSTEM OPTION	COLLECTOR TYPE (SEE TABLE 13)	TRACKING	ENGINE TYPE	OPTIMUM OPERATING TEMPERATURE (NOTE 1) (°C)	PEAK ENGINE POWER OUTPUT WATTS	COLLECTOR AREA m <sup>2</sup>	CAPITAL COST \$	SPECIFIC CAPITAL COST \$/kJ (per day)
1	Flat plate single glazed	Yes	Organic Rankine Cycle (R11)	80	278	20.6	4410	2.0
2	Flat plate single glazed	No	Organic Rankine Cycle (R11)	80	491	36.3	6150	2.8
3	Flat plate double glazed	Yes	Organic Rankine Cycle (R11)	90	274	18.8	4540	2.1
4	Flat plate double glazed	No	Organic Rankine Cycle (R11)	90	474	32.5	6300	2.9
5	Evacuated tube	Yes	Organic Rankine Cycle (R11)	150	256	8.1	3680	1.7
6	Evacuated tube	No	Organic Rankine Cycle (R11)	150	409	12.9	4530	2.1
7	Compound parabolic	Yes	Organic Rankine Cycle (R11)	130	261	10.3	3210	1.5
8	E-W low concentration trough	No	Organic Rankine Cycle (R11)	105	777	35.0	5170	2.9
9	N-S trough unglazed absorber	Yes	Organic Rankine Cycle (R11)	100	492	20.9	4360	2.0
10	N-S trough glazed absorber	Yes	Organic Rankine Cycle (R11)	140	441	13.1	3490	1.6
11	N-S parabolic trough - manufacturer A	Yes	Organic Rankine Cycle (R11)	150	384	10.0	3310	1.5
12	N-S parabolic trough - manufacturer A	Yes	Steam, condenser @ 0.16 bar	190	401	10.8	3850	1.8
13	N-S parabolic trough - manufacturer A	Yes	Steam, condenser @ 1 bar	190	401	16.4	4110	1.9
14	N-S parabolic trough - manufacturer B	Yes	Organic Rankine Cycle (R11)	150	384	9.9	3290	1.5
15	N-S parabolic trough - manufacturer B	Yes	Steam, condenser @ 0.16 bar	190	400	10.6	3820	1.8
16	N-S parabolic trough - manufacturer B	Yes	Steam, condenser @ 1 bar	190	400	16.1	4070	1.9
17	Linear Fresnel lens concentrator	Yes	Organic Rankine Cycle (R11)	150	451	13.2	3800	1.8
18	Linear Fresnel lens concentrator	Yes	Steam, condenser @ 0.16 bar	190	530	17.0	4930	2.3
19	Linear Fresnel lens concentrator	Yes	Steam, condenser @ 1 bar	190	530	25.8	5520	2.6
20	Point focus parabolic dish - type A	Yes	Organic Rankine Cycle (R11)	150	370	7.8	3370	1.6
21	Point focus parabolic dish - type A	Yes	Steam, condenser @ 0.16 bar	190	382	8.3	3860	1.8
22	Point focus parabolic dish - type A	Yes	Steam, condenser @ 1 bar	190	382	12.6	4170	1.9
23	Point focus parabolic dish - type A	Yes	Stirling Cycle	500	443	4.4	2420	1.1
24	Point focus parabolic dish - type B	Yes	Organic Rankine Cycle (R11)	150	361	8.6	3770	1.7
25	Point focus parabolic dish - type B	Yes	Steam, condenser @ 0.16 bar	190	366	8.8	4180	1.9
26	Point focus parabolic dish - type B	Yes	Steam, condenser @ 1 bar	190	366	13.3	4550	2.1
27	Point focus parabolic dish - type B	Yes	Stirling Cycle	500	406	4.3	2660	1.2
28	Central receiver - power tower	Yes	Organic Rankine Cycle (R11)	150	366	7.7	2790	1.3
29	Central receiver - power tower	Yes	Steam, condenser @ 0.16 bar	190	377	8.1	3230	1.5
30	Central receiver - power tower	Yes	Steam, condenser @ 1 bar	190	377	12.3	3220	1.5
31	Central receiver - power tower	Yes	Stirling Cycle	500	423	4.0	2060	1.0

Note 1: Ambient temperature 20°C, coolant temperature 30°C  
 Note 2: 6kWh/m<sup>2</sup> (21.6MJ/m<sup>2</sup>) daily Global solar irradiation

TABLE 12 -- RESULTS OF THERMAL SYSTEM MATHEMATICAL MODELLING

than a larger system would be somewhat more cost-effective. How much more cost-effective could only reliably be determined through considerable further data collection and analysis. Since it is felt that the main value of this analysis is to show the relative merits of different system concepts in very broad and basic terms, and consideration of a larger system did not alter the apparent relative merits of the different concepts over the scale range chosen, it was decided not to proceed with work on the 10kWh/day system analysis.

For each system concept considered, the model calculates:

- o the optimum operating temperature,
- o the area of collector and size of engine and condenser necessary to achieve the required output with the input energy level specified,
- o and, hence the Specific Capital Cost to be expected for each system concept, (derived from cost data used in the manner shown in Table 13).

#### 5.9.4 Results of Thermal Systems Analysis

The results are presented in Table 12 and Figures 52 and 53. Figure 52 gives an indication of the relative cost-effectiveness of the different system concepts analysed, so it involves both technical and cost assumptions. Figure 53, on the other hand, simply shows the relative collector areas required for each concept and is therefore purely based on technical considerations; collector costs are dominant in general and therefore the area of collector needed is of interest.

The greatest uncertainty when going from the assumptions of Figure 53 to those of Figure 52 is the price differential between sophisticated point focus collectors and power towers and the less sophisticated line focus collectors (and their tracking mechanisms) and flat plate collectors. There is uncertainty on how mass-production might reduce the relative unit costs of the more sophisticated collectors compared with flat plate collectors; the analysis is based on present day costs and projections and compares technologies at different stages of maturity and scale of production.

On the cost assumptions used, which it is believed are reasonably close to present day reality, it seems that the improved efficiency resulting from a greater temperature difference (either through a hotter collector or a cooler condenser) is cost-effective. In other words, the higher temperature and more efficient systems invariably show significant reductions in Specific Capital Costs compared with conventional simple low temperature flat-plate collector systems.

It should be noted that if the collector terminology used in Table 12 is unfamiliar, the types of collector referred to are specified in more detail in Table 10.

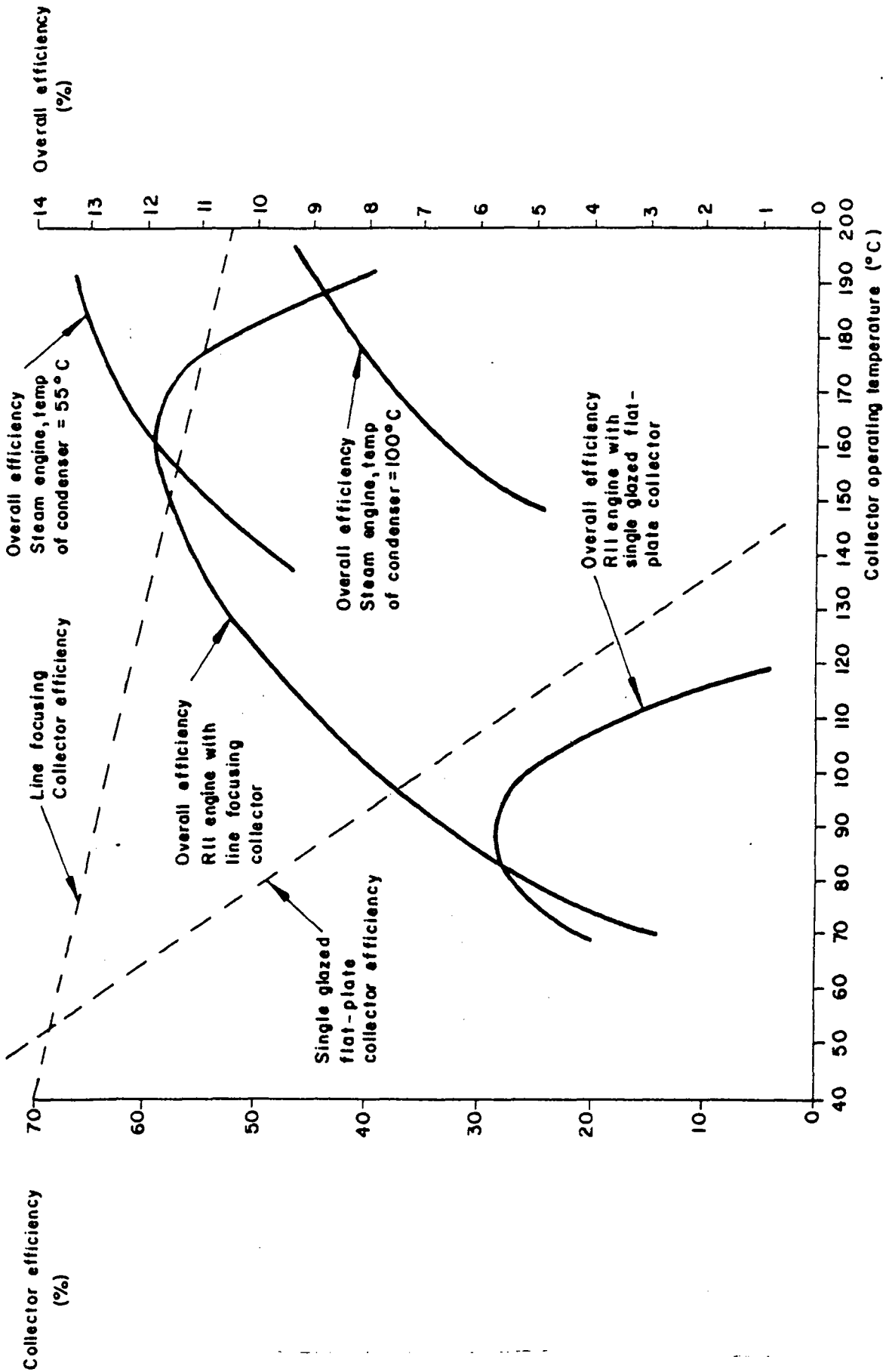

FIGURE 51 - EXAMPLES OF SOLAR COLLECTOR AND ENGINE EFFICIENCY  
(Excluding pump, mechanical transmission and pipework losses)

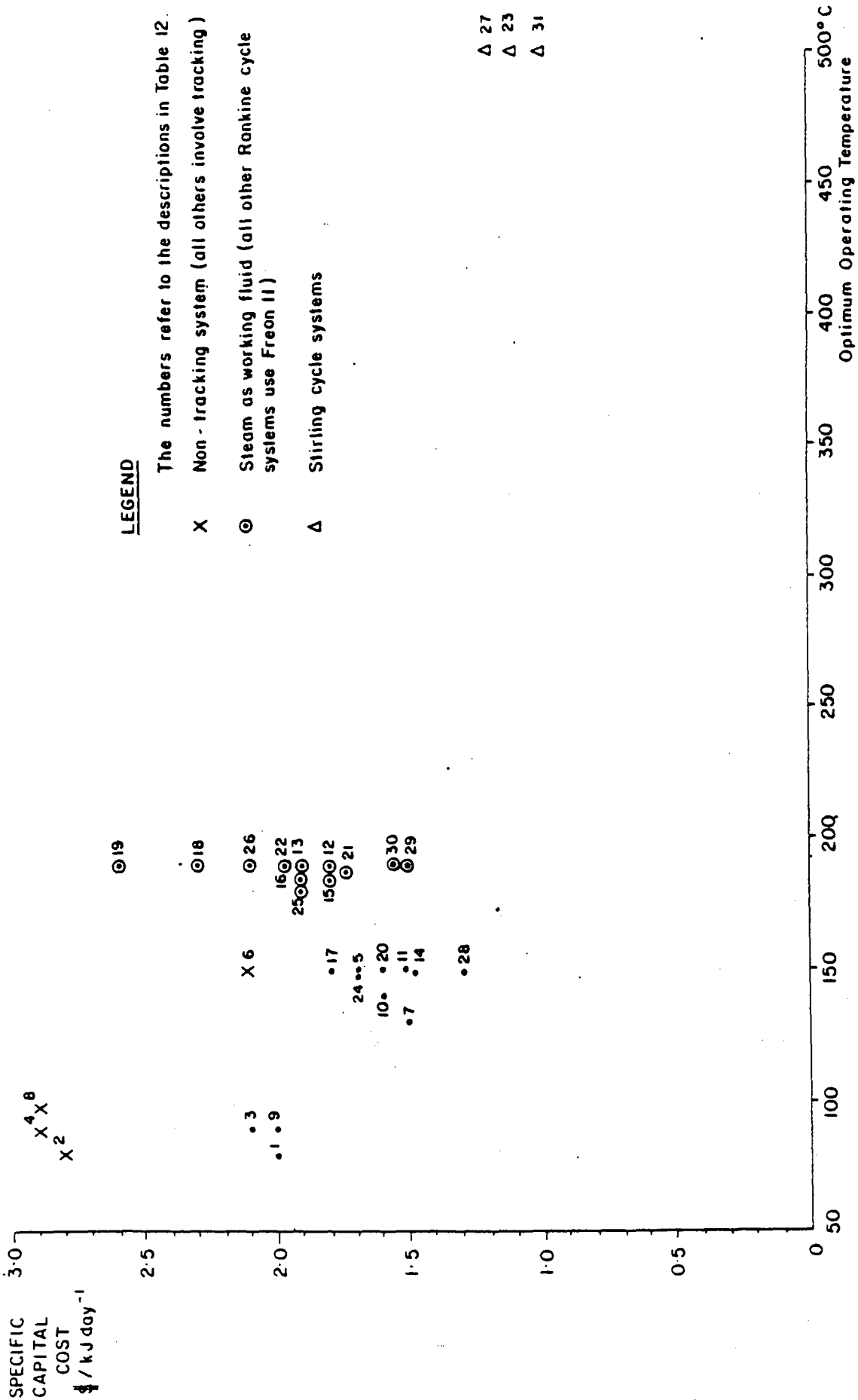

FIGURE S2 - EFFECT OF OPTIMUM OPERATING TEMPERATURE ON COSTS OF THERMAL SYSTEMS

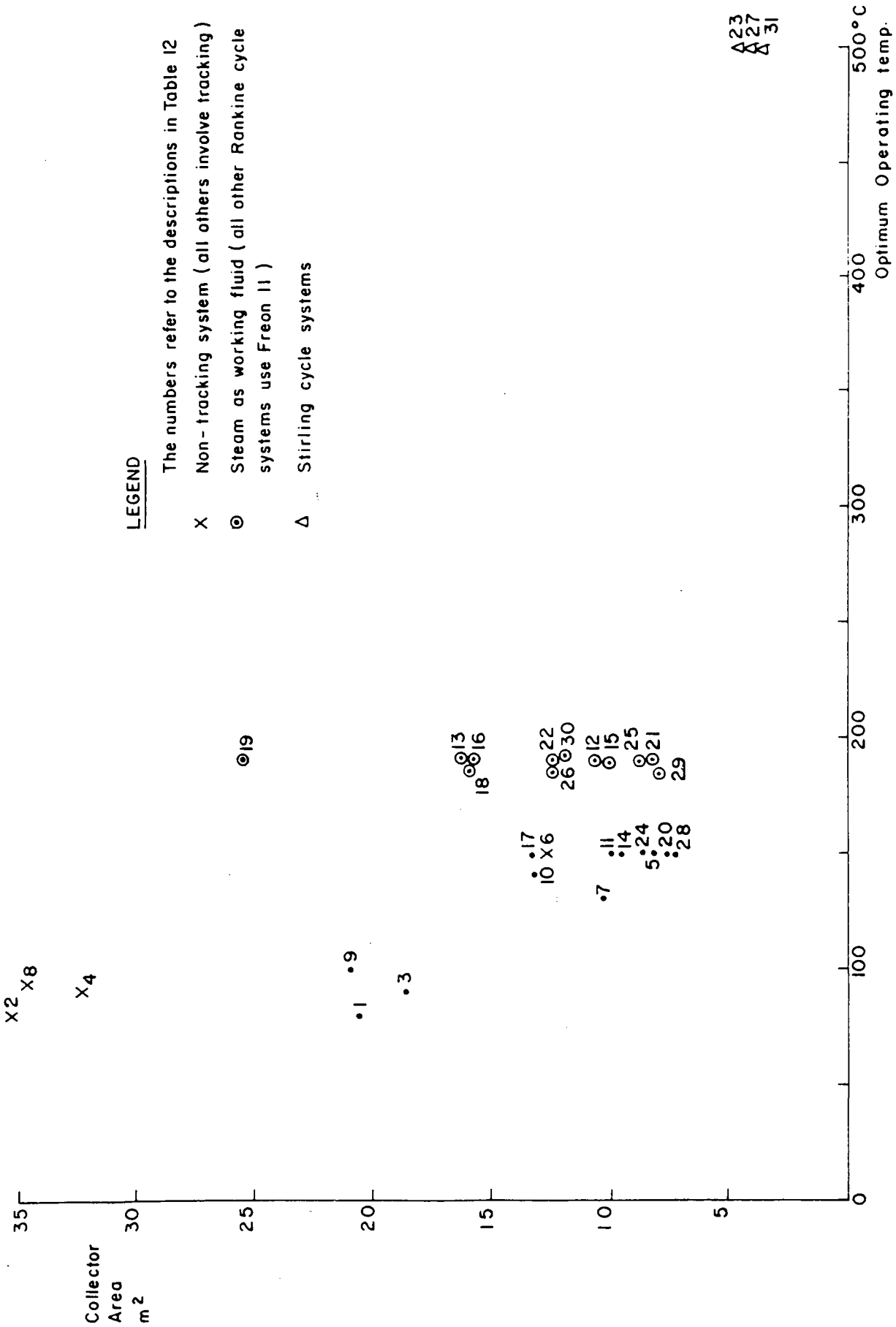

FIGURE 53 - EFFECT OF OPTIMUM OPERATING TEMPERATURE ON COLLECTOR AREAS OF THERMAL SYSTEMS



Certain factors stand out from the analysis and are highlighted by Figure 52:-

- a) fixed flat-plate collectors driving R11 engines appear to be about the least cost-effective option. This conclusion is at variance with the trends of recent years as aspiring manufacturers have used precisely this apparently wrong approach.
- b) tracking introduces significant economies even with flat plate collectors, for the kind of reasons detailed in section 2.7 and illustrated in Figures 4A and B, 5A and B. Compare examples 2, 4 and 8 in Figure 52 with their tracking equivalents 1, 3 and 9.
- c) systems using R11 as a working fluid appear cheaper than similar systems (using the same type of collector) with steam as a working fluid, even when operating at a lower temperature. This is mainly because R11 has better thermo-dynamic characteristics than steam at the temperatures considered and its use allows a much smaller system, as is also clearly evident from comparing areas of collectors of similar concepts in Figure 53. However, the steam engine might be able to overcome its size disadvantage through simpler and lower cost construction.
- d) Piston Stirling engines operating at high temperatures appear very attractive, but they are still far from practical use and many "ifs" are built into the cost assumptions. The main reason for their apparent low costs is the small size that results from their high efficiency. They are almost certainly the most efficient method of converting solar energy into shaft power currently available, and could become cheap through mass production if a successful and reliable design is perfected, since the material requirements for them are much smaller than for other types of system. Against these virtues must be balanced the cost and complexity of both the high temperature engine and of the high concentration factor collector with a very precise tracking mechanism (two axis).
- e) the Fluidyne liquid piston engine/pump which operates on the Stirling cycle in the form produced by Metal Box Ltd., has made rapid progress towards commercialisation.
- f) central receiver systems (power towers) are usually associated with large-scale solar thermal systems and have received surprisingly little attention for small-scale applications. They appear attractive for this kind of application, but are not in production for such small-scale usage.
- g) the fixed E-W trough collector, (with occasional seasonal reorientation in the vertical plane), appears unattractive, being little better than a fixed flat plate collector.

- h) a simple parabolic trough (or linear Fresnel lens) concentrator appears attractive for use in the medium to short term as it offers appreciable advantages over flat plate collectors and yet is quite a well developed concept with numerous examples on the commercial market, (intended mainly for heating commercial buildings or for process heat).
- i) the analysis of the same concepts used to deliver 10kWh/day produced the same general cost patterns, but the differences appeared to be more marked.
- j) the use of evacuated tube collectors results in a marked reduction of size compared with conventional flat plate collectors; with a 2kWh/day non-tracking system the reduction was from 36 down to 13 m<sup>2</sup>. Many uncertainties surround projections of the future cost of mass produced evacuated tube collectors and how competitive they would be for this application in cost terms. Also, the durability of evacuated tubes under field conditions remains to be demonstrated.
- k) quantity production of systems having a R11 (Freon) engine and line-focus parabolic trough collector could result in a system having a Specific Capital Cost of \$ 1.5/kJ per day (and an actual capital cost for a 2kWh shaft power per day output of around \$3300).

It should be noted that the tracking/concentrating thermal systems that appear from the analysis to be so advantageous compared with flat-plate systems, can only utilise the direct beam component of solar energy received while the latter can use diffuse radiation too. This was allowed for in the analysis, although solar data from an arid region (Sudan) were used.

In areas with a high proportion of diffuse solar irradiation, the difference between flat plate and concentrating systems would be narrower, but this would not be through the flat-plate systems becoming more cost-effective, rather than the concentrating systems would be less.

#### 5.9.5 Comparison between thermal and PV small scale pumping systems

Table 8 indicates that given certain improvements, plus manufacture in reasonable quantity, it should be possible at present day prices to obtain a Specific Capital Cost of around \$2.3/kJ per day from PV systems. This compares with the SCC of around \$ 5/kJ per day for imperfectly optimised present-day PV systems manufactured in very small quantities.

However, it is highly likely that by the time PV systems are manufactured in some quantity (i.e. thousands of units) the price of photocells will have fallen by 50% to around \$5/W pk and, as previously explained, it is probable that within a few years the price of PV cells will fall to nearer \$1 or \$2/W pk.

A price of \$5/W pk (50% reduction in PV cell costs) reduces the SCC of a well optimised PV system from 2.3 to about \$ 1.6 kJ per day. If the price of PV cells falls to \$2/W pk, then the PV system SCC would correspondingly fall to about \$ 1.2/kJ per day. Further reductions in PV cell costs do not have a very significant effect on PV Specific Capital Cost since the balance of system costs dominate. Probably a SCC at present dollar values of around \$ 1/ kJ per day is the absolute lower limit that could be achieved for small, low-head, PV systems.

Therefore it does seem probable that well-optimised PV systems will eventually have a significant, but not an overwhelming, edge over the best small thermal systems for low-head operation. Since PV systems are already a more mature produce, it seems unlikely that well optimised small thermal systems will become available before the expected reductions in PV cell costs are realised. The best SCC assumptions for small thermal systems are far more speculative than those used for PV systems, since they assume such requirements as a reliable low cost tracking system, etc.

However, the thermal systems cost analysis assumed operation with a positive displacement pump, which at low heads would probably be no more than 30% efficient. At higher heads, where a positive displacement pump could be 70-80% efficient, the SCC for small thermal systems is quite likely to be lower than that for low-head PV systems. Further, PV systems for higher heads would be relatively more complicated, requiring positive displacement pumps with reduction gearing, plus power conditioning electronics to obtain good optimisation, or multi-stage turbine pumps driven by a long shaft from the surface, or a submersible multistage turbine pump (which would require an extremely reliable brushless motor to be practical). These extra complications would if anything substantially increase the SCC for higher head PV systems as compared with low head ones.

In other words, low head operation seems to favour PV systems, while higher heads seem to favour thermal (assuming suitable thermal systems are developed). However, high head operation (over 10m) was outside the scope of the first Phase of this Project and further investigation would be needed to arrive at a reliable conclusion.

So far analyses have only considered "conventional" PV and thermal small-scale pumping system technologies, in the sense that all systems considered could be put together with existing components. What cannot be considered or predicted is the possibility of new inventions in either field radically altering the picture. Both fields offer scope for such possibilities, and many claims are made for unconventional solutions. Since the conventional technologies appear potentially capable of becoming cost-effective for small-scale pumping, although they are some way off at present, anything that offers any substantial improvement in cost-effectiveness could hardly avoid being immediately within striking distance of offering economic operation. The next chapter considers some of the unconventional technologies which just might overtake the approaches described in this and the previous chapter, and some which may be of general interest but which seem unlikely contenders for success in this field.

## 6. OTHER SOLAR PUMPING SYSTEM OPTIONS

### 6.1 Introduction

The preceding two sections have described solar photovoltaic and solar thermal pumping systems, which are at present the only options that have been demonstrated either as commercial products or which are sufficiently developed to be close to commercialisation. For completeness a number of other developments or potential methods for converting solar energy into pumped water power are considered below. Some of these techniques do not appear to have any future for small-scale solar pumping systems, but others may, with further development, prove to have advantages over the systems available at present.

### 6.2 Thermo-electric Generators

These devices utilise the Seebeck Effect in which an e.m.f. is produced when the junctions of a circuit made of suitable dissimilar metals are maintained at different temperatures, a principle that has been widely used for temperature measurements in certain types of thermocouple and for working thermostatic switches. At least two manufacturers produce commercial thermo-electric generators (Global Thermoelectric Power Systems Limited (Canada) and Teledyne Energy Systems Inc. (USA)), but both these systems are intended for ultra-reliable, virtually zero-maintenance power generation in remote areas with heating provided by propane gas in cylinders; neither supplier offers solar powered systems.

Like photovoltaic devices, the thermo-electric generator is a solid state device with no moving parts and consequently can be expected to have a long working life and to be very reliable. Propane heated units have been claimed to be 4 to 6% efficient and to work without any maintenance or attention for periods of up to six years at a time and to have a useful life of many decades. Typical power outputs are in the 10 to 300W range which would be appropriate for the end use being studied. Considerable work is believed to have been completed in the USSR on thermo-electric generation using solar heating and typical system efficiencies of 1 to 4% have been reported, with considerable improvement thought to be possible, (Reference 36).

Thermo-electric generators require high temperature operation (over 500°C) and therefore most experimental examples tested with solar power are mounted at the focus of a parabolic dish concentrating collector. As with high temperature heat engines, they are therefore dependent on the use of reliable and economic high temperature tracking concentrators and require regular direct sunshine.

Their costs at present do not appear to make them competitive with photovoltaic systems.

### 6.3 Thermionic Generators

These involve heating a suitable electron-emitting cathode surface in a vacuum or low pressure ionised gas; electrons are driven off and collected by a cold anode placed very close to the cathode. The principle is much the same as in a thermionic diode or valve (tube). Because very high temperatures are required (over 1000°C), there does not seem to be much potential for their use for small-scale solar pumping.

### 6.4 Brayton (Gas Turbine) Solar Thermal Systems

This process involves the continuous compression, heating and then expansion of a gas (as in a conventional gas turbine). It is mentioned for completeness but appears to have no potential for small-scale solar pumping because of the high temperatures required and the practical problems associated with small turbines.

### 6.5 Photochemical Systems

Ordinary plant growth by photosynthesis is the prime example of a photochemical system which forms the basis of all life on earth and which also formed most of our fossil fuels. Natural biomass utilisation is outside the scope of this project, but a synthetic photochemical process which shows some promise is the photo-electrolysis of water, in which sunlight is used, in the presence of various catalysts, to break water down into its constituent components of hydrogen and oxygen, which could then be used to power a fuel cell, or an engine.

It is too early to give any kind of firm estimate of the future potential of the catalytic photo-electrolysis of water process and artificial photosynthesis is even further from practical realisation at present, but if and when it is successful it could revolutionise the use of solar energy.

### 6.6 Improved Efficiency Photovoltaic Technology

Apart from the development of Cadmium Sulphide and Gallium Arsenide cells already referred to in Chapter 4, a number of other innovative developments are in hand to improve the efficiency of conversion or cost-effectiveness of photovoltaic cells but none is believed to be at all close to commercialisation as yet.

These methods include:

- i) Separation of incident light into wavelength bands which are then applied to photovoltaic devices chosen for their sensitivity to each band, giving overall efficiencies of up to 50%.
- ii) Vertical multi-junction cell, in which conventional silicon cells are stacked in such a way that light enters parallel to the junctions. These offer the possibility of efficiencies in excess of 20% and it has been claimed that

such cells are not so sensitive to reduction of performance under high temperatures, hence they are better suited for use in concentrating photovoltaic arrays of much higher potential efficiency than has so far been possible.

- iii) Thermophotovoltaic cell, in which sunlight is focussed onto a thermal mass in an enclosure designed to maintain the thermal mass at a temperature of 1800°C. A layer of cooled photovoltaic silicon cells is arranged behind the thermal mass and receives radiation at the wavelength corresponding to an emitter at 1800°C, which happens to be the wavelength to which silicon solar cells are particularly sensitive. In this way the relatively broad solar spectrum is converted with reasonably high efficiency to a much narrower wavelength band at which it can be converted with high efficiency to electricity by silicon cells. An overall system efficiency (solar radiation to electricity) of the order of 30 to 50% may thereby be achieved.

If the expected future cost reductions in conventional photovoltaic cells materialise then it is questionable whether any of these innovations will be economically justified.

## 6.7 Memory Metal and other Solid-State Heat Engines

Various alloys, including one of nickel and titanium developed by the US Naval Ordnance Laboratory called Nitinol, have the property that they deform easily at low temperatures but return to their original shape with considerable force if heated. Various simple heat engines have been demonstrated in which Nitinol elements are used by being alternately heated and cooled between warm water and air. So far this technology is at an early stage and low efficiencies have been reported. However, the rather small temperature differences required mean that it may be possible for such a device to function with simple and low cost (per unit area) collectors (e.g. possibly a solar pond) which may offset the disadvantage of low efficiency.

Differential expansion of dissimilar metal strips is also a potential source of power from a low temperature heat source, but the efficiency is again likely to be very low.

Rubber and other polymers have recently been shown to have similar properties to Nitinol and engines using these have been demonstrated in the laboratory. However their efficiencies seem low and they are still at too early a stage in their development for it to be clear whether they may eventually be either technically or economically viable.

## 6.8 Osmotic Pressure Engines

In theory, thermal energy can be converted to mechanical energy for pumping by an osmotic process. In this process, a dilute solution, such as brackish water, is distilled using solar heat into separate solvent and concentrate (e.g. distilled water

and saturated brine solution). The concentrated solution and solvent are then passed into two chambers separated by a semi-permeable membrane. The resulting osmotic pressure set up across the membrane is very substantial (up to 380 atmospheres in the case of concentrated brine and distilled water), and this pressure could be used to drive a turbine or other mechanical device (see Reference 37).

Although the techniques for solar distillation are simple and well-established, it is not thought that any serious investigation into the feasibility of energy conversion based on osmotic pressures has taken place.

## 7. REFERENCES

1. UNDP/World Bank/Sir William Halcrow & Partners/Intermediate Technology Dev. Grp. Ltd., "Testing & Demonstration of Small-Scale Solar-Powered Pumping Systems: State-of-Art Report", London, December 1979.
2. Salazar, G., & Mcss, C.J., "An overview of the water pumping equipment available to small farmers" International Rice Research Institute, Los Banos, Philippines, 1979.
3. World Bank "Energy in the Developing Countries", Washington, August 1980, (p 53).
4. Stern, Peter "Small-Scale Irrigation", I T Publications, London, 1979, (p 16 et seq)
5. World Bank "World Bank Development Report, 1980", World Bank/Oxford University Press, New York, 1980. (p42-3).
6. Leach, Gerald "Energy & Food Production", International Institute for Environment & Development, London, 1975 (p9-15).
7. World Water, Oct 1980, "The Right to Rice".
8. Smith, Douglas V., "Photovoltaic power in less developed countries", M.I.T., Massachusetts, 1977.
9. Langerhorst, J., et al, "Solar Energy, report of a study on the difficulties involved in applying solar energy in developing countries" Netherlands Ministry for Development Cooperation, 1977.
10. Tabors, Richard D., "The Economics of Water Lifting for Small-Scale Irrigation in the Third World: Traditional and Photovoltaic Technologies "M.I.T. Energy Laboratory Report M.I.T. - EL - 79 - 011, Cambridge, Mass., 1979.
11. Makhijani, Arjun and Poole, Alan, "Energy & Agriculture in the Third World," Ballinger, Cambridge, Mass., USA, 1975.
12. Electrical Research Association Ltd., "Electric Power Plant International", 1978 - 79 Edition, Leatherhead, Surrey, 1980.
13. Kooi, Clarence F., "Cost Comparison of Diesel and Photovoltaic Pumps for 'Action Ble' ", REDSO/WA, (private communication, Dec 1980).
14. French, David,; "The Economics of Renewable Energy Systems for Developing Countries", al Dir'iyyah Institute & USAID funded private report, Washington DC, USA.
15. Jansen, W.A.M., "Performance Tests of Kerosene Engine Pumpsets", Wind Energy Unit, Water Resources Board, Colombo, Sri Lanka, 1979.



16. J.D.Walton, A.H.Roy and S.H.Bomar, "A State-of-the-Art survey of solar powered irrigation pumps, solar cookers and wood burning stoves for use in sub-saharan Africa", Georgia Institute of Technology, Atlanta, USA, 1978.
17. J.Giri and B. Meunier, "Evaluation des energie nouvelles pur le developpement des etats africains", Ministry of Co-operation, France, 1977.
18. M.N.Bahadori, "Solar Water Pumping", Solar Energy 21 (4) p. 307, 1978.
19. J.T. Pytlinski, "Solar energy installations for pumping irrigation water", Solar Energy 21 (4) p 255, 1978.
20. E.H. Lysen, "Solar pumps", TOOL Compendium 5, April 1979.
21. P.L. Fraenkel (editor), "The Power Guide", Intermediate Technology Publications, 1979.
22. D.L.Larson and C.D. Sands II, "Considerations in using solar energy to drive irrigation pumps", Proc. of the International Conference on Energy Use Management, Pergamon Press, 1977.
23. J.P. Durand, M.G. Clemot, J.P. Girardier and M.Y. Vergnet, "Utilisation of solar energy in the development of arid zones: solar water pumps", Technology for Solar Energy Utilisation UNIDO Development and Transfer of Technology Series No. 5, 1978.
24. W.K. Kennedy, "The appropriateness and implementation of solar energy in rural development programmes in developing countries", Proc. of the UNESCO/WMO Symposium, Geneva, WMO 477, September 1976.
25. US Department of Energy Target Costs for Photovoltaics, quoted by R.G.Forney, "Photovoltaics in the USA - a progress report", Proc. of One-day Conference on Photovoltaic Solar Energy Conversion, UK-ISES, September 1979.
26. Maycock, Paul - Presentation at 15th IEEE PV Specialists Conf., Orlando, Florida, May, 1981.
27. Gay, Charles F., "Solar Cell Technology: an assessment of the State of the Art", Solar Engineering Magazine, Dallas, Texas, Vol. 5, No.3, March 1980.
28. R.W. Matlin, "Design optimization and performance characteristics of a photovoltaic micro-irrigation system for use in developing countires", MIT Lincoln Laboratory, Lexington, USA, July 1979.
29. D.Campana, A. Castiel, A. Perez, J.A. Roger, C. Dupuy, P. Labit and M. Lepert, "Realisation and testing of a pumping system powered by solar cells", Proc. of the UNESCO/WMO Symposium, Geneva, WMO 477, September 1976.
30. Butti, K. and Perlin, S., "A Golden Thread: 2500 years of Solar architecture and Technology", Cheshire Books/Van Nostrand Reinhold, 1980.

31. Sandia National Laboratories, "Concentrator Collector Results, Report SAND 80-0865, Albuquerque, N.M. USA, 1980.
32. R.L.Wood and E.A.Platt, "Shallow solar pond powered irrigation pumping: a feasibility study", Proc American Section ISES Annual Meeting, P 41 - 45, Denver, USA, August 1978.
33. W.T.Beale, "A free cylinder Stirling engine solar powered water pump", Sunpower Inc., Athens, Ohio, USA, 1979.
34. D.R.Gedeon, "The optimization of Stirling cycle machines", Sunpower Inc., Athens, Ohio. USA, 1979.
35. G.G.Puri, "A reflector concentrator modified Stirling engine unit for farm power needs", Proc. International Solar Energy Society Congress, New Delhi, 1978.
36. V. Baum and N. Ovezsackatov, "Solar thermoelectric generators, attainable efficiency and perspectives", Proc. International Solar Energy Society Congress, New Delhi, 1978.
37. "Application of Solar technology to today's energy needs", Office of Technology Assessment, Congress of the United States, Washington, USA, 1978.
38. Doorenbos J., and Pritt W.O., "Crop Water Requirements" FAO Irrigation and Drainage Paper No. 24. 1977.



## **APPENDICES**

- 1. Preliminary Estimates of Costs of Solar Pumping Systems in Developing Countries**
- 2. General Recommendations for the Development of Small-Scale Solar Pumping Systems**
- 3. Executive Summary of the Project Report**
- 4. Objectives of and Preparation for Phase II of the Project**

**APPENDIX 1**

**Preliminary Estimates of Costs of Solar Pumping Systems in Developing Countries**

## APPENDIX 1

### PRELIMINARY ESTIMATES OF COSTS OF SOLAR PUMPING SYSTEMS IN DEVELOPING COUNTRIES

#### 1. Background

With the continuous escalation in the price of fossil fuels, and the anticipated global shortage of oil, the attractions of solar energy have magnified enormously over the last ten years. The American government gave a target in 1979 that renewable energy sources must satisfy 20% of total U.S. energy needs by the year 2000, and naturally this gave much stimulus to the solar industry in the USA.

However, all this activity is not necessarily beneficial so far as the needs of developing countries are concerned. The US programmes are of national, political, and military significance, and while the economic aspect is obviously important it is not necessarily all important. The majority of the end uses, and the vast purchasing powers of the U.S. market are quite different from those of developing countries. Therefore much of the development is high technology, large scale, sophisticated, and in a country with an almost unlimited manufacturing base plus the highly skilled maintenance follow up required.

Developing countries offer a complete and stark contrast to the USA. Technology is limited, and so is the supply of technicians, the manufacturing base is small, only fairly standard raw materials are available (with imports of special items difficult due to lack of foreign currency), quality control at manufacture and after sales maintenance follow up is likely to be inadequate.

Manufacture of solar pumping systems in the developing countries, beneficial though it might be, is therefore by no means an automatic spin-off from work carried out in the industrialised countries.

Fortunately there is a plus to this situation as well as a minus. Appropriate solar pumping system technology must aim for maximum simplicity, which in turn can lead to lower prices and should give better reliability.

#### 2. Cost and Market

Given a low enough cost there is undoubtedly a very large world wide demand for reliable small-scale solar-powered pumps for irrigation and water supply. While first cost is not the only factor in the overall economic equation it is almost certainly the most important. As mentioned earlier this can work in favour of the Project since low first cost implies simplicity and small-size, which in turn implies a design suitable for manufacture in the developing countries.

### 3. Estimate of costs of quantity production of a 200 watt PV system

The simple type of sythen is assumed:

Array/DC Motor/Centrifugal Pump

A maximum power point tracker (MPPT) is also considered in case these turn out to be cost-effective. Cost estimates for quantity production in a developing country in 1984 are made for each component as follows:

#### (i) Array

Modules from USA at \$5 per peak watt

(At a later stage cells may be imported and built into modules in the developing countries - though the value added will be modest)

50% added for packing, air freight, import duty, and local fabrication into arrays - including provision for 2 axis adjustment. This gives \$7.50 per watt.

Assuming 50% wire to water efficiency, array must produce 400 Watts.

Cost = \$3000

#### (ii) MPPT

Initial import of 10 complete units plus 100 sets of components to the developing country.

Deletion program increases local content to 100% as local components become available.

Cost taken as \$200

#### (iii) DC Motor

Developing country will probably have to import (initially at least) copper wire for windings, ball bearings, seals, permanent magnets and armature stampings.

Hopefully commutation will be brushless, position unclear at the moment.

Shaft, casing, and various other parts to be made in developing country.

Armature winding and motor assembly locally.

Total cost taken as \$250

**(iv) Centrifugal Pump**

Main casings (cast iron) and shaft produced in developing country.

Initial import, but later local production, of impeller (sintered metal or plastic), and shaft seal (spring loaded graphite/steel), and plain bearings (probably sintered metal).

Total cost taken as \$300

Thus the target cost for the complete system is \$3750

It should be stated that:

- (a) The significance of the array cost as 80% of the overall price build up is apparent even with cells purchased at \$5/W pk
- (b) No attempt has been made to estimate installation costs since these by their nature are site specific.



#### 4. Estimate of costs of quantity production of the 200 Watt thermal system

A conventional design is assumed using a simple line-focussing low concentration tracking collector with the Solar Pump Corporation system components taken as models for casting the balance of the system. Cost estimates for quantity production in the developing country in 1984 for each component as follows:

##### (i) Collector

Copper pipe, reflectors and tracking unit for concentrator probably imported. Steel framing, insulation and overall fabrication assumed available in developing country.

Given some efficiency increase from development work up to 1984, area for 200 watts peak pumping power could be about 10m<sup>2</sup>.

Taking \$150 per square metre, (compared with current U.S. manufacturer's price of \$120/m<sup>2</sup> including tracker)

Cost = \$1500

##### (ii). Main Frame

Fabricated from local standard stock steel, and including provision for mounting of collector and tracker.

Cost taken as \$400

##### (iii) Freon Engine & Valve

Main rubber diaphragm, various seals, and some small components imported, initially at least.

Main housing, piston rod, piston rod guide etc, and most valve parts cast and machined in developing country.

Cost taken as \$350

##### (iv) Condenser

Made in developing country

Cost taken as \$250

(v) **Freon Pump**

Seals imported, otherwise locally made,

Cost taken as \$ 100

(vi) **Pressure Relief Valve**

Locally made

Cost taken as \$ 50

(vii) **Various Levers etc**

Locally made

Cost taken as \$ 100

(viii) **Well Head Assembly**

Locally made.

Cost will clearly depend on cylinder size and depth of well. For a 10 metre depth it would seem not unreasonable to take cost as :-

\$400

(ix) **Freon**

Taken as \$ 100

(x) **Piping & Assembly**

Taken as \$ 250

Thus the target cost for the complete system is \$3600. It should be noted that:-

- (a) SPC have "guestimated" a selling price of \$ 4000 for quantity production in Las Vegas of their flat plate collector, but otherwise similar system.

- (b) No figure is included for site preparation, foundation work, etc. The assembly figure (§ 250) covers the assembly and pipe connection work.
- (c) It is felt that considerable design, development, and test work will be necessary before any small thermal system is suitable for quantity production, either in developing countries or in industrialised countries.

**APPENDIX 2**

**General Recommendations for the Development of Small-Scale Solar Pumping Systems**

**GENERAL RECOMMENDATIONS FOR THE DEVELOPMENT OF SMALL-SCALE SOLAR PUMPING SYSTEMS\*****1 Applications**

Small-scale solar pumps for irrigation purposes are more likely to be successful if they are:

- o applied in areas where irrigation has been traditionally practised, so that it is only the use of the novel pump technology and not irrigation per se that has to be taught
- o sized for small land holdings of the order of 0.5 ha., for which they are most competitive with the alternatives
- o first promoted in areas which need to be irrigated over most of the year and where multiple cropping might be practised in order to achieve a good year-round load factor for the solar pump
- o preferably restricted, at least initially, to pumping static heads of no more than around 5m (and 10m at the very highest), implying a system output of the order of 100 to 300W peak of hydraulic power for a land area of 0.5 ha.
- o used generally in areas where the provision of fuel for engines is proving increasingly difficult and costly and where mains electric power is absent.

It should be noted that the first costs of the more cost-effective of the present generation of pumps are still at least double that of systems which would represent an economic investment when used for irrigation. The aspect is discussed fully in the Technical and Economic review.

Small-scale solar pumps should also be considered for application to non-irrigation purposes such as village or livestock water supplies, which offer a better load factor (demand being more or less constant all the year around). Another point of fundamental importance is that the price which water can command for domestic purposes is considerably higher than for irrigation. It was beyond the scope of the project so far to investigate these other end-uses but it is expected that solar pumps would be viable at a much higher head (perhaps up to 20m) for this kind of application.

**2 Photovoltaic System Specification****General**

As a result of the studies completed under this project, it is possible to produce an outline specification for a small-scale PV pumping system for irrigation at low heads, that ought to be competitive with small engine powered pumps in many parts of the world.

It must be stressed that this is not the ultimate type of design that is to be recommended, but the logical next step incorporating the principal lessons learnt so far in using present day equipment. It is to be expected, of course, that innovative developments in the technology will introduce new options in the near future that are not considered here, but which have been discussed in the Project Record and in the Technical and Economic Review accompanying this Report.

\* A copy of Chapter 11 'Design Recommendations' from the Project Report

## iii) System Efficiency Requirement

Optimum system efficiency targets should be set as follows for the next generation of pumping systems:

array cells	11%	at 25°C (10% at NOCT)
connections	95%	
motor	85%	
pump	55%	
pipework	95%	

total for system 4.6% (based on array cell area)

This is equivalent to the very best systems so far tested. Any power conditioner or other such accessories that consume power, should provide benefits to more than compensate for their cost and power consumption.

## iv) Design Point to be observed

In preparing designs to meet performance specifications of the type outlined in 11.2.2 and the target efficiencies set out in 11.2.3, it is recommended that manufacturers pay due regard to the following practical design points. These are not listed with the intention of inhibiting future development in any way, but as a convenient resume of the main lessons learnt during Phase I of the Project.

## a) General Requirements

- o the system should either be fully portable and mounted on skids or wheels or it should be fixed. In the latter case the array should be mounted at least 1.5m above ground level and bolted to not more than two concrete foundation blocks; the holding down bolts to be positioned to an accuracy no better than 25mm, to allow for errors in the positioning of the foundations.
- o systems should be designed to survive particular local climatic conditions. In areas prone to typhoons or hurricanes it may be necessary to provide for the rapid dismantling and removal to safety of the array.
- o pumps and motors should be provided with sun-shades whenever possible, but be well ventilated if air-cooled.
- o materials exposed to solar radiation (such as plastics) should have proven durability.
- o modules should be individually packed to avoid damage in transit. No single package for the system should exceed 1m x 2m or a weight of 50kg. Safety of contents should not be dependent on being stored any particular way up or on receiving special handling treatment.

- o detailed instructions should be provided, in the local language, for the correct assembly of the system. Also included should be a components list, maintenance and operating instructions and guidance on how to achieve the best output (eg, not using small bore pipes or restricting fittings, not allowing shadows to fall on the array). All documentation should be written in simple terms.
- o the need for routine maintenance lubrication and re-adjustments (eg, belt-drives and waterseal packing) should be minimised and avoided if possible.

(b) Array and Module Requirements

- o lifetime guarantee of say 5 years against faulty quality with no more than 10% degradation of performance to be accepted.
- o small modules (not more than about 20W nominal rating preferred).
- o laminated glass or an impervious and ultra-violet resistant plastic cover.
- o optimum module cell efficiency exceeding 11%.
- o redundant interconnects between cells.
- o no air gap between cell encapsulant and cover glass.
- o generously sized (brass) terminals with grip screws, (plated steel terminals not acceptable) or appropriate plug and socket connectors.
- o weather-sealed terminal boxes behind array.
- o array frame should be capable of being manually tracked on an equatorial axis at intervals through the day.
- o array inclination should be adjustable and preferably engraved with correct angles for different season for the region.
- o cables should be generous in cross-section, to limit resistive losses at full power to no more than 5%; blocking diodes (if required) should result in no more than 2% loss at full power.
- o array nominal voltage under peak sunlight conditions should be around 80V; higher voltages will not be safe, while lower voltages will mean higher currents and larger resistive losses.

- o electronic power conditioners (or other electronic circuitry) should be fully 'tropicalised' and should use components to tropical ambient temperature specifications. Full protection by automatic cut-out against excessive temperature, voltage or current, (prefer automatic reset).
  - o quality assurance and testing to be to a satisfactory standard and specified by the manufacturer.
  - o module or array performance to be specified on the basis of tests to a stated international standard. The module/array area to which array efficiency is referred is to be clearly defined.
- c) Subsystem (motor-pump unit plus fittings) Requirements
- o dc permanent magnet motor preferred unless alternative shown to be of comparable efficiency.
  - o fail-safe brush gear (motor stops when brushes too worn), or electronically commutated motor, (see electronic requirements above). If brushes are used, life of 4000 hours minimum required between changes. Sufficient spare brushes for the expected life of the system should be provided.
  - o generously sized brass terminals with grip screws (plated steel terminals not acceptable) or appropriate plug and socket connectors.
  - o full load motor efficiency should exceed 85%.
  - o half load motor efficiency should exceed 75%.
  - o motor bearings and other components should be sized for a life in excess of 10,000 hours.
  - o submersible units are preferred to eliminate suction problems.
  - o if motor not submersible, coupling between motor and pump should permit significant motor and pump angular and/or parallel misalignment. Motor and pump bearings should be entirely independent, except in the case of integral submersible motor-pump units.
  - o thermal cut-out required on motor, unless motor can sustain continuous stalled conditions with the maximum array current.
  - o pump optimum efficiency should be in excess of 50%.
  - o pump should be capable of self-priming in the event of a leaking footvalve (where fitted).



- o impeller material, clearances and passages should be suitable for use with water containing suspended silt and/or corrosive salts. Open impellers are preferred.
- o where necessary, a suitable strainer for larger particles should be provided and to be sized so as to have negligible effect on performance while clear.
- o pumps should not normally weigh in excess of about 30 kg for low head irrigation application, and should preferably be no heavier than 20 kg (assuming peak flow rates in the range of 2-5 l/s).
- o pump should have bearings sized for 10,000 hours of operation and be supplied with spare seals or any other consumables to cover that period of operation; prefer ball bearings with grease seals.
- o pump characteristic should permit stable operation at sub-optimum speeds.
- o pump should be capable of running dry without serious damage if not submersible; alternatively, fail-safe method of protection from running when dry should be provided, and seals designed to suit.
- o pipework and fittings should be correctly optimised for minimum system cost, rather than minimum pipework cost; all pipework should be supplied with system to length specified for head and site.

### 3 Thermal System Development

Following the laboratory tests of thermal systems, the system design studies, and the installation in the field of a complete system, definite recommendations for the development of small-scale solar-thermal water pumping systems can be made.

The continued development of solar-thermal systems should be encouraged in particular to demonstrate small-scale systems utilizing concentrating solar collectors with organic Rankine cycle engines or high temperature air Stirling cycle engines.

Existing working systems have been shown to have the potential for quantity production at costs comparable with the present costs of photovoltaic systems. Further development of these type of systems is justified if significant future reductions in the cost of photovoltaics is in doubt in which case development should be encouraged to improve the reliability and performance in order to achieve designs more appropriate to the proposed use.

Further work is required in order to broaden the limited scope of the present thermal design studies and in particular to investigate the designs that have been shown to have promise for low cost manufacture.

Specific Capital Cost analysis on small thermal systems gave \$ 1.5/kJ per day for a Freon vapour Rankine cycle engine with a one-axis tracking parabolic trough (line-focus) collector. A high temperature air Stirling cycle engine with a point-focus, tracking parabolic dish collector or central receiver collector also should be further investigated as the Specific Capital Cost was determined as being even lower. Components in this type of system are however less developed than those in line-focus collector Rankine cycle engine systems

Components that may form part of an improved solar-thermal system should be evaluated and tested. For example an inexpensive reliable tracking mechanism for a solar collector needs to be investigated.

Improved systems will need thorough laboratory tests followed by field trials. This will also improve the data base for development of the mathematical model.

The sizing of thermal systems needs further study to improve Specific Capital Costs. This is more size dependant for thermal systems than for photovoltaics.

Daily output m<sup>3</sup>

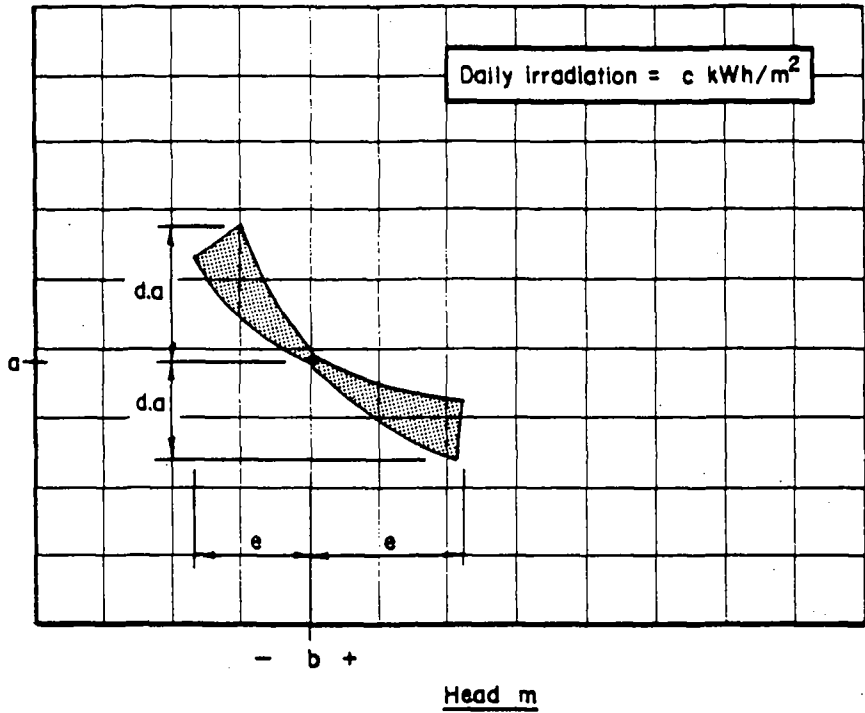

Daily output (m<sup>3</sup>)  
at head b.m.

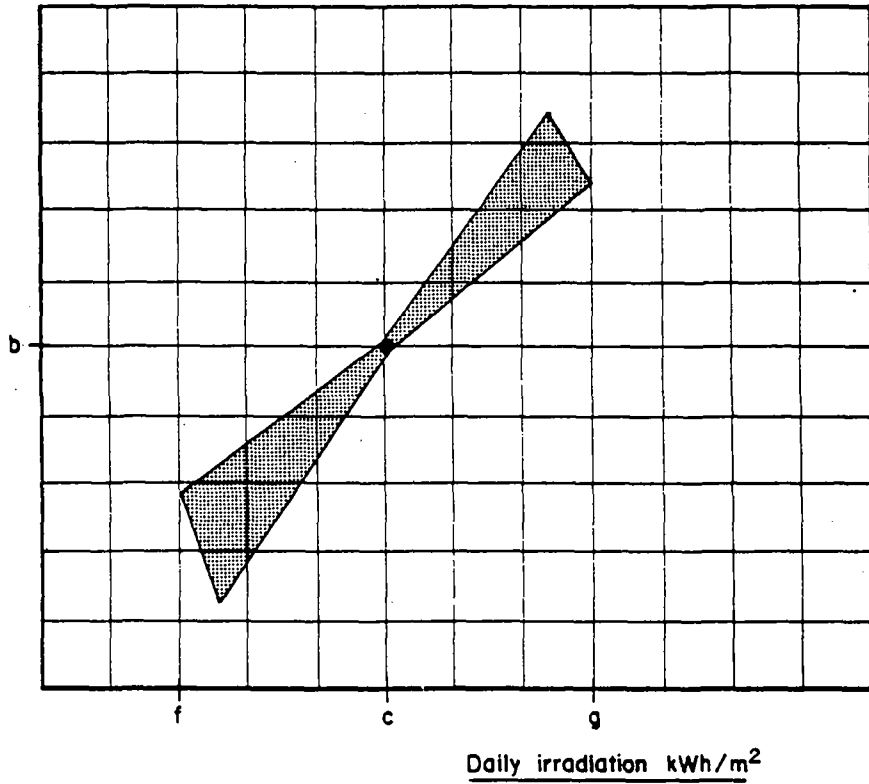

Figure 53 Specification characteristics for photovoltaic pump

**APPENDIX 3**

**Executive Summary of the Project Report**

## EXECUTIVE SUMMARY

### 1. INTRODUCTION

#### 1.1 Purpose and Background

The Project was funded by the UNDP and executed by the World Bank. The Consultants appointed to implement the technical work were Sir William Halcrow & Partners working in association with the Intermediate Technology Development Group (both of London, UK). Phase I of the Project commenced in July 1979 and lasted until May 1981.

The main purpose of Phase I of the Project has been to demonstrate and evaluate the use of solar energy for powering small-scale pumping systems to be used for irrigation on typical small land holdings in developing countries, with a view to recommending how the technology should develop.

In this connection, "small" land holdings refers to the millions of intensely cultivated land holdings farmed by poorer farmers in many developing countries, the majority of which have areas of around one hectare or less requiring, typically, about 50m<sup>3</sup> of water per day per hectare in the irrigation season. The hydraulic power output required to pump such daily volumes from depths of typically 5m, will be of the order of 100-300W.

In order to evaluate pumps for this duty, considerable practical work was required, including field trials of systems and laboratory testing of subsystems and components, followed by an analytical system design study.

As a result of this work, the likely performance to be expected from small-scale solar pumps as the technology matures has been determined with some precision. The advantages and disadvantages of different technical options have been studied and indications obtained about the desirable features to be developed for small-scale irrigation pumping systems.

Some forecasts of the likely price trends and of the factors that affect the economics of such systems have also been made.

During the course of the Project, much useful experience was gained about the procedures necessary for testing the equipment in the field and laboratory and for data collection and reporting. Valuable lessons were also learnt about the collaborative relationships which need to be established with the co-operating agencies in the host countries and these will be useful to future phases of this Project.

#### 1.2 Reports

This Volume contains a description of the project and the substantive conclusions which were reached as a result of the work done in Phase I. An accompanying Volume reviewing the technical state-of-the-art, possible future developments and

the general economics of small-scale solar pumps, is entitled "Small-Scale Solar-Powered Irrigation Pumping Systems: Technical and Economic Review".

Phase I of the project conveniently breaks down into three principal components - field trials, laboratory tests and system design studies-and this is the general format of the Project Report and of the summary which follows.

## **2. FIELD TRIALS**

### **2.1 Objectives**

The main objectives of the field trials were:

1. To obtain first hand, reliable and objective performance data for existing systems under field conditions as a prerequisite for assessing how the technology should be improved.
2. To gain experience with the management of field testing, data collection and analysis and reporting.
3. To demonstrate the technology in countries typical of those in which solar pumping may have widespread future application as a preliminary to technology transfer, and to highlight the aspects which most urgently require attention.
4. To provide data for the validation of the mathematical model built as part of the system design studies.

The UNDP selected Mali, Philippines and Sudan to participate in the field trials. The Consultants collaborated with the Solar Energy Laboratory in Mali, the Center for Non-Conventional Energy Development in Philippines, and the Institute of Energy Research in Sudan.

### **2.2 Selection of Equipment**

The Consultants reviewed the availability of small-scale solar pumps suitable for the purposes of the Project. 250 questionnaires were sent to potential suppliers throughout the world. However, although many countries have significant R & D programmes, few suppliers were in a position to offer adequately developed systems to satisfy the selection criteria and within the delivery schedule demanded by the Project.

The selection criteria required equipment with the correct delivery for the head specified, typically in the range 1 to 3 litre/sec through a static head of 5 to 10m under peak sunlight conditions. Also, systems were required to be robust and

practical, have low maintenance requirements, be efficient and preferably have some promise of capability of manufacture in developing countries. The required delivery time was 13 weeks from time of order.

Only 13 suppliers were able to offer equipment that appeared suitable and a short list was prepared for approval by the World Bank. Finally, 10 different systems were purchased, nine photovoltaic (PV) and one thermal. One PV system was duplicated and so 11 systems in all were purchased for the field trials. In addition, permission was given to monitor an existing system already installed and working in Mali, but not purchased by the Project.

The 12 systems monitored, their respective costs (including air freight to host country), locations and the volume of data collected for them are indicated in Table I.

### 2.3 Field Programme and Progress

The field programmes in each country were supported by Resident Engineers (RE's), one in each country, posted by the Consultants to assist the national institution install the equipment and to advise the local engineers and technicians in its use and in the monitoring procedures. The RE's had previously visited the manufacturers of the systems they were to install to inspect the equipment prior to despatch and to receive instruction and advice.

The principal parameters measured in the field were concerned with performance assessment, both instantaneously through continuous monitoring of key variables (such as irradiance in the plane of the array, photovoltaic array electrical power output and pumped water flow rate) using chart recorders and cumulatively, by daily readings of inputs and outputs (such as solar energy input during the whole day, electrical energy generated and total quantity of water pumped) registered on totalizers.

In the event, the recording of field data presented some difficulties: technically with the pumping systems and to a lesser extent, with the instruments; and logistically with late deliveries by the manufacturers, damaged key items, and difficulty in arranging transport to the sites. The short time scale of Phase I also created other problems: equipment could only be ordered in January 1980, testing commenced mainly between June and September 1980, and the RE's left their countries by September 1980 (returning briefly later in December 1980 and/or January 1981). Despite these matters, the field trials programme was substantially completed by the end of Phase I.

Of the 12 systems monitored, 10 yielded sufficient continuous data to determine their performance, while two systems could not be tested at all; in one case (a PV system) this was because of delays in arrival of parts and damage in transit, while in the other (the thermal system) technical problems prevented the pump from running for periods long enough for its performance to be determined (though these defects were of a kind which, given time, should be solvable). Of the 10 PV systems from which data were obtained, one borehole pumping system performed almost faultlessly for the whole of the trial period. A number of problems afflicted

other PV systems including, for example, two systems with poor suction performance (even under high levels of irradiance), two systems with unreliable footvalves (leading to pumps being difficult to prime or running dry), two systems with wrong wiring or poor connections (leading to low power output from the arrays), one system with an impeller binding on the pump casing and two systems with unreliable electronics (leading to complete failure). Some faults were repaired in situ, while others required replacement parts. The problems involving poor suction and impeller binding were not resolved within the time scale of Phase I of the Project.

## 2.4 Conclusions from Field Trials

Table II indicates the principal results obtained from testing all the systems. The maximum instantaneous system efficiency (based on array area) recorded was just over 3%. However, most of the adequately reliable systems were typically 2% efficient and the poorer systems only returned optimum efficiencies of around 1%. Referenced to gross cell area, the maximum system efficiency was just over 4%. Clearly, there is considerable variability in efficiency between different systems, and since the efficiency dictates the size of array necessary for a given output, and array costs dominate, overall efficiency has a major effect on equivalent annual costs.

From an operational viewpoint, the main conclusion was that pumps have to be self-priming, that is, they must be able to start pumping without any need for operator intervention. Non-self priming pumps, if emptied of water due to, say, a leaking footvalve, cannot refill themselves and therefore will simply run dry, overheat and may suffer serious damage.

Wherever possible, centrifugal pumps should be of the immersed type and so dispense with troublesome and energy consuming footvalves. If surface-mounted self-priming centrifugal suction pumps have to be used, care should also be taken to see that the suction head remains moderate.

Numerous relatively minor problems were experienced with many of the systems; for example:

- o incorrect wiring supplied
- o terminals that did not readily give good electrical connection
- o failure of electronic circuitry (due either to overheating or to overload)
- o possibility of safety hazard due to dangerous dc voltages
- o broken module cover glasses (both in transit and on site)
- o suction pipework trapping air in cavities
- o footvalves jamming or leaking
- o inadequate packing for shipping

It was felt, however, that these problems were not fundamental to the technology and can be overcome during the normal course of development as the technology matures. Certainly, the systems have the potential for reliable operation with minimum maintenance. Regular maintenance jobs should be minimized and made easy to carry out.



### 3. LABORATORY TESTS

#### 3.1 Objectives

The main objectives of the laboratory testing programme were:

- (1) To determine independently the true performance characteristics of selected solar pumping subsystems and components under controlled conditions at full and part-load.
- (2) To provide data for the system design studies to enable improved solar pumping systems to be developed.
- (3) To help identify the causes of good or bad field-tested system performance.
- (4) To provide limited indications of the basic reliability and durability of certain components.

Generally, the component testing programme was designed to investigate performance (i.e., output and efficiency characteristics) rather than reliability or quality. Hence, single items were tested in the case of PV sub systems (motors and pumps) and of thermal systems, but for the reasons given below, five examples of each selected PV module were tested.

The testing programme breaks down into three principal areas of investigation: PV modules, PV subsystems (motor and pump) and thermal systems.

#### 3.2 PV Modules

The choice of PV modules was limited to those which had not been independently tested and publicly reported and which displayed interesting features - technical (e.g. high packing density for cells), commercial (e.g. low cost) or others, such as a product made in India which was indicative of what might readily be manufactured in a developing country. All cells were of the mono-crystalline silicon type. Since these are particularly expensive components which are required to be durable, robust and long-lasting, five examples of each module were purchased for a more detailed investigation of quality and performance. Details of products tested are given in Table III.

The modules were performance tested independently by the Royal Aircraft Establishment (RAE) in the U.K. and by the Jet Propulsion Laboratory (JPL) in the U.S.A. RAE carried out performance tests and ultra-violet accelerated ageing tests and JPL carried out their standard performance and durability testing (a routine generally applied by JPL for the US Department of Energy to most American PV modules). Both testing organizations carried out visual inspections and reported on the condition of the modules before and after testing. The results obtained by each of the organizations for the maximum power output of the same module were very close (average value differed by 0.5%).

### 3.3 PV Subsystems

The University of Reading in the UK tested pump and motor units from all the PV systems purchased for testing in the field. In addition a selection of four further pumps and two motors were tested. The extra pumps were chosen as representing generic types of pump not otherwise included in the programme but of possible interest for the future design of pumping systems. These included a free-diaphragm pump, a rotary screw (or progressive cavity) pump, a piston pump and a self-priming centrifugal pump. The extra motors included a high efficiency industrial permanent magnet dc motor, similar to those used on most of the subsystems, and a reciprocating linear actuator. Details are given in Table III.

The main requirement of this testing programme was to obtain performance data vital for the system design study over a wide range of full and part-load conditions and typical of those existing in solar pumping applications. Components were also visually inspected after testing to determine their general quality and suitability for inclusion in small-scale irrigation pumping systems.

### 3.4 Thermal Systems

Virtually all thermal systems were of prototype status - only one such system could be purchased for field trials and even this was not a mature product. The only system which could readily be transported for laboratory testing at the University of Reading was a *Stirling cycle solar pump*, under development in the USA. Hence the only generally practicable way to gain an insight into thermal system performance and potential was to witness testing at the manufacturers' own test facilities; hence arrangements were made for the Consultants' engineers to monitor tests of three systems under development in Israel, Germany and the U.S.A. Although other systems were known to be under development, it was only possible to make arrangements for those listed in Table III.

### 3.5 Conclusions of Laboratory Testing

The objectives of the laboratory testing programme were generally achieved, with reports of completed tests on all of the equipment.

#### Modules

The performances of the PV modules were consistently below their manufacturers' specifications, by from 2½% to 16½%. This has serious implications in view of their high cost (\$10 to \$20 per peak Watt) and because accurate performance knowledge is necessary for good system design. Cell efficiency varied by over 20% between the best and worst products tested.

Although only one PV module actually failed under the durability testing programme, all products displayed minor flaws or design faults and one or two had potentially serious shortcomings.

Although it is considered that the levels of efficiency (10%+), high quality and long life often claimed for PV arrays in the technical press and in manufacturers' literature are obtainable, such a standard of performance of most currently available products cannot be taken for granted at present.

## Motors

The dc motors tested were all permanent magnet machines\* of generally high efficiency. Nevertheless a spread of about 15% in optimum efficiency (75 to 87%) was found between the best and the worst performers. This difference can be worth more than the total cost of a motor in terms of extra array costs (at present day prices). Clearly, PV solar pumping systems should use motors of better than 85% optimum efficiency, so long as the cost of PV arrays is dominant.

## Pumps

Considerable variability in pump performance was revealed. The best centrifugal pumps were over 50% efficient under optimum operating conditions, while many were only 30 to 40% efficient. A few were less than 20% efficient. It is clear that the choice of pump can be perhaps the single most influential factor in good small-scale solar PV pumping system design. From the system design studies it was found that overall system efficiencies for systems using centrifugal pumps were sensitive to head variation, and it is clearly important to seek pumps whose drop in efficiency when operating away from their optimum head is as small as possible. This objective will help to maintain acceptable performance for situations where the actual head does not coincide with the optimum for the pump or where the head varies either seasonally or due to well draw-down.

Nevertheless, centrifugal pumps appear to be the most promising type of pump for the low head applications ( $< 10\text{m}$  head) demanded for irrigation, although self-priming capability is essential for practical field use. Positive displacement piston pumps offer good performance (better than 50%) at higher heads ( $> 10\text{m}$ ). They are also relatively insensitive to variations in head or to operating off their optimum head.

## Thermal Systems

The performance of the Stirling engine pumping system was disappointing and it failed mechanically partway through the test series. The other systems, all Rankine cycle using Freon type working fluids, performed in line with our expectations and gave overall efficiencies of between 1% and 2%. Examples seem some distance from commercial viability (with the possible exception of the system purchased for field testing), but our system studies showed that this technology could be competitive with PV systems, given suitable development and high volume production.

The system design studies showed that thermal systems would be likely to improve in both efficiency and in cost-effectiveness if tracking concentrating collectors were used instead of the fixed flat plate collectors of the Rankine cycle systems so far tested. Consideration would need to be given to the maintenance requirements which this would impose.

---

\* One was of the brushless electronically commutated type

## 4. SYSTEM DESIGN STUDIES

### 4.1 Objectives

The purpose of the system design studies was to investigate whether, and in what ways, small-scale solar pumping systems might be improved for irrigation purposes and to see whether the specification of an improved system could be developed. This was achieved by examining the cost-effectiveness of a number of technically feasible system options under a variety of operating conditions. For all systems, computer-based mathematical modelling techniques were used to simulate the performance and cost of the main components of both PV and thermal systems.

### 4.2 Models

The PV systems model was developed using data from the laboratory testing programme, validated by comparison with the field performance data obtained for complete systems. Factors that were investigated are listed in Table IV. A special parameter, the Specific Capital Cost (the capital cost per unit energy output per day in US \$ per kJ) was used to assess the cost-effectiveness of the alternative system options examined. For this purpose "normalized" costs were used to give a measure of the capital cost of a different systems, excluding arbitrary factors which may influence the price of individual items.

A simple thermal system model was also produced to investigate the general merits of different thermal system concepts (i.e., the use of different types of solar collector, thermal cycle, working fluid and expander). The Specific Capital Cost was also used to express and compare the cost-effectiveness of thermal systems.

Finally, a simple economic model for PV systems was constructed to investigate the sensitivity of typical PV solar systems to variations in selected economic and technical parameters (discount rate, life, differential movement in real prices) and to compare solar pumping system costs with those of small engine-powered pumping systems. The model calculated the present value of the various cash flow streams. This work is reported in detail in the separate "Technical and Economic Review" volume.

### 4.3 Conclusions

#### PV Systems

Significant performance and cost-reducing improvements appear to be readily obtainable with PV systems at the existing level of technology developed from those tested under the programme so far. In particular overall efficiency can be improved by:

- o the use of pumps whose efficiency change with head over the likely working head range is as small as possible.
- o optimisation of the proportion of PV cells that were connected in parallel and series within the module. (One system supplied was almost perfectly optimised, but with another an improvement of 13% in overall system efficiency could be achieved).

- o varying the array power to find the optimum value: in one case the Specific Capital Cost dropped by 19% when the array power was increased by 60%, due to a substantial increase in output and efficiency.
- o the use of a Maximum Power Point Tracker (MPPT)\*. This was investigated and may have little or no benefit on well-matched systems but would be expected to improve less well-matched systems under varying climatic and head conditions. Pumped daily water output was increased typically by 15% on a clear day and by 25% on a hazy day through the use of a MPPT.
- o using movable or tracking PV arrays. The increase in output obtained by a perfectly tracked array (over a fixed array) was compared with the increases obtained by arrays reoriented to preset positions once, twice or three times in a day and reset in the evening. It was found that re-orientation twice daily allows the use of 95% of the energy received by a continuously tracked array. It is doubtful therefore whether the extra cost and complication of a continuously tracking system can be justified for applications such as irrigation.
- o care in specifying pipework for systems. The pipework necessary to connect the pump with the source and to deliver water to the point of application is a simple, but vitally important, part of the solar pumping system. The Specific Capital Cost was minimized for the particular conditions of the tests: it is unlikely that a pipe diameter less than 50 mm should ever be used. The use of inadequate pipe diameters can dramatically reduce the system efficiency and increase the Specific Capital Cost.

The combined result of a number of these improvements for one system is shown in Table V.

In general, the Consultants consider it is feasible to produce small-scale solar pumping systems having overall instantaneous system efficiencies above 4% (some of the systems tested were only around 2% efficient). Specific Capital Costs of around \$2.5 kJ\*\* per day should be possible (at present day prices with current technology) compared to a range of \$3.1 to \$9.8 obtained from model tests on the systems purchased. If PV array prices fall to about 50% of their current lowest level (i.e. reach \$4/W peak) then the Specific Capital Cost of \$2.5/kJ per day will reduce to about \$1.0 yielding water at about one third the cost of the most cost-efficient systems currently available.

### Thermal Systems

Data on thermal systems were restricted in scope and quality compared with the PV data, but nevertheless clear conclusions emerged from the studies which analysed over 30 different system options. The principal one is that high temperature

\* A Maximum Power Point Tracker (MPPT) is an electronic control device which continuously adjusts the array voltages to an optimum value to maximise the power output from the array. Its main benefit is increased system efficiency and output, but it also consumes a proportion of the power produced by the array and it can be an expensive component adding significantly to system first costs.

\*\* The unit kilojoule has been used because it is a basic SI unit of energy and because it gives convenient dollar numbers. There are 3600 kJ in one kWh.

thermal systems using concentrating collectors appear to be significantly more cost-effective than low temperature flat plate collector systems, mainly on account of the much smaller collector areas required to yield a given output.

The least cost-effective approach appears to be precisely the one favoured by most current manufacturers (fixed flat plate collectors); the indications are that a system using a linear-focussing equatorially-tracking collector would be about 30 to 40% less expensive, while even higher concentration through the use of a power tower or point focus two-axis tracking collector could result in some slight further improvement in cost effectiveness. Some uncertainties lie in the assumptions concerning the likely costs of tracking mechanisms, but the results are nevertheless significant enough to justify serious study of the use of concentrating and tracking thermal concentrators, and the more complex maintenance requirements this would impose.

Specific Capital Cost analysis on small thermal systems gave \$2.8/kJ per day for a typical flat plate collector system (similar to the one tested) and \$ 1.5 for a Freon vapour Rankine cycle engine with a one-axis tracking parabolic trough (line focus) collector: these costs appear to be competitive with PV systems. Thus it would be premature to dismiss thermal systems at this stage.

## 5. RECOMMENDATIONS

### 5.1 General

- o Solar pumping for irrigation is most suitable on small farms where low lift pumping is needed, where high value crops are grown and where the demand for irrigation is regular over much of the year.
- o Solar pumping should be considered in future phases of these studies for water supply applications as well as for irrigation.

### 5.2 Technical Development

- o Present field trial programmes should be continued wherever feasible
- o The conclusions of this Report should be implemented with a view to producing improved PV systems. This may be done by specifying various improved systems with the desirable technical features so far identified, and ordering examples from suppliers capable of demonstrating a competence to respond to a call for tenders.
- o The systems produced in this way should then be laboratory tested, prior to any further field testing, to confirm that they achieve specification and to identify any further shortcomings.
- o Following satisfactory laboratory tests, such systems may subsequently be field tested.

- o Further design studies, supported by continued field testing of the more successful systems so far installed in the field should be carried out to investigate further possible areas of improvement and to improve the data base.
- o The development of small-scale thermal systems with concentrating and tracking collectors appears to be fruitful and should be encouraged.
- o A review should be made of any worthwhile improvements which may be worth considering to individual components of PV systems. Specification for manufacture should be prepared and tenders invited.
- o Desk studies of the detailed requirements for local manufacture or assembly should be initiated to be followed up, if possible, by case studies.

### 5.3 Institutional Arrangements

Countries to be involved in field testing programmes should be able to satisfy a number of criteria, the most important being:

- o The existence of important pumping needs for irrigation and water supply in rural areas that could be met by solar powered pumping systems and which would require a range of pump output power suitable for solar systems.
- o The presence of a suitable solar energy resource and the absence of any more readily exploitable alternatives.
- o Government interest in solar pumping and a willingness and ability of host country institutions to provide the necessary technical and logistical support for the reliable field monitoring of the systems.

Country	Location	Water Source	Water Use	Total Head (m)	Supplier	Equipment Type	Cost c.i.f. (\$)	Approximate Rating		Date (1) first operated	No. of days on which data recorded	Remarks		
								Peak flow (l/s)	Peak Hydraulic Power(W)					
Mali	Bahugou	Open well	Supply to students hostel	10.0	Briau	PV	14,065	0.3 (at 10m head)	27	315	19 Jul 80	3	83	Under care of FAO. Some data missed because of battery discharge
	Korofina	Open well	Market Garden	3.0-7.0	Photowatt	PV	14,219	1.5 (at 6m head)	90	275	25 Sep 80	1	0	Under care of laboratory. Difficulty in getting system to work limited data collected
	Yangasso	Borehole	Village water supply	20.0	Pompes Guinard	PV	n/a	2.7	540	1300	Already in operation	3	149	Under care of Mali Aqua Viva Availability for monitoring maximum possible.
	Banankoro and Solar Lab.	Open Well	None	2.0-4.0	SEI	PV Portable	8,625	2.3	115	250	15 Jul 80	3	0	Initial electronic failures limited data collected. Had to be moved to laboratory.
Philippines	Talaksan San Raphael	Small Canal	Rice Irrigation	5.0	Briau	PV	22,094	2.0	100	600	11 Jul 80	30	139	Good quality of data collected despite foot valve problems.
	Talampas Sapang Palay	Stilling Pool	Rice Irrigation	5.0	Omera-Segud	PV	16,417	1.0	50	200	13 Jun 80	23	159	Quality of data affected by poor weather and shading of array.
	Talampas Sapang Palay	River	Rice Irrigation	12.0	Pompes Guinard	PV	17,450	1.0	120	600	13 Jun 80	4	30	Problems with pump priming limited data collected.
	Center for Non-Conventional Energy Development	Tank		2.0-5.0	SEI	PV Portable	8,625	2.3 (at 5m head)	115	250	20 Sep 80	6	0	Initial electronic failures limited data collected. Had to be moved to laboratory.
Sudan	Butri	Open well	Orchard & Field crops	9.5-18.0	Arco Solar	PV	5,063	1.0 (at 15m head)	150	530	24 Jun 80	32	177	Availability for monitoring maximum possible.
	Butri	Open well		4.9-11.0	Intertechnology Solar Corp	PV	22,462	1.0 (at 8.0m head)	80	530	26 Jul 80	6	0	Mechanical problems with pump operation. Limited data collected.
	Soba	Borehole		20.0	Solar Pump Corp.	Thermal	7,500	0.8 (at 15m head)	120	Collector Area 5.1m <sup>2</sup>	13 Jan 81	0	0	Delay in installation and difficulty in operating system. Limited data collected.
	Butri	Open Well		9.5-11.0	Soteren	PV Tracking	30,475	1.0 (at 8m head)	80	480	not yet run	0	0	Delays in installation prevented completion of system.

(1) Monitoring did not commence on these dates

TABLE 1 FIELD TRIALS -- SITES, SYSTEMS, COSTS AND DATA COLLECTED



Country	System (Type of Pump)	Array Rated Power	Average Peak Power measured @ 1000 W/m <sup>2</sup> Solar Irrad.	Optimum Head (See Note 1)	Actual Operating Head	Average Peak Hydraulic Power Measured @ 1000 W/m <sup>2</sup> Solar Irrad	Approx Start Up Solar Irrad	Average Measured Max. Efficiency	Average Daily (Efficiency (Note 3) (Note 6))	Average Daily Water Output (Note 5) (See Note 3)	Max Temp Increment of Array Measured	Remarks		
	Name	W	W	m	m	W	W/m <sup>2</sup>	System (Note 6) % @ W/m <sup>2</sup>	Sub-System (Note 5) %	Cells Array %	%	%	°C @ W/m <sup>2</sup>	
Mali	BRIAU (DUVA) (Piston Pump)	316	196	20+	3.6 to 10.9	28	608	0.8 to 800	1.3 @ 800	14	9.0	5.6	7.3 @ 800	No major problems with system. Start up achieved significantly earlier by alteration on site of series/parallel configuration.
	PFOTOWATT (Surface centrifugal)	275	146	6	3.2 to 3.7	31	800	1.0 @ 900	1.5 @ 900	21	7.3	4.8	Insuff. Data	Severe problems with priming. System would only work at high irradiance and then not consistently.
	POMPES GUINARD (Borehole centrifugal)	1260	807	-	14 to 20	307	220	2.2 @ 720	3.4 @ 720	39	9.2	5.9	31 @ 890	System ran without fault.
	SEI (Submersible Unit)	250	202	5	2.6 to 5.3	90	200 to 300	3.1 @ 1000	4.0 @ 1000	45	8.9	6.9	Insuff. Data	Electronic failures marred otherwise promising performance.
Philippines	BRIAU (Suction centrifugal)	600	410	6	3.7 to 5.0	102	350 to 400	1.4 @ 830	2.4 @ 830	26	9.5	5.6	35 @ 970	Foot valve problems caused dry running and gland failures otherwise generally satisfactory.
	OMERA SEGID (Suction centrifugal)	200	151	5	4.1 to 4.8	47	390	1.8 @ 840	2.9 @ 840	32	10.2	6.4	5.5 @ 970	Performance improved after module wiring corrected. Low value for daily efficiencies because array partly shaded.
	POMPES GUINARD (Suction centrifugal)	600	422	10	10.2 to 11.0	114	800	1.9 @ 1000	2.3 @ 1000	27	8.9	7.5	Insuff. Data	Suction head near to practical limit made priming and operation very difficult.
	SEI (Submersible unit)	250	240	5	4.5	81	200 to 300	2.8 @ 915	3.6 @ 915	34	10.5	8.2	Insuff. Data	Tests under optimum head conditions at laboratory confirmed good performance after electronics corrected.
Sudan	ARCO SOLAR (Suction centrifugal)	530	505	9+	9.3 to 16.8	161	350	2.7 @ 1000	3.5 @ 1000	32	11.0	8.5	20 @ 870	Ran almost without fault. Ran dry on one occasion and caused temporary overheating.
	INTER TECHNOLOGY CORP (Regenerative pump)	530	470	7	Up to 11.9	113	400	1.9 @ 1000	2.5 @ 1000	24	10.6	8.2	Insuff. Data	Impeller binding gave trouble throughout period of trial and prevented consistent running.
	SOLAR PUMP CORP (Thermal system)	5.1m <sup>2</sup>	-	Vari-able	18	30 (prelim)	-	-	-	-	-	-	-	Continuous operation not achieved because commissioning problems not overcome.
	SOTEREM (Piston pump)	480	-	10	-	-	-	-	-	-	-	-	-	Components lost or broken and complete installation impossible. Tracking mechanism worked well under test.

NOTES 1. from laboratory tests  
2. including max power point tracker losses  
3. at 6 kWh/m<sup>2</sup> (21.6MJ/m<sup>2</sup>) array solar irradiation  
4. at 4.3 kWh/m<sup>2</sup> (15.3MJ/m<sup>2</sup>) array solar irradiation (insufficient data for 6kWh/m<sup>2</sup>)  
5. referenced to gross cell area  
6. referenced to overall array area.

TABLE II SUMMARY OF SYSTEM, FIELD PERFORMANCES

Supplier	Manufacturer	Country of Origin (Supplier)	Model or Type and Specification	Cost(FOB)		Site of Complete System
				£	\$	
<b>1. PV MODULES</b>						
Arco Solar	Arco Solar	USA	Model 16-2300, 37 Watts nominal maximum power (one module)	144	330	.
CEL	CEL	India	PM621 7.6 Watts nominal maximum power (one module)	147	247	.
RTC	RTC	France	Model BPX47C, 33 Watts nominal maximum power (one module)	565	1300	.
Solarex	Solarex	USA	Model HES1 JG, 34 Watts nominal maximum power (one module)	380	874	.
<b>2. PV SUB-SYSTEM</b>						
Arco Solar	Mavlor motor Sta-rite pump	USA	Pmdc, model no M0300, 400 Watts rated power, 54 Volts nominal voltage Centrifugal, model J	481	1112	Sudan
Briau	Brot motor Briau pump	France	Pmdc, 450 Watts rated power, 48 Volts nominal voltage Piston, model DUVA 20	987	2270	Mali
Briau	Brot motor Briau pump	France	Pmdc, 240 Watts rated power, 48 Volts nominal voltage Centrifugal, model MG V.40.1	999	2298	Philippines
ITC/ Solar Corp.	Applied Motors motor Roth pump	USA	Pmdc, 480 Watts rated power, 24 Volts nominal voltage Regenerative, model V-140	391	883	Sudan
Omera Segid	Brot motor Essa-Mico pump	France	Pmdc, 190 Watts rated power, 52 Volts minimum voltage Centrifugal	1795	4129	Philippines
Photowatt	Brot motor Brequet pump	France	Pmdc, 190 Watts rated power, 52 Volts minimum voltage Centrifugal, model KSB	1975	4543	Mali
Pompes Guinard	Leroy-Somer motor Pompes Guinard pump	France	Pmdc, 370 Watts rated power, 31 Volts minimum voltage Centrifugal, model AJta X 600/12	1018	2341	Philippines
Soterem	CEM motor Salmson pump	France	Pmdc, 345 Watts rated power, 61 Volts minimum voltage Piston, model PE-99083	473	1088	Sudan
SEI	AEG motor KSB pump	USA	Brushless, 200 Watts rated power Centrifugal, model M	600	1380	Mali and Philippines
<b>3. INDIVIDUAL MOTORS</b>						
SEM	SEM	UK	Permanent magnet dc, 370 Watts rated power	155	357	.
Selwood	Selwood	UK	Permanent magnet dc	240	552	.
Hitachi Metals	Hitachi Metals	Japan	Reciprocating actuator	63	140	.
<b>4. INDIVIDUAL PUMPS</b>						
Godwin	Godwin	UK	Self-priming, centrifugal Cobra pump	Free	Loan	.
Godwin	Godwin	UK	Piston pump with hand wheel	Free	Loan	.
Mono	Mono	UK	Monolift progressive cavity pump model C32 B620	913	2100	.
Selwood	Selwood	UK	2 inch diaphragm, model Mk 4 simplite	683	1571	.
<b>5. THERMAL SYSTEMS</b>						
.	Dornier	W. Germany	Complete pumping system with Freon engine being developed in association with BHEL (India)	.	.	Tested at Works
.	Ormat	Israel	Skw energy converter with Freon turbine Generator	.	.	Tested at Works
.	Solar Pump Corp.	USA	Complete pumping system with Freon engine, as supplied for field trials in Sudan	.	.	Tested at Works
.	Sunpower Inc.	USA	Stirling engine (free piston) and diaphragm pump	.	.	Tested at University of Reading

Pm = Permanent Magnet

TABLE III LABORATORY TESTED SYSTEMS AND COMPONENTS

Factor Investigated	Outline Description
1. Static head variation	Investigate effect of changing static head from 2.5m to 10.0m (all 9 reference systems).
2. Solar day variation	Insolation data for a typical hazy day substituted for clear reference day data (all 9 systems).
3. PV array optimization	Array nominal voltage varied keeping power constant to find optimum voltage. Voltage then held constant at optimum value and power varied to find optimum power (all 9 systems).
4. Impedance matching	The use of a perfect array maximum power point tracker, first with zero losses and then with 10% of output power losses. Also crude impedance matching by series parallel switching at certain times of the day (three systems only).
5. Sun tracking	The effect of continuous sun tracking by the array was compared to manual tracking with one, two or three array movements per day (at "correct" and at "incorrect" times of day), (three systems only).
6. Pipework variation	The effect of changing system losses by increasing or decreasing delivery pipe length and diameter (two systems only).
7. Cost sensitivity	The effect of changing the array cost relative to the balance of system .

N B. The effect of the changes investigated was assessed in terms of the daily pumped output and Specific Capital Cost. The mathematical model built as part of the system design studies was used for this work.

**TABLE IV- SENSITIVITY ANALYSIS OF PV PUMPING SYSTEMS**

MODIFICATION	Effective <sup>(1)</sup> Overall efficiency (%)	Specific Capital Cost (\$ / kJ per day)	Daily output at 5m head (standard clear day (m <sup>3</sup> ))	Effect compared with basic system	
				Volume pumped	Spec Cap Cost
None - System as supplied	2.2	3.4	44.9	1.00	1.00
Voltage and power optimized by changing array cells series/parallel arrangement	2.6	3.0	46.6	(2)	0.88
MPPT (10% losses) (Maximum Power Point tracker)	2.5	3.1	51.2	1.14	0.91
Manual tracking of sun (2-adjustments of array position per day)	2.9	2.6	57.7	1.30	0.94
Voltage and power optimized plus manual tracking	3.3	2.3	60.3	(2)	0.68
MPPT plus manual sun tracking	3.1	2.5	62.3	1.39	0.74

Notes : (1) based on irradiation on fixed array.

(2) power is reduced and so pumped volume is not comparable with basic system

**TABLE V - RESULTS OF MAKING 'IMPROVEMENTS' TO A PV PUMPING SYSTEM BY USING THE MATHEMATICAL SIMULATION MODEL**

**APPENDIX 4**

**Objectives of and Preparation for Phase II of the Project**

**APPENDIX 4****OBJECTIVES OF AND PREPARATION FOR PHASE II OF THE PROJECT\***

The next phase of the Project, Phase II preparation, provides a period in which to reflect on the results obtained from Phase I, to confirm the objectives of Phase II, and to make the necessary preparations for it.

The Consultants think it important to use this period to review the applications, economics and system sizes of solar pumps. As far as applications are concerned, it will be necessary to review the conditions under which solar pumps will be suitable for irrigation purposes and to evaluate in detail the potentially more attractive water supply application. The economic criteria to be satisfied by the pumps will need to be examined in more detail and the relative economic merits of other lifting devices will need to be assessed, so that solar pumps are only demonstrated where there are good prospects for their technical and economic viability. It will also be necessary to study and define the pumping requirements (head, flow and pattern of consumption) in order to build up a profile of market requirements for each application.

The main areas of technical development should be as follows:—

- o Present field trial programmes should be continued wherever feasible.
- o The conclusions of this Report should be implemented with a view to producing improved PV systems. This may be done by specifying various improved systems with the desirable technical features so far identified, and ordering examples from suppliers capable of demonstrating a competence to respond to a call for tenders.
- o The systems produced in this way should then be laboratory tested, prior to any further field testing, to confirm that they achieve specification and to identify any further shortcomings.
- o Following satisfactory laboratory tests, such systems may subsequently be field tested.
- o Further design studies, supported by continued field testing of the more successful systems so far installed in the field, should be carried out to investigate further possible areas of improvement and to improve the data base.
- o The development of small-scale thermal systems with concentrating and tracking collectors appears to be fruitful and should be encouraged.
- o A review should be made of any worthwhile improvements which may be worth considering to individual components of PV systems. Specification for manufacture may then be prepared and tenders invited.
- o Desk studies of the detailed requirements for local manufacture or assembly should be initiated to be followed up, if possible, by case studies.

\* A copy of chapter 12 'Future Work' from the Project Report

Visits need to be made to potential Phase II host countries to explain the Project and explore the possibilities for their future involvement. The countries to be involved need to satisfy a number of criteria the most important being:

- o The existence of important pumping needs for irrigation and water supply in rural areas that could be met by solar-powered pumping systems and which would require a range of pump output power suitable for solar systems.
- o The presence of a suitable solar energy resource and the absence of any more readily exploitable alternatives.
- o Government interest in solar pumping and a willingness and ability of host country institutions to provide the necessary technical and logistical support for the reliable field monitoring of the systems.

Additional visits will be made to select field trial sites for Phase II and to agree and brief the participating institutions.

The final objective of Phase II is seen as the development of solar pumping systems to the stage there they will be suitable for pilot manufacture or assembly in developing countries.