

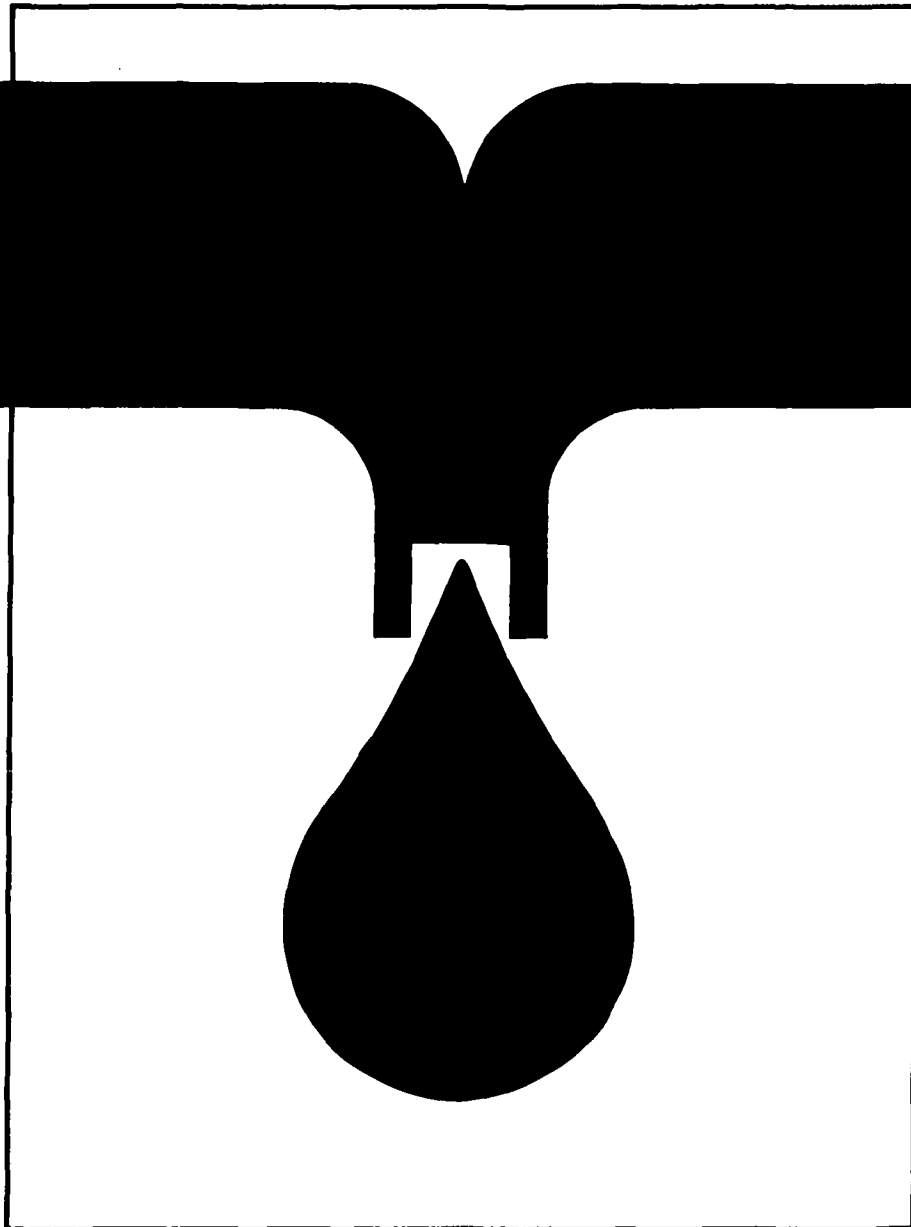

TRAINING MODULES FOR WATERWORKS PERSONNEL



Basic Knowledge

0.2

Basic concepts of physics

262.0-8132 99

8132
262.0 87TR(1)

Foreword

Even the greatest optimists are no longer sure that the goals of the UN "International Drinking Water Supply and Sanitation Decade", set in 1977 in Mar del Plata, can be achieved by 1990. High population growth in the Third World combined with stagnating financial and personnel resources have led to modifications to the strategies in cooperation with developing countries. A reorientation process has commenced which can be characterized by the following catchwords:

- use of appropriate, simple and – if possible – low-cost technologies,
- lowering of excessively high water-supply and disposal standards,
- priority to optimal operation and maintenance, rather than new investments,
- emphasis on institution-building and human resources development.

Our training modules are an effort to translate the last two strategies into practice. Experience has shown that a standardized training system for waterworks personnel in developing countries does not meet our partners' varying individual needs. But to prepare specific documents for each new project or compile them anew from existing materials on hand cannot be justified from the economic viewpoint. We have therefore opted for a flexible system of training modules which can be combined to suit the situation and needs of the target group in each case, and thus put existing personnel in a position to optimally maintain and operate the plant.

The modules will primarily be used as guidelines and basic training aids by GTZ staff and GTZ consultants in institution-building and operation and maintenance projects. In the medium term, however, they could be used by local instructors, trainers, plant managers and operating personnel in their daily work, as check lists and working instructions.

45 modules are presently available, each covering subject-specific knowledge and skills required in individual areas of waterworks operations, preventive maintenance and repair. Different combinations of modules will be required for classroom work, exercises, and practical application, to suit in each case the type of project, size of plant and the previous qualifications and practical experience of potential users.

Practical day-to-day use will of course generate hints on how to supplement or modify the texts. In other words: this edition is by no means a finalized version. We hope to receive your critical comments on the modules so that they can be optimized over the course of time.

Our grateful thanks are due to

Prof. Dr.-Ing. H. P. Haug
and
Ing.-Grad. H. Hack

for their committed coordination work and also to the following co-authors
for preparing the modules:

Dipl.-Ing. Beyene Wolde Gabriel
Ing.-Grad. K. H. Engel
Ing.-Grad. H. Hack
Ing.-Grad. H. Hauser
Dipl.-Ing. H. R. Jolowicz
K. Ph. Müller-Oswald
Ing.-Grad. B. Rollmann
Dipl.-Ing. K. Schnabel
Dr. W. Schneider

It is my sincere wish that these training modules will be put to successful use and will thus support world-wide efforts in improving water supply and raising living standards.

Dr. Ing. Klaus Erbel
Head of Division
Hydraulic Engineering,
Water Resources Development
Eschborn, May 1987



Title:	Page
<u>1 International system of units (SI)</u>	3
1.1 General points on linear measurement	3
1.2 Measurement of time	4
1.3. Measurement of speed	5
<u>2. Forces and their measurement</u>	6
2.1 Action of forces	6
2.2 The unit of force	7
2.3 Hooke's law and the measurement of force	7
2.4 Force as a vector quantity	9
2.5 Forces of friction - laws of friction	11
<u>3 Mass - weight - density</u>	14
3.1 Measurement of mass	14
3.2 Variability of weight	15
3.3. Density	16
3.4 Measurement of density	16
<u>4 Pressure</u>	17
4.1 Pressure and pressure transmission in liquids and gases	18
4.2 Action of forces on the surfaces of liquids	18
4.3 Pressure in enclosed liquids Hydraulic transmission of force	19
4.4 Pressure in open liquids	21
4.5 Upthrust in liquids	24
4.6 Sinking, suspension and flotation of bodies	25



4.7	Communicating vessels	26
4.8	Atmospheric pressure	27
4.9	Measurement of atmospheric pressure	28
4.10	Excess pressure - negative pressure - absolute pressure	29
5	<u>Types of mechanical energy</u>	30
5.1	Mechanical work	30
5.2	Work and energy	31
5.3	Mechanical power	33
6.	<u>Electric current</u>	34
6.1	Voltage - current - resistance	34
6.2	Dangers of electricity	40

Basic concepts of physics

Physics is concerned with the properties and behaviour of non-living matter. It is the task of physics to observe and measure processes in nature and to summarize the results of these observations and measurements as generally applicable laws. The physical relationships determined in this way are expressed as equations, or formulae.

For example: distance = speed x time

$$s = v \times t$$

To obtain results which are directly comparable with each other, it is necessary to use a system of basic units with universally accepted definitions.

1 International System of Units (SI)

Unit of length: symbol (s), unit 1 metre (1 m)

Unit of mass: symbol (m), unit 1 kilogram (1 kg)

Unit of time: symbol (t), unit 1 second (1 s)

Unit of electric current: symbol (I), unit 1 ampere (1 A)

Unit of temperature: symbol (I), unit 1 kelbin (1 K)

Unit of luminous intensity: symbol (I_v), unit 1 candela (1 cd)

Certain prefixes are used to denote very large or very small magnitudes. Some of the most common of these are:

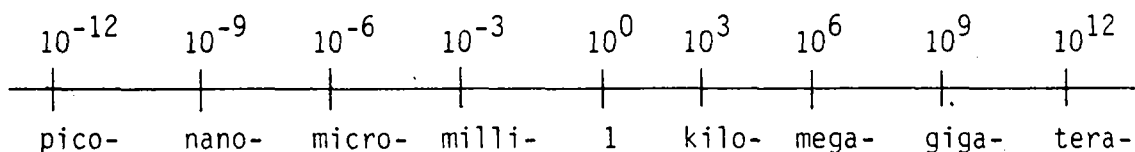

1.1 General point on linear measurement

Measuring a quantity means comparing it with a unit of known size.

Take a distance with a length of 5 m. This is written as

$$s = 5\text{m}$$

s (length) = physical quantity

5 (figure) = coefficient of measure

m. (metre) = unit of measurement

(cf. Module 01.5.2)

The general rule is: physical quantity = coefficient of
measure x unit of measurement.

1.2 Measurement of time

All natural processes require time. They begin at a certain point in time and proceed through a certain duration. To measure time we use clocks. In these, processes take place periodically, i.e. they repeat themselves with a certain rhythm. If the number of oscillations which have taken place is determined, this is a measurement of how many times the duration of an oscillation has gone by. In this way, a quantity has been found for the duration of a process which could be used as a unit of time. Whereas the unit of length can be represented as a body, time can only be determined by the duration of a process. Particularly suitable for the definition of a quantity of time are processes which repeat themselves cyclically in nature over long periods; e.g. the Earth's orbit round the Sun, or the rotation of the Earth round its axis. The unit of time, 1 second, has been determined as part of the measure of time which elapses between two successive zeniths of the Sun at the same place. This period of time is called 1 day. The Earth takes 1 year to complete its full orbit round the Sun. Because the length of the day varies throughout the year, an average has been taken of all the days and this is called the mean solar day.

Definition: The unit of time is the second. The second is the 86 400th part of a mean solar day.

$$1 \text{ day} = 24 \text{ hours} = 24 \times 60 \text{ minutes} = 24 \times 60 \times 60 \text{ seconds} \\ = 86\,400 \text{ seconds.}$$

The International System of Units (SI) has re-defined the second as follows:

The fundamental unit 1 second is the duration of 9 192 631 770 periods of the radiation corresponding to the transition between two hyperfine levels of the ground state of the caesium - 133 atom.

1.3. Measurement of speed

A motion is uniformly linear if this motion takes place at a steady speed and without changing direction. If motions such as this are to be described and compared, two quantities must be measured: the distance moved (i.e. length) and the time taken. With uniform motion, the quotient obtained from distance moved and time taken is constant and is called speed.

$$\text{Speed} = \frac{\text{distance moved}}{\text{time taken}} \quad v = \frac{s}{t}$$

Whereas length and time are defined fundamental quantities, speed is derived from these and is therefore known as a derived quantity. Fundamental quantities are measured in fundamental units and derived quantities in derived units. The derived unit for speed is thus $\frac{\text{m}}{\text{s}}$.

Through conversion, other units of speed can be obtained,

$$\text{e.g. } \frac{\text{m}}{\text{min}}, \frac{\text{km}}{\text{h}}, \frac{\text{cm}}{\text{s}}$$

Example: Convert $\frac{\text{m}}{\text{s}}$ into $\frac{\text{m}}{\text{min}}$, $\frac{\text{km}}{\text{h}}$ and $\frac{\text{cm}}{\text{s}}$.

$$\text{Answer: } \frac{\text{m}}{\cancel{\text{s}}} \times \frac{60 \cancel{\text{s}}}{\text{min}} = \frac{60\text{m}}{\text{min}}$$

$$\frac{\cancel{\text{m}}}{\cancel{\text{s}}} \times \frac{\text{km}}{1000\cancel{\text{m}}} \times \frac{3600 \cancel{\text{s}}}{\text{h}} = \frac{\text{km} \times 3600}{\text{h} \times 1000} = 3.6 \frac{\text{km}}{\text{h}}$$

$$\frac{\cancel{\text{m}}}{\cancel{\text{s}}} \times \frac{100 \text{ cm}}{\cancel{\text{m}}} = 100 \frac{\text{cm}}{\text{s}}$$

Explanation of conversion into other units, taking the example of $\frac{\text{m}}{\text{s}}$ to $\frac{\text{m}}{\text{min}}$.

Every number or unit may be multiplied any number of times by 1 without altering its value. If $\frac{\text{m}}{\text{s}}$ are multiplied by 1,

the result is still $\frac{\text{m}}{\text{s}}$. If the multiplicand is chosen so

that its value is 1, but it contains both the wanted unit and the unit to be converted, after simplification of the expression there remains the wanted unit with the appropriate conversion factor.

$$\frac{\text{m}}{\text{s}} \times \frac{60 \text{ s}}{\text{min}} = \frac{60 \text{ m}}{\text{min}}$$

60 seconds per minute = 1

2 Forces and their measurement

2.1 Action of forces

A force is described in terms of its action. Forces act in two different ways.

Example: Action of gravitational force.

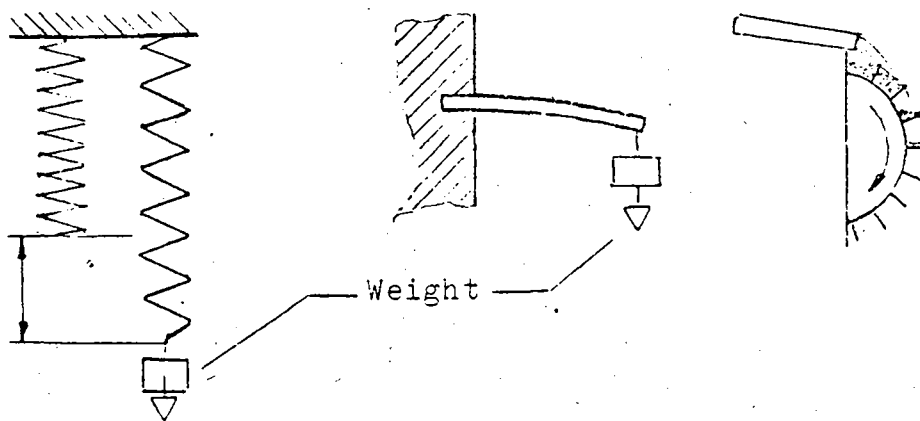

Here, gravitational force results in extension of the spiral spring, bending of the rod and in the motion of the water-wheel.

Forces alter a body's state of rest or state of motion.

This is equally true if it is not gravitational force which is the cause of the alteration; e.g. a magnet attracts a piece of steel (magnetic force) or a spring is tensed by hand (muscular force).

Three determining characteristics of force

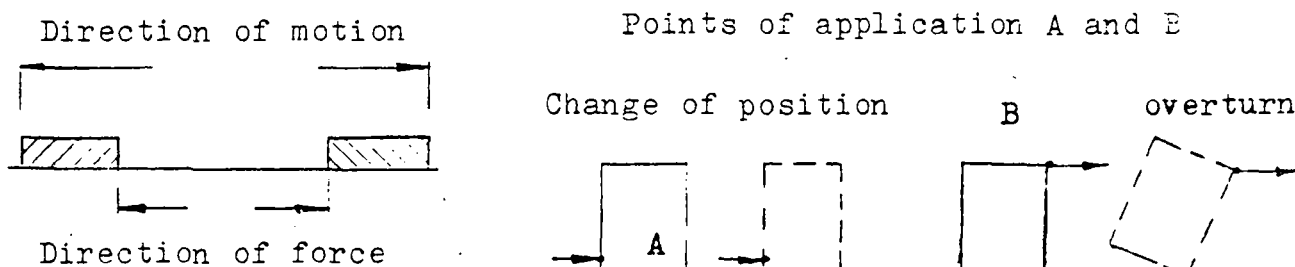

The action of a force depends on its magnitude, its direction and its point of application.

2.2 The unit of force

The unit of force is defined in terms of the alteration of a body's state of rest or motion, i.e. of acceleration or retardation. The symbol used for force as a physical quantity is F .

Example: $F = 10 \text{ N}$.

The derived unit of force, the newton, is the force required to give a mass of one kilogram an acceleration of one metre per second per second.

$$1 \text{ newton} = 1 \text{ kg} \times \frac{1 \frac{\text{m}}{\text{s}}}{\text{s}} \text{ or } 1 \frac{\text{kg m}}{\text{s}^2}$$

(Acceleration = the rate of change of speed with time.)

2.3 Hooke's law and the measurement of force

According to Hooke's law¹⁾, when a spring is fixed at one end and a force is applied to the other, the extension of the spring is proportional to the applied force.

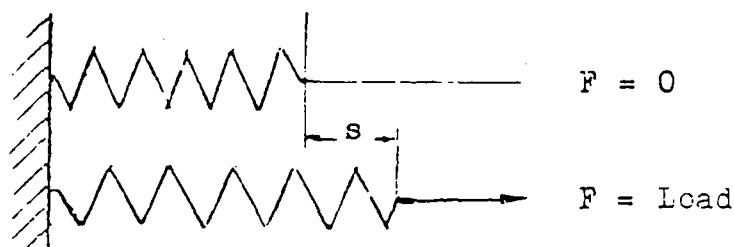

1) Robert Hooke: British physicist (1635 - 1703)

Extension s	0	0.02	0.04	0.06	0.08	metres.
F	0	0.05	1	1.5	2	N

The extension s is proportional to the load F .

If the measured extensions are plotted against the corresponding loads, the points can be joined by a straight line.

Force F in N

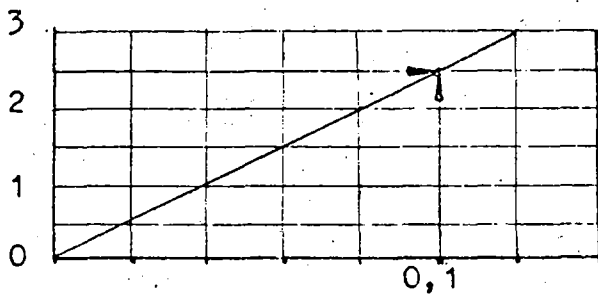

$$\frac{F}{s} = \frac{1}{0.04} = 25 \frac{\text{N}}{\text{m}}$$

$$\text{or } \frac{2}{0.08} = 25 \frac{\text{N}}{\text{m}}$$

Extension s in m

Force/extension graph

The product $\frac{F}{s}$ = constant has a different value for each spring. This is the spring constant D .

$\frac{\text{force}}{\text{extension}} = \text{spring constant}$

$$\frac{F}{s} = D$$

The unit of D is 1 N/m . Thus D indicates how many newtons would be necessary to extend the spring by 1 m . An extension of this magnitude is in practice seldom possible. The use of D is thus as a comparative quantity in the designation of springs. The calibration curves of stiffer springs are steeper in the F/s graph.

Limitation: Hooke's law applies only below the elastic limit; i.e. only up to the point where on removal of the load the spring fails to return to its original length. With this reservation, Hooke's law also applies to the deformation of any elastic body, e.g. to the increase in length of a steel rod on application of a not too great load.

Measurement of force: Hooke's law allows forces to be measured by reading off the extension of a calibrated spring from a scale. Spring balances are based on this principle.

2.4 Force as a vector quantity

To define the action of a force properly, not only its magnitude and point of application are required, but also its direction. Force is therefore a quantity which has direction as well as magnitude. In physics, such quantities, which can be represented by an arrow of a certain size, are called vectors.

Example: A force of 600 N is to be drawn, acting at a point A horizontally and towards the right.

Scale: 10 mm \cong 100 N¹⁾

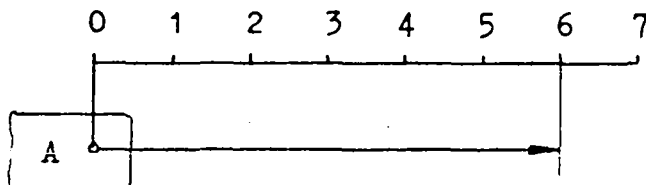

There are other vectors besides force, e.g. velocity. All vectors are added geometrically.

The method of determining the resultant force by drawing a parallelogram is called "geometric addition". Unlike algebraic addition, where numbers are simply added (e.g. $5 + 3 = 8$), in geometric addition the resultant may have numerous different values, depending on the size of the enclosed angle.

1) The sign \cong means "is equivalent to".

Parallelogram of forces

Two component forces making an angle of any size are exerted at a point A. The resultant is given in magnitude and direction by the diagonal of the parallelogram drawn from the intersection of the forces as sides.

Given: F_1, F_2, α

To be found: R, β

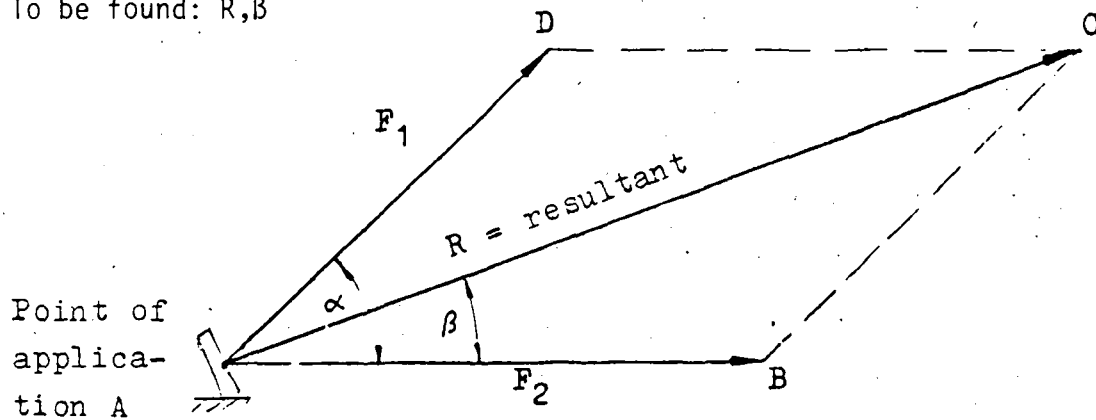

Example: Find the resultant, $F_1 = F_2 = 400$, for the following values.

Scale: 1 cm = 200 N

$R = 140$ N

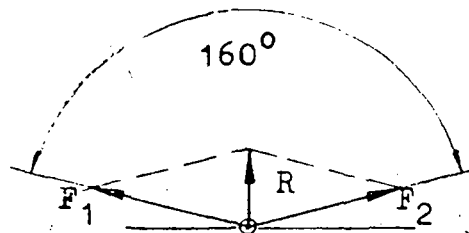

$R = 400$ N

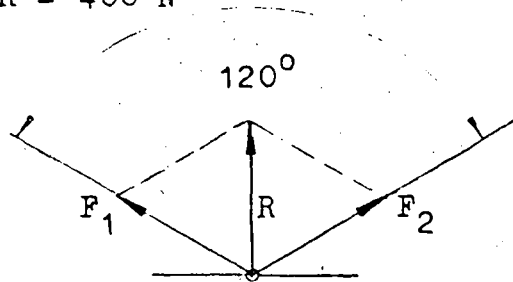

R has the same magnitude as F_1 and F_2

$R = 570$ N

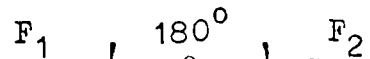
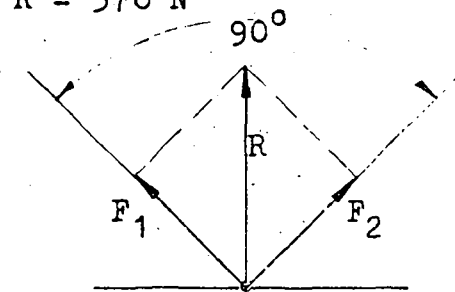

$R = 0$, (equilibrium)

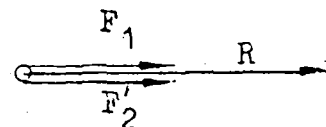

$\alpha = 0^\circ, R = F_1 + F_2 = 800$ N

This method of adding forces only produces the correct result if both forces are acting (pulling or pressing) at the point of application. Both forces must thus either be directed away from the point of application (traction forces) or towards it (compressive forces). If necessary, the direction of a force must be moved in such a way that both forces act on the point of application, in the same direction.

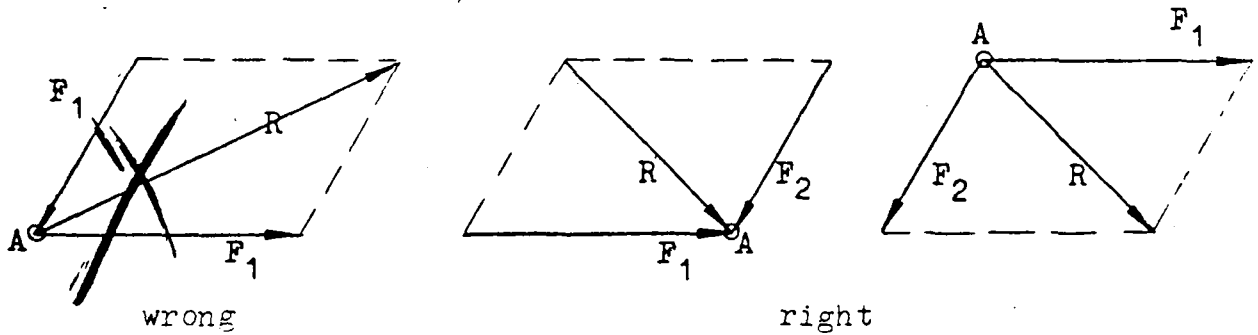

The resultant may be greater or smaller than each of the two components.

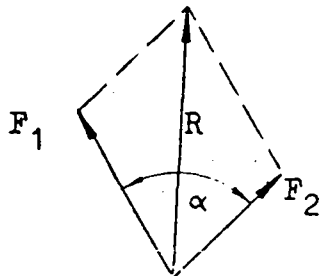

Acute angle

R will be greater than F_1 or F_2

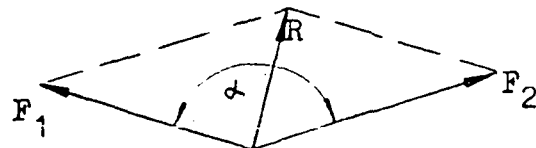

Obtuse angle

R will be smaller than F_1 or F_2

2.5 Forces of friction - laws of friction

Sliding friction: To move a rectangular block of wood on a plane surface made of wood, a force R is necessary to overcome the force of friction F . This can be measured with a spring balance. The frictional force F is always oppositely directed to the movement. When $R > F$, a movement takes place; at $R = F$ the forces are in equilibrium.

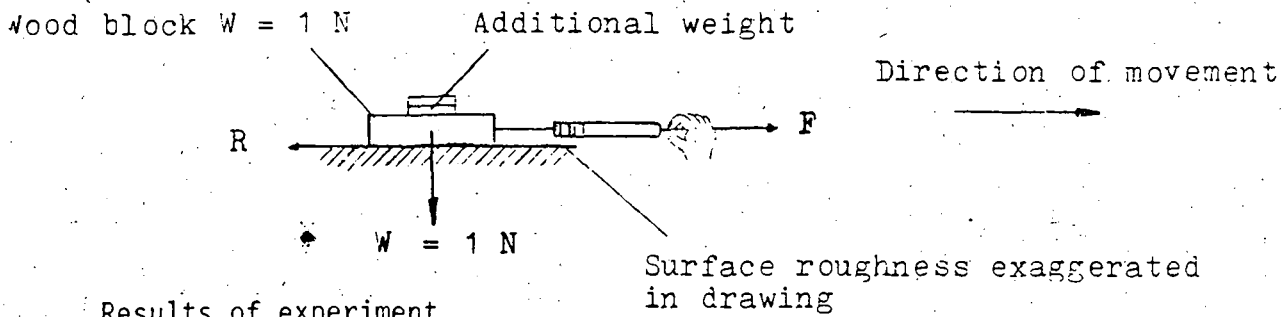

Results of experiment

Weight W (wood block + additional weight)	Force of friction F	$\frac{F}{W}$
1.0 N	0.22 N	0.22
1.5 N	0.32 N	0.21
2.0 N	0.44 N	0.22
2.5 N	0.49 N	0.20
	Mean value.....	0.21

The experiment shows that $\frac{F}{W} = \text{constant}$

This constant is called the coefficient of friction μ .
Thus (on a horizontal surface):

$$\text{Force of friction} = \text{coefficient of friction} \times \text{weight}$$

$$F = \mu \times W$$

Higher pressure on the block means greater friction. Since normal force alone presses block and horizontal surface together, Coulomb's ¹⁾ law of friction applies in its general form:

$$\text{Force of friction} = \text{coefficient of friction} \times \text{normal force}$$

$$F = \mu \times R_n$$

1) The first experiments on friction were carried out by the French scientist A. de Coulomb (1736 - 1806).

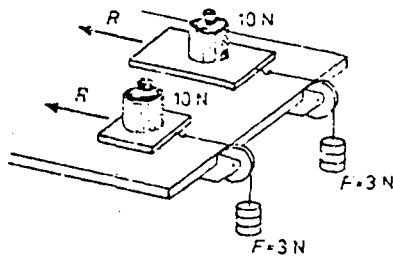

$R = \mu \times F_n$ is always true, even if the supporting surface is inclined. When the surface is horizontal, $R_n = W$, i.e. $F = \mu \times W$.
Experiment: If the two surfaces are increased in size, the force of friction remains the same if the normal force is not altered.

Double surface area -
same normal force -
same force of friction

The force of friction is independent of the size of the sliding surfaces.

Static friction: A greater force is needed to start an object which is at rest moving than to keep it moving. Static friction is therefore higher than sliding friction.

Static friction $F_o = \mu_o R_n$ $\mu_o =$ coefficient of st. friction

Sliding body on surface	Coefficient of sliding friction μ (to maintain movement, $F = \mu \times R_n$ has to be overcome)	Coefficient of static friction μ_o (to initiate movement, static friction $F_o = \mu_o R_n$ has to be overcome)
Steel on steel (dry)	0.1 ... 0.2	0.15 ... 0.3
Steel on steel (lubricated)	0.03 ... 0.08	0.12 ... 0.14
Steel on ice (ice skating)	0.014	0.028
Rubber on asphalt (car on asphalted road)		
dry	0.4 ... 0.5	0.55
wet	0.15 ... 0.2	0.2 ... 0.3

3 Mass - weight - density

3.1 Measurement of mass

Mass is a property of every material body. Our experience shows that every body is "inert", i.e. it resists alterations of its state of motion, and it has "weight": it exerts a force on anything freely supporting it. Physics combines these two properties into a quantity called "mass": this can be understood as the amount of matter a body contains. The basic SI unit of mass is the kilogram (kg). Mass is represented by the letter m .

The concept of mass contains both the property of inertia and the property of weight. It can be said that the more inert a body is, the greater its mass, and vice versa. This is true wherever the body happens to be. We know that if the weights of two different bodies are the same in one particular place, they are the same at any place; i.e. they have the same mass. We are thus in a position to carry out a comparison of the mass of a body, which does not depend on where the body happens to be, via its weight. The heavier a body is at the same place, however, the greater its mass.

A dynamometer is used to determine the weight of an iron ball. Sand is filled into a plastic bag until the dynamometer shows the same weight as for the iron ball.

More exact and easier to carry out are measurements using a beam balance. This can be used to compare masses very simply.

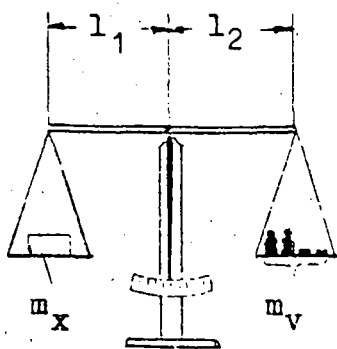

The beam balance is in equilibrium when $m_x = m_v$, since the distances of the pans from the centre beam bearing are equal ($l_1 = l_2$).

m_x = unknown mass

m_v = standard mass

Multiples and fractions of the unit of mass kg

1 kilogram (1 kg) = 1000 grams (1000 g) = 10^3 g

1 gram (1 g) = 1000 milligrams (1000 mg) = 10^3 mg

1 tonne (1 t) = 1000 kilograms (1000 kg) = 10^3 kg

3.2 Variability of weight

Weight is understood as the force which a body exerts under the influence of the attraction of the Earth, the Sun and the Moon and of the centrifugal force due to the rotation of the Earth.

On the surface of the Earth, weight is exerted directly towards the centre of the Earth, since the Earth's gravitational pull is far stronger than the other forces.

The weight of a body with a mass of 1 kg varies from place to place on the Earth, since the acceleration of the body becomes less with increasing distance from the centre of the Earth.

Weight of a body
with a mass of 1 kg

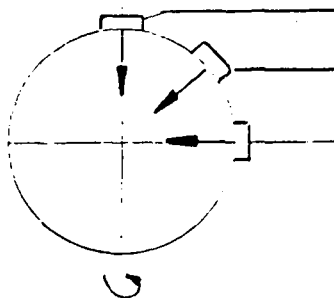

At the Pole 9.83 N

In Paris, France 9.81 N

At the Equator 9.78 N

The fundamental law of dynamics states that:

$$\text{Resultant force} = \text{mass} \times \text{acceleration}$$

Thus, applied to weight:

$$\text{Weight} = \text{mass} \times \text{acceleration due to gravity}$$

$$W = m \times g$$

Example: Find the weight of a body exerted on its support
if the body has a mass of 5 kg.

$$\text{Answer: } W = m \times g = 5 \text{ kg} \times 9.81 \frac{\text{m}}{\text{s}^2} = 49.05 \frac{\text{kg} \cdot \text{m}}{\text{s}^2} = 49.05 \text{ N}$$

3.3 Density

Bodies made from different substances but with equal volume have different inertias and different weights, i.e. different masses.

The density of a substance is defined as its mass per unit volume.

$$\text{Density} = \frac{\text{mass}}{\text{volume}} \quad \rho = \frac{m}{V}$$

kg/m³ or
kg/dm³ or
g/cm³

m = mass, V = volume, ρ = density ¹⁾

Example: A test tube with an inside diameter of 5 mm and a length of 22 cm is filled with mercury.

$$\rho = 13.6 \frac{\text{kg}}{\text{dm}^3} = 13.6 \frac{\text{g}}{\text{cm}^3}$$

Find the mass of mercury in the tube.

Answer: $m = \rho \times V$; $V = \frac{d^2 \times \pi \times h}{4}$

$$= \frac{0.5^2 \text{ cm}^2}{4} \times \pi \times 22 \text{ cm} = 4.32 \text{ cm}^3$$

$$m = 13.6 \frac{\text{g}}{\text{cm}^3} \times 4.32 \text{ cm}^3 = 58.89 \text{ g}$$

Note: When substituting figures in the equation, the units must always be given too and simplified as necessary.

The units can be combined at the end of the expression.

Only one unit of measurement must be used for each quantity in a calculation. For instance, m³ and dm³ may not both be used in one equation. If necessary, units must be converted.

3.4 Measurement of density

To determine the density of a body, its mass and volume must be known. Mass is determined by weighing, volume either by calculation (when this is simple), or else, in the case

1) ρ = Greek letter of the alphabet rho

of an irregular solid, this is immersed in liquid in a measuring beaker or Eureka can (filled with liquid to overflow) and its volume determined through displacement of the liquid.

Volume measurement of an irregular solid

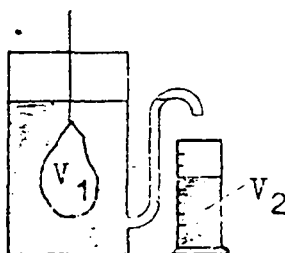

$$V_1 = V_2$$

To determine the mass of a liquid, a previously weighed beaker is filled with the liquid. Beaker and liquid are then weighed and the mass of the liquid found by subtraction ($m = m_{\text{full}} - m_{\text{empty}}$)¹

4 Pressure

If, in a building, a heavy girder rests on only a small area of the supporting wall, the support collapses. Where the area of support is larger, however, it can rest safely. The force is in both cases the same, but it is exerted over different areas. To determine what force is exerted on the unit area, the total force must be divided by the area. The physical quantity which results is called pressure (p). This indicates what part of the total force is exerted on the unit area.

Pressure is the quotient of force and area.

$$\text{Pressure} = \frac{\text{force}}{\text{area}} = p = \frac{F}{A}$$

Equal force

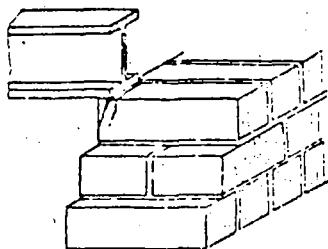

High pressure with small
 area of support

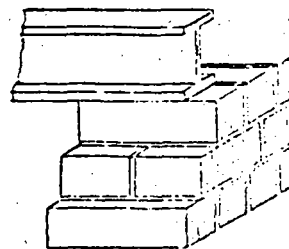

Low pressure with large
 area of support

Unit of pressure

$\frac{\text{N}}{\text{m}^2}$ 1 newton/metre² is called 1 pascal¹⁾ (1 pa).

The pascal generally results in figures which are too large for convenient use in engineering. For this reason, the unit normally used is 1 bar, which replaces 100 000 pascals.

$$1 \text{ bar} = 100\,000 \text{ Pa} = 100\,000 \frac{\text{N}}{\text{m}^2} = 10 \frac{\text{N}}{\text{cm}^2} = 1000 \text{ mbars}$$

4.1 Pressure and pressure transmission in liquids and gases

In a liquid, much smaller forces of attraction are active between the molecules than in a solid. The molecules can therefore move freely among one another. They thus obey the Earth's gravitational pull and fill any vessel from the bottom upwards. A liquid does not have a fixed shape. On the other hand it maintains a fixed volume, which is only slightly compressible even when high pressures are exerted on the liquid.

4.2 Action of forces on the surfaces of liquids

If we press our hand against a solid body which is not fixed (e.g. a table or chair), i.e. if a force is applied to it, the complete body moves. If, on the other hand, we attempt

1) Pascal: French philosopher and mathematician (1623 - 1662)

to push against the surface of a liquid, the water particles slide past our hand. If the hand moves slowly, no opposing force is felt. A force can therefore only be effectively applied to a liquid if the water particles are prevented from giving way. To achieve this, the liquid must be in a closed chamber and the complete surface area of the liquid be covered by a moveable plunger with a good seal. Whereas in the case of a solid moveable body the force can be effective when applied to one point on its surface (point of application), in the case of a liquid the force must be applied to the complete surface.

4.3 Pressure in enclosed fluids

Hydraulic transmission of pressure

If, in the arrangement described above, a force is exerted on the plunger, the liquid is forced not only out of an opening on the opposite side of the chamber, but also out of any other openings round its circumference. The force is transmitted via the plunger uniformly throughout the whole of the enclosed fluid.

The water particles adhering to the plunger are under a pressure P , which is the quotient of force and plunger area:

$$P = \frac{F}{A}$$

As the illustration shows, not only the water particles next to the plunger are affected, but the pressure is transmitted in all directions through the liquid, including the opposite direction to that in which the force was originally applied.

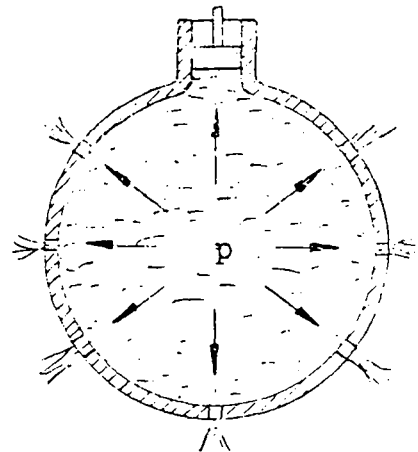

Pascal's law of fluid pressures

Pressure applied anywhere to an enclosed body of fluid is transmitted equally in all directions.

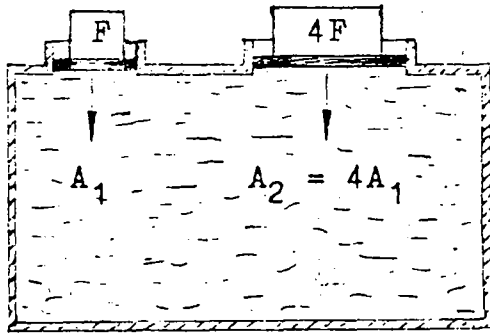

The two plungers are only at equilibrium if the plunger with the greater cross-sectional area has a greater pressure applied to it, so that the total pressure on each of the plungers is equal. This principle finds a technical application e.g. in the hydraulic press.

Technical applications: The hydraulic press.

A force F_1 is applied to the piston with smaller diameter A_1 . In this way, a pressure $p = \frac{F_1}{A_1}$ is exerted on the fluid in

the cylinder (area A_1). This pressure is transmitted equally through the whole of the liquid, so that the force on the working piston is $F_2 = p \times A_2 = \frac{F_1}{A_1} \times A_2$.

The force on the working piston = the force on the pressure piston $\times \frac{\text{large area}}{\text{small area}}$

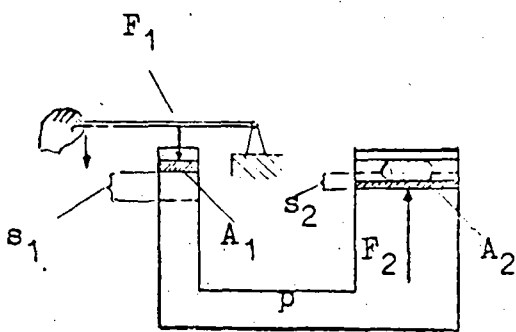

$$F_2 = f_1 \times \frac{A_2}{A_1} \text{ or } \frac{F_1}{F_2} = \frac{A_1}{A_2}$$

The forces on the pistons are in the same proportion as their areas. If the ratio of the diameters is 1 : 5, the forces will be in the proportion

$$1' : 25, \text{ since } F_1 : F_2 = \frac{d_1^2}{4} : \frac{d_2^2}{4} = d_1^2 : d_2^2$$

Extension: Inclusion of the distances moved by the pistons, s_1 and s_2 . If the distances covered by the two pistons in their cylinders are considered, it is clear that these must be equal, since the fluid is not compressible.

Therefore $V_1 = V_2$, or $A_1 s_1 = A_2 s_2$.

Consequently, if the fraction s_1/s_2 is substituted for A_2/A_1 ,

$$F_2 = F_1 \times \frac{A_2}{A_1} = F_1 \times \frac{s_1}{s_2}, \text{ from which } f_2 \times s_2 = F_1 \times s_1.$$

4.4 Pressure in open liquids

Since liquids also obey the law of gravity, there is a constant pressure in any liquid resulting solely from its weight. The pressure in a fluid at rest is generally known as "hydrostatic pressure"¹⁾.

The hydrostatic pressure can result from the application of external forces, e.g. via the piston in a hydraulic press, or from the weight of the liquid alone.

Hydrostatics is the study of forces and pressure in liquids at rest.

Hydrostatic pressure: exerted by the weight of a liquid.

Assuming a horizontal area A below the surface of a liquid, a vertical column of liquid is standing on this area, the weight of which is exerted on area A . If the height of the vertical column is h , its mass is given by

$$m = V \times \rho, \quad V = A \times h, \quad m = A \times h \times \rho$$

When the mass is known, the weight can be calculated:

$$W = m \times g; \quad W = A \times h \times \rho \times g$$

From the weight in relation to the area A , the hydrostatic pressure can be calculated.

$$p = \frac{\text{force}}{\text{area}} = \frac{A \times h \times \rho \times g}{A} = h \times \rho \times g$$

$h \text{ in } m$
 $\rho \text{ in } \frac{kg}{m^3}$
 $g \text{ in } \frac{m}{s^2}$

1) From the Greek hydor = water, statos = at rest.

$$p = \rho \times g \times h$$

Pressure = density x acceleration due to gravity x depth

$$1 \frac{\text{N}}{\text{m}^2} = 1 \frac{\text{kg}}{\text{m}^3} \times 1 \frac{\text{m}}{\text{s}^2} \times 1 \text{ m}$$

Downthrust, sidethrust and upthrust

Since the hydrostatic pressure at any point in a liquid acts in all directions, it follows that it is exerted on every part of the surface of the vessel containing the liquid. The pressure exerts a force downwards, on the floor of the vessel, sideways on its sides and upwards: these are known respectively as downthrust, sidethrust and upthrust.

The downthrust is thus dependent on the volume of the liquid and consequently on the shape of the vessel.

$$F_d = A \times p = A \times h \times \rho \times g$$

In a wide vessel, part of the liquid is supported by the sloping sides, in a narrow vessel the narrowing sides exert a force downwards, which apparently increases the weight of the liquid, so that the downthrust is the same as in the other vessels in spite of the lower weight. A sidethrust increasing with the depth of the liquid is exerted on the vertical side walls of a vessel or tank filled with liquid.

In the illustration, the magnitude of the side- and downthrust is indicated by the varying length of the small arrows. Because the sidethrust varies with the depth of the liquid, sidethrust can only be calculated by multiplying the mean value of the sidethrust by the area. The mean value is that acting at the area's centre of gravity.

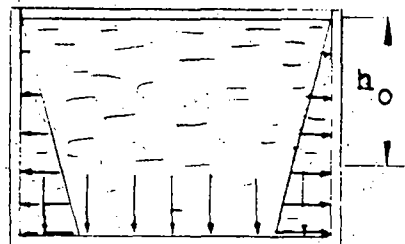

$$F_s = A \times p = A \times h_0 \times \rho \times g,$$

where h_0 is the distance between the area's centre of gravity and the surface of the liquid.

The line of application of this force does not go through the centre of gravity of the area, however, but acts at a lower level, since the sidethrust acting on all parts of the area below the centre of gravity is higher than the mean value, and lower at all points above it. The point through which the line of application of the sidethrust passes is called the centre of pressure. Assuming a rectangular side area of height h , it lies e.g. at $\frac{2}{3}h$ below the surface of the liquid.

Where areas are large, the sidethrust can reach considerable proportions. For this reason it is very important to dimension weirs, dams etc. adequately.

A liquid can, however, also exert a pressure upwards. If this pressure is multiplied by the area, the result is the upthrust.

The formula $p = h \times \rho \times g$, multiplied by the area, is used to calculate upthrust:

$$F_u = A \times h \times \rho \times g$$

Upthrust plays an important part e.g. in casting metal, if the level of the liquid metal filled into the sprue and rising gate is higher than the line of separation between upper and lower parts of the mould. The upthrust will then try to push off the upper mould section. Due to the high specific gravity of liquid metals, very high forces may occur, especially in the case of large castings with relatively large areas. Sometimes they exceed the weight of the finished casting. They must be countered by clamping the two parts of the mould together or by weighting the upper section.

4.5 Upthrust in liquids

The apparent loss of weight of a body in a liquid can be explained by the action of hydrostatic pressure. This acts on all surfaces of the immersed body and exerts forces on it.

The illustration shows the principle at work on a cubic body.

The forces exerted on each of two opposite sides are equal and opposite, thus they cancel each other out. Whereas, however, a pressure $p_1 = h_1 \times \rho \times g$ is exerted upwards against the bottom of the cube, a smaller

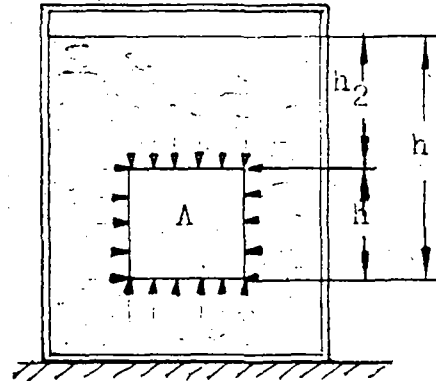

pressure $p_2 = h_2 \times \rho \times g$ acts downwards on it. Thus the total forces exerted on each of these surfaces are different.

If top and bottom surfaces both have an area A , a force $F_1 = A \times h_1 \times \rho \times g$ acts against the bottom surface in an upward direction, whilst a smaller force $F_2 = A \times h_2 \times \rho \times g$ acts downwards on the top surface. Because the forces act in opposite directions, the resultant is the upward force:

$$F_u = F_1 - A \times h_2 \times \rho \times g$$

$$F_u = A \times \rho \times g (h_1 - h_2) = A \times h \times \rho \times g$$

Thus, since $A \times h = V$,

$$F_u = V \times \rho \times g$$

This force, the upthrust, tries to push the cube upwards.

The final expression of the equation above shows that:

The upthrust is equal to the weight of the fluid displaced.

It can be shown that this statement is valid not only for a cube, but for every body immersed in a fluid. The law is called Archimedes' principle after its discoverer Archimedes, the great mathematician and physicist of antiquity.

Legend tells that Archimedes discovered this principle when ordered by the king of Syracuse (Sicily) in about 220 B.C. to prove that a crown was not made of pure gold, but without damaging the crown in any way. Archimedes succeeded by showing that a piece of pure gold, which had the same weight in air as the crown, was heavier than the crown in water.

4.6 Sinking, suspension and flotation of bodies

The upthrust may be smaller than, equal to or even greater than the weight of the body immersed in the liquid. The rule at work can be found by comparing the following formulae:

$$W_b = V_b \times \rho_b \times g \quad \text{and} \quad f_u = V_{f1} \times \rho_{f1} \times g$$

a) If a body sinks in a fluid, its weight must be greater than the upthrust. From the two formulae, it follows that the relative density of the body is greater than that of the fluid.

A body sinks if its relative density is greater than the relative density of the liquid.

b) If the weight of the body is equal to the upthrust, the resultant of the two forces equals zero. At every point in the liquid the body is at equilibrium, i.e. in suspension. As shown above, it follows that its relative density must be equal to that of the liquid.

A body remains in suspension if its relative density is equal to the relative density of the liquid.

c) If a body floats in a liquid, the upthrust is greater than the weight. Thus:

A body floats if its relative density is less than the relative density of the liquid.

As soon as it comes to the surface, the body displaces a smaller amount of liquid and the upthrust is therefore less. The body comes to rest when the weight of the liquid

displaced is just equal to its own weight. When this point is reached, the body floats. Thus:

$$\text{A body floats if } W = F_u \text{ or if } W = V_1 \times \rho_{f1} \times g$$

This equation is equally true if a body, e.g. a steel ship, is made of a material which has a higher relative density than that of the liquid. The ship floats because it is hollow and contains air, therefore its average density is less than that of water.

4.7 Communicating vessels

Often several vessels filled with the same liquid communicate with each other. At the communicating point, the pressure

$$p_1 = p_2, \text{ i.e. if } h_1 \text{ also} = h_2$$

Thus the following applies for such communicating vessels:

In communicating vessels, the surfaces of a liquid at rest are always at the same vertical height, i.e. at the same horizontal level.

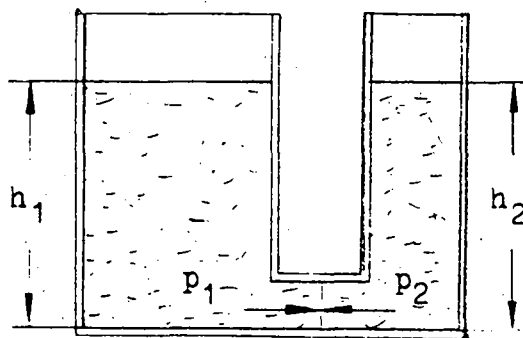

This fact is often made use of in practice, e.g. in watering-cans, water-level gauges on steam boilers, siphons on drains acting as stench traps. The water surfaces of two vessels connected by a hose also stand at the same vertical height.

Such an arrangement can therefore be used to construct a hose level balance, e.g. to determine points on a building site which are at the same level but may be several metres away from each other. The readings h_1 and h_2 give the difference in height between the two points of measurement.

$$\Delta h^1) = h_2 - h_1$$

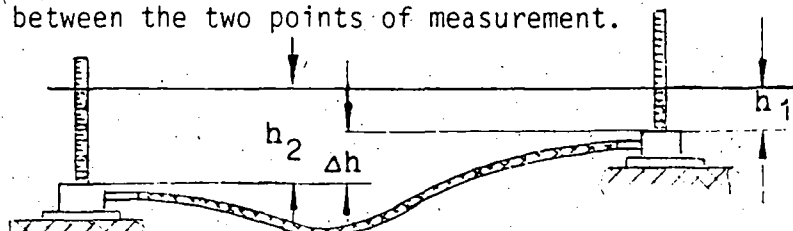

1) Δ = Greek letter of the alphabet, capital delta

Water mains are also an example of communicating pipes and containers (see fig). There is a free surface only in the high-level tank or water tower. At all other points in the system, valves prevent the water from rising. The difference between the height of the water in the high-level tank and at the valve is equivalent, disregarding the friction losses caused by the liquid flowing through the pipes, to the effective pressure at the valve. This is e.g. 4 bars when the high-level tank is 40 m above the tap; it drops however to 3 bars at a tap which is 10 m higher in the same house.

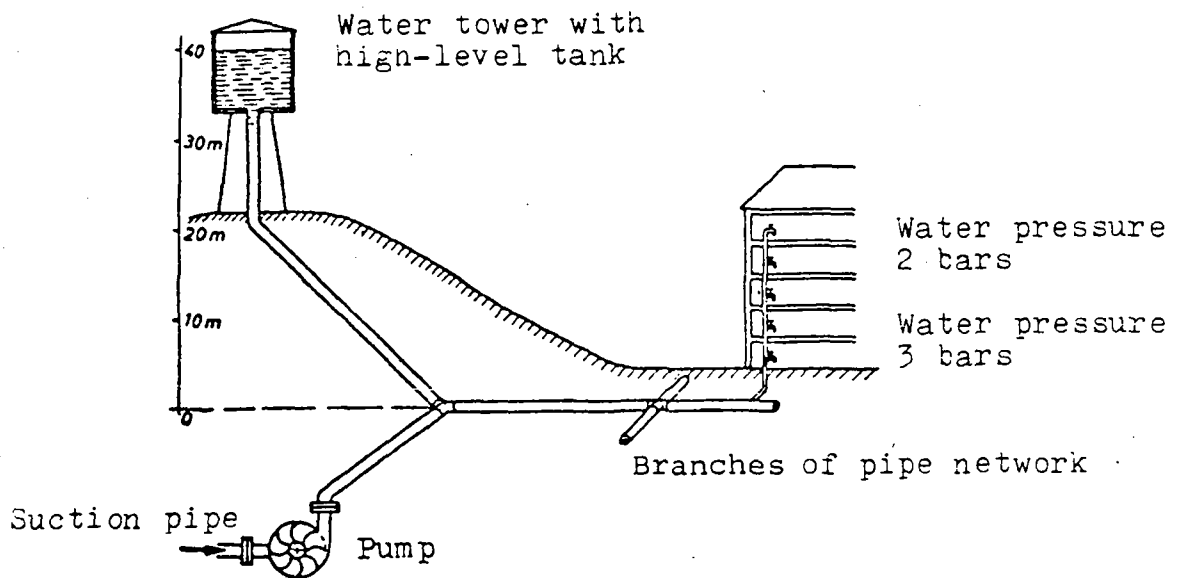

4.8 Atmospheric pressure

Cause of atmospheric pressure

Atmospheric pressure is due to the molecules of the air colliding with each other. Our Earth is surrounded by a layer of air several hundred kilometres thick, rotating with it. At the bottom of this "sea" of air, a pressure is exerted on the surface of the Earth which is comparable to the downthrust of a heavy liquid.

Experiment to prove that air has weight

Using a bicycle pump, air is pumped into a flask having a known weight. The flask is then weighed. The increase in weight results from the weight of the air which was forced in. By measuring the volume of the air flowing out, it can be established that

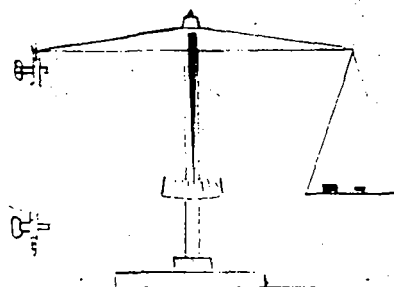

1 litre of air weighs (under normal conditions) 0.0127 N,
since $\rho_{\text{air}} \sim 1.29 \text{ kg/m}^3$

Effects of atmospheric pressure

The Earth is surrounded by a layer of air approx. 500 km thick, which is called the atmosphere. Its mass exerts a pressure on the surface of the Earth: atmospheric or barometric pressure. This pressure, at sea-level and with dry air, is the pressure which will support a column of water 10 332 mm high or a column of mercury 760 mm high (mercury is 13.6 times heavier than water).

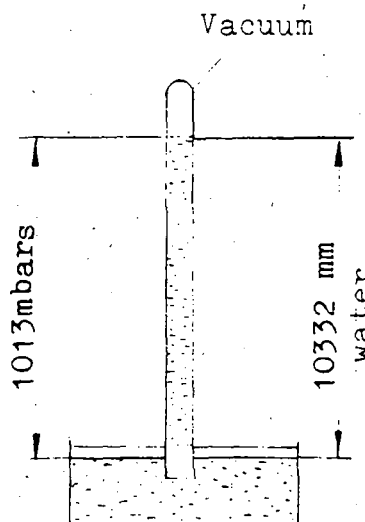

4.9 Measurement of atmospheric pressure

The standard barometers used today in meteorological stations are based on the work of Torricelli. This standard barometer consists of a u-shaped tube, closed at one end. One arm is exhausted of

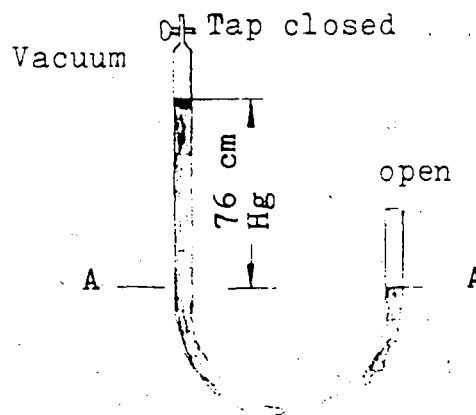

air and in this the mercury is forced up by external atmospheric pressure until equilibrium is reached between the pressure of the mercury and the atmospheric pressure. Atmospheric pressure varies from day to day. Its magnitude is given by the difference in height between the two surfaces of the mercury in the open and in the closed arms of the barometer.

Bulb barometer

This has the advantage that only one reading has to be taken, at the higher surface (A_1), since the lower surface (A_2) alters only very slightly with variations in pressure.

The atmospheric pressure measured by the barometer is usually given in millibars.

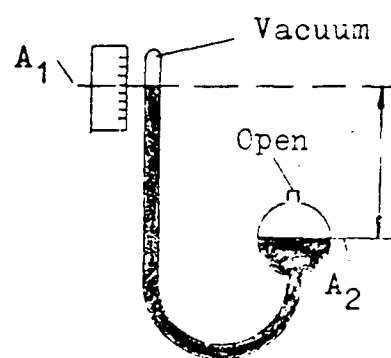

4.10 Excess pressure - negative pressure - absolute pressure

In water mains, tanks, chambers etc. processes or phenomena are often the result of differences between the pressure in the enclosed space and a certain reference pressure, which is usually atmospheric pressure. The following terms are used:

p = atmospheric pressure

p_{ex} = excess pressure (pressure in excess of atmospheric pressure)

p_n = negative pressure (pressure lower than atmospheric pressure)

p_a = absolute pressure (pressure from the zero line up)

($p_a = p_{ex} + p$ or $p_a = p_{ex}$)

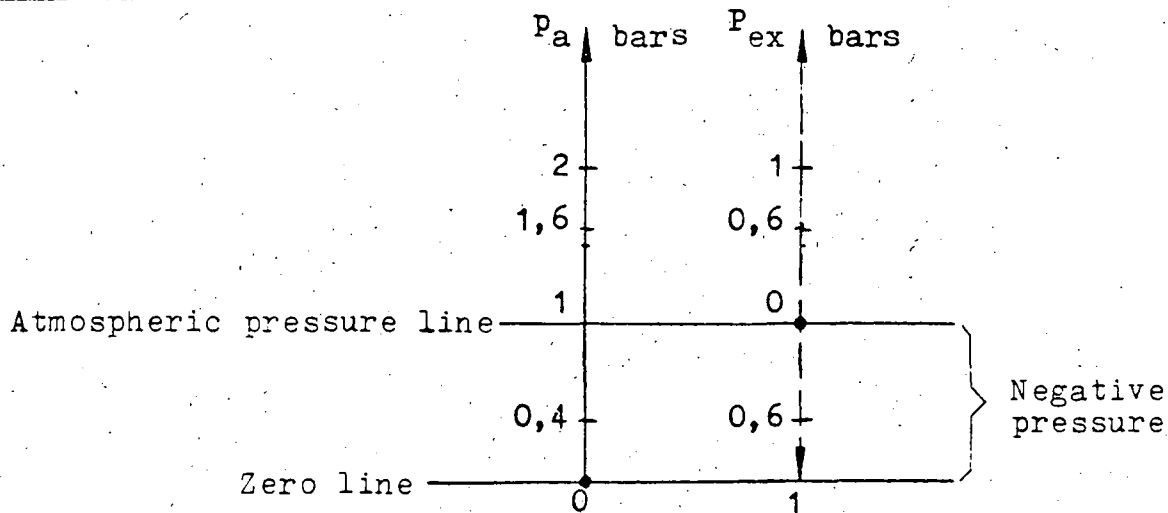

5 Types of mechanical energy

5.1 Mechanical work

Work = force x distance

$$w = F \times s \quad \text{in Nm}$$

The simplest case: lifting work.

If a load is lifted vertically,

lifting work = weight x height lifted

$$w_l = W \times h$$

Example: A load weighing 3 000 N is lifted by 5 m

$$w_l = W \times h = 3\,000 \text{ n} \times 5 \text{ m} = 15\,000 \text{ Nm}$$

Only that part of the force which acts in the direction of the distance moved enters into the calculation of the work done.

Work = force applied in direction of movement x distance moved

Example: A cask is to be moved up an inclined plane. The formula work = force x distance, or here

$$w = 600 \text{ N} \times 2.7 \text{ m} = 1420 \text{ Nm}$$

gives the wrong result.

For the calculation, only that part of the force effective in the direction of the distance moved, i.e. the force F_{II} necessary to overcome the inclination may be entered.

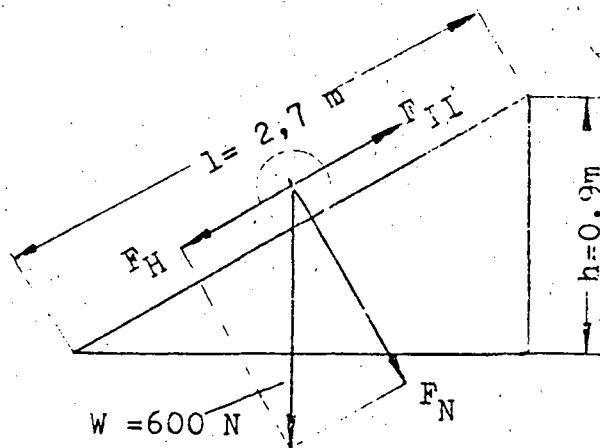

Thus the work performed over distance l is

$$w = F_{II} \times s = F_H \times l = 200 \text{ N} \times 2.7 \text{ m} = 540 \text{ N} \times \text{m} = 540 \text{ J}$$

Vertical lifting of the load W by the height h requires the work

$$w_1 = W \times h = 600 \text{ N} \times 0.9 \text{ m} = 540 \text{ N} \times \text{m}$$

The work done along the inclined plane is independent of the distance. Determinative factor is the difference in height to be overcome.

5.2 Work and energy

Energy is the capacity to perform work (stored work)

Lifting work is done on a body with weight W :

$$w_1 = W \times h = 24 \text{ N} \times \text{m}$$

By suddenly letting the body go at any subsequent moment, the mass m can be thrown upwards with the aid of a pivoted lever. Thus acceleration work has been done on the mass m .

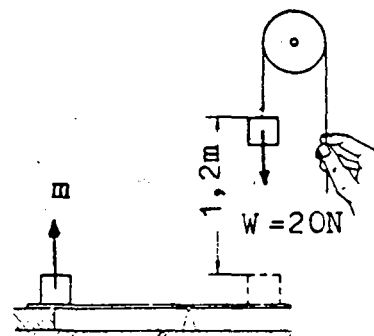

Conclusion: When the load was lifted, work was stored and set free again when the load fell. Any kind of stored work is called energy.

The stored work or energy of the lifted weight in the example above is $24 \text{ N} \times \text{m} = 24 \text{ J}$.

Different kinds of mechanical energy

Depending on the type of stored work, there are different kinds of energy, outlined in the table below.

Type of work	Work done against	Energy	Formula
Lifting w_l	Force of gravity	Potential energy (gravitational)	$E_g = w_l = W \times h$
Tension w_t	Spring tension	Potential energy (elastic)	$E_e = w_t = \frac{1}{2} D s^2$
Acceleration w_a	Inertia	Kinetic energy	$E_{kin} = w_a = \frac{1}{2} m v^2$

Example 1: If 80 000 kg of water are pumped into a reservoir 60 m higher, the potential energy of the water is

$$E_p = W \times h = 800\,000 \text{ N} \times 60 \text{ m} = 48\,000\,000 \text{ N} \times \text{m}$$

(80 000 kg of water "weigh" 800 000 N.)

Example 2: A force of 20 N compresses a spring by 8 cm.

Then with

$$D = \frac{F}{s} = \frac{20 \text{ N}}{0.08 \text{ m}} = 250 \frac{\text{N}}{\text{m}}, \text{ the elastic potential energy}$$

$$E_e = \frac{1}{2} D s^2 = \frac{1}{2} 250 \times 0.08^2 \frac{\text{Nm}^2}{\text{m}} = 0.8 \text{ N} \times \text{m}$$

Example 3: A motor vehicle with a mass of 1520 kg crashes against the arch support of a bridge at a speed of 30 m/s. What kinetic energy is released at that moment to carry out work of destruction?

$$E_{kin} = \frac{1}{2} m v^2 = \frac{1}{2} 1520 \times 30^2 \frac{\text{kg} \times \text{m}^2}{\text{s}^2} = 684\,000 \text{ J} = 0.684 \text{ MJ}$$

$$v = 30 \text{ m/s}$$

Law of conservation of energy

In frictionless mechanical processes, mechanical energy can never be destroyed. The creation of new energy is also impossible. In all mechanical processes energy can only be transferred.

5.3. Mechanical power

Power is the ratio of work done to time taken:

$$\text{Power} = \frac{\text{work}}{\text{time}} \quad \boxed{P = \frac{W}{t}}$$

Unit of power:

$$\frac{1 \text{ N} \times \text{m}}{\text{s}} = \frac{1 \text{ J}}{1 \text{ s}} = \frac{1 \text{ Ws}}{\text{s}} = 1 \text{ watt}$$

Example: Calculate the power of a pump which can lift 2 m^3 of water through a vertical height of 35 m in 2 min.

$$\begin{aligned} \text{Answer: } P &= \frac{W}{t} = \frac{F \times s}{t} = \frac{m \times g \times h}{t} = \frac{2000 \text{ kg} \times 10 \text{ m} \times 35 \text{ m}}{\text{s}^2 \times 2 \times 60 \text{ s}} \\ &= 5830 \text{ watts} = 5.83 \text{ KW} \end{aligned}$$

Power used to be measured in horsepowers (h.p.).

1 h.p. (British) is equivalent to 745.7 watts.

Reformulation of the power equation

Example: As a passenger aeroplane takes off, the thrust of each engine is 72 000 N when a speed of 210 km/h is reached. What is the power of the four engines?

$$\begin{aligned} \text{Answer: } P &= F \times v = 4 \times 72 \text{ 000 N} \times 210 \text{ km/h} \\ &= 4 \times 72 \text{ 000 n} \frac{210 \text{ m}}{3.6 \text{ s}} = 16 \text{ 800 000} \frac{\text{Nm}}{\text{s}} \\ &= 16.8 \times 10^6 \frac{\text{J}}{\text{s}} = 17 \text{ MW} \end{aligned}$$

Power in turning motion

A wheel is set in motion by a force F applied in the direction of its circumference. If the point of application A of the force moves with the circumferential speed v , $P = F \times v$.

With $v = r \times \omega$, it follows that $P = F \times r \times \omega = M \times \omega$, since $F \times r$ represents the torque of the force F .

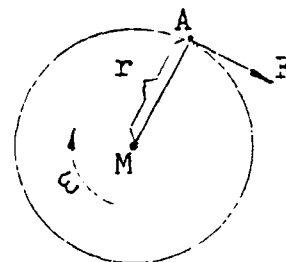

Turning power = torque x angular velocity

$$P = M \times \omega \text{ in } \frac{\text{N} \times \text{m}}{\text{s}} = \text{watts} \quad \omega = 2 \times \pi \times n$$

Example: What power is required to turn a crank handle with a length of 300 mm, exerting an effort of 100 N at a speed of 20 revolutions per minute;

Answer: $P = M \times \omega$ $M = F \times r = 100 \text{ N} \times 0.3 \text{ m} = 30 \text{ N} \times \text{m}$

$$\omega = 2 \pi n = 2 \times \pi \times 20 \frac{1}{\text{min}} = 2 \times \pi \times 20 \frac{1}{60 \text{ s}} = \frac{2}{3} \frac{1}{\text{s}}$$

$$\text{Thus } P = M \times \omega = 30 \text{ N} \times \text{m} \times \frac{2}{3} \frac{1}{\text{s}} = 62.8 \frac{\text{Nm}}{\text{s}} = 62.8 \text{ WW}$$

(= approx. 0.08 Brit. h.p.)

The required power of 0.08 h.p is well within the capacity of a human being for relatively long periods.

6 Electric current

If we wish to use e.g. an electric drill, we simply plug it into a socket. The socket is for us a source of electric current. In various electrical appliances, electric current transforms electrical energy into other forms of energy. Thus electric current produces heat in a heating appliance, light in a lamp, coolness in a refrigerator and movement in a drill.

6.1 Voltage - current - resistance

Voltage

When insulating materials, e.g. plastics or glass, are rubbed with a piece of leather or fur, a separation of charges occurs, resulting in either an excess of or a deficit of electrons.

A deficit of electrons is known as a positive charge, an excess of electrons as a negative charge. This can be demonstrated using a glass or plastics rod which is pivoted or suspended. The rods are rubbed with fur or leather and then brought near to each other.

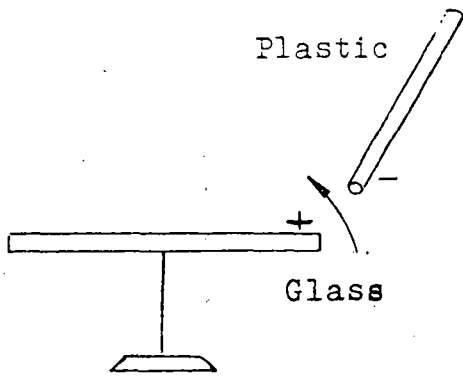

The pivoted glass rod
is attracted

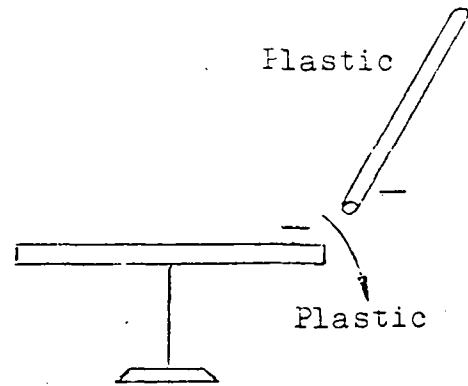

The pivoted plastic rod
is repelled

This verifies the fundamental law that like charges repel, unlike charges attract. The cause of this flow of electrons is called the potential difference (i.e. between two points with a different electric potential), also electromotive force or voltage.

In industry and technology, the following methods of producing a voltage are of importance:

Electromagnetic induction through moving magnets or coils.

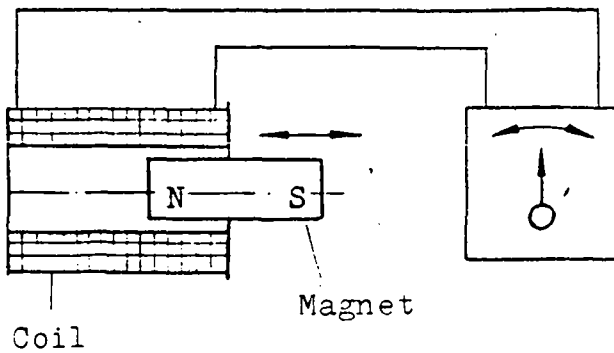

Changes of a magnetic field produce a voltage in a conductor. This is known as inductions.

Application: generators.

Voltage from chemical changes

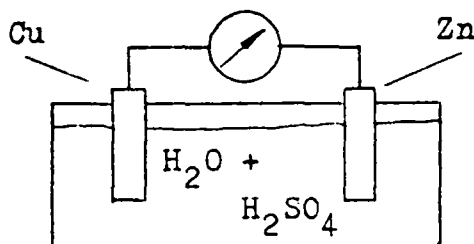

If two different metals are dipped into an electrolyte, a voltage is produced as a result of chemical changes.
Application: accumulators, batteries.

Voltage from heat

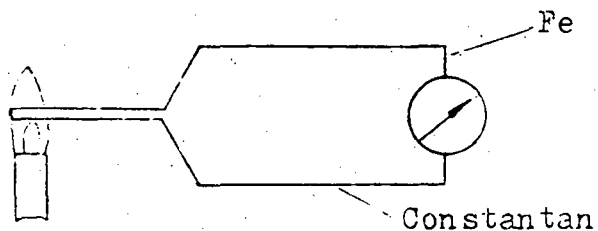

If the junction of two different metals is heated, a voltage is produced (thermo-electric effect).

Application: thermo-elements.

Voltage from light

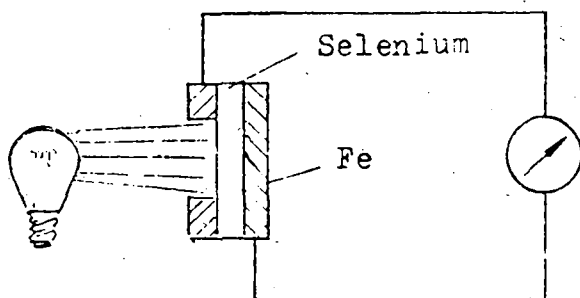

If light falls on a selenium cell, a photovoltaic effect occurs.

Application: light meters, "magic eyes".

Voltage through pressure or tension applied to crystals

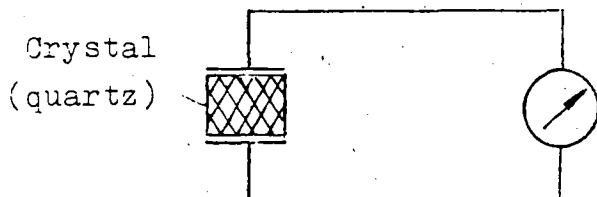

Certain crystals produce a voltage due to the piezo-electric effect when they are subjected to pressure or tension.

Application: record players, cigarette lighters.

Voltage variation with time

Voltage variation with time can be observed with the aid of a cathode ray oscillograph. The following patterns result:

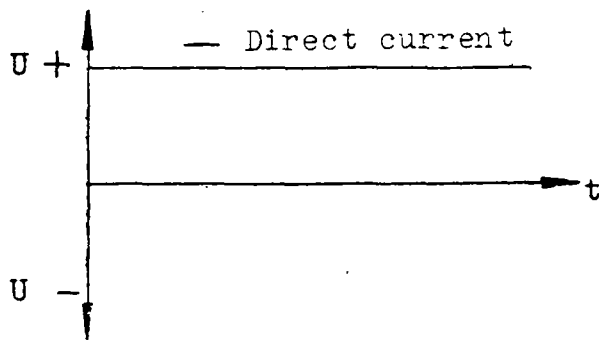

In the case of a battery, the magnitude and direction of the current are the same at all points.

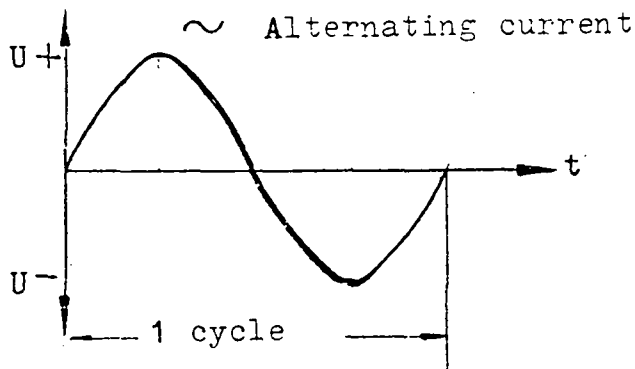

In the case of a generator, magnitude and direction of the current change at regular intervals (i.e. cyclically). The alternating current frequency used in technology is 50 Hz = 50 cycles per second.

Voltage is the source of electric current. If a direct voltage is fed into an electric circuit, a direct current will flow. Direct current flows in one direction only. If an alternating or mixed voltage is fed into the circuit, an alternating current results. This flows backwards and forwards many times per second.

Electric current

Production of electric current

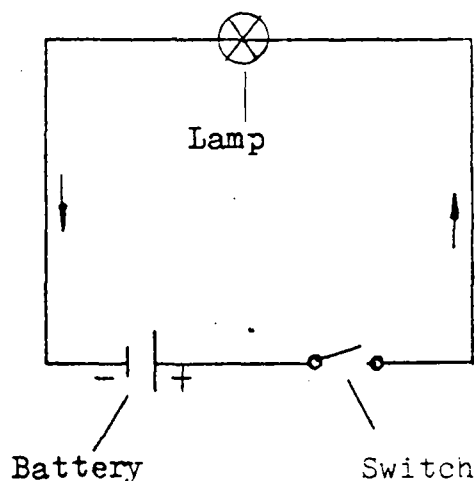

A lamp is connected via a switch to the two terminals of a battery.

Finding: Current can only flow when there are both a source of voltage and a closed electric circuit. Current is the movement of charges. The conventional direction of flow of electric current is from positive to negative.

Effects of electric current

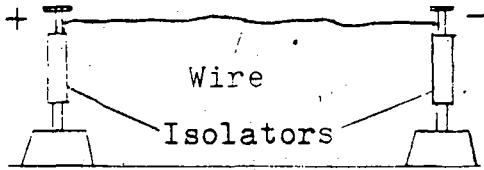

Heat is produced by friction of the electrons in the conductor.

Applications: heating, lighting.

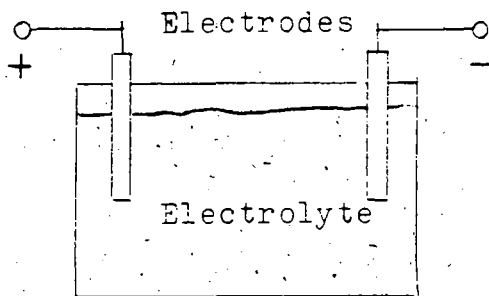

If current flows through an electrically conductive substance (electrolyte), it undergoes decomposition.

This is called electrolysis. Applications: electroplating, copper refining, aluminium production.

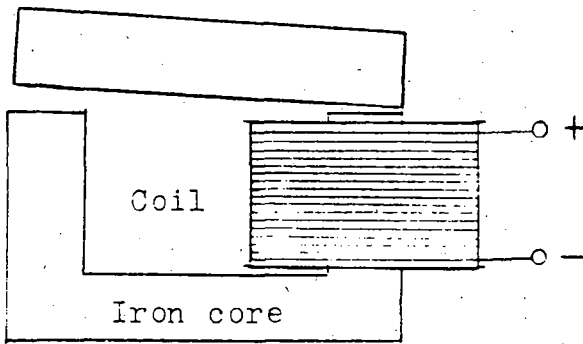

A conductor with a current flowing through it acts like a magnet.

Applications: magnets, relays, electric motors.

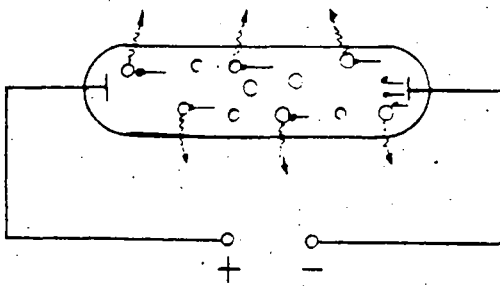

If electrons collide with gas molecules, these emit light. This is one way in which electric current is used for lighting.

Applications: lighting (streets, factories, houses).

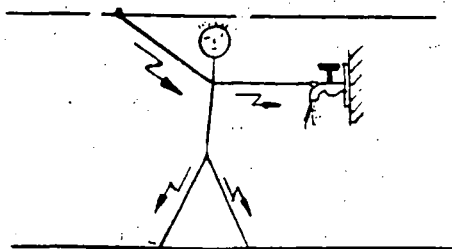

If current flows through a living being, nerves and muscles are affected. This is called the physiological effect.

Applications: some uses in medicine, but danger, may be fatal!

Resistance

If in an electric circuit different materials with different dimensions (length and cross-section) are used, it will be found that although the voltage source is the same, the current is different. The reason for this is the varying ability of different substances to resist the flow of

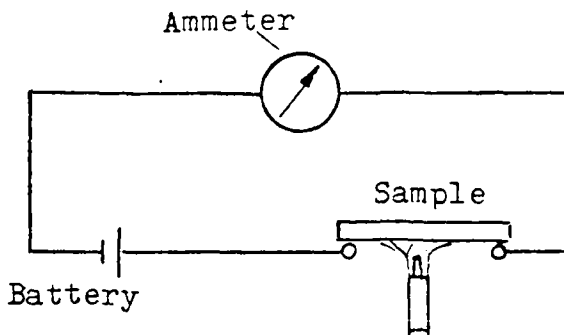

electric current through them. The resistance e.g. of a wire depends on its dimensions, the material from which it is made, and the temperature.

Electric conductors

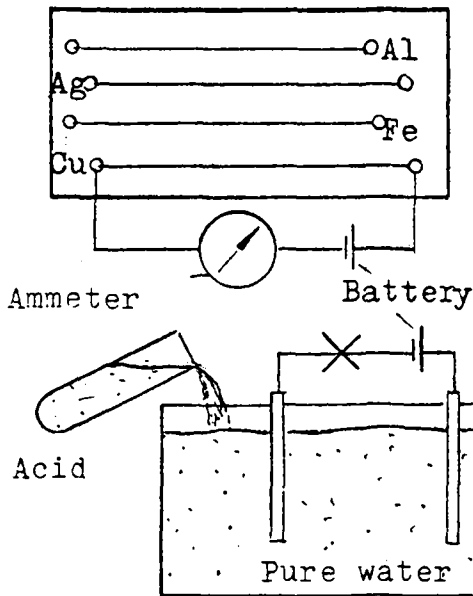

The best conductors are silver, copper and pure aluminium; also all other metals and coal conduct electric current.

Applications: electric cables, energy transference, resistance wires.

Solutions of acids, alkalis and salts conduct electric current via movement of ions. Applications: galvanization, electrolysis.

Non-conductors

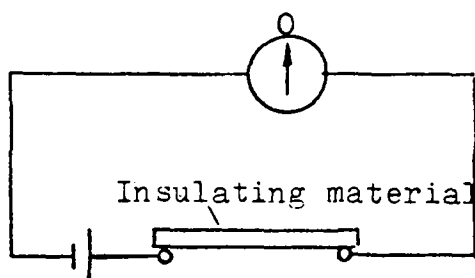

Various substances such as glass, air, china, plastics, rubber and pure water do not conduct electric current.

Applications: insulating materials.

Semi-conductors

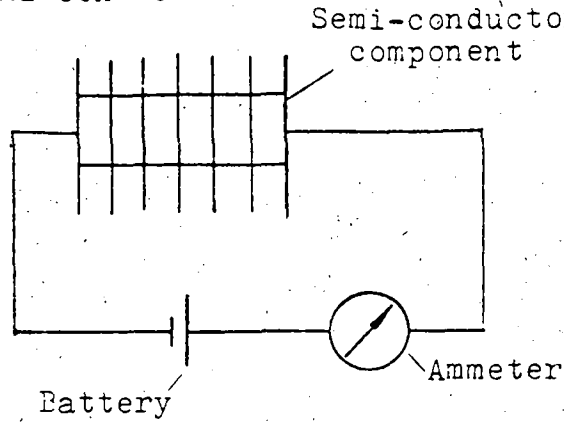

Various substances such as selenium, silicon, germanium have a conductivity between that of metals and of insulating substances. With an appropriate arrangement, the type of conductivity can be influenced, e.g. conduction in one direction, conduction under exposure to light or application of voltage.

Applications: rectifiers, transistors, diodes.

6.2 Dangers of electricity

Effect on the human organism

Electric current is dangerous for human beings because we possess no sense which can detect electricity, we can only register its effects on us. The three main effects on the human (and animal) organism are the following:

Chemical effect; physiological effect; heat effect.

Chemical effect: Approx. 2/3 of the human body consists of water. When a voltage is applied, a decomposition therefore takes place. This decomposition destroys the cells which are the ultimate elements of all organism structures.

Physiological effect: Our bodies use electricity all the time to convey messages from the senses to the brain, or to send signals from the brain to the nerve ends in our muscles. These impulses use a voltage of about 0.1 V. If an additional exterior voltage is applied, normal processes can no longer take place: e.g. muscles are no longer relaxed (muscular spasms).

The control centre of our heart is located in the heart itself (coronary sinus), so that currents passing through the heart are particularly dangerous. The current normally used in industry has 50 Hz, so that the cardiac muscle would be given an order to contract 100 times per second. This is roughly 80 times faster than normal. The result is a racing, shallow action, i.e. the heart ceases to pump. This is known as auricular fibrillation and leads to cardiac arrest.

Heat effect: Every substance is heated by electric current passing through it, including the human body. Especially endangered are the points of entry and exit, because the relatively high transfer resistance leads to high power levels ($P = I^2 \times R$) and a high conversion into heat. Added to this is the fact that protein coagulates in the hot tissue; also increasing the temperature of the muscles by only 15°C already causes the red blood corpuscles to burst.

Amperage ranges

The extent to which the effects described above occur will depend in each separate instance above all on the intensity of the current (amperage), but also to a considerable degree on the path taken by the current through the body, the duration of the shock and the type of current (direct current, alternating current, mixed current).

According to Koeppen, a distinction is to be made between four amperage ranges;

0 25 80 5000 (in mA)
 ← 1 → ← 2 → ← 3 → ← 4 →

The values in the table below, "Current intensities and their effects", resulted from investigations of accidents. This means that in a different situation with different conditions, a lower intensity may well be fatal. A person's state of health and general fitness also play a decisive part.

Amperage range	Current intensity (a.c.) in mA	Effects	Consequences
1	2 10	Slight tingling Paralytic symptoms; muscular spasms; increase of blood pressure	Uncontrolled movements due to shock "Let-go limit"; respiratory paralysis; possibly loss of consciousness
2	25 - 80	Stomach cramps; severe muscular spasms; with longer duration auricular fibrillation	Nausea; bone fractures due to distortions; circulation ceases to function; supply of oxygen to the brain fails; approx. 4 min. later brain cells start to die
3	80 - 5000	Auricular fibrillation begins after only 0.1 s	Cardiac arrest and death
4	over 5000	Severe burn, often cardiac arrest, usually no auricular fibrillation	Death due to burns, often days or weeks later

Maximum permissible contact potential

To determine what voltage begins to be dangerous for human beings, we have to know the resistance of the human body. Many different measurements and calculations have resulted in quite widely varying findings, so that no generally applicable figure can be given. A lower limit of 1000 is generally agreed on, however.

For amperage range 2, the following calculation of voltage results:

$$U = I \times R$$

$$U = 0.25 \text{ A} \times 1000$$

$$U = 25 \text{ V}$$

Since it can be assumed that a person will in general not receive the full operating voltage, it has been ruled that where plants have a rated voltage greater than 65 V, additional protective measures must be taken to prevent indirect contact. (Note: on finalization of international agreements, this level will probably be lowered to 50 V.)

This limit is known as the maximum permissible contact potential. It represents the voltage which a human being can receive without taking lasting harm.

The maximum permissible contact potential is:

for human beings 65 V

for domesticated animals 24 V

This limit must on no account, however, lead anyone to suppose that lower voltages are completely safe; as already pointed out, these may quite well represent a risk, depending on circumstances.



Deutsche Gesellschaft für Technische Zusammenarbeit (GTZ) GmbH
Dag-Hammarskjöld-Weg 1 + 2 · D 6236 Eschborn 1 · Telefon (0 6196) 79-0 · Telex 4 07 501-0 gtz d

The government-owned GTZ operates in the field of Technical Cooperation. Some 4,500 German experts are working together with partners from some 100 countries in Africa, Asia and Latin America in projects covering practically every sector of agriculture, forestry, economic development, social services and institutional and physical infrastructure.

- The GTZ is commissioned to do this work by the Government of the Federal Republic of Germany and by other national and international organizations.

GTZ activities encompass:

- appraisal, technical planning, control and supervision of technical cooperation projects commissioned by the Government of the Federal Republic of Germany or by other authorities
- advisory services to other agencies implementing development projects
- the recruitment, selection, briefing and assignment of expert personnel and assuring their welfare and technical backstopping during their period of assignment
- provision of materials and equipment for projects, planning work, selection, purchasing and shipment to the developing countries
- management of all financial obligations to the partnercountry.

The series "**Sonderpublikationen der GTZ**" includes more than 190 publications. A list detailing the subjects covered can be obtained from the GTZ-Unit 02: Press and Public Relations, or from the TZ-Verlagsgesellschaft mbH, Postfach 36, D 6101 Roßdorf 1, Federal Republic of Germany.

TRAINING MODULES FOR WATERWORKS PERSONNEL

List of training modules:

Basic Knowledge

- 0.1 Basic and applied arithmetic
- 0.2 Basic concepts of physics
- 0.3 Basic concepts of water chemistry
- 0.4 Basic principles of water transport
- 1.1 The function and technical composition of a watersupply system
- 1.2 Organisation and administration of waterworks

Special Knowledge

- 2.1 Engineering, building and auxiliary materials
- 2.2 Hygienic standards of drinking water
- 2.3a Maintenance and repair of diesel engines and petrol engines
- 2.3b Maintenance and repair of electric motors
- 2.3c Maintenance and repair of simple driven systems
- 2.3d Design, functioning, operation, maintenance and repair of power transmission mechanisms
- 2.3e Maintenance and repair of pumps
- 2.3f Maintenance and repair of blowers and compressors
- 2.3g Design, functioning, operation, maintenance and repair of pipe fittings
- 2.3h Design, functioning, operation, maintenance and repair of hoisting gear
- 2.3i Maintenance and repair of electrical motor controls and protective equipment
- 2.4 Process control and instrumentation
- 2.5 Principal components of water-treatment systems (definition and description)
- 2.6 Pipe laying procedures and testing of water mains
- 2.7 General operation of water main systems
- 2.8 Construction of water supply units
- 2.9 Maintenance of water supply units
Principles and general procedures
- 2.10 Industrial safety and accident prevention
- 2.11 Simple surveying and technical drawing

Special Skills

- 3.1 Basic skills in workshop technology
- 3.2 Performance of simple water analysis
- 3.3a Design and working principles of diesel engines and petrol engines
- 3.3b Design and working principles of electric motors
- 3.3c —
- 3.3d Design and working principle of power transmission mechanisms
- 3.3e Installation, operation, maintenance and repair of pumps
- 3.3f Handling, maintenance and repair of blowers and compressors
- 3.3g Handling, maintenance and repair of pipe fittings
- 3.3h Handling, maintenance and repair of hoisting gear
- 3.3i Servicing and maintaining electrical equipment
- 3.4 Servicing and maintaining process controls and instrumentation
- 3.5 Water-treatment systems: construction and operation of principal components: Part I - Part II
- 3.6 Pipe-laying procedures and testing of water mains
- 3.7 Inspection, maintenance and repair of water mains
- 3.8a Construction in concrete and masonry
- 3.8b Installation of appurtenances
- 3.9 Maintenance of water supply units
Inspection and action guide
- 3.10 —
- 3.11 Simple surveying and drawing work



Deutsche Gesellschaft für
Technische Zusammenarbeit
(GTZ) GmbH

P. O. Box 5180
Dag-Hammarskjöld-Weg 1+ 2
D 6236 Eschborn/Ts. 1
Telephone (06196) 79-0
Telex 407 501-0 gtz d
Fax No. (06196) 79-1115