

UNITED NATIONS SYSTEM

INTERNATIONAL REFERENCE CENTRE
FOR COMMUNITY WATER SUPPLY AND
SANITATION (IRCS)

DRAFT

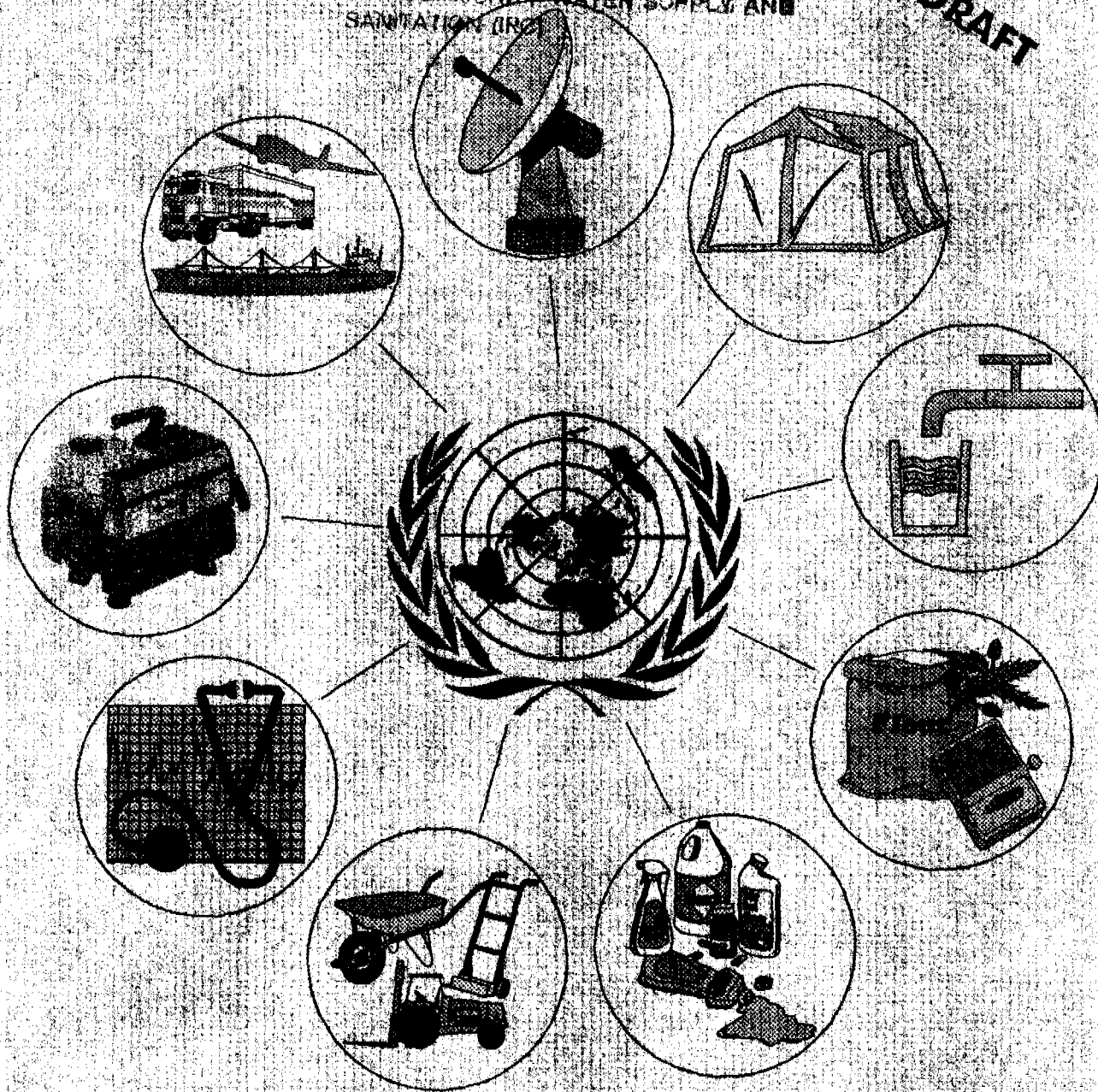

EMERGENCY RELIEF ITEMS COMPENDIUM OF GENERIC SPECIFICATIONS

UNITED NATIONS DEVELOPMENT PROGRAMME (UNDP)



INTER-AGENCY PROCUREMENT SERVICES OFFICE (IAPSO)

Prepared in cooperation with UNDHA, Geneva

MARCH 95

FOREWORD

The last few years have seen a growth in the number of emergencies all over the world. Along with the increasing number of disasters and their spreading human and economic effects, especially in developing countries, the cost of relief and rehabilitation is also increasing. During 1993 alone, the United Nations System and other humanitarian aid organizations have distributed disaster relief items to a value of nearly USD 3 billion.

In the current economic climate, donors are increasingly concerned about cost-effectiveness to enable relief and rehabilitation measures to be sustained. The issue has been reflected in various General Assembly resolutions and raised at meetings with the participation of the United Nations Agencies, governmental and other organizations.

Mindful of this concern, Department of Humanitarian Affairs (DHA) has redoubled its efforts to increase the cost-effectiveness of international relief operations through improved emergency preparedness, cooperation and coordination. Within the framework of this task, DHA has initiated projects and promoted and sponsored other programmes conducted by United Nations Agencies with the participation of governmental, international non-governmental and other organizations.

The present *Catalogue of Items for Emergency Relief* is the result of one such project conducted by the Inter-Agency Procurement Services Office of the United Nations Development Programme (UNDP/IAPSO) with the aim of developing generic specifications for emergency relief items to be provided during the initial phase of a disaster. It has been built upon the years of expertise and experience accumulated within the United Nations System and the international relief community. DHA is happy to have provided support and, through its Relief Coordination Branch, to have made a substantial contribution to this project.

The catalogue is one of the three correlated practical tools envisaged in the joint DHA/IAPSO strategy paper "An Initiative to Improve Emergency Preparedness" elaborated following the Workshop on Emergency Stockpiles organized by DHA in Geneva on 3 - 4 March 1993. The two others are the Register of Emergency stockpiles (established by DHA) and the database of commercial supply sources (being developed by UNDP/IAPSO) as the Database of Items for the Relief of Emergencies.

We are sure that the international community will find this catalogue, together with the other tools being made available, a useful instrument for proper planning and delivery of relief assistance in a rapid, concerted and cost-effective manner.

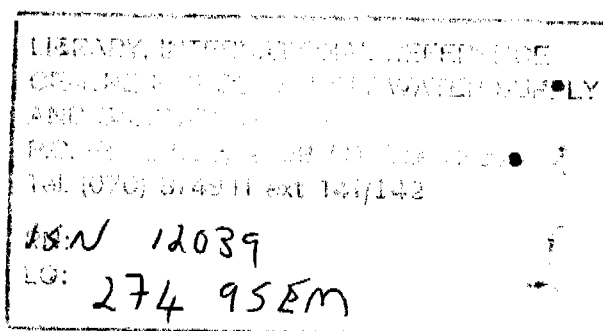

PREFACE

1. The need for improved standardization of emergency relief items has been expressed at various meetings of the Inter-Agency Procurement Working Group (IAPWG *), as well as more recently at the workshop attended by organizations operating stockpiles of disaster relief items, organized by UN/DHA in Geneva from 4-5 March, 1993. Over the past twelve months, IAPSO in close cooperation with UN/DHA and supported by major UN organizations as well as some international NGOs has coordinated the joint efforts towards this objective.
2. The following product groups were identified for which development of common specifications for individual emergency relief items would be particularly desirable:
 - Telecommunications equipment
 - Shelter, housing, storage and cooking appliances
 - Water supply equipment and supplies
 - Food items
 - Sanitation and hygiene items
 - Materials handling equipment
 - Power supply systems
 - Medical supplies and equipment (under preparation for inclusion in next year's edition)

After numerous meetings, the participating organizations agreed on lists of specific items required in each product group, notably for the first phase of an emergency, and finalized generic specifications for each item.

3. An additional chapter (logistics) has been added to the catalogue to assist procurement personnel in contracting of most appropriate forwarding services, depending on commodities and circumstances.
4. To ensure incorporation of products most suitable for disaster relief, the product selection and technical specifications were based on experience gathered over the years by UN/DHA, ITU, UNHCR, UNICEF, UNRWA, WFP and WHO, but likewise by such important relief organizations like MSF, Oxfam, ICRC and the IFRC, together with the input provided by ECHO of the European Community and information received from the government purchasing centres of Germany and Sweden.
5. The catalogue lists by product group the complete generic specifications for all selected items, together with indicative prices and information on shipping weight/volume for budgeting purposes. The relevant UNCCS identification number (United Nations Common Coding System) has also been allotted to assist in the interchange of information and statistical reporting.
6. The catalogue is intended to facilitate the acquisition of suitable relief items from as many qualified suppliers as feasible, in a cost efficient manner.
To assist in the selection of the most appropriate equipment, a section on needs and recommended responses has been added to each product chapter.
7. The catalogue could provide guidance and assistance to:
 - * Donor governments as well as national governments and institutions in developing countries concerned with the planning, budgeting and execution of assistance in emergency situations
 - * Procurement officials of the UN system and within NGOs and Bilateral Aid Organizations involved in the acquisition of emergency relief items.
8. It should be noted that a database of items for the relief of emergencies (DIRE) is maintained by IAPSO/UNDP containing information of potential suppliers of relief items. These were identified through international bidding using the generic specifications as listed in this catalogue, and were selected on criteria based on conformity with specifications, prices, past experience, stock levels and services.
9. IAPSO takes this opportunity to express its gratitude to all cooperating organizations, for their continuous support in the preparation of this catalogue. It is hoped that this publication will assist the efforts of the international aid community for improved and cost-efficient emergency preparedness.

* These meetings are organized by IAPSO to facilitate exchange of experience among various organizations of the UN system concerned with procurement.

CONTENTS

Foreword	i
Preface	ii

CHAPTER 1 - TELECOMMUNICATIONS EQUIPMENT 1

<i>Needs and recommended responses</i>	3
--	---

- **Public address equipment** 9
 - Megaphone, hand-grip type 9
 - Megaphone, shoulder type 9
 - Public address (PA) set, mobile 10
 - Public address (PA) set, fixed installation 10
- **VHF equipment** 11
 - Transceiver, VHF, hand-held 11
 - Transceiver, VHF, base station 12
 - Transceiver, VHF, vehicle 13
 - Repeater station, VHF 14
 - VHF field kit 15
- **HF equipment** 16
 - Transceiver, HF, radio voice system 16
 - Transceiver, HF, transportable 17
 - Radiotelex data transmission system 18
- **Antennae systems for HF radio communications** 19
 - Broadband antenna 19
 - Delta loop antenna 20
 - Automatic antenna tuner 21
 - Log periodic antenna 22
- **Satellite communications equipment** 23
 - INMARSAT system A 23
 - INMARSAT system C 24
 - INMARSAT system M 25
- **Power sources** 26
 - Generator 26
 - Solar power supply kit 27

CHAPTER 2 - SHELTER, HOUSING, STORAGE AND COOKING APPLIANCES 29

<i>Needs and recommended responses</i>	31
--	----

- **Shelter and housing** 35
 - Tarpaulin, woven plastic 35
 - Tarpaulin, reinforced, non-woven plastic 36
 - Tarpaulin, reinforced, non-woven braided plastic 37
 - Family size temporary shelter 38
 - Tent, ridge type for tropical use 39

CONTENTS

Tent, ridge type for cold climate	41
Utility tent	43
Tent repair kit	45
• Bedding	46
Blanket, low thermal resistance	46
Blanket, medium thermal resistance	47
Blanket, high thermal resistance	48
Sleeping bag	49
Mattress	50
• Kitchen accessories	51
Kitchen set, family size	51
Kitchen set, for 250 people	52
Kitchen set, for 100 children	53
Stove, kerosene	54
Hot plates, gas	55
Hot plates, electric	55
Jerry can, plastic	56
Jerry can, plastic, collapsible	56
Bucket, plastic	57
Bucket, steel	57
• Lighting equipment	58
Lantern, kerosene	58
Solar lighting kit, mobile	59
• Heaters	60
Heater, kerosene/diesel	60

CHAPTER 3 - WATER SUPPLY EQUIPMENT AND SUPPLIES 61

<i>Needs and recommended responses</i>	<i>63</i>
• Water testing equipment	69
Water testing kit	69
• Water pumping equipment	70
Submersible borehole pump, low yield	70
Submersible borehole pump, medium yield	71
Submersible borehole pump, high yield	72
Mobile centrifugal pump, medium yield	73
Mobile centrifugal pump, high yield	74
• Water storage equipment	75
Water pumping pack	75
Water storage tanks, collapsible, reinforced plastic	76
Water storage tanks, steel	77
• Water treatment equipment	78
Disinfectant, calcium hypochlorite powder	78
Sand filtration plant	79
U.V. treatment unit for water purification	80
Chlorinator	81
Water treatment plant	90

CONTENTS

• Water distribution equipment	83
Water collection point	83
Water pipes, polyethylene	84
Quick pipe coupling	85
Male and female pipe adaptors	86
Gate valve	87
Check valve	87
Water tap, self-closing	88
Ball valve	88
Water distribution pack	89
• Tool kits	90
Pump tool set	90
Water system tool set	91

CHAPTER 4 - FOOD ITEMS **93**

<i>Needs and recommended responses</i>	95
--	----

• Cereals	99
Wheat	99
Rice, husked	100
Sorghum, grain	101
Maize, white	102
• Wheat products	103
Flour, wheat	103
Flour, maize	104
Pasta and noodles wheat	105
• Blended foods	106
Wheat soya blend (WSB)	106
Corn soya blend (CSB)	107
Wheat soya milk (WSM)	108
Corn soya milk (CSM)	109
• Pulses	110
Beans, dried, shelled	110
Horse beans	111
Whole peas	112
Split peas	113
Lentils, dried, shelled	114
Chickpeas	115
• Edible oils	116
Oil, rapeseed	116
Oil, soya bean	117
Oil, sunflower	118
Oil, palm	119
Oil, butter	120
Margarine	121

CONTENTS

• Dairy products	122
Dried skimmed milk powder (DSM)	122
Dried whole milk powder (DWM)	123
Feta cheese	124
Milk, enriched, dried skimmed	125
• Meat and fish	127
Corned beef	127
Canned meat	128
Canned fish	129
• Miscellaneous	130
Biscuits	130
Biscuits, high protein	131
White sugar	132
Tea	133
Iodized salt	134
Dried yeast	135
Food basket	136
• Fumigation items	137
Fumigation sheet	137
Fumigants, aluminium phosphide	138
Fumigants, magnesium phosphide	138
Fumigants, methyl bromide	139
Fumigation kit	140
• Grain processing equipment	141
Hammer mill	141
Hand mill	142
• Packaging	143
Jute bags	143
Polypropylene bags	143
Jute/polypropylene bags	144
Multiple-ply paper bags	144
Plastic containers	145
<hr/>	
CHAPTER 5 - SANITATION AND HYGIENE ITEMS	147
<hr/>	
<i>Needs and recommended resonses</i>	<i>149</i>
• Refuse collection and disposal	151
Collection bins, plastic	151
Plastic bags	152
Body bag	153
Wheelbarrow	154
• Excreta collection and disposal	155
Sludge pump	155
Digging tool kit	156
Squatting plate	157
Wire, galvanized	157
Cement	158

CONTENTS

Reinforcing steel rods	158
Carpenter's tool kit	159
• Personal hygiene	160
Toilet soap	160
Toilet paper	160
Shampoo	161
Shampoo, medicated	161
Hygiene kit	166
• Washing and disinfection	163
Wash basin, plastic	163
Wash basin, steel	163
Laundry soap	164
Washing tubs, plastic	164
Disinfectant, calcium hypochlorite	165
Disinfectant, chloramine	165
• Vector and vermin control	166
Insecticides, propoxur	166
Insecticide, malathion	167
Insecticides, fenitrothion	168
Insecticides, fenthion	169
Insecticides, permethrin	170
Rodenticides, bromadiolone	171
Rodenticides, coumatetralyl	171
Rodenticides, warfarin	172
Sprayer, knapsack type	173
Sprayer, hand-held type	174
Fog generator, portable	175
Protective clothes/accessories kit	176
Sanitarian's kit	177
Mosquito screens	178
Impregnated bednets	178
• Drainage	179
Drains and drain fittings	179
Solvent cement for water pipes	179

CHAPTER 6 - MATERIALS HANDLING EQUIPMENT 181

<i>Needs and recommended responses</i>	<i>183</i>
• Lifting equipment	187
Gantry crane	187
Ball bearing trolley	187
Chain pulley block	188
Lifting sling	188
Winch	189
Jack	190
Ropes	191
• Transportation equipment	192
Hand truck	192

CONTENTS

Drum truck	193
Platform truck	194
Cage truck	195
Pallet truck, manual	196
Forklift truck, light duty	197
Forklift truck, medium duty	198
Dolly	199
Inflatable boat	200
Life-jacket	201
• Storage items	202
Storage rack	202
Cupboard	203
Scale	204
Ladder, aluminium	205
Gravity roller conveyor	206
Materials handling tool kit	207
Repacking tool kit	208
• Safety Equipment	209
Protective mask	209
Working gloves	209
Safety helmet	210
Hearing protector	210
Safety shoes	211
• General items	212
Hand saw	212
Circular saw	213
Snow chains for vehicles	214
Lead seal	215
Seal press	215
Roller crowbar	216
CHAPTER 7 - POWER SUPPLY SYSTEMS	217
<i>Needs and recommended responses</i>	<i>219</i>
• Power generators	221
Diesel generating set, 60 kVA, for 800/1000 shelters	221
Diesel generating sets, 5 kVA, for field offices	223
Portable generators, 0.3 - 0.7 kVA, for field telecommunications	225
CHAPTER 8 - LOGISTICS	227
<i>Introduction</i>	<i>229</i>
• Packaging	230
General	230
Outer packing	230
Inner packing	231
Other considerations	232

CONTENTS

Marking	233
• Quality inspection services	235
General	235
Terms and conditions for inspecting agency	235
Guidelines for selection of inspection agencies	236
• Shipping	237
General consideration	237
Methods of dispatch	237
Selecting the method of dispatch	239
Parties involved in the chain of transport events	239
Shipping documents	240
Incoterms	242
• Insurance	243
General	243
How to insure	243
Insurance documents	243
Insurance claims	244
• Forwarding arrangements	245
General	245
Dispatch arrangements by the buyer	245
Dispatch arrangements by the supplier	245
Dispatch arrangements through forwarding agents	245
• Transportation costs	246
General	246
Some cost comparisons	246
References	247
Index	251

NOTES

**CHAPTER 1 -
TELECOMMUNICATIONS EQUIPMENT**

NEEDS AND RECOMMENDED RESPONSES

General

The success of an emergency relief operation is highly dependent on an efficient communication network. Since the public telecommunication network will under an emergency situation often be saturated or out of order, the communication network for a relief operation should be based on equipment which is brought into the disaster area and which can work independent of local support. It is therefore extremely important that all the communication equipment to be used in the field is able to operate from a 12 VDC power supply, possibly supported by a solar power system or small portable generating sets (with output 12 VDC) as backup. The different communications systems needed in a disaster relief operation can normally be divided into three categories, each of which require different kinds of equipment:

- **Short-Range Communication**
Hand-held VHF radio systems to be used locally within a very limited distance from the base (2-10 km depending on the terrain).
- **Medium-Range Communication**
Portable and mobile HF radio equipment. VHF equipment with possible use of a repeater station can be used in a regional area.
- **Long-Range Communication**
HF radio and satellite equipment for communication with the outside world, HQ, etc..

The criteria for selection of specific equipment in each category are of course different and will therefore be treated separately.

Establishing or improving a telecommunication network is a complex process, and users of these guidelines should be aware of the fact that a working telecommunication network has to be adapted to the needs of the organization and local conditions.

Therefore, the establishment of a telecommunication network must be considered as a project in which technical expertise should be incorporated from the start, generally beginning with a field evaluation.

It is recommended that the present guidelines be given to the technical expert, and that he should be advised to follow, as far as possible, the proposed standardization for telecommunications equipment.

Short-Range Communication

a) Public Addressing (PA) Equipment

As one-way communication equipment, the hand-held power megaphone can be very useful when a large number of people assembled in a small area need to be informed simultaneously.

b) Hand-held & Base Station VHF Equipment

For short-range communication between individuals in a local area (normally within "line of sight"), and between these individuals and a base, it is essential to have a reliable, foolproof and professional radio-telephone system installed (often called a "walkie-talkie" system). The specifications for such a system are based on these criteria and are similar to the military specifications for such equipment. Attention should be paid to the confidentiality/privacy of all communication which are not encrypted.

NEEDS AND RECOMMENDED RESPONSES

Medium-Range Communication

When communication beyond the immediate area around the base is needed, the equipment described above needs to be supplemented with additional equipment. In order to cover a larger region around the base and overcome the "line of sight" limitations for the VHF equipment, it will often be necessary to use VHF repeater station equipment and make use of mobile VHF and HF equipment.

The mobile equipment is often the same as that used at the base station, but with the hardware modified for vehicle installation. The criteria for choosing the specifications for this equipment are therefore the same as those mentioned above, i.e. reliable, foolproof and professional equipment (with specifications similar to military specifications requirements).

Long-Range Communication

For long-range communication there are basically two different methods to choose from: HF-radio systems or satellite systems. Each method requires completely different types of equipment with advantages and disadvantages as explained below.

a) HF-Radio Systems

HF-radio (shortwave radio) is the traditional method for medium and long-range voice and telegraphic communication. However, today's technology offers more sophisticated services required for data communications by means of HF-radio based systems.

HF-radio system allows voice and "error free" data communication (e.g. AMTOR, SITOR, PACTOR, SKYFAX, etc.) An HF-radio station in the field can communicate either with other stations of your own network (including a base station at your headquarters), or through public marine and aeronautical services coast or ground stations, with the public communication networks (phone, telex). While communications within your own network will normally be free of charge, coast or ground stations will charge a fee for handling your traffic. It is advisable to make arrangements with the above for such services.

Apart from the fact that the transmission can sometimes be seriously affected by propagation and interference, the disadvantage of an HF-radio system is the need for a trained technician to install and line up the equipment and antennas. It should also be mentioned that, in some parts of the world, the allocation of HF radio frequencies by authorities can be a rather complicated and time-consuming procedure, and will normally require a trained technician to operate the system.

To select the most suitable antenna system, advice from a qualified technician is strongly recommended, and required during the installation process. Technical specifications of three commonly used antenna systems have been included.

The specifications for HF-radio systems have been selected on the basis of long-term experience which various UN agencies and other international relief organizations and embassies have had with this type of equipment. Special consideration has in all cases been given to their reliability and suitability for field use.

b) Satellite Systems

Within the last ten years, long-range telecommunication has been revolutionized through the use of satellite systems, which provide the most reliable, high-quality wireless communications available today.

Systems of special interest for emergency relief operations are those based on the Standard-C and Standard-A terminals of the INMARSAT mobile satellite service. The VSAT networks using the more powerful

NEEDS AND RECOMMENDED RESPONSES

INTELSAT and EUTELSAT systems are not, at the moment, considered suitable for emergency relief purpose, as they cannot be accessed by portable terminals.

For all kind of satellite terminals, registration with PTT authorities is required before the terminal can be used. Registration, of course, ensures that all communication via the satellite can be invoiced to the owner of the terminal. This is a significant difference and disadvantage of satellite communication when compared to HF-radio. Communication by satellite can be very expensive, the average fee being about five times the cost of HF coast radio services.

* INMARSAT-A

The standard-A terminal provides telephone, telefax, telex and low speed data facilities between the terminal and the international telecommunication network via a satellite and a suitable Land Earth Station (LES). Certain types of standard A-terminals can be equipped with an optional High Speed Data (HSD) system, thereby providing 56 or 64 kbit/s data transmission rates which enable compressed (Store and Forward) video transmission and multi-channel voice, data and telefax connections. Standard-A terminals are portable and relatively easy to set up for operation, but due to the directional parabolic antenna they cannot be used in a mobile situation. Confidentiality of communications via standard-A stations is low, and eavesdropping on this system is easily achieved.

* INMARSAT-B

Standard-B terminals offers the same facilities as INMARSAT-A systems, but uses digital communication technology. Features include high-speed data communication as standard and lower communication costs. Unlike standard-A high confidentiality can be achieved by using channel coding techniques. Although standard-B is expected to replace standard-A, the services have only become operational since 1995, and does not feature in this catalogue.

* INMARSAT-C

The standard-C terminal provides access to the international telex network and can also be used for transmitting data files, but no voice or telefax communication is possible. Text can however, be transmitted from the standard-C terminal to the PSTN (public telephone network) and received as a telefax. Standard-C terminals are available in portable and very compact models with an omnidirectional antenna which makes them very easy to install and operate (also mobile models). They are therefore, very well suited for emergency relief operations.

* INMARSAT-M

Standard-M terminals are light-weight (attache case sized) and provide telephone links only. Telefax is possible, but the low data rate would result in very high communications costs. The equipment is highly complex, as the system is digitized

The specifications selected for satellite terminals take into consideration previous UN- experience with this equipment.

To provide an overview for selecting the most suitable communication system for a special case, a schematic diagram has been drawn depicting the different options mentioned in the text above.

Power Source

The power source for telecommunications equipment is often one of the following types depending on the location where the systems are operated:

NEEDS AND RECOMMENDED RESPONSES

- Battery
- Generating set
- Solar power

The commonly used source is a battery, which can be charged regularly with a charger. Power for battery recharging can be drawn from the mains, the engine of a running vehicle or from a gasoline generator.

Typically however, when telecommunications equipment is utilized in emergency situations the regular provision of electric power is uncertain. In such cases, it is better to rely on small self-contained generating sets. Solar energy, also known as photovoltaics, is a mature technology that has already proved its reliability in numerous situations. The capital cost, however, is much higher and requires a skilled technician for maintenance and repairs.

NEEDS AND RECOMMENDED RESPONSES

• Schematic diagram showing communications systems for emergency operations

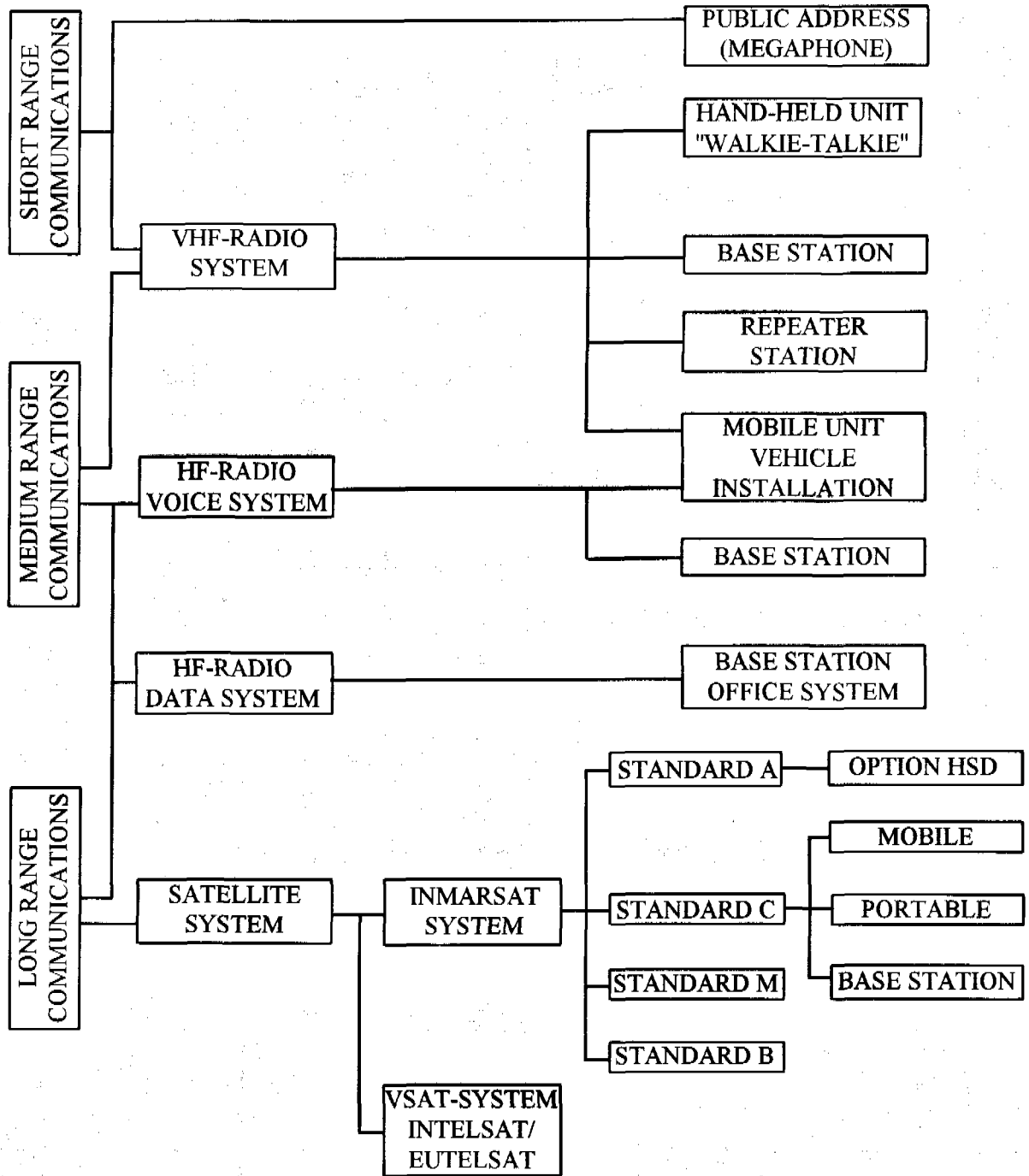

Type	Range	Size/Weight	Cost	Remarks
VHF (Voice)	3 - 25 km (line-of-sight)	Hand-held or mobile unit VHF Kit: 6 hand-held & 2 mobile/base units weight: 48 kg	400 - 700 \$ per unit 12,000 \$ per set	For on-site co-ordination and individual communications for safety and security of field personnel. Range depends on terrain and is larger for mobile/fixed stations than for hand-held units.
VHF (with repeater)	10 - 50 km	Repeater: 10 kg	Units as above Repeater 3000 \$	Repeater increases the range of VHF communication, particularly in urban and mountainous territories. Repeater needs to be installed in a high location (hill, building) and by a qualified technician.
HF (Voice)	Regional to world-wide	Portable: 10 kg Fixed: 20 kg	4,000 \$ per station no fees	Commonly used for regional communications, 50 to 1,000 km, no communications fees unless used for phone through commercial land-stations.
HF (teletype)	Regional to world-wide	Fixed: 25 kg	7,000 \$ per station, no fees	Reliable teletype (sitor) provides links world wide. Requires a qualified operator. No communications fees unless messages are routed through commercial land-stations.
Satellite Inmarsat A	World-wide Phone/Fax (Telex/Data)	Suitcase set: 20 kg Fax, power supply etc. extra	30,000 \$ per station, fees 8 \$ per minute	Full phone and fax capability, telex with laptop, high-speed-data capability optional. Expensive to purchase and to operate. Telex far more expensive than on C. Complete transportable communication facility.
Satellite Inmarsat B	World-wide Phone/Fax (Telex/Data)	Lighter and smaller than Inmarsat A	Expected to be lower than Inmarsat A	To be introduced by 1995 and expected to replace Inmarsat A by the year 2000. Lighter and possibly less expensive than Inmarsat A.
Satellite Inmarsat C	World-wide Telex/Data	Suitcase set: 20 kg	7,500 \$ per station, fees similar to telex, but calculated per kbyte, not per minute. 1 \$ per kbit	Sends messages to any telex or fax machine, receives messages from any telex machine or C terminal. Can send and receive data (ASCII files). Storage-and-forward only, no dialogue possible.
Satellite Inmarsat M	World-wide Phone (Fax)	Attache-case set: 5 - 10 kg	18,000 \$ per station, fees approx. 5.5 \$ per minute	Digital voice communication with very narrow band-width ("computer voice"), with phone network fax extremely slow. Partially operational as of late 1994. Light weight equipment.

• Summary table of systems

NEEDS AND RECOMMENDED RESPONSES

PUBLIC ADDRESS EQUIPMENT

MEGAPHONE, HAND-GRIP TYPE

Indicative unit price: USD 60
Shipping weight: 1 kg
Shipping volume: 0.03 m³
UNCCS Code: 472341

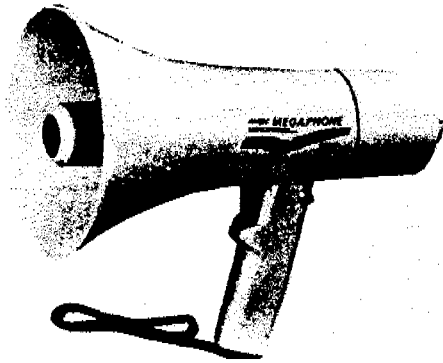

Type: Handheld with built-in microphone volume control and alarm switch in handgrip. Suited for small group of people (20-30 persons).

Audible range: * City areas - 250 m (min)
* Suburban - 800 m (min)

Output power: 6 - 10 W

Power source: 12 VDC

Accessories required: Batteries, size "AA", 8 pieces

MEGAPHONE, SHOULDER TYPE

Indicative unit price: USD 120
Shipping weight: 1.5 kg
Shipping volume: 0.04 m³
UNCCS Code: 472342

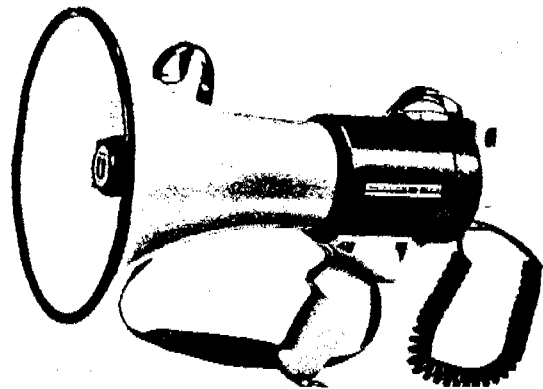

Type: External input connection to microphone, tape recorder or recorder or record player. Handheld microphone with on/off switch and built-in volume control.

Audible range: * City areas - 400 m (min)
* Suburban - 1.3 km (min)

Output power: 10-16 W

Power source: 9 or 12 VDC

Accessories required: Batteries, size "C", 8 pieces

PUBLIC ADDRESS EQUIPMENT

PUBLIC ADDRESS (PA) SET, MOBILE

Indicative unit price: USD 200
Shipping weight: 3.5 kg
Shipping volume: 0.1 m³
UNCCS Code: 472352

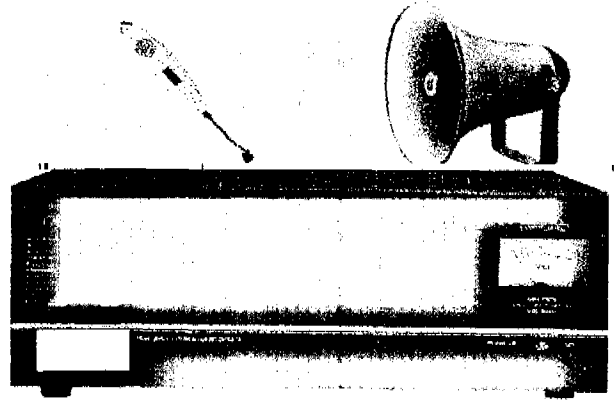

Type: Mobile (vehicle mounted) PA - amplifier with hand-held microphone and two horn speakers for outside vehicle mounting including cables.

Output power: 10-15 W or 20-30 W

Power source: 12 VDC

PUBLIC ADDRESS (PA) SET, FIXED INSTALLATION

Indicative unit price: USD 800
Shipping weight: 20 kg
Shipping volume: 0.3m³
UNCCS Code: 472353

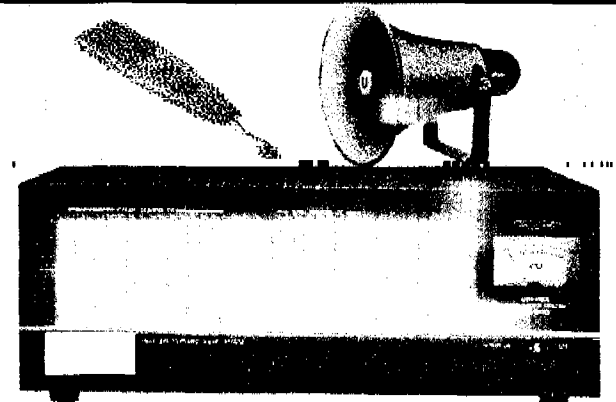

Type: Desktop PA-amplifier with connections for microphone, speakers, tape recorders or record player. Suited for indoor or outdoor groups of people up to approx. 750 persons.

Output power: Minimum 60 W (Rated)

Power supply: * 110 / 220 VAC 50/60 Hz and
* 24 VDC (battery operation)

Speakers: Minimum two pieces directional reflex horns with driver units and extension cables

Microphone: Dynamic type microphone with extension cables

VHF EQUIPMENT : TRANCEIVER, HANDHELD

Indicative unit price: USD 500
Shipping weight: Approx. 0.5 kg
Shipping volume: Approx.
50x150x130 mm
UNCCS Code: 467651



Basic specifications: Portable VHF - FM Transceiver, compact, light weight, microprocessor controlled, housed in rugged casing, rubber antenna & CTCSS control unit built- in

Area of use: In-between individuals and base normally, within "line of sight" and maximum approx 10 km depending on the terrain.

Frequency range: VHF: must include 154 - 166 MHz

Channel: Minimum 6 programmable

Channel spread: Minimum 10

Channel spacing: 25 kHz

Receiver sensitivity: Better than 0.35 μ V at 12 dB/SINAD

Power output: Selectable high/low (on high minimum 2 W)

Power supply: 7.2 V or 12 V Ni-Cd batteries (rechargeable), min. 600MAh.

Standard accessories:

- * Spare battery
- * 110 - 220 VAC rapid charger with automatic charging control
- * Carrying case with shoulder strap
- * 5 tone selective call-paging
- * Equipment for programming
- * Belt clip

Accessories
(for some units only):

- * Mobile DC adapter/charger
- * Speaker/microphone

VHF EQUIPMENT: TRANSCEIVER, BASE STATION

Indicative unit price: USD 550
Shipping weight: Approx. 1.5 kg
Shipping volume: Approx.
140x40x175 mm
UNCCS Code: 467653

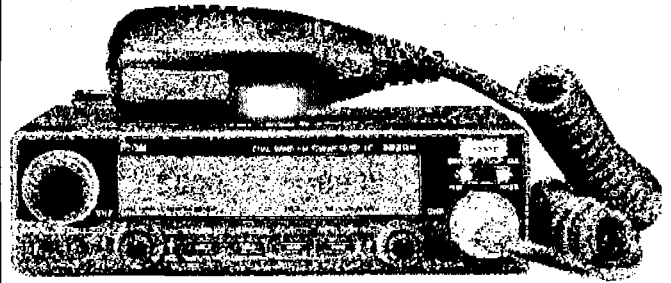

TRANSCEIVER

Type: VHF FM transceiver of rugged construction, synthesized, selective channel scanning, and a built in CTCSS controller.

Area of use: Communication in a local area up to approx. 50 km depending on the terrain

Frequency range: Must include 154 - 166 MHz

Channels: Minimum 8, programmable

Channel spread: Minimum between 154 - 166 MHz

Channel spacing: 5 or 12.5 or 25 kHz

Receiver sensitivity: Better than $0.35\mu\text{V}$ at 12 dB/SINAD

Power output: Minimum 25 W

Power supply: 12 VDC

Options:

- * Equipment for field programming
- * 5-tone selective call

BASE STATION ANTENNA

Frequency range: 146 - 174 MHz, adjustable

Gain: Minimum 5 dB

Fitted with lowloss coaxial cable (less than 5 dB/100 m at 150 MHz) with necessary connectors.

VHF EQUIPMENT: TRANSCEIVER, VEHICLE

Indicative unit price: USD 600
Shipping weight: Approx. 1.5 kg
Shipping volume: Approx.
140x40x175 mm
UNCCS Code: 467652

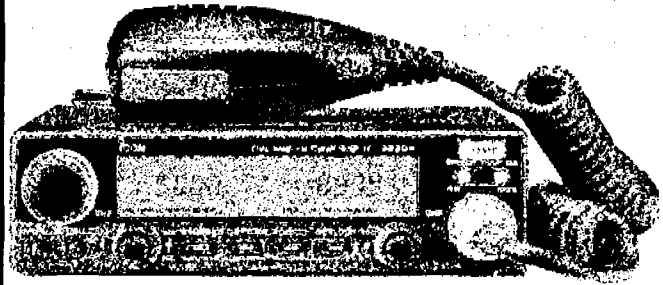

TRANSCEIVER

Type: VHF FM transceiver of rugged construction, synthesized and selective channel scanning, including brackets and other vehicle installation, CTCSS control unit built-in

Area of use: Communication in a local area up to approx. 50 km depending on the terrain.

Frequency range: Must include 154 - 166 MHz

Channels: Minimum 8, programmable

Channel spread: Minimum 10 MHz

Channel spacing: 25 kHz

Receiver sensitivity: Better than 0.35 μ V at 12 dB/SINAD

Power output: Minimum 25 W

Power supply: 12 VDC

Options:

- * Key pad encoder
- * Equipment for field programming

VEHICLE ANTENNA

Frequency range: 146 - 174 MHz, adjustable

Gain: Minimum 5 dB

Fitted with 5 m coaxial cable RG - 58 and PL - 259

In some vehicles it is easier to install the antenna on the rooftop rather than on the side - and in this case the antenna should be of a size that avoids contact with low hanging power lines and tree branches.

VHF EQUIPMENT: REPEATER STATION

Indicative unit price: USD 2,000
Shipping weight: Approx. 20 kg
Shipping volume: Approx.
480x150x400 mm
UNCCS Code: 467683

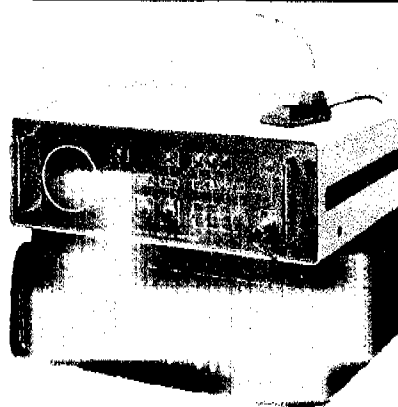

Type: VHF repeater in rugged construction preferably with CTCSS decoder and duplexer

Area of use: To increase the range and capability of handheld VHF equipment up to approx. 50 km and the other VHF equipment to approx. 60 km depending on the terrain.

Frequency range: 154 - 166 MHz (preferable)

Channel: Factory aligned to a specified transmission and reception frequency

Channel spacing: 25 kHz

Frequency separation: 4.6 to 5.5 MHz

Power output: Minimum 10 W

Power supply:

- * 110 - 230 VAC
- * 12 VDC with automatic switching

Antenna: Base station antenna, to match programmed transmission frequency
Gain: Minimum 5 dB

Options:

- * Power amplifier
- * Time-limiter
- * Battery charger, 12 V, 10 A
- * Heavy duty battery 12 V / 100 AH

Accessories: Equipment for field programming

Note: Antenna should be specified according to frequencies to be used.

VHF EQUIPMENT: VHF FIELD KIT

Indicative unit price: USD 8,000
Shipping weight: 10 kg
Shipping volume: 0.1 m³
UNCCS Code: 467685

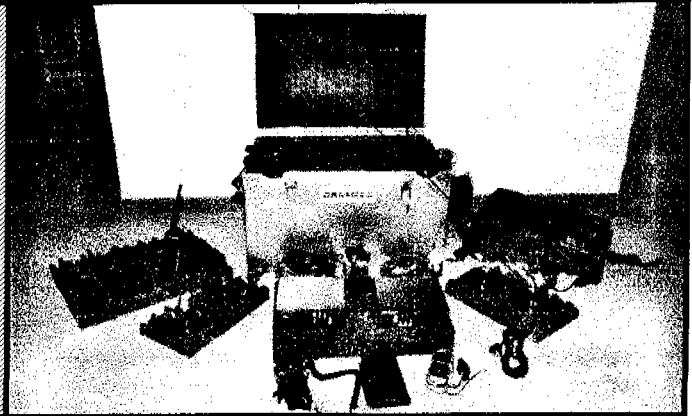

Type: VHF field kit

- To be included:**
- * 6 handheld VHF transceivers conforming to the specifications for UNCCS 467651, but with only one programming unit including software
 - * 2 mobile VHF transceivers conforming to the specifications for UNCCS 467652, but with only one programming unit
 - * 4 mobile antennae with magnetic mount including 2 x 6 metre cable RG-58 and 4 adaptor plugs for handheld transceiver
 - * 2 base station antennae modified to reduce packing size below 50 cm including 2x20 metre cable RG-58 and plugs
 - * 2 adapters for cigarette lighters in car for handheld VHF transceivers, cable attached to adaptor
 - * 1 AC distributor for 6 chargers and adaptor set
 - * 1 extra automatic charger for AC & DC
 - * 1 instruction and service manual for the handheld and mobile transceivers and for the programming units
 - * 1 waterproof aluminium transport box for storage of telecommunications items as below

The individual items in the kit are stored in four layers in the transport box, each of which contains a specific group of material:

- Top layer:** 6 handheld VHF transceivers
- Second layer:** 6 battery chargers
- Third layer:** 2 mobile antennae with magnetic mount and 2 base antennae, cables and adaptors
- Bottom layer:** 2 VHF transceivers with higher power and equipment to programme additional channels on all transceivers

The layout is such, that the most urgently needed and immediately usable items are on top, while the equipment which offers additional possibilities but needs a minimum amount of installation work is stored further down. All items are however accessible at all times, as the layers can be lifted out one by one and can be inserted in any other sequence as well.

HF EQUIPMENT: TRANSCEIVER, RADIO VOICE SYSTEM

Indicative unit price: USD 3,500
Shipping weight: Approx. 10 kg
Shipping volume: Approx. 290x110x360 mm
UNCCS Code: 467654

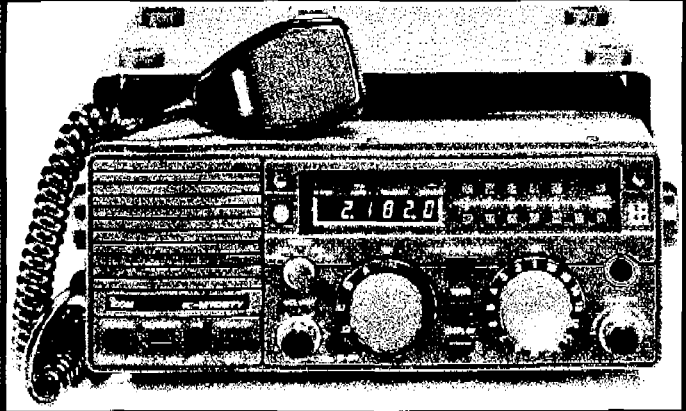

Type: Light weight base station of rugged construction

Input power: 10 - 15 VDC, standby consumption to be lower than 1A at 12 V

Frequency range: 2 to 24 MHz (receive and transmit)

Operating range: -50°C to +50°C, up to 90% humidity

Frequency control: Minimum 25 front-panel programmable channels, simplex and operation mode

Modes of operation: Transmit and receive: J3E (USB and LSB)

Transmitter: Output power: 100 W pep minimum in SSB

Receiver:
 Sensitivity: Better than 0.5 microV for 12 dB sinad in SSB
 Selectivity: 2.3 kHz/-6 dB (SSB)
 Image rejection: 70 dB or better
 Clarifier: With central detent, approx. ± 150 Hz

Additional features:

- * Programmable scanning facility for all channels
- * Protection against inversion of polarity
- * Protection against overvoltage
- * Automatic fuses or easily accessible interchangeable fuses with spare fuses delivered as part of a standard package.
- * Automatic antenna tuner (Integrated or external)

Optional features: Self-call (protocol to be compatible)

HF base station antenna: See antenna systems for HF radio communications, pages 19 - 23

HF EQUIPMENT: TRANSCIVER, TRANSPORTABLE

Indicative unit price: USD 4,500
Shipping weight: Approx. 4 kg
(incl. control head)
Shipping volume: Approx. 250x320x80 mm
(transceiver)
Approx. 190x75x50 mm
(control head)
UNCCS Code: 467655



TRANSCIVER

Type: Solid state HF transceiver of rugged construction. Synthesized, programmable with built in receiver scanning facility

Frequency range:

- * 2 - 24 MHz (min) - base station
- * 3 - 18 MHz (min) - mobile station

Receiver selectivity: Greater than 60 dB at -1 kHz and +5 kHz

Channels: 25 front-panel programmable channels

Mode of operation: J3E (USB and LSB)

Operating range: -30 to +60 degrees °C at 90% humidity

Transmission Output: 100 W pep

Power requirements: 10-15 VDC, reverse polarity and overvoltage protection

Options:

- * Selcall (Protocol to be compatible)
- * Extended control head with mounting
- * Bracket for vehicle installation

HF VEHICLE ANTENNA

Frequency range: To cover the range in operation

Sturdy construction to withstand rough road driving, automatically tuned and complete with installation hardware. (must be waterproof, i.e. unaffected by river fords)

HF EQUIPMENT: RADIOTELEX DATA TRANSMISSION SYSTEM

Indicative unit price: USD 8,500
Shipping weight: Approx. 15 kg
Shipping volume: Approx. 0.05 m³
 (excl. antenna)
UNCCS Code: 467684

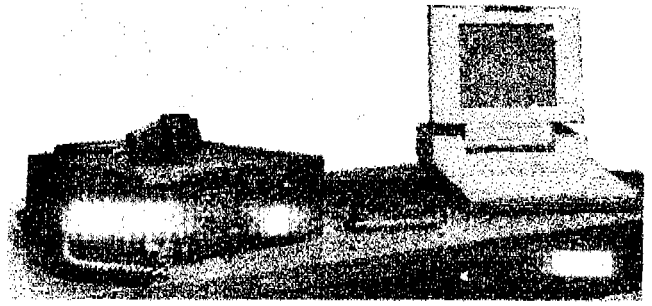

- Type:** Data transmission via a HF-radio connection using the PACTOR A system.
- Area of use:** SITOR and PACTOR are communication systems whereby low speed data information can be transmitted over a HF-radio connection.
- Power supply:** 12 VDC
- HF-Transceiver:** Suitable for SITOR/PACTOR (see specifications of HF-Transceiver)
- HF-Modem:**
- | | |
|--------------------|--|
| Type: | High speed PACTOR, incl. software on 3.5" diskette, interface cables and operation manual. |
| Throughput: | 200/100 bps |
| Com. modes: | PACTOR ARQ, FEC, MONITOR, SITOR ARQ, SELFEC |
| Modulation: | FSK/AFSK |
- Computer equipment:**
- | | |
|------------------|--|
| Computer: | <ul style="list-style-type: none"> * RAM; 1 Mb (min) * 1 floppy drive 3.5" 1.44 Mb * 20 Mb hard disk (min) * Working from 12 VDC * Serial RS232 and parallel Centronics Interface * Socket for 12 V external supply, including mains battery charger |
| Printer: | <ul style="list-style-type: none"> * 9-pin matrix print head, or bubble-jet printer * Parallel PC connection * Draft printing speed 120 characters/sec * Ribbon cartridges for matrix printer or printer heads if it is a bubble jet printer. * Modified for 12 VDC operation * Accessories for printer: <ul style="list-style-type: none"> - Paper roll holder - Spare cartridge |
- Power equipment:**
- | | |
|---------------------------|--|
| Battery charger: | 12V/25A or |
| Generating set: | 350W or |
| Solar power supply | (see Solar Panel specifications for further details) |
- Antenna equipment:**
- | | |
|-----------------|--|
| Antenna: | Delta-loop, broad band or log periodic antenna (see antenna specifications for further details. |
| * | Accessories for antenna: <ul style="list-style-type: none"> - Heavy duty antenna coupler control cable, 25 meters long - SWR/power meter, frequency range 2 - 30 MHz |

ANTENNA SYSTEM FOR HF RADIO COMMUNICATION: BROADBAND ANTENNA

Indicative unit price: USD 300
Shipping weight: Approx. 20 kg
Shipping volume: Approx. 0.16 m³
(packed in carton)
UNCCS Code: 475431

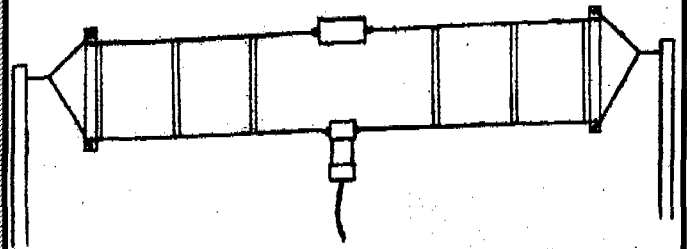

Type: Broadband antenna

Area of use: For medium-range point to point and base to mobile communication. The advantage is that it can be used with natural available support systems such as buildings, high trees and free-standing masts. It is relatively simple and easy to erect and does not require an antenna tuner.

Typical kit:

- * 1 Antenna
- * 1 Roll of 100 m nylon rope, Ø 5 mm
- * 2 Mast holders
- * 2 Wire holders
- * 4 Raw plugs with hook screw
- * 50 Union screws
- * 8 Turn buckles
- * 20 Protective rings
- * 8 D shackles
- * 5 Complete raw plugs
- * 30 m Coaxial cable RG-58U

Note: For temporary installations where available support structures can be used, the above mentioned kit could be reduced to consist of only a few necessities such as rope and connectors to fix the mast.

ANTENNA SYSTEM FOR HF RADIO COMMUNICATION: DELTA LOOP ANTENNA

Indicative unit price: USD 1,000
Shipping weight: Approx. 10 kg
Shipping volume: Approx. 0.02 m³
 (packed in carton)
UNCCS Code: 475432

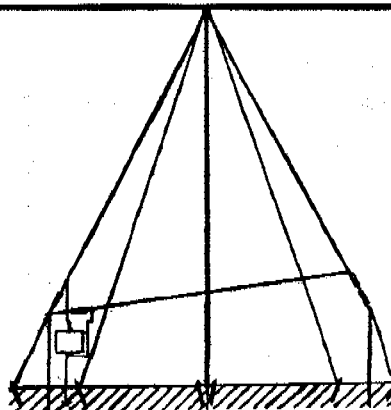

Type: Delta loop antenna

Area of use: For a semi-permanent or fixed base station installation, where an antenna system needs to be erected quickly and easily for multi-frequency operation, a delta loop antenna is most often chosen. A delta loop antenna can only be used with an associated antenna tuner, preferably automatic.

Wind and ice survival: Wind: 100 mph (160 km/h)
Ice-accumulated: 40/50 kg (90/110 lbs)

Typical kit: Standard version for wall mounting

- * 30 m Multistrand (49x0.2 mm) copperweld wire
- * 1 10.2 m telescopic mast
- * 6 Insulators
- * 2 Variable wall brackets
- * 100 m Guywire
- * 1 Guywire bracket
- * 10 Guywire clamps
- * 1 Ground bracket
- * 50 m Coaxial cable RG58 fitted with 2 UHF PL259
- * 8 Spring safety hooks
- * 6 Plastic dowels
- * 5 Wall dowels
- * 1 Mounting instructions manual

Extending kit: For field installation

- * 2 2 m masts
- * 2 Guyrope brackets
- * 8 Ground spikes
- * 4 Ground spikes for mastfoot
- * 4 Hooks
- * 4 Guywire clamps
- * 1 Swivel mastfoot
- * 2 Fixed mastfeet

Note: In some cases the above mentioned kit is too extensive - locally available mast material, plenty of good nylon rope, 6 ceramic insulators and about 30 meters of insulated stranded 4 mm² is often enough to make up the loop. A few meters of solid copper wire 4 mm² should also be included to make up egg-chains and for general use.

ANTENNA SYSTEM FOR HF RADIO COMMUNICATION: AUTOMATIC ANTENNA TUNER

Indicative unit price: USD 500
Shipping weight: Approx. 5 kg
Shipping volume: Approx. 0.02 m³
(packed in carton)
UNCCS Code: 475434

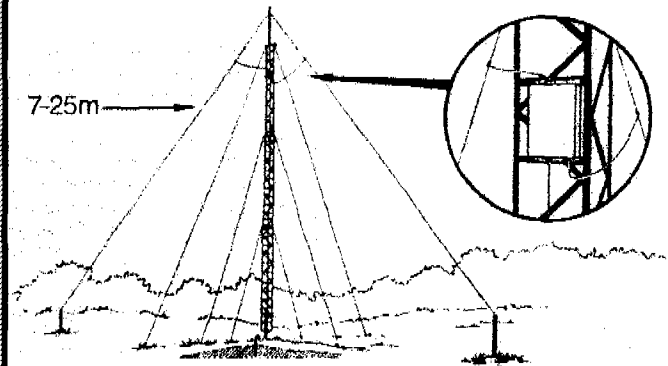

Area of use: To be used with a delta-loop antenna as a substitute to the broadband antenna. In very dry areas the delta-loop performs much better as it does not have to rely on a good grounding. It is furthermore less susceptible to high level interference as it is made resonant with the help of the automatic antenna coupler - attenuating unwanted frequencies.

Frequency range: 2-30 MHz

Power capability: 150 W pep

Input impedance: 50 Ohms

Tune-up power: 5-15 W

Tune-up time: 1-2 sec

Power supply: From transceiver (negative ground)

Construction: Weather-proof

Accessories: 50 m control cable

ANTENNA SYSTEM FOR HF - RADIO COMMUNICATION: LOG PERIODIC ANTENNA

Indicative unit price: USD 3,500
Shipping weight: Approx. 38 kg
Shipping volume: Approx. 3 m³
 (packed in carton)
UNCCS Code: 475433

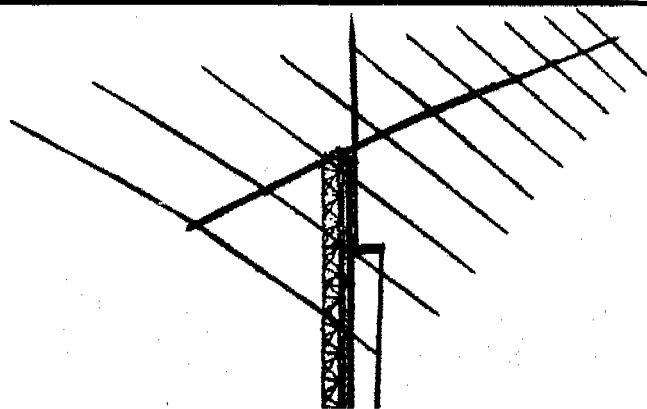

- Type:** Log periodic antenna:
- Area of use:** A log periodic antenna is suitable for communication over medium and long distances where a more sophisticated antenna system is required. It needs, however, a solid mast or tower of minimum 8 meters and is therefore most often used with permanent or semi-permanent installations.
- Frequency range:** 10-30 MHz
- Power capability:** 1.5/3.0 kW pep
- Forward gain:** (Nominal) approx. 10 dB
- Input impedance:** 50 Ohms
- Azimuth beam width:** Nominal 58 degrees (at half power point)
- Angle of maximum radiation:**
- | | |
|-----------------|------------|
| Low frequency: | 20 degrees |
| High frequency: | 8 degrees |
- Accessories:**
- * Hoisting mast, minimum 8 m
 - * Rotor system, complete with control box and fittings
 - * Multicore remote control cable: 50 m x 10 x 1 mm²
 - * Ground wire: 20 m x 1 x 4 mm²
 - * Coaxial cable: 50 m, RG 213
 - * Automatic antenna tuner (see delta loop antenna for more information)
- Comments:** As cranes are often not available to mount such an antenna, a tilting type mast (i.e. VERSA tower) is recommended.

SATELLITE EQUIPMENT: INMARSAT, SYSTEM A

Indicative unit price: USD 25,000
Shipping weight: Approx. 25 kg
Shipping volume: Approx. 0.1 m³
UNCCS Code: 467431

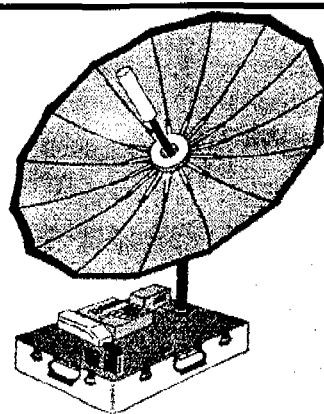

- Type:** INMARSAT approved STANDARD A
- Area of use:** To provide telephone, telefax, telex and data facilities between the terminal and the international telecommunication networks
- To include:** Dual identity number, control keyboard and telephone handset, parabolic dish antenna including wall brackets, visual and/or acoustic signal strength indicator (to facilitate positioning of antenna), printer, power cable and interconnecting cable, operating manual, fax machine, DC/AC 12/220 V inverter (inverting output rating: minimum 300 W sufficient to power the STD-A terminal plus a connected fax machine), laptop computer for telex and log printout, extension low-loss coaxial cable for parabolic dish (5 m)
- Modes of operation:**
- Full duplex telex:** 50 bauds 66.6 wpm
 - Full duplex telephone:** Meeting CCITT requirements
 - Full duplex fax:** To 9600 bauds using voice channel
 - Full duplex data:** To 9600 bauds using voice channel for use with an external modem
- Environment:**
- Operating temperature:** * Antenna: -25 to +55 degrees °C
 - * Electronic: 0 to + 45 degrees °C
 - Relative humidity:** * Antenna: 95% at 40 degrees °C
 - * Electronic: 85% at 40 degrees °C
- Antenna and outdoor-unit must be weather proof
- Power supply:** 90 - 240 VAC; 50 - 60 Hz
- Transportability:** Packed in robust (shock protected) hand case
- Options:**
- * Connector for second identity (fax)
 - * High Speed Data (HSD) 56/64 kbits/sec
- Accessories:**
- * Wall brackets for parabolic dish
 - * 10 to 150 metres extension low-loss coaxial cable for parabolic dish depending on the manufacture and the use of the equipment
 - * Laptop computer for telex and log printout
- Running cost:**
- * Approx USD8/minute peak time
 - * Approx USD5/minute off peak time

SATELLITE EQUIPMENT: INMARSAT, SYSTEM C

Indicative unit price: USD 7,500
Shipping weight: 14 kg
Shipping volume: 0.04 m³
UNCCS Code: 467432

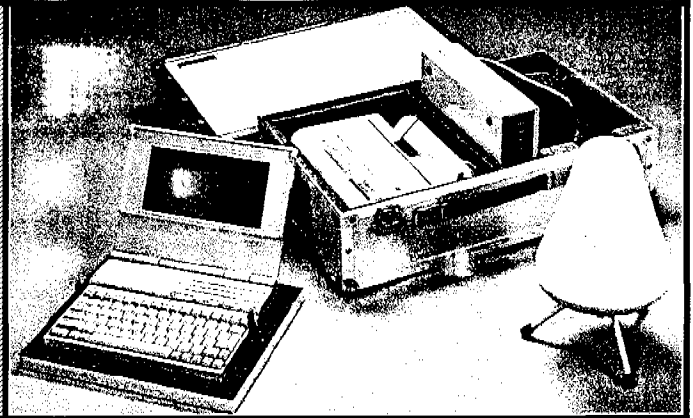

- Type:** INMARSAT approved STANDARD C
- Area of use:** To provide access to the international telex, data and other networks and to transmit data files.
- To include:** Rugged and compact land-mobile satellite transceiver supporting 2-way telex- and data transfer in addition to 1 way compressed telex, X25 and PSTN (sending text to a telefax) Standard interface to Data Terminal Equipment printers and logging system
- Environment:**
- Electronic unit:** -25°C to +55°C (operating)
 - Antenna unit:** -35°C to +55°C (operating)
 - Relative humidity:** 95% non condensing at 40°C
 - Weather resistance:** Antenna only
- Power supply:**
- * 10.5-32 VDC
 - * 110-240 VAC
- Accessories:**
- Office installation: * Laptop PC with AC-charger
 - * Mobile printer and AC/DC supply
 - * Integrated land-mobile GPS omnidirectional antenna
 - Mobile system: * Mobile truck terminal
 - * Data interface box and mobile printer
 - * Integrated land-mobile GPS omnidirectional antenna
 - * GPS interface - and operations package
 - * Automatic data - and position reporting/polling
 - Portable system: * Flight case with AC/DC charger and lead/acid batteries
 - * Laptop PC and diconix printer
- Running cost:** Approx USD1/kbit

SATELLITE EQUIPMENT: INMARSAT, SYSTEM M

Indicative unit price: USD 14,000
Shipping weight: Approx. 14 kg
Shipping volume: Approx. 0.02 m³
UNCCS Code: 467433

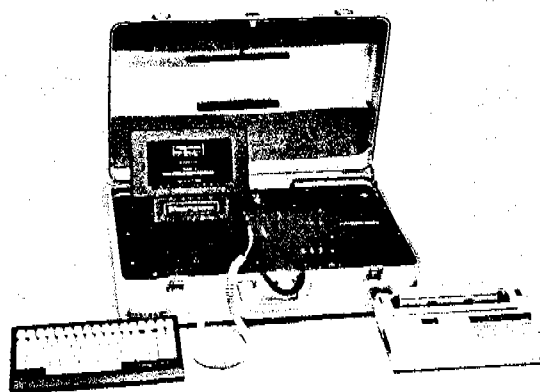

- Type:** INMARSAT approved STANDARD M
- Area of use:** To provide voice, fax and data access facility in a small portable briefcase.
- To include:** Hard shell briefcase with built-in antenna, battery, battery charger, compass, transceiver and operation manual
- Environment:**
- Operating temperature:** -25°C to +55°C (operating)
 - Humidity:** Up to 95% non condensing at 40°C
- Power supply:**
- * 10.5-32 VDC
 - * 90 - 240 VAC at 50/60 Hz with AC/DC connector
- Channels:**
- Voice channel:** INMARSAT standard
 - Fax channel:** G3-standard, 2400 bps
 - Data Channel:** 2400 bps
- Features:** Extra phone/fax port
- Running cost:**
- * Approx USD 5.5/minute, peak time
 - * Approx USD 3.5/minute, off-peak time
- Accessories:**
- * Portable fax machine equipment
 - * Up to 15 meters antenna cable

POWER SOURCES: GENERATORS

Indicative unit price: USD 510
Shipping weight: 10 kg
Shipping volume: 0.02 m³
UNCCS Code: 461140

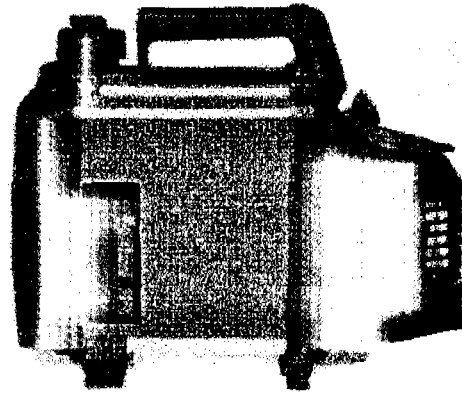

Type: Portable petrol generator, both AC and DC output

Area of use: Can be used as a power generator and as a battery charger.

Output: Voltage: 220 VAC
12 VDC
Frequency: 50 Hz
Power: Minimum 300 W

Engine: * 2 stroke, petrol engine, Air cooled
* Consumption approx 0.3 litres/h

Tank: Minimum: 0.8 litres

Options: * Manual switch to select between AC or DC output
* Battery charger built in.

Accessories: Cables and connectors included

POWER SOURCES: SOLAR POWER SUPPLY KIT

Indicative unit price: See below
Shipping weight: See below
Shipping volume: See below
UNCCS Code: 466541

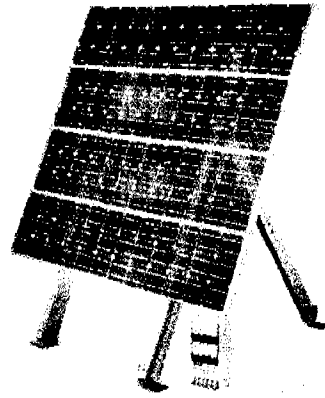

Type:	Heavy duty	Light duty
Indicative unit price:	USD 3,500	USD 1,100
Shipping volume:	0.2 m ²	0.1 m ²
Number of panels:	2	1

Area of use: Power supply for 12 VDC telecommunication equipment.

Rated: Heavy duty: 5.4 A, 65 W
 Light duty: 2.7 A, 32 W

Contents of solar kit:

- * Solar panel
- * Mounting frame
- * Anti-bird spikes
- * 6 meter long heavy duty twin core cable
- * Battery lugs
- * Regulator containing minimum:
 - * Volt/ampere meter
 - * High/low voltage indicator
 - * 50 amps battery fuse
 - * 30 amps load control fuse, outdoor enclosure
 - * Adjustable overcharge timer

Cabling and plugs:

- * 6 m single core 4 mm² cable (intermodule cabling)
- * 50 m double core 2.6 mm² power cable (array to charge controller and from charge controller to load)
- * 100 pieces cable clip
- * 100 pieces plastic plugs
- * 10 plastic strips
- * 1 piece isolation tape
- * 2 pieces plugs of mil. standard (for the array cable and the load cable into the battery box)

The storage of the power should be on a 12V batteries with capacity of minimum 200Ah

NOTES

**CHAPTER 2 -
SHELTER, HOUSING, STORAGE
AND HOUSING APPLIANCES**

NEEDS AND RECOMMENDED RESPONSES

General

This chapter covers following areas:

- Shelter and housing
- Bedding
- Kitchen accessories
- Lighting equipment
- Heating equipment

Clothing is not covered by this chapter for the following reasons. Often used clothing is commonly offered in emergencies but is generally an unsatisfactory means of meeting the need for clothing and should be discouraged. Experience suggests that much will arrive in poor shape, some will be dirty and badly sorted and little will be appropriate to the customs of the refugees. Furthermore, due to its volume, it is expensive to store and transport. First priority for meeting clothing needs should be the provision of fabrics for clothing that can be prepared by the people locally. For these reasons, clothing is not included in this catalogue.

Shelter and housing

Shelter must as a minimum provide; protection from the elements, space to live, rest and store belongings, privacy and emotional security. Shelter is likely to be one of the most important determinants of general living conditions and is often one of the largest items of non-recurring expenditure.

While the basic need for shelter is similar in most emergencies, issues such as the kind of housing needed, what materials and design are used, who constructs the housing and how long it must last, will differ significantly in each situation. In cold climates or those areas subject to daily extremes in temperature, lack of adequate shelter and clothing can have a particularly adverse affect on health and nutritional status. Thus, in addition to shelter, provision of sufficient blankets, sleeping bags, beds, appropriate clothing and even heaters will in some cases be a high priority.

To meet these varying situations, the following items are covered in the catalogue:

- * Tarpaulins
- * Shelter kit, family size
- * Tents, shelter
- * Utility tents

The best way to meet emergency shelter needs is to provide the same materials or shelter that would commonly be used by the refugees or the local population. The simplest principles and structures, and labour intensive building methods, are to be preferred. The design of shelter and more permanent housing should, if possible, provide for modification by the occupants to suit their individual needs.

The key to providing an adequate shelter is the provision of a solid and robust roof. If a complete shelter cannot be provided, provision of adequate roofing will be the priority. Plastic tarpaulins (woven and non-woven types) are in most cases the best materials available. These materials are also very useful in protecting minor stockpiles, latrines etc..

Tents are often not an effective means of providing shelter as they are difficult to live in and provide little insulation against extremes in temperature. There are however, circumstances in which tents may be useful and appropriate, for example when local materials are not available, for use as storage or for various other purposes. In areas where the ground can be used as a floor in tents, the Shelter kit can be used as an

NEEDS AND RECOMMENDED RESPONSES

inexpensive and efficient solution. The life of an erected tent is dependent on climate but may be as long as two years. In areas where the weather is very cold or rainy, a tent should be selected. Where tents are appropriate, repair material should be provided to the occupants.

Utility tents are needed to establish storage facilities, hospitals, schools and other field services. The success of the camp highly depends on these facilities. In order to select a hospital tent, it is important firstly, to establish a requirement for quantities of beds and to determine the types of diseases which have stricken the area. In colder areas, it may be necessary to use a prefabricated house as a hospital to provide the minimum protection against weather.

If the operation is long term and some of the refugees are children, a school tent should be erected. This increases the enthusiasm among the refugees and assists in making the camp a success.

When selecting storage facilities and shelter equipment, a systematic record of needs has to be established. It is important to ensure that the shelter is of sufficient size for its purpose. If the storage facility consists of several small tents situated in close proximity, the opportunity of losing equipment and products from stock is increased. It is also necessary to have a proper security system for the storage facility e.g. guards or a proper fence.

To date neither pre-fabricated building systems nor specially developed emergency shelter units have proven effective in refugee emergencies. Reasons include inappropriateness, high unit cost, inflexibility and the fact that emergency shelter arrangements will have been made before these systems can arrive. They are therefore, not included in this catalogue as a commonly used item.

Recommendations for tents

Protected from:	Mosquitoes, refuse dumps, adverse weather conditions, commercial and industrial zones
Average number of persons per family:	5 persons
Floor area in tent:	3.5 m ² per person in tropical climates 5 m ² per person in colder climate
Preferable tent area:	17.5 m ² in tropical climate 25 m ² in colder climate
Minimum height of side wall of tents:	90 cm

Bedding

There is a significant need for blankets in an emergency situation. Depending on the climate, blankets are one of the most valuable items in emergency situations. The catalogue covers the following bedding:

- * Blankets, heavy thermal resistance
- * Blankets, medium thermal resistance
- * Blankets, light thermal resistance
- * Sleeping bags and mattresses

The type of bedding selected for the operation, will depend on the climate. In cold areas where a heavy blanket is insufficient, sleeping bags should be considered.

NEEDS AND RECOMMENDED RESPONSES

Kitchen accessories

Kitchen-sets containing basic items are required for food preparation and consumption by the refugees. This catalogue contains three types of kitchen sets:

- * Family size
- * For 250 people
- * For 100 malnourished children

Cooking utensils, water carriers/containers, stoves and lighting equipment may be required for family units and communal kitchen facilities - especially for displaced people and those who cannot salvage their own facilities after a sudden disaster.

Utensils, lanterns and stoves in particular should be the type which are commonly used in the area. Plastic jerry cans are very useful for carrying and storing water, and are easy to handle and use. In many situations, pre-packed family kits of cooking utensils have been found useful, and are therefore included in this chapter.

It should be emphasized that the equipment supplied must consist of a light weight material, but must be packed in a strong double-walled carton. Generally, equipment which can be purchased locally is to be preferred. It is very important that the refugees are aware of how to use the cooking utensils and related equipment and that this equipment can be useful to them, even after the emergency situation is stabilized.

Stoves that require wood or other fuels for operation, should be selected rather than those based on an electric principle. Stoves based on a solar energy principle might be necessary in areas where wood or fuel is unavailable.

Furthermore, it is crucial that cooking utensils are disinfected when appropriate. Disinfection can be carried out effectively by various methods, such as:

- * Boiling water for minimum 5 minutes
- * Chlorine solution, 100mg/litre for 30 seconds
- * Quaternary ammonium compounds, 200mg/litre for 2 minutes

NOTES

NOTES

SHELTER & HOUSING: TARPAULINS, WOVEN PLASTIC

Indicative unit price: USD 7.5/ sheet
Shipping weight: 40 kg/roll
Shipping volume: 0.15 m³/roll
UNCCS Code: 271616

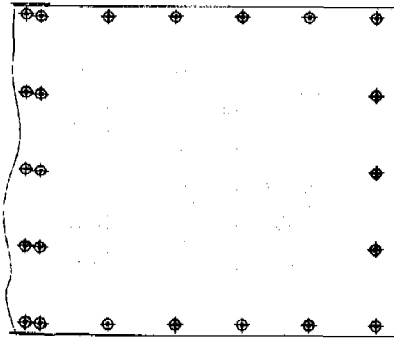

- Type:** Woven flexible tarpaulin
- Area of use:** Mainly for temporary human shelter or other personal protection purposes
- Material:** Woven high density polyethylene (HDPE) fibres laminated on both sides with low density polyethylene (LDPE) sheet, with reinforced rims, preferably by heat sealing on all sides, and nylon ropes in hem.
Yarn: Minimum 1000 denier
- Tensile strength:** Minimum 23.0 kN/m in both directions - warp and weft (corresponding to 60 kg in the BS 2576, 25 mm grab test, or equivalent)
- Tear resistance:** 9 kg min. both directions (BS 4303 or equivalent)
Note: Tensile strength and tear resistance to be measured across any joints or seams present in the material offered
- Bursting strength:** 20 kg/cm² min. (BS 4768 or equivalent)
- Width:** 4 m, standard size
- Length:** Sheets of 6 meters, or rolls of 48 meters
- Thickness:** Minimum 0.20mm (200 microns)
- Weight:** Minimum 200 g/m²
- Resistancy:** Temperature resistant from -20 to +80°C
- Eyelets:** Placed on 4 sides of the single sheets at approx. 1 metre centre to centre, double row of eyelets every 6 meters if provided in rolls
- Features:**
- * UV- and chemical resistant
 - * Water-, rot- and soil fauna resistant
 - * Long-life outdoor use in all climates
- Colors:** White sun reflective top side and grey reverse side
- Flammability:** Flash point above 200°C
- Optional Accessories:**
- * 2 poles 2.15 m steel, 30 mm diameter
 - * 1x33 rope, polypropylene, endless fibers
 - * 4 pegs 48 x 3.35 cm, 1.25 mm thick, steel
 - * 10 pegs 29 x 1.85 cm, 1.0 mm thick, steel
 - * 15 toggles with one eye
 - * Reinforced adhesive tape for repair
 - * Manual for shelter construction

SHELTER & HOUSING: TARPAULINS, REINFORCED NON -WOVEN PLASTIC

Indicative unit price: USD 210/roll
Shipping weight: 55 kg/roll
Shipping volume: 0.15 m³/roll
UNCCS Code: 271617

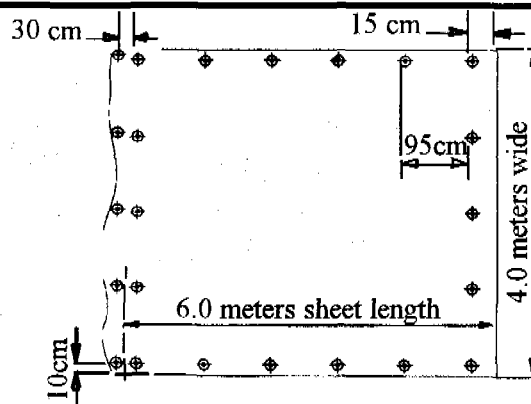

- Type:** Flexible braided plastic sheeting, with sealed eyelets
- Area of use:** Mainly for temporary human shelter or other personal protection purposes
- Material:** Flexible low density polyethylene (LDPE) sheet, reinforced with scrim of approx. 10/12 mm x 10/12 mm mesh, preferably of high tenacity polyester multifilament.
- Tensile strength:** Minimum 7.0 kN/m
- Tear resistance:** 180 N to DIN 53363 (average of longitudinal and transverse values)
Note: tensile strength and tear resistance to be measured across any joints or seams present in the material offered
- Width:** 4 m, standard size
- Length:** 48 m in rolls
- Thickness:** 0.25 mm (250 microns)
- Weight:** 275 g/m²
- Resistancy:** Temperature resistant from -40 to +80°C
- Eyelets:** Strong built-in plastic eyelets, melted into tarpaulin material, placed at approx. 1 metre center to centre and 10 cm from both lengthwise edges. Double row of eyelets every 6 meters and water-tight until pierced
- Features:**
- * UV- and chemical resistant
 - * Water, rot, and soil fauna resistant
 - * Long-life outdoor use in all climates
- Colors:** White sun reflective top side and grey reverse side
- Optional Accessories:**
- * 16 poles 2.15 m fiber glass 30 mm diameter
 - * 16 pole head, 16 pole feet plate
 - * 8x33 rope, polypropylene, endless fibers
 - * 32 pegs 48 x 3.35 cm, 1.25 mm thick, steel
 - * 80 pegs 29 x 1.85 cm, 1.0 mm thick, steel
 - * 120 toggles with one eye
 - * reinforced adhesive tape for repair
 - * Manual for shelter construction
 - * Cutting table

SHELTER & HOUSING: TARPAULINS, REINFORCED, NON -WOVEN BRAIDED PLASTIC

Indicative unit price: USD 220/roll
Shipping weight: 60 kg/roll
Shipping volume: 0.15 m³/roll
UNCCS Code: 271618

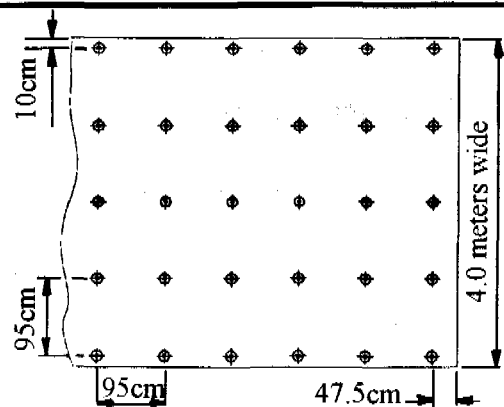

- Type:** Flexible braided plastic sheeting, with sealed eyelets
- Area of use:** Mainly for temporary human shelter or other personal protection purposes
- Material:** Braided LDPE (reinforced plastic) with built-in reinforced eyelets
- Tensile strength:** Minimum 7.0 kN/m
- Tear resistance:** 180 N to DIN 53363 (average of longitudinal and transverse values)
Note: tensile strength and tear resistance to be measured across any joints or seams present in the material offered
- Width:** 4 m, standard size
- Length:** 53.5 m in rolls
- Thickness:** 0.25 mm (250 microns)
- Weight:** 275 g/m²
- Resistancy:** Temperature resistant from -40 to +80°C
- Eyelets:** Strong built-in plastic eyelets, melted into tarpaulin material placed at every 95 cm (10 cm from lengthwise edges), water-tight until pierced
- Features:**
- * UV- and chemical resistant
 - * Water, rot, and soil fauna resistant
 - * Long-life outdoor use in all climates
- Colors:** White sun reflective top side and grey reverse side
- Optional accessories:**
- * 16 poles 2.15 m fiber glass 30 mm diam
 - * 16 pole head, 16 pole feet plate
 - * 8x33m rope, polypropylene, endless fibers
 - * 32 pegs 48 x 3.35cm, 1.25 thick, steel
 - * 80 pegs 29 x 1.85cm, 1mm thick, steel
 - * 120 toggles with one eye
 - * Reinforced adhesive tape for repair
 - * Manual for shelter-construction
 - * Cutting table

SHELTER & HOUSING: FAMILY SIZE TEMPORARY SHELTER

Indicative unit price: USD 120
Shipping weight: Approx. 26 kg
Shipping volume: Approx. 1000
 pcs./20 ft. container
UNCCS Code: 271628



- Type:** Temporary shelter for personal protection, appropriate for 1 family
- Size:** **Area:** Approx. 4 x 4 m (16 m²), appropriate for 5 persons
Centre height: Approx. 2 m
- Tent:** Reinforced white-grey LDPE sheeting¹
Size: Approx. 7 x 4 m
- Doorways:** Reinforced white-grey LDPE sheeting¹
Size: Approx. 4 x 4 m
- Tent poles:** 3 poles, each with one end capped and one end spiked
Size: 2.2 m x Ø 25 mm in 3 pieces
Material: Galvanized steel or aluminium
- Ridge pole:** 1 ridge pole in 4 pieces
Total length: 3.76 m including end caps
Material: Galvanized steel or aluminium Ø 25 mm
- Tent pegs:** Self coloured steel pegs packed on a PE-bag
11 pcs: 450 mm x Ø 10 mm
- Packing:** Packed in polyethylene bag
- Accessories:**
- * 2 pcs: 8 mm x 10 m Polypropylene rope
 - * 5 pcs: 6 mm x 10 m Polypropylene rope
 - * 42 pcs: Polyoggles
 - * Packing list with assembling drawing

¹ LDPE sheeting should conform to material specifications of tarpaulins (refer UNCCS code 271612 or UNCCS code 271611)

SHELTER & HOUSING: TENTS, RIDGE TYPE FOR TROPICAL USE

Indicative unit price: USD 200
Shipping weight: 65 kg
Shipping volume: 0.15 m³
UNCCS Code: 271631

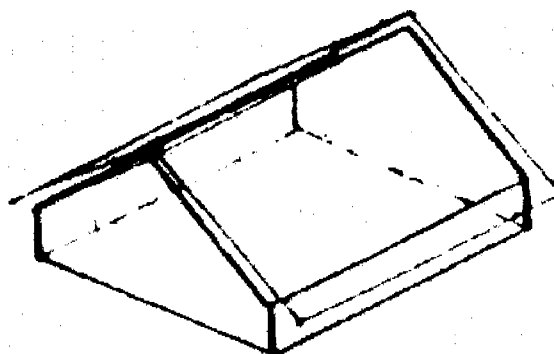

Type: Tent, ridge type, rectangular, single fly

Area of use: Tent for tropical climates, suitable for 5 persons

Dimensions: **Area:** 16 m², (4 x 4 meter)
 Center height: 2.0 m
 Wall height: 0.9 m

Tent fly:

- * Cotton or cotton/polyester canvas minimum 370 g/m², breaking strength, tear strength, water resistance and other properties as per BS 6341, Grade 2 (or equivalent).
- * Tent fly to have a cotton lining of 170 g/m².
- * Tent fly to be placed over the ridge pole and not hung by loops to the pole.
- * All points of strain to be reinforced. (Ridge reinforced lengthwise on inside).
- * Triangular shaped hood canopies of 50 cm wide ridge band, full length of flysheet on either end, suitably reinforced and hemmed.

Make up:

- * 2 windows, one on each side wall, size 40 cm x 60 cm, with cross-strengthening bands, mosquito nets and adjustable canvas flaps.
- * Front and rear doors with lacing and mosquito nets.
- * Four pockets, approx. 40 cm wide x 60 cm deep, provided between outer and inner walls on either side.
- * Mud walls, door and window openings to comply with ISO 5912 or equivalent.
- * Two ventilators to be provided in the roof of the tent, with mosquito net, spaced symmetrically approx. 25 cm from the ridge, and 1.0 meter from each end.
- * Entrance fasteners, zippers, clips, ties to be of heavy duty, where applicable non-ferrous, generally as per specifications in ISO 5912 or equivalent.

Groundsheet: **Dimensions:** 4.4 m x 4.4 m.
 Reinforced PVC minimum 250 g/m², or alternatively same material as for tent fly.
 Groundsheet to comply with ISO 5912 or equivalent.

Materials: All materials flame retardant, UV-stabilized, water and rot proof, to comply with requirements in BS 6341. (Alternative waterproofness test as per ISO 811, and anti-rot/mildew treatment as per DIN 53931)

continued on next page

SHELTER & HOUSING: TENTS, RIDGE TYPE FOR TROPICAL USE

Indicative unit price: USD 200
Shipping weight: 65 kg
Shipping volume: 0.15 m³
UNCCS Code: 271631

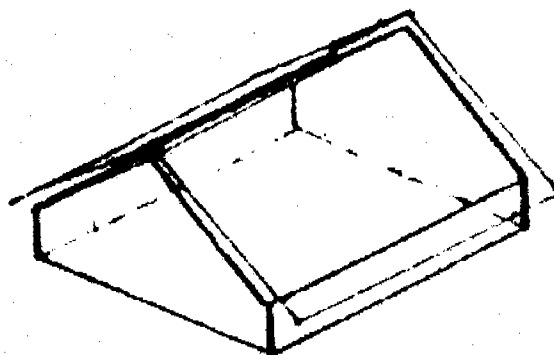

...continued from previous page

Ropes: Guy ropes made up of 9 mm 3-strand nylon or polypropylene with tensile strength of min. 500 kg, loop lacing for doors - 7 mm cotton spun yarn or equivalent.

Poles:

- * Tubular poles of heavy-duty section, plastclad/galvanized steel or aluminium. (To comply with ISO 5912, Section 4.8).
- * Ridge beam - 4 metres long, upright poles - 2.15 metres each.
- * Framework to comply with requirements of ISO 5912, Section 4.12, for bending resistance of the load-bearing elements and their angular joints.

Colours: White outside and grey inside.

Packing: Packed in canvas or heavy duty plastic bag. Accessories packed in a separate canvas bag inside the carry bag.

Accessories:

- * Ropes
- * Guy-lines
- * Pegs
- * Pins
- * Mallets
- * Repair kit
- * Assembly instructions and necessary tools
- * Attachment devices and metal tent-pegs
- * Pegs to comply with specifications in ISO 5912, Section 4.13 or equivalent.

NOTE: Stitching and seams to be of good quality throughout, and conforming to BS 3870 or equivalent.

SHELTER & HOUSING: TENTS, RIDGE TYPE FOR COLD CLIMATE

Indicative unit price: USD 250
Shipping weight: 80 kg
Shipping volume: 0.2 m³
UNCCS Code: 271632

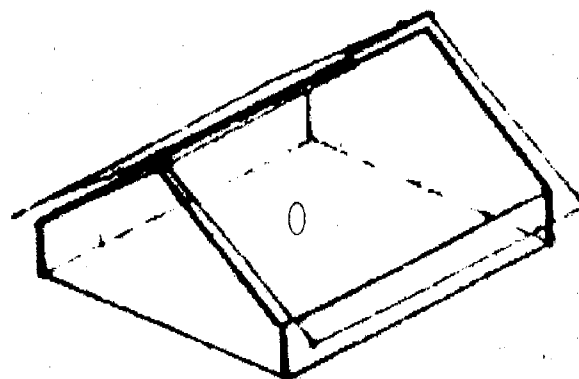

Type: Tent, ridge type, rectangular, double fly

Area of use: Tent for cold climates, suitable for 5 persons

Dimensions: **Area:** 16 m², (4 x 4 meter)
 Center height: Approx. 2.0 m
 Wall height: Approx. 0.9 m

Outer fly:

- * Cotton or cotton/polyester canvas minimum 400 g/m², breaking strength, tear strength, water resistance and other properties as per BS 6341, Grade 2 (or equivalent).
- * Tent fly to be placed over the ridge pole and not hung by loops to the pole.
- * All points of strain to be reinforced. (Ridge reinforced lengthwise on inside)
- * Apron for flue pipe fitted onto one end of the roof (apron to have a 10 cm opening provided with a flap and located about 40 cm from the middle of the ridge).
- * Triangular shaped hood canopies of 50 cm wide ridge band, full length of flysheet on either end, suitably reinforced and hemmed.

Inner fly:

- * Cotton or cotton/polyester canvas 370 g/m², as per BS 6341 (or equivalent), Grade 2 and Grade 3, for inner fly and side walls respectively.
- * Inner fly and side walls to have a cotton lining of 170 g/m².
- * Provision for flue pipe.

Make up:

- * 2 windows, one on each side wall, size 40 cm x 60 cm, with cross-strengthening bands, mosquito nets and adjustable canvas flaps.
- * Front and rear doors with lacing and mosquito nets.
- * Four pockets, approx. 40 cm wide x 60 cm deep, provided between outer and inner walls on either side.
- * Mud walls, door and window openings to comply with ISO 5912 or equivalent.
- * Two ventilators to be provided in the roof of the tent, with mosquito net, spaced symmetrically approx. 25 cm from the ridge, and 1.0 meter from each end.
- * Entrance fasteners, zippers, clips, ties to be of heavy duty, and where applicable non-ferrous, generally as per specifications in ISO 5912 or equivalent.

Groundsheet: **Dimensions:** 4.4 m x 4.4 m.

continued on next page...

SHELTER & HOUSING: TENTS, RIDGE TYPE FOR COLD CLIMATE

Indicative unit price: USD 250
Shipping weight: 80 kg
Shipping volume: 0.2 m³
UNCCS Code: 271632

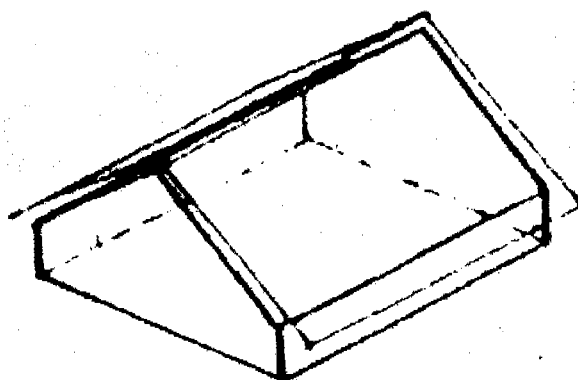

...continued from previous page

Reinforced PVC minimum 250 g/m², or alternatively same material as for outer fly. Groundsheet to comply with ISO 5912 or equivalent.

Materials: All materials flame retardant, UV-stabilized, water and rot proof, to comply with requirements in BS 6341. (Alternative water proofness test as per ISO 811, and anti-rot/mildew treatment as per DIN 53931).

Ropes: Guy ropes made up of 9 mm 3-strand nylon or polypropylene with tensile strength of min. 500 kg, loop lacing for doors - 7 mm cotton spun yarn or equivalent.

Poles:

- * Tubular poles of heavy-duty section, plastclad/galvanized steel or aluminium, (to comply with ISO 5912, Section 4.8).
- * Ridge beam - 4 metres long, upright poles - 2.15 metres each.
- * Framework to comply with requirements of ISO 5912, Section 4.12, for bending resistance of the load-bearing elements and their angular joints.

Colours: White outside and grey inside.

Packing: Packed in canvas or heavy duty plastic bag. Accessories packed in a separate canvas bag inside the carry bag.

Accessories:

- * Ropes
- * Guy-lines
- * Pegs
- * Pins
- * Mallets
- * Repair kit
- * Assembly instructions and necessary tools.
- * Attachment devices and metal tent-pegs
- * Pegs to comply with specifications in Section 4.13, ISO 5912, or equivalent.

Note: *Stitching and seams to be of good quality throughout, and conforming to BS 3870 or equivalent.*

SHELTER & HOUSING: UTILITY TENT

Indicative unit price: USD 750
Shipping weight: 140 kg
Shipping volume: 0.6 m³
UNCCS Code: 271630

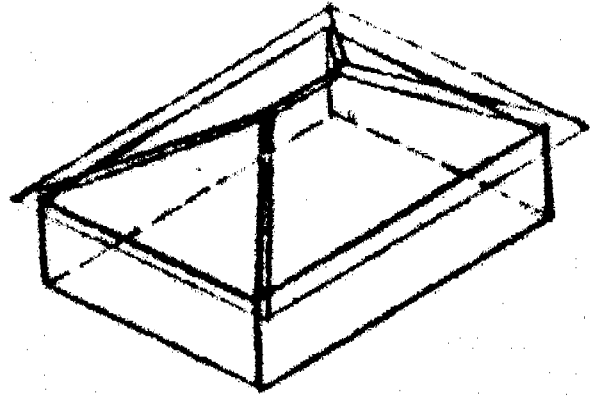

- Type:** Tents for multiple use, double fly.
- Area of use:** To be used as hospital, school or storage tent, as stand-alone or groups erected together.
- Dimensions:**
- | | |
|--------------------------|--|
| Area: | Approx. 27.5 m ² , (5 x 5.5 metres) |
| Center height: | 3.0 m |
| Wall height: | 2.0 m |
| Spacing of beams: | 2.0 m |
- Outer fly:**
- * Cotton or cotton/polyester canvas minimum 500 g/m², breaking strength, tear strength, water resistance and other properties as per BS 6341, Grade 2 (or equivalent).
 - * Tent fly to be placed over the ridge pole and not hung by loops to the pole.
 - * All points of strain to be reinforced. (Ridge reinforced lengthwise on inside).
 - * Triangular shaped hood canopies of 50 cm wide ridge band, full length of flysheet on either end, suitably reinforced and hemmed.
- Inner fly:** Cotton or cotton/polyester canvas 500 g/m², as per BS 6341 (or equivalent), Grade 2 and Grade 3, for inner fly and side walls respectively.
- Make up:**
- * 8 windows, four on each side, size 60 cm x 60 cm, with cross-strengthening bands, mosquito nets and roll-up canvas flaps.
 - * Front and rear "roll-up" doors, approx. 2 m x 2 m with lacing and mosquito nets.
 - * Mud walls, door and window openings to comply with ISO 5912 or equivalent.
 - * Maximum ventilation to be provided in the roof of the tent, with mosquito nets.
 - * Entrance fasteners, zippers, clips, ties to be of heavy duty, and where applicable non-ferrous, generally as per specifications in ISO 5912 or equivalent.
- Groundsheet:**
- Dimensions:** 5.9 m x 5.4 m.
Reinforced PVC minimum 250 g/m², or alternatively same material as for tent fly.
Groundsheet to comply with ISO 5912 or equivalent.
- Materials:** All materials flame retardent, UV-stabilized, water- and rotproof, to comply

continued on next page...

SHELTER & HOUSING: UTILITY TENT

Indicative unit price: USD 750
Shipping weight: 140 kg
Shipping volume: 0.6 m³
UNCCS Code: 271630

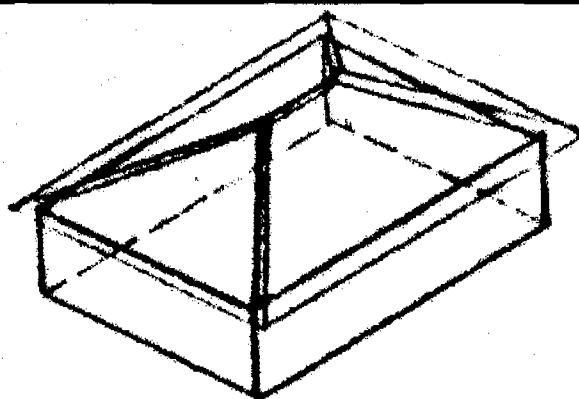

...continued from previous page

with requirements in BS 6341. (Alternative waterproofness test as per ISO 811, and antirot/mildew treatment as per DIN 53931)

Ropes: Guy ropes made up of 9 mm 3-strand nylon or polypropylene with tensile strength of min. 500 kg, loop lacing for doors - 7 mm cotton spun yarn or equivalent.

Poles:

- * Tubular poles of heavy-duty section, plastclad/galvanized steel or aluminium (to comply with ISO 5912, Section 4.8 or equivalent).
- * Ridge beam - 5.5 metres long, upright poles - 3.2 metres each.
- * Framework to comply with requirements of ISO 5912, Section 4.12 or equivalent, for bending resistance of the load-bearing elements and their angular joints.

Colours: Preferably white or green .

Packing: Packed in canvas or heavy duty plastic bag, accessories packed in a separate canvas bag inside the carry bag.

Accessories:

- * Ropes
- * Guy-lines
- * Pegs
- * Pins
- * Mallets
- * Repair kit
- * Assembly instructions and necessary tools
- * Attachment devices and metal tent-pegs
- * Pegs to comply with specifications in Section 4.13, ISO 5912, or equivalent.

Note: *Stitching and seams to be of good quality throughout, and conforming to BS 3870 or equivalent.*

SHELTER & HOUSING: TENT REPAIR KIT

Indicative unit price: USD 8
Shipping weight: 0.7 kg/set
Shipping volume: 0.0045 m³
UNCCS Code: 271695

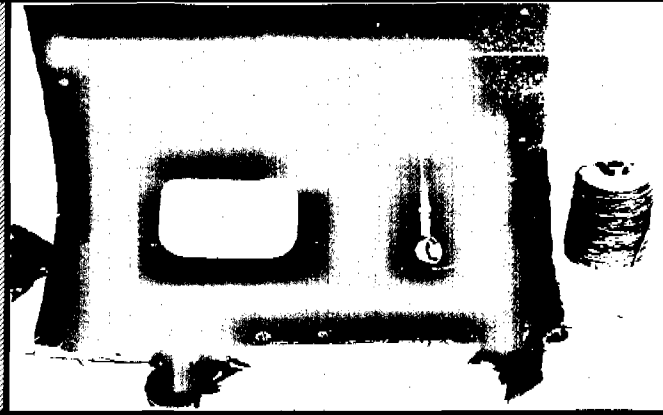

Type: Repair kit for cotton/canvas tent sheet

To include:

- Sheet:** Cotton- or cotton/polyester canvas, minimum 250 g/m²
Size: 0.5 m² (approx. 70 cm x 70 cm)
- Needle:** 1 piece straight and 1 piece curved needles
- Thread:** 1 roll of appropriate thread as per BS 6157 or equivalent.
Thread length to be minimum 50 meters.

BEDDING: BLANKETS, LOW THERMAL RESISTANCE

Indicative unit price: USD 3.0 - 4.5
Shipping weight: 1.3 kg
Shipping volume: Approx. 5,000/20 ft.
container
UNCCS Code: 271123

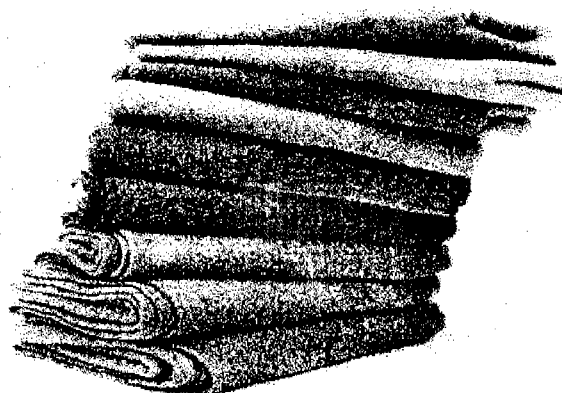

Type: Woven, low thermal resistance blanket. Dry raised

Area of use: For tropical climates

Content: 30% wool, virgin or reconditioned
Rest: Other virgin fibres (e.g. cotton or cotton/synthetic mix)

Weight: 1.2-1.5 kg/blanket

Size: 150 x 200 cm

Thickness: 4 mm under load 20g/cm² and before compression into bales

Tensile strength: **Warp:** Approx. 30 kg
Weft: Approx. 18 kg

Tear strength: **Warp:** Approx. 7 kg
Weft: Approx. 7 kg

Thermal resistance: 0.11 - 0.18 m²K/W

Finish: Whipped (10 stitches/decimetre) or ribbon bordered 4 sides

Shrinkage: Maximum 8 % after handwashing at 40°C

Colors: Grey, brown or other dark colors

Packing: Should be sprayed to avoid moths, packed in compressed bales of 30 blankets and water-tight wrapping

BEDDING: BLANKETS, MEDIUM THERMAL RESISTANCE

Indicative unit price: USD 4.5 - 7.0
Shipping weight: 1.7 kg
Shipping volume: Approx. 5,000/20 ft.
container
UNCCS Code: 271124

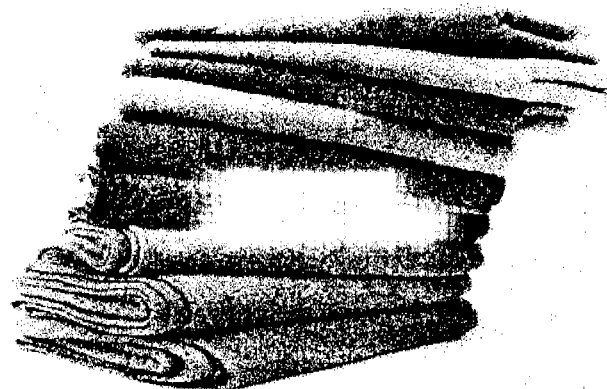

Type: Woven, medium thermal resistance blanket. Dry raised

Area of use: For tropical climates

Content: 50% wool, (virgin)
Rest: New polyester fibres

Weight: 1.4-1.8 kg/blanket

Size: 150 x 200 cm

Thickness: 5 mm under load 20g/cm² and before compression into bales

Tensile strength: **Warp:** Approx. 30 kg
Weft: Approx. 18 kg

Tear strength: **Warp:** Approx. 7 kg
Weft: Approx. 7 kg

Thermal resistance: 0.22 - 0.24 m²K/W

Finish: Whipped (10 stitches/decimetre) or ribbon bordered 4 sides

Shrinkage: Maximum 8 % after handwashing at 40°C

Colors: Grey, brown or other dark colors

Packing: Should be sprayed to avoid moths, packed in compressed bales of 30 blankets and water-tight wrapping

BEDDING: BLANKETS, HIGH THERMAL RESISTANCE

Indicative unit price: USD 10
Shipping weight: 1.2 kg
Shipping volume: Approx. 5,000/20 ft
container
UNCCS Code: 271125

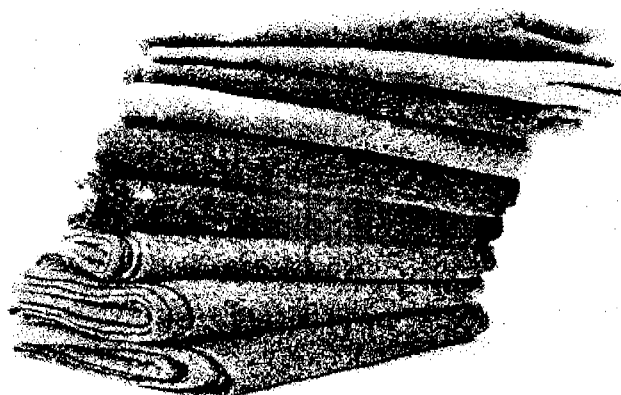

Type: Knitted, high thermal resistance blanket. Polar fleece double sided.

Area of use: For cold areas

Content: 80% Dacron polyester and 20% polypropylene or 50% polyacrylic and 27% polyester and 23% polypropylene

Weight: 1.2 kg/blanket

Size: 160 x 230 cm

Thickness: 6 - 7 mm under load 20g/cm² and before compression into bales

Tensile strength: **Warp:** Approx. 30 kg
Weft: Approx. 18 kg

Tear strength: **Warp:** Approx. 7 kg
Weft: Approx. 7 kg

Thermal resistance: 0.25 - 0.30 m²K/W

Finish: Whipped (10 stitches/decimetre) or ribbon bordered 4 sides

Shrinkage: Maximum 2 % after handwashing at 40°C

Colors: Grey, brown or UN light blue

Packing: Should be sprayed to avoid moths, packed in compressed bales of 30 blankets and water-tight wrapping

BEDDING: SLEEPING BAGS

Indicative unit price: USD 50
Shipping weight: Approx. 2 kg
Shipping volume: Approx. 0.05 m³
UNCCS Code: 271830



Size: Approx. 200 x 75 cm

Climate: Suitable for temperature range: -15 to +15°C

Material: **Outside fabric:** Nylon
Inside fabric: Cotton or viscose, rot-, water- & wind proof

Fillings: 100% polyester fibres, wool type, approx. 400 g/m²

Shape: Rectangular

Colors: Preferably dark colors

Thermal resistance: 12 - 14 m²K/W

Features:

- * Heavy duty double pull coil zipper on 2 sides, for easy drying or for using as a quilt
- * Attached hood for cold climates
- * Washable at 40°C
- * Sleeping bag material allows body vapor to pass freely through the insulation and outer shell thus keeping the body dry for maximum warmth
- * Quick drying and vermin proof

Packing: Packed in a nylon sack of similar material

BEDDING: MATTRESSES

Indicative unit price: USD 10
Shipping weight: Approx. 2 kg
Shipping volume: Approx. 0.5 m³
UNCCS Code: 381713

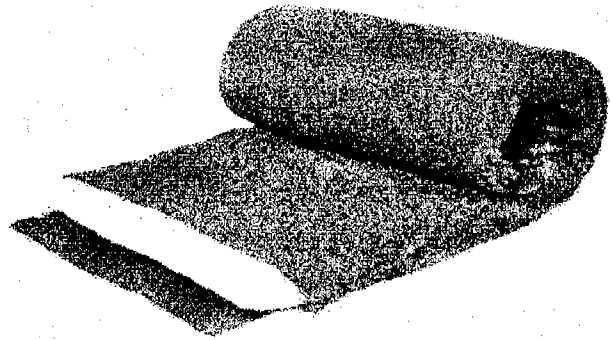

Size: Minimum 200 x 80 x 10 cm
Material: Polyurethane foam
Density: 18 kg/m³
Quality: Rot proof standard
Cover: Removeable non-woven corovin material (100 g/m²) with zip fastener
Colours: Dark or grey
Packing: 10 pieces to be vacuum packed in strong PE material

KITCHEN ACCESSORIES: KITCHEN SETS, FAMILY SIZE

Indicative unit price: USD 17
Shipping weight: Approx. 5 kg
Shipping volume: 0.04 m³
UNCCS Code: 429187

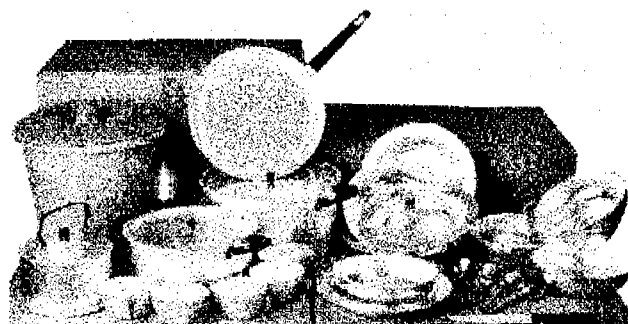

2 cooking pots:	<u>(1)</u>	<u>(2)</u>
Capacity:	7 litre	5 litres
Material:	Aluminium	Aluminium
Diameter:	Min. Ø 27 cm	Min Ø 22cm
Height:	Approx. 19 cm	Approx. 12.5 cm
Thickness:	Min. 1.75 mm	Min. 1.6mm
Lid:	Min 1.0 mm thick	Min 1.0 mm thick
Handles:	2 cast aluminium handles	2 cast aluminium handles
5 bowls:	Capacity: Approx. 1 litre	
	Material: Aluminium or stainless steel	
	Diameter: Min. 18 cm	
	Thickness: Min. 1.0 mm	
	Height: Up to 8 cm with rolled edge border	
5 plates:	Capacity: Approx 1 litre	
	Material: Aluminium	
	Diameter: 24/25 cm	
	Thickness: Min. 1.0 mm, with border	
5 knives :	Material: Stainless steel	
5 forks:	Material: Stainless steel	
5 tablespoons:	Material: Stainless steel	
5 cups:	Capacity: Approx. 0.3 litres	
	Material: Aluminium or stainless steel	
	Thickness: Minimum 1.0 mm	
	Handle: Approx. 1 mm thick	
1 kitchen knife:	Cutting edge: Minimum 15 cm	
	Width: Approx. 2.5 cm	
	Material: Stainless steel	
	Handle: Moulded plastic handle	
1 bucket:	Capacity: Minimum 15 litres	
	Material: HDPE or Galvanized steel	
	Handle: Plastic- or metallic handle	

KITCHEN ACCESSORIES: KITCHEN SETS, FOR 250 PEOPLE

Indicative unit price: USD 850
Shipping weight: 90 kg
Shipping volume: 0.5 m³
UNCCS Code: 429188

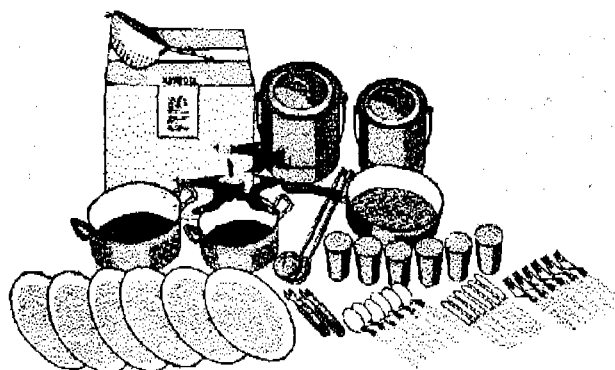

<u>Item</u>	<u>Quantity</u>	<u>Approx. type</u>	<u>Material</u>
Cooking pots with lids	2	501, Ø 400 mm, 400 mm high 1001, Ø 500 mm, 500 mm high	Aluminium or stainless steel
Paddles for stirring food	2	Optional	Wood
Cups	300	Ø 80 mm	Plastic
Bowls	300	400 ml, 50 mm deep, Ø150 mm	Melamine
Teaspoons	100	140 mm	Stainless steel
Measuring jugs	2	2 litres, Ø 170 mm, 170 mm deep	Stainless steel
Scoops	2	2 litres, Ø 200 mm	Stainless steel
Ladles	2	250 ml, Ø100 mm	Stainless steel
Whisks	2	300 mm	Stainless steel
Tin openers	2	Optional	Metal
Scrubbing brush	1	Optional	Optional
Large jerry can	2	20 litres	PE
Buckets with lids	4	10 litres	PE
Stoves, butane gas	2	Ø 450mm, 4000 kcal/h	Cast iron
Water purification tablets:	500	1 tablet/20 l (10 ppm)	Optional

KITCHEN ACCESSORIES: KITCHEN SETS, FOR 100 CHILDREN

Indicative unit price: USD 1,200
Shipping weight: Approx 80 kg
Shipping volume: Approx. 0.5 m³
UNCCS Code: 429189

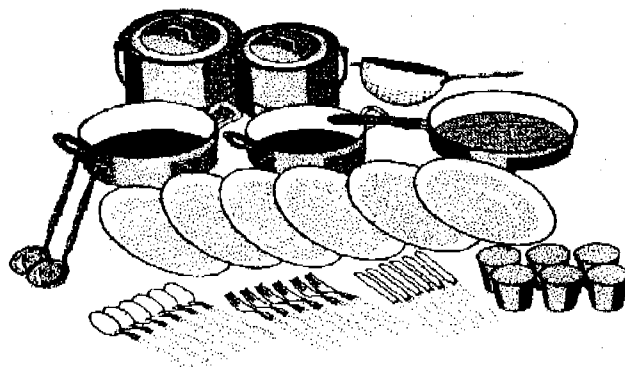

<u>Item</u>	<u>Quantity</u>	<u>Approx. type</u>	<u>Material</u>
Cooking pots with cover	2	501, Ø 400 mm, 400 mm high 1001, Ø 500 mm, 500 mm high	Aluminium or stainless steel
Paddles for stirring food	2	Optional	Wood
Cups	120	Ø 80 mm	Plastic
Bowls	120	400 ml, 50 mm deep, Ø150 mm	Melamine
Teaspoons	50	140 mm	Stainless steel
Teaspoons	250	140 mm	Plastic
Measuring jugs	2	2 litres, Ø 170 mm, 170 mm deep	Stainless steel
Scoops	2	2 litres, Ø 200 mm	Stainless steel
Ladles	2	250 ml, Ø100 mm	Stainless steel
Whisks	2	300 mm	Stainless steel
Tin openers	2	Optional	Stainless steel
Food scale, metric	1	10 kg/50 g	Metal
Alarm clock	1	Optional	Optional
Scrubbing brush	1	Optional	Optional
Large jerry can	2	20 litres	PE
Buckets with lids	4	10 litres	PE
Hurricane lamps, kerosene	2	Ø 150 mm, 400 mm high	Light grade tin plated finish
Candles & matches	Optional	Optional	Optional
Stoves, butane gas	2	Ø 450mm, 4000 kcal/h	Cast iron
Torch	1	Ø 50 mm, 250 mm	Heavy duty plastic
Batteries	4	Ø 33 x 61 mm, D-size, 1.5 V	Heavy duty metal
Water purification tablets	500	1 tablet/20 l (10 ppm)	Optional
Nasogastric tube kit	50	Optional	Optional

KITCHEN ACCESSORIES: STOVES, KEROSENE

Indicative unit price: USD 6
Shipping weight: Approx. 1 kg
Shipping volume: Approx. 0.005 m³
UNCCS Code: 448222

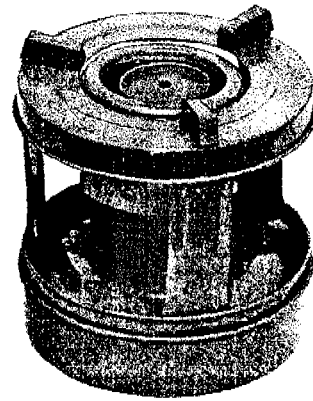

- Type:** Fuel efficient and low consumption stove non-pressurised wick type with incorporated fuel tank
- Fuel:** Kerosene
- Burner:** Minimum 8 wicks
- Dimensions:** **Approx. length:** 15 cm
 Approx. width: 15 cm
 Approx. height: 20 cm
- Capacity of tank:** Minimum 1 hour burning time
- Material:** Sheet iron, rust- and heat resistant
- Features:** * Wind safe
 * Noiseless, odourless and smokeless
- Accessories:** * Spare parts,
 * wicks and cleaners
 * Instructions for use and maintenance

KITCHEN APPLIANCES: HOT PLATES

HOT PLATES, GAS

Indicative unit price: USD 50
Shipping weight: Approx. 3 kg
Shipping volume: Approx. 0.02 m³
UNCCS Code: 448216

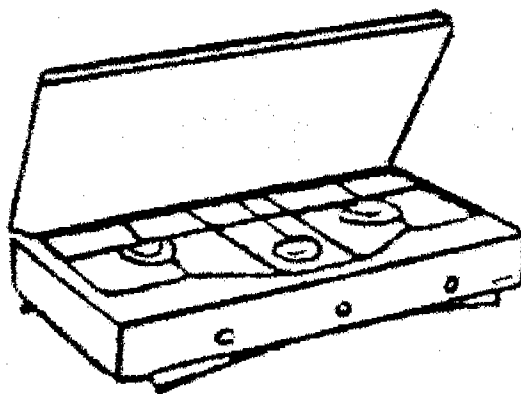

Type: Hot plate/stove, table type, manual ignition, incl. gas-adapter and hose
Power: Butane/propane gas, approx. 50 mbar
Consumption: Approx. 100 g/h gas (at 1500 W)
Capacity: 2-3 burners, individually controlled, performing 1-2,000 W, equal to 850-1,700 kcal/h per burner
Material:

Burner:	Stainless steel
Casing:	Steel or aluminium, enamelled
Grid:	Steel or cast iron, enamelled

HOT PLATES, ELECTRIC

Indicative unit price: USD 70
Shipping weight: Approx. 2.5 kg
Shipping volume: Approx. 0.02 m³
UNCCS Code: 448217

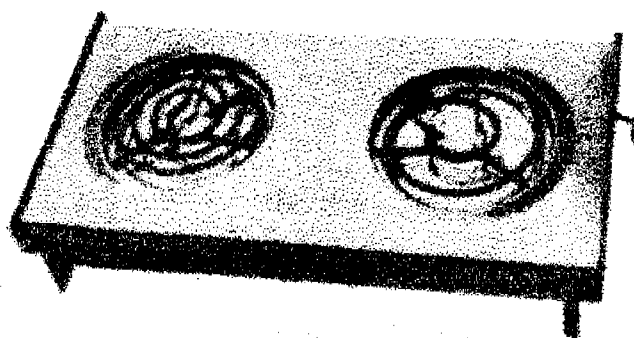

Type: Hot plate, table type
Power supply: 110/220 VAC
Capacity: 2 elements, individually controlled, each plate performing up to 1500 W, Minimum 3 stage switches
Material:

Casing:	Steel or aluminium, enamelled
----------------	-------------------------------

Plates: Approx. Ø 14-18 cm

KITCHEN APPLIANCES: JERRY CANS

JERRY CANS, PLASTIC

Indicative unit price: USD 2
Shipping weight: 1 kg
Shipping volume: 0.3 m³
UNCCS Code: 369494

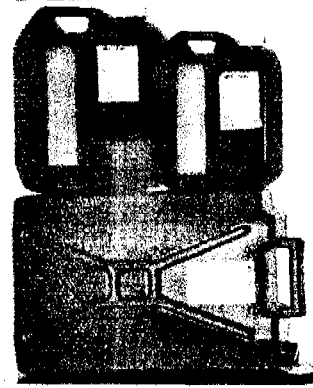

Type: Plastic jerry cans for carrying and storing water
Size: 20 litres
Material: (high density polyethylene), food grade containing no toxic elements
Construction: Non-collapsible type
Handle: Built-in carrying handle, wide enough for adult hands
Cap: Screw type
Features:

- * Impact resistant when filled
- * UV-resistant

Packing: 4 pcs packed together

JERRY CANS, COLLAPSIBLE

Indicative unit price: USD 1
Shipping weight: Approx. 0.5 kg
Shipping volume: Approx. 0.01 m³
UNCCS Code: 369491

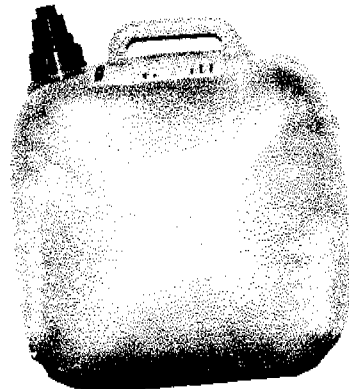

Type: Plastic jerry cans for carrying and storing water
Size: 5 litres
Material: Plastic, food grade
Construction: Collapsible type
Handle: Built-in carrying handle, wide enough for adult hands
Cap: Screw type
Features:

- * UV-resistant

Quality: **Should withstand a drop-test:** A full can should be secure against a fall of 2.5 metres onto a concrete base.

KITCHEN APPLIANCES: BUCKETS

BUCKET, PLASTIC

Indicative unit price: USD 1
Shipping weight: Approx. 0.7 kg
Shipping volume: Approx. 0.01 m³
UNCCS Code: 369424

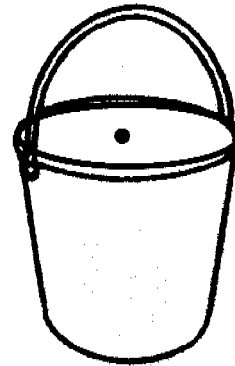

Type: Heavy duty plastic bucket, multi-purpose
Material: High density polyethylene (HDPE), food grade material, conical seamless design with a lid
Capacity: Approx. 10 litres
Handle: Steel-wire bale handle, fitted with grip, rust-proof
Thickness: Minimum 1.0 mm
Dimensions: Approx. top diameter: 30 cm
Approx. height: 30 cm

BUCKET, STEEL

Indicative unit price: USD 1.5
Shipping weight: Approx. 2 kg
Shipping volume: Approx. 0.01 m³
UNCCS Code: 429147

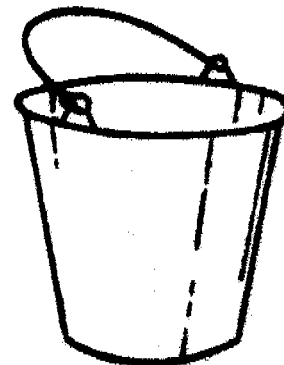

Type: Heavy duty steel bucket, multi-purpose
Material: Galvanized steel, rust-proof
Thickness: Minimum 0.5 mm
Capacity: Approx. 10 litres
Dimensions: Approx. top diameter: 30 cm
Approx. height: 30 cm
Handle: Steel wire bale handle, fitted with grip and rust-proof

LIGHTING EQUIPMENT: LANTERNS, KEROSENE

Indicative unit price: USD 5
Shipping weight: Approx. 0.8 kg
Shipping volume: Approx. 0.01 m³
UNCCS Code: 465319

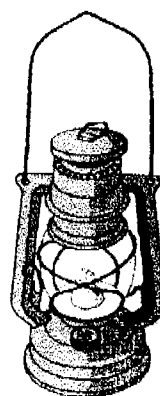

Type: Hurricane lantern, kerosene type

Size: **Height:** Approx. 30 cm
Diameter: Approx. 15 cm

Performance: Fuel efficient, low consumption, easy to light, bright flame in rough weather

Capacity of tank: Approx. 0.5 litres, minimum 10 hours burning

Materials: Heavy gauge steel body, tin coated, rust- and heat resistant and clear glass globe

Features: Easy to carry and operate, smokeless and odourless

Accessories:

- * Flame regulator
- * Spare globe and wicks
- * Instructions for use and maintenance
- * Cleaners & filling can

LIGHTING EQUIPMENT: SOLAR LIGHTING KIT, MOBILE

Indicative unit price: USD 600
Shipping weight: 9 kg
Shipping volume: 0.5 m³
UNCCS Code: 465346

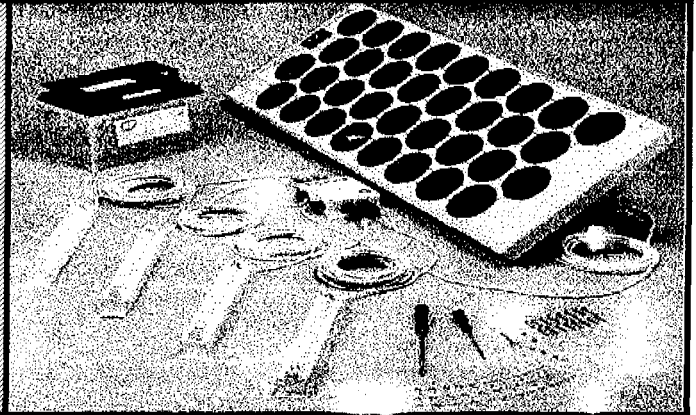

- Type:** Solar electric lighting package
- Area of use:** For domestic and community use in emergency relief aid situations
- Capacity:** Approx. 15 light-hours/day with an average insolation of 5 kWh/m²/d
- Solar module:** Mounted on support structure with pre-fitted cable and plug
- Power:** Nominal 50 Wp, 12 V
- Control:** Plug-in type, featuring low battery warning
- Lights:** 4 lights of 8 W, 12 V, fluorescent type, integral switch and pre-fitted cable and plug
- Features:** Automatic daylight cut-out
- Accessories:**
- * Cabling, 10 m
 - * Battery
 - * Spare fuse
 - * Additional lights
 - * Lighting tubes
 - * Tool kit for installation and use
 - * Manual for installation and use

HEATERS: HEATERS, KEROSENE/DIESEL

Indicative unit price: USD 50
Shipping weight: Approx. 10 kg
Shipping volume: Approx. 1 m³
UNCCS Code: 448293

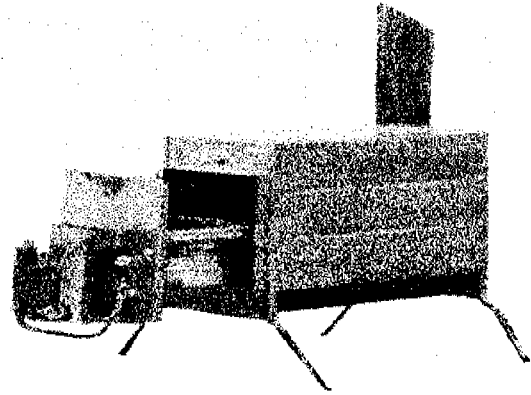

- Type:** Heater for tents and buildings, with built-in hotplate
- Area of use:** As a heater and as a stove
- Fuel:** Kerosene, fuel oil
- Heating capacity:** Minimum 10 kW consuming 20 litres kerosene/day
- Capacity of tank:** Minimum 5 litres
- Dimensions:**
- * Approx. 50 x 50 cm
 - * Approx. 100 cm high
- Materials:**
- Steel sheet body:** Approx. 0.5 mm thick
 - Cast aluminium dome:** Approx. 5 mm thick
 - Cast iron hot plate:** Approx. 5 mm thick
- Features:**
- * Easy to install and operate
 - * Low fuel consumption
 - * Non-smoke producing
 - * Non-corrosive materials
 - * Wind safe
 - * Supporting frame of steel
 - * Fuel level gauge breather
- Accessories:**
- * Damper for air flow control, complete with ducting and piping
 - * Spare parts and cleaning instruments
 - * Small tool kit for repairs and maintenance
 - * Instructions for use and maintenance

**CHAPTER 3 -
WATER SUPPLY EQUIPMENT
AND SUPPLIES**

NEEDS AND RECOMMENDED RESPONSES

General

To save lives and preserve health, minimum quantities of safe water must be made available. The following indications are standard guidelines to be considered when setting up a water supply system.

Water requirements

When setting up a water supply system, the following minimum water requirements should be considered:

a) Human consumption

- | | | |
|------------------------------------|-------|---------------|
| - Minimum, "Survival" allocation: | 7 | litres/person |
| - Average refugee camp allocation: | 15-20 | litres/person |

b) Average for services at camp level (Additional to human consumption)

- | | | |
|--|---------|----------------|
| - Out patient health centers | 5 | litres/patient |
| - In-patient health centers | 40-60 | litres/patient |
| - Hospital (with laundry facilities) | 220-300 | litres/bed |
| - Schools (Toilet requirement not included) | 2 | litres/person |
| - Schools (Water-flushed toilet system) | 10-15 | litres/person |
| - Feeding centers | 20-30 | litres/person |
| - Camp administration (Staff accommodation not included) | 5 | litres/person |
| - Staff accommodation | 30 | litres/person |

c) Livestock

- | | | |
|-------------------|-------|--------------------|
| - Bovine animals | 25-30 | litres/head |
| - Horses, mules | 20-25 | litres/head |
| - Goats and sheep | 15-20 | litres/head |
| - Pigs | 10-15 | litres/head |
| - Chickens | 10-20 | litres/100 animals |

However, if there are no restrictions or water supply limitations, the use of water may even reach up to 100 litres/person/day, if desired.

Water sources

The most important component of a water supply system is the water source. There are three main sources of natural water; groundwater, rainwater and surface water. Groundwater is the clearest and purest, followed by rainwater and then surface water.

The following should be considered when choosing the appropriate water source:

- * Volume of supply
- * Reliability of supply (taking into account seasonal variations and, if necessary, logistics)
- * Water quality, risk of contamination and ease of treatment
- * Speed and cost with which a source can be made operational
- * Simplicity of technology and ease of maintenance
- * Costs of operation and maintenance

NEEDS AND RECOMMENDED RESPONSES

Water pumping

In an emergency situation there are various needs for pumping equipment, notably to:

- * Pump water from wells or boreholes
- * Pump water from surface water
- * Pump water into storage tanks
- * Boost water within the system

To distribute water from the water tank to the end user, gravity flow should be utilized where feasible. However, in cases where gravity flow is impossible, a pump is required for distribution.

Pumps commonly used in emergency situations can be divided into two categories:

a) Reciprocating pumps

Reciprocating pumps are typically handpumps, which retrieve water from wells. There are two types of reciprocating pumps:

- Direct action
- Suction pumps

These are not discussed in this catalogue since they are usually used in a later stage of emergency.

The suction pump can only lift water up to 7 meters and can therefore only be used in shallow wells and boreholes with a very limited depth. For deeper wells or boreholes it is necessary to use a deep well pump, such as a submersible pump.

There are three important characteristics to be aware of when selecting handpumps for water supply. They can only supply individuals, not health centers, hospitals or other places which require a larger water supply. Hand pumps should only be selected when the group of people can be divided into smaller groups (maximum 200 persons/pump). It should be noted that the design from a traditional point of view is important for the success of selecting handpumps.

b) Centrifugal pumps

The centrifugal pump is motorized and can, depending on the type, be used to transport water from all sources. There are two categories of centrifugal pumps:

- Pumps used for surface water and shallow wells
- Submersible pumps

When the water leaves the pump, it can be transported to a storage tank, treatment equipment etc.. The maximum lift from the pump to the destination depends on the pressure from the pump. The pumps listed in this catalogue can force the water up to approx. 50 meters. It is recommended however, that the lift of the pump be as low as possible to achieve the highest flow. If it is necessary to force the water to a higher level, a combination of pumps can be used by boosting the system (inserting a pump half way up). In this case, it is essential to consult a technician to establish a functional system.

A submersible borehole pump is needed in boreholes deeper than 7 meters. The pump operates under water with an electrical motor and needs a power supply on the ground, usually a generator.

NEEDS AND RECOMMENDED RESPONSES

Water treatment

Depending on the water source and quality, a water treatment system may be required. Water treatment can involve many unit operations and unit processes, which should be chosen according to the available raw water quality. The basic types of treatment units or systems covered in this catalogue are as follows:

- * Screening for floating objects
- * Micro-straining for algae and coarse particles
- * Gravity separation for suspended solids
- * Chemical precipitation for turbidity and/or colour removal
- * Sand filtration
- * Chlorine and UV disinfection
- * Membrane or evaporation systems

The most commonly used processes in emergency situations are filtration, preceded by chemical precipitation when necessary, and chlorine disinfection. Other processes such as UV disinfection, chemical precipitation and membrane systems are included in the catalogue to account for emergency situations where chlorine disinfection and filtration alone are not enough to produce a potable water, or when only brackish or sea water are available as source of supply.

Chlorine disinfection is a very effective means of eliminating microbiological contamination of drinking water. When applying the adequate chlorine dosage a contact time of approximately 30 minutes must be ensured before the water is distributed. When the source of water is excessively contaminated, consideration must be given to the provision of pre-chlorination. The use of chlorine tablets is recommended for disinfection of small volumes of water, during short periods of time. If the emergency situation calls for disinfection of large volumes, during extended periods of time, adequate chlorine equipment for dosing chlorine gas or hypochlorite solutions should be utilized.

Since the treated water can undergo contamination in the distribution system, a residual chlorine should be maintained in the water supplied. The residual chlorine should be frequently monitored and additional chlorine may be added into the lines or distribution reservoirs, if deemed necessary.

Water storage

To acquire a reliable and effective water supply and compensate for variations in water use during the day, it is necessary to have a storage tank of an appropriate size. The situations and locations where tanks can be used are as follows:

- * At the water collection point (raw water tanks at surface water intake, run-off water collection and storage facilities)
- * At central storage tanks, before or after treatment to balance the supply from the source with the needs and in many cases, to provide the system with enough hydraulic head to allow for gravity-fed distribution.
- * In connection with sand filtration
- * At distribution points which may include public standposts and other service points (health or feeding centres, camp administration facilities and sometimes at staff houses)
- * At household level

In some cases, a transportable storage tank is required to transport water to areas lacking a water supply.

This catalogue contains two types of storage tanks. A prefabricated open top tank for stationary use and a

NEEDS AND RECOMMENDED RESPONSES

pillow tank for mobile use and distribution.

In emergency situations, it is customary to place the stationary water tank after the treatment and before the distribution system. This arrangement ensures the most efficient means of chlorination. In special cases where the chlorination is replaced and not combined with UV-light and special filtration, treatment should be after the storage tank and as close to the distribution point as possible.

The size of a storage tank should be in accordance with the water demand of a specific area. If the population to be supplied is smaller than approx. 2000 people, the volume should be equal to at least one day of water demand. For economic reasons, a larger camp population will have less storage capacity but, under no circumstances should this capacity be smaller than 1/6 of the camp's daily water demand. In camps with a population of more than 5000 people, the water storage capacity could be obtained through a battery of smaller reservoirs.

Water distribution

When a camp or area requires treated water from the storage tank it is necessary to use a distribution system. Whenever possible, the system should be based on gravity flow, which means that the outlet from the storage tank should be on a higher level than the taps at the distribution points. The distribution system consists of the following items:

- * Pipeline (HDPE pipes)
- * Connectors
- * Valves
- * Taps - Self closing type

The major difference between the two types of pipes is flexibility and the degree of resistance when exposed to sunlight. Usually, PVC pipes are hard plastic tubes, irrisistant to sunlight. They therefore, need to be buried if possible. The HDPE pipe is normally a flexible material and is therefore transported in coils. This reduces the number of necessary joints. HDPE has better resistance to sunlight but it is recommended that they also be buried.

The choice between the two pipe materials should be determined by their availability within the local market, cost, diameter available, pressure rating and transport costs. HDPE is environmentally friendly compared to PVC and thus is to be preferred.

The commonly used distribution system for emergency purposes is a distribution pack developed by OXFAM. The pack is sized to supply 5000 people using 27 litres/person/day. If there is a smaller number of people, the taps can be mounted directly on the bottom of the storage tank.

Test type	Quality	Treatment	Remarks
Turbidity	Algae	Straining/Filtration	Algae which passes the filter is destroyed through chlorination.
	Particles > 20 NTU	Sedimentation	If floating objects are represented in the water, sedimentation should be considered.
	Particles < 20 NTU	Slow sand filtration	If the water contains large quantities of particles, the filtration tank must be frequently cleaned. A prefiltration tank could also be considered. Filtration should proceed chlorination.
pH-value	> 5.5	Not included in this volume	Acid water should be treated with limestone or marble. If the pH-value is under 5.5, soda ash or caustic soda should be added to the water. An expert should be consulted to perform the above pH-adjustment.
	< 5.5		
Electric conductivity	Excessive iron, manganese and hardness	Not included in this volume	The most chemical related water quality problems do not cause serious health hazards if the water is consumed during short periods. An expert should be consulted for consumption over longer periods.
Coliform bacterial	> 50 colonies/100 ml in rough water	Prechlorination with calcium hypochlorite	If the water is very polluted, a prechlorination is recommended. The chlorination should last for at least 30 minutes.
	< 50 colonies/100 ml in rough water	Calcium hypochlorite powder	The water should be stored for at least 30 minutes before being distributed.
	Bacterial survived chlorination	UV light	The UV treatment should be used in combination with chlorination to avoid contamination of the water after the treatment plant. The UV treatment is best suited to larger water supplies.
Chlorine	< 0.2 - 0.3 mg/litre at water collection point	Calcium hypochlorite powder	The remaining chlorine in the water at the distribution point should be approx. 0.2 - 0.3 mg/liter to avoid contamination in the distribution system.

• Guidelines for water treatment methods

NEEDS AND RECOMMENDED RESPONSES

NOTES

WATER TESTING EQUIPMENT: WATER TESTING KIT

Indicative unit price: USD 1,500
Shipping weight: 10 kg
Shipping volume: 0.01 m³
UNCCS Code: 439479

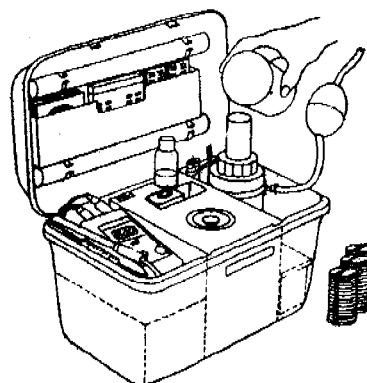

Type: A water testing kit designed to provide rapid information regarding the safety of a water supply.

Area of use: For testing quality of water at various sources

Design: The water testing kit packed in a handy portable box

Construction: Box of polypropylene with handle and hinged lockable, lid built-in incubator and storage for test equipment

Capacity: The kit should be able to perform a minimum of 250 complete tests.

Performance: Must provide the following tests:

- * Thermotolerant coliform count test
- * Turbidity test
- * Chlorine test
- * pH test
- * Electrical conductivity test
- * Temperature test

Additional optional tests can be included in the kit, e.g.:

- * Filtration test
- * Identification of various chemicals

Incubator: **Temperature:** 44°C
Power supply: 12 VDC from built-in rechargeable battery
Capacity: Approx 160 ml, Petri dishes

Battery charger: 120 or 240 VAC, 12 VDC

Accessories:

- * Instructions and reporting sheets
- * Complete with consumables and ancillary equipment
- * Pressure cooker, portable sterilizer or autoclave
- * Methanol (1 ml. per test)
- * Distilled water
- * Measuring cylinder or beaker (1 litre)

WATER PUMPING EQUIPMENT: SUBMERSIBLE BOREHOLE PUMP

LOW YIELD

Indicative unit price: USD 2,500
Shipping weight: approx 85 kg
Shipping volume: approx. 0.1 m³
UNCCS Code: 432236

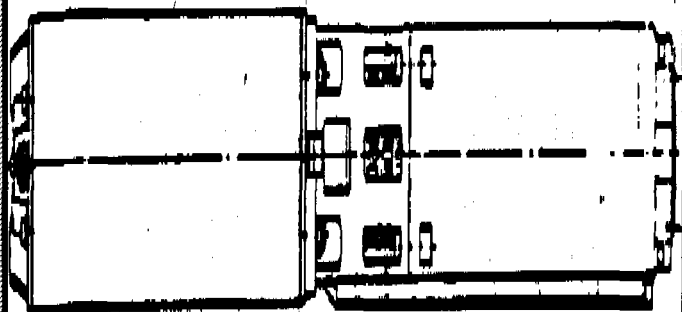

Head: 40 - 100 mtrs

Maximum flow: Approx. 20 m³/h at 40 mtrs head
 Approx. 10 m³/h at 100 mtrs head

Area of use: Ground water supply from boreholes

Life span: 5 years

Water temperature: Maximum 40 °C

Pump:

- * Multistage centrifugal submersible pump
- * Radial or semiradial impellers
- * Water lubricated bearings

Material: Stainless steel or thermoplastic
Max size: 100 mm diameter

Motor:

- * 3-phase submersible, 2-pole AC-motor
- * 3-phase 380 VAC / 3-phase 415 VAC

Dimensions: 100 mm (4") diameter
Frequency: 50 Hz
Effect: Approx. 6 kW at maximum flow rate
Material: Stainless steel

Drive: 3-phase 380 VAC / 3-phase 415 VAC, 50 Hz, 7.5 kW

Borehole: **Minimum diameter:** 100 mm (4")

Features: Corrosion resistant

Standard accessories:

- Installation, operation and maintenance manuals
- Tool kit for installation and maintenance
- Spare parts for 2 years
- 100 mtrs drop cable (4G6 mm²), starting device with dry running protection

Optional:

- * Generating set (tropicalised)
 - Continuous rating: 20 kVA
 - Speed: 1500 rpm
 - Voltage: 380 / 220 VAC
- * Direct on-line switch

WATER PUMPING EQUIPMENT: SUBMERSIBLE BOREHOLE PUMP

MEDIUM YIELD

Indicative unit price: USD 4,000
Shipping weight: approx. 100 kg
Shipping volume: approx. 0.15 m³
UNCCS Code: 432237

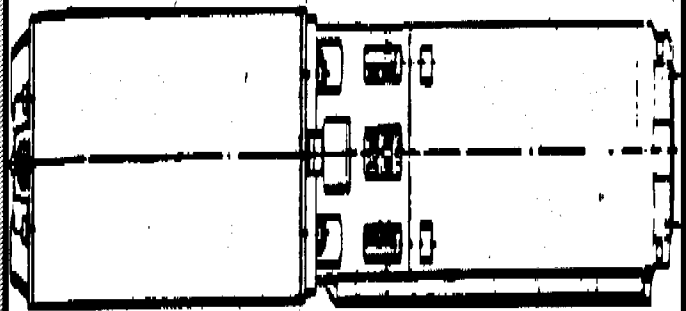

- Head:** 40 - 100 mtrs
- Maximum flow:** Approx. 35 m³/h at 40 mtrs head
Approx. 20 m³/h at 100 mtrs head
- Area of use:** Ground water supply from boreholes
- Life span:** 5 years
- Water temperature:** Maximum 40 °C
- Pump:**
- * Multistage centrifugal submersible pump
 - * Radial or semi-axial impellers
 - * Water lubricated bearings
- Material:** Stainless steel or thermoplastic
- Max size:** 150 mm diameter
- Motor:**
- * 3-phase submersible, 2-pole AC-motor
 - * 3-phase 380 VAC / 3-phase 415 VAC
- Dimensions:** 138 mm diameter
- Frequency:** 50 Hz
- Effect:** Approx. 8 kW at maximum flow rate
- Material:** Stainless steel
- Drive:** 3-phase 380 VAC / 3-phase 415 VAC, 50 Hz, 11 kW
- Borehole:** **Minimum diameter:** 152 mm (6")
- Features:** Corrosion resistant
- Standard accessories:**
- Installation, operation and maintenance manuals
 - Tool kit for installation and maintenance
 - Spare parts for 2 years
 - 100 mtrs drop cable (4G6 mm²), starting device with dry running protection
- Optional:**
- * Generating set (tropicalised)
 - Continuous rating: 30 kVA
 - Speed: 1500 rpm
 - Voltage: 380 / 220 VAC
 - * Direct on-line switch

WATER PUMPING EQUIPMENT: SUBMERSIBLE BOREHOLE PUMP

HIGH YIELD

Indicative unit price: USD 7,000
Shipping weight: approx. 200 kg
Shipping volume: approx. 0.25 m³
UNCCS Code: 432238

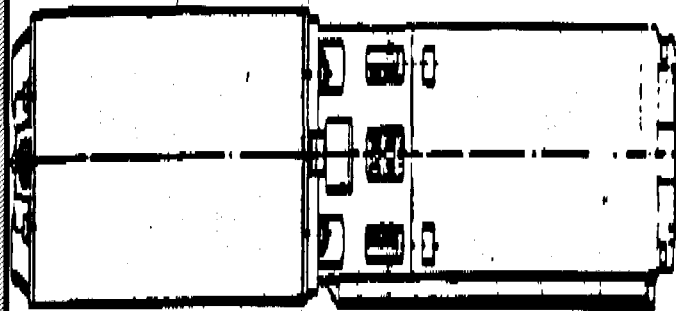

- Head:** 50 - 100 mtrs
- Maximum flow:** Approx. 90 m³/h at 50 mtrs head
Approx. 45 m³/h at 100 mtrs head
- Area of use:** Ground water supply from boreholes
- Life span:** 5 years
- Water temperature:** Maximum 40 °C
- Pump:**
- * Multistage centrifugal submersible pump
 - * Radial or semi-axial impellers
 - * Water lubricated bearings
- Material:** Stainless steel or thermoplastic
Max size: 180 mm diameter
- Motor:**
- * 3-phase submersible, 2-pole AC-motor
 - * 3-phase 380 VAC / 3-phase 415 VAC
- Dimensions:** 186 mm diameter
Frequency: 50 Hz
Effect: Approx. 20 kW at maximum flow rate
Material: Stainless steel
- Drive:** 3-phase 380 VAC / 3-phase 415 VAC, 50 Hz, 22 kW
- Borehole:** **Minimum diameter:** 200 mm (8")
- Features:** Corrosion resistant
- Standard accessories:**
- Installation, operation and maintenance manuals
 - Tool kit for installation and maintenance
 - Spare parts for 2 years
 - 100 mtrs drop cable (4G6 mm²), starting device with dry running protection
- Optional:**
- * Generating set (tropicalised)
 - Continuous rating: 60 kVA
 - Speed: 1500 rpm
 - Voltage: 380 / 220 VAC
 - * Direct on-line switch

WATER PUMPING EQUIPMENT: MOBILE CENTRIFUGAL PUMP UNITS

MEDIUM YIELD

Indicative unit price: USD 3,000
Shipping weight: 250 kg
Shipping volume: 0.5 m³
UNCCS Code: 432277

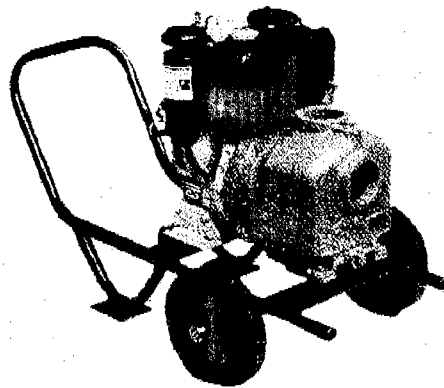

Type:

- * End suction self-priming self-contained centrifugal pump
- * Diesel powered type
- * Mounted on a 2 wheeled portable trolley

Area of use: For surface waters and shallow wells

Head: 50 m

Discharge: 50 m³/h

Life span: Minimum 5 years

Suction lift: Maximum 7 m

Operating conditions:

Water temperature:	Max. 100°C
Ambient temperature:	Max. 50° C
Casing pressure:	Max. 6 bar
Altitude:	Max. 1,000 m

Drive: 4 stroke diesel engine, air cooled

Connections:

Suction:	3 "
Discharge:	3 "

Materials: Cast iron and stainless steel

Features:

- * Dry running protection
- * Corrosion resistant materials
- * Pump/driver, closed coupled unit

Accessories:

- * Operation and maintenance manual
- * Tool kit for repairs and maintenance
- * Spare parts for 2 years
- * Motor starting device, manual
- * Min. 25 m flexible suction hose
- * Min. 50 m flexible discharge hose

WATER PUMPING EQUIPMENT: MOBILE CENTRIFUGAL PUMP UNITS

HIGH YIELD

Indicative unit price: USD 3,500
Shipping weight: 250 kg
Shipping volume: 0.5 m³
UNCCS Code: 432278

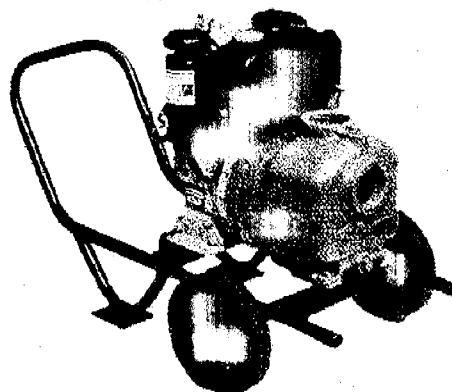

Type:

- * End suction self-priming self-contained centrifugal pump
- * Diesel powered type
- * Mounted on a 2 wheeled portable trolley

Area of use: For surface waters and shallow wells

Head: 50 m

Discharge: 100 m³/h

Life span: Minimum 5 years

Suction lift: Maximum 7 m

Operating conditions:

Water temperature:	Max. 100°C
Ambient temperature:	Max. 50° C
Casing pressure:	Max. 6 bar
Altitude:	Max. 1,000 m

Drive: 4 stroke diesel engine, air cooled

Connections:

Suction:	4 "
Discharge:	4 "

Materials: Cast iron and stainless steel

Features:

- * Dry running protection
- * Corrosion resistant materials
- * Pump/driver, closed coupled unit

Accessories:

- * Operation and maintenance manual
- * Tool kit for repairs and maintenance
- * Spare parts for 2 years
- * Motor starting device, manual
- * Min. 25 m flexible suction hose
- * Min. 50 m flexible discharge hose

WATER STORAGE EQUIPMENT: WATER PUMPING PACK

Indicative unit price: USD 2,500
Shipping weight: 250 kg
Shipping volume: 1 m³
UNCCS Code: 432276

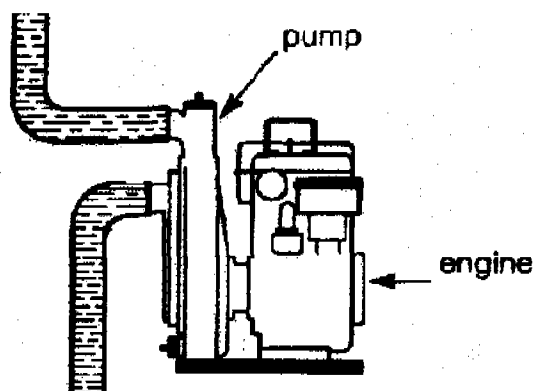

- Type:** Water pump, coupled to diesel engine
- Output:** 20 m³/h
- Head:** 30 m
- Area of use:** For surface waters and shallow wells
- Life span:** Minimum 5 years
- Suction lift:** Maximum 7 m
- Operating conditions:**
- | | |
|----------------------|--------------|
| Water temperature: | Max. 100°C |
| Ambient temperature: | Max. 50° C |
| Altitude: | Max. 1,000 m |
- Pumps:**
- * Self-priming centrifugal pumps
 - * Close coupled to diesel engines
 - * Variable speed control
- Drive:**
- * 4 stroke diesel engine, air cooled
 - * Approx. 4.0 l fuel tank
 - * Variable speed control
- Connections:**
- | | |
|------------|-----|
| Suction: | 2 " |
| Discharge: | 2 " |
- Materials:** Cast iron and stainless steel
- Features:**
- * Dry running protection
 - * Corrosion resistant materials
- Accessories:**
- * Fittings and oiling equipment
 - * Operation and maintenance manual
 - * Tool kit for repairs and maintenance
 - * Spare parts for 2 years
 - * Engine starting device, manual
 - * Min. 25 m flexible suction hose
 - * Min. 50 m flexible discharge hose

WATER STORAGE EQUIPMENT: WATER STORAGE TANKS, COLLAPSIBLE

Indicative unit price: See below
Shipping weight: See below
Shipping volume: See below
UNCCS Code: 369511

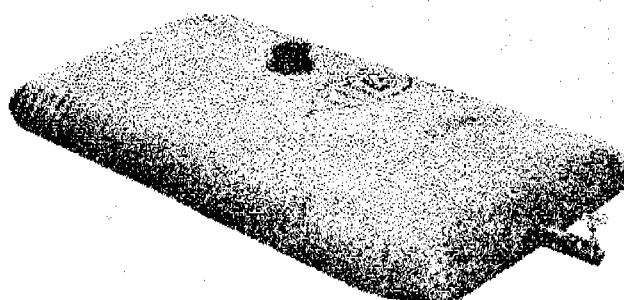

Capacity [liter]	Shipping weight [kg] [USD]	Shipping volume [m ³]	Indicative unit price
2,000	10	0.04	250
5,000	20	0.08	500
10,000	40	0.15	1,500
20,000	70	0.30	3,000
50,000	100	0.40	7,000

Area of use: For transportation, storage and distribution
Filling: 2-4" connection
Discharge: 1-2" connection
Construction: High frequency, double welded joints
Temp. resistance: Flexible in the range of -25°C to +70°C
Material: Reinforced polyester fabric, non-toxic food grade approved material, according to international standards

Thickness: Minimum 1 mm
Weight: Minimum 1000 g/m²
Coating: PVC coating, high UV-resistant

Strength:

Tear resistance:	Minimum 500 N
Tensile strength:	* Warp: Minimum 4000 N
	* Weft: Minimum 4000 N
Adhesion:	Approx. 15 kg/cm ²

Quality: Weathering, abrasion, puncture and temperature resistant
Fittings: Stainless steel or fibre glass reinforced polypropylene

Features:

- * Maintenance free
- * Easy installation by non-technical personnel

Packing: Folded and packed in a polyethylene carrying bag

Accessories:

- * Set for small repairs and cleaning procedures
- * Instructions for installation and use
- * Linings, fittings & air release valve
- * Harness for vehicle installation
- * Ground cover

WATER STORAGE EQUIPMENT: WATER STORAGE TANKS, STEEL

Indicative unit price: See below
Shipping weight: See below
Shipping volume: See below
UNCCS Code: 422357

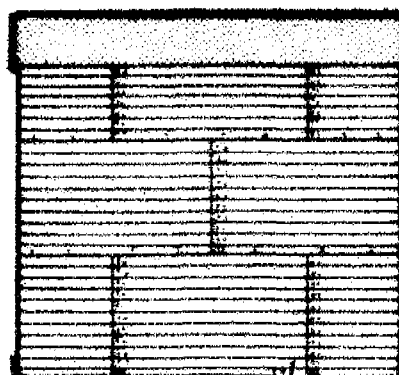

Capacity [liter]	Height [m]	Diameter [m]	Kit weight [kg]	Kit volume [m ³]	Indicative unit price [USD]
10,000	2.3	2.5	400	1.5	1,700
45,000	1.5	6.4	700	4.0	3,800
70,000	2.3	6.4	900	4.0	4,500
95,000	3.0	6.4	1100	4.5	4,500

Type: Prefabricated open top tank of steel panels, supplied in kit form, ready for installation on site

Area of use: For storage and distribution of drinking water

Life span: Minimum 10 years

Tank panels: Hot dip galvanized, curved 1.2 mm steel panels
 * Prepared for interconnection and outlet
 * Prepared for assembly

Tank roof: Reinforced PVC cover with eyelets, UV-resistant and rot-proof

Tank liner: Reinforced synthetic rubber liner, non-toxic food grade approved material, UV-resistant and rot-proof

Outlet type: Diameter: 2 - 4 "

Parts: Complete with parts and fixings for:
 * Assembly of tank panels
 * Securing of tank roof

Features:
 * Easy installation by non-technical personnel
 * Corrosion resistant

Accessories:
 * Tool kits for assembly, repair and maintenance
 * Instructions for installation and use
 * Chlorination kit for water treatment
 * Pipework kit for external connections

WATER TREATMENT EQUIPMENT: WATER DISINFECTION POWDER

CALCIUM HYPOCHLORITE

Indicative unit price:	1300 USD/MT
Shipping weight:	16,000 kg / 20" container
Shipping volume:	350 drums / 20" container
UNCCS Code:	356465

Type:	Powder for disinfection of water in water tanks, wells and reservoirs
Contents:	Calcium hypochlorite
Concentration:	Minimum 60 % available chlorine
Exposure time:	Approx. 30 minutes
Treatment:	Disinfection of microbial contamination in water
Stability:	Stable for minimum 3 years, unopened
Features:	<ul style="list-style-type: none">* Non-toxic to humans* Rapidly dissolving* Added directly to water
Packing:	Drums of approx 50 kg Drums of fibre or steel with inner PE bag
Accessories:	User guide

WATER TREATMENT EQUIPMENT: SAND WATER FILTRATION PLANT

Indicative unit price: USD 20,000
Shipping weight: 3,500 kg
Shipping volume: 15 m³
UNCCS Code: 439425

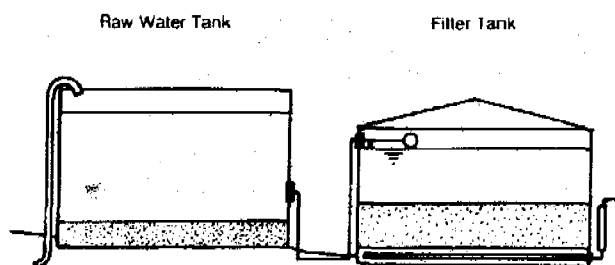

- Type:** Filtering plant for drinking water supply
- Life span:** Minimum 10 years
- Capacity:** Approx. 150 m³/day
Approx. 6 m³/h
- Treatment:** Slow sand filtering process based on the gravity force only
- Contents:**
- * 4 standard water tanks with PVC covers
 - * Reinforced synthetic rubber liner
 - * Connecting pipework, parts and fittings
 - * Filtration fabrics
- Tanks:** Prefabricated open top tanks:
- * 2 tanks: Ø 6.4 m x 3.0 m: 95 m³, for storage
 - * 2 tanks: Ø 6.4 m x 2.3 m: 70 m³, for filtering
 - * Of corrugated, galvanized 1.2 mm steel sheets
 - * Prepared for interconnection and assembly
- Tank roof:** Reinforced PVC cover with eyelets, UV-resistant and rot-proof
- Tank liner:** Reinforced synthetic rubber liner, non-toxic, UV- & rot-proof
- Filters:** Sand and gravel
- Features:** Easy to install, operate and maintain
- Accessories:**
- * Instructions for installation, use and maintenance
 - * Tool kit for installation and repair
 - * Essential spare parts for 2 years

WATER TREATMENT EQUIPMENT: UV TREATMENT UNIT FOR WATER PURIFICATION

Indicative unit price: USD 6,000
Shipping weight: 70 kg
Shipping volume: 0.5 m³
UNCCS Code: 439419

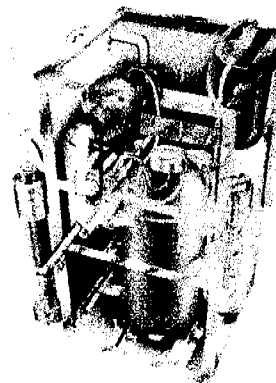

Type: Light duty water purification and sterilisation unit, portable and self contained

Elements:

- * Power source
- * Electrical transfer pump
- * Filtration units
- * UV sterilisation unit
- * Intake and outlet

Power: Human, electrical or solar power, approx. 40 rpm

Generator:

- * Hand operation
- * Diesel generator
- * Solar cells

Capacity: 0.5 m³/h

Head: 0-30 m

Treatment:

- * Filtration in 3 steps
- * UV bacteria treatment

Construction: Elements fitted into a robust stainless steel body

Features:

- * Easy to transport
- * Self explanatory
- * Solar panels mounted on body

Packing: On individual wooden-crated pallets

Accessories:

- * Tool kit for maintenance and repair
- * Instructions for use
- * Spare parts for 2 years

WATER TREATMENT EQUIPMENT: CHLORINATOR

Indicative unit price: USD 40,000
Shipping weight: 450 kg
Shipping volume: 2 m³
UNCCS Code: 439411

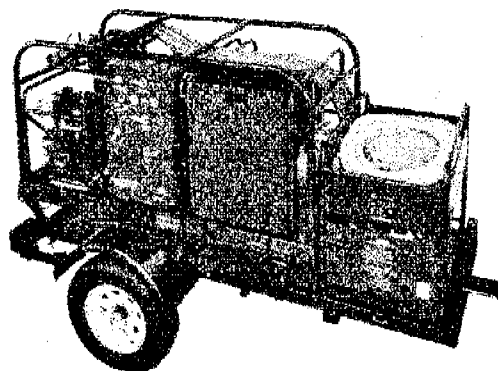

- Type:** Field portable trailer mounted water purification system
- Treatment:** Chlorination, based on a 1% solution
 Feed rates: 0-8 mg/l (ppm)
- Capacity:** 12 m³/h
- Operation:** Operated by one man
- Power unit:** 4 stroke diesel engine with integrated fuel tank, variable speed and air cooled
 Capacity: 4.5 kW
 Consumption: 2 l/h fuel
- Pump:** Self-priming centrifugal pump
 Power: 2.5 kW required
 Material: Bronze and stainless steel
 Head: 0-30 m
 Capacity: 40 m³/h
 Connections: 2 "
- Frame:**
- * Robust welded aluminium frame
 - * Protective finish
- Features:**
- * Self contained to produce approx. 100 m³
 - * Easy to transport
 - * Self explanatory
 - * Set up in approx. 30 min.
- Accessories:**
- * 2 wheeled trailer
 - * Tool kit for maintenance and repair
 - * Instructions for use
 - * Hoses and strainers
 - * Chlorine granules & chlorine test kit
 - * Protection cover for storage
 - * Spare parts for 2 years

WATER TREATMENT EQUIPMENT: WATER TREATMENT PLANT

Indicative unit price: USD 50,000
Shipping weight: 2500 kg
Shipping volume: 1 standard container
 (6 x 2.4 x 2.4 m)
UNCCS Code: 439423

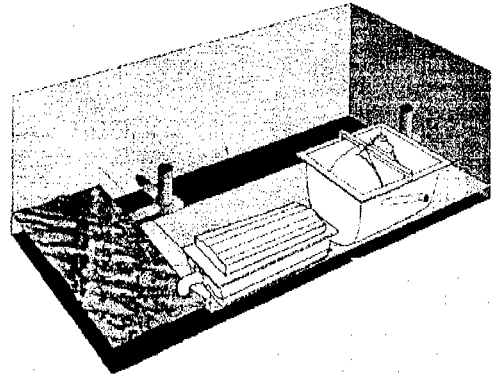

- Type:** Containerized stationary water treatment plant, non-pressure type
- Container:** 20 foot ISO-standard steel container, complete with ventilation, light and heat
6 x 2.4 x 2.4 m, 2500 kg
- Power:**
- * 12 kW diesel generator
 - * Built-in fuel tank
- Pumps:**
- * Centrifugal pump for water input
 - * Pressure pump for water output
- Treatment:**
- * Microfiltration
 - * UV disinfection
- Filter:** Non-pressure channel filter
- Type:** 17 micron
- Size:** Ø1200 mm
- UV unit:** Non-pressure UV disinfection unit, ozone-free lamps
- Burning time:** Minimum 8,000 h
- Capacity:** Approx. 30,000 l/h
- Dose:** Approx. 16 mJ/cm²
- Transmission:** Approx. 3 %/5 cm
- Water tank:** Built-in reservoir for treated water
- Features:**
- * Can be solar-powered if desired
 - * Micro-processor based control unit
 - * Easy to operate and install
- Options:** Alkaline filtration if necessary
- Accessories:**
- * Instructions for installation and use
 - * Tool kit for maintenance and repair
 - * 25 m suction hose

WATER DISTRIBUTION EQUIPMENT: WATER COLLECTION POINT

Indicative unit price: USD 200
Shipping weight: 25 kg
Shipping volume: 0.05 m³
UNCCS Code: 432484

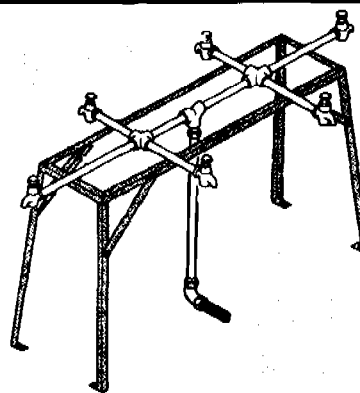

- Type:** Water collection point with 6 water-saving taps mounted on a frame including pipes and fittings
- Area of use:** For safe and easy water distribution, to be connected to a water distribution system
- Capacity:** Approx. 150 m³/day
 Approx. 6 m³/h
- Taps:**

Type:	Self-closing
Pressure:	To stand minimum 6 bar
Material:	Brass and stainless steel
- Frame**

Pre-assembled frame top
Material: Cast iron
- Pipes:**

Material: Polyethylene
To be connected to a Ø 1¼" pipe of PE
- Features:** Easy to install and operate
- Accessories:**
 - * Instructions for installation and use
 - * Tool kit for installation and maintenance
 - * Essential spare parts for 2 years
 - * Water collecting tray

WATER DISTRIBUTION EQUIPMENT: WATER PIPES, HDPE

Indicative unit price: See below
Shipping weight: See below
Shipping volume: Approx. 1 m³/bundle
UNCCS Code: 367221

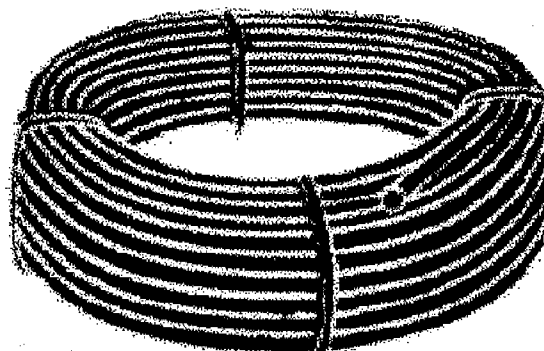

Outer diameter [mm]	Wall thickness [mm]	Indicative unit price [USD/m length]	Unit weight [kg/m length]
25	2.3	0.3	0.15
32	3.0	0.5	0.27
40	3.7	0.8	0.43
50	4.6	1.2	0.65
63	5.8	1.9	1.04
75	6.9	3.2	1.50

Type: Pipe for potable water conduit

Area of use:

- * For connection to pumps, water storage etc.
- * For trenchless laying

Material:

- * High Density Polyethylene (HDPE)
- * Approx. 0.95 g/cm³ density
- * Non toxic material, food grade approved
- * Resistant to high pressures
- * UV-stabilized

Pressure: 10 bar at 20°C

Length: 100 m, standard length

Features:

- * Quick fit compression fittings
- * Bundled in coils of 100 m
- * Coils tightly strapped and end protected
- * Abrasion and weather resistant
- * Suitable for butt welding at fusion temp. 200-220°C

WATER DISTRIBUTION EQUIPMENT: MALE AND FEMALE PIPE ADAPTORS

Indicative unit price: See below
Shipping weight: See below
Shipping volume: Approx. 0.50
 m³/1,000 units
UNCCS Code: 367275



Type	Dimensions	Unit price [USD]	Unit weight [g]
Female/Female threaded	OD ¹ 25 mm x 3/4"	0.9	60
	OD 32 mm x 1"	1.1	95
	OD 40 mm x 1 1/4"	1.7	155
	OD 50 mm x 1 1/2"	2.3	235
	OD 63 mm x 2"	3.0	375
	OD 75 mm x 3"	7.0	550
Female/Male threaded	OD 25 mm x 3/4"	0.7	55
	OD 32 mm x 1"	0.8	85
	OD 40 mm x 1 1/4"	1.4	140
	OD 50 mm x 1 1/2"	1.9	215
	OD 63 mm x 2"	3.3	350
	OD 75 mm x 3"	7.5	530

Types:

- * Female, female threaded adaptors
- * Female, male threaded adaptors

Area of use: For pipe connections

Material:

- * High Density PolyEthylene (HDPE)
- * Resistant to high pressures
- * Non-toxic, food grade approved
- * Reinforced, high impact strength

Pressure: 10 bar at 20°C

Features: UV-stabilized

1 Outer Diameter

WATER DISTRIBUTION EQUIPMENT: WATER GATE & CHECK VALVES

GATE (SLUICE) VALVES

Indicative unit price: USD 30
Shipping weight: 3kg (1" valves)
Shipping volume: 0.005 (1" valves)
UNCCS Code: 432417

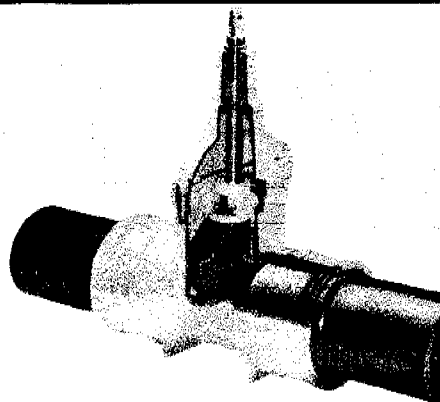

Type: Gate (sluice) valve for water distribution
Material: Brass or Gunmetal, coated with a non-toxic and non-corrosive surface
Size: ½ - 3"
Sockets: Female
Pressure: Maximum 10.34 bar
Temperature: Maximum 65°C

CHECK VALVES

Indicative unit price: USD 15
Shipping weight: 0.3 kg (1" valves)
Shipping volume: 0.001 (1" valves)
UNCCS Code: 432413

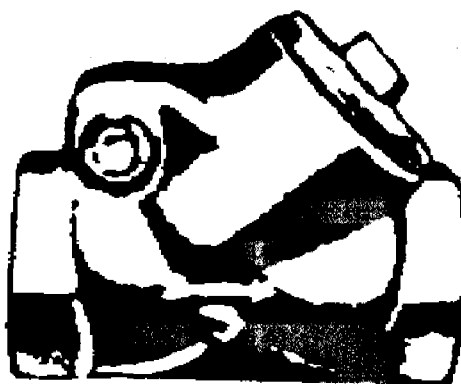

Type: Swing check valve for water distribution systems
Material: Brass
Size: ½-3"
Sockets: Female
Pressure: Maximum 10.34 bar
Temperature: Maximum 65°C

WATER DISTRIBUTION EQUIPMENT: WATER TAPS AND VALVES

SELF CLOSING TAPS

Indicative unit price: USD 12
Shipping weight: 60 kg/100 units
Shipping volume: 0.2 m³/500 units
UNCCS Code: 432483

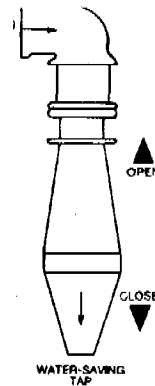

Type: Water tap, self closing of rugged construction
Size: ½-1"
Thread: Whitworth thread, Female
Material: Brass and stainless steel

BALL VALVES

Indicative unit price: USD 20
Shipping weight: Approx. 50-100 kg/1,000 units
Shipping volume: Approx. 0.5-1.0 m³/1,000 units
UNCCS Code: 432411

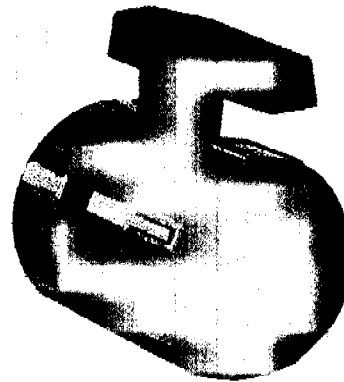

Type: Ball valve for water distribution
Area of use: For storage tanks
Material: PVC, Non-toxic material
Size: ½-2"
Construction: Reversible, self-lubricating teflon seals and viton O-rings, seat tension externally adjustable to compensate for wear
Ball valves: Quick acting valves, inert to corrosive media
Sockets: Female
Pressure: Maximum 10.34 bar
Temperature: Maximum 65°C
Features:

- * UV-stabilized
- * Non-corrosive

WATER DISTRIBUTION EQUIPMENT: WATER DISTRIBUTION PACK

Indicative unit price: USD 2,000
Shipping weight: 200 kg
Shipping volume: 0.5 m³
UNCCS Code: 432570

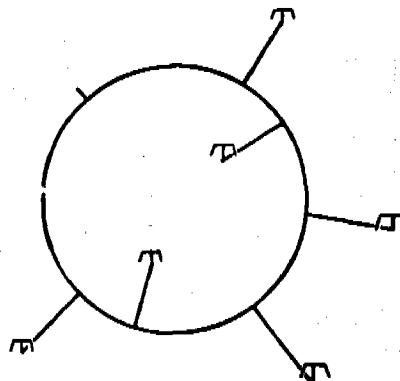

Type: Water distribution kit with 6 distribution points

Capacity: Approx. 150 m³/day
 Approx. 6 m³/h

To include:

- * 1 distribution main pipe
- * 6 connecting pipes
- * 6 collection points
- * Fittings, pipework, valves and parts

Distribution pipe:

- Size:** Ø 3" x 600 meters
- Material:** PVC pipe

Connecting pipe:

- Size:** Ø 1¼" x 50 meters
- Material:** PE pipe

Collection points: To confirm the specification for water collection point, fitted with self-closing taps

Features: Easy to install and operate

Accessories:

- * Instructions for installation and use
- * Tool kit for installation and maintenance
- * Essential spare parts for 2 years of operation
- * Water collection tray

TOOL KITS: PUMP TOOL SET

Indicative unit price:	USD 100
Shipping weight:	20 kg
Shipping volume:	0.06 m ³
UNCCS Code:	429253

Type: Tool set for maintenance of water pump

- To include:**
- * 2 pcs. Strap wrenches, 200mm Ø capacity.
 - * 1 pcs. Adjustable pipe wrench, 140mm capacity
 - * 1 pcs. Junior hacksaw complete with 10 blades.
 - * 1 pcs. 8" adjustable spanner.
 - * 1 pcs. Screwdriver 6" blade.
 - * 1 Set Combination spanners 7/16 - 3/4" A.F.
 - * 1 pcs. Combination spanner 1/4" B.S.F
 - * 1 Set Allen keys 7/32", 3/16" and 3 mm.
 - * 1 pcs. Pair pliers.
 - * 1 Set Metric feeler gauges.
 - * 1 pcs. Oil can.

TOOL KITS: WATER SYSTEM TOOL SET

Indicative unit price:	USD 120
Shipping weight:	10 kg
Shipping volume:	0.01 m ³
UNCCS Code:	429254

Type: Tool set for installation and maintenance of pipes in a water supply system

To include:

- * 1 pcs. Tool box, steel
- * 2 pcs. 12" screwdrivers
- * 1 pcs. 8" half round file with handle
- * 1 pcs. 4" round file with handle
- * 1 pcs. Knife needle file with handle
- * 2 pcs. 8" adjustable spanner, capacity 1"
- * 2 pcs. Strap wrenches, 200mm Ø capacity.
- * 1 pcs. Stillson pipe wrench, 65 mm Ø capacity
- * 1 pcs. Adjustable pipe wrench, 150 mm Ø capacity
- * 1 pcs. 12" hacksaw complete with 6 blades
- * 1 pcs. Surform plane complete with 2 blades
- * 1 pcs. Retractable knife with 5 blades
- * 10 rolls. Teflon tape
- * 1 pcs. Pencil, workers

NOTES

CHAPTER 4 - FOOD ITEMS

NEEDS AND RECOMMENDED RESPONSES

General

The purpose of this chapter is to provide guidance to the donors and to the procurement staff as to what food commodities should be provided in emergencies. Apart from the potential waste of resources and flooding of relief operations with unwanted products, there are other consequences related to health, social and economic situations that can occur when improper food commodities are supplied. There are several misconceptions related to food and nutrition, and one of them is that starving people can eat anything. This attitude is inhumane and incorrect. Even if hungry, people often do not consume adequate quantities of unfamiliar foods for long times. Moreover, starving people are often ill and may not have a sufficient appetite. They will therefore languish in an emaciated state or become even weaker. Therefore, it is essential to provide familiar and nutritionally adequate food items which are palatable.

This chapter therefore provides a checklist and a set of standard specifications for use by donor countries who are trying to buy food commodities for emergency relief and/or donate food, with the aim of minimizing their inappropriate use.

The key issues under critical consideration are the degrees of cultural acceptance and familiarity, since food which is not eaten has no nutritional value.

The standardized specifications of food commodities will not only facilitate the identification of potential suppliers and prices, but will create a method for better quality control.

The Needs

Food supplies the body with energy in the form of protein, carbohydrates and fat, which are needed to maintain the functions of the body. Food also provides the body with materials such as amino acids, vitamins and minerals. These materials help the body to control the growth and maintenance of the cells, while losses of some of these materials will result in an unhealthy population. This will make an emergency situation even worse. When choosing food, these aspects have to be taken into consideration.

To feed a population, the following important factors should also be considered when selecting the products for food aid:

- * Suitability
- * Local habits
- * Availability of fuel and clean water
- * Acceptability

a) *Nutritional needs*

Nutrition is an important factor for consideration when selecting the type of food for a specific operation. The short term nutrition needs of disaster relief are not as stringent as those of population groups subsisting for longer periods of time on food supplied through aid sources. Energy is the most important nutritional requirement in food aid. Generally, if enough energy is provided in a mixed diet, the protein required is also present. For food aid where only two or three foods may be available, there is a need to ensure that protein quality and quantity is adequate.

Vitamins and minerals do not need to be considered for first phase of emergency situations but do need to be considered for "temporary maintenance" and "long term" feeding. Deficiency of vitamin A, iron and iodine are the three nutritional problems targeted by WHO as the most significant in developing countries.

NEEDS AND RECOMMENDED RESPONSES

b) Food basket

Ideally the "basket" should provide a specific amount of energy, calculated in terms of the given amount of calories and protein derived from cereals, milk, meat, fish, oils etc.. The commodities chosen for the "basket" should furthermore correspond as closely as possible to the normal eating habits of the persons receiving the food aid.

The items normally required for first phase of emergencies could be classified as follows:

- * Cereals
- * Dried legumes
- * Dairy product
- * Edible oils
- * Meats and fish
- * Blended/processed food
- * Miscellaneous

In deciding the mix, the following factors need also to be considered, and may usually lead to various compromises:

- Nutritional requirements may vary according to type of activity, to location and to season.
- There may be some local products available for purchase, these should then be bought and not included in the food basket from external sources.
- The limited shelf life of certain commodities under conditions of high humidity and/or temperature needs to be taken into consideration.
- The local transport capacity and storage facility may be inadequate.

Cereals

These account for 90 percent of all food aid in volume terms and 75 percent in value terms. In general, cereals for food aid comprise wheat, maize and rice.

a) Wheat

Wheat which has been shipped as bulk grain, forms the major share of food aid allocation. Some type of processing will therefore be required before it can be consumed as bread. In some cases, processing is a problem. For this reason, wheat is frequently sent as flour rather than as grain. The flour is usually bagged in thin cotton sacks and has a limited shelf life in hot and humid conditions.

b) Maize

There is considerable production of maize in the traditional donor group countries. Maize is a staple in many parts of Africa, Latin America and the Caribbean. In the case of Africa, most of the local maize is of white variety.

c) Rice

Rice is a staple in most parts of Asia. It is generally shipped parboiled or polished to eliminate parasites and improve shelf life.

d) Other cereals

Cereals such as barley, rye, sorghum and oats are products which are common in some smaller regions. These products are normally not provided in first phase food baskets, but in "long term" or "temporary maintenance" feeding programs. These products should be considered as food which is closely related to traditional local consumption.

NEEDS AND RECOMMENDED RESPONSES

Dried legumes

In tropical and sub-tropical countries a wide varieties of beans, peas and tubers are a part of the traditional diet. The lower-cost varieties most commonly grown in temperate climates are lentils, chick peas and cow peas, which in recent years have become part of food-aid. The supply of pulses however is limited since it is more time consuming to soak and cook, and it possesses a higher fuel and water requirement compared to rice.

Dairy products

Major relief agencies have come to very strict policies regarding the use of dairy products in emergency situations. Usually, they supply and distribute milk products only in a supervised environment for on the spot feeding of severely malnourished children. It is also acknowledged that powdered dried skimmed milk, premixed centrally with cereal flour and sugar, is useful for feeding young children, especially if prepared with oil.

Powdered dried skimmed milk and dried whole milk cannot be given directly to malnourished children. Their mineral content and their high protein concentration makes them unsafe to use when the kidney cannot produce concentrated urine, which frequently occurs among young or malnourished infants. Moreover, the high lactose content of dried skimmed milk may induce or aggravate diarrhoea, especially in the malnourished child. These dairy products can be used safely only after addition of oil and sugar in hygienic conditions and under close supervision.

Therapeutic milk has its protein and mineral content adapted for the treatment of severe malnutrition. It also contains vitamins and trace elements in therapeutic amount to correct coexisting deficiencies.

Edible oils

This covers oils derived from maize, rape, soyabean, sunflower, palm, ground nuts etc. These oils are used for frying which is considered one of the safest means of cooking. Normally, the oils used for food aid are rapeseed, soyabean, sunflower or palm oil because of their nutritional values compared with price and availability.

Meats and fish

Meat is seen as the most desirable source of animal protein but its supply is limited due to both availability and cost. When providing meat in food baskets, it is important to choose meat which is commonly used in, and is in accordance with the religion and traditions of the disaster area.

Fish is supplied in dry or canned forms. Most frequently the canned form is being provided in food parcels. The advantage with both meat and fish is that they are good protein sources and have a long shelf life.

Blended/processed foods

A number of blended foods have been made available in food aid, mostly in the form of fortified cereal blends. One of these is wheat soya blend (WSB). The cost for blended food is relatively high and has a limited provision for food aid.

Miscellaneous

a) Biscuits

In many situations biscuits are provided as a part of the food parcels, and in supplemental foods for children,

NEEDS AND RECOMMENDED RESPONSES

pregnant and lactating mothers, the biscuit is very valuable. Compared to the weight and volume it has a high energy density and high contents of protein and can be fortified with essential vitamins and minerals.

b) Packaging

When deciding the packaging requirements, the three following main subjects should be considered:

- * The type of food to be transported
- * The type of transportation from manufacturer to end-user
- * The cost and availability of the packing to be used

The guidelines for each group of food product is explained below:

Cereals

- Jute sacks: minimum weight 500 g/m²
- Composite Jute/polypropylene sacks: minimum weight of 300 g/m²
- Woven polypropylene sacks: minimum weight 120 g/m² and treated against ultra violet light, in a way that does not impair foodstuffs.

Cereal flour

- Jute sacks lined with woven polypropylene
- Cotton sacks lined with woven polypropylene
- Composite jute/polypropylene sacks: minimum weight 330 g/m²
- Woven polypropylene sacks
- Multilayer kraft paper, 4 plies

Canned foods

- Cans with a non-toxic coating to prevent corrosion and contamination with built-in openers.

Products of second-stage processing (i.e. pasta, blended food etc.)

- Outer packaging shall be of cardboard or shrink-wrapped polyethylene film of sufficient strength to survive transportation.

Oleaginous products

- Metal containers coated externally with varnish and internally with edible varnish. The container shall be hermetically sealed after filling in an atmosphere of nitrogen.
- Plastic drums or PET bottles.

In general, when containers or cartons are used, the following recommendations should be observed:

- * Individual items such as cans etc. shall be suitably packed in cartons or boxes, and strapped before palletizing.
- * All carton should be of at least double-wall construction to withstand a bursting strength of 17.6 kg/cm². Each container, carton, box, packet, bag etc. should contain a net weight not exceeding 25 kg.
- * All containers, cartons, boxes, packages etc. shall be tightly sealed and strapped with steel or nylon straps.
- * A transparent plastic cover of reasonable strength shall be installed as protection against water.

NOTES

CEREALS: WHEAT (TRITICUM)

Indicative unit price:	USD 140/MT
Stowage Factor:	680 - 830 kg/m ³
UNCCS Code:	011100

Types:	Soft wheat:	For average bread-making qualities
	Hard wheat:	For average superior bread-making qualities

General Description: Common wheat of fair and sound and marketable quality, free of odour and live pests, which produces dough that is not sticky and can be milled.

Quality Specifications: According to official government standards of country of origin.

Typical Quality Specifications:

Moisture:	14 %	maximum
Foreign matter:	1 %	maximum
Broken grains:	4 %	maximum
Heat damaged grains:	0.5 %	maximum
Sprouted grains:	1 %	maximum
Specific weight:	76 kg/hl	minimum
Protein content:	11 %	minimum (N x 5.7 of dry matter)
Hagberg falling number:	220	minimum, including preparation (agitation time of 60 seconds)
Zeleny index:	20	minimum
Crop year:		To be specified

Packaging: In polypropylene bags of 50 kg or bulk

Nutritional values per 100g:

Energy:	350	kcal
Protein:	11.5 g	minimum
Fat:	2.5 g	maximum
Carbohydrate:	75 g	maximum

**CEREALS:
RICE, HUSKED (ORYZA SATIVA)**

Indicative unit price: USD 260/MT
Storage factor: 800 - 900 kg/m³
UNCCS Code: 011400

Types: **Indica type:** Long grain white rice
Japonica type: Short/round grain white rice

General Description: White milled grain rice of fair and sound and marketable quality, free of odour and live pests, fit for human consumption.

Quality specifications: According to official government standards of country of origin.

Typical quality Specifications:	<u>5 % Broken</u>		<u>35 % Broken</u>	
	Moisture:	14 %	max	14 %
Foreign matter:	1 %	max	14 %	max
Broken rice:	5 %	max	35 %	max
Chalky grains:	4 %	max	10 %	max
Grains streaked with red:	3 %	max	5 %	max
Spotted grains:	1.5 %	max	N/A	
Stained grains:	1 %	max	N/A	
Yellow grains:	0.050%	max	2 %	max
Amber grains:	0.2 %	max	N/A	
Damaged grains:	N/A		2.5 %	max
Glutinous rice:	N/A		2.5 %	max
Paddy (grains/kgs):	N/A		35	max
Crop year:	To be specified		To be specified	

Tolerance of extraneous matter consisting of:

- * **Inedible mineral and vegetable substances provided they are not toxic:** 0.01 % maximum
- * **Edible extraneous grains or parts thereof:** 0.10 % maximum

Packaging: In jute bags of 50 kg, stitched at mouth or in 1 kg multiwall paper bags

Nutritional values per 100g:

Energy:	370 kcal
Protein:	7.1 g minimum
Fat:	0.5 g maximum
Carbohydrate:	81 g maximum

CEREALS:
SORGHUM GRAIN (SORGHUM BICOLOR)

Indicative unit price: USD 100/MT
Stowage factor: 650 - 780 kg/m³
UNCCS Code: 011920

Types:

- * White
- * Yellow/brown

General Description: Sorghum of fair, sound and marketable quality. Free of odour and live pests, fit for human consumption.

Quality specifications: According to official government standards of country of origin.

Typical quality specifications:

Moisture: 14.5 % maximum
Total defects: 8 % maximum
Of which:

- * **Diseased grains:** 0.5 % maximum
- * **Broken kernels:** 5 % maximum
- * **Other grains:** 1 % maximum
- * **Foreign matter:** 2 % maximum

Crop year: To be specified

Sorghum grains shall be free from toxic or noxious seeds in amounts which may represent a hazard to health

Packaging: In jute bags of 50 kg, stitched at mouth

Nutritional values per 100g:

Energy: 370 kcal
Protein: 7.0 g minimum
Fat: 1.0 g maximum
Carbohydrate: 80 g maximum

**CEREALS:
MAIZE (ZEA MAIS)**

Indicative unit price: USD 100/MT
Stowage factor: 640-750 kg/m³
UNCCS Code: 011220

Types: White or yellow maize (corn)

General description: Maize of fair, sound and marketable quality, free of odour and live pests, fit for human consumption.

Quality specifications: According to official government standards of country of origin.

Typical quality specification:

Moisture:	14 %	maximum
Foreign matter:	1.5 %	maximum
Sprouted grains:	0.5 %	maximum
Broken kernels:	5 %	maximum
Weevilled damaged kernels:	3 %	maximum
Other types: (dented/ semi dented)	3 %	maximum
Other colour:	3 %	maximum
Aflatoxin:	20 ppb	maximum
Crop year:	From the current crop	
Type:	Flint or dent (to be specified)	

Maize not to contain fungus produced toxins

Packaging: In jute bags of about 50 kg gross weight each bag or bulk

Shelf life: 1 year

Nutritional values per 100g:

Energy:	365	kcal
Protein:	7.8 g	minimum
Fat:	1.2 g	maximum
Carbohydrate:	77 g	maximum

CEREAL PRODUCTS: WHEAT FLOUR

Indicative unit price : USD 220/MT
Stowage Factor: 490 - 560 kg/m³
UNCCS Code: 231110

Types:

- * White
- * Dark

General description: Wheat flour of fair, sound and marketable quality, free of odour and live or dead pests, which produces a dough that does not stick during the mechanical kneading process. From grain not older than 2 years.

Quality specifications: According to official government standards of country of origin.

Typical quality specification:

Moisture:	14 %	maximum
Protein:	10.5 %	minimum (N x 6.25 of dry matter)
Ash content:	0.62 %	maximum of dry matter
Hagberg falling number:	220	minimum
including preparation (agitation time of 60 seconds)		
Zeleny index:	20	minimum

Packaging: In polypropylene bags of 50 kg or bulk

Nutritional values per 100g:

Energy:	350	kcal
Protein:	10.5 g	minimum
Fat:	1.7 g	maximum
Carbohydrate:	73 g	maximum

CEREAL PRODUCTS: MAIZE FLOUR

Indicative unit price :	USD 160/MT
Storage Factor:	460 - 500 kg/m ³
UNCCS Code:	231240

Types:

- * Maize grits
- * Maize flour
- * Maize meal

General description: Maize flour of fair, sound and marketable quality, free of odour and live or dead pests.

Quality specifications: According to official government standards of country of origin.

Typical quality specifications:

Moisture:	13.5 %	maximum
Protein:	8 %	approx. (N x 6.25 of dry matter)
Fibre:	1.2 %	maximum
Fat:	3-4 %	maximum
Granulation to pass through 1.4 mm sieve:	90 %	minimum

Packaging: In polypropylene bags of 50 kg or bulk

Nutritional values per 100g:

Energy:	365	kcal
Protein:	8 g	minimum
Fat:	1.2 g	maximum
Carbohydrate:	77 g	maximum

CEREAL PRODUCTS: PASTA AND NOODLES WHEAT

Indicative unit price:	USD 350/MT
Stowage factor:	300 kg/m ³
UNCCS Code:	237110

Types:

- * Long pasta
- * Short pasta
- * Noodles

General description: Pasta made from durum wheat meal

Quality specifications: According to official government standards of country of origin.

Typical quality specifications:

Moistures:	12.5 %	maximum
Protein content:	10.5 %	minimum (n x 5.70 of dry matter)
Ash content:	0.70 %	minimum of dry matter
	0.90 %	maximum
Cellulose:	0.20 %	minimum of dry matter
	0.45 %	maximum
Acid value:	Not more than the acid value expressed by the number of cm ³ of normal alkaline solution required to neutralize 100g of dry matter.	

Packaging: In polypropylene bags of 500g or 1 kg

Nutritional values per 100g:

Energy:	365	kcal
Protein:	10.5 g	minimum
Fat:	1.5 g	maximum
Carbohydrate:	75 g	maximum

**BLENDED FOOD:
WHEAT SOYA BLEND (WSB)**

Indicative unit price: USD 415/MT
Stowage factor: 800 kg/m³
UNCCS Code: 239976

Type: Wheat soya blend (WSB)

Ingredients:

Bulgur flour:	53.1 %
Wheat protein concentrate:	20 %
Soya flour:	20 %
Soya oil:	4.0 %
Mineral premix:	2.8 %
Vitamin premix:	0.1 %

Quality specifications: According to official government standards of country of origin.

Typical quality specifications:

Moisture:	11.0 %	maximum
Protein:	20.0 %	minimum
Crude fat:	6.0 %	minimum
Ash:	6.6 %	maximum
Crude fiber:	2.5 %	maximum
Lysine:	0.9 %	minimum

Packaging: Packed in 25 kg bags, 3 ply kraft paper with an inner poly liner

Nutritional values per 100g:

Energy:	400	kcal	minimum
Protein:	14	g	minimum
Fat:	7	g	maximum
Carbohydrate:	75	g	maximum

**BLENDED FOOD:
CORN SOYA BLEND (CSB)**

Indicative unit price: USD 343/MT
Stowage factor: 900 kg/m³
UNCCS Code: 239977

Type: Corn soya blend (CSB)

Ingredients:

Processed gelatinized maize meal:	69.85 %
Defatted toasted soya flour:	21.85 %
Refined deodorized stabilized soya oil:	5.5 %
Mineral premix:	2.7 %
Vitamin premix:	0.1 %

Quality specifications: According to official government standards of country of origin.

Typical quality specifications:

Moisture:	10.0 %	maximum
Protein:	16.7 %	minimum
Fat contents:	6.0 %	minimum
Crude Fiber:	2.0%	maximum
Ash:	3 %	maximum
Carbohydrates:	70 %	(tolerance maximum 5 %)
Vitamin mix:	0.5	kg/mt
Mineral mix:	2	kg/mt

Packaging: Packed in 25 kg bags, 3 ply kraft paper with an inner poly liner

Nutritional values per 100g:

Energy:	400	kcal	minimum
Protein:	14	g	minimum
Fat:	7	g	maximum
Carbohydrate:	75	g	maximum

**BLENDED FOOD:
WHEAT SOYA MILK (WSM)**

Indicative unit price:	USD 634/MT
Stowage factor:	800 kg/m ³
UNCCS Code:	221121

Type: Wheat soya milk (WSM)

Ingredients:	Bulghur flour:	45.6 %
	Wheat protein concentrate:	17.2 %
	Defatted toasted soya flour:	15.0 %
	Stabilized soya oil:	4.3 %
	Mineral premix:	2.8 %
	Vitamin premix:	0.1 %

Quality specifications: According to official government standards of country of origin.

Typical quality specifications:	Moisture:	9.5 %	maximum
	Protein:	20.0 %	minimum
	Crude fat:	6.0 %	minimum
	Ash:	6.6 %	maximum
	Crude fiber:	2.5 %	maximum
	Lysine:	0.9 %	minimum

Packaging: Packed in 25 kg bags, 3 ply kraft paper with an inner poly liner

Nutritional values per 100g:	Energy:	400 kcal	minimum
	Protein:	14 g	minimum
	Fat:	7 g	maximum
	Carbohydrate:	75 g	maximum

**BLENDED FOOD:
CORN SOYA MILK (CSM)**

Indicative unit price:	USD 569/MT
Stowage factor:	900 kg /m ³
UNCCS Code:	221122

Type: Corn soya milk (CSM)

Ingredients:	Processed gelatinized maize meal:	59.2 %
	Defatted toasted soya flour:	17.5 %
	Refined deodorized stabilized soya oil:	5.5 %
	Non-fat spray-dried milk:	15.0 %
	Mineral premix:	2.7 %
	Vitamin premix:	0.1 %

Quality specifications: According to official government standards of country of origin.

Typical quality specifications:	Moisture:	9.5 %	maximum
	Protein:	19.0 %	minimum
	Crude fiber:	2.0 %	maximum
	Fat:	6.0 %	maximum

Packaging: Packed in 25 kg bags, 3 ply kraft paper with an inner poly liner

Nutritional values per 100g:	Energy:	400	kcal	minimum
	Protein:	14	g	minimum
	Fat:	7	g	maximum
	Carbohydrate:	75	g	maximum

PULSES:
DRIED BEANS (PHASEOLUS VULGARIS)

Indicative unit price:	USD 250-450/ MT
Stowage factor:	900 kg/m ³
UNCCS Code:	012210

Type:

- * Red speckled kidney beans.
- * Mixed coloured beans

General Description: Beans of fair, sound and marketable quality, free of odour and live pests, fit for human consumption. The beans must be shelled, clean and fumigated.

Quality specifications: According to official government standards of country of origin.

Typical quality specification:

Moisture:	15 %	maximum
Foreign matter:	1 %	maximum
Split, rotten and discoloured:	4 %	maximum
Broken or damaged beans:	4 %	maximum
Of which insect damaged:	1 %	maximum
Cooking time after soaking for 24 hours:	90 minutes	maximum
Crop year:	To be specified	

Packaging: 1 or 50 kg jute bags

Nutritional values per 100 g:

Energy:	355	kcal	
Protein:	25	g	minimum
Fat:	1.7	g	maximum
Carbohydrate:	58	g	maximum

**PULSES:
HORSE BEANS (VICIA FABA)**

Indicative unit price:	USD 300/MT
Stowage factor:	900 kg/m ³
UNCCS Code:	012227

Type: Horse beans (also broad or Faba beans)

General Description: Horse beans of fair, sound and marketable quality, free of odour and live pests, fit for human consumption. The beans are washed and fumigated

Quality specifications: According to official government standards of country of origin.

Typical quality specification:

Moisture:	16 %	maximum
Foreign matter:	5 %	maximum
Broken beans:	2 %	maximum
Damaged beans:	8 %	maximum
Cooking time after soaking for 24 hours:	90 minutes	maximum
Crop year:	To be specified	

Packaging: 1 or 50 kg jute bags

Nutritional values per 100g:

Energy:	355	kcal
Protein:	25	g minimum
Fat:	1.7	g maximum
Carbohydrate:	58	g maximum

PULSES:
WHOLE PEAS (PISUM SATIVUM/ARVENSE)

Indicative unit price:	USD 300/ MT
Stowage factor:	880 kg/m ³
UNCCS Code:	012254

Type:

- * Dried, whole green peas
- * Dried, whole yellow peas

General description: Peas of fair , sound and marketable quality, free of odour and live pests, fit for human consumption.

Quality specifications: According to official government standards of country of origin.

Typical quality specifications:

Moisture:	15 %	maximum
Foreign matter:	1 %	maximum
Purity:	99%	minimum
of which		
* Broken/Split:	3 %	maximum
* Damaged/Weevilled/Eaten:	1.5 %	maximum
* Spoiled/Brownish Stained:	2 %	maximum
* Wrinkled:	2.5 %	maximum
Crop year:	To be specified	

Packaging: 50 kg in multiwall or jute bags

Nutritional values per 100g:

Energy:	340	kcal
Protein:	21.6	g minimum
Fat:	1.3	g maximum
Carbohydrate:	60	g maximum
Vitamin A:	417	I.U.

**PULSES:
SPLIT PEAS (PISUM SATIVUM/ARVENSE)**

Indicative unit price:	USD 400/MT
Stowage factor:	880 kg/m ³
UNCCS Code:	012252

Type:

- * Split green peas
- * Split yellow peas

General description: Peas of fair, sound and marketable quality, free of odour and live pests, fit for human consumption.

Quality specifications: According to official government standards of country of origin.

Typical quality specifications:

Moisture:	15 %	maximum
Foreign matter:	0.1 %	maximum
Purity:	99.9 %	minimum
of which		
* Broken/Split:	1 %	maximum
* Damaged/Weevilled/Eaten:	0.3 %	maximum
Colour:	Good natural colour	
Percentage of other colour:	1 %	maximum
Cooking time after soaking for 24 hours:	60 minutes	maximum
Fumigation:	To be specified	
Crop year:	To be specified	

Packaging: 50 kg in multiwall bags

Nutritional values

per 100g:	Energy:	340	kcal	
	Protein:	21.6	g	minimum
	Fat:	1.3	g	maximum
	Carbohydrate:	60	g	maximum
	Vitamin A:	417	I.U.	

**PULSES:
DRIED LENTILS (LENS ESCULENTA)**

Indicative unit price:	USD 550/MT
Stowage factor:	890 kg/m ³
UNCCS Code:	012240

Type:

- * Whole red lentils
- * Whole green lentils

General description: Dried lentils for human consumption shall be clean, fumigated, dry and free from mould and living vermin

Composition:	Moisture:	13 %	maximum
	Foreign matter:	1 %	maximum
	Damaged lentils:	3 %	maximum
	Of which vermin damaged:	1 %	maximum
	Ash:	3 %	maximum

Packaging: 50 kg in multiwall bags

Nutritional values per 100g:	Energy:	350	kcal	
	Protein:	24	g	minimum
	Fat:	1	g	maximum
	Carbohydrate:	63	g	maximum

**PULSES:
CHICKPEAS**

Indicative unit price: USD 1000/
MT
Stowage factor: 750 kg/m³
UNCCS Code: 012233

Chickpeas type: Spayola, size 28/30

General description: Chickpeas of fair, sound and merchantable quality, free of odour and live pests, fit for human consumption, fumigated maximum ten days prior delivery.

Quality specifications: According to official government standards of country of origin

Typical quality specifications:

Moisture content:	max 14%
Foreign matter:	max 1%
Weevilled grains:	max 1%
Total defective grains: (discolored, rotten, broken, diseased, mouldy)	max 13%
Cooking time: (after soaking 24 hrs)	max 90 minutes
Undersized:	max 10%
Size 28:	max 30%

EDIBLE OILS: RAPESEED OIL

Indicative unit price: USD 800/1000 litre
Stowage factor: 860 kg/m³
UNCCS Code: 216561

Type: Refined rape seed oil

General description: The fully refined and deodorized rape seed oil must be of fresh production and fit for human consumption.

Quality specifications: According to official government standards of country of origin.

Typical quality specification:

Water and impurities: 0.2 % maximum
Free fatty acids: 0.15 % maximum, expressed as oleic acid
Erucic acid: Maximum 5 % of total fatty acids present
Brassicasterol: Minimum 5 % of total sterol content
Soap: Absent
Foreign odours and flavours: Absent
Peroxide number: Below 10 milliequivalents of active oxygen per kilogram of oil
Authorized additives: 100 mg of butylated hydroxytoluene (BHT-E-321) per kilogram of oil

Packaging:

- * Packed in jerry cans of 4 or 5 litres capacity or PET bottles of 1 litre
- * Airtight, with welded aluminium diaphragm seal.
- * Export worthy cartons of 4 cans each

Nutritional values per 100 g:

Energy: 880 kcal
Fat: 100 g

EDIBLE OILS: SOYA BEAN OIL

Indicative unit price:	USD 800/1000 litre
Stowage factor:	870 kg/m ³
UNCCS Code:	216510

Type: Soya bean oil

General description: The fully refined and deodorized soya bean oil must be of sound, fair and marketable quality. Fit for human consumption.

Quality specifications: According to official government standards of country of origin.

Typical quality specification:

Moisture & volatile matter at 105°C:	0.1 %	maximum
Free Fatty Acid (expressed as oleic acid):	0.1 %	maximum
Colour (5¼" lovibond scale):	20 yellow/2 red	maximum
Iodine value:	120/143	
Saponification value:	mg KOH/G oil	189 - 195
Soap content:	0.005 %	maximum
Unsaponifiable matter:	1.5 %	maximum
Peroxide number: *	Maximum 2 milli equivalents peroxide oxygen per kilogram of oil	
*	Clear and brilliant in appearance at 70 - 85° C	

Packaging:

- * Packed in jerry cans of 4 or 5 litre capacity or PET bottles of 1 litre
- * Airtight, with welded aluminium diaphragm seal.
- * Export worthy cartons of 4 cans each

Nutritional values per 100g:

Energy:	880	kcal
Fat:	100	g

EDIBLE OILS: SUNFLOWER OIL

Indicative unit price:	USD 1/litre
Stowage factor:	870 kg/m ³
UNCCS Code:	216551

Type: Sunflower oil

General description: The refined sunflower oil must be of sound, fair and marketable quality

Quality specifications: According to official government standards of country of origin

Typical quality specification:

Water and impurities:	0.2 %	maximum
Free fatty acids (expressed as oleic acid):	0.15 %	maximum
Linolenic acid of total fatty acids present:	5 %	maximum
Delta-7-stigmastrol of total sterol content, and absence of brassicasterol:	9 %	minimum
Soap:	Absence	
Foreign odours and flavours:	Absence	
Peroxide number:	Below 10 millicquivalents of active oxygen per kilogram of oil	
Authorized additives:	100 mg of butylated hydroxytoluene (BHT-E-321) per kilogram of oil	

Packaging:

- * Packed in jerry cans of 4 or 5 litre capacity or PET bottles of 1 litre
- * Airtight, with welded aluminium diaphragm seal.
- * Export cartons of 4 cans each

Nutritional values per 100g:

Energy:	880	kcal
Fat:	100	g

EDIBLE OIL: PALM OIL

Indicative unit price:	USD 750/1000 litre
Stowage factor:	840 kg/m ³
UNCCS Code:	216720

Type: Palmolein oil

General description: The refined palmolein oil must be of sound, fair and marketable quality

Quality specifications: According to official government standards of country of origin

Typical quality specification:

Water and impurities:	0.1 %	maximum
Free fatty acids:	0.1 %	maximum
Colour (5¼ inch lovibond cell):	red 6	maximum
Phosphorus:	4 ppm	maximum
Iodine value:	50 to 60	minimum
Palmitic acid:	41-45 % of total fatty acids present	
Cholesterol:	4 % maximum of total sterol content	
Oleic acid:	36-41 % of total fatty acids present	
Melting point:	24 degrees centigrade maximum	
(slip point, softening point or rising point)		
Peroxide value:	10 mg/1 kg	maximum
Unsaponifiable matter:	1.2 %	maximum
Refractive index at 40°C:	1.4580 - 1.4590	
Relative density:	0.910 - 0.915(27°C/water at 27°C)	
Saponification value:	195-205(as mg KOH/GM)	

Packaging:

- * Packed in jerry cans of 4 or 5 litres capacity or PET bottles of 1 litre
- * Airtight, with welded aluminium diaphragm seal.
- * Export cartons of 4 cans each

Nutritional values per 100g:

Energy:	880	kcal
Fat:	100	g

EDIBLE OIL: BUTTER OIL

Indicative unit price:	USD 2000/MT
Stowage factor:	600 kg/m ³
UNCCS code:	229420

Type: Butter oil

General description: Butter oil made from milk fat

Quality specifications: According to official government standards of country of origin

Typical quality specification:

Moisture:	0.1 %	maximum
Milk fat:	99.8 %	minimum
Free fatty acids:	0.3 %	expressed as oleic acid
Peroxide value:	0.3 meq/kg	maximum
Copper:	0.05 ppm	maximum
Iron:	0.3 ppm	maximum
Absence of pathogenic/toxic bacteria and/or salmonella and/or mouse disease.		

Packaging: 200 kg metallic drums coated internally with edible varnish or in 2 kg metallic drums

Nutritional values per 100g:

Energy:	725	kcal/100g
Protein:	0.6 g/100g	minimum
Fat:	81.4 g/100g	maximum
Carbohydrate:	0.6 g/100g	maximum
Vitamin A:	3400 I.U./100g	

EDIBLE OIL: MARGARINE

Indicative unit price: USD 1500/MT
Stowage factor: 700 kg/m³
UNCCS code: 216810

Type: Margarine

General description: Margarine made of edible fats and/or oils containing water, milk and/or milk products

Quality specifications: According to official government standards of country of origin

Typical quality specification:

Water contents:	16 %	maximum
Fat:	80 %	minimum
Iron:	1.5 ppm	maximum
Copper:	0.1 ppm	maximum
Lead:	0.1 ppm	maximum

Packaging: Packed in 2.5 kg tins of aluminium or 50 kg drums of steel

Nutritional values:	Energy:	710	kcal/100g	
	Protein:	0.6	g/100g	minimum
	Fat:	80	g/100g	minimum
	Carbohydrate:	0.4	g/100g	maximum
	Vitamin A:	900	I.U./100g	

DAIRY PRODUCTS: DRIED SKIMMED MILK POWDER (DSM)

Indicative unit price:	USD 1500/MT
Stowage factor:	700 kg/m ³
UNCCS Code:	229115

Type: Spray dried skimmed milk powder, vitamin enriched

General description: Non fat dry milk, A.D.M.I. extra grade, fortified with A and D3 vitamins, fit for human consumption and manufactured not more than six (6) months before shipment.

Quality specifications: According to official government standards of country of origin.

Typical quality specifications:

Moisture content:	4 % maximum
Fat content:	1.25% maximum
Vitamin A:	5,000 - 10,000 I.U./100g
Vitamin D3:	500 - 1,000 I.U./100g
Total acid (Lactic acid):	1,500 mg / 100g
Additives:	None
Neutralizers:	None
Phosphate:	Negative i.e. not more than 4 micrograms of phenol per gram of reconstituted milk
Solubility index:	Maximum 1.25 ml
Burnt particles:	Max 15.0 mg i.e. disc B minimum
Micro-organism content:	50,000/g maximum
Coliform test:	Negative in 0.1 g
Taste and smell:	Clean
Appearance:	White or slightly yellowish colour, free from impurities or coloured particles, caking or lumps.
Absence of pathogenic/toxic bacteria and/or salmonella and/or mouse disease	

Nuclear radiation: To meet the values specified in the area of consumption. If these limits are not defined the content of Caesium (Cs134 & Cs137) must be less than 50 bq/kg and Strontium 90 must be less than 1 bq/kg

Packaging: In 1 or 25 kg bags of 4 ply paper with polyethylene inner liner which are placed on pallets and stretch/shrinkwrapped

Storage life: 24 months

Nutritional values per 100g:

Energy:	150 kcal
Protein:	35 g minimum
Carbohydrate:	51 g maximum

**DAIRY PRODUCTS:
DRIED WHOLE MILK POWDER (DWM)**

Indicative unit price:	USD 1550/MT
Stowage factor:	600 kg/m ³
UNCCS Code:	229125

Type: Spray dried whole milk powder

General description: Dried Whole Milk Powder, A.D.M.I. extra grade, fit for human consumption and manufactured not more than (1) month before shipment

Quality specification: According to official government standards of country of origin.

Typical quality specification:

Moisture content:	4 %	maximum
Fat content:	26.0%	maximum
Total acidity:	0.15 %	maximum in terms of lactic acid
Lactate content:	150 mg/ 100 g	maximum referred to dry matter
Additives:	None	
Neutralizer:	None	
Phosphate:	Negative i.e. not more than 4 micrograms of phenol per gram of reconstituted milk	
Solubility index:	Maximum 0.5 ml	
Burnt particles:	Max 15.0 mg i.e. disc B minimum	
Micro-organism content:	50,000/g maximum	
Coliform test:	Negative in 0.1 g	
Taste and smell:	Clean	
Appearance:	White or slightly yellowish colour, free from impurities or coloured particles, caking or lumps.	

Absence of pathogenic/toxic bacteria and/or salmonella

Nuclear radiation: To meet the values specified for the area of consumption. If these limits are not defined the value must not exceed 370 bq/kg (Cs¹³⁴ & Cs¹³⁷)

Packaging: In 1 or 25 kg bags of 4 ply paper with polyethylene inner liner, which are placed on pallets and stretch/shrinkwrapped

Storage life: 9 months

Nutritional values per 100g:

Energy:	500	kcal
Protein:	28	g
Carbohydrate:	38	g

DAIRY PRODUCTS: FETA CHEESE

Indicative unit price:	USD 3000/MT
Stowage factor:	800 kg/ m ³
UNCCS Code:	229532

Cheese type: Feta cheese

General description: The feta cheese must be made using solely cow milk

Quality specifications: According to official government standards of country of origin

Typical quality specifications:

Water content:	72 %	maximum on non-fat solids
Fat contents:	40 %	maximum of dry matter
pH value:	Variable	
Salt contents:	Variable	

Packaging: In 500 g boxes or in approx 15 kg steel drums with 500 g pieces

Shelf life: 12 - 18 month

Nutritional values per 100g:

Energy:	230	kcal
Protein:	13	g
Carbohydrates:	6	g

DAIRY PRODUCTS: MILK, ENRICHED, DRIED AND SKIMMED

Indicative unit price:	USD 3000/MT
Stowage factor:	700 kg/m ³
UNCCS Code:	229116

Type: Milk proteins or spray dried skimmed milk powder with added vegetable oil, carbohydrates, vitamins and minerals. Minerals and vitamins should be added before drying the final product

General description: Milk product for treatment of severe protein and energy malnutrition. This low iron milk is not suitable for long term feeding of well nourished children

Typical quality specifications:

Moisture content:	2.5 %	maximum
Energy:	520-550	kcal/100g
Protein:	10 to 12 %	total energy
Fat:	45% to 60%	total energy
Sodium:	290 mg/100g	maximum
Potassium:	1100 mg to 1400	mg/100g
Calcium:	300 mg to 600	mg/100g
Phosphorus:	300 mg to 600	mg/100g
Magnesium:	80 mg to 140	mg/100g
Iron:	0.2 mg/100g	maximum
Zinc:	11 mg to 14	mg/100g
Copper:	1.4 mg to 1.8	mg/100g
Selenium:	20 µg to 40	µg/100g
Iodine:	70 µg to 140	µg/100g
Vitamin A:	0.8 mg to 1.1	mg/100g
Vitamin D:	15 µg to 20	µg/100g
Vitamin E:	20 mg/100g	minimum
Vitamin K:	15 µg to 30	µg/100g
Vitamin B1:	0.5 mg/100g	minimum
Vitamin B2:	1.6 mg/100g	minimum
Vitamin C:	50 mg/100g	minimum
Vitamin B6:	0.6 mg/100g	minimum
Vitamin B12:	1.6 µg/100g	minimum
Folic acid:	200 µg/100g	minimum
Nicotinic acid:	5 mg/100g	minimum
Pantothenic acid:	3 mg/100g	minimum
Biotin:	60 µg/100g	minimum
n-6 fatty acid:	3% to 10%	of total energy
n-3 fatty acid:	0.3% to 2.5%	of total energy
Additives:	None expect specified mineral and vitamins	

Continued on next page...

DAIRY PRODUCTS: MILK, ENRICHED, DRIED AND SKIMMED

Indicative unit price:	USD 3000/MT
Stowage factor:	700 kg/m ³
UNCCS Code:	229116

...Continued from previous page

Neutralizer:	None
Phosphatases:	Negative i.e. not more than 4 micrograms of phenol per gram of reconstituted milk
Solubility index:	0.5 ml maximum
Burnt particles:	15.0 mg maximum i.e. disc B minimum
Micro-organism content:	10,000/g maximum
Coliform test:	Negative in 1 g
Clostridium perfringens:	Negative in 1 g
Yeast:	Maximum 10 in 1 g
Moulds:	Maximum 50 in 1 g
Pathogenic Staphylococci:	Negative in 1 g
Salmonella:	Negative in 125 g
Listeria:	Negative in 25 g

Added minerals should be added from water soluble salts

The balance between the equivalents of salts of weak acid (citrate, acetate, phosphate) and the sum of magnesium and calcium salts must be such that there is less than 0.1 mE/100g excess cation

Nuclear radiation: To meet the values valid in the area of consumption. If these limits are not defined the value must not exceed 370 bq/kg (Cs134 & Cs137)

Packaging:

- * In sachets of approximately 450 g which after addition of 2 litres of water give a therapeutic milk with an energy density above 100 kcal/100ml.
- * Labelling should give directions for use and mention in big letters that this milk is not suitable for long term feeding of well nourished children.
- * Packaging must be airtight and include an aluminium layer to protect against UV light and humidity.
- * Sachets should be filled with inert gas such as nitrogen or carbon dioxide. They should be packed in cardboard shocked resistant boxes of a maximum weight of 20kg

Storage life: 12 months after date of shipment

MEAT & FISH: CORNED BEEF

Indicative unit price: USD 2250/MT
Stowage factor: 470 kg/m³
UNCCS Code: 211361

Type: Corned beef (EEC product code 16.02.50.31.1.25)

General description: The corned beef must not contain bones, ligaments, gristle, hair or any foreign substances or additives, particularly fattening agents other than tendon collagen. Moreover, it must not be finely minced and must be free of disagreeable odours and tastes.

Quality specifications: According to official government standards of country of origin.

Typical quality specification:

Moisture:	60 %	maximum
Protein:	21%	minimum
The proportion of collagenous protein in relation to total protein content :		
	30 %	maximum
Fat:	15.5 %	maximum
Salt:	2%	maximum; (50 ppm of maximum total nitrate content expressed as sodium nitrate)
Sugar:	1 %	maximum
Ash:	3.5 %	maximum

Packaging: In cans of approx 500 g. Each can includes a built-in opener. The production date and the expiry date shall be printed on each can

Shelf life: 2 - 3 years

Energy: 280 kcal/100g

MEAT & FISH: CANNED MEAT

Indicative unit price:	USD 2100/MT
Stowage factor:	470 kg/m ³
UNCCS Code:	211313

Type: Canned meat - meat cooked in its own juice

General description: The meat must not contain bones, ligaments, gristle, hair or any foreign substances or additives, particularly fattening agents other than tendon collagen from meat. It must be free of disagreeable odours and tastes.

Quality specifications: According to official government standards of country of origin.

Typical quality specification:

Meat contents:	90 %	minimum
Fat content:	30 %	maximum
Protein:	13.5%	minimum
The proportion of collagenous protein in relation to total protein content :		
	35 %	maximum
Salt content:	2%	maximum
Sodium nitrate:	0.01%	maximum
Sodium phosphates:	0.5 %	maximum
Sugar content:	1 %	maximum
Ash content:	2.5 %	maximum

Packaging: In cans of approx 500 g. Each can includes a built-in opener. The production date and the expiry date shall be printed on each can

Storage life: 2 - 3 years

Energy: 280 kcal/100 g

MEAT & FISH: CANNED FISH

Indicative unit price: USD 2300 /MT
Stowage factor: 520 kg/m³
UNCCS Code: 212410

Fish type:

- * Mackerel
- * Sardines
- * Herrings

General description:

- * Canned Mackerel in vegetable oil (EEC product code no. 16.04.15.1.00)
- * Canned Sardines in vegetable oil
- * Canned Herring in vegetable oil

Quality specifications: According to official standards of country of origin

Typical quality specification:

Moisture: 70 % maximum
Contents of fish: 70 - 75 % of the declared contents
Contents of oil: 10 - 15 % of the declared contents
Fishwater: No water may be added to this product
Contents of salt: 1 - 2 % in fish flesh

Packaging: In cans of approx 125 - 400 g. Each can include a built-in opener. The production date and the expiry date shall be printed on each can

Shelf life: 3 years

Nutritional values:

Energy:	285	kcal/100g
Protein:	24 %	minimum
Fat:	21 %	maximum

MISCELLANEOUS: BISCUITS

Indicative unit price: USD 1100/MT
Stowage factor: 3 m³/MT
UNCCS Code: 234300

Type: Biscuits.
General description: Biscuits for food aid
Quality specification: According to official standards of country of origin

Typical quality specifications:

Minimum nutritional composition per 100 grams:

Energy:	470	kcal
Protein:	10	g
Carbohydrates:	70	g
Fat:	10	g
Calcium:	600	mg
Magnesium:	30	mg
Iron:	15	mg
Phosphorous:	100	mg
Iodine:	110	microgram
Folic acid:	5	microgram
Vitamin B1:	60	µg
Vitamin B2:	30	µg
Vitamin B6:	0.1	mg
Niacin:	0.8	mg
Vitamin A:	500	I.U.

Design: Preferably rectangular shape

Packaging:

- * Approx 100 g per package
- * Packed in heavy duty export cartons
- * Up to 15 kg per carton

Shelf life: 3 year

MISCELLANEOUS: HIGH PROTEIN BISCUITS

Indicative unit price: USD 1300/MT
Stowage factor: 1.5 m³/MT
UNCCS Code: 239972

Type: High energy biscuits

General description: High energy biscuits, especially developed for emergency supply.

Quality specification: According to official standards of country of origin

Typical quality specifications:

Minimum nutritional composition per 100 grams:

Energy:	450	kcal	
Protein:	15	g	maximum
Carbohydrates:	56	g	
Fat:	21	g	
Calcium:	250	mg	
Magnesium:	30	mg	
Iron:	15	mg	
Phosphorous:	170	mg	
Iodine:	30	microgram	
Folic acid:	5	microgram	
Vitamin B1:	1.2	mg	
Vitamin B2:	1.3	mg	
Vitamin B6:	1.5	mg	
Niacin:	12	mg	
Vitamin A:	1500	I.U.	
Vitamin D:	90	I.U.	
Vitamin E:	5.0	mg	

Design: Preferably rectangular shape

Packaging:

- * Approx 100 g per package
- * Packed in heavy duty export cartons
- * 10 kg per carton

Shelf life: 3 year

MISCELLANEOUS: WHITE SUGAR

Indicative unit price: USD 380/MT
Stowage factor: 820 kg/m³
UNCCS Code: 235330

Type: White sugar

General description: White crystal sugar according to EEC specifications, category 2. Fit for human consumption, sound, dry in crystals of uniform medium grain size and free running.

Quality specification: According to official government standards of country of origin

Typical quality specifications:

Polarization: Minimum 99.7 degrees
Humidity/moisture: Maximum 0.06 %
Invert sugar: Approx. 0.04 %
Ash: Maximum 0.027 %
(Not more than 15 points¹)
Colour: Not more than 9 points
Colour in solution: Not more than 6 points
Maximum 45 units (ICUMSA)
Points in total: Maximum 22 points

Packaging: In 50 kg jute bags lined inside with polyethylene, stitched at mouth or in 1 kg bags

1

1 point equals:

- 1) 0.0018 % ash
- 2) 0.5 units of colour type units
- 3) 7.5 attenuation index for colour in solution at 420 NM (ICUMSA)

**MISCELLANEOUS:
TEA**

Indicative unit price:	USD 2400/MT
Stowage factor:	300 kg/m ³
UNCCS Code:	239131

Black tea: Dried and sound processed leaves, buds and tender stalks

Composition:	Water Extract:	33 %	minimum
	Total Ash:	8 %	maximum
	Ratio of soluble of total Ash:	45 %	minimum
	Ash soluble in acid:	0.8 %	maximum
	Crude fibre:	15 %	maximum
	Caffeine:	2.5 %	minimum
	Tannin:	10 %	minimum

Packaging: In 50 kg tea chest lined with aluminium

Shelf life: 6 months

**MISCELLANEOUS:
IODIZED SALT**

Indicative unit price: USD 180/MT
Stowage factor: 800 kg/m³
UNCCS Code: 357811

Type: Iodized salt

General description: Edible iodized salt, fit for human consumption

Quality specification: According to official government standards of country of origin

Typical quality specification:

Moisture content: 1.70 % maximum
(dried at 140°C)
Sodium chloride as NaCl: 99.16 % (on dry basis)
Alkalinity as Na₂CO₃: 0.07 % maximum (on dry basis)
Iodine as KIO₃: 15 ppm minimum (on dry basis)
50 ppm maximum (on dry basis)
Acid insoluble matter: 0.02 % maximum (on dry basis)
Barium (spot test): No trace
Colour: The salt shall be white and 10 g of salt in 100 ml of water shall give a colourless solution having neutral reaction

Packaging:

- * Salt to be hygienically prepared and packed for human consumption
- * Polypropylene bags of 1 or 50kg

**MISCELLANEOUS:
YEAST**

Indicative unit price:	USD 300/MT
Stowage factor:	450 kg/m ³
UNCCS Code:	239964

Type: Dried instant yeast

General description: Dried instant yeast, fit for human consumption

Quality specification: According to official government standards of country of origin

**Typical quality
specification:**

Dry matter:	95 %
Crude protein:	51 % on dry matter
Total carbohydrate calculated as % dextrose on dry matter:	38 %
Nitrogen:	8.2 % on dry matter
Crudes fat:	6 %
Ash:	6 %
Rehydrated agent:	1.5 %
Chlorides as NaCl:	0.5 %

Packaging:

- * Salt to be hygienically prepared and packed for human consumption
- * Polypropylene bags of 50 or 100kg

MISCELLANEOUS: FOOD BASKET

Indicative unit price: USD 600 /MT
Stowage factor: 20 kg/packs
UNCCS Code: 239975

Type: Food parcel of family size to meet the basic nutritional needs

Contents of kit:	<u>Product</u>	<u>UNCCS Code</u>	<u>Packaging size</u>
	Wheat flour	231110	6 x 1 kg
	Rice	011400	3 x 1 kg
	Pasta	237100	4 x 500 g
	Dried red beans	012210	3 x 1 kg
	Rapeseed oil	216561	2 x 1 litre
	Sugar	235330	2 x 1 kg
	Corned beef	211362	6 x 340 g

Quality specifications: Each of the above products should conform to quality specifications provided under the corresponding technical bulletin in this catalogue.

Packaging: Packing size for each product must meet the specifications provided earlier. The parcel must be packed in a heavy duty carton.

Note: *Food parcels delivered from WFP are always 20 kg net and contain the listed types of products. Other items like DSM or sugar is delivered beside and "normally" in 25 kg bags. In addition to the food parcel some of the items are:*

- * *Meat*
- * *Milk powder*
- * *Feta cheese (depending on the place of the disaster)*

PACKAGING AND STORAGE: FUMIGATION SHEET

Indicative unit price: USD 3.5 /m²
Stowage factor: 50 kg/sheet
UNCCS Code: 485252

- Type:** Fumigation sheeting, water and gas proof
- Size:** Approx 15 x 15 m
- Texture:**
- * Small textile tape of HDPE with 14 x 17 thread/inch, 100 g/m²
 - * One side covered with LDPE 30 g/m², 3 % UV-stabilised
 - * Other side covered with LDPE 40 g/m² and a 5 layer sandwich foil 60 g/m² for gas tightness
 - * Stable to light
- Weight:** Minimum 230 g/m²
- Tear strength:**
- Warp:** Approx. 90 kg
Weft: Approx. 92 kg
- Resistance:** Temperature resistant from -30°C to +80°C
- Packaging:** Each sheet packed in a strong bag of woven PE
- Accessories:**
- * Adhesive tape
 - * Pieces of sheet
 - * Special glue to seal and repair

**PACKAGING AND STORAGE:
FUMIGANTS**

ALUMINIUM PHOSPHIDE

Indicative unit price: USD 20/kg
UNCCS Code: 345837

Area of use: For fumigation of cereals and pulses
Contents: Aluminium Phosphide in tablets of approx 5 g
Packaging: Packed in resealable tins or flasks of 1 kg

MAGNESIUM PHOSPHIDE

Indicative unit price: USD 25/kg
UNCCS Code: 345921

Area of use: For fumigation of cereals and pulses
Contents: Magnesium Phosphide in tablets of approx 5 g
Packaging: Packed in resealable tins or flasks of 1 kg

**PACKAGING AND STORAGE:
FUMIGANTS**

METHYL BROMIDE

Indicative unit price: USD 40/cylinder
UNCCS Code: 342423

Area of use: For fumigation of cereals and pulses

Contents: Methyl bromide

Packaging: In 25 litre gas cylinder

PACKAGING AND STORAGE: FUMIGATION KIT

Indicative unit price: See below and the next two pages
Shipping weight: 5 kg
Shipping volume: 0.3 m³
UNCCS Code: 485251

Type: Equipment used during fumigation of food products

GAS DETECTOR:

UNCCS Code: 482627
Indicative unit price: USD 200
Type: Detector with detector tubes for Phosphine or methyl bromide
Detecting range : 0.01 - 10,000 ppm minimum
Features:

- * Rechargeable batteries
- * Battery charger

GAS MASK:

UNCCS Code: 369739
Indicative unit price: USD 170
Type: Full-face mask with chin mounted cannister furnished
Filters:

- * Approved canister for phosphine
- * Approved canister for methyl bromide

Features:

- * High-impact plastic face piece
- * Plastic carrying case

HALIDE DETECTOR LAMP:

UNCCS Code: 482620
Indicative unit price: USD 100
Type: Lamp to check for methyl bromide leakage

OVERALLS:

UNCCS Code: 282313
Indicative unit price: USD 50
Area of use: Protective overalls for complete body protection
Material: Dark blue cotton

MEASURING TAPE:

UNCCS Code: 482351
Indicative unit price: USD 5
Material:

- * Tape measure of steel

Features:

- * Spring rewind
- * 2m/6feet long
- * Calibrated in cm/inches

Note: Detector and detector tubes must be from the same manufacturer

PROCESSING EQUIPMENT: HAMMER MILLS

Indicative unit price: USD 2500
Shipping weight: 550 kg
Shipping volume: 1.5 m³
UNCCS Code: 441852

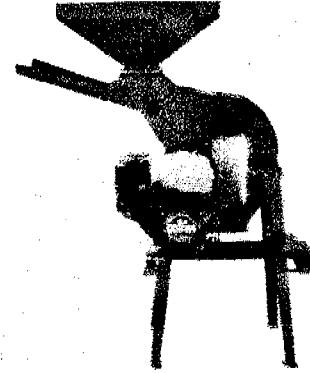

Type: Hammer mill of rugged construction, milling grain for human consumption

Area of use: Suitable for maize, wheat, sorghum and other cereals

Capacity: Approx 80 kg/h of wheat flour of bread quality using screen size 0.7 mm

Screen: Size of masks: From 0.7 to 1.5 mm

Drive: Diesel driven with hand start unit, approx 7 hp

Material: Milling house of heavy steel plates, painted steel frame

Accessories:

- * Spare parts for 2 years of operation
- * Usage and maintenance manual

PROCESSING EQUIPMENT: HAND MILLS

Indicative unit price: USD 300
Shipping weight: 25 kg
Shipping volume: 0.05 m³
UNCCS Code: 441851

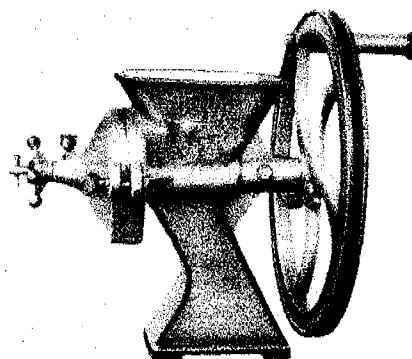

Type: Hand-operated grinding mill with grinding plates, milling grain for human consumption

Area of use: Suitable for maize, wheat, sorghum and other cereals

Capacity: Approx 10 kg/h of wheat flour of bread quality

Grinding plates: **Size:** Approx. 150 mm in diameter
Material: Steel or stone plates

Material: Milling house of rugged construction
Painted house

Accessories: * Spare parts for 2 years of operation
* Usage and maintenance manual

PACKAGING

JUTE BAGS

Indicative unit price: USD 0.45

UNCCS Code: 292264

Type: * Ghanny bags
* Hessian bags

Area of use: Sugar, coffee and pulses

General description: New jute bags of 50 kg net content, weighing minimum 500 gr and max 700 gr

POLYPROPYLENE BAGS

Indicative unit price: USD 0.25

UNCCS Code: 368191

Type: Polypropylene bags

Area of use: Sugar, salt, tea and malt,

General description: New, sound, woven polypropylene bags stitched at mouth and of up to 20/50 kgs content net with a minimum tare of 110/120 grams. Fabric to contain an inhibitor to resist ultra-violet absorption along with an anti-skid coating.

PACKAGING

JUTE/POLYPROPYLENE BAGS

Indicative unit price: USD 0.45
UNCCS Code: 368192

- Type:** Jute/polypropylene bags
- Area of use:** Grains, seeds, potatoes, sugar and flour
- General description:** Woven as cloth with jute in the porter and polypropylene yarns in the shot - 60 x 100 cm - minimum 335 gr weight, of 50 kg content each. All bags to be clean, dry, undamaged and firmly sewn.
- Quality specifications:** According to official government standard of country of origin

MULTIPLE PLY PAPER BAGS

Indicative unit price: USD 0.75
UNCCS Code: 321550

- Type:** Multiple ply paper bags
- Area of use:** Flour, sugar, grains and milk powder
- General description:** Waterproof multiple ply paper bags (4/5 ply) with a separate inner polythene bag of 8/100 to 12/100 thickness, fit for export of a net content of 25 kgs net.

PACKAGING

PLASTIC CONTAINERS

Indicative unit price:

UNCCS Code: 368968

Type: Plastic containers: * Plastic jars
* PET bottles

Area of use: For storage of oils and edible foods

General description: 4 or 5 litre plastic container, suitable for foodstuffs. They must have stoppers fitted with safety devices and be hermetically sealed weighing minimum 160 gr.

NOTES

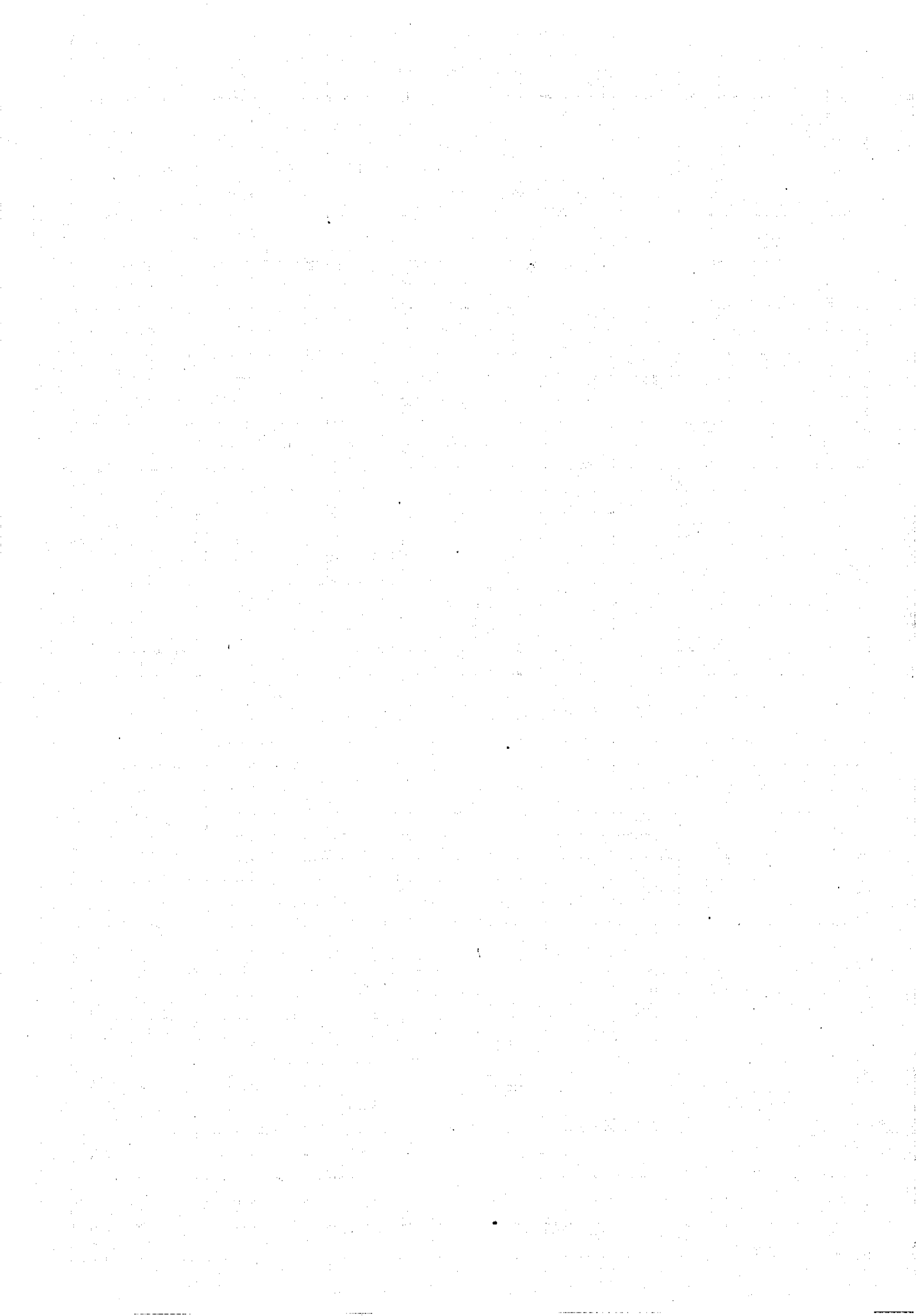

**CHAPTER 5 -
SANITATION AND HYGIENE ITEMS**

NEEDS AND RECOMMENDED RESPONSES

General

When disaster occurs, one of the major concerns is to save the lives of affected people, protect their health and help them return to a normal way of life. Since health protection can not be effective without the creation of a healthy environment, it is clear that one of the primary tasks in disaster relief is the immediate provision of adequate sanitary facilities. In order to achieve this task, excreta and other waste have to be properly disposed of, food and milk treated and general disinfection and disinfestation measures taken. This includes the rapid control of flies, mosquitoes and other insects, rats and other rodent pests. All sanitation measures must be closely coordinated with those for water supply and health services.

Recommendations

The priority activities are:

- * to prevent the spread of disease and promote the establishment of a safe environment.
- * to provide the means for reasonable personal hygiene

For support of these priority areas the necessary equipment and supplies for emergency sanitation work have been identified, and specifications for these have been compiled (see technical specifications).

In order to estimate the equipment needed and ensure efficient use of the sanitation items, the following data based on past field experience should be considered.

a) Refuse containers

- Metallic with tight lid
- Capacity: 50-100 litres, one for every 25-50 persons

b) Latrine accommodation

- 5-6 seats per 100 persons
- Distance from tents 30-50 m

c) Latrines

- Shallow trench latrine
 - Width: 30 cm or as narrow as it can be dug
 - Depth: 90 - 150 cm
 - Length: 3 - 3.5 meters
- Deep trench latrine
 - Width: 75 - 90 cm
 - Depth: 1.8-2.4 meters
 - Length: 3 - 3.5 meters
- Bore hole latrine
 - Diameter: 40 cm
 - Depth: 5 - 6 meters
 - 1 for every 20 persons

d) Refuse disposal

- Trench
 - Width: 1.5 meters
 - Depth: 2 meters
 - Length: 1 meter per 200 persons, so that trench is filled in one week
 - Time allowed for decomposition: 4 - 6 months

NEEDS AND RECOMMENDED RESPONSES

e) *Washing*

- Bench, double sided, 3 meters long, 2 for every 100 persons

f) *Food sanitation*

- Disinfecting the eating utensils
- Boiling water for 5 minutes
- Chlorine solution, 100mg/litre for 30 seconds

g) *Vector control*

- Insecticides
- Rodenticides

List of sanitation equipment and supplies

The tentative list of sanitation equipment and supplies required to satisfy the needs of 10000 people is provided below for guidance. In certain countries or localities additional items may be needed and others may be deemed necessary.

Waste water, sewage and excreta disposal

Quantity

* Mobile mud pump	2 - 5
* Sludge pump (non-clogging diaphragm type)	2 - 5
* Sludge tank trucks, capacity 7 m ³	5
* Augers (earth type)	5
* Pipes (plastic) and fittings	
* Cement and reinforcing bars	
* Cresol-base disinfection material	50 - 100 barrels
* Timber, boards, nails etc..	
* Repair kit	

Vector and vermin control

* Hand-pressure sprayers 20-30 litres	50
* Thermal foggers	20
* Insecticides	
* Rodenticides	1 - 2 kg
* Protective gear	
* Rodent traps	100
* Screen for fly control	10 rolls

Sanitarian's kit

1 set

* Comparator for chlorine residual and pH	* Mosquito larval dipper
* Thermometer, 0-100°C	* Magnifying glass
* Tape measure, 30 meters (cloth or metal)	* Felt pen
* Flashlight (pocket type)	* Safety Shoes
* Plums rod	* Mask
* Hand level	* Gloves
* Collection vials	

REFUSE COLLECTION AND DISPOSAL: COLLECTION BINS, PLASTIC

Indicative unit price: 10 ltr USD 2
50 ltr USD 10
100 ltr USD 20
Shipping weight: According to size
Shipping volume: 42 x 42 x 63 cms
(100 ltrs bin) 0.2 m³ for 10 bins
UNCCS Code: 369428

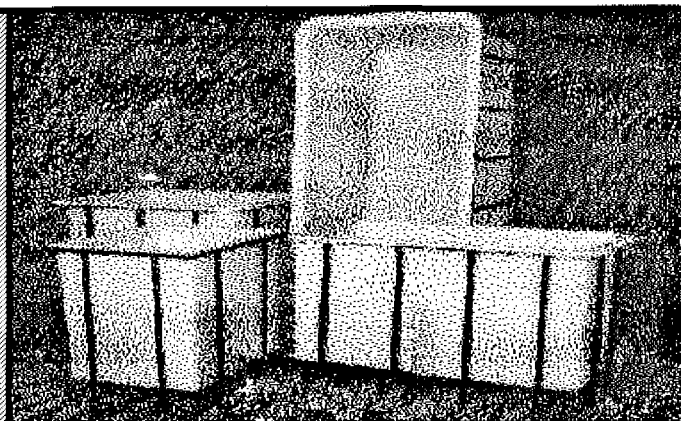

- Type:** Heavy duty plastic vats, multi-purpose, with lid built in
- Area of use:**
- * Wash basin: personal hygiene
 - * Wash basin: utensils, clothes
 - * Small scale transport and storage of food, water and waste
 - * Garbage can
- Size:** 10 litres, 50 litres, 100 litres
- Material:**
- * Heavy duty structural foam Polyethylene
 - * UV-resistant
 - * Acid-, alkali- and corrosion resistant
 - * Tasteless, odourless, and non-toxic
- Design:** Must be stackable and preferably of rectangular/square shape with lid built in
- Features:** For 100 litre bins: 2 built-in handles for ease of transportation

REFUSE COLLECTION AND DISPOSAL: BAGS, PLASTIC

Indicative unit price:	USD 25/roll
Shipping weight:	10 kg/roll
Shipping volume:	25 rolls/m ³
UNCCS Code:	368114

Type: Disposable black plastic bags

Area of use: For use as waste receptacle liners or alone for collection of clothes or waste materials

Bag size:

Capacity:	Approx. 100 litres
Thickness:	Approx. 0.05 mm
Length:	Approx. 100 cm

Material: Polyethylene

Packaging: Rolled in coils of approx. 100 pieces

REFUSE COLLECTION AND DISPOSAL: BODY BAGS

Indicative unit price:	USD 20/roll
Shipping weight:	4 kg/roll
Shipping volume:	30 rolls/m ³
UNCCS Code:	388310

Type: Non transparent body bag with full length zipper closure

Area of use: Used in mortuaries and morgues to store and preserve cadavers. Can be used to remove a contagious or contaminated body from institution

Bag size: **Length:** Approx. 230 cms
 Width: Approx. 90 cms

Material: Made of heavy vinyl with easy access

Packaging: Rolled in coils of 10 pieces

REFUSE COLLECTION AND DISPOSAL: WHEELBARROW

Indicative unit price: USD 50
Shipping weight: Approx. 40 kg
Shipping volume: 0.9 m³
UNCCS Code: 441710

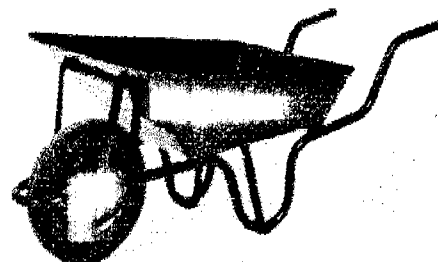

Type: Wheelbarrow of rugged construction for long life under demanding conditions

Capacity: Approx 130 litres

Body: Length: approx. 100 cms
Width: approx. 70 cms
Depth: approx. 50 cms

Wheel: Pneumatic wheel (approx) - 40 x 10 cms

Material: Painted or galvanized metal body welded to tubular frame
Plastic hand grips
Constructed from 18 gauge steel (approx.)

Design: The construction must be a knock down type for ease of transportation

EXCRETA COLLECTION AND DISPOSAL: SLUDGE PUMP

Indicative unit price: USD 1000
Shipping weight: Approx. 90 kg
Shipping volume: Approx. 0.5 m³
UNCCS Code: 432296

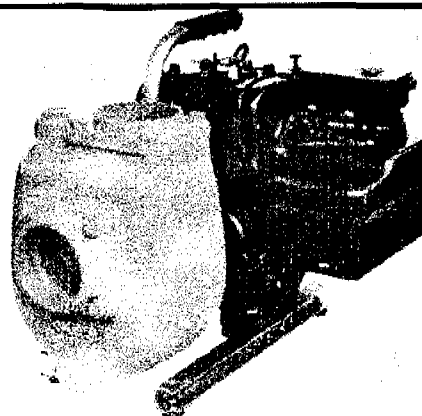

- Type:** Diesel driven selfpriming centrifugal pump
- Area of use:** Used for handling fluids with solid particle contents
- Head:** 20 meters
- Discharge:** Min. 50 m³/h
- Life span:** Minimum 5 years
- Suction lift:** Approx. 7 meters
- Engine:**
- * 4 stroke diesel engine, approx. 15 hp, air cooled
 - * Mechanical governor
- Speed:** 2500 - 3000 rpm
- Connections:**
- Suction Ø: 4 inches
 Discharge Ø: 4 inches
- Materials:** Corrosion resistant cast iron and stainless steel
- Features:**
- * Able to run dry
 - * Quick self-priming
 - * Abrasion resistant impeller
 - * Externally lubricated mechanical seal
 - * Pump/driver, coupled unit
- Accessories:**
- * Installation, operation and maintenance manuals
 - * Tool kit for repairs and maintenance
 - * Spare parts for 2 years
 - * Motor starting device, manual
 - * Min. 25 m flexible suction hose
 - * Min. 50 m flexible discharge hose

EXCRETA COLLECTION AND DISPOSAL: DIGGING TOOL KIT

Indicative unit price: USD 46
Shipping weight: 20 kg
Shipping volume: 0.1 m3
UNCCS Code: 429250

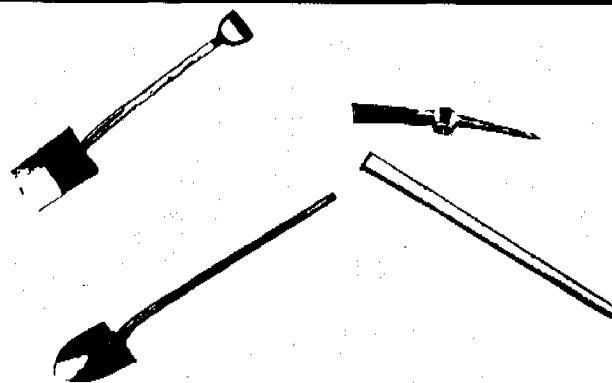

Type: Hand operated tools for digging wells etc..

- SPADE:**
- UNCCS Code:** 429211
Indicative unit price: USD 10
Type: Square point with D-handle
Blade:
 - * High quality carbon steel blade
 - * Sharp cutting edge
 - * Blade approx. 300 x 180 mm**Handle:**
 - * Fitted with ash handle
 - * Approx. length: 85 cms
- SHOVEL:**
- UNCCS Code:** 429215
Indicative unit price: USD 10
Type: Round point with long straight ash handle
Blade:
 - * High quality carbon steel blade
 - * Approx. blade length: 320 mm
 - * Approx. blade width: 260 mm**Length:** Approx. 160 cms
- PICK AXE:**
- UNCCS Code:** 429223
Indicative unit price: USD 12
Type: Point/chisel type pick, head forged
Head:
 - * High quality carbon steel with oval eye
 - * Head length approx 550 mm
 - * Chisel width approx 50 mm
 - * Head weight approx 2.0 kg**Handle:**
 - * Separate prefitted ash handle
 - * Handle length approx 900 mm

EXCRETA COLLECTION AND DISPOSAL

SQUATTING PLATES

Indicative unit price:	USD 2/unit
Shipping weight:	4 kg/units
Shipping volume:	1.2 x 0.8 x 1.5 m/pallet
UNCCS Code:	369392

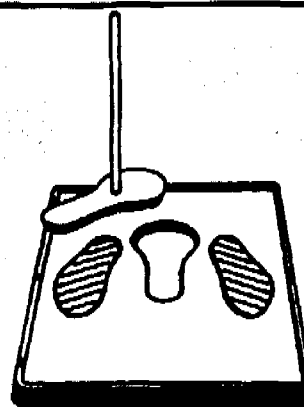

Type:	Pit latrine squatting plate
Area of use:	Used for the disposal of excreta; to be fitted over hand dug pit
Material:	Thermoplastic (Polypropylene)
Dimensions:	Approx. 800 x 600 x 60 mm (50 units per pallet)
Weight:	Approx. 3.5 kg each
Features:	<ul style="list-style-type: none">* Resistant to commonly used chemicals, urine and faeces* Easy to clean* Removable cover with handle* Feet placement areas designed to prevent slipping

WIRE, GALVANIZED

Indicative unit price:	USD 25/coil
Shipping weight:	5 kg/coil
Shipping volume:	0.1 m ³ /coil
UNCCS Code:	429653

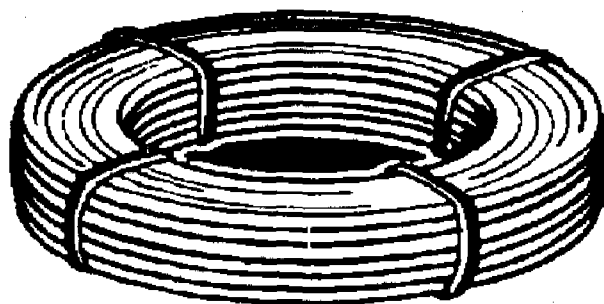

Type:	General purpose utility wire
Material:	Galvanized mild steel wire
Dimension:	Diameter: 1.5 to 2 mm Weight: Approx. 1 kg/12 m
Coil weight:	Approx. 5 kg

EXCRETA COLLECTION AND DISPOSAL

CEMENT

Indicative unit price:	USD 7
Shipping weight:	50 kg/bag 40 bags per pallet)
Shipping volume:	0.05 m ³ /bag
UNCCS Code:	374400

Type:	Portland cement
Area of use:	For making squatting slabs and other on-site reinforced concrete works
Quality class:	400 to BS 12 or equivalent
Packaging:	<ul style="list-style-type: none">* 50 kg / pack* Plastic or six-ply kraft paper bags, with one bitumen or plastic layer* Stitched both sides

STEEL REINFORCING RODS

Indicative unit price:	USD 400/MT
Shipping weight:	1000 kg
Shipping volume:	Approx. 0.5 m ³ per bundle (1 MT)
UNCCS Code:	412460

Type:	Bars of mild steel (plain or ribbed) for easy bending
Area of use:	For reinforcement of concrete
Dimensions:	Diameter: 6 mm Length: 6 mtrs
Packing:	Supplied in bundles of 1 to 2 MT, securely strapped with binding wire

EXCRETA COLLECTION AND DISPOSAL: HAND TOOLS, CARPENTRY

Indicative unit price: USD 150
UNCCS Code: 429465

Contents of carpenter's kit:

Hand drill:	Double-pinion, 1/4" capacity
Twist drill bit:	HSS: 1/16" to 1/4", set of 13
Hand saw:	Cross-cut 500 mm 20 points/50 mm
Coping saw:	Throat depth 120 mm, blade 165 mm
Blades:	For coping-saw 160 mm set of 12
Hand brace:	8-pt open ratchet 250 mm sweep
Clamp:	76 mm opening
Clamp:	100 mm opening
File:	Half-round machinists' bastard cut 250 mm
Handle:	File handle 100 mm length
Claw hammer:	Head of 450 g
Paint brush:	35 mm wide
Pliers:	Combination type, 200 mm long and 30 mm capacity
Rule:	300 mm/12", graded in mm and inches steel
Screwdriver:	250 mm x 9.5 mm
Square:	Carpenter's try/mitre 200 x 200 mm
Vice:	Vice screw jaw for woodworking, continuous, width 175 mm
Glue:	Liquid waterproof, 480 ml
Nails:	Roofing 25 mm long, wire 2.5 mm, non-toxic, 1 kg
Nails:	Woodworking flat-head assorted sizes, 1 kg
Sandpaper:	Assorted grains, pack of 12 sheets
Wood screws:	19 mm # 4 pack of 200 19 mm # 6 pack of 200 32 mm # 8 pack of 200 38 mm # 10 pack of 200

PERSONAL HYGIENE

SOAP, TOILET

Indicative unit price:	USD 510/MT
Shipping weight:	Approx. 750 kg/pallet
Shipping volume:	80 x 120 x 25 cms/pallet
UNCCS Code:	362211

Type:	Soap in bars															
Weight:	Approx. 200 g/bar															
Packaging:	30 cartons per pallet, approx. 120 soaps (200 g each) per carton															
Properties:	<table><tr><td>Fatty acid:</td><td>70%</td><td>min.</td></tr><tr><td>Moisture:</td><td>20%</td><td>max.</td></tr><tr><td>NaOH content:</td><td>0.2%</td><td>max.</td></tr><tr><td>NaCl content:</td><td>0.5%</td><td>max.</td></tr><tr><td colspan="3">No contents of mercury</td></tr></table>	Fatty acid:	70%	min.	Moisture:	20%	max.	NaOH content:	0.2%	max.	NaCl content:	0.5%	max.	No contents of mercury		
Fatty acid:	70%	min.														
Moisture:	20%	max.														
NaOH content:	0.2%	max.														
NaCl content:	0.5%	max.														
No contents of mercury																

TOILET PAPER

Indicative unit price:	USD 25/100 rolls
Shipping weight:	Approx. 180 kg/pallet
Shipping volume:	Approx. 2.1 m ³ /pallet
UNCCS Code:	321311

Type:	From 100% recycled paper, double sheeted
Size:	Approx 300 sheets/roll
Width:	Approx. 100 mm
Weight:	Approx. 2 x 20 g/m ²
Packaging:	<ul style="list-style-type: none">* 10 rolls/pack* Approx. 1100 rolls/pallet

PERSONAL HYGIENE

SHAMPOO

Indicative unit price:	USD 0.5/liter
Shipping weight:	approx. 760 kg/pallet
Shipping volume:	120 x 80 x 190 cms/pallet
UNCCS Code:	362323

Type:	General use shampoo
Packaging:	<ul style="list-style-type: none">* Supplied in unbreakable container* Approx. 12 x 1ltr bottles per carton* Approx. 60 carton per pallet
Properties:	<ul style="list-style-type: none">* Easy-lathering shampoo formulated for normal hair* To clean hair and scalp

SHAMPOO, MEDICATED

Indicative unit price:	USD 0.7/liter
Shipping weight:	Approx. 1000kg/pallet
Shipping volume:	Approx. 100 x 120 x 150 cms/pallet
UNCCS Code:	362328

Type:	Medicated shampoo
Area of use:	For the prevention and treatment of scabies/fleas
Packaging:	<ul style="list-style-type: none">* Supplied in unbreakable container* Approx. 52 x 250 ml bottles per carton* 36 cartons per pallet

PERSONAL HYGIENE

HYGIENE KIT

Indicative unit price: USD 20/kit

UNCCS Code: 362350

Contents of hygienic kit:

Washing powder:	2 bags of 1 kg/bag
Toothpaste:	4 tubes of 75 ml/tube
Toothbrush:	10 pieces (in cellophane)
Toilet paper:	3 packs of 4 rolls of 250 sheets (eco natural)
Sanitary towel:	4 bags of 20/bag
Razor:	1 pack of 5/pack (safety, disposable)
Soap:	6 pieces of 100g/bar (individually packed)
Shampoo:	2 bottles of 500 ml/bottle
Comb:	1 piece (plastic)

WASHING AND DISINFECTION

WASH BASINS, PLASTIC

Indicative unit price: USD 4
Shipping weight: Approx. 1.5 kg
Shipping volume: Approx. 0.04 m³
UNCCS Code: 369312

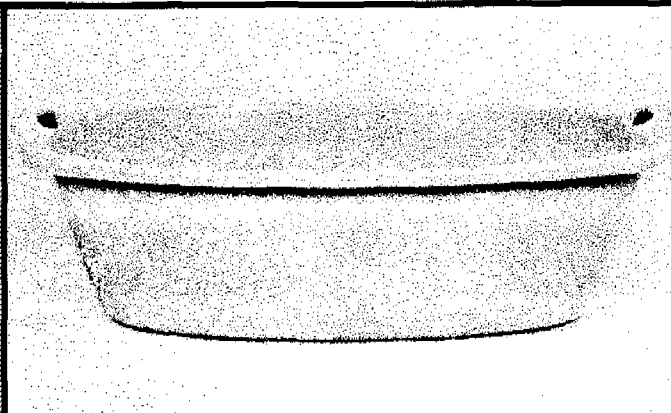

Type:

- * Heavy duty plastic basin, multi-purpose
- * Rectangular shape

Material: High density polyethylene (HDPE)

Capacity: Approx. 40 litres

Thickness: Approx. 0.5 mm

Dimensions: Approx. height: 30 cm

Features: 2 built-in handles, 1 at each end

WASH BASINS, METAL

Indicative unit price: USD 5
Shipping weight: Approx. 2.5 kg
Shipping volume: Approx. 0.03 m³
UNCCS Code: 429113



Type:

- * Heavy duty steel basin, multi-purpose
- * Round shape

Material: Galvanized steel, rust-proof

Capacity: Approx. 30 litres

Thickness: Approx. 0.5 mm

Dimensions:

- Approx. top diameter: 50 cm
- Approx. height: 25 cm

Features: 2 built-in handles, 1 at each end

WASHING AND DISINFECTION

LAUNDRY SOAP

Indicative unit price: USD 0.5/kg
Shipping weight: 12 kg/100 carton
Shipping volume: 14 x 42 x 28 cms
UNCCS Code: 362241

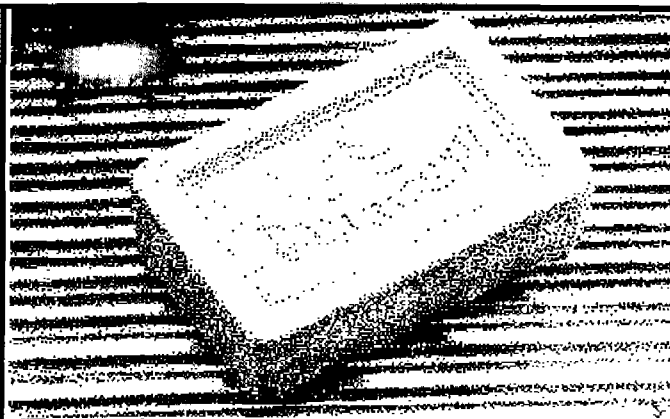

Type: Laundry soap
Area of use: For hand washing clothes
Packaging: 100 bars of 125 g, packed in a corrugated carton box
Features: Must not be harmful for the skin

WASHING TUBS, PLASTIC

Indicative unit price: USD 7
Shipping weight: Approx. 5 kg
Shipping volume: 0.1 m³
UNCCS Code: 369427

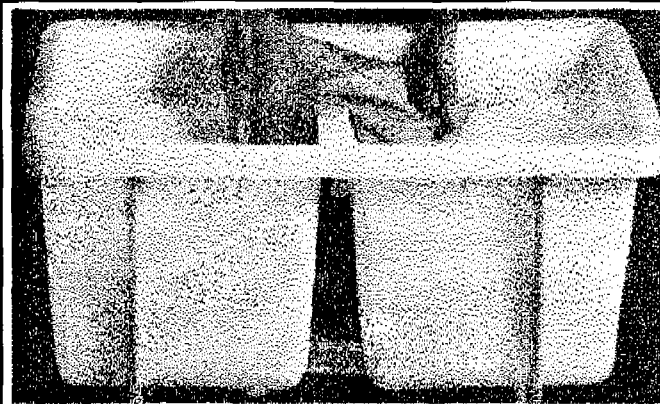

Type: Small plastic vessels for multipurpose washing
Design: Double vessel, each of a capacity of approx. 50 litres
Area of use:

- * Mainly for washing utensils and clothes
- * For indoor or outdoor use

Material: Polyethylene or polypropylene, UV-resistant, moulded in one piece
Features:

- * Durable construction
- * Good insulation ability
- * Draw-off valve

WASHING AND DISINFECTION

CALCIUM HYPOCHLORITE

Indicative unit price: USD 1.5/kg
UNCCS Code: 356451

- Type:** Chloride-releasing compound disinfectant
- Area of use:** Disinfection of surfaces, floors, objects, clothes and water treatment
- Packaging:** Concentrated solution in drums/cans or tablets in boxes, packed in strong export-worthy containers, in compliance with IATA regulations
- Properties:**
- * Contains approx. 70% active chlorine
 - * Wide range of bactericidal, fungicidal and virucidal activity
 - * Rapid action
 - * Low concentrations are non-toxic
 - * More stable in dry form, solutions decay rapidly with decreasing concentration
 - * Incompatible with cationic detergents

CHLORAMINE

Indicative unit price: USD 14/kg (tablet form)
UNCCS Code: 356493

- Type:** Chlorine-releasing compound disinfectant
- Area of use:** Disinfection of floors, surfaces and medical instruments
- Packaging:** Powder or tablets of 250 mg, 500 mg or 1 g, with a slight odour of chlorine, packed in strong export-worthy cartons.
- Properties:**
- * Contains approx. 25 % active chlorine
 - * Can be used as antiseptic
 - * Used for the disinfection of drinking water

VECTOR AND VERMIN CONTROL: INSECTICIDES

PROPOXUR

Indicative unit price: Approx. USD 20/liter (75% WPD)
UNCCS Code: 345834

- Area of use:**
- * For the control of mosquitoes, flies, cockroaches, bugs, ticks, fleas, etc.
 - * Suitable for the control of numerous household and public health pests.
- Formulation:**
- * Emulsifiable concentrate
 - * Wettable powder
 - * Hot fogging concentrate
 - * Cockroach bait
 - * Fly bait
 - * Dust
 - * Oil based spray
- Toxicity (1% dust):**
- | | | |
|-------------------|---------|------------|
| LD50, oral, rat | approx. | 100 mg/kg |
| LD50, dermal, rat | above | 4000 mg/kg |
- Packaging:** Varying depending on bait form. Typically 1 or 25 kg bags or 25, 50 or 200 litre fibre drums. Packed in tightly closed containers with detailed instructions of use and handling.
- Features:**
- * Propoxur is a **carbamate** insecticide with a broad spectrum of activity
 - * Contact and stomach poison action
 - * Rapid knockdown and long residual action

VECTOR AND VERMIN CONTROL: INSECTICIDES

MALATHION

Indicative unit price: Approx. USD 4/liter (50% WDP)
UNCCS Code: 345862

Area of use: Insecticide used in locust, vector and crop control and as house hold pest management and protection of stored grain. Also used as a ULV spray against mosquitoes and as a dust for flea control.

Formulation:

- * Emulsifiable concentrate
- * Wettable powder
- * Dust

Toxicity (approx.):

LD50, acute oral, rat	approx.	2000 mg/kg
LD50, dermal, rat	above	3000 mg/kg

Packaging:

Emuls. concentrate:

- * In 1 or 25 litre bottles
- * 200 litre drum.

Wettable powder:

- * 10, 25 or 50 kg bags

Each container labelled with information containing the content of the product as well as usage and storage instructions

Features:

- * Broad spectrum organophosphate insecticide with non bio-accumulating properties.
- * Low toxicity to mammals.

VECTOR AND VERMIN CONTROL: INSECTICIDES

FENITROTHION

Indicative unit price: Approx. USD 7/liter (50%
EC)
UNCCS Code: 345821

Area of use: Insecticide used in locust, vector and crop control and as household pest management and protection of stored grain. To be used with a sprayer or thermal fogger. Mainly used when there is resistance to Malathion.

Formulation:

- * Wettable powder
- * Emulsifiable concentrate

Toxicity (approx.):

LD50, acute oral, rat	700 mg/kg
LD50, dermal, rat	1100 mg/kg

Packaging:

Emuls. concentrate:	* 1 or 25 litre bottle
	* 200 litre drum
Wettable powder:	* 1 or 25 kg bags
	* 30 kg fibre drums

Each container labelled with information concerning the content of the product as well as usage and storage instructions

Features:

- * **Organophosphate** insecticide with fast knockdown and kill time.
- * Broad spectrum, effective against a wide range of flying and crawling insects.

VECTOR AND VERMIN CONTROL: INSECTICIDES

FENTHION

Indicative unit price: USD 15/litre (40% WP)
UNCCS Code: 345828

- Area of use:** Used mainly as a residual insecticide and larvicide for outdoor pest control.
- Formulation:**
- * Emulsifiable concentrate
 - * Wettable powder
 - * Dustable powder
 - * Hot fogging concentrate
 - * Granules.
- Toxicity:**
- | | |
|-------------------|---------------|
| LD50, oral, rat | 190-330 mg/kg |
| LD50, dermal, rat | 330-500 mg/kg |
- Packaging:** Depending on bait form, but typically:
- | | |
|-------------------------|-------------------------|
| * Emuls. concentrate: | * 1 or 25 litre bottles |
| | * 200 litre drums |
| * Wettable concentrate: | * 1 or 25 kg bags |
| | * 30 kg fibre drums |
- Features:**
- * **Organophosphate** insecticide, stable on alkaline surfaces
 - * Effective larvicide for treatment of ditches, ponds and swamp areas
 - * Compatible with other pesticides, except those of highly alkaline nature

VECTOR AND VERMIN CONTROL: INSECTICIDES

PERMETHRIN

Indicative unit price: USD 25/litre (50% EC)
UNCCS Code: 345886

- Area of use:**
- * Pest control, mosquito net impregnation
 - * Very efficient for mass and/or individual delousing
- Formulation:**
- * Wettable powder
 - * Emulsifiable concentrate
- Toxicity:**
- | | | |
|-----------------------|---------|------------|
| LD50, acute oral, rat | approx. | 5000 mg/kg |
| LD50, dermal, rat | approx. | 4000 mg/kg |
- Packaging:**
- Emuls. concentrate:**
- * 1 or 25 litre bottles
 - * 5, 25 and 200 litre drums
- Wettable powder:**
- * 1 or 25 kg bags
 - * 30 kg drums
- All packaging containing information on use and handling
- Features:**
- * Fast acting broad spectrum **synthetic pyrethroids** insecticide
 - * Multi purpose insecticide suitable for use as a thermal fog
 - * Contact and stomach action, with slight repellent action

VECTOR AND VERMIN CONTROL: RODENTICIDES

BROMADIOLONE

Indicative unit price: USD 12/kg (25%)

UNCCS Code: 345932

Area of use: For use against mice and rats, in and outdoors

Formulation: All-weather cakes or waxed blocks; Solution

Toxicity: LD50, acute oral, rat 1.1 mg/kg

Mode of action: Anticoagulant

Packaging:

- * 5 to 20 kg plastic pails
- * Approx. 0.5 kg waxed blocks
- * 25, 30 or 50 litre drums

Feature: Kills warfarin resistant rodents

COUMATESTRALYL

Indicative unit price:

UNCCS Code: 345934

Area of use: Rat control, in and outdoor use

Formulation:

- * Tracking powder
- * Bait concentrate
- * Solid bait (wax blocks)

Toxicity (approx): LD50, acute oral, rat approx. 20 mg/kg
LD50, dermal, rat above 4000 mg/kg

Mode of action: Anticoagulant

Packaging: Varying depending on bait form. Packed in tightly closed containers

Feature: Cumulative action, must be ingested in small amounts over several days

VECTOR AND VERMIN CONTROL: RODENTICIDES

WARFARIN

Indicative unit price: Approx. USD 5/kg
(0.05%)
UNCCS Code: 345938

Area of use: For use against mice and rats, in-and outdoor

Bait form: Meal bait packaged in place packs, Granules

Toxicity: LD50, acute oral, rat 15-320 mg/kg

Mode of action: Anticoagulant

Packaging:

- * Approx 10 kg bulk pails
- * Cartons of 50 to 100 packs
- * 25 - 30 kg drums
- * 1, 5 or 25 kg bags

Feature: Low hazard to humans

VECTOR AND VERMIN CONTROL: SPRAYERS

KNAPSACK TYPE, MANUAL

Indicative unit price: USD 70
Shipping weight: 5.5 kg
Shipping volume: 0.02 m³
UNCCS Code: 441611

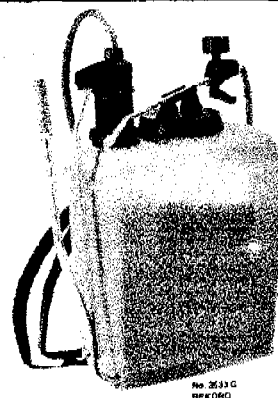

- Type:** Knapsack manual sprayer of rugged construction
- Area of use:** For application of all types of cleaning solutions, pesticides and agro-chemical formulas including herbicides, insecticides and fungicides. Designed for portability and easy operation
- Capacity:** 15 - 20 litres
- Pressure:** To withstand minimum 5 bar
- Material:**
- * Stainless steel or high density poly ethylene
 - * UV and chemical resistant.
- Pump:** Hand-operated pump for both left and right
- Hose:** Approx 0.5 meter of PP/Nitrile
- Spray nozzle:**
- * One single head nozzle
 - * Adjustable from straight stream to cone spray pattern
- Features:**
- * Safety valve built-in
 - * Adjustable carrying straps and backrest
 - * Large filling opening with strainer
- Accessories:** Set of spare joints

VECTOR AND VERMIN CONTROL: SPRAYERS

HANDHELD TYPE, MANUAL

Indicative unit price: USD 50
Shipping weight: 4 kg
Shipping volume: 0.04 m³
UNCCS Code: 441673



Type: Handheld manual sprayer

Area of use: Compressed air sprayer for application of chemical solutions and treatment of exposed surfaces

Fill capacity: Approx. 10 ltrs

Operating pressure: Approx. 3 bars

Tank Dimensions: **Diameter:** approx. 20 cms

Height: approx. 60 cms

Features:

- * Relief valve for safety
- * Packed in single seaworthy cardboard box
- * Made of high grade chemical compounds for protection against corrosion

VECTOR AND VERMIN CONTROL: SPRAYERS

FOG GENERATORS

Indicative unit price: USD 800
Shipping weight: 15 kg/unit
Shipping volume: 0.1 m³
UNCCS Code: 441660



- Type:** Thermal fogger for both water and oil based insecticides
- Area of use:** For fast, easy and effective dispensing of oil, water and petroleum based products and for large area insect control. To be used with appropriate protective clothing and breathing apparatus
- Engine:**
- * 4-cycles
 - * 5 hp
 - * Lead-free gasoline fueled
- Tank capacity:** Approx. 10 ltrs
- Dimensions:** Approx. 65 x 55 x 30 cms
- Features:**
- * Flameless
 - * Low maintenance

VECTOR AND VERMIN CONTROL: PROTECTIVE CLOTHES/ACCESSORIES KIT

Indicative unit price: USD 40/kit
UNCCS Code: 369728



Respirators: **UNCCS Code:** 369738
Indicative unit price: USD 20 / unit
Type: Medium size half mask respirator
Area of use: To provide protection when spraying pesticides. Also to be approved for organic vapors, dusts, fumes and mists.

Goggles **UNCCS Code:** 483143
Indicative price: USD 6 / unit
Type: Transparent protective goggles
Area of use: To protect eyes from dust and chemical splash
Features:

- Indirect vent system for air circulation
- Lightweight flexible vinyl

Rubber gloves: **UNCCS Code:** 366621
Indicative price: USD 2 / unit
Type: Chemical resistant gloves
Area of use: To protect hands when handling chemicals
Features:

- Nitril latex gloves resistant to animal fats
- Tear, puncture and abrasion resistant

Thickness: Approx. 0.4 mm

Protective coveralls: **UNCCS Code:** 369728
Indicative price: USD 7 / unit
Type: Full length disposable plastic protective gown
Area of use: For protection when handling insecticides
Features:

- Chemical resistant, cuff design to prevent leakage between glove and sleeve
- 100% non-woven polypropylene

Rubber boot covers **UNCCS Code:** 295321
Indicative price: USD 5 / unit
Type: Latex rubber boot covers
Area of use: For protection against hazardous chemicals
Features: Ribbed, textured soles for safe, dependable traction
Thickness: Approx. 0.7 mm

VECTOR AND VERMIN CONTROL: SANITARIAN'S KIT

Indicative unit price: USD 100/kit
UNCCS Code: 429257

Contents of sanitarian's kit

- Comparator:** For chlorine residual and pH, together with orthotolidine and pH indicator solutions
- Thermometer:** 0°C to 100°C, with protective casing
- Tape measure:** 30 meters, cloth or metal, graduated in m and cm
- Flashlight:** Pocket type, including batteries and spare bulbs
- Plumb rod:** Handle of wood, head of rubber/plastic
- Mask:** Regular dust mask
- Gloves:** Working gloves with finger and palm of leather and back of cotton
- Hand level:** With 1 horizontal and 1 vertical spirit level made of corrosion-resistant metal
- Collection vials:** Including standard measuring cup, 500 ml
- Mosquito larvae dipper**
- Chemical test kit:** Insecticide resistance test kit
- Magnifying glass:** Pocket size, 5x to 20x
- Felt-tip pen:** Ink marking pen
- Safety Shoes:**

VECTOR AND VERMIN CONTROL: FLY CONTROL

MOSQUITO SCREENS

Indicative unit price: USD 0.3/m²
Shipping weight: 5 kg/100 mtr roll
Shipping volume: 0.01 m³
UNCCS Code: 421230

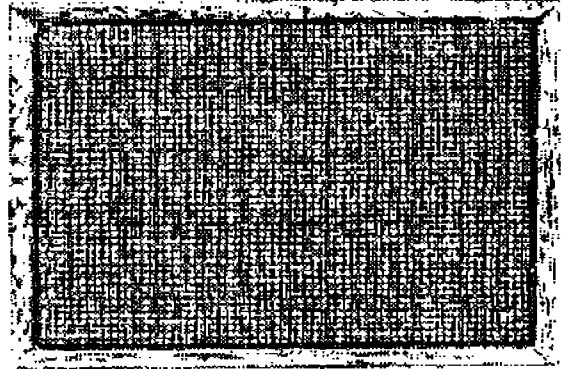

Type: Mosquito netting, to be placed on windows or doors for insect screening
Size: * Approx. 90 to 120 cms wide
 * 100 mtrs per roll
Packaging: 20 to 25 rolls per pallet
Material: Knitted polyester, plastic-coated or impregnated fiber-glass yarn
Properties: **Denier:** 75 or 100 (weight in grms of 9000 mtrs of thread)
Mesh: 156 (i.e. 12 x 13 holes per square inch) or 196 (14 x 14)

IMPREGNATED BEDNETS

Indicative unit price: USD 4 Family size
Shipping weight: 35 kg / 100 nets
Shipping volume: 60 x 60 x 65 cms
UNCCS Code: 421231

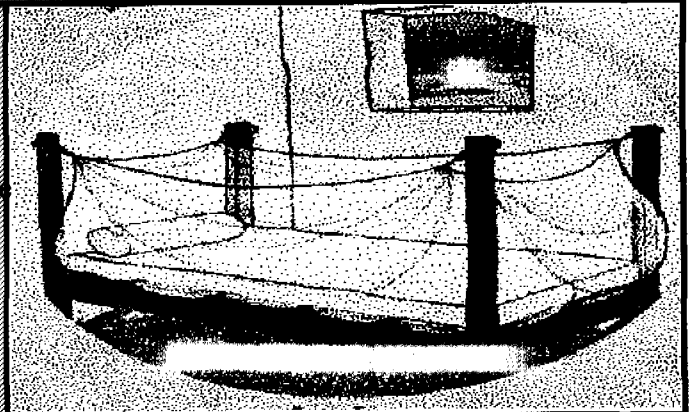

Type: Insecticide impregnated bednets
Size: **Single:** 70 x 180 x 150 cms (W x L x H)
Family: 130 x 180 x 150 cms
Packaging: Pressure baled into small packs, wrapped in water resistant PE bags
Material: Knitted polyester, plastic coated or impregnated fiber-glass yarn
Properties: **Denier:** 75 or 100 (weight in grms of 9000 mtrs of thread)
Mesh: 156 (i.e. 12 x 13 holes per square inch) or 196 (14 x 14)
Features:

- * Sheeting border (reinforcement at the bottom of the net for increased life-span)
- * Slit door for easy access into the net, with overlap of approx. 60 cms
- * Optional kit for impregnation including basin, bucket, gloves and instructions

DRAINAGE

DRAIN AND DRAIN FITTINGS

Indicative unit price: USD 25/3 mtr pipe
Shipping weight:
Shipping volume:
UNCCS Code: 367262

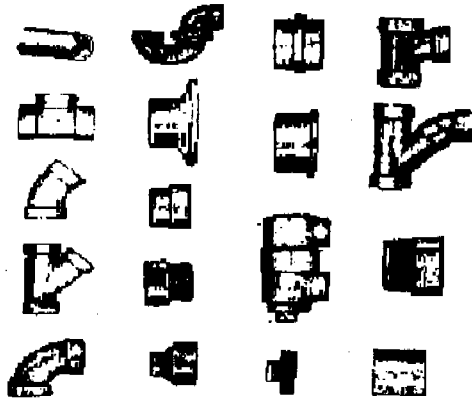

Type: Plastic water pipes, vent tees, bends, wyes, P-traps, cleanout plugs, closet flanges, adaptors (male and female), coupling.

Area of use: Water drainage

Size: **Length:** Delivered in length of approx. 3 mtrs
Diameter: 4" diameter

Material: Polyvinyl chloride (PVC)

Features:

- * Tough PVC plastic pipes and fittings to connect quickly and easily with solvent welds.
- * Highly resistant to impact, yet easy to work with and light weight.
- * Can be used with copper, cast iron and galvanized steel piping systems.

SOLVENT CEMENT FOR WATER PIPES

Indicative unit price: USD 10/liter
Shipping weight: Approx. 1 kg/liter
UNCCS Code: 412827

Type: Solvent cement for PVC pipes and fittings

Area of use: Cement for repairs of PVC plastic drainage pipes and fittings

Features: Furnished in cans with applicator caps

NOTES

**CHAPTER 6 -
MATERIALS HANDLING EQUIPMENT**

NEEDS AND RECOMMENDED RESPONSES

General

Materials handling is concerned with the moving, packing and storing of materials to meet specific objectives. The cheapest and most reliable power for this operation is the manpower available in field. However, to facilitate easy and safe handling of material, some equipment is required during the first phase of emergency relief operations. Depending on the application, they can be categorized as follows:

- **Lifting Equipment**
- **Transportation Equipment**
- **Storage Items**
- **Safety Items**

Surface transport vehicles such as heavy trucks and pickups are not covered in this publication, since they are already covered in the UN standards developed by IAPSO.

Lifting equipment

The first stage of handling is to load or unload the material. The lifting facility required for this can either be stand alone or built into the trolley or truck. This catalogue covers stand alone equipment only, which is broadly categorized as follows:

- * Chain pulley blocks
- * Winches
- * Jacks

a) Chain pulley blocks

A chain pulley block can be mounted in different ways depending on the purpose. In this catalogue, a gantry crane has been selected for its suitability in emergency operations. The hoist can be used with or without this crane depending on the specific purpose.

A lifting sling such as a polyester or polypropylene rope, steel chain or wire rope is required in addition to the chain pulley block. It is necessary to remember the capacity of the equipment when it is being used for this purpose. This document includes a lifting sling specifically designed for lifting and a type of rope which could be used for lifting lightweight goods.

b) Pulling winches

Pulling winches facilitate the lifting of goods with higher mechanical efficiency as they require less force and can be used for both lifting and pulling. They are ideally utilized for the removal of large rubble or other heavy loads when cleaning-up an area.

c) Jacks

Jacks are commonly used as a lift for trucks or vehicles when changing tyres or for maintenance. Usually, a jack is included with a vehicle at the time of purchase, however, there may be a requirement for additional supplies of this type of equipment.

Transportation Equipment

There are two types of trucks, manually operated and powered trucks which can be utilized for the transportation of material. The use of hand-operated trucks allows for the participation of several people

NEEDS AND RECOMMENDED RESPONSES

within the area of distribution. Different types of hand trucks are designed to suit various applications. When unloading heavy trucks, ships or airplanes, a powered truck is very useful. The different types of forklift trucks, should in particular be carefully chosen. It is advisable that care is taken to ensure some protection from the weather when equipment is to be used in tropical and sub-tropical locations, as otherwise, this can lead to maintenance problems. In addition to trucks, inflatable boats are included in the catalogue for transportation of supplies by sea. The types of equipment covered in this section are as follows:

Hand-operated trucks

- Hand trucks
- Platform and cage trucks
- Pallet trucks

Powered trucks

- Forklift trucks, light duty
- Forklift trucks, medium duty

Inflatable boats

a) Hand-operated trucks

Choosing a hand-operated truck for the movement of goods is essential in setting up a reliable system. This type of truck requires minimum maintenance and is therefore very useful in emergency situations where reliability of supplies is very important.

** Hand trucks*

There are many types of hand trucks designed for specific purposes. There are two varieties of hand trucks discussed in this catalogue; a simple type for the transportation of food parcels, food sacks or other sacks and a specialized type for the transportation of drums e.g. fuel drums.

** Platform and cage trucks*

A major portion of the activity in storage is the movement of goods from one location to another. This task can be simplified through the use of a platform truck or a cage truck, provided the goods are not loaded on pallets. If the goods are lightweight and are space-consuming, a cage truck is to be preferred. Then the goods can be stacked vertically without the risk of overturning.

** Pallet trucks*

Hand operated pallet trucks are very useful in the distribution of goods which are being freighted on pallets. Although the freight costs are higher, the use of a pallet truck, makes it possible to distribute goods more quickly and easily.

b) Powered trucks

The powered trucks included in this catalogue are differentiated according to use. There are basically three uses; loading and unloading of aeroplanes or other elevated sources, loading and unloading of heavy trucks, and loading and unloading of containers. The three uses require different criteria for selection of a forklift truck. In airports, the required lifting height is often 5 - 8 meters. This must be specified if ordering a truck for this purpose. In containers, the forklift truck must have a high freelif to be able to load and unload the goods. Otherwise the mast will exceed the height limit of the container, as soon as the fork is lifted. When loading and unloading a heavy truck, the high freelif is not important, but to standardize and to make the truck usable in all cases a forklift truck with high freelif should be selected.

NEEDS AND RECOMMENDED RESPONSES

Only forklift trucks for containers and for heavy trucks are included in this volume. When selecting the capacity of the truck it should be calculated to be 30% above what is expected to be the heaviest actual load.

The powered trucks included in this document are all diesel driven.

c) Inflatable boats

In the event of a flood or similar situation, some transportation must be provided by seaway. An inflatable boat is therefore included in this catalogue to meet this special need.

Storage items

In the storage of emergency items, various items are required to provide a simple and systematic means of stocking goods. The most commonly used items which are covered in this volume are as follows:

- * Storage racks
- * Cupboards
- * Scales
- * Ladders
- * Gravity roller conveyors
- * Warehouse tool kits
- * Repacking equipment

The above items are the basic necessities for the establishment of stockpiles.

a) Storage racks

To organize the warehouse, when handling smaller items e.g. medical equipment, a storage rack is very useful. This can be extended by separating the loose items into bins placed in the storage rack. The different types and sizes of bins will usually be chosen to fit the specified group of items. In an emergency situation, the usage of the bins and racks may change to fulfill the specific needs in the field. The storage racks contained in this catalogue are the type commonly used for these situations.

b) Pallets

When pallets are being freighted with goods to a distribution point or a warehouse, a special type of pallet can be used which acts as a storage rack. This pallet type, as listed in the catalogue, also provides significant protection of the goods during freighting.

c) Scales

Scales are an essential item used in the process of re-packing food products, in particular for their distribution in the field. The most commonly utilized scales are included in this catalogue.

d) Ladders and wheelbarrows

Ladders and wheelbarrows are very useful for handling different goods and for the maintenance of warehouse stockpile items.

e) Tool kits

The basic tools required for the opening or packing of goods are included in the "Materials handling tool kit". For the handling of food products however, a special kit is recommended which contains equipment for the opening and repairing of packages.

NEEDS AND RECOMMENDED RESPONSES

Safety Items

In order to establish a minimum safety level when working with trucks and hoists, a range of products are available. Lifejackets are also included to provide the required level of safety when transporting equipment by boat. The items included are as follows:

- * Working gloves
- * Safety helmets
- * Dust masks
- * Ear-muffs
- * Lifejackets

Dust masks and working gloves are also very useful during the clean-up after an earthquake.

LIFTING EQUIPMENT: CRANES & TROLLEYS

GANTRY CRANE

Indicative unit price: USD 1300
Shipping weight: 500 kg
Shipping volume: 1.2 m³
UNCCS Code: 435213

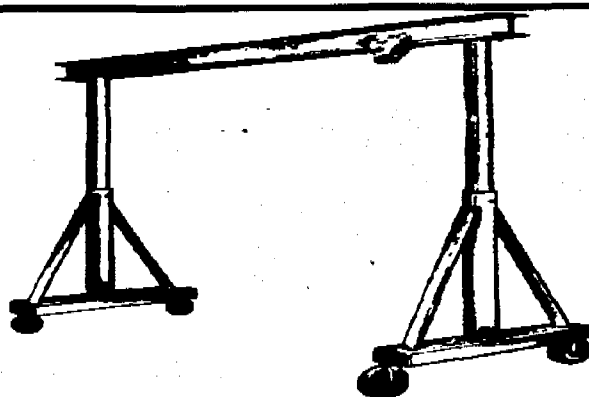

Type: Mobile gantry crane on four wheels. All steel construction.
Area of use: For lifting goods in loading areas, warehouses, machine shops
Lifting capacity: Minimum 2000 kg
Beam: Standard I-beam profile
 Height: Approx. 200 mm
 Flange width: Approx. 100 mm
 Length: Approx. 3300 mm
Base: **Width:** Approx. 2000 mm
 Overall height: Approx. 3600 mm

BALL BEARING TROLLEY

Indicative unit price: USD 300
Shipping weight: 25 kg
Shipping volume: 15 pieces/m³
UNCCS Code: 435351

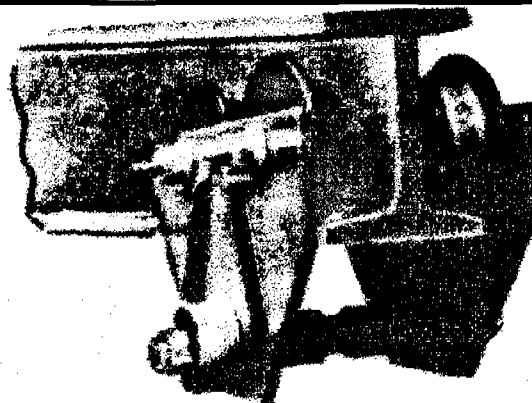

Type: Trolley with four steel wheels with bearings and side plates joined with one steel shaft for a hoist.
Area of use: To be used with the gantry crane above or the like
Lifting capacity: Minimum 3000 kg
Options:

- * Steel wheels with ball bearings
- * Flange width adjustable: 100 - 200 mm

LIFTING EQUIPMENT: HOISTS & LIFTING SLINGS

CHAIN PULLEY BLOCK

Indicative unit price: USD 650
Shipping weight: 20 kg
Shipping volume: 60 pieces/m³
UNCCS Code: 435116



Type: Hand-operated chain hoist with overload limiter. Steel link chain, swivel and safety hooks included.
Area of use: To use on ball bearing trolley with the gantry crane
Lifting capacity: Minimum 2000 kg
Lifting height: 3 meters
Brake: Fitted with automatic brake
Construction: Fully enclosed spur gear with strong frame
Hooks: Forged steel safety hook conform to recognized safety standards
Accessories: Tools used for maintenance

LIFTING SLING

Indicative unit price: USD 24
Shipping weight: 0.5 kg
Shipping volume: 300 pieces/m³
UNCCS Code: 435712

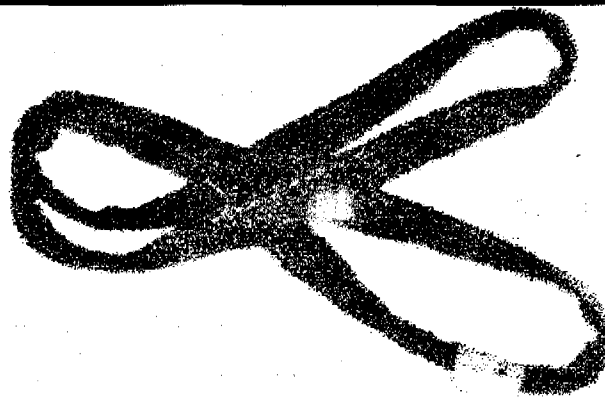

Type: Flexible lifting sling
Material: Loop made of polyester fibre with double protective cloth cover. Temperature limit approx 85°C
Lifting capacity: Minimum 2000 kg
Safety factor: minimum 6
Length of loop: 3 meters (circumferential)

LIFTING EQUIPMENT: WINCH

Indicative unit price: USD 450
Shipping weight: 20 kg
Shipping volume: 20 pieces/m³
UNCCS Code: 435130

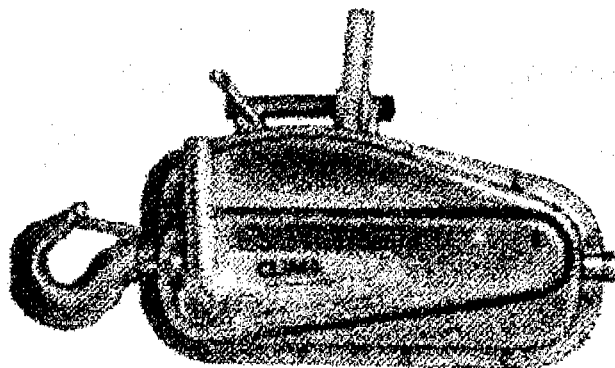

Type: Hand-operated winch of rugged construction, wire included

Area of use: Pulling and lifting heavy loads

Load capacity: **Lifting capacity:** Approx. 1500 kg
 Pulling capacity: Approx 2500 kg

Wire: **Diameter:** 11.6 mm
 Length: 20 meters
 Breaking strength: Minimum 75 kN

Wire lock: * A self-perpetuating self-locking type
 * Protection against overload

Lever: **Length:** approx. 1040 mm

Hooks: Safety hook conforms to recognized safety standards

Necessary power: Maximum 45 kg lever effort at maximum pulling load

Accessories: 2 extra shear pins

LIFTING EQUIPMENT: JACK

Indicative unit price: USD 240
Shipping weight: 36 kg
Shipping volume: 25 pieces/m³
UNCCS Code: 435141

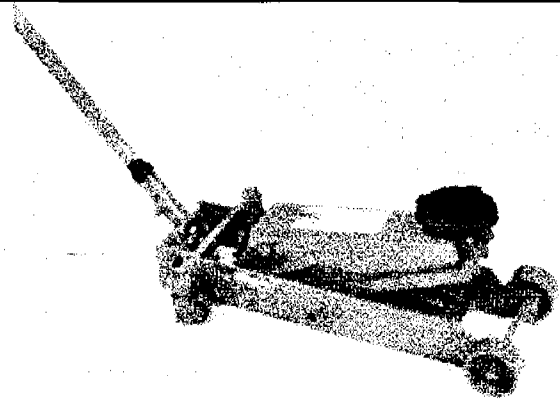

Type: Manually operated hydraulic trolley jack of rugged construction

Lifting capacity: Minimum 2000 kg

Lifting height:

- * Minimum approx. 125 mm
- * Maximum approx. 500 mm

Handle:

- * Removable
- * Full 90° pumping action

Wheels: Two fixed steel wheels and two swivel castors

Safety feature: Fitted with safety valve to prevent overloading

LIFTING EQUIPMENT: ROPES

Indicative unit price: See below
Shipping weight: See below
Shipping volume: See below
UNCCS Code: 273151

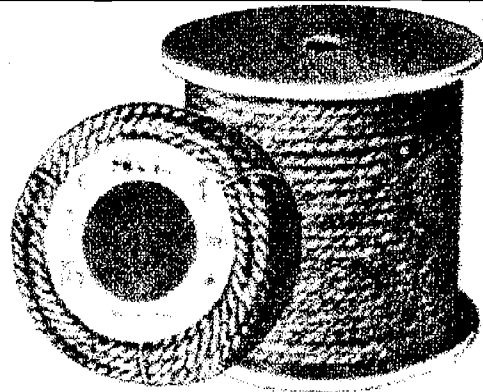

Diameter:	6 mm	16 mm	24 mm
Material:	Polypropylene	Polypropylene	Polypropylene
Weight:	2.5 kg/100 m	20 kg/100 m	45 kg/100 m
Coil of approx.:	200 m	200 m	200 m
Safe load:	50 kg	500 kg	1050 kg
Indicative unit price:	USD 13/100 m	USD 75/100 m	USD 120/100 m

TRANSPORTATION EQUIPMENT: HAND TRUCK

Indicative unit price: USD 110
Shipping weight: 15 kg
Shipping volume: 0.1 m³
UNCCS Code: 435354

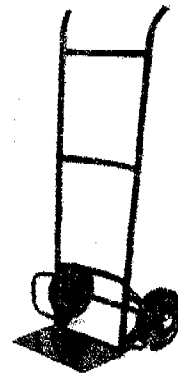

Type: Tubular sack truck of rugged construction

Capacity: 200 kg

Material: * Tubular steel construction
* Painted frame

Toe plate: * Approx. 320x200 mm
* Solid

Wheels: * Roller bearing rubber-tyred wheels
* Size: Approx. 200x50 mm

Handles: Plastic grip handles

TRANSPORTATION EQUIPMENT: DRUM TRUCK

Indicative unit price: USD 200
Shipping weight: 30 kg
Shipping volume: 0.5 m³
UNCCS Code: 435355

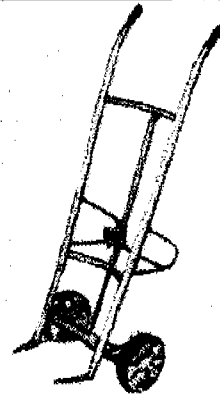

Type: Tubular drum truck of rugged construction

Capacity: 300 kg

Material:

- * Tubular steel construction
- * Painted frame

Toe bars: Welded onto the frame

Wheels:

- * Solid rubber tyred wheels
- * **Size:** Approx. 250x50 mm

Handles: Plastic grip handles

TRANSPORTATION EQUIPMENT: PLATFORM TRUCK

Indicative unit price: USD 250
Shipping weight: 60 kg
Shipping volume: 0.4 m³
UNCCS Code: 435352

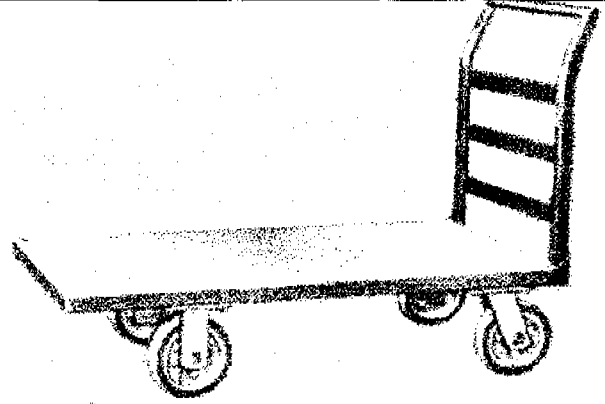

Type: Tubular platform truck of rugged construction

Capacity: 1000 kg

Material:

- * Base frame is welded steel with rounded corners
- * Handle is tubular steel construction
- * Abrasion proof paint

Platform: Approx. 1400x700 mm

Wheels:

- * Roller bearing with rubber tyre wheels
- * 2 fixed and 2 swivel castors
- * Size: Approx. 200x50 mm

Handles: Tubular metal handle, removable

TRANSPORTATION EQUIPMENT: CAGE TRUCK

Indicative unit price: USD 290
Shipping weight: 50 kg
Shipping volume: 0.7 m³
UNCCS Code: 435353

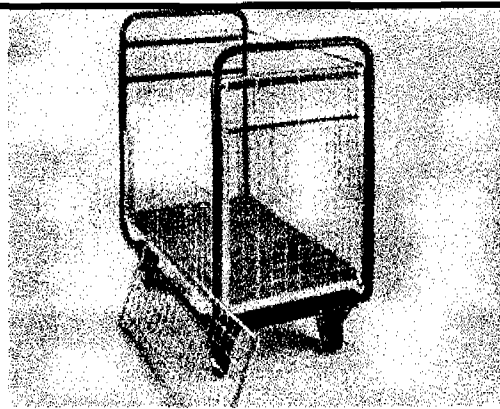

Type: Welded steel tube frame and mesh sides with 2 removable sides

Capacity: Minimum 250 kg

Size: **Platform:** Approx. 1000 x 600 mm
Hight of sides: Approx. 800 mm

Material: **Frame:** Painted mild steel tube
Mesh sides: Corrosion resistant steel or painted

Wheels: * 2 fixed and 2 swivel solid rubber tyres
* **Diameter:** Minimum 160 mm

TRANSPORTATION EQUIPMENT: PALLET TRUCK, MANUAL

Indicative unit price: USD 400
Shipping weight: 80 kg
Shipping volume: 0.4 m³
UNCCS Code: 435326

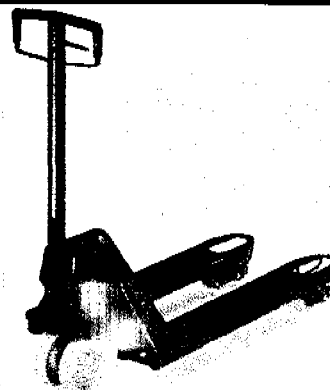

Type: Manual pallet truck operated from operation handle
Area of use: To move pallets within a store or warehouse
Material: All steel construction
Fork:

Width:	520 mm
Length:	Approx. 1125 mm
Height:	Lowered: 80 mm
	Raised: 120 mm

Pump: Heavy-duty sealed hydraulic jack unit
Hand operated lever: 3 position control for lower, neutral and raise
Load: Lifting capacity 2000 kg
Wheels:

- * Nylon wheel with built-in bearings.
- * Fork wheels in single or bogie-mounting
- * **Dimension:**

Steering wheel:	Approx.	175x60	mm
Fork wheel:	Approx.	85x100	mm

Accessories:

- * Spare parts for two years of operation.
- * Handtools used for maintenance.
- * Operation and service manual

TRANSPORTATION EQUIPMENT: FORKLIFT TRUCK

LIGHT DUTY

Indicative unit price: USD 25000
Shipping weight: 2700 kg
Shipping volume: 5.5 m³
UNCCS Code: 435312

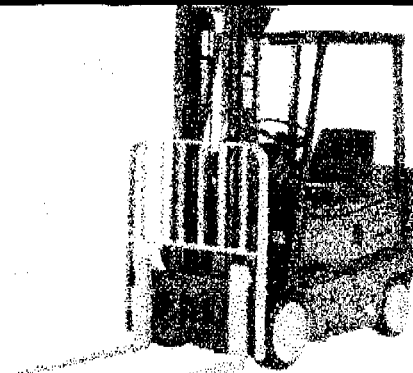

- Type:** Forklift truck, diesel driven.
- Area of use:** To load and unload heavy trucks and containers. Also to operate inside 20' standard containers
- Fork:**
- * Adjustable fork width
 - * **Length:** Approx. 1000 mm
- Lifting:**
- Method:** High freelift
- Load capacity:** 1500 kg at 500 mm load centre
- Lifting height:** 3000 mm
- Lift speed (loaded):** Approx 600 mm/sec
- Body:**
- * Strong steel framed body
 - * Safety cab with adjustable drivers seat
- Wheel:**
- * Pneumatic tyre type
 - * **Front tyre:** 6.50x10-10 ply
 - * **Rear tyre:** 5.00x8-8 ply
- Drive:**
- * 4 cylinder diesel engine
 - * Fuel tank minimum 40 litres
 - * Battery 2x12V - 40 Ah
- Travelling speed:** **Without load:** Approx 20 km/h
- Turning radius:** Approx. 2000 mm
- Accessories:**
- * Tool kit for maintenance
 - * Spare parts for two years of operation
 - * Tool kit to repair punctured tyres
 - * Operation and maintenance manual

TRANSPORTATION EQUIPMENT: FORKLIFT TRUCK

MEDIUM DUTY

Indicative unit price: USD 55000
Shipping weight: 8150 kg
Shipping volume: 22 m³
UNCCS Code: 435313

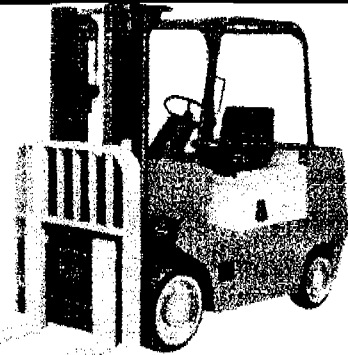

- Type:** Forklift truck, heavy type, diesel driven.
- Area of use:** To load and unload heavy trucks and container. Also to operate inside 20' standard containers
- Fork:**
- * Adjustable fork width
 - * **Length:** Approx. 1200 mm
- Lifting:**
- Lifting method:** High freelifit
- Load capacity:** Minimum 5000 kg at 600 mm load centre
- Lifting height:** Minimum 3100 mm
- Body:**
- * Strong steel framed body
 - * Safety cab with adjustable drivers seat
- Wheel:**
- * Pneumatic tyre type
 - * 4 wheels in front and 2 rear, all same size
- Tyres:**
- * 7.50x15-12 ply
- Drive:**
- * Diesel
 - * Fuel tank minimum 40 litres
 - * **Indicative values:**

Engine power:	50	kW
Consumption:	5	litre/h
- Speed:** Travelling without load: Approx. 25 km/h
- Turning radius:** Approx. 3400 mm
- Accessories:**
- * Tool kit for maintenance
 - * Spare parts for two years of operation
 - * Tool kit to repair punctured tyres
 - * Operation and Maintenance manual

TRANSPORTATION EQUIPMENT: DOLLY

Indicative unit price: USD 220
Shipping weight: 8 kg
Shipping volume: 0.01 m³
UNCCS Code: 435691

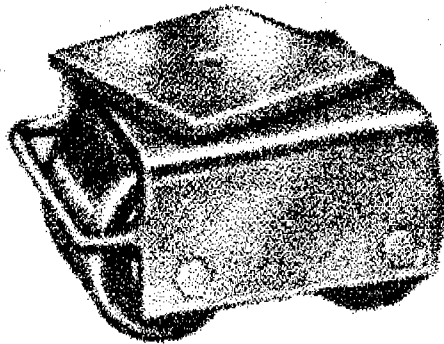

Type: Roller Skid Dolly with swivel top.
Area of use: For moving heavy equipment
Capacity: Minimum 1,250 kg
Size:

High:	Approx.	110	mm
Width:	Approx.	300	mm
Length:	Approx.	230	mm

Swivel top: Rotates 360°
Roller bearing rollers:

Diameter:	Approx.	100	mm
Width:	Approx.	105	mm

Frame: 6 mm thick steel
Material:

Frame:	Steel
Axles:	Steel
Rollers:	Steel

TRANSPORTATION EQUIPMENT: BOAT, INFLATABLE

Indicative unit price: USD 4500
Shipping weight: 450 kg
Shipping volume: 1 m³
UNCCS Code: 494200

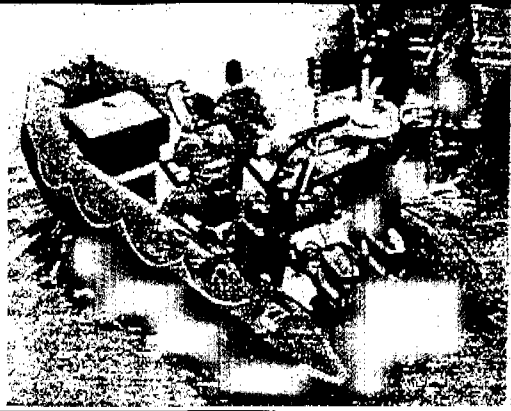

Type: Inflatable boat for approx. 10 persons, including outboard motor

Capacity: Minimum 1200 kg

Collar:

- * Lifeline built-in
- * Inflated:

Total length:	Approx. 6.0 m
Total width:	Approx. 2.5 m
Air chamber diameter:	Approx. 0.5 m

Material: Heavy duty nylon weave, coated on both sides

Accessories:

- * Outboard motor, Diesel driven, Maximum 2 x 30 hp
- * 2 Paddles
- * Baler, approx. 1.5 litre
- * Boat-hook
- * Foot pump with hose
- * Repair kit
- * Operation manual

TRANSPORTATION EQUIPMENT: LIFE-JACKET

Indicative unit price: USD 40
Shipping weight: 650 g
Shipping volume: 35 pieces/m³
UNCCS Code: 271921



Type: Life-jacket, - adult size

Area of use: During handling of materials on boats

Lifting material: Foam with a buoyancy covering a weight from 40 to 80 kg

Outer material:

- * Covered with nylon
- * Mounted with reflectors

Colour: Orange

Accessories: Signal whistle

STORAGE ITEMS: STORAGE RACK

Indicative unit price: USD 90/bay
Shipping weight: 50 kg/bay
Shipping volume: 6 bays/m³
UNCCS Code: 381631

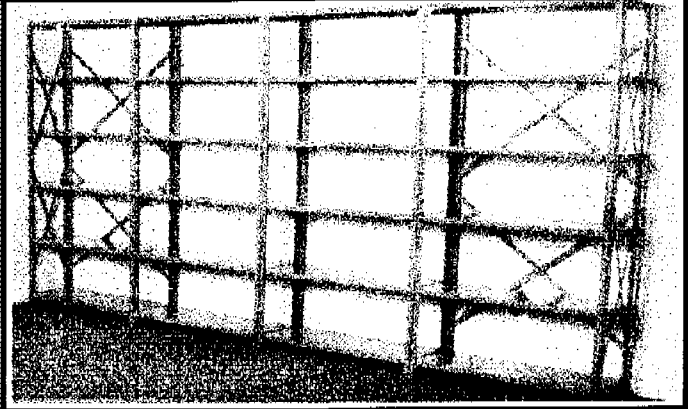

Type: Open shelf unit, consisting of one or several bays joined together side-by-side.

Area of use: Storage of smaller items, boxes, medicine etc...

Size: Indicative dimensions:

Height: 2000 mm
Width of a bay: 1000 mm
Depth: 500 mm

Capacity: Minimum 150 kg per shelf

Material: **Frame:** Galvanized steel angle profile
Shelves: Galvanized steel

Options:

- * Extension of the bay possible
- * Tools for mounting included

STORAGE ITEMS: CUPBOARD

Indicative unit price: USD 350
Shipping weight: 70 kg
Shipping volume: 0.2 m³
UNCCS Code: 381720

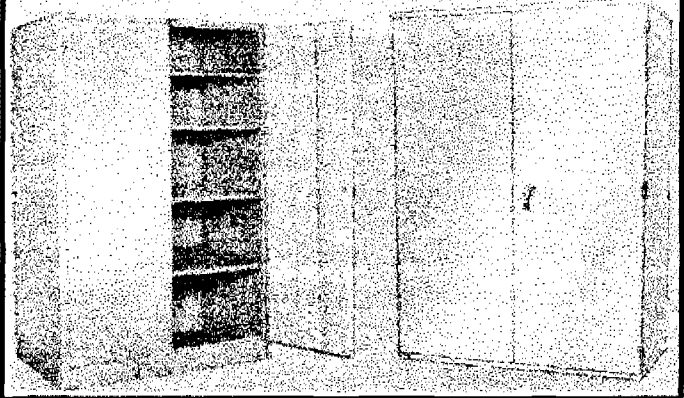

Type: Cupboard of steel

Area of use: Storage of tools, medicine etc...

Design: * Cupboard with 4 adjustable shelves and two doors with lock
* Knock-down type

Size: Indicative dimentions:

Height: 2000 mm
Width: 1000 mm
Depth: 500 mm

Material: All material of painted steel

Accessories: Tools for mounting included

STORAGE ITEMS: SCALE

Indicative unit price: USD 780
Shipping weight: 30 kg
Shipping volume: 0.1 m³
UNCCS Code: 482331

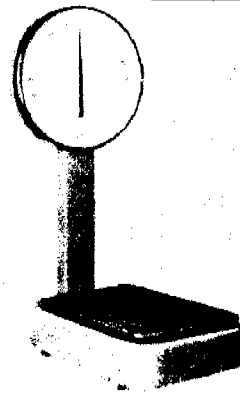

Type: Mechanical bench dial scale

Capacity: Approx. 110 kg

Material:

- * Cast iron base fully enclosed
- * Plexiglass cover on dial

Platform: Approx. 340 x 480 mm

Dial: **Diameter:** Approx. 330 mm
Metric reading, graduation in kg or lbs.

Features:

- * Springs unaffected by the temperature.
- * Easy to maintain

STORAGE ITEMS: LADDER, ALUMINIUM

Indicative unit price: USD 150
Shipping weight: 12 kg
Shipping volume: 2900x500x70 mm
UNCCS Code: 429931

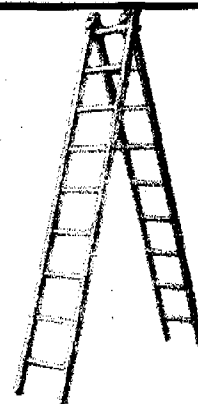

Type: A double ladder for free standing application and as an adjustable ladder consisting of 2 single robust light metal ladders

Area of use: Free standing ladder or fitted together as an adjustable ladder

Length: **Overall height:** Approx. 5.0 m
Free standing height: Approx. 2.7 m

Steps: Approx. 9 steps on each ladder

Profile: Approx. 70x35 mm

Material: Aluminium ladder with steel fittings

Strength: Conforms to recognized safety standard.

Accessories: * Fittings for freestanding mode and for extended mode
* Security fittings

STORAGE ITEMS: GRAVITY ROLLER CONVEYOR

Indicative unit price:	USD 120/m
Shipping weight:	60 kg
Shipping volume:	0.01 m ³
UNCCS Code:	435551

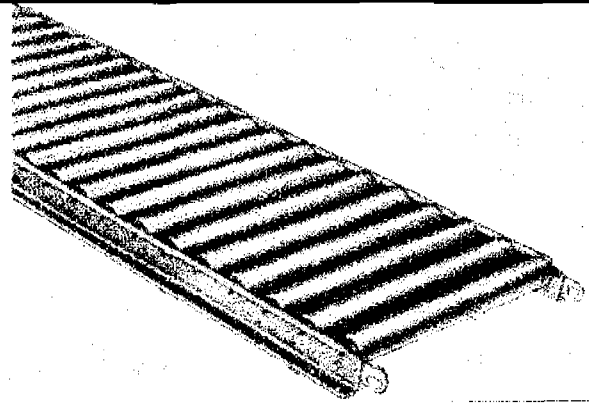

Type:	Section of conveyor line on support stand		
Length:	3 m		
Frame:	Painted, galvanized steel frame on 4 adjustable support stands		
Capacity:	400 kg		
Rollers:	* Capacity:	20	kg/roller
	* Width:	400	mm
	* Diameter:	50	mm
	* Pitch:	90	mm
	* High impact plastic rollers fitted with stainless steel ball bearing race		
Ball bearings:	Sealed type		
Height:	Adjustable 700 to 900 mm		

STORAGE ITEMS: MATERIALS HANDLING TOOL KIT

Indicative unit price: USD 85/set
Shipping weight: 5 kg
Shipping volume: 200 sets/m³
UNCCS Code: 429255

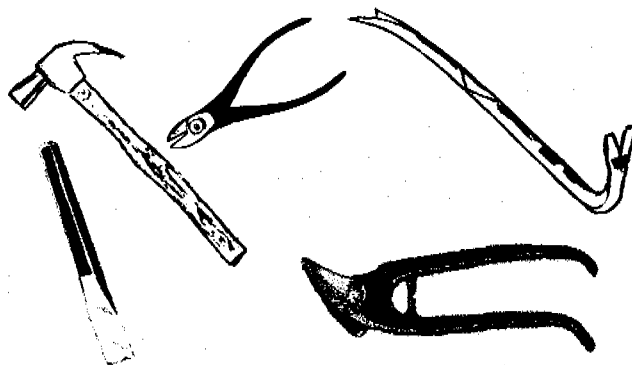

HAMMER:

Indicative unit price:	USD 14
UNCCS Code:	429414
Type:	Claw hammer for general use
Head:	<ul style="list-style-type: none"> * Forged grade, alloy steel head * Polished and chamfered on edge to resist chipping * Weight - approx. 600 g * Wooden handle * Pre-shrunk and triple wedged into head
Handle:	

PLIER:

Indicative unit price:	USD 12
UNCCS Code:	429324
Type:	Diagonal cutting pliers to cut steel banding up to 1.8mm thick, or steel wire up to 3.0 mm diameter
Material:	<ul style="list-style-type: none"> * Chromium or forged alloy steel. * Chromium plated
Options:	Built-in spring to keep the pliers open when not in use

CROW BAR:

Indicative unit price:	USD 14
UNCCS Code:	429351
Material:	Carbon steel hex bar
Design:	Gooseneck claw at one end and a pinch at the other
Size:	Approximately 700 mm long

SNIP:

Indicative unit price:	USD 25
UNCCS Code:	429522
Type:	Sheet cutting snips for mild steel sheets up to 1.5 mm thick
Blades:	Induction hardened

CHISEL:

Indicative unit price:	USD 20				
UNCCS Code:	429342				
Type:	Standard cold chisel set. Set of five chisels				
Size:	<table border="0"> <tr> <td>Cut:</td> <td>Approx. 1/4" to 1"</td> </tr> <tr> <td>Length:</td> <td>Approx. 5" to 8"</td> </tr> </table>	Cut:	Approx. 1/4" to 1"	Length:	Approx. 5" to 8"
Cut:	Approx. 1/4" to 1"				
Length:	Approx. 5" to 8"				
Material:	Forged, high-grade hexagon steel				

STORAGE ITEMS: REPACKING TOOL KIT

Indicative unit price: USD 450/set
Shipping weight: 10 kg
Shipping volume: sets/m³
UNCCS Code: 429256

TAPE FOR REPACKING:

Indicative unit price: Approx. USD 2/coil
UNCCS Code: 369936
Width: Minimum 50 mm
Tensile strength: Minimum 50 N/10 mm

TENSIONER/SEALER:

Indicative unit price: USD 170
UNCCS Code: 451673
Type: * Tensioner of rugged construction
* Sealer of rugged construction for plastic strapping
Size: For 1/2" strapping
Accessories: 10000 Strapping seals, semi-open

STAPLER:

Indicative unit price: USD 130
UNCCS Code: 389158
Type: Manual stapler for carton closing
Stapler: 1 1/4" x 5/8" staples
Accessories: 1000 staples

KNIVES, UTILITY:

Indicative unit price: USD 4
UNCCS Code: 429155
Type: Adjustable general utility knife
Accessories: 3 extra blades

SAFETY ITEMS: MASKS & GLOVES

PROTECTIVE MASK

Indicative unit price: USD 50/100 pieces
Shipping weight: 0.6 kg/100 pieces
Shipping volume:
UNCCS Code: 369737

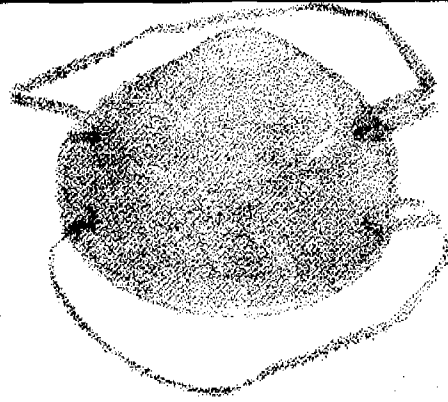

Type: Dust/mist respirators covering mouth and nose

Area of use: Protecting against light concentrations of dust and mists which do not contain harmful vapors

Material: Synthetic fibre

Filters: Woven fibre filter

Options: Double elastic headbands

WORKING GLOVES

Indicative unit price: USD 2
Shipping weight: 20 kg/100 pair
Shipping volume: 0.05 m³/100 pair
UNCCS Code: 282387



Type: Chrome leather gloves with elasticated gauntlet cuff

Material: Full leather front and cotton back

Size: 10.5 cm

Option: With fingertip and knuckle protection of leather

**SAFETY ITEMS:
SAFETY HELMETS & HEARING PROTECTORS**

SAFETY HELMET

Indicative unit price: USD 10
 Shipping weight: 0.5kg
 Shipping volume: 100 pieces/m³
 UNCCS Code: 369711

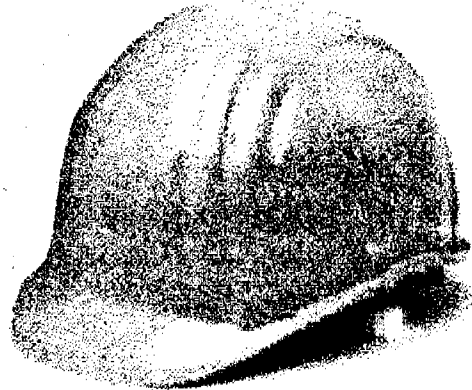

Type: Safety helmet of rugged construction

Head band: Adjustable to fit size 6½ to 7½

Material:

- * High density polyethylene, with easily replaceable 4 point suspension.
- * Conforms to recognized standards

HEARING PROTECTOR

Indicative unit price: USD 10
 Shipping weight: 0.15 kg
 Shipping volume: 250 pieces/m³
 UNCCS Code: 369735



Type: Ear muffs

Noise reduction: Approx. 30 dB

Material:

- Head band:** Plastic reinforced glassfibres or stainless steel spring bands
- Cups:** Thermoplastic
- Filling:** Non-toxic sound absorbing foam

Options: Easily adjustable cups

SAFETY ITEMS: SHOES, SAFETY

Indicative unit price:	USD 55
Shipping weight:	1 kg
Shipping volume:	0.02 m ³
UNCCS Code:	295322

Type: Safety shoes with a protective sole and a built-in protective toe cap

Size range: 6 to 12 (US size)

Material:

Toe cap:	Steel
Sole:	Moulded rubber sole with a built-in steel arch at the instep
Uppers:	Leather

Toe cap: To withstand minimum 2500 kg static pressure

**GENERAL ITEMS:
HAND SAW**

Indicative unit price: USD 20
Shipping weight: 0.4 kg
Shipping volume: pieces/m³
UNCCS Code: 429310

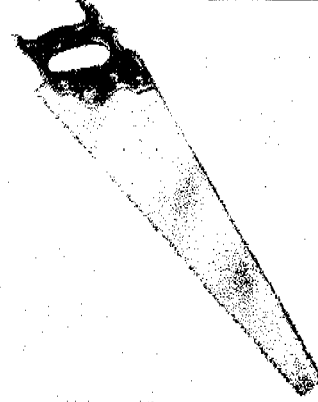

Type: Hand saw

Length: Approx 550 mm (22")

Teeth: * Universal tooth setting for cross-cutting and ripping
* Approx. 7 teeth per inch

Material: **Blade:** Hardened and tempered chrome nickel alloy steel
Handle: Plastic or hard wood handle

GENERAL ITEMS: CIRCULAR SAW

Indicative unit price: USD 140
Shipping weight: 6.5 kg
Shipping volume:
UNCCS Code: 429315

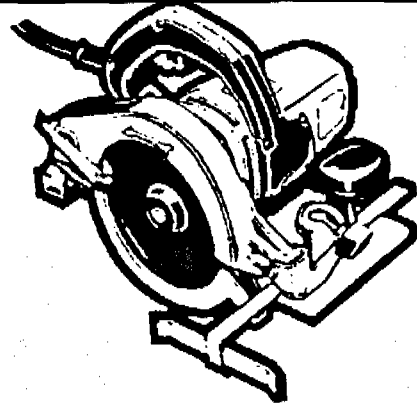

- Type:** Portable circular saw for rip, cross and mitre cutting
- Power input:** Approx. 1400 W
- Speed:** **No-load speed:** 5000 rpm
- Capacity:** **At 90 degrees:** 65 mm
Continuous cutting depth adjustment: 0-65 mm
- Saw blade:** **Diameter:** 90 mm
Drilling diameter: 30 mm
- Features:**
- * Interior retracting guard providing proper saw blade covering
 - * Safety coupling for disengaging in case of blade jamming
 - * Shavings blower keeping cutting point and track clean
 - * Dust extractor
- Accessories:**
- * Allen key and parallel fence
 - * One saw blade
 - * Instruction and maintenance sheets

**GENERAL ITEMS:
SNOW CHAINS FOR VEHICLES**

SNOW CHAINS FOR VEHICLES

Indicative unit price: USD 90 - 150

UNCCS Code: 491943

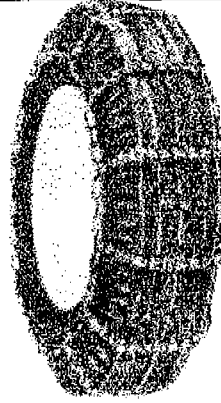

- Type:** Reinforced snow chain for vehicles
- Area of use:** To be used on trucks.
- Size:** When ordering, specify the size of the truck tyre.
- Material:** Case hardened steel with polished finish

**GENERAL ITEMS:
LEAD SEAL & SEAL PRESS**

LEAD SEAL

Indicative unit price: USD 90/1000 pieces
Shipping weight: 3 kg
UNCCS Code: 429685

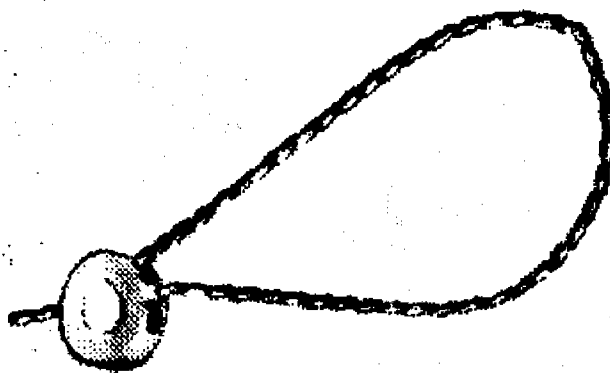

Type: Blank lead and wire seals
Seal: Wire seals with attached lead discs
Discs: **Diameter:** 1/2"
Material: Lead
Wire: **Material:** 23-gauge galvanized steel wire
Length: 10"

SEAL PRESS

Indicative unit price: USD 75
Shipping weight: 0.5 kg
UNCCS Code: 451644

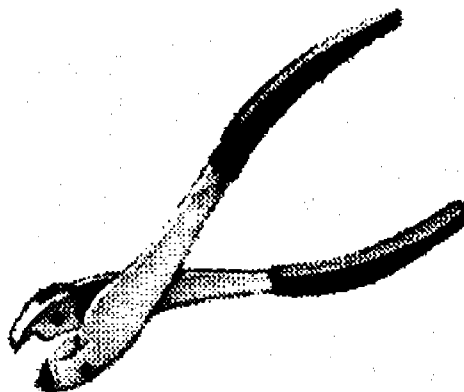

Type: Combination seal and wire cutter
Size: To seal minimum 1/2" diameter lead seals
Features: Built-in wire cutter

GENERAL ITEMS: ROLLER CROWBAR

Indicative unit price: USD 100
Shipping weight: 14 kg
UNCCS Code: 429355

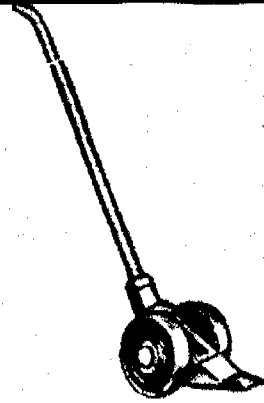

Type: Crowbar with two rollers built in

Area of use:

- * In warehouses
- * In freight terminals where heavy items have to be moved

Capacity: Minimum 2,500 kg

Crowbar style: Nose rolls

Wheels:

Material:	Steel	
Diameter:	150	mm
Width:	50	mm

Handle:

Material:	Painted steel	
Length:	Approx. 2000	mm

**CHAPTER 7 -
POWER SUPPLY SYSTEMS**

NEEDS AND RECOMMENDED RESPONSES

Introduction

This section has been prepared to facilitate the selection of appropriate power generating equipment suitable for installation as a part of emergency relief operations.

The range of equipment covered essentially addresses the requirements of electric power in an emergency relief camp with about three thousand to four thousand persons housed in approximately 800 - 1000 temporary shelters.

Camps of approximately the above size are estimated to require about 50-60 kVA to cope with the primary needs of adequate lighting in the community kitchens and security lighting, whilst also allowing some minimal lighting of the shared facilities such as toilets etc., and of the shelters themselves.

Apart from the above, there are perceived some specific power requirements for mobile communications and also for a field office set-up, which are desirable for the effective functioning of the personnel from relief organizations. These aspects are estimated to need about 5 kVA of power generating capacity to drive some basic office equipment, and a minimum of 0.3 kVA for mobile communications equipment.

It is recommended that when power generating sets of the larger capacities are purchased for emergency relief (i.e. over 45 kVA), these should be obtained along with weather proof or acoustic canopies, as available, to minimize the nuisance from noise, and also to obviate the need for provision of a separate shelter for the power generating equipment itself.

As a rule, the power generating equipment listed in this catalogue will need to be installed and commissioned at emergency sites. Hence, it is unlikely that properly prepared foundations can initially be made available, as described in the general catalogue for power generating sets which are intended for stand-by duty in more permanent installations.

However, the smallest power generators (below 1.0 kVA) are suitable for use without any special foundations, whereas the larger equipment can be used for several days simply placed on firm and well-levelled ground (which must be able to support the weight of the set).

Basis for estimating power requirements:

For the purpose of classification, the power supply equipment is categorized into the three generic types of:

- Power supply for 800 - 1000 emergency relief shelters
- Power supply for a field office of the relief agency
- Power supply for mobile communications

The power requirements for each of the above are arrived at as follows:

- (i) Lighting for 800 - 1000 temporary shelters (an average lighting of 20 - 30 watts in each shelter) to house 3000 - 4000 persons (approx) 20 kW

Security lights for camp as above..... 15 - 20 kW

Lighting/power for community kitchens, first-aid rooms, toilets 15 - 20 kW

- (ii) Lighting/power for a field office equipped with:

NEEDS AND RECOMMENDED RESPONSES

<u>Appliance</u>	<u>Approx. power requirements (kW)</u>
Computer (personal)	0.3 - 0.5
Computer (laser printer)	1.0
Lights (bulbs)	0.03 - 0.1
Lights (fluorescent tubes)	0.02 - 0.1
Lights (security, halogen)	0.1 - 0.5
Photocopier (desktop)	1.0 - 2.0
Typewriter/Word processor	0.2 - 0.4

- (iii) Mobile communications systems of A, C and M types are currently supplied with a power requirement ranging between 120 watts and 250 watts.

Spare Parts

It is recommended that spare parts packs be ordered together with the equipment (for regions with poor or non-existing local services). Suppliers or IAPSO may be contacted for details of the content of recommended spare parts packs.

Some notes on installation

Advance planning and installation work is desirable before arrival of the larger power generators at site.

Some aspects to be considered in planning installations at emergency relief sites include:

a) Generator Location

The larger generators are supplied with anti-vibration mounts and on a fabricated skid base, which allows the equipment to be installed for temporary use without elaborate foundations.

However, it is important to ensure that the area of installation is on a firm and hard ground surface, which must be carefully checked and levelled. Any irregularities which can lead to unbalanced seating of the set on its base must be completely eliminated, and full and secure seating confirmed before starting up of the equipment.

b) Foundations

Though, the power generating sets may be used temporarily as above, without specially constructed foundations. It is important that proper foundations are prepared according to the manufacturer's specifications as soon as possible.

Note: Guidelines for construction of appropriate foundations are also available in IAPSO's product catalogue of Power Generators.

POWER GENERATOR FOR 800 - 1000 SHELTERS

DIESEL GENERATING SETS, 60 kVA

Indicative unit price: USD 9000
Shipping weight: Aprox. 1000 kg
Shipping volume: Aprox. 3 m³
UNCCS Code: 461133

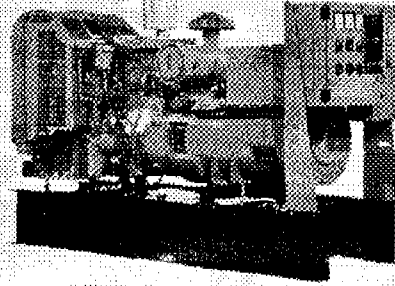

Principal particulars: **Rated Power:** 60 kVA
 Power factor: 0.8
 Voltage: 380V [220V] 3 phase
 Output: 90 A
 Speed: 1500 [1800] rpm
 Frequency: 50Hz [60 Hz]

Engine: * Diesel, 4 stroke cycle
 * Direct injection
 * Turbo charged
 * 4 or 6 cylinders in-line
 * Water cooled with tropical radiator
 * 24 Volt electrical system with starter and battery
 * Electronic or mechanical governor
 Output: 60 kW at 1500 rpm

Alternator: **Output:** 60 kVA at 1500 rpm
 * Insulation to class H
 * To CEI 2.3, IEC 34.1, VDE 0530, BS 5000
 * Self regulating, 4 pole, 2 bearing type
 * Fabricated steel shell with drip proof air ducts

General: * Engine close coupled to alternator
 * Mounted on anti-vibration mounts on fabricated skid base
 * Fuel tank incorporated into base
 * Lifting points for handling.

Control Panel: **Steel panel fitted on the set including:**
 * Ammeter with switch, Voltmeter with switch, Hour meter, Tachometer and Frequency meter
 * Key start/stop
 * 2 x 380/3/50 [210/3/60] outlet sockets (CEE type) 32 Amp
 * 2 x 220/1/50 [120/1/60] outlet sockets (CEE type) 16 Amp
 * Main 3-pole circuit breaker

Instruments: * Water temperature
 * Oil pressure
 * Battery voltmeter

Continued on next page...

POWER GENERATOR FOR 800 - 1000 SHELTERS

DIESEL GENERATING SETS, 60 kVA

Indicative unit price:	USD 9000
Shipping weight:	Aprox. 1000 kg
Shipping volume:	Aprox. 3 m ³
UNCCS Code:	461133

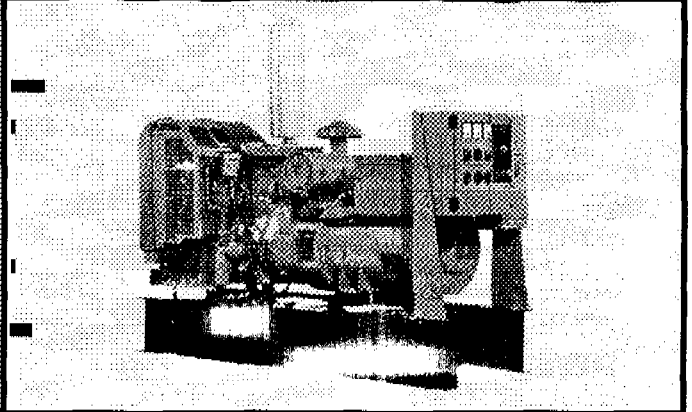

... Continued from previous page

- Standard Accessories:**
- * Automatic shutdown on low oil pressure or high engine temperature
 - * Low resistance earth rod with 4 m cable
 - * 4 x 25 m supply cables (2 x 3 phase, 2 x 1 phase) with plugs
 - * Engine makers' tool kit
 - * Operator manuals
 - * Tropical radiator
 - * Oil, air and fuel filters
 - * Flexible exhaust pipe, heavy duty industrial silencer and guards
 - * Fuel tank gauge

Spares and optional extras:

- * Spare parts (2500 h)
- * Automatic mains failure panel (AMF)
- * Heavy duty air cleaner
- * Over speed protection
- * Synchronizing/paralleling panel
- * Flex. exhaust & silencer
- * Acoustic canopy (80 dBA)
- * Weatherproof canopy
- * Slow moving trailer
- * Fast moving trailer (highway)
- * Overhaul kit

Note: Values for [60 Hz, 220V, 3phase] are shown in italics.

POWER GENERATOR FOR FIELD OFFICE

DIESEL GENERATING SETS, 5 kVA

Indicative unit price: USD 3,000
Shipping weight : Approx. 180 kg
Shipping volume: Approx. 0.5 m³
UNCCS Code: 461131/461132

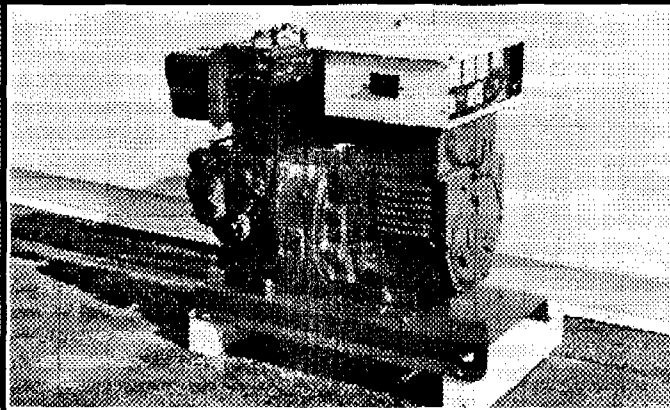

Principal particulars: **Rated Power:** 5 kVA
 Power Factor: 0.8
 Voltage: 220/380 V [120/210 V] 3 phase
 Output: 8 A [14 A]
 Speed: 1500 rpm [1800 rpm]
 Frequency: 50 Hz [60 Hz]

Engine: * Diesel, 4 stroke cycle
 * Direct injection
 * Naturally aspirated
 * 1 cylinder
 * Forced Air Cooling by flywheel mounted/separate Fan or Water Cooling
 by Radiator and Fan
 * Electric/Hand start
 * Mechanical governor
 Output: 4.5 kW at 1500 rpm

Alternator: **Output:** 5 kVA at 1500 rpm
 * Insulation to class H
 * To IEC 34.1, VDE 0530, BS 5000 part 3, UTE 5100, NEMA MGI 22,
 CSA 22.2, AS 1359
 * Self regulating, 4 pole, single bearing type
 * Fabricated steel shell with drip proof air ducts to IP23

General: * Engine close coupled to alternator
 * Mounted on anti-vibration mounts on fabricated skid base
 * fuel tank mounted on engine or incorporated into base
 * Lifting points for handling

Control Panel: **Panel fitted on the set including:**
 * 3 x Ammeter, Voltmeter with switch, Hour meter and Frequency meter
 * 1 x 380/3/50 [210/3/60] outlet socket (CEE type) c/w circuit breaker
 * 1 x 220/1/50 [120/1/60] outlet socket (CEE type) c/w circuit breaker

Standard Accessories: * Automatic shutdown on low oil pressure or high engine temperature when
 ordered with electric start option
 * Low resistance earth rod with 4 m cable
 * 1 x 25 m supply cable with plug (H07) suitable for sockets supplied

Continued on next page...

POWER GENERATOR FOR FIELD OFFICE

DIESEL GENERATING SETS, 5 kVA

Indicative unit price:	USD 3,000
Shipping weight :	Approx. 180 kg
Shipping volume:	Approx. 0.5 m ³
UNCCS Code:	461131/461132

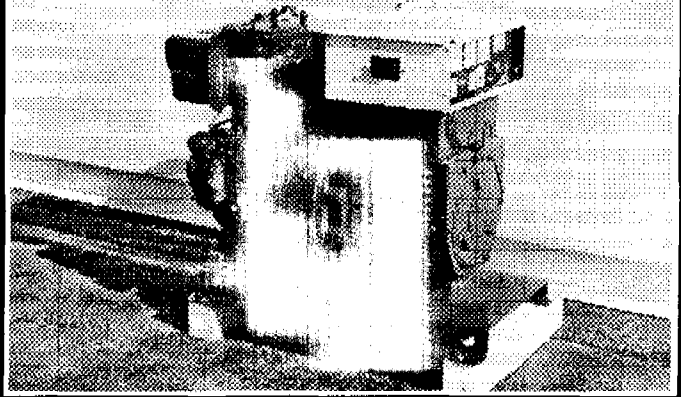

... Continued from previous page

- * Engine makers' tool kit
- * Operator manuals
- * Oil, air and fuel filters
- * Engine mounted exhaust silencer

Spares and optional extras:

- * Spare parts (500 h)
- * Wheeled trolley kit
- * Electric starting system with battery
- * Acoustic canopy

- Engine instruments:**
- * Temperature
 - * Oil pressure
 - * Battery ammeter

Note: Values for [60 Hz, 220V, 3phase] are shown in italics.

POWER GENERATOR FOR FIELD TELECOMMUNICATIONS

PORTABLE GENERATORS, 0.5 kVA

Indicative unit price: USD 950
Shipping weight : Approx. 20 kg
Shipping volume: Approx. 0.05 m³
UNCCS Code: 461141

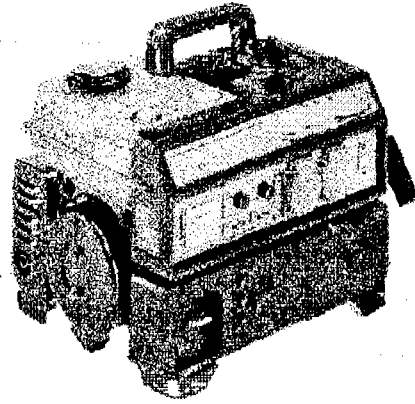

- Type:** Portable petrol power generator
- Area of use:** For use as a power supply for mobile field communication equipment
- Principal Particulars:**
- Rated Power:** 0.5 kVA
 - Voltage:** 220 V [*120 V*] 1 phase
 - Output:** 1.3 - 3 A [*2.3 - 5.2 A*]
 - Speed:** 3000 rpm [*3600 rpm*]
 - Frequency:** 50 Hz [*60 Hz*]
- Engine:**
- * Petrol, 2 stroke cycle
 - * 1 cylinder
 - * Forced Air Cooling by flywheel-mounted fan
 - * Hand start
- Fuel consumption:** approx. 0.25 - 0.6 litres/hour
- Output:** 0.65 - 1.1 kW at 3000 rpm
- Fuel tank:** 1 - 3 litres (to last 4 - 5 hrs at approx. full power output)
- Alternator:**
- Output:** 0.5 kVA at 3000 rpm
 - * 220 volts - 50 Hz [*120 V - 60 Hz*]
 - * Construction to IP 23 or equivalent
- Features:**
- * 2 - power outlets
 - * Quiet operation
 - * Easy starting
 - * Petrol level indicator
 - * Automatic power regulator
- Standard Accessories:**
- * Battery charger, **output:** 12 V, 72 W
 - * Tool kit for routine maintenance
 - * Operation manuals
 - * Oil, air and fuel filters

Note: Values for [60 Hz, 110V, 1phase] are shown in italics.

NOTES

CHAPTER 8 - LOGISTICS

Introduction

Logistics for emergency operations is a complex task aiming for mobilization and development of the necessary capacities to deliver assistance to the communities in need.

It contains actions *inter alia*, to ensure the provision of facilities to receive/discharge and store at ports and airports, any supplies to be imported, organize the transport of supplies within the country, organize storage for operational and any necessary contingency stocks at appropriate locations, ensure fuel supplies, maintenance etc. for all means of transport, establish reliable means of communications between all key locations etc..

These elements of logistics operations are normally dealt with by logistics offices and operational managers and not by Procurement officers.

This chapter is therefore limited to the part of contracting the efficient forwarding of acquired relief items up to the first point of entry into the disaster-stricken country, and is intended to assist Procurement Personnel to do this job in an effective and professional way.

Apart from the acquisition of suitable products as identified in this catalogue, the timely and safe provision of the goods to the disaster area is the key to the success of any emergency relief operation.

Like the detailed technical specifications for relief items to be provided, a clear and comprehensive list of shipping requirements is also indispensable.

Based on practical field experience, this chapter will provide necessary details, specifications and useful information that is to be considered for essential elements of the forwarding process.

In particular, such important elements like

- **Packaging**
- **Quality Inspection**
- **Selection of mode of transport and shipping arrangements**
- **Insurance**

will be dealt with.

PACKAGING

General

One can hardly imagine what treatment relief supplies undergo during the journey from their country of origin to the place of distribution. A single item may be loaded or off-loaded up to a dozen times before it reaches its final destination. And then, it is possible that the eventual beneficiary will still need to carry it over long distances to his family.

Particular attention should therefore be given to adequate and durable packing of relief supplies, which in fact, encompass a considerable variety of items and need to deal with virtually every conceivable (and sometimes quite inconceivable) eventuality.

The objectives of packaging include:

a) Containment

- * Small items in quantity are contained for handling purposes and for issue in standard units.
- * Items of inconvenient shape are contained in regular containers for similar reasons.
- * Items may be contained in ways that permit their easier placement upright on shelves.

b) Protection

- * Fragile items need protection from handling.
- * Items to be temporarily stored outdoors need protection from the weather.
- * Handlers have, on occasion, to be protected from items.
- * Valuable items or items in bond require packaging for security.

c) Identification

- * Technical information of hazardous or potentially life-expired items (pharmaceuticals, film) must be communicated to potential users.
- * Items are sometimes required to certain operating or usage instructions.

Further consideration should also be given:

- * to protect goods against breakage, contamination or distortion.
- * to reduce the volume and thereby cut freight costs.
- * to facilitate handling.
- * to facilitate storage.
- * to group goods into a convenient unit for distribution.
- * to reduce opportunities for pilfering.

Outer packing

a) Weight

To allow acceptable ease of manual handling in field locations where mechanical equipment may sometimes not be available, maximum gross weights of some commonly encountered items should be restricted as follows:

- Boxes or cartons: 25 kg
- Bundles or sacks: 50 kg

b) Strength

Strong outer material to ensure that packages do not twist or collapse during handling.

PACKAGING

c) Fillers

Empty spaces should be filled with filling material like wood shavings, straw, shredded paper, plastic foam, corrugated paper board etc., to eliminate any free movement of the contents of the packages, and also to contribute towards the mechanical rigidity of the packages.

d) Stackability

Package sizes in each consignment should be standardized, and packages should preferably be stackable up to a height of 3.0 metres (Round or cylindrical packages should be avoided where possible).

e) Sealing

All packages should be closed or lidded and sealed.

f) Weatherproofing

Waterproof material or material treated for moisture resistance should be used for packing.

g) Seaworthiness

Fortified, strong, solid packaging material i.e. multi-wall cardboard or wood should be used.

h) Extra empty Bags or Cartons

Ask for extra empty bags or cartons, and the number should be equal to 2% of the total number of bags or cartons with large consignments.

i) General advice

- * Never pack loose items in sacks.
- * If several transfers are required along the way from vessel to rail, rail to lorry and finally to 4-wheel drive vehicle involving manual transfer, the packing will require special provision for this, and the weight of each package may need to be restricted to allow manual transfer.
- * Where possible, the type of packaging should be specified in detail at the time of order placement.

Inner packing

Attention should be paid to the following points:

- * The inner packing should be unbreakable and sealed
- * Glass or brittle containers should be avoided
- * Cellophane should not be used
- * Lids should be fastened tightly
- * There should be no sharp edges

a) Goods by Type

- * Never mix medical with non-medical supplies.
- * Generally, any one package should contain only one product, and only one size of that product.
- * Goods should only be mixed if special mixed units are required, i.e. "Family parcels".

b) Edible and Inedible goods

- * If packed with other goods, the contamination of edible foods must be prevented by provision of adequate barriers.
- * Edible and inedible products must be packed separately in plastic wrapping when included in the same unit or consignment

PACKAGING

b) Certification

- * Shipper should certify that packing complies with I.A.T.A. regulations, as required.

Other considerations

a) Cartons, desirable qualities

- * Maximum content weight: 25 kg.
- * Strong export carton such as multi-wall cardboard container with one waterproof layer.
- * Strong and stackable when filled to capacity, solidly packed and sealed.
- * Resistant to humidity which can cause loss of corner strength or collapse.
- * Bound with tape or strapping.

b) Wooden Box or Case

Used for breakable or valuable goods, for sea shipments and where especially difficult conditions of transportation are likely to be encountered.

- * Maximum gross weight: 50 kg, but preferably 25 kg.
- * Stackable
- * Strong quality wood
- * Treated for moisture resistance
- * Lined with heavy plastic or waterproof paper
- * Bound with strapping

c) Wooden crate

Used to protect heavy articles such as generators and medical equipment.

- * Packing case made from slats of wood

d) Bag or Sack

Used for packing bulk dry food items.

- * 3 ply paper sack with plastic inner sack, used for milk powder and enriched food products.
- * Jute outer sacks with cotton inner sack for legumes, grains etc.
- * Woven polypropylene or cotton/polypropylene blend outer sack, with cotton inner sack for cereals, grains etc..

e) Bale or Bundle

Generally used for packaging blankets and clothing.

- * Generally maximum weight: 50 kg
- * Compressed and strapped
- * Covered with waterproof material

f) Pallet

Generally used for outgoing relief consignments.

- * Good quality of wood
- * Covered with plastic shrink-wrap or plastic sheeting and bound with strapping or strapped thoroughly all around goods and the pallet
- * Size and type chosen to fit onto transport and loading equipment used
- * Packing list must itemize goods on each pallet

PACKAGING

g) Standardized Trans-Container

Most commonly used are:

- * 20 foot container and 30 cubic meters capacity with a maximum load of 18 tons.

Internal dimensions:	Length:	5.89 meters
	Width:	2.32 meters
	Height:	2.23 meters
Door:	Width:	2.30 meters
	Height:	2.14 meters

- * 40 foot container and 60 cubic meters capacity with a maximum load of 30 tons.

Internal dimensions:	Length:	12 meters
	Width:	2.32 meters
	Height:	2.34 meters
Door:	Width:	2.30 meters
	Height:	2.23 meters

- * 45 foot containers are also in use, mainly in the U.S.A.

Note: Where containers are to be used for dispatch of supplies, the following points should be covered:

- * It must be confirmed that the destination can handle the container
- * Each package in container must be properly marked

h) Strapping, Taping

Bales, wooden boxes and cases are always strapped.

- * Woven polyester strapping preferred to metal bands
- * Strong packing tape may be preferred on cartons if under 10 kg
- * Strap at least once around length and twice around width of package

i) Tins, Cans

- * Re-usable containers preferred
- * Accompanied by opening devices

j) Plastic Bags and Wrapping

- * No cellophane
- * Heavy duty plastic
- * Possibly vacuum packed

k) Filling Materials

- * Wood shavings
- * Straw
- * Shredded paper
- * Styrofoam
- * Air-bubble plastic sheet
- * Corrugated paperboard partitions

Markings

In large scale relief operations, the simultaneous arrival of thousands of relief parcels is common. Information on the content of these consignments is thus of vital importance. Accordingly, attention should be paid to the following issues:

PACKAGING

a) Visibility

- * The vendor shall preferably stencil in bold letters and waterproof ink the address indicated in each purchase order on each pallet, package, carton etc..

- * Dark lettering on light background

Non-detachable Labels:

- * Glue labels with heat-curing glue

- * Avoid self-adhesive stickers

b) Identification

- * To facilitate identification of shipments at the point of discharge, each pallet, package, carton etc., shall have a wide blue band in the form of a ribbon of blue paint, at least one inch wide (In the case of containerized shipments, the blue band is not required).

c) Addresses

The actual address to be used shall be that indicated in the purchase order. The following information should be available "at a glance" on each label:

- * Symbol of the organization placing the order

- * Purchase order reference

- * Final destination (port of arrival)

- * Name of sender

- * Total number of pieces

- * Box number, if part of a set

- * Weight

- * Description of contents

- * Consignee address

The language to be used depends on the destination of the consignment. In most cases, English, French or Spanish would be used.

d) Air consignments

For air consignments, a label with the following information must be attached:

- * Airway bill number

- * Airport of destination

- * Airport of departure

- * Total number of pieces

- * House air way bill number, if any

e) International hazard warning signs

These are used to indicate fragile, poisonous, no hooks, keep dry, keep cool at °C, combustible etc.. The labels are available from airports for air shipments.

Additional compulsory information may need to appear, i.e. any warnings required by law, because of the nature of the goods or simply required by caution for proper handling.

It should be kept in mind that the physical handling in warehouse sheds is often done by unskilled or illiterate workers unable to read the European alphabet. Indications are therefore preferable as symbols such as broken glass for fragile items, or arrows for a package to be kept upright.

QUALITY INSPECTION SERVICE

General

When purchases are made from a number of supply sources, it may be necessary to ascertain that the goods meet the required specifications, arrive in good condition and perform to expectations.

For this reason, quality inspection service is often ordered from specialized companies complementing supply contracts for goods.

Available services include:

a) Endorsement of supplier's capability

For large-scale contracts an additional appraisal of supplier's capability can be undertaken in order to assess in depth, the suppliers ability to supply goods to the required standard, their capacity to supply, and the effectiveness of the quality control systems used by them.

b) Protection of purchased goods/equipment

In order to minimize the risk of the goods or equipment proving inadequate when received, or quality not up to the mark, the following services can be ordered prior to delivery:

- * Verification of conformity to standard specifications
- * Check for quantity and packaging
- * Provision of an inspection report, including a final inspection certificate.

Terms of reference governing the mandate of inspecting agencies

Terms governing the pre-dispatch inspection of goods consignments can be of a varied nature, simply because of the vast range of goods needing to be dealt with in the procurement operations of the UN system and affiliated organizations.

As a general rule, the following aspects are contained in the services offered by Inspecting Agencies:

- * Assessing the capability of remote and often unknown manufacturers before a contract is awarded
- * Advising on competitive tender adjudication
- * Assessing samples
- * Making critical stage manufacturing checks and witnessing final tests
- * Approving protection and packing for shipment
- * Helping to maintain quality of supply from one supplier to another
- * Issuing verification that the correct goods are dispatched

These services can make some important contributions toward the successful implementation of relief projects by:

- * Minimizing the risk of delays and rectification costs due to damaged or incorrect equipment arriving at site
- * Maximizing quality and reliability standards inherent in the specification

Given the wide range of supplies that are handled by the UN and affiliated organizations, it is doubtful that any one inspection organization would be capable of offering their services for all the items involved.

There are, however, a large number of individually specialized agencies that cover the entire range of

QUALITY INSPECTION SERVICE

required services. Typically, the requirements of inspection needs faced by the UN and affiliated organizations will tend to be concentrated in the aspects relating to pre-dispatch quality checks, quality assurance audits, in-process and commissioning surveillance and also packing and shipping verification.

The Inspecting Agency selected for a particular assignment will need clear instructions as to the scope of the service required. Most of the companies offering services in this field are happy to guide potential clients as to the extent of scrutiny, which is desirable or necessary in each particular instance. This would naturally depend on several factors such as the commodity being procured, the source of supply, past experience of the purchasing organization with the particular supplier etc..

The agreement with the Inspecting Agency would normally be in the form of a contract specifying the exact nature and scope of the quality checks at various stages during the contracted supply of the goods being purchased.

Charges for the services of the Inspecting Agencies can either be as "Lump sum for services rendered" or alternatively, as a percentage on the dispatch value of the goods under inspection.

Some guidelines for selection of Inspecting Agencies

From the list of the companies offering quality inspection services, it can be seen that these are situated in widely-dispersed locations, and in fact, tend to be specialized in the particular fields related to the predominant industrial and commercial activities of their regions.

The factors influencing the choice of company for a specific assignment of Quality Inspection include:

- * The background and experience profile offered by the company in the particular field relating to the commodity to be shipped.
- * The location of the Inspecting Agency with respect to the location of the supplier in question. This will have a bearing on the familiarity that the Inspecting Company would have with the local environment, and could influence the effectiveness of the service at that location.
- * The strength of the company's professional manpower.
- * The flexibility of response, and the degree of expert back-up available to field inspectors.
- * The access to communications within the company, in case of a remotely-located head office. This should be available for emergency consultations needed by field staff, which in turn affects the supply or shipment of the material in question.

SHIPPING

General considerations

The annual volume of equipment and supplies procured by the various agencies of the United Nations system adds up to some US \$ 3.5 billion a year. A considerable proportion of these goods are shipped from the place of procurement to their final destination.

Transport is the essential link between supplier and receiver. Even the best supplies are of no avail if they are not received when they are needed, where they are needed and in good condition. This necessitates a close collaboration between purchasing and shipping, since the journey involved, whether surface or air, may be an important factor, and because the cheapest price, FCA (or FOB) excluding shipment, may not be the cheapest landed cost.

Methods of dispatch

Some important aspects which need to be considered when selecting a method of transport are:

- * Speed
- * Reliability
- * Convenience
- * Flexibility
- * Customer communication

Various methods are available for transportation of goods between countries:

a) *Ocean freight*

- Conventional service

Cargo is transported by a "carrier" between a named port of shipment and a designated place of destination. The carrier issues a bill of lading (B/L) covering the consignment which is loaded into one of the holds of the carrying vessel (exceptionally on deck if the nature of the goods so requires).

- Container services

Cargo is transported in a 20 foot or 40 foot container. The use of containers is expanding constantly due to the considerable cost advantages available from the savings in loading/unloading time and for the shipper, also the reduced risk of loss, pilferage and damage, through a safer carriage. Easily stockable goods can be delivered with lighter packing, thus not only allowing savings here, but also on transportation costs because less weight/bulk means lower charges.

When a shipper does not have enough cargo to load a container to its full capacity, he may often find it an advantage to contact a forwarder running a "consolidated container service", i.e. using one container for several loads originating from various shippers. This is of the greatest interest in the case of shipments to land-locked countries, as the use of containers practically eliminates the risks of loss, pilferage and delays in the port of unloading for trans-shipment over land.

Bills of lading are issued direct by the carriers, in case of a "full container load (FCL)", or by the consolidator, in case of a "less than full container load (LCL)". In the last instance, the document issued is a "house" bill of lading for each individual load, the container itself being covered by a master B/L kept by the consolidator.

SHIPPING

- Chartering

When a consignment represents several thousand tons or cubic metres, the normal procedure is to charter a vessel or part of a vessel, after contacting possible carriers for quotations. A charter-party can be concluded for a specific load (tonnage), for a journey or for a determined length of time.

b) Rail or Road

For overland transportation, cargo can be sent by rail or road, depending on the availability of services and, of course, the type of cargo to dispatch. Bulk cargo such as coal, sand, cement etc., will normally travel by rail or barge wherever possible. Smaller and higher value consignments are more and more dispatched by road, either as full lorry-loads, with the advantage of door-to-door service, or in consolidated containers described before.

c) Air freight

The traditional method of air dispatch is to deliver a consignment covered by an individual airway bill to an air carrier (either direct or through a freight forwarder). The airway bill will specify the goods to be carried between two designated airports placed at the disposal of a designated consignee, against payment of the freight charges calculated in accordance with the rates applicable in their current tariff.

In the same manner as for surface transport, air consignments may be carried in consolidated services operated by freight forwarders, between main airports at advantageous rates. In case of large loads, it is possible to charter a full aircraft or arrange for what is called a split-charter if the load will not fill the aircraft to full capacity. Such a contract is placed subsequent to receipt of quotes from carriers, whether traditional airlines, their subsidiaries specializing in chartering or independent carriers.

d) Post

Where postal services are reliable, small parcels can often be more cheaply sent by air parcel post or even by surface parcel post, if the time element is not of primary importance. These, however, should always be sent registered or insured. The main consideration is the reliability of the postal service at the destination, in advising consignees of the arrival of parcels, which in most instances, have to be cleared through customs before they can be delivered.

e) Multimodal Transportation

This relatively recent method of transportation, is essentially the movement of one unit load by several methods of transportation under one document from origin to destination, without breaking-up the unit load.

It is the development of containerized traffic which has made this possible, as containers can travel from end to end without being opened / unloaded / reloaded during the course of the journey.

Companies which can offer multimodal transportation are usually large firms of forwarding agents who specialize in such traffic, as it obviously requires considerable organization for the smooth working of the chain of transport events involved here.

The advantage to those who make use of multimodal transportation is, that they have one document only for the whole operation and that the operator is legally responsible for a satisfactory performance by his own staff and by the agents or branches that he is employing.

SHIPPING

Selecting the most appropriate method of dispatch

Several factors need to be considered when planning the dispatch of an item, and they may be conflicting. Some important aspects are type of goods, journey involved, the time element, the cost element and safety considerations.

In some cases there is little choice: perishable goods will be sent by air, and large quantities of fertilizer, insecticides or sewer pipes will be sent by surface transport. Again, dangerous goods may not be allowed by airfreight. But in many instances there is a wide flexibility as to the choice of method of transportation.

Origin and destination determine distance and can decide the type of transportation required. Surface shipment may be logical in certain cases while airfreight might be required in others.

In emergencies, the initial top priority is the delivery of supplies within the shortest possible time. Subsequent follow up supplies will however often present a range of possibilities requiring some consideration to arrive at the best choice of transportation.

Parties involved in the chain of transportation

There are several parties involved in the process of transportation of supplies from the point of origin to the designated destination. These include the following:

a) Carriers

Inland carriers are those who take charge of the consignment at the supplier's premises, carry and deliver it to the specified warehouse, berth, wharf or airport of departure. At destinations, inland carriers may be required to transport consignments from the place of arrival to their final destination.

Overseas carriers are either steamship or airline companies. A shipment may require transportation by one or several carriers if transshipments are involved.

b) Forwarding Agents

Known also as freight forwarders, freight brokers, transit agents, and who also may act as clearing agents or customs brokers. In most cases buyers and sellers rely on the services of specialized firms for shipment and processing of customs formalities for their cargos. The role of the forwarding agent is to monitor shipping from the moment cargo becomes available. At destination, forwarders may be appointed to retrieve cargo, arrange for its clearance through customs, and for its delivery or on-forwarding

c) Dock Authorities

Consignments will be kept in the jurisdiction of port/airport authorities pending shipment or pending clearance and retrieval at destination.

d) Customs Authorities

Cargo imported or exported from one country into another needs customs clearance. The functions of the customs authorities include controls to prevent illegal transactions. Documents need to be processed through the competent customs offices.

e) Insurers

By means of separate insurance policies or under contractual arrangements, insurance companies will hold all cargo covered against the hazards of transportation from origin to destination.

SHIPPING

Shipping documents

Certain basic documents are required for the carriage of cargo. Other documents are also needed by consignees and buyers to complete any transaction.

a) Ocean freight

The bill of lading (B/L), which is the document covering the carriage of goods by sea, is the authentic receipt delivered by a carrier, confirming that the goods therein specified have been loaded or taken in charge for loading on a designated vessel for carriage to a specified port. The original B/L is the title of property to the goods.

The B/L can be of the following types:

- Relating to parties

B/L to a named person or consignee - that person alone will be able to collect the goods at destination against presentation of the original B/L.

B/L to bearer - the holder is considered as the legal owner of the goods.

B/L to order - that is to the order of the shipper, who must endorse it first. Such a B/L can be endorsed by several persons successively, to transfer the title to the goods to successive parties.

- Relating to journey

Direct B/L - from port to port, without transshipment.

Through B/L - means that a transshipment is taking place along the journey. This can be either in a first port of unloading for transfer into another vessel serving the final destination, or in a port for overland on-forwarding, or again, from an inland origin for carriage to a port where shipment will take place.

In a through B/L, the cost of transshipment, the first and/or second freights are paid by the carrier and normally billed as a lump sum. Transshipment, however, is always effected at the risk of the owner of the goods.

These various features of Bs/L designating beneficiaries and routing, can combine their elements, and there can be, for instance, a direct B/L to order, or a through B/L to bearer.

- Forwarder B/L

In the case of multimodal transportation, one document only is issued and this is what is called a "house" B/L or also a FIATA B/L, if the document is prepared on forms emitted by FIATA (International Federation of Freight Forwarders Association). This document is in fact a through B/L, with the difference that it is not emitted by an ocean carrier but by a forwarding agent under his own name.

b) Rail - Road

Goods transported by rail between countries are covered by international "rail consignment notes". These documents are not negotiable, the cargo being placed at the disposal of the designated consignee, upon proof of identity. For road transportation, waybills are normally issued. For loads less than a full truck, consolidation is the rule.

SHIPPING

c) Air freight

The document covering the carriage of goods by airfreight is called an airway bill (AWB).

The AWB to air transportation is what the B/L is to ocean freight, with however, a fundamental difference: the AWB is not a negotiable document; it cannot be endorsed and is not a title of property to a cargo as such. There is no "original" AWB to be given to the consignee to enter into possession of the goods. The consignment is placed at the disposal of the stipulated consignee against proof of identity, a signed receipt, and payment of charges if any.

When airfreight consignments are sent by a joint-cargo service, the consolidator will issue an ordinary AWB to his agent at destination, covering the entire consignment, but issue a separate "house air waybill" (HAWB), for each individual lot. The agent will place the individual lots at the disposal of the various consignees designated on the house air waybills. As with Bs/L, all detailed information required to identify the consignee and the goods must appear on the AWB.

d) Post

A postal declaration giving the name and address of the consignee must be filled. A receipt is given by the postal authorities for all registered/insured parcels.

e) Supporting documentation

In addition to the basic transport documents, buyers and receivers may require some other forms:

- * Invoices and packing lists, essential to clear through customs and to tally the supplies received
- * Forwarder's receipt, to process suppliers' invoices for payment;
- * Certificate of origin, may be required by the customs, in the country of destination
- * Legalized invoices, may be required by the customs, in the country of destination
- * Consular invoices, may be required by the customs, in the country of destination
- * Declaration on dangerous or restricted cargo required by carriers before they will accept such items for transportation
- * Insurance certificates, as applicable
- * Veterinary certificates and
- * Certificates of analysis or of conformity in accordance with special conditions, which may be part of contracts.

In some special cases, additional certifications or mentions may need to appear on invoices or shipping documents. When this is required, forwarding agents will normally be able to deal directly themselves.

SHIPPING

INCOTERMS

To avoid conflicts and difficulties, buyers and suppliers must have a common understanding of the terms under which they trade. The mention of "INCOTERMS 1990" in a contract determines the obligations of both parties, and contributes to eliminate causes of disagreement. In some countries INCOTERMS have to be used by law, in others, they are recommended and could be judged to be legally binding in any dispute. There are 13 different terms, but in practice, commonly used terms in the UN system are as follows:

Any mode of transport including multimodal	EXW FCA CPT CIP	Ex Works (... named place) Free Carrier (... named place) Carriage Paid To (... named place) Carriage and Insurance Paid To (... named place of destination)
Air Transport	FCA	Free Carrier (... named place)
Maritime Transportation	FAS FOB CFR CIF	Free Alongside Ship (... named port of shipment) Free On Board (... named port of shipment) Cost and Freight (... named port of destination) Cost, Insurance and Freight (... named port of destination)

The detailed definitions of the above-listed terms may be referenced in INCOTERMS 1990, published by the International Chamber of Commerce in Paris.

The minimum responsibility for suppliers is "ex-works" (EXW), where the supplier has few obligations other than to make the goods available at the warehouse/factory gate.

The supplier wishing to manage the entire movement sells on "delivered duty paid" (DPP) terms.

On the whole, INCOTERMS tend towards minimum liability on the part of the supplier. It is for the buyer to ensure that the supplier's liabilities not in the rules are imported into the contract if he so desires.

When purchasing from a country which has strict exchange control regulations, it is always preferable to buy on a CPT/CFR basis, the main reason being that, in case of CIF, the settlement of potential claims against the insurance company in the country of the supplier is rather lengthy, as it normally requires the approval of exchange control authorities.

INSURANCE

General

It is normal practice to insure goods in transit. Briefly, the following reasons compel traders to contract transport insurance:

- * Protection against financial losses resulting from damages, pilferage and theft, breakage, non receipt of entire or part of a consignment and damage suffered by goods whilst in transit.
- * Protection against financial claims that can be made against the owner of goods on board a vessel in case of a "declared general average" (the goods themselves being undamaged).

It may be of interest to explain here the exact significance of the terms "particular average" and "general average":

- Particular average means damages sustained by goods only or by the ship only
- General average means the loss (jettison) and the expenditure, voluntarily incurred, to prevent the entire loss of a vessel and her cargo on board.

How to insure

a) Through suppliers

In case of contracts placed CIF or "freight and insurance extra at cost". The only advantage of this method is, that it relieves the buyer of the task of making the insurance arrangement. The disadvantages are many and often less coverage is obtained at much higher premium this way.

b) Self-insurance

This is when the buyer decides against insuring outside and chooses to bear the risks of transportation. This is quite a common practice for consignments of small value where the administrative work involved with any commercial insurance is not warranted.

c) Floating policy with an Insurance Company

This method is adopted by many commercial firms with a regular flow of shipments. A floating (or open) policy is the result of negotiation between parties. The larger the amount of business for the insurers, the better the terms they are prepared to offer. The consignees have the advantage in this case of dealing with the same insurance agents under the same terms and with a standardized method of reporting claims.

Insurance documents

Apart from the insurance policy itself, insurance documents are issued to cover consignments in transit. These documents include:

a) Insurance certificates

These are a furtherance of the policy issued to cover consignments in transit, to describe them, the journeys, the amounts covered, agents to contact at destination and other details relevant to cases.

Insurance certificates are signed by the underwriters and the original certificate is normally required in the set of documents to be presented to a bank for a transaction covered by a letter of credit. When not required for banking purposes, and to cut down on administrative work, certificates can be replaced by much simpler notices of insurance where only the agent to contact at destination need be added. This can be arranged by agreement between the holder of a floating policy and the underwriters.

INSURANCE

b) Survey reports

This is the document established by the insurance company's agents at destination, when consignments are received in bad order. Since survey reports are costly, they should be requested only when it is expected that the loss or damage will exceed the figure considered reasonable by the underwriters. The survey report will be the basis of settlement of an insurance claim and it can be accompanied by an estimate of repairs approved by the surveyor when applicable.

The fees levied by the surveyor for preparing his report are payable by the party who requested his services, but are reimbursable by the insurance company.

Insurance claims

Processing an insurance claim involves administrative work, correspondence and accounting. It is not worth putting this into motion to recover small amounts, and claims involving compensations under say, \$25 or \$ 50, for instance, can well be dropped. A minimum level should be determined by negotiation. There is a difference between processing an insurance claim and the provision of replacements. A small and inexpensive spare part may be essential and urgently needed, but its procurement should not be the subject of an insurance claim.

An agreement should be reached with the insurer as to the amount under which no survey will be required, a report signed by a designated official being deemed sufficient by the underwriters to take a claim into consideration. This arrangement however does not relieve the consignee of sending letters of claim to the responsible party.

The following documents are required to process claims:

- * Survey report or Senior Officer's report, according to the extent of damages
- * Estimates and/or invoices for the cost of repairs or for local purchase of replacement parts, whenever possible, approved by the surveyor to facilitate settlement
- * Copy of the invoice for the original shipment
- * Copy of claim letters to the responsible party and their answer
- * Short-landing certificates or certificate of loss when entire cargo is missing
- * Copies of invoices for replacement or spare parts which had to be procured and sent.

Note: A successful insurance claim will not compensate for the inconvenience caused to the end-users by arrival of supplies in bad order therefore, it is advisable to consider safety before cost.

The use of container services, full load or consolidated services, is recommended whenever possible, as this offers the best protection.

Clear shipping instructions are necessary to secure the best possible handling.

Supplies, even by post parcel must always be sent with a timely notification and supporting documents being issued to the end-user.

FORWARDING ARRANGEMENTS

General

In most instances, UN purchasing and shipping can be described as a triangular operation. There is a buyer, a supplier, and a receiver. On many occasions, the three parties are in different countries, if not on different continents. Directing the movement of supplies, i.e. shipping, can be done in different ways.

Dispatch arrangements by the buyer

For surface shipments, this can be achieved only if the buyer is located in a port city, where the numerous contacts for booking consignments, arranging delivery and processing documents can be made by the buyer himself. It requires a well established shipping department and is justified only in case of a large flow of cargo to be sent from that particular port.

For airfreight traffic, direct contact with carriers without intervention of freight forwarders, can be more easily arranged. Here again, a proper shipping office, a delivery service to and from the airport, direct access to the customs for clearances in and out, as well as agreement with carriers for payment of air freight charges are required. And of course, stocks of airway bills from the various airlines are needed.

Dispatch arrangements by suppliers on behalf of the buyer

This is the basis of contracts placed C&F (CFR), CIF, or following instructions on orders such as "freight and shipping charges (most often including insurance) at additional cost". Orders placed on CFR, or CIF, terms mean that suppliers have quoted a price which included the value of the goods and all shipping cost up to port/airport of arrival (CFR) or the value of the goods, all shipping cost and insurance up to port/airport of arrival (CIF). Suppliers are therefore, responsible for the shipping arrangements, either directly themselves or through their own forwarders most of the time. This should in accordance with shipping instructions they may have received from the buyer, or according to their own best judgement if they have no specific instructions.

Dispatch arrangement made through forwarding agents

Forwarding agents are the nearly unavoidable intermediaries whose work is to ship goods on behalf of their many principals. When a contract is "ex-works" or FOB, the choice of the forwarder lies with the buyer.

There is a difference whether a forwarding agent is selected by the supplier or buyer. A forwarder works for and is responsible to his principals, i.e. to those from whom he receives a mandate and who pay him for his services.

A forwarding agent appointed by a buyer is in fact the buyer's representative on the spot with the specific mandate to look after interests of his principals, the buyer, and not after the supplier's interest. This can be very important should an incident occur at the time of delivery. Forwarders appointed by buyers can also perform other functions such as:

- * Keeping in touch with suppliers and sending them reminders when orders are falling behind their delivery schedule.
- * Consolidating orders for joint dispatch, thus reducing overall cost of transportation and facilitating receipt of orders at destination by making one instead of several shipments.

TRANSPORTATION COSTS

General

The cost of transportation represents a significant proportion of the total cost and time involved in getting a given item of emergency relief to its intended destination. In this context, it is important to be able to identify the options available in any given situation, so that the "most optimal" solution to a specific need can be met quickly and conveniently.

When purchases are made from a number of supply sources and require to be delivered to some common point of dispatch for forwarding to one destination, it would usually involve transshipment of sections of the eventual whole consignment. The transshipped sections may use different modes of transportation to reach the common point of consolidation of the whole shipment.

Some cost comparisons

It is important to remember that the cheapest mode of transport does not necessarily give the lowest landed cost at site. In fact, in some instances it is seen that air freight can work out to be the cheapest form of transportation overall. This can sometimes be the case when supplies need to be delivered to inland locations from sea ports and can require additional handling for maybe two or more transfers between different modes of transportation to the eventual end-users.

As a general rule however, air freight will be more expensive than other options; often, the cost of air freight is found to be almost double that of sea freight. However air freight can still be preferable where there is significant risk of damage to delicate or fragile cargo, or where the time element is of over-riding importance.

REFERENCES

- AICF, L'eau et l'assainissement dans les centres nutritionnels, 1993.
- DHA, UNDRO/DHA News, 1990 to 1993.
- Edward Clay, Food Aid Reconsidered, Assessing the Impact on Third World Countries, Frank Cass, London, 1991.
- FAO, Food Aid For Development, Rome, 1985.
- Grundfoss, Domestic Water Supply, 1988.
- GTZ, Manual on the Prevention of Post-harvest Grain Losses, Eschborn, Germany, 1990.
- Hans Singer, John Wood, Tony Jennings, Food Aid, The Challenge and the Opportunity, Clarendon Press, Oxford, 1987.
- ILO, Equipment Planning Guide, Foundry, 1987.
Equipment Planning Guide, Carpentry and Joinery, 1982.
Equipment Planning Guide, Masonry and Related Occupations, 1986.
Equipment Planning Guide, Forestry, 1980.
- International Trade Centre (ITC), UNCTAD/GATT, Import Management, Guide No. 4, Maritime Transportation, Guidelines for Importers, 1994.
Import Management, Guide No. 12, Port and Customs Clearance, 1988.
Import Management, Guide No. 14, Guide on Cargo Insurance for Importers, 1989.
- IRC, Handpumps, 1988
- Ken Darrow and Mike Saxenian, Appropriate Technology Sourcebook, 1993.
- Ministry of Foreign Affairs, New Zealand, Food Aid Problems and Possibilities, New Zealand, 1986.
- MSF, Catalogue des Articles, 1991.
Technicien Sanitaire, 1992.
Kits & Emergency Items Guide, 1994.
Logistics items catalogue, 1994.
- MSF/HCR, Guidelines for the Use of Disinfectants, 1993.
- PHLS, Chemical Disinfection in Hospitals, 1984.
- Raymond A. Kulwiec, Materials Handling Handbook, 1985.
- Statens Livsmedelverk, Livsmedelstabeller, Sweden, 1992
- UNDP/IAPSO, UNCCS Thesaurus, 1994.
Power generators, May 1994.

REFERENCES

UNDP/IAPSO, Shipping Guide, January 1991.

UNHCR, UNHCR Guidelines for the Use of Imported Food Items in Selective Feeding Programmes, Geneva, 1987.

Water Manual for Refugee Situations, 1992.

First International Workshop on Improved Shelter Response and Environment for Refugees, 1993.

Handbook for Emergencies, 1982

UNICEF, Assignment Children, Vitamine A, New York, 1987.

Aqua Plus, 1988.

Assisting in Emergencies, 1986.

Copenhagen Warehouse Catalogue, 1993.

Warehouse Guide, 1992.

Waclaw Micuta, Modern Stoves for All, Intermediate Technology Publications Ltd., Geneva, 1985.

World Bank, Community Piped Water Supply Systems in Developing Countries, 1987.
Rural Water Supply Handpumps Projects.

World Bank/UNICEF, Terminology of Water Supply and Environmental Sanitation.

WFP/Natural Resource Institute, Food Storage Manual, Rome, 1992.

WHO, The Management of Nutritional Emergencies in Larger Populations, Revised Edition, 1992.

Public Health Action in Emergencies Caused by Epidemics, 1986.

Health Guidelines for the Use of Waste Water in Agriculture and Aquaculture, 1989

Guide to Sanitation in Natural Disasters, 1971.

A Guide to the Development of On-site Sanitation, 1992.

WHO/FAO, Handbook On Human Nutritional Requirements, Geneva, 1974.

WHO/LRC/RCS, Coping with Natural Disasters, The Role of Local Health Personnel and Community, 1989.

WHO/UNEP, Manual on Water and Sanitation for Health in Refugee Camps, 1991.

REFERENCES

- | | |
|---------------------------|--|
| BS 397:1:1989 | Primary batteries |
| BS 1010:2:1973 | Draw-off taps and stopvalves for water service |
| BS 2037:1990 | Specifications for portable aluminium ladders, steps, trestles and light weight stagings |
| BS 2054:1953 | Augers and Augers bits |
| BS 2629:1:1989 | Specifications for principal dimensions and tolerances |
| BS 2629:2:1970 | Recommendations for pallets for use in freight containers |
| BS 3300:1985 | Paraffin unflued space heater and cooking appliances |
| BS 3408:1992 | Tarpaulins |
| BS 4155:1986 | Specification for dimensions of pallet trucks |
| BS 4533:102.8:1990 | Luminaires - Specification for handlamps |
| BS 5129:1982 | Dimensions of bed blankets |
| BS 5257:1975 | Horizontal end-suction centrifugal pumps |
| BS 5480:1990 | Glass reinforced plastic (GRP) pipes |
| BS 5576:1985 | Safety features of camping tents, awnings etc. |
| BS 5639:1:1978 | Vocabulary for hook-on type fork arms |
| BS 5639:3:1978 | Recommendations for dimensions of fork arms |
| BS 5866:1:1990 | Blankets suitable for use in the public sector |
| BS 5866:2:1990 | Blankets suitable for use in the public sector |
| BS 5866:3:1990 | Blankets suitable for use in the public sector |
| BS 5866:4:1990 | Blankets suitable for use in the public sector |
| BS 6068:0:1988 | Water quality |
| BS 6316:1992 | Test pumping of water wells |
| BS 6341:1983 | Fabrics for camping tents |
| BS 6572:1985 | Blue PE pipes for below ground use for water |
| BS 6730:1986 | Black PE pipes for below ground use for water |
| BS 7022:1988 | Geophysical logging of boreholes for hydrogeo. |
| BS 7491:1:1991 | Glass fibre reinforced plast cisterns for water storage |
| BS 7491:2:1991 | Glass fibre reinforced plast cisterns for water storage |
| Codex Alimentarius | Abridged version |
| Codex Alimentarius | Volume one - General Requirements |
| Codex Alimentarius | Volume two - Pesticide Residues in Foods |
| Codex Alimentarius | Volume four - Food for Specisl Dietry uses |
| Codex Alimentarius | Volume seven - Cereals, Pulses (Legumes) and Derived Products |
| Codex Alimentarius | Volume eight - Fats and Oils |
| Codex Alimentarius | Volume nine - Fish and Fishery Products |
| Codex Alimentarius | Volume ten - Meat and Meat Products |
| Codex Alimentarius | Volume eleven - Sugar, Cocoa Products and Chocolate |
| Codex Alimentarius | Volume twelve - Milk and Milk Products |
| DIN 7940 | Campingzelte |
| DIN 7943/1 | Schlafsacke |
| DIN 7943/2 | Schlafsacke |
| DIN 19606 | Chlorinators for water treatment |
| EN 131-1:1993 | Ladders - Terms, types, functional size |
| EN 131-2:1993 | Ladders - Requirements, testing, marking |

REFERENCES

- EN 566:1992** Mountaineering equipment - *Slings* - Safety requirements and test method
EN 567:1992 Mountaineering equipment - *Rope clamps* - Safety requirements and test method
- ISO 28: volume 1** Pipes, fittings and valves, plastic products
ISO 161/1 Thermoplastics pipes for the transportation of fluid
ISO 445:1984 Pallets for materials handling
ISO 1836:1980 Short link chain for lifting purposes - Grade M (4), calibrated, for chain hoists and other lifting appliances
ISO 2163:1975 Industrial trucks - *Wheels and castors*
ISO 3077:1984 Short link chain for lifting purposes - Grade T (8), calibrated, for chain hoists and other lifting appliances
- ISO 3994** Plastics products - *Hose of Polymer reinforced*
ISO 5199 Technical specification for centrifugal pumps
ISO 5912 Camping tents - *Requirements and test methods*
ISO 5913 Camping tents - *Requirements and test methods*
ISO 7152 Camping tents - *Nomenclature*
ISO 7301:1988 Rice - *specification*
ISO 7555:1987 Soya beans - *specification*
ISO 7556:1987 Rape (colza) seeds with high erucic acid content - *specification*
ISO 7557:1988 Rape (colza) seeds with low erucic acid content - *specification*
ISO 7970:1989 Wheat - *specification*
ISO 8029 Plastics hose (*collapsible water hose*)
ISO 8426 Determining the derived capacity of hydraulic

INDEX

A

Aluminium phosphide, 138
Antenna, broadband, 19
Antenna, delta loop, 20
Automatic antenna tuner, 21

B

Bag, body, 153
Bag, jute, 143
Bag, paper, 144
Bag, plastic, 152
Ball bearing trolley, 187
Bean, dried, shelled, 110
Beef, corned, 127
Biscuits, 130
Biscuits, protein/high protein, 131
Blanket, high thermal resistance, 48
Blanket, low thermal resistance, 46
Blanket, medium thermal resistance, 47
Boat, inflatable, 200
Bromadiolone, 171
Bucket, plastic, 57
Bucket, steel, 57
Butter oil (dairy oil), 120

C

Cage truck, 195
Calcium hypochlorite, 165
Calcium hypochlorite, powder, 78
Cement, 158
Cheese, feta, 124
Chickpeas, 115
Chisel, 207
Chloramine, 165
Chlorinators, 81
Collection bin, plastic, 151
Corn Soya Blend (CSB), 107
Corn Soya Milk (CSM), 109
Coumatetratyl, 171
Crane, gantry, 187
Crowbar, 216
Cupboards, 203

D

Digging tool kit, 156
Dolly, 199
Drains and drain fittings, 179
Drum truck, 193

F

Family size temporary shelter, 38
Fenitrothion, 168
Fenthion, 169
Fish, canned, 129
Flour, maize (corn), 104
Flour, wheat, 103

Fog generator, 175
Food basket, 136
Forklift truck, light duty, 197
Forklift truck, medium duty, 198
Fumigation kit, 140
Fumigation sheet, 137

G

Gas mask, 140
Generator, 26
Gloves, working, 209
Gravity roller conveyor, 206
Grinding mill, manual, 142

H

Hammer, 207
Hammer mill, vertical/horizontal, 141
Hand saw, 212
Hand tools, carpentry, 159
Hand truck, 192
Hearing protector, 210
Heater, kerosene/diesel, 60
Helmet, safety, 210
Horse beans, 111
Hot plates, electric, 55
Hot plates, gas, 55
Hygiene kit, 166

I

Impregnated bednet, 178
INMARSAT, System A, 23
INMARSAT, System C, 24
INMARSAT, System M, 25
Iodized salt, 134

J

Jack, 190
Jerry can, collapsible, 56
Jute, polypropylene bag, 144

K

Kitchen set, family size, 51
Kitchen set, for 100 children, 53
Kitchen set, for 250 people, 52

L

Ladder, aluminium, 205
Lantern, kerosene, 58
Laundry soap, 164
Lead seal, 215
Leak detector, 140
Lentils, dried, shelled, 114
Lifejacket, 201
Lifting sling, 188
Log periodic antenna, 22

M

Magnesium phosphide, 138
Maize, white, 102
Malathion, 167
Male and female adaptors, 86
Margarine, 121
Mask, face, protective, 209
Materials handling tool kit, 207
Mattress, 50
Measuring tape, 140
Meat, canned, 128
Megaphone, hand-grip type, 9
Megaphone, shoulder-type, 9
Methyl bromide, 139
Milk, dried, skimmed, 122
Milk, dried, whole, 123
Milk, enriched, dried, skimmed, 125
Mobile centrifugal pump (high yield), 74
Mobile centrifugal pump (Medium yield), 73
Mosquito screen, 178

O

Oil, palm, 119
Oil, soya-bean, 117
Oil, sunflower, 118
Oil, rapeseed, 116
Overalls, boiler suits, dark blue cotton, 140

P

Packaging tape, 208
Pallet truck, manual, 196
Pasta and noodles, wheat, 105
Peas, whole, 112
Permethrin, 170
Pick axe, 156
Plastic container for foodstuff, 145
Platform truck, 194
Pliers, 207
Polypropylene bag, 143
Propoxur, 166
Protective clothes/accessories kit, 176
Protective goggles, 176
Public Address set, fixed installations, 10
Public Address set, mobile, 10
Pump tool set, 90
Pump, sludge, 155

Q

Quick pipe couplings, 85

INDEX

R

Radiotelex data transmission system, 18
Repacking tool kit, 208
Repeater station, VHF, 14
Respirator, safety, 176
Rice, husked, 100
Roller crowbar, 216
Ropes, 191
Rubber boot covers, 176
Rubber gloves, 176

S

Sand filtration plant, 79
Sanitarian's kit, 177
Saw, circular, 213
Scale, 204
Seal press, 215
Shampoo, 161
Shampoo, medicated, 161
Shoes, safety, 211
Shovel, 156
Sleeping bag, 49
Snip, 207
Snow chains for vehicles, 214
Soap, toilet, 160
Solar lighting kit, mobile, 59
Solar power supply kit, 27
Solvent cement for water pipes, 179
Sorghum, grain, 101
Spade, 156
Split peas, 113
Sprayer, handheld type, manual, 174
Sprayer, knapsack type, manual, 173
Squatting plate, 157
Stapler, 208
Steel reinforcing rod, 158
Storage rack, 202
Stove, kerosene, 54
Submersible borehole pump
(high yield), 72
Submersible borehole pump
(low yield), 70
Submersible borehole pump
(medium yield), 71
Sugar, white crystal, 132

T

Tap, water, self-closing, 88
Tarpaulin, reinforced, non-woven,
plastic, 36
Tarpaulin, reinforced, non-woven,
braided plastic, 37
Tarpaulin, woven plastic, 35
Tea, black, 133
Tensioner/sealer, 208
Tent repair kit, 45
Tents, ridge type for cold climate, 41

Tents, ridge type for tropical use, 39
Toilet paper, 160
Transceiver, HF, radio voice system, 16
Transreceiver, HF, transportable, 17
Transceiver, VHF, base station, 12
Transceiver, VHF, handheld, 11
Transceiver, VHF, vehicle, 13

U

UV treatment unit for water purification, 80
Utility tent, 43

V

Valve, water, ball, 88
Valve, water, check, 87
Valve, water, gate, sluice, 87
VHF field kit, 15

W

Warfarin, 172
Wash basin, metal, 163
Wash basin, plastic, 163
Washing tub, plastic, 164
Water collection point, 83
Water distribution pack, 89
Water pipes and fittings pack, 89
Water pipe, polyethylene, 84
Water pumping pack, 75
Water storage tank, collapsible,
reinforced plastic, 76
Water storage tank, steel, 77
Water system tool set, 91
Water testing kit, 69
Water treatment plant, 90
Wheat, 99
Wheat soya blend (WSB), 106
Wheat soya milk (WSM), 108
Wheelbarrow, 154
Winch, 189
Wire, galvanized, 157

Y

Yeast, dried, 135