

ECOLOGICAL ALTERNATIVES IN SANITATION

Proceedings from Sida Sanitation Workshop
Balingsholm, Sweden 6-9 August 1997

Library

IRC International Water
and Sanitation Centre
Tel.: +31 70 30 699 80
Fax: +31 70 25 085 94

Editors

Jan-Olof Drangert

Jennifer Bew

Uno Winblad

Publications on
Water Resources: No 9

Department for Natural Resources
and the Environment

Publications on Water Resources

This series covers issues on water resources from a development cooperation perspective. Sida's Department for Natural Resources and the Environment believes that the publications will be of interest to those involved in this field of work.

The document is a result of a Sida commissioned study but it does not necessarily represent Sida's policy. The views expressed are those of the author(s) and should not be attributed to Sida.

Copies may be obtained from:
Swedish International Development Cooperation Agency, Sida,
Department of Natural Resources and the Environment,
S-105 25 Stockholm, Sweden.
Telephone: +46 8 698 5100 Telefax: +46 8 698 5653

Foreword

Most cities in the world are short of water and many are subject to critical environmental degradation. Their peri-urban areas are among the worst polluted and disease ridden habitats of the world. Sewage discharges from centralised water-borne collection systems pollute surface waters and seepage from sewers, septic tanks and pit toilets pollute groundwater.

It is quite clear that conventional sanitation technology based on flush toilets, sewers, treatment and discharge cannot solve these problems in urban areas lacking the necessary resources in terms of water, money and institutional capacity.

The main purpose of the Sida Sanitation Workshop, held in Stockholm 6-9 August 1997, was to widen the range of policy options in sanitation by presenting and discussing ecological alternatives in urban sanitation with special reference to the possibility of reusing human excreta, particularly urine, for agricultural purposes.

The 50 participants from 22 countries analysed the basic problems of urban sanitation, discussed a variety of possible solutions, presented case studies from around the world and visited ecological sanitation project in the vicinity of Stockholm. The main papers from the Workshop are presented in this report. Other case studies are summarised here but can be made available in full upon request to Sida.

The preparations for the Workshop received strong support from a group of Swedish experts: Uno Winblad from the Sanres project, Thor-Axel Stenström from the National Institute for Infectious Disease Control, Jan-Olof Drangert from the University of Linköping and Håkan Jönsson from the Swedish University of Agricultural Sciences, Uppsala.

The findings of the Workshop were presented at the Stockholm Water Symposium the following week and are included in these Proceedings. The most important outcome of the Workshop is, however, the process which has been initiated in terms of stimulating a broader co-operation between professionals committed to new thinking in sanitation.

Stockholm in October 1997



Ingvar Andersson
Head of Africa Division,
Department of Natural Resources and the Environment

LIBRARY IRC
Box 170, 2509 AD THE HAGUE
Tel.: +31 70 30 689 80
Fax: +31 70 35 899 64
IRCODE: 14330

321.097 EC

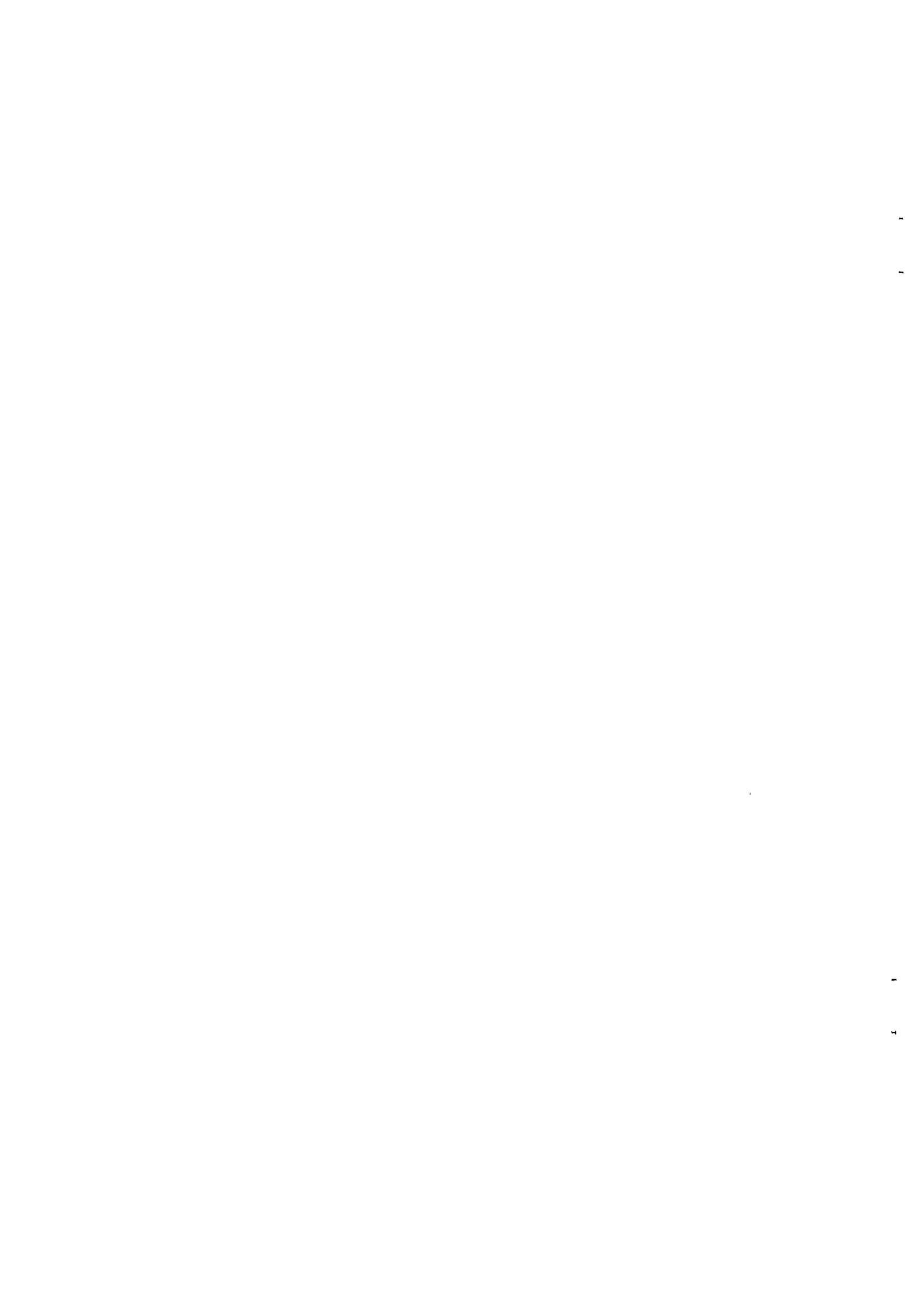

List of CONTENT

Foreword	i
1. Introductory speech by <i>Bo Göransson</i> , Director General, Sida	1
2. Important aspects of ecological sanitation	
2.1. Ecological sanitation - A global overview, by <i>Uno Winblad</i>	3
2.2. Ecological sanitation in Sweden - Evaluations, by <i>Per-Arne Malmqvist</i>	7
2.3. Assessment of sanitation systems and reuse of urine, by <i>Håkan Jönsson</i>	11
2.4. Disease control, by <i>Thor Axel Stenström</i>	23
2.5. Perceptions, urine blindness and urban agriculture, by <i>Jan-Olof Drangert</i>	29
2.6. Institutional and financial consequences of sanitation, by <i>Jorge Vargas</i>	39
3. Case studies from various countries and projects	
3.1. Dry sanitation in Morelos, Mexico, by <i>George Anna Clark</i>	45
3.2. El Salvador experience with dry sanitation, by <i>Jean Gough</i>	53
3.3. Zero-discharge sanitation for Pacific islands, by <i>Dave Rapaport</i>	59
3.4. Nightsoil collection and treatment in Japan, by <i>Saburo Matsui</i>	65
3.5. Some notes from the sites of the field visits	75
4. Workshop Resolution and summary of working group deliberations	
4.1. Summary of the group-work sessions	79
4.2. Resolution from the Sida workshop	81
5. Abstracts of background papers submitted to the workshop	
5.1. Latrines and use of human excreta in China, by <i>Pan Shungchang</i> et al.	83
5.2. Small-scale high-temperature composting, by <i>Wang Junqi</i> et al.	83
5.3. Sanitary evaluation of rural double-pit dry latrines, by <i>Wang Junqi</i> et al.	84
5.4. Environmental health development in China, by <i>Jicheng Dong</i>	84
5.5. Sanitation in Bolivia, by <i>Enrique Torrico</i>	85
5.6. Report on wastewater management in Botswana, by <i>O.M. Serumola</i>	86
5.7. Environmental sanitation in El Salvador, by <i>Rafael Mejia</i>	87
5.8. Environmental sanitation in Namibia, by <i>Ben van der Merwe</i>	87
5.9. Vietnam environmental sanitation: status and solutions, by <i>Pham Song</i>	88
5.10. Urban sanitation in Maharashtra, India, by <i>Nandita Kapadia-Kundu</i>	88
5.11. Environmental sanitation in the republic of South Africa, by <i>Aussie Austen</i>	89
Appendices	
1. Programme of the workshop	91
2. List of participants and their addresses	93

INTRODUCTORY SPEECH

*Bo Göransson,
Director General, Sida*

Introduction - the problem

In an era when we put people on the moon, transplant hearts and communicate instantly around the world, we are still unable to manage our own waste. At least half the population of the world has no access to proper sanitation. The present trend is that the number of unserved people is increasing. What we are doing today does not even keep up with the population increase. This indicates that there is something seriously wrong with our present approaches.

For the past 100 years the sewerred WC has been regarded as the ideal. But it is not:

- It uses a lot of water. Each one of us is flushing away something like 15,000 litres per year.
- It pollutes our groundwater, streams, lakes and coastal seas.
- It is extremely costly both to install and to run.
- It wastes valuable nutrients that we need in agriculture to secure our food supply.

We all know this; why then do we continue to plan for more and larger sewage systems? In water- and money-poor countries as well as in better-off countries? Because we have no alternatives! At least that is what many people think, professionals as well as politicians and the general public. Fortunately alternatives are emerging, and for several years it has been part of Sida policy to support the development of such alternatives.

In Sweden more and more citizens are questioning the sustainability of present technologies. Alternative systems based on ecological principles are developed and tested. You will visit some of these projects during this workshop and I hope this will challenge and stimulate sanitation development in your own countries.

Sida's views on poverty and the environment

Ever since 1962 the prime goal of Swedish development assistance has been to improve the living conditions of poor people. One of the six overall development cooperation goals laid down by the Swedish Parliament is the sustainable use of natural resources and the protection of the environment.

Sida's Policy on Sustainable Development gives priority to eight specific areas for support, of which five are very relevant to sanitation: the urban environment, water resources, sustainable use of land, capacity development, NGOs and civil society. In Sida's perspective lack of sanitation is one of the major environmental problems especially in poor rural and urban areas.

Long-term food security is another issue of prime concern to Sida. There is an urgent need for improved productivity in agriculture to cater for an ever-increasing population. From a sustainability point of view we more and more question 'modern' farming systems based on chemical fertilisers and pesticides. We also see a decline in soil fertility in some parts of the world, especially Africa. Today nutrients are transported from agricultural land to towns and cities and never recycled. Alternative sanitation methods, based on the 'don't mix' principle, could provide an answer.

Why Sida is arranging this Sanitation Workshop

Sweden has for the past 30 years given high priority to water supply projects in development cooperation. Improved sanitation and hygiene education has gradually been integrated into these projects and sanitation is now seen as a component as important as water. But the success of sanitation has been very limited, with few exceptions. There is a need for a rethink, a need to raise the status of sanitation and a need for new approaches, techniques and methods. The Stockholm Water Symposia have, over the past six years, touched on the problem of sanitation, but it has always been a minor issue. Sida last year therefore decided to arrange a workshop entirely devoted to new ideas in sanitation. That is why we are gathered here today: 50 carefully selected professionals from 22 countries.

What Sida expects from the Workshop

The theme of this workshop is 'Ecological alternatives in urban sanitation'. We expect this workshop:

- ◆ to take a holistic view of sanitation, including its relation to the health of the environment, to human wellbeing, to food production, to employment and to economic development;
- ◆ to explore the concept of ecological sanitation;
- ◆ to turn its findings into a statement that can serve as an input to next week's Water Symposium.

I wish you an interesting workshop during these three intensive days and hope you bring new knowledge back to colleagues, decision-makers and mass media in your respective countries.

Chapter 2

Important aspects of ecological sanitation

2.1. ECOLOGICAL SANITATION - A GLOBAL OVERVIEW

*Uno Winblad, Architect/Planner, WKAB, Pataholm 5503, S-384 92 ÅLEM, Sweden
(uno.win@wkab.se)*

Introduction

There are basically three ways in which we can manage human excreta at the household level: 'drop-&-store', 'flush-&-discharge', and 'sanitize-&-reuse'.

Drop-&-store is based on safe storage of the material containing pathogenic organisms. The device in this system is a pit toilet.



The system is simple, easy to understand and to use, and accepts any kind of anal cleansing material. But it cannot be used everywhere: it is unsuitable where we cannot dig a deep pit (because of rocky soil, soft sand, high groundwater table or lack of space) and in areas where there is periodic flooding. The pit toilet is malodorous, breeds flies, and may harbour mosquitoes. Valuable nutrients are lost and the groundwater may be contaminated. Basically it is a bottom-of-the-garden system, unsuitable for in-house application, high-standard housing and crowded conditions.

Flush-&-discharge is based on dilution and removal of the human excreta. The device is a WC connected to a sewage system.

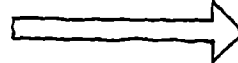

Those who can afford it and have access to water for flushing often regard flush-and-discharge as the ideal system. It can be installed indoors, on any floor and at any population density. It has a high status, is generally regarded as the ideal solution and is promoted in cities and towns around the world, even in poor countries where people cannot afford it and in arid areas where there is hardly enough water for drinking. (The drawbacks of flush-&-discharge systems are outlined on pp 3-5 of the paper 'Towards an ecological approach to sanitation' distributed to the workshop participants.)

Sanitize-&-reuse systems are based on accelerated pathogen destruction through dehydration and/or composting. The device is either a dehydrating toilet or a composting toilet.

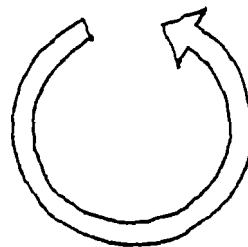

We may also call sanitize-&-reuse systems 'ecological sanitation' because they are based on fundamental ecological principles: zero pollution, water conservation and recycling. Ecological sanitation systems are relatively unknown outside East Asia and many attempts to introduce them in other parts of the world have failed because of lack of knowledge of the principles involved and the design and management options available.

Global overview

The purpose of this talk is to present a number of ecological sanitation systems in use around the world. I have divided these into two categories, dehydration and decomposition, and into two subgroups, urine diversion and no urine diversion.

Dehydration means that the humidity of the contents of the vault is brought down to below 20%. For effective decomposition humidity must be kept above 60%. In a dehydrating system pathogens are destroyed by depriving them of water and by increasing the pH above tolerable levels. Users help the process by adding dry materials and lime (or ash) as part of routine management. The humidity interval of 20-60% should be avoided, because it results in incomplete dehydration, slow and malodorous decomposition and fly breeding. Instead, it provides the perfect conditions for reproducing harmful organisms that produce unpleasant odours.

Dehydration vs decomposition

20%<----->60%
 (dehydration) (microorganisms and odours flourish) (decomposition)

Examples of ecological sanitation systems:

	<i>Urine diversion</i>	<i>No urine diversion</i>
Dehydration	long-drop (Yemen) 'WM Ekologen' (Sweden) twin chamber (Vietnam) twin chamber (Mexico) solar heated (El Salvador)	earth toilet, Ladakh (India)
Composting	no-cost toilet (China) solar heated (Mexico) multi-unit (Sweden)	'Clivus Multrum' (Sweden) solar heated (Ecuador) CCD (South Pacific)

Conclusions

Within the overall concept of ecological sanitation there is a range of options: for rich as well as poor communities, for urban as well as rural locations, for humid as well as dry climates and for a variety of cultures.

There is ample proof that the concept of sanitize-and-reuse does work, and that ecological sanitation systems, when properly managed, do function very well.

The three main prerequisites for the successful introduction and adoption of ecological sanitation are:

- ◆ those who plan, design, build and operate fully understand the basic principles involved;
- ◆ the system must be adapted to local conditions;
- ◆ the users must be fully involved in implementation and operation.

References

- Black (1994). *Mega-slums: the coming sanitary crisis*. WaterAid, London.
- Dudley, E. (1993). *The critical villager - beyond community participation*. Routledge, London.
- Goodland, R. and Rockefeller, A. (1996). *What is environmental sustainability in sanitation?* UNEP-IETC Newsletter, Summer 1996, Nairobi.
- Liljencrants, A. (1996). *Options to deal with a resource turned into a problem - critical review of dry and wet treatment of human excreta*. Thesis, Dept of Systems Ecology, University of Stockholm.
- Niemczynowicz, J. (1994). New aspects of urban drainage and pollution reduction towards sustainability. *Wat.Sci.Tech.* Vol 30, No 5, pp 269-277
- Rapaport, D. (1995). *Sewage pollution in Pacific island countries and how to prevent it*. Centre for Clean Development, Eugene, Oregon.
- Winblad, U. and Kilama, W. (1985). *Sanitation without water*. Macmillan, London.
- Winblad, U. (1996). Towards an ecological approach to sanitation. Publications on *Water Resources* No 5, Sida, Stockholm
- Wolgast, M. (1993) *Rena vatten - om tankar i kretslopp*. Creanom HB, Uppsala (in Swedish).

ECOLOGICAL SANITATION IN SWEDEN - EVALUATION

Per-Arne Malmqvist, Assoc. Professor, SWECO and VBB Viak, Box 2203, S-403 14 Göteborg, Sweden (pmt@vbb.se) and Luleå University of Technology, Division of Sanitary Engineering, S-97187 Luleå, Sweden

Background

In Sweden a number of 'eco-villages' were constructed during the 1990s using urine-separating wastewater systems. Recently some larger domestic houses have also been equipped with urine-separating toilets. The reasons for the interest in separating systems are mainly that:

- farmers or the agricultural industry do not accept sewage sludge on their farmland owing to the (verified or suspected) content of heavy metals and harmful organic substances;
- the sludge from the treatment plants utilises the contents of nitrogen and potassium to only a minor degree, even if the sludge is used for fertilising.

Reactions from municipal water and wastewater works have mostly been negative, and a considerable number of arguments have been raised against urine separation. A common attitude is that the system may work and be useful in sparsely built-up areas, but it is not suitable for the densely populated city.

Thus, the evaluations referred to below emphasize the densely populated city, where the problems and the potential are anticipated to be much greater.

Evaluation

Among the quantitative evaluation methods dealt with in this paper are:

- ◆ *Pragmatic methods such as 'analysis of direction' and others.* In several studies of alternative wastewater systems in Sweden during the last few years simple models have been used. These have in common that alternative systems are compared with each other, and with a set of criteria developed at the start of the analysis. Often these have been divided into main criteria (health requirements, flows of phosphorus and nitrogen, use and recovery of energy, discharges to receiving waters, investment and annual costs) and secondary criteria (various).
- ◆ *Life cycle assessment.* Life cycle assessment (LCA) is a method for analysis and assessment of the environmental impact of a material, product or services throughout its entire life cycle. A life cycle includes raw material extraction, processing, transportation, manufacturing, distribution, use, reuse, maintenance, recycling and waste treatment. LCAs are often comparative studies, e.g. comparisons of different products performing the same function, different process alternatives or different waste handling alternatives.
- ◆ *Environmental impact assessment (EIA)* EIA aims to serve as a decision support on different levels. The two most common applications are proposed projects (e.g. construction or changes in wastewater systems) and municipal planning. There is also a close connection between EIA and legislation.

Other evaluation methods, such as mass balances, ORWARE, exergy analysis and others, will not be dealt with here.

All quantitative evaluation methods have considerable elements of subjective values integrated in the method. Also, the limits of the systems studied are crucial to the results of the study. If only the municipal wastewater system is studied, one result may be obtained, but a totally different result may be obtained if an enlarged system is studied, including the provision of drinking water and food. Further, the limits for the associated energy system studied are very important.

Case study: the Eco-Guide project

The aim of the Eco-Guide project has been to develop and apply planning and evaluation tools for wastewater systems. In the project two different urban areas were studied: Bergsjön, a suburb of 13,000 inhabitants in Göteborg, and Hamburgsund, a small coastal village of 1100 inhabitants. In each area three different wastewater systems were studied: the existing system with conventional piping and treatment, a local alternative with sand filter beds and wetlands, and a system where wastewater is separated into urine, faeces and grey water. The different wastewater systems have been compared and evaluated using different approaches: analysis of direction, environmental impact assessment and life cycle assessment. Conclusions were drawn concerning the environmental effects of the chosen system and the application of different evaluation methods.

Concerning the environmental effects the separating wastewater system turned out to be the best choice both in Bergsjön and in Hamburgsund. Discharges of nutrients and polluting substances to air, water and land were minimised and the nutrients were recycled. From an energy point of view the existing system in Bergsjön was favourable owing to the recovery of heat and the production of biogas. In Hamburgsund there were no economical or technical prerequisites for energy recovery. The investment costs per capita were lower in the existing system in Bergsjön than in the alternative systems. The costs of operation were, on the contrary, lower in the alternative systems. In Hamburgsund the costs for both investment and operation were lowest in the local wastewater alternative.

The results are to a great extent dependent on the choice of area to be studied and the chosen technical solutions. However, some general conclusions were drawn.

- * Importance of the scale. Large wastewater systems (like Bergsjön) use less energy per capita than small systems (like Hamburgsund). Investment and operation costs are also lower in a large-scale system.
- * Importance of use of energy. Recovery of energy is an important factor for environmental considerations. Heat pumps, for example, use the large amounts of heat in wastewater. Energy consumption during the operational phase is larger than that for the manufacturing of components in the wastewater system (investment phase). The energy use for investments is, however, not negligible when studying systems with many components.

Within the project three evaluation methods have been compared. An LCA is applicable especially when studying energy use and environmental impact on a global level. An EIA is useful when describing environmental impact on a local level. The results from the simplified analysis of direction produced similar results to the more comprehensive evaluation methods.

Case study: Hammarby Sjöstad

Hammarby Sea Town is now being planned as a living area for about 15,000 people. The environmental requirements have been set at a high level. The environmental goal for the area is to be 'twice as good' as the ambitious environmental plan for Stockholm in general. In order to achieve this goal, alternative systems have been studied for the handling of wastewater and the solid waste from households.

The selected wastewater systems have been evaluated using one set of main criteria and one set of supplementary criteria. The main criteria used were:

- Hygiene
- Energy consumption during the operational phase
- Investment and operations cost
- Discharges and utilisation of phosphorus
- Discharges and utilisation of nitrogen.

The criterion 'hygiene' is assessed as a restriction: none of the studied systems must create any hygienic risk to human beings.

The energy criterion has been assessed from an exergy point of view, that is, fossil fuels, electricity and heat have been studied separately. The energy consumption during the investment phase has been considered negligible compared to the operations phase.

Among the supplementary criteria were the following:

- Social aspects. How will the inhabitants accept and use different installations in the household? What impact will alternative, 'ecological' systems have on the behaviour of the inhabitants to make them more environmentally conscious?
- Organisation. Who will own and operate different parts of the system? What complications does a split responsibility create?
- Operation and robustness. What kind of operational difficulties may arise? Are the decentralised, alternative systems more or less robust than centralised, conventional ones?
- Discharge of harmful substances such as heavy metals and organic substances to water bodies and soil.
- Acceptance by farmers. Will separated wastewater fractions or composted household organic wastes be more or less accepted by farmers and their cooperative companies?

Further criteria may be raised, such as impact from traffic (noise and air pollution), the development of new products for use in Sweden or for export, etc.

In the study four scenarios were investigated:

Scenario 0 The wastewater is conveyed to the central treatment plant in a conventional manner. The effluent from the treatment plant passes large heat pumps, which extract heat for the district heating system. The sludge is digested, producing biogas. The organic waste from the households is brought to the central incineration plant, producing heat for the district heating system.

Scenario 1 Separating toilets are installed in the households. Faeces and grey water are transported to the central treatment plant. The urine is pumped to a storage tank on the outskirts of the area, for subsequent transport to farmland. Transport distances are assumed to be 30 or 100 km (two cases) The organic solid waste is treated locally by composting, one reactor in each block (about 300 persons), for subsequent transport to farmland.

Scenario 2 Separating toilets and household waste disposers are installed. Organic waste and faeces are pumped directly to the digester at the central treatment plant. The grey water is brought to the inlet of the treatment plant. Urine is dealt with as in Scenario 1.

Scenario 3 Separating toilets and a vacuum system for the organic solid waste are installed. Organic waste and faeces are brought to a local digester or an aerobic stabilisation tank. The grey water is treated in a local treatment plant. Urine is dealt with as in Scenario 1. All fractions, except sludge from the grey water treatment, are transported to farmland.

In summary, the scenarios have been assessed according to a ranking system, where 1 is the most favourable and 4 the least favourable.

Criteria	Rank			
	<i>Scenario 0</i>	<i>Scenario 1</i>	<i>Scenario 2</i>	<i>Scenario 3</i>
<i>Main criteria:</i>				
Hygiene	1	2	2	2
Energy consumption	1	2	3	4
Cost	1	2	3	4
Use of phosphorus	2	1	1	3
Use of nitrogen	3	2	2	1
<i>Supplementary criteria</i>				
Social aspects	3	1	2	2
Organisation	1	2	2	2
Operation & robustness	1	2	3	4
Discharges of harmful substances	1	1	1	1
Acceptance by farmers	3	2	2	1

The values in the table should be summarised in order to achieve a 'total best' system. The final decision on the choice of system is a matter of evaluation, and should be done by the inhabitants-to-be, by politicians and by other groups, besides the person who made the evaluation. Most but not all of the detailed environmental goals for Hammarby Sjöstad are reached in Scenarios 0, 1 and 2.

Conclusions

- * Each wastewater system must be selected and designed on the basis of the local conditions. A solution that may be suitable in one place may not be so in another place.
- * The choice of evaluation method may influence the result of the evaluation. However, more important is the selection of limits for the system studied.
- * The final decision on the choice of wastewater system involves more players than the evaluator, and certainly comprises considerable elements of evaluation

2.3

ASSESSMENT OF SANITATION SYSTEMS AND REUSE OF URINE

Håkan Jönsson, Senior Lecturer, Department of Agricultural Engineering, Swedish University of Agricultural Sciences (hakan.jonsson@lt.slu.se)

Introduction

One of the most pressing issues during the next century is the development of sustainable systems for the handling and treatment of toilet wastes. The price paid for the present lack of such systems is high in terms of disease and death, effects on the environment and in wasted resources.

Currently, nearly 3,000 million people, i.e. approximately half of the world's population lack even the most basic sanitation (WHO, 1996). This is one of the main reasons that every year 1,500 million people are infected with intestinal worms, and that more than 3 million people die of diarrhoea (WHO, 1995).

The usual approach to the problem of lacking sanitation is the introduction of conventional flush-type sewage systems. Sewage contains large amounts of pathogens, organic substances and plant nutrients. Discharges of sewage cause major effects on many receiving waters: contamination by pathogens, floating impurities, primary oxygen depletion caused by large emissions of organic substances, and secondary oxygen depletion caused by the biological degradation of algae which has grown due to large emissions of phosphorus and/or nitrogen. These emissions can be drastically reduced, but not eliminated, by sophisticated and costly sewage treatment. Thus, the conventional sewage system can be described as a flush-and-discharge system. It uses large quantities of clean water (in many places a scarce resource) to dilute and transport small amounts of toilet wastes.

The reuse of plant nutrients (nitrogen, phosphorus, potassium etc.) in our human excreta is necessary for sustainable food production. These nutrients are provided by the soil to the plants which serve as our food. If they are removed from the soil without new nutrients being supplied, then the soil will eventually be depleted.

Humans produce urine and faeces, not sewage. The chemical, physical and hygienic characteristics of urine and faeces differ drastically and the two products need different types of treatment before they can be safely applied to arable land. Therefore, it is often easier to design a sustainable sanitation system if the urine and faeces are treated separately than if they are mixed.

Definition

This paper concerns separating systems. Urine and faeces leave the body separated. In source separating (urine separating) systems they are kept and handled separately. Such systems require source separating toilets.

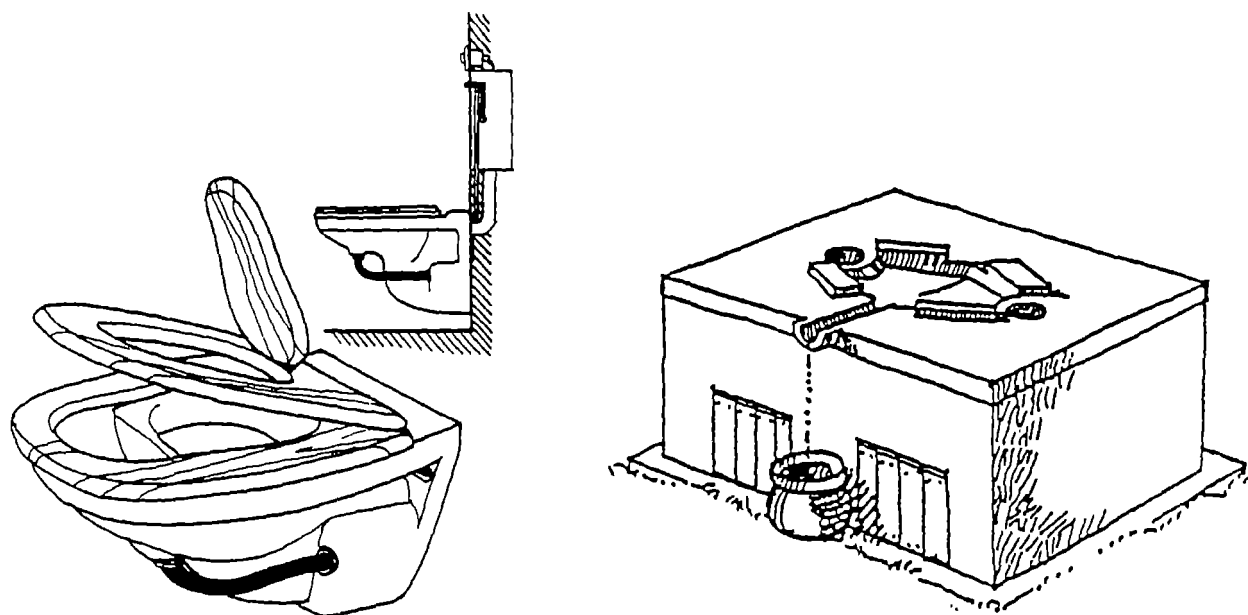

Fig. 1. A source-separating double-flush toilet is shown to the left. With this toilet both urine and faeces are flushed away with water, the urine requiring just a small amount of water (0.1-0.3 l/flush) and a storage tank, whereas the faeces are flushed away with the normal amount of water (in Sweden 4-8 l/flush). Usually the faeces are later mixed with grey water and treated in a sewage plant. An unflushed source separating toilet, a Vietnamese double vault dehydrating toilet, is shown to the right. The toilet is shown without superstructure. (From Winblad, 1997)

Urine and faeces

For most persons average weight gain is small during their lifetime. Therefore, we excrete essentially the same amount of plant nutrients as we eat. This depends on diet and thus differs between different persons as well as between different societies. The quantities given in this paper are based on the average Swedish diet and Swedish circumstances.

Table 1. Estimated Swedish averages for weight of and plant nutrient content in urine and faeces (SEPA, 1995a) as well as the distribution of these variables between urine and faeces

Parameter	Urine		Faeces		Total toilet waste	
	g/pers.day	%	g/pers.day	%	g/pers.day	%
Wet weight	900-1200	90	70-140	10	1000-1400	100
Dry substance	60 ^{a)}	63	35	37	95	100
Nitrogen	11.0	88	1.5	12	12.5	100
Phosphorus	1.0	67	0.5	33	1.5	100
Potassium	2.5	71	1.0	29	3.5	100

^{a)} A large proportion of this dry substance is rapidly biodegradable. Much of it already degrades in the sewage pipes.

Between 65 and 90% of the excreted nitrogen, phosphorus and potassium is estimated to be excreted in the urine (Table 1). Furthermore, the plant nutrients excreted in urine are found in chemical compounds which are easily accessible for plants. Initially 80-90% of the nitrogen is

found as urea (Orten & Neuhaus, 1982; Geigy Scientific Tables, 1981). This rapidly degrades to ammonium and carbon dioxide (Eqn. 1). In a measurement on a source separated sewage system in Stockholm, Sweden, Jönsson et al. (1997) found that 97.5% of the urine nitrogen was already in the form of ammonia when the urine entered the collection tank after an average pipe transport of just one or two hundred metres. This shows that urea degrades very rapidly, not only in conventional but also in source separating systems.

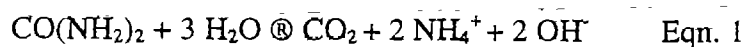

The urea degradation increases the pH value of the urine, from its normal slightly acid reaction (often pH around 6) when excreted (Kirchmann & Pettersson, 1995; Jönsson et al., 1996) to a value normally around 9 (Olsson, 1995; Kirchmann & Pettersson, 1995; Jönsson et al., 1997). The phosphorus in urine is in the form of phosphate and the potassium is in the form of ions (Kirchmann & Pettersson, 1995; Jönsson et al., 1996).

Many chemical fertilisers contain, or dissolve to, nitrogen in the form of ammonium, phosphorus in the form of phosphate and potassium in the form of ions. Thus, the fertilising effect of urine ought to be comparable to the application of the same amount of plant nutrients in the form of chemical fertilisers.

Naturally source separated urine is liquid, but a small amount of sediment rapidly forms. Therefore, the handling equipment has to be tolerant of small amounts of fast-settling suspended solids.

Faeces contain undigested fractions of food which contain plant nutrients. However, organically bound plant nutrients are not plant available: the undigested food residuals have to be degraded before their plant nutrients become available, and so the plant availability of the nutrients in the faeces is expected to be slower than that of the nutrients in the urine.

The low water content in faeces means that source separated faeces should be handled with equipment for solid handling. It also means that the risk of a leaching liquid appearing is small, and that only a small amount of water, 65 g/person and day according to Table 1, has to be evaporated to completely dehydrate the faeces.

System assessment

Which requirements should be put upon a sustainable sanitation system? These can be classified into four groups: hygiene, environmental impact, resource usage and socioeconomic parameters (SEPA, 1995b). Health protection is the main reason for developing good sanitation systems. This is also the main reason for the development and widespread use of the conventional flush-and-discharge sewage system.

Sewage contains large amounts of pathogens, organic substances, plant nutrients and different chemical substances, giving it large potential for environmental impact. Sometimes this can lead to an indirect threat to the health of the population (spoilt drinking water supply, destroyed fishing etc.).

Both directly and indirectly, a sewage system uses scarce resources. A conventional flush-and-discharge system, for example, directly uses water, energy, and often also treatment chemicals. To construct it building materials are needed, which have used scarce resources in production.

The socioeconomic parameters are often critical when assessing whether a sewage system can be realised or not. If it is too expensive, too unreliable or is socially unacceptable, then that system is not a realistic possibility, regardless of how good it is in other respects.

Preliminary assessment of three different sanitation systems

In this section a first preliminary assessment and comparison is made between three different sanitation systems.

System 1. An unflushed source separating system. The urine is accumulated in a collection tank. Then, for hygienic reasons, it is stored separately in a storage tank, with no new urine being added, before it is used as a fertiliser on arable land. The faeces are collected in a container, where they also receive a primary treatment: dehydration or uncontrolled composting. To ensure safety the faeces are given a secondary treatment. This is assumed to be controlled composting, but it could be controlled thermal sanitation (solar energy, or in connection with anaerobic digestion) or incineration.

System 2. A conventional water-based flush-and-discharge system. Urine and faeces are mixed and flushed away with water. This black water is mixed with grey water. The sewage is assumed either to be emitted completely untreated (which is the case for 95% of the sewage in the third world; World Resource Institute, 1992) or to be treated in an advanced sewage treatment plant.

System 3. A conventional drop-and-store pit toilet. Urine and faeces are dropped collectively in a pit where they are stored, for hygienic reasons. When the pit is full it is abandoned for a new one.

Hygiene

As hygiene is treated in depth in another paper only a few general remarks will be made. Faeces are heavily contaminated with pathogens. Most, if not all, intestinal pathogens use faeces as a main pathway for spreading.

Although not sterile the pathogen content of fresh urine is generally low, even though some pathogens are spread via urine. However, in many situations the main hygienic risk with source separated urine is the risk of faecal contamination, often stemming from persons with diarrhoea, i.e. sick persons. Thus, source separated urine should be treated as if heavily contaminated.

In system 1, the unflushed source separating system, all human excreta are collected and treated. The hygiene risk is local, since it emanates from the handling and reuse of the urine and faeces. With a properly functioning system and adequate secondary treatment no pathogens should be spread to the environment. The hygienic risk depends on the pathogen content of the source separated products when they are handled.

The survival in stored source separated urine of eight different pathogen and indicator organisms has been tested in the laboratory (Jönsson et al, 1996; Olsson, 1995). Most of the tested organisms died off rapidly, within a week, in stored urine with pH around 9; one organism died off slowly and two organisms, *Salmonella* phage 28B and *Clostridium perfringens*, were not affected at all during the experiment (approximately 70 days). The experiment also showed that the further away from neutral the pH, the higher the temperature and the less diluted the urine was, the more rapid was the die-off. Based on this experiment in Sweden, six months of separate storage is currently considered a sufficient secondary treatment and sanitation of source separated urine for its safe reuse as a fertiliser. The length of the separate storage period needed in other countries, with other pathogenic loads and other storage temperatures, has not yet been investigated.

One major advantage provided by the source separation in system 1 is that the really heavy pathogenic load is limited to the faeces, the weight and volume of which is limited to around 100 g/person and day. The special precautions needed, owing to the high pathogenic load, are simplified by the small weight and volume of the faeces. It is advantageous if the faeces have

been given a primary treatment and thus a primary sanitation, before they are first handled, i.e. before they are removed from the toilet. Dehydration and uncontrolled composting are two possible primary treatments. To achieve a high hygienic quality the faeces should also be given a secondary treatment, for example controlled composting or incineration.

In system 2, the conventional water-based flush-and-discharge system, the faeces and the urine are mixed with flush water and possibly also grey water and industrial wastewater. This increases the volume with high hygienic risk from 1.1 l/person (urine plus faeces) and day to between approximately 40 and 400 l/person and day. With this system the hygienic risk in the dwellings is low, as the sewage is flushed away. The risk emanates from leaking and overflowing sewage, from pathogens spread into the recipient water by the sewage emission and, when the sewage is treated in a sewage plant, from the handling and possible reuse of the sludge.

In system 3, the conventional drop-and-store pit toilet, the faeces and urine are mixed and stored in the pit. The hygienic protection is based on storing, or rather depositing, the excreta well away from humans, food and water. Thus, it is important that no pathogens should escape from the pit. However, lately it has been shown that pathogens might be spread by the infiltration of urine, which has seeped through faeces in the pit (Stenström, 1996)

Environmental effects

A sanitation system can pollute the surrounding environment via air and water. In system 1, the unflushed source separating system, all excreta are collected. The risk of any liquid leaching from the faeces should normally be small, as they are collected source separated. If the secondary treatment is controlled composting, leaching liquids might also arise at this step. If this occurs they should be collected and added to the process again, as a lot of water evaporates during composting.

Water emissions might also arise from the fertilised fields. However, if recycled toilet products were not used the fields would presumably be fertilised with some other agent. There is at present no reason to believe that water pollution from the fields will be greater when fertilised by adequately sanitised recycled toilet products than when fertilised in another way.

Water is evaporated in both the primary and the secondary treatment of the faeces. The faeces contain nitrogen, and part of this will be emitted as ammonia simultaneously with the evaporation of water. Ammonia is a serious air emission, since it is both eutrophication (fertilising) and acidifying. Based on the ratio between carbon and nitrogen in faeces, the ammonia emission when composting faeces can be estimated at around 50% (Kirchmann, 1985; Hargelius et al., 1997). Assuming that 10% of the urine is wrongly separated and ends up together with the faeces, the ammonia emission from the treatment and handling of the faeces can be roughly estimated at around 1.3 g/person and day.

Ammonia is also emitted from the urine collection and handling. The urea of the source separated urine is quickly degraded to ammonia and carbon dioxide (Eqn. 1). Simultaneously the pH increases to around 9 (Jönsson et al., 1997; Kirchmann & Pettersson, 1995; Olsson, 1995). When the pH is high, the potential for a large ammonia emission is high. This implies that source separated urine should be handled in closed systems (i.e. tanks, containers etc. with only minimum ventilation), and that the urine should be spread and rapidly mixed into the soil. If it is not possible to mix the urine into the soil, then the soil should be such that the urine rapidly infiltrates into it, since the pH and the potential ammonia emission both decrease as the urine comes into good contact with the soil.

The first measurements of ammonia emission after spreading source separated urine are being made in Sweden this summer, and no results are so far available. However, in experiments with pig urine (Rodhe & Johansson, 1996) the ammonia loss was very low when the urine was

spread and immediately mixed into the soil by harrowing. The loss was several times higher when the urine was spread in 10 cm high growing barley. It was 5% when urine was spread in bands between the rows of growing barley and 10% when the urine was broadcast over the barley. In the same experiment the ammonia loss when cattle urine was spread on pastures was very high, between 20 and 86%. This means that source separated urine should normally not be spread on pastures. If these measures are taken, it is estimated that the ammonia emission from the handling and spreading of source separated urine, at least under Swedish conditions, should be below 10% of nitrogen content or around 1 g/person and day (Hargelius et al., 1997).

Air pollution is also caused when fuels are used, for example to transport the toilet products to the fields. The quantity of these air emissions depend on the weight of the products transported and the distance. Since the toilet is unflushed the weight transported can be estimated at approximately 1100 g/person and day or 400 kg/person and day, 90% of which is urine. If the location for secondary treatment, separate storage for the urine and controlled composting for the faeces, is located either close to the fields to be fertilised or to the toilets, the transport distance can be kept to a minimum. The technology used by the system functions well also on a small scale. This helps to keep the transport distance at a minimum.

The emissions from the different systems are summarised in Table 2.

Table 2. Estimated water and air emissions from the three proposed sanitation systems

Variable	System 1 g/person & day	System 2 ^a g/person & day	System 3 ^b g/person & day
Water emissions			
BOD ₇	0	1-20	Often negligible
Nitrogen	0	6-13	6 ^b
Phosphorus	0	0.08-1.5	Often negligible
Air emissions			
Ammonia	2.3	0.6-0	6 ^b
Methane ^c	Negligible	Low - very high	Low - medium
Combustion Emissions (CO ₂ , NO _x , SO _x)	From transporting and handling 1.1 kg toilet products per person and day	From fertiliser production From handling 0 - 1 ^d kg sewage sludge per person and day From generating electricity to the sewage plant	From fertiliser production

^a The first figures give emissions when the sewage is treated, achieving 95% reduction of BOD (biological oxygen demand), 50% nitrogen reduction and 95% phosphorus reduction, and assuming that the dewatered (25% dry substance) anaerobically digested sewage sludge is recycled as fertiliser. The last figures assume no treatment or reduction at all.

^b The total nitrogen emissions are probably approximately 12 g/person and day. In the table 50% are assumed to be emitted to air and 50% to water.

^c The emission of methane is very difficult to estimate. The estimations are preliminary and studies of methane emission should be carried out.

^d The amount of sludge produced varies greatly depending on the process: 1 kg sludge (3-4% dry substance) has been calculated as being due to black water alone at large Swedish sewage plants. 1 kg raw sludge reduces to 0.1 kg or less if it is anaerobically digested and dewatered to 25% dry substance.

The water emissions from system 2, the conventional flush-and-discharge system, are great. If the sewage, like 95% of that in the third world (World Resource Institute, 1992), is emitted completely untreated, the water emissions for nitrogen can be estimated at 12.5, for phosphorus to 1.5 and for BOD at 20 g/person and day. In many environments emissions of this size will have large and unacceptable negative effects. The water emissions will be large even if the sewage is treated by an advanced and well functioning sewage treatment plant. Such a plant might reduce the nitrogen emissions by 50%, the phosphorus emissions by 95% (chemical precipitation is assumed) and BOD emissions by 95%. Even so, for nitrogen the water emissions would be 6, for phosphorus 0.08 and for BOD 1 g/person and day. If the population density is high and the recipient is small, these emissions will also have large negative environmental effects.

If the sewage is emitted untreated the environmental effects of the air emissions from the sewage system *per se* are probably normally negligible; however, the water recipient might emit methane, a potent greenhouse gas, owing to serious oxygen deficiency caused by the sewage emission. If the sewage is treated in an advanced treatment plant the risk of oxygen deficiency in the recipient is drastically reduced. Instead, methane emissions are generated by the handling of the sewage sludge. These emissions will be high or very high if the sludge is deposited on a landfill or somewhere else where it becomes anaerobic. They will be small if the sludge is recycled and used as a fertiliser, since agricultural soils are aerobic. On the other hand, if the sludge is used as a fertiliser, ammonia will be emitted. Under Swedish conditions this ammonia emission has been estimated at 0.6 g/person and day when recycling digested and dewatered sludge from the treatment of just black water. When the sludge is used as a fertiliser it has to be transported to the fields, and the fuel used for this transport generates air emissions. The mass of the generated sludge varies widely. Around 1 kg or more of raw sludge might be generated per person and day just from the black water. The mass to be handled can be reduced to below 0.1 kg/person and day if the sludge is digested and dewatered to 25% dry substance.

A properly functioning sewage plant uses energy, usually electrical. The production of this electricity generates air emissions, the quantity and quality of which depend on the power plant used. Such emissions are significant and it is important that they are included when evaluating the total environmental effect of a sewage system.

Water and air emissions from system 3, the conventional pit toilet, are hard to estimate as they depend on how much of the urine infiltrates into the soil and how much evaporates. However, only a minor fraction - perhaps 0.5 g/person and day - of the nitrogen will accumulate in the pit, since almost all organic material is eventually degraded and mineralised nitrogen is easily emitted to water and air. The other 12 g/person and day are emitted to air or water. The phosphorus and BOD content of the liquid leaching from the pit ought under most conditions to be negligible, if measured when the leaching liquid has passed through a few metres of soil.

In system 1 the recycled toilet products are used to fertilise crops. Neither system 2 nor system 3 normally delivers any fertilising products to sustain the arable soil. Thus, to equalise the systems and to maintain the productivity of the arable land, chemical fertilisers having the same effects as the toilet products recycled by system 1 have to be used when systems 2 and 3

are used. For the same fertilising effect approximately 10 g of nitrogen, 1.5 g of phosphorus and 3.5 g of potassium per person and day are needed as chemical fertilisers. The emissions from producing, distributing and spreading these chemical fertilisers should be added to the other emissions from systems 2 and 3.

Usage of scarce resources

Once established, system 1 uses few scarce resources. The main one is energy, which is used for transporting the recycled toilet products back to the fields, for spreading, and for turning and tending the compost used as secondary treatment of the faeces.

Nutrients are removed from the fields with the harvested crops. In sustainable agriculture the same amount of nutrients removed from a field should be returned to it. In Table 3 the nutrient content of the toilet products recycled by system 1 is compared to that of wheat and maize. It should be remembered that nutrients are also lost from the fields in ways other than with the harvested crop.

The fertilising effect of source separated urine, which contains the majority of the nutrients, seems from the few finished experiments to be almost as good as that of the corresponding amount of chemical fertilisers, provided that the ammonia emissions are kept low. So far only one pot experiment and one field experiment with cereals comparing the fertilising effect of human urine with that of chemical fertilisers have been completed. In addition, one field experiment with pig urine has been completed. In the pot experiment (Kirchmann & Pettersson, 1995) the uptake of urine nitrogen by barley harvested at the flowering stage was 42 and 22% at two application rates, and the uptake of ammonium nitrate nitrogen at the same application rates was 53 and 28% respectively. Kirchmann and Pettersson (1995) explained the lower uptake of urine nitrogen by higher gaseous losses of nitrogen (i.e. ammonia), 7 and 6%, from the urine pots than from the ammonium nitrate pots, which had losses of 0 and 2%, respectively. The utilisation of urine phosphorus was found to be 28% better than that of chemical fertiliser. The barley fertilised with urine derived 12.2% of the phosphorus from the fertiliser, whereas that fertilised with dipotassium hydrogen phosphate derived 9.1% from the fertiliser. In the field experiment by Johansson et al. (1997) the nitrogen effect of stored human urine on oats was compared to that of ammonium nitrate fertiliser at three different application rates. The human urine, which was surface spread and immediately harrowed into the ground, gave approximately the same yield as the corresponding amount of chemical fertiliser. Rodhe & Johansson (1996) compared the nitrogen effect on barley of pig urine with that of chemical fertiliser. Also in this field experiment the fertilising effect of urine was the same as that of the corresponding amount of chemical fertiliser.

Table 3. Content of nitrogen and phosphorus in the recycled toilet products from system 1 compared to the content in 162 kg of wheat and 153 kg of maize

Products	Nitrogen in kg	Phosphorus in kg
Recycled toilet products from system 1 per person and year	3.65	0.55
Wheat ^a , 162 kg	3.36	0.55
Maize ^a , 153 kg	2.44	0.55

^a Chemical analysis according to Eriksson et al. (1972)

Using the recycled toilet products as fertilisers saves chemical fertilisers containing almost the same amount of nutrients, and hence also the resources needed to produce, distribute and spread them. This requires that each system should deliver the equal amount of fertiliser to arable land. Systems 2 and 3 fulfil this requirement by using chemical fertilisers. The production of the required amounts of fertiliser is considered a necessary function of systems 2 and 3, and its resource usage is therefore included.

The soil cannot sustainably produce healthy, high-quality food if it accumulates heavy metals. The heavy metal content of the recycled toilet products is very small. Source separated urine contains less than 3.6 mg of cadmium per kilogram of phosphorus (Jönsson et al., 1997; Olsson, 1995) and the corresponding figure for source separated faeces is estimated to be 20 mg (SEPA, 1995a). Sweden has long had restrictions and fees in order to decrease the cadmium level in chemical fertilisers, but it is still much higher than in source separated urine. The average cadmium level in Swedish fertilisers in 1994/95 was about 26 mg/kg phosphorus (Eksvärd, pers. comm.), whereas a few years earlier it was 40-50 mg/kg phosphorus. Many fertilisers on the international market contain higher levels of cadmium.

To establish system 1, the unflushed source separating system, source separating toilets with collection containers, a secondary treatment facility and equipment for transport and spreading are needed. These need to be capable of dealing with 1-1.5 l urine and 0.1 kg faeces per person and day.

Table 4. Usage of some scarce resources. (The figures apply to Swedish conditions)

Resource:	<i>System 1</i>	<i>System 2</i>	<i>System 3</i>
Energy	For secondary treating, transporting and spreading 1.1 kg/person and day	For production of fertiliser (0.4 MJ/person and day) For pumping sewage (40-400 l/person and day), running sewage plant, and for handling sewage sludge (0-1 kg/person and day)	-
Water	-	For flushing toilet (50 l/person and day)	-
Fossil phosphorus	-	1.5 g/person and day (if no sewage sludge is recycled)	1.5 g/person and day
Fossil potassium	-	3.5 g/person and day	3.5 g/person and day
Infrastructure	Source separating toilets, secondary treatment facility and transporting and spreading equipment for 1.1 kg/person and day	Toilets, piping system for water and sewage, sewage plant, sludge treatment and reuse/disposal facility and equipment	Pit toilets

System 2, the conventional flush-and-discharge system, uses energy for pumping the sewage and, if equipped with a sewage plant, for running this. The energy usage varies depending on the construction and size of the plant.

System 2 uses water to flush the toilets. The Swedish Environmental Protection Agency (SEPA, 1995a) estimates flush water usage at 50 l/person and day. Swedish toilets use 4 (new) to 8 (old) litres per flush. To transport the sewage a piping system is needed; often also a piping system is needed to supply the water. To preserve the environment a sewage plant and sludge treatment facility are also needed. An additional function of system 2, compared to systems 1 and 3, is that grey water and industrial wastewater can often be piped and treated together with the toilet waste. However, this is often also the reason for the high or very high heavy metal concentration in sewage sludge, which makes it unfit for use as an agricultural fertiliser.

If no sewage sludge is recycled, chemical fertilisers containing 10 g of nitrogen, 1.5 g of phosphorus and 3.5 g of potassium need to be produced per person and day when comparing system 2 with system 1. Besides using fossil resources of phosphorus and potassium, the production uses energy, more than 0.4 MJ/person and day (37 MJ/kg nitrogen, 19 MJ/kg phosphorus and 7.5 MJ/kg potassium; Jónsson et al., 1995).

In system 3 no plant nutrients are recycled from the toilet waste. Thus the same amount of chemical fertiliser has to be added when using system 3 as when using system 2 without any sludge recycling.

Socioeconomic parameters

The relevant socioeconomic parameters vary considerably with the situation. Therefore, except for two remarks, these are left to others to investigate based on specific situations.

System 1 provides local control not only over the sanitation system, but also over part of the system supplying the agricultural fertiliser urgently needed for sustainable food production. The technologies used by systems 1 and 3 are simple and easy to maintain.

Conclusion

Different sanitation systems should be evaluated concerning hygiene, the impact on the environment, usage of resources and socioeconomic parameters.

A very preliminary evaluation of hygiene indicates that one advantage of an unflushed source separating system is that the volume of the most pathogen-contaminated fraction is kept small, since it is limited to the faeces. Furthermore, since the faeces fraction is dry, the risk of leaching liquid should be small. This is important since leaching liquids, besides being a direct health hazard to those handling the faeces, might also contaminate surface and/or groundwater. The low water content also improves the possibilities of good sanitation results in primary and secondary treatments.

Since the unflushed source separating system collects, treats and recycles the excreta, the environmental impact is limited to the gaseous losses from the system, estimated at 2-3 g of ammonia per person and day, and to the impact of collecting, transporting, secondary treating and spreading approximately 1.1 kg of toilet fertiliser products per day. With a conventional pit toilet the emissions of nitrogen to air and/or water can be great. If the sewage from a conventional flush-and-discharge system is emitted untreated, heavy environmental effects can be caused by the emitted organic matter, phosphorus and nitrogen. These emissions can be significantly decreased if the system contains an advanced sewage treatment plant.

Methane is generated when organic matter is degraded anaerobically. This is a very potent greenhouse gas. When a conventional flush-and-discharge system is used methane can be generated both in the recipient water, if its oxygen storage is completely depleted, and from the treatment and disposal of the sewage sludge. Methane is probably also emitted from pit toilets, but the quantity is uncertain. Methane emissions from different sanitation systems need to be studied.

A conventional flush-and-discharge system uses a good deal of water. Energy is needed for pumping the sewage, and for treating the sewage if this is done. Also an extensive piping system is needed. Since normally no plant nutrients are recycled, this system implies the use of chemical fertilisers, and the resources needed for their production should be added to the other resources used by the system. The pit toilet system also implies the use of chemical fertilisers to sustain agriculture. Apart from this, resource usage by the pit toilet system is low.

A sanitation system should be evaluated based on the specific situation where it will be used. Socioeconomic variables must be thoroughly considered, along with hygiene, environmental impact and resource usage.

References

- Eriksson, S., Sanne, S. & Thomke, S. 1972. *Fodermedlen - sammansättning näringsvärde användbarhet* (Feeds - composition, nutrient value, usefulness). LTs förlag. (In Swedish).
- Geigy Scientific Tables. 1981. Vol 1. Ciba Geigy Limited, Basel, Switzerland.
- Hargelius, K., Svensson, U, Eriksson, T., Kling, R., Elmquist, H., Jönsson, H., Norin, E., Albihn, A., Stenstrom, T. A., Steineck, S. & Thyselius, L. 1997. *Utveckling av kretsloppsanpassade avloppssystem i befintlig bebyggelse* (Development of ecocyclic sewage systems for existing housing). Research report, Scandiaconsult. Gothenburg, Sweden.
- Johansson, S., Elmquist, H., Jönsson, H. & Steineck, S. 1997. *Human urine as fertilizer for oats, a field trial*. Paper to be presented at the "11th World Fertilizer Congress of CIEC FERTILIZATION for sustainable plant production and soil fertility" September 1997.
- Jönsson, H., Olsson, A., Stenstrom, T. A., Dalhammar, G. 1996. *Källsorterad humanurin i kretslopp - forstudie i tre delar* (Recycling source separated human urine - pilot study in three parts). *VA-Forsk Report 96-03*. Stockholm, Sweden. (In Swedish, English summary)
- Jönsson, H., Stenström, T.A., Svensson, J. & Sundin, A. 1997. Source separated urine - nutrient and heavy metal content, water saving and faecal contamination *Water Science and Technology* 35(9):145-152.
- Kirchmann, H. 1985. Losses, plant uptake and utilisation of manure nitrogen during a production cycle. *Acta Agriculture Scandinavica Supplement* 24.
- Kirchmann, H. & Pettersson, S. 1995. Human urine - chemical composition and fertilizer use efficiency. *Fertilizer Research* 40: 149-154.
- Olsson, A. 1995. *Källsorterad humanurin - förekomst och överlevnad av fekala mikroorganismer samt kemisk sammansättning* (Source separated human urine - occurrence and survival of faecal microorganisms and chemical composition). Report 208, Department of Agricultural Engineering Research, Swedish University of Agricultural Sciences, Uppsala, Sweden.
- Orten & Neuhaus. 1982. *Human biochemistry*, 10th edition. Mosby Year Book.

Rodhe, L. & Johansson, S 1996. Urin - Spridningsteknik, ammoniakavgång och växtnäring-
utnyttjande (Ammonia emission and nutrient utilization from urine using different techniques
for application). Report *Lantbruk & Industri* No 217, Swedish Institute of Agricultural
Engineering, Uppsala. (In Swedish, English summary)

SEPA. 1995a. *Vad innehåller avlopp från hushåll?* (What is the content of sewage from
households?). Report 4425, Swedish Environmental Protection Agency, Stockholm,
Sweden. (In Swedish)

SEPA. 1995b. *Miljöanpassade vatten- och avloppssystem* (Environmentally adapted water
and sewage systems). Report 4429, Swedish Environmental Protection Agency, Stockholm,
Sweden. (In Swedish)

Stenström, T.A. 1996. *Water microbiology for the 21st century*. Paper presented at Workshop
3, Stockholm Water Symposium, August 7th 1996. Stockholm, Sweden.

WHO. 1995. *Community water supply and sanitation - needs, challenges and health
objectives*. Report by the Director-General to the 48th World Assembly, Geneva, Switzerland.

WHO. 1996. *Creating healthy cities in the 21st century*. Geneva, Switzerland.

Winblad, U. 1997. *Towards and ecological approach to sanitation*. Publications on water
resources no 5, Department for Natural Resources and the Environment, Swedish
International Development Cooperation Agency, Stockholm, Sweden.

World Resource Institute. 1992. *World resources, 1992-1993*. Oxford University Press. New
York, USA.

Personal communication

Eksvärd, Jan. Swedish Farmers Association.

2.4

DISEASE CONTROL

Thor Axel Stenström, Swedish Institute for Infectious Disease Control, S-105 21 Stockholm Sweden. (Thor-Axel.Stenstrom@smi.ki.se)

Introduction

At all times and in most cultures humans have known that faecal material and wastewater may transmit diseases but at the same time have a valid potential for fertilization. The difference today, however, is that with our rapidly growing knowledge we can, in theory, make more sound risk assessments while at the same time taking advantage of the nutrient potential of the material.

In ancient Egypt different filtration methods, through sand, clay or charcoal, were already in use for drinking water. The Persian kings used to boil their water and store it in silver vessels. Filtration through volcanic stones has been used in many cultures, and in parts of Africa (e.g. Sudan) local tradition is to add certain clays to drinking-water pots, to act as adsorbents for microorganisms.

Similarly, reducing direct contact with faecal material and its secondary transmission to water was traditionally included in many religions. According to the Old Testament in the Bible, defecation should be performed outside the camp: one should carry a stick to dig a hole in a secluded place, defecate in the hole and cover the dropping afterwards with the stick. Similar rules exist in old Hinduism in relation to how Brahmins should answer the call of nature: they should not defecate at the edge of a river, dam or well, but in a hole, where they also pour the water for anal cleansing. According to an Islamic Hadith one should be aware of "three cursed things: to leave faecal material close to water sources, on the road or in the shadow". These rules of life were all preventions against direct and secondary disease transmission to others.

Nowadays we tend to focus our discussions on one transmission route for pathogens at a time, excluding or diminishing the importance of others. This approach often leads to failure to take remedial and preventive action against disease spread, if the route of spread is not clearly established, as in confined epidemics. The large urban and periurban areas of today are a good example of this problem.

Urban and periurban centres as a focus of disease transmission

Three main things apply to the prevention of disease transmission today, as well as in the future:

- ◆ the role of perception and medical anthropology in understanding habits, transmission routes and the potential for prevention by adequate treatment of waste and waste products, especially where these are used for crop fertilization; also the inadequate treatment of faecal material in society, and secondary transmission through vector animals;
- ◆ the multitude of transmission routes in existence, and factors such as location, potential pollution sources and fertilization of untreated waste, inadequate waste treatment and seasonality;
- ◆ the prevalence of disease within the society in question, and the local habits.

When we consider a poor urban area several factors surface as being essential for disease transmission both within and from the area. Some of these are:

- ◆ poor housing and limited indoor space per individual;
- ◆ the density of people within an area and limited outdoor space, giving numerous opportunities for pathogen transmission between individuals;
- ◆ private or family domains compared to common or public domains, where many areas can be considered no-one's responsibility;
- ◆ a high influx and outflux of people, favouring the import and export of disease;
- ◆ low per capita income, a high unemployment rate and a break-up of social structure, leading to a careless mentality in relation to personal hygienic practices;
- ◆ possibly a higher proportion of vulnerable individuals, including young children, old and sick or immunocompromised and malnourished persons;
- ◆ on an individual family basis, a deterioration in food handling and storage practices.

These features coincide with:

- ◆ the breakdown or non-existence of safe water sources and sanitary facilities, favouring indirect spread of pathogens through contact with fresh faecal material;
- ◆ non-existent rubbish collection facilities and often the occurrence of standing water or stormwater heavily polluted with faecal material and organic waste, favouring the coexistence of relatively large populations of rodents as well as other animals acting as secondary transmitters of disease to humans. These areas are also breeding sites for different insects acting as vectors, as well as sites for direct parasite transmission;
- ◆ sometimes the coexistence of a high proportion of domestic animals.

These factors combine the vulnerability of subgroups favouring the introduction of pathogens within the area with factors enhancing the possibilities of direct as well as environmental transmission within the population. It also favours a secondary "public" as well as a "family-based" secondary transmission.

The exposure to many of the pathogens may occur early in life in such settings, creating early immunological protection. Further exposure now and then will boost this protection effect for otherwise healthy adults, whereas vulnerable individuals will have been weeded out. This situation is sometimes taken as an excuse by politicians and some professionals for not acting. However, this neglects infections in small children, inactive immunological agents and the introduction of new agents, against which no protection exists in the community and for which the setting may serve as a focus for epidemics. These situations are by no means restricted to developing countries only, and the situation will exacerbate in the future.

These areas also pose a problem for further disease transmission, not just within the society itself but also as a continuous locus for the export (and import) of diseases to other areas. It is deleterious in preventive remedial measures to isolate one factor for action in such situations. The need for clean water and better sanitary conditions will increase. However, disease transmission will not be prevented simply by improving the water situation, but rather needs a multifactorial approach.

Disease transmission through contaminated water or inappropriate sanitary facilities - an international dilemma?

Waterborne disease outbreaks have had a tendency to be looked upon by many politicians as odd events occurring infrequently. They have also been considered by some as "the rich man's problem", in the sense that solutions are not on hand or affordable for poor communities. Sometimes they have been seen as mere statistics.

Human faecal products have similarly been looked upon as a 'deposition problem'. Most of us have a perception of faecal material as repulsive and not to be touched. The obvious solution is that if faecal material is not considered a waste product but merely an economic and agricultural resource, can be shown to be safe in relation to disease transmission and does not look like faecal material, it may be accepted in most cultures, thereby reducing the risk of accidental contact by uncontrolled spread in the environment.

As regards disease transmission, the persistences for different pathogens, variable infective doses, time of latency for some parasites in the environment and different susceptibilities between individuals are some of the factors that have created insecurity in the reuse of such products.

Newly recognised organisms with a high resistance against environmental factors have also created a feeling of insecurity. The role of such organisms is under investigation. The Milwaukee *Cryptosporidium* outbreak in the US has served as a national and international alarm-bell in water treatment. Realisation that the current treatment barriers and disinfection practices may not be enough to safeguard the water has raised demands for direct routine monitoring of different groups of pathogenic organisms. Secondly, it has also focused attention on the relatively large group of people that may be susceptible, owing to immune defects, age or other factors. Thirdly, it has brought forward a growing interest in zoonotic spread, i.e. organisms transmitted from animals to man. This interest in zoonotic transmission also exists in Sweden, partly due to the number of *Campylobacter* outbreaks transmitted through water. However, it also focus on the potential of human disease transmission through animal manure, which further questions the role of disease transmission from different type of waste products to man.

All these factors prevail to a large extent in developing countries and in poor urban situations, where the sick, the malnourished, the young and elderly may all be more likely to contract diseases through faecal contamination, as well as being more likely to transmit the diseases further secondarily. Prevention of disease transmission through sanitary interventions in such situations will never occur if, for example, young children are kept away from the sanitary facilities, and the sick and old are too weak to use them, and therefore defecate in the gutter just outside the house.

Several international epidemics or outbreaks have also been suspected of being caused by vegetables irrigated with wastewater and thereafter exported and consumed in other areas or countries. This type of international transmission will most likely occur at a higher frequency in the future.

Deposition of faecal material in pit latrines - risk of groundwater contamination

Over the last few decades national authorities in developing countries, as well as various donor agencies, have recommended and promoted the use of pit latrines to reduce the presence of human waste and thereby counteract the transmission of enteric diseases. These efforts have led to an improvement in sanitary conditions in many instances, but in others no apparent improvement has been observed and in some cases even a deterioration has occurred. The ever-increasing demands in the cities and periurban areas will further enhance the need for on-site sanitation and sources of drinking water. The use of pit latrines has also hampered the reuse of faecal material as a resource.

Poor siting of latrines or wells may create extensive groundwater pollution by microorganisms. A safety distance of 10-30 m between latrines and wells has been adhered to in many developing countries, but without considering factors that may affect the actual risk of pollution. To assess and exemplify this as a transmission route, we conducted a number of simple experiments where bacteriophages were introduced as biotracers into different latrines in two periurban African settings. It was shown that transmission occurred within days under the prevailing conditions, from the latrines to wells up to distances of between 50 and 100 metres. This shows that although parasites and bacteria may be held back effectively, some viruses were not. The old rules may therefore not be applicable.

This example also demonstrates a second possibility, namely the potential of assessing different transmission routes by means of bacteriophages. Different tracers can be applied simultaneously to study the impact of groundwater transmission, food handling practices or person-to-person transmission. Further studies need to be done to assess the relative impacts of different transmission routes in different communities.

Treatment and preventive alternatives for waste in deposition and reuse

A multitude of treatment options and approaches exist to reduce or diminish the number of pathogens in waste products. However, many of these have not been evaluated for reuse situations for land fertilisation.

Preventive measures can also be taken at different levels with an exposure barrier approach. These include deposition, treatment, waste product separation, reuse optimisation, ways of application, crop selection and human exposure control.

Urine separation is an example of waste product separation and reuse. The pathogens excreted in the urine are fewer than those in faecal material. Among them are *Leptospira*, *Salmonella typhi* and *paratyphi* and *Schistosoma haematobium*. According to our investigations the *Salmonella* group of bacteria seem to be highly susceptible to the environment in the collected urine, with a rapid die-off. *Schistosoma* will probably also die off rapidly. *Leptospira* has not been investigated. The main problem, however, is the faecal contamination that may and will occur. Owing to the low degree of dilution within a urine-separating system the concentration of pathogens may potentially be high. A number of bacterial pathogens have been tested, and most of these will have a rapid die-off. Some parasites, like *Cryptosporidium* and *Ascaris*, have also been investigated in preliminary trials and seem to be reduced within a couple of months. Viruses may be a problem but have so far not been investigated. However, most pathogens will be reduced within a couple of months. The present rule in Sweden is that the separated urine should be stored for six months before use. This time may be reduced in the future, or in relation to ways of application to arable lands.

The combined faecal waste has been investigated in a wet composting process in Sweden and in relation to temperature. In this thermophilic liquid composting system we applied a strategy to assess the sanitary effects in relation to time, treatment and temperature. By adding small 'teabags' of *Ascaris* eggs to the material, and bacteriophages with an elevated temperature resistance, and doing some supplementary laboratory analysis with bacterial strains, we were able to give definite time/temperature relationships for an effective treatment.

Evaluation of dry composting systems

There is a need for simple comparable approaches to the evaluation of dry composting systems and other treatment alternatives applicable in developed as well as developing countries. Current assessments of faecal indicator bacteria are less valid, as these are more susceptible than many true pathogens. The direct assessment of different pathogens is also less valid, as these may vary to a very high degree between situations and experimental evaluations. They also vary in susceptibility depending on the treatments applied.

By selecting organisms with a high resistance to a certain treatment it may be possible to accrue baseline information on the die-off and hygiene and form a sustainable base for comparable risk assessment in different situations.

For dry composting systems the addition of *Ascaris* eggs under controlled conditions, combined with evaluations of added innocuous bacteriophages, may be the best and cheapest approach to evaluate storage time, temperature effects and pH effects (e.g. by lime treatment). This will also make it possible to compare and quantify the treatment effects of different systems.

In conclusion I believe:

- ◆ that the approaches taken within this workshop, for the reuse of waste with separation of the liquid and dry phases, are the best for the future from a hygienic point of view;
- ◆ that this approach may diminish the accidental presence of faecal material and the risk of accidental spread within vulnerable societies;
- ◆ that caution must be raised not to create new routes of transmission through food products and animal vectors
- ◆ that evaluation of the treatment alternatives at hand should be standardized, so as to promote the systems and clarify the questions relating to pathogens.

The increasing need for alternative treatment systems for wastewater handling also raise a demand for simple assessment schemes to be applied. The potential routine monitoring applied in some developed countries is not applicable in many developing areas. A promising approach to both waste and wastewater handling is source separation of the material. This is also essential for their reuse in agriculture. Also, in these situations biotracers may give a good indication of the treatment potential and times needed. The choice of organisms may vary from time to time and between systems.

2.5

PERCEPTIONS, URINE BLINDNESS AND URBAN AGRICULTURE

Jan-Olof Drangert, Dept of Water and Environmental Studies, Linköping University, 581 83 Linköping, Sweden (jandr@tema.liu.se)

Introduction

The problems and inconveniences caused by human excreta are aggravated in towns. The Romans built their Cloaca Maxima to rid the city of human waste before Christ was born; today all over the world cities are trying hard to get rid of faeces and urine in one way or another.

Given that any arrangement relies on the perceptions people have, we need to know more about these. So far, however, no comprehensive history of excreta has been written, but we have some good compilations on the development of technologies over the millennia (e.g. Hösel, 1987).

The legacy of the water closet

Water-closet technology has been promoted successfully all over the world. This ingenious system does the work of the former cleaners in Rome and London. However, not enough attention has been paid to the circumstances under which it functions properly. Europeans, as well as engineers in the south, have been trapped by a climatic and agricultural bias. For instance, in Rome, where long aqueducts carried water from distant rivers to the town, the constant water flushed all debris and household waste through Cloaca Maxima back to the river Tiber, which empties into the Mediterranean Sea. The one million citizens of Rome imported much of their food from neighbouring countries and did not have to worry about the reuse of nutrients in the effluent. Likewise, the unique natural conditions in London made it possible to flush out all black water into the sea; the enormous quantity of water in the River Thames, flowing the year around, and the regular ebb and flow of the tide carried the contaminated water into the North Sea. With cheap, imported fertilizers the British were not concerned about a decline in soil fertility.

A sustainable society presupposes the recirculation of nutrients or the import of food from other places. However, the legacy of the water closet seems to impede creative thinking in most countries. In a world with limited nutrients and an increasing number of inhabitants we can hardly hope for a constant flow of fertilizers, but should, whenever possible, reclaim the nutrients from human waste. This has been done in many places in varying ways over time. Chinese farmers collecting buckets of nightsoil for their agriculture is a major example. However, the history of human excreta is one where urine and faeces have seldom been separated, either practically or mentally. This 'urine blindness' has left a number of dry options undeveloped.

Perceptions of urine and faeces

Attitudes and perceptions about health hazards and people's revulsion against faeces and urine vary between cultures, and often people's attitudes towards urine differ from those towards

faeces. Tanner (1995) writes that every social group has a social policy for excreting: some norms of conduct will vary with age, marital status, sex, education, class, religion, locality, employment and physical capacity. The human dimension was found by Cross (1985:I-1) to be a seriously neglected in environmental health, and yet it is of central importance to a full understanding of the potential reuse of human waste. For example, a process of social conditioning is involved in the identification of those smells which may be categorized as disgusting in particular cultures. However, as noted by Loudon (1977:168), it is a common observation that among individuals accustomed to the smells of putrefaction, such as those involved in specialized occupations, conditioning modifies or suppresses a response which may well have a biochemical basis, even though reinforced by sociopsychological factors. People's perceptions of urine have hardly been studied. A Koranic edict considers urine to be a spiritual pollutant, and Islamic custom demands that Muslims minimize contact with human excreta (Hanafi 1985). In Sweden urine has commonly been used to smear wounds, and to some extent to drink as therapy (Frode-Kristensen 1966:18). Recently urine has been shown to have a disinfectant property. Hansen (1928:88) reported that in the Danish countryside in the 19th century urine was stored and used as a detergent for washing clothes and dyeing. A century earlier, European artisans collected urine and canine excrement for industrial purposes (Reid 1991:10).

Faeces are perceived quite differently, and are regarded as offensive and unpleasant to handle (Fortes 1945:8 on the Tallensi; Malinowski 1929:378 on the Trobriand; Hamlin 1990 on the British; Reid 1991 on the French). An exception seems to be people's perception of cleansing a child's bottom, which fits Loudon's comment on conditioning. Furthermore, one may find differences in male and female perceptions, owing to varying exposures to adult excreta, as is expected in the care of the elderly and incapacitated.

Both professionals and laymen foster strong opinions that adult faeces are hazardous to health because the stool may contain a variety of pathogens, such as *Giardia* and *Entamoeba* parasites, *Shigella* and *Campylobacter* bacteria and rotavirus. More generally, Mary Douglas (1978:34) argues that it is difficult to think of dirt except in the context of pathogenicity within contemporary European thinking, and this makes it more important to understand dirt avoidance before perception was transformed by bacteriology.

Faeces may carry a definite cultural meaning, for example that one's faeces can be a medium for revenge and therefore must not be seen by others, or that the faeces of certain kin must not be mixed (Tanner and Wijsen, 1993). Such perceptions are difficult to maintain in crowded urban areas and they may gradually disappear. A study in periurban Eldoret in Kenya indicates this by stating that only 10% of the informants thought it unsafe to throw children's faeces into the latrine, for example because children's stools should not be mixed with those of adults; children's stools should be hidden because of the danger of a witch picking on the stool of a particular child; and faeces left in shallow latrines can be picked up by people with ill will (Akongá 1996:42).

From its practical uses cow dung seems to be seen as less offensive than human faeces. A century ago it became popular in rural Sweden to attach the latrine house (with no pit) to the stable, so that human faeces and dung from the stall-fed animals were mixed to make them less repulsive when applied to the fields. Fortes reported a similar practice among Tallensi farmers, using a mixture of human faeces and animal manure as fertilizer. Another common way to get rid of faeces is to let pigs and dogs scavenge, i.e. eat the human faeces and produce their own faeces, which are not regarded as equally repulsive.

Another way of approaching people's attitudes to excreta is how sewage workers and excrement collectors are viewed. The emerging picture is a fairly homogeneous one. Noble (1991) writes about the professional pride shown by Parisian sewer men. Another example from South Africa tells that the ethnic group Bhaca are eagerly sought after as attendants at sewage treatment works (Mbambisa and Selkirk, 1990). On the other hand, according to the same source, highly qualified Transkeians are reluctant to work in the sewage treatment field. A possibly contrasting example given by Tanner (1995:90) mentions the social position of lavatory cleaners: "In Hinduism it is done by outcastes, but much the same status applies to cleaners in western societies". In ancient Rome the cleaning of the Cloaca Maxima was performed by prisoners of war (Hösel 1987:22). We may infer from this that the general perception of human waste was one of disgust. However, the organization of waste disposal was highly regarded and led by one of the most prestigious officials in the Roman Empire.

Bearing in mind that all these examples from various times and parts of the world deal exclusively with mixed excreta, my impression is that both professionals and laymen consider plain urine harmless and inoffensive. A reason for this may be the fact that urine is indistinguishable from water on the ground, and stepping into it is quite different from stepping into faeces. To what extent would this relaxed view of urine make people prepared to use it for their own benefit?

Alternative dry systems in Sweden

Dry systems have been on the market since the early 1970s. Initially, these were intended for use in summer cottages rather than in apartments. More than fifty thousand units have been sold so far. The Agenda 21 resolutions of 1992 promoted serious activity in Sweden concerning alternative options for the disposal of excreta. An earlier interest among ecologically minded people has now broadened into a public concern. The Swedish Environmental Authority (SEPA) has approved a number of disposal systems and the present regulations make the user responsible for maintaining the system.

Some one hundred ecological 'villages' have been founded in Sweden by people interested in leading an environmentally friendly life. They have organized themselves and built or bought houses and installed a variety of devices for the reuse and recirculation of water and nutrients and the saving of energy. Most villages are at a distance from towns, but an increasing number of projects take shape in urban settings. The residents often have a middle-class background with a good education and an ability to get bank loans for their projects, just as when building a conventional house.

Municipal councils and some of the major contractors are also beginning to sense that the future may have more ecological approaches in store, and therefore they invest in test houses. All these developments clearly show that assumed norms and attitudes may change rather quickly if viable alternatives appear.

A market survey carried out by the Swedish Consumer Protection Board presents 42 different 'dry' systems involving 22 manufacturers. Most of these are small companies, but two of the well-established whiteware manufacturers offer no-mixing toilets, i.e. keeping faeces and urine separated; 21 systems keep faeces and urine separated, another five have this as an option and four systems first mix and then separate faeces and urine. Twelve systems mix excreta and compost it or remove it in buckets/plastic bags.

The majority of the units for permanent buildings are made of porcelain with two bowls, whereas most units for summer houses are made of plastic. Only one of the marketed toilets has a lid inside the bowl to cover the faeces.

The cost of the units, excluding installation, is between 1,000 and 30,000 SEK, and the cost of a porcelain unit is only slightly higher than a conventional toilet. From a user's point of view, the household saves the fee for connection to a communal water and sewerage system, which runs at 50,000-100,000 SEK.

Commercial presentation of dry systems

All 22 manufacturers argue in their promotion material in favour of protecting the environment, mainly by saving water and/or reducing the discharge to rivers and lakes. Most manufacturers emphasize the reuse/recirculation of the faeces, but fewer mention the possibility of reusing urine in the garden. The adverts in daily papers claim that the units are easy to install, are hygienic and free from odour, and use no chemicals.

The modern composting latrine is described in rather idyllic terms, as opposed to the smelly bucket latrine of the past. One advert puts it as follows:

"Forget everything that reminds you of stinking dry (bucket) toilets and malfunctioning compost toilets. The Septum ecotoilet combines the simplicity of the dry toilet with the convenience of the WC, without the need for electricity or water."

Rarely is the word faeces mentioned in the information material, but instead the word for the end-product, compost, is used. It seems that drying the faeces is an acceptable way of conveying a message to potential customers. This may be because not only are Swedes late urban dwellers (flush toilets were introduced on a large scale around the First World War, and many of the flats in Stockholm still had dry toilets on the ground at the end of the Second World War), but also a sizeable proportion of families have summer cottages with a compost latrine or a bucket latrine, which is emptied by the family and collected by municipal staff.

The manufacturers have switched from approaching only ecologically minded customers to reaching the general public. There is currently an interesting change of emphasis from composting of faeces to using the collected urine. Some company leaflets have changed their texts only this year. One company now offers a urine tank, which is airtight so that the ammonia is not released. Also the tank is connected to a plastic pipe to water the garden, so that the underpressure drains the tank and mixes the urine and the water in the pipe.

If the adverts indicate how consumers are assumed to perceive urine and faeces, we may conclude that it is possible to communicate the message that faeces can be composted (together with other biological waste from the household) and used safely in the garden. The use of urine is mentioned only rarely, not because of cultural resistance, but because it has only very recently become an option.

Experiences and perceptions among users of dry systems

There are a number of studies of users' experiences from a number of experiments. For example, Schmidtbauer (1996) interviewed 14 farmers, five property managers and 28 households in Ale in southern Sweden. The farmers expressed positive attitudes to the use of human urine on their fields; tenants believed in recirculation, but the property managers preferred to wait for initiatives from tenants.

The Eco-house in Norrköping town is a three-storey building with 18 flats, built in the 1960s and converted into an eco-house last year. The aim was to reduce energy consumption and to handle wastewater and garbage locally. Potable water is taken from the municipal system. The new toilets are water-driven and urine and faeces are kept separate. The urine is flushed with 0.2 litres of water and drains into a urine tank. After some six months' storage to allow antibiotics to disintegrate, the contents are collected by a farmer. Faeces are flushed with 4 litres of water to a separator in the basement which separates the liquid from the solids. The dehydrated faeces are composted together with household garbage for some eight months before being used as fertilizer in the residents' small gardens near the house. The separated flush water is irradiated with UV light to kill the germs and piped, together with bath, dish and laundry water, to a three-chamber tank for sludge separation. The treated water is then used in a root-filtering system in the ecology park situated in a beautifully formed marsh. Rainwater is also taken care of locally

Botta (1997) made an initial study of this eco-house, which included residents' perceptions. Among other things, she found that the no-mixing toilets were appreciated by both women and men (men need to sit when urinating). The firm responsible for the treatment plant faced numerous operational problems. The residents accepted the inconvenience of smells from the initially malfunctioning composting system, since they were well-informed about the pilot nature of the new system.

A critical evaluation of the eco-village of Toarp in southern Sweden was reported by Fittschen and Niemczynowicz (1997). The village was established in 1992 and comprised 37 houses with water from a well, dry sanitation, and a common treatment facility for the grey water. Three different kinds of composting (mixing) toilets were installed. All three had some kind of shortcomings, and one brand received many complaints about flies, smells, wet composting material, and difficulty in cleaning. The reasons for the poor results were, among other things, that the composting process was not supplied with sufficient oxygen, and the residents were not informed about how much carbon-rich material was needed in order to improve the C:N ratio. Eleven out of 12 respondents were 'very' or 'quite' satisfied with the Norwegian system with four rotating chambers, whereas 11 out of 16 Ekoloo users were 'quite' or 'very' dissatisfied. In 1995 the housing corporation let the households decide if they wanted to keep the dry latrine or switch to water closets. All but four chose a WC.

User experiences of no-mixing toilets are fairly positive, but some of the mixing toilets face user dissatisfaction. The composted material is often used as fertilizer in the home garden. The reuse of urine is less developed, and several projects rely on farmers to collect the urine and spread it on their farms.

Capacity of the vegetation to utilize urine and faeces

UNDP (1996) has recently estimated that some 15% of world food production comes from urban agriculture (farming, horticulture, animal husbandry, fish ponds etc.). Cities like Lusaka and Dar es Salaam reach figures as high as 50%. Given that half of the world's population will soon live in urban areas, it is to be expected that the recirculation of nutrients will feature highly in the near future, as was the case a century ago in Europe.

The land area needed to produce people's average annual intake of, say, 250 kg of cereals, would be 2500 m², since the average global output is about one tonne per hectare. This varies

substantially between different agricultural zones and whether irrigation or dry-land farming is contemplated: from some 500 m² in irrigation agriculture to perhaps as much as 5000 m² in dry land farming on marginal land.

It is assumed that many people have had more or less explicit ideas about how much excreta vegetation can consume. For instance, if half of the food consumed in Lusaka is consumed within the city boundary, a first approximation would be that half of the accumulated excreta could be input into the urban agriculture. An early, closer scientific look was taken by Pettenkofer's disciple Max Rubner, who took on the chair of Robert Koch as professor in Berlin. He estimated that excreta from 80 persons is enough to fertilize a hectare (Schadewaldt 1983), or in other words one person could fertilize some 125 m². FAO (1977) reported application rates of nightsoil in China of 20-30 tonnes per hectare, which corresponds to disposing of the annual human waste from one adult on 250-300 m², with only one crop per year. As expected, these figures differ partly because they represent different geographical areas, different diets and varying intensities of crop production. It reminds us of the importance of local data on, for example, agriculture, efficiency and nutrient intake, in order to find out what area can be fertilized with a person's accumulated excreta.

Losses to the atmosphere of ammonia and to the soil of phosphorus by fixation may be considerable from faeces, whereas the loss from urine was very low if it was immediately mixed into the soil by harrowing (Jönsson, 1997). Vegetation on some 50-100 m² may be enough to consume the nutrients from the urine of one person if intensive horticulture is practiced with, say, three crops a year. We may formulate the information in an equation as follows:

The urine equation

An (1) adult eats 250 kg of cereals per year, which has been grown on less than 500 m² and fertilized to perhaps 50% by the person's urine mixed with her used wastewater.

Drangert, 1996

Daily household water use varies and periurban residents with no piped water may use as little as 10-20 litres. The resulting quantity of wastewater can be mixed with the excreted 1.5 litre urine in order to make a perfect fertilizer. Some 20 litres of fluid can be disposed of daily on a few square metres and easily infiltrated into the soil. Ground infiltration rates for wastewater into soils of different types have been estimated and found to vary considerably. from as much as 50 litres/m²/day in gravel, coarse and medium sand to 8 litres/m²/day in silty clay loam and clay loam (Franceys et al., 1992). Too much wastewater may, however, pollute the groundwater with nitrogen and phosphorus (Lagerstedt et al., 1994). The authors recommend planting of deep-rooted trees close to latrine pits as a countermeasure. The Swedish Environment Protection Agency estimates that wastewater from households requires an infiltration area of 5-20 m² per person (with a daily use of some 200 litres of water), whereas a conventional treatment plant requires only 0.1 m² per person (SEPA, 1992).

Reuse in urban agriculture

It is obvious that the open space available in densely populated urban areas does not allow *in situ* recirculation of all human excreta, even if all open space were allotted to agriculture. A balance has to be achieved between utilising excreta in the neighbourhood and transporting it to distant sites through sewers or on trucks and bicycles.

Poor settlements on urban fringes may look very different depending on the age of the settlement, economic and cultural conflict patterns etc. Settlement patterns around every city also vary considerably. Keeping such differences in mind, we can still try to discuss recirculation of urine and faeces in urban agriculture. Any recommendations on how to dispose excreta must, however, be sensitive to people's perceptions and local physical conditions. Residents' skills and knowledge of urban agriculture are important, in addition to their perceptions of the reuse of human excreta.

The relationship between outdoor space and plant uptake of nutrients is summarized in Figure 1. There is a biological limit to what it is possible to achieve, and another limit to what is administratively allowed. In between these limits there is a 'feasibility gap' that is being explored.

Figure 1. Proportion of human waste to be recirculated and reused in urban agriculture in relation to population density (log scale)

Proportion of human waste being reused locally

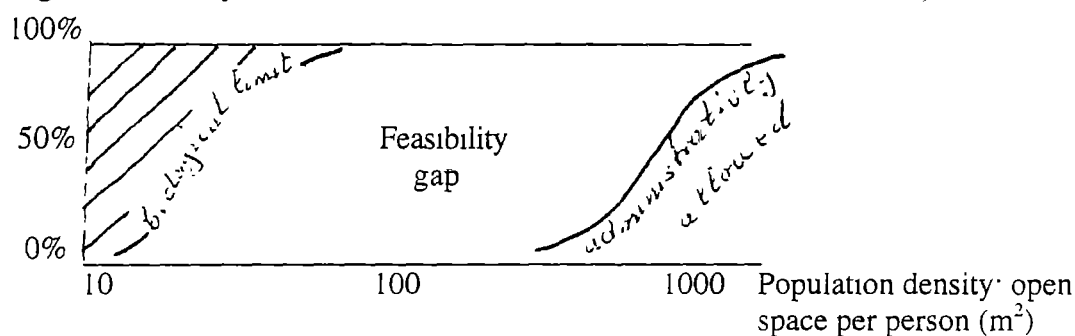

If the population density is low, each person having on average more than, say, 500 m² of open space, as in periurban Trivandrum in India, household members may take care of the spread of urine and faeces in the garden and fields close by. They may urinate directly on the fields or collect urine in a bucket or container in the latrine house, mix it with wastewater and spread it on the fields in the evening. Faeces may be dropped in a shallow latrine or in a cat-hole and covered with soil. A fairly intensive use of excreta in agriculture would recirculate most nutrients in such areas.

This way of dealing with excreta is an individual affair similar to what is already practised in rural areas. Such a system does not require much effort by the authorities or the local power structure. Healthwise it is fairly safe, except for hookworms, which can survive in the soil for several months (a protective measure is to wear shoes).

The other extreme, when a person has less than, say, 20 m² of open space, as in parts of Khayelitsa in Cape Town, there is little room for reuse of urine and faeces. The large volume of wastewater-urine mix will almost serve as irrigation water and requires a thick vegetation cover to consume the nutrients. Only a keen and skilful horticulturist can be expected to manage such a task. Health precautions require strict handling of the faeces, if they are not dried or incinerated or buried in a pit. Alternatively, removal of excreta from the area would require a well-organized collection and transport system.

Interesting combinations of recirculation locally may be found in the 'feasibility gap', in the spectrum of about 20-500 m² of open space per person. Small home gardens would be able to absorb the prepared urine. The soil's capacity to digest urine varies, and the hydrological regime, type of vegetation, pH etc. determine what happens to the nutrients. Excess urine may soak into the ground without medium-term harm to the groundwater. In compounds where cows are kept, however, raised levels of nitrate and phosphorus may occur in the groundwater. A raised nitrate level will affect the water quality in nearby wells for a long time. If the available space is above, say 200-300 m², a more casual way of agriculture would suffice to utilize all urine.

The odour-free faeces can be disposed of. In areas with deep groundwater levels pit latrines may be convenient, whereas areas with shallow groundwater levels should aspire to other solutions. Dry-box inclusion, incineration and physical removal of the faeces are some of the alternatives.

Summary

There are at least three reasons to overcome our 'urine blindness' and to reuse urine: urine is bulkier than faeces and more expensive to transport; it contains more nutrients than faeces; and people have a more relaxed view on urine than on faeces. If periurban residents are interested, they can easily reuse urine in agriculture and increase their food production, thereby reducing malnutrition. The remaining dry faeces may easily be disposed of in any culturally accepted and hygienic way.

The limited capacity of town councils causes large numbers of periurban dwellers to lack piped water and/or sewerage, and they are left to explore their own solutions. The lesser cultural revulsion against urine may increase people's willingness to keep urine and faeces separate, and use both in urban agriculture. Poor periurban dwellers may appreciate the possibility of using urine in intensive gardening and earning part of their living from it (in the way some wealthy people do, or as was done in wartime Europe). This is probably more tempting than following the advice to improve health by building a latrine and using it regularly.

By introducing the common measure of 'per square metre' we have been able to establish crude relationships such as the *urine equation* between the soil's capacity to absorb urine, plant production and plant nutrient requirements, the land area required for a person's food intake, the amount of nutrients in human excreta, and the density of population in periurban areas. The conclusion is that the environmental capacity to use urine in urban agriculture varies with the population density, but appears to be enough in most circumstances. However, in very densely populated areas with, say, 10 m² of open space per person, it would require strong efforts by skilful and keen horticulturists.

Women usually take care of the cleaning of the toilets and latrines in the home, they handle most of the grey water, they often do the gardening, and are responsible for feeding the family. Therefore, the potential use of urine mixed with grey water in watering and fertilizing the garden - be it a lawn or vegetable garden - does not require a change of responsibilities between men and women in the household. The woman can be in control of all the aspects of urine-based agriculture. However, the question of putting even more pressure on already overworked women should be addressed, as it could become an obstacle. Only the individual woman will in the end decide whether the effort is worthwhile. However, women who are

already involved in gardening may find it easier to reuse grey water and urine than fetching water from a well to water their garden.

Well-intended interventions may fail owing to neglect of individual values or societal norms, or they may succeed thanks to other, seemingly unrelated, values that were not contemplated by the intervention. The discussion in this paper presents a plural view on the reuse of excreta while paying attention to perceptions and possibilities. There is no single best solution, but there is a need to soften the resistance to alternative excreta disposal, as evidenced by many local regulations.

References

- Akongá, Joshua. 1996. Safe Water Environment in Eldoret town: the social dimension. In Proceedings on Safe Water Environments held in Eldoret, 21-23 August 1995. *Water and Environmental Studies*. Linköping University. Report 24. 1996
- Botta, M. et al. 1997 Projektet "Ekoporten" *Dokumentation av ombyggnad och kretslopps-anpassning av ett flerbostadshus från miljonprogrammet*. BOOM-gruppen på KTH. Arbetsrapport februari 1997.
- Cross, Piers. 1985. *Health aspects of nightsoil and sludge use in agriculture and aquaculture*. International Reference Centre for Water Disposal (IRCWD), Duebendorf, Switzerland.
- Douglas, Mary. 1978. *Purity and danger. An analysis of the concepts of pollution and taboo*. Routledge & Kegan Paul. London.
- Drangert, J-O. 1996. *Perceptions of human excreta and possibilities to re-use urine in periurban areas*. Stockholm Water Symposium, August 6-9, 1996, Stockholm.
- Fittschen, I. and J. Niemczynowicz 1997 Experiences with dry sanitation and grey water treatment in the ecovillage Toarp, Sweden. Submitted to *Water Science and Technology*.
- Franceys, R., Pickford, J., and Reed, R. 1992. *A guide to the development of on-site sanitation*. World Health Organization, Geneva.
- Frode- Kristensen, Selma. 1966. Vid brunnen. En kulturbild från sekelskiftet. (At the well at the turn of the century). *Skrifter från Folkliivsarkivet i Lund. Nr 8*. Lund.
- Hamlin, Christopher. 1990. *A science of impurity. Water analysis in nineteenth century Britain*. University of California Press, Berkeley.
- Hanafi, H. 1985. Human surrender to nature- an Islamic model (Swedish). In: Hjort, A. and U Svedin (eds.) *Jord - Människa - Himmel*. pp. 81-113. Stockholm, Liber Förlag.
- Hansen, H.P 1928. *Om renlighed i gamle dage*. (On hygiene in the old days). Nordisk Forlag, Copenhagen.
- Hösel, G. 1987. *Unser Abfall Aller Zeiten Eine Kulturgeschichte der Stadtereinigung*. Kommunal-schriften-Verlag J. Jehle, Munich.
- Lagerstedt, E., Jacks, G. and F. Sefe. 1994. Nitrate in groundwater and N circulation in eastern Botswana. *Environmental Geology*, Vol. 23, No. 1 1994. Springer International. .
- Loudon, J.B. 1977. On body products. In: John Blacking (ed.) *The anthropology of the body*. A.S.A. Monograph 15. Academic Press, London.
- Luyendijk, Rolf. 1994. Double vault composting latrine, revisited and rejected. *Waterfront*, Issue 6, December 1994
- Mbambisa, G.P. and W.T. Selkirk.1990. Sanitation in Transkei: problems and perspectives. International Water Supply Association (IWSA) 1990. *Seminar on Water and Sanitation*, Transkei, 26-27 June 1990. Wild Coast Sun, Transkei. Volume of Papers ISBN 0 7988 4938 X.
- Reid, Donald. 1991. *Paris sewers and sewer men. Realities and representations*. Harvard University Press, Cambridge (Mass).

Schadewaldt, Hans. 1983. Von der Cloaca maxima bis zur modernen Kläranlage-historische Aspekte zur Abfallsbeseitigung. *Zbl. Bakt. Hyg., I Abt. Orig. B* 178, 68-80 (1983).

SEPA 1992. *Vatten, avlopp och miljö* (Water, sewage and the environment). Swedish Environmental Agency. Report 4207. Stockholm.

Schmidtbauer, P. 1996. Hinder och möjligheter för källsortering av humanurin- intervjuundersökning bland lantbrukare, fastighetsförvaltare och boende i Ale kommun. Avd. för jordbearbetning. *Teknisk rapport* nr 5, 1996. Sveriges lantbruksuniversitet.

Tanner, R. and F. Wijzen. 1993. Christianity in Usukuma. A working misunderstanding. *Nouvelle Revue de Science Missionnaire*. In press.

Tanner, Ralph. 1995. Excreting, excretors and social policy. Some cross-cultural observations on an underresearched activity. *J Preventive Medicine & Hygiene*. 1995 36(N) 3/4. pp. 1-10.

UNDP 1996. *Urban agriculture. Food, jobs and sustainable cities*. UNDP Publication Series for Habitat II. Volume 1. New York.

INSTITUTIONAL AND FINANCIAL CONSEQUENCES OF ECOLOGICAL SANITATION

Jorge Vargas Cullell, P.O. Box 348-2050, Costa Rica (jvcaam@sol.rasca.co.cr)

Introduction

In many developing countries water is an increasingly scarce and expensive resource. It is a documented fact that the poor bear the brunt of this well known problem (Garn and Briscoe, 1994; World Bank, 1993). However, governments and international institutions continue to advocate sewerage as the normal or ideal system to manage human excreta and wastewater in urban centres. Yet if water is an economic good, and in many urban centres it is a particularly expensive and scarce one, a *non sequitur* emerges between the diagnosis "water scarcity" and the recommendation urban sanitation based on sewerage. Consequently, the "sewerage for all" ideal may be called into task.

Any debate over this issue faces a seemingly insurmountable obstacle. An ingrained perception of low-cost alternatives as substandard and temporary solutions for the urban poor still holds sway in many sanitation policies. Its underlying assumption is that economic modernization will bring about increased institutional and financial capabilities which, in turn, will make it possible in the future to supply the ideal service to everyone.

For vast urban populations, however, temporary solutions are anything but temporary. In spite of new news on financing water supply and sewerage services, policies based on "sewerage for all" as an ideal face harsh realities. Sewerage remains by far the most expensive technology, and in developing countries the costs of providing sewerage continue to rise. It also demands increasing water consumption levels, which may prove infeasible in many urban areas.

In addition, given the absence of adequate treatment facilities, sewerage heavily pollutes coastal areas and river basins. In Latin America, less than 2 % of all urban sewerage is treated. In Costa Rica, a country with otherwise high sanitation achievements, treatment of effluents remains an exception, and almost all decentralised treatment plants are out of service (Reynolds, 1997)

The acute and growing problems affecting developing countries' urban centres certainly beg for new approaches to urban sanitation. These do not necessarily presuppose doing away with sewerage, but imply combinations of different technical solutions. However, the difficulties in conceptualizing and implementing new sanitation approaches on a city/regional scale must not be underestimated, as they stretch far beyond financial, technical or managerial predicaments. A fundamental change in urban sanitation policies' conceptual and practical frameworks may be required, for which a few settlements and institutions are fully prepared. Nonetheless, some things may provisionally be said.

This paper discusses some of the long-term daunting institutional and financial choices faced by urban sanitation policies based on the "sewerage for all" ideal. The discussion will be approached through a fictional situation, considering an imagined "City X". The paper aims at depicting fundamental policy dilemmas faced by fast-growing cities, even when sound financial policies are followed. Its purpose is not to prove the feasibility of any alternative low-cost sanitation policy, or to lump together all sewerage as one possible solution. Rather, it intends

to dissipate the illusion that low-cost sanitation represents a temporary solution for poor urban households, and to argue that the time has come to consider new approaches to urban sanitation as something more than substandard solutions.

Sewerage for all revisited

"City X" is a busy city of roughly two million inhabitants in the developing world with a rapid growth rate (3.5% annually). City dwellers may be classified into two social groups, poor and non-poor. The former, who represent around 50% of the city's population, grow faster (4.5%) than non-poor households. Although poor households have very low estimated average annual income, say USD 300, there is a hidden informal economy which provides additional income, an extra USD 300 on average per poor household.

Sanitation goals

Public authorities in "City X" currently discuss the 20-year water supply and sanitation strategic coverage goals. Their current situation and target is depicted in Table 1.

Table 1. "City X" 20-year goals for urban sanitation

<i>Population</i>	<i>Current (1997)</i>	<i>Targeted (2017)</i>
Population	2,000,000	4,000,000
No. of households (average of 5 persons per hh)	400,000	800,000
In-house water supply	80% (Tegucigalpa 79%)	100%
Sewerage	50% (Tegucigalpa 58%)	100%
Sewage treated	4% (Costa Rica urban 2%)	100%

Source: City council report 1997

These goals demand large new water and financial resources, as well as substantially enhanced institutional capabilities. However, as table 2 suggests, "City X" faces somewhat stringent restrictions on each of these fronts.

Table 2. Requirements to reach full coverage of water and sanitation by 2017

<i>Resource</i>	<i>Source</i>	<i>Restrictions</i>	<i>Additional requirements</i>
Water	groundwater	pollution by infiltration, urban growth affects regeneration	130*10 ⁶ m ³ at 140 lt/person/day
Finance	domestic	international household purchasing power, credit availability, economic risk	water: USD 49 million (capital cost USD 150 per household) sewerage: USD 367 million (USD 600 per household)
Institutional capability		lack of trained staff and fiscal policies	new technicians, funds for O&M, improved control and capabilities

In addition, "City X" officials strongly feel that policies should be consistent with targeted goals and existing restrictions. Hence, they favour (rather optimistic) policies based on the following.

- ◆ Households and communities should contribute to the construction of new facilities and their operation and maintenance. Flexible arrangements will be set up to allow communal management according to local resources. Local participation is expected to cut construction costs by, say 20%, and O&M costs by, say 30%. In short, decentralised policies based on flexible public and private partnerships will be followed.
- ◆ Users of water supply services must be charged the "financial costs of abstracting, transporting, storing, treating and distributing the water and the economic costs of water as an input" (Briscoe and Garn, 1994:19). Sewerage requires more complex financial arrangements. Following Briscoe and Garn, costs "should be assigned to different levels according to the benefits accruing at different levels" (ibid 20). City officials estimate that 75% of construction and O&M costs should be assigned to "City X" households, and the rest should be charged to other stakeholders (industries etc.).
- ◆ Increased institutional input will enable capital costs and operation and maintenance costs to be cut by 20%.
- ◆ No subsidies will be granted, yet officials think it is both socially and politically infeasible to charge poor households more than 18% of their estimated incomes (average plus hidden) for water and sewerage. This figure exceeds what poor households currently pay to informal water vendors for a much more limited water supply in some cities such as Tegucigalpa, Honduras.

Unpleasant hints

For strategic planning purposes officials need some idea about the "big picture". Can sewerage for all be realistically envisaged as "City X"'s sanitation policy goal for the year 2017? In other words, should all efforts be directed toward the universalization of sewerage?

Table 3 suggests that "sewerage for all" as a policy goal seems to run into difficulties, even if the city assists in applying sound principles. In spite of full cost recovery policies, and of cost reduction through local participation and increased institutional efficiency, the City expects poor households to face payment difficulties. Even if poor households were willing to pay up to 18% of their monthly incomes for water and sanitation, unless the economy substantially improves, the City does not expect them to provide additional monies.

Table 3. Financial consequences of sewerage for all in "City X"

<i>Item</i>	<i>1997</i>	<i>2017</i>	<i>Difference</i>
No. of households	400,000	800,000	400,000
poor	200,000	482,000	282,000
non-poor	200,000	318,000	118,000
Water consumption (m ³)			
used by the poor	35,000,000	123,000,000	88,000,000
used by non-poor	35,000,000	81,000,000	46,000,000
Total	70,000,000	204,000,000	134,000,000
Investments (USD) in			
water			49,000,000
sanitation			367,000,000
Total			416,000,000
O&M costs	37,200,000	96,000,000	59,000,000
Financial surplus/deficit*			
water			0
sanitation**			28,000,000 (for poor) 6,500,000 (non-poor)

* Figures refer to cumulative deficit during the period 1997-2017

** Non-poor willing to pay 2.5% of income for water and sanitation respectively, and poor willing to pay 9% respectively

Given that costs top payments from poor households which comprise the majority of the new demand in the year 2017 the water and sanitation system will confront an increasing financial deficit (USD 27.9 million in that year). All of this deficit comes from sewerage. Unless "City X" receives permanent and increasing external transfers (external funds or national funds via central government) the financial situation cannot expect to improve. There is no reason, however, to expect flow of external resources to offset the deficit.

Finally, City officials expect a rapidly increasing water demand. If consumption patterns remain unchanged, by the year 2017 water demand may reach a level three times higher than 1997, prompting rising costs and scarcities.

Policy dilemmas

"City X" officials know that even if they choose a "sewerage for all" policy goal (and pray for the water and money to come), many poor households will continue using other sanitation alternatives for a long time. Even if open defecation is eliminated - a short term goal - sewerage should not be expected to follow shortly.

If "temporary" encompasses a rather long period the notion of low-cost sanitation as a substandard technology must also be called into question. However, the low-cost technologies at hand (pit, VIP latrines) seem improper for dense urban settlements. New and substantially improved sanitation alternatives must be developed.

"City X" officials urgently need affordable sanitation options. At issue are not just the principles of sound financial and management policies of urban sanitation: the fundamental problem seems to be that sewerage for all as a policy goal seems out of reach, even if sound financial policies are applied. Who is going to pay for a "sewerage for all" goal? Running up an astronomical bill seems not to be a realistic response. In an era of fiscal austerity and economic transformation, shopping around for hundreds of millions of dollars seems futile.

Finally, extended sanitation coverage to all of the sprawling population poses a nearly impossible task for City X's inefficient sanitation institutions. If they perform ill at the existing coverage levels, what can be expected other than managerial chaos if coverage expands? Also, some functional order must be created in a city where sanitation authorities traditionally have allowed a confusing gamut of strategies in the management of human waste. For example, when dealing with substandard solutions "City X" officials actively or passively nurture de facto decentralization. This occurs when no specific institution deals with the problems of vast urban areas, and communities have to manage human waste disposal at their own expense or with the help of private organisations.

Issues in the large-scale application of new sanitation policies

In terms of strategic thinking, "City X" needs new sanitation approaches upon which financial, institutional, organisational and technical policies must be consistently implemented. Whatever the specifics, the approaches seem to rest on a few unavoidable principles:

- water must be considered an economic good
- "City X" must have affordable sanitation
- high-quality sanitation must play a major role in sanitation policies

- sanitation alternatives must be environmentally sound, and
- new decentralised institutional arrangements must be developed

These seemingly simple principles, known as "eco-sanitation" (Winblad et al., 1997) launch "City X" into unchartered territory and experimental programmes should be carried out before large-scale applications are considered.

The policy goal for experimental urban eco-sanitation programmes is to set up safe, affordable and effective urban sanitation systems in densely populated areas. Such a goal faces two critical issues: on the one hand, making scores of sanitation devices work properly (performance of devices) and, on the other implementing the safe handling, transportation and reuse of the output of these devices (handling of output).

From an institutional perspective, City officials should initiate sweeping reforms to enable the implementation of new sanitation policies, even at an experimental stage. Reforms go beyond improving the efficiency of existing public institutions. These were set up to manage centralised flush systems that involve complex technical tasks and substantial financial resources, and little if any local training, education and participation.

New sanitation policies aimed at tackling extensive urban sanitation problems call for decentralised institutional arrangements based on extensive community participation in the design, construction, operation and maintenance of such systems. Community participation should be coupled with a strong and enforceable regulatory framework and stable cooperation between stakeholders such as households, local organisations, non-governmental organisations municipalities, private firms and public institutions.

New sanitation policies imply a functional partnership between stakeholders. Institutions monitor and evaluate the participation of many actors, including households and communities, in the safe handling, transportation, storage and disposal of output of toilets.

In short, in a new regulatory framework institutions perform key policy functions:

- defining standards for the handling, transportation, storage and reuse of urine and desiccated or composted material
- establishing monitoring and evaluation procedures
- implementing systems of incentives and sanctions, and
- mobilizing and allocating resources to fund the construction of sanitation systems

To control and monitor local eco-san systems one may consider a number of options involving varying degrees of decentralization. For example, in cities where technically able private firms exist, they could undertake these functions. In such cases community organisations could have the right to select the enterprise in charge of monitoring their community sanitation from a pool of authorized firms. However, in cities with more stringent technical and institutional capabilities, policy makers may rely on simpler arrangements. Traditional systems may be adapted to perform basic control and monitoring over sanitation devices, for example, the donkey system in the old city of Harar in Ethiopia. Finally, public officials may explore the desirability of making different sanitation systems coexist.

Conclusion

In the sprawling cities of the developing world "sewerage for all" will probably have low economic and institutional feasibility and could prompt acute water scarcities. In spite of its egalitarian ethos, "sewerage for all" as an ideal may actually deepen current inequalities in water supply and sanitation. It will also provide further environmental problems. Given stringent financial and institutional capabilities a probable outcome is "sewerage for some, substandard sanitation for the poor, and pollution for all".

The time is ripe to implement alternative urban sanitation policies. However, these require a preliminary experimental stage before going up to scale. Experimental projects have manyfold goals: to adapt sanitation practices and beliefs; to test technologies; to set up standards; to test the effectiveness, affordability and safety of handling; transportation and treatment systems; to develop a fit regulatory framework; to train stakeholders; and to build up organisational and institutional capabilities.

References

- Briscoe, J. and M. Garn, 1994. *Financing Agenda 21: Freshwater*. Paper prepared for the UN Commission of Sustainable Development.
- Dudely, E. and U. Winblad. 1994. *Dry latrines for urban areas*. Mexico. 2nd SANRES Workshop.
- Reynolds, J. 1997. *El recurso hidrico. San José, Costa Rica*. Informe final consultatoria del proyecto COS 94/003 "Estado de la Nación en desarrollo humano sostenible".
- Winblad, U. et al. 1997 *Ecological sanitation*. Draft.
- World Bank. 1993. *World development report: Investing in health*. New York. Oxford University Press.

Chapter 3

Case studies from various countries and projects

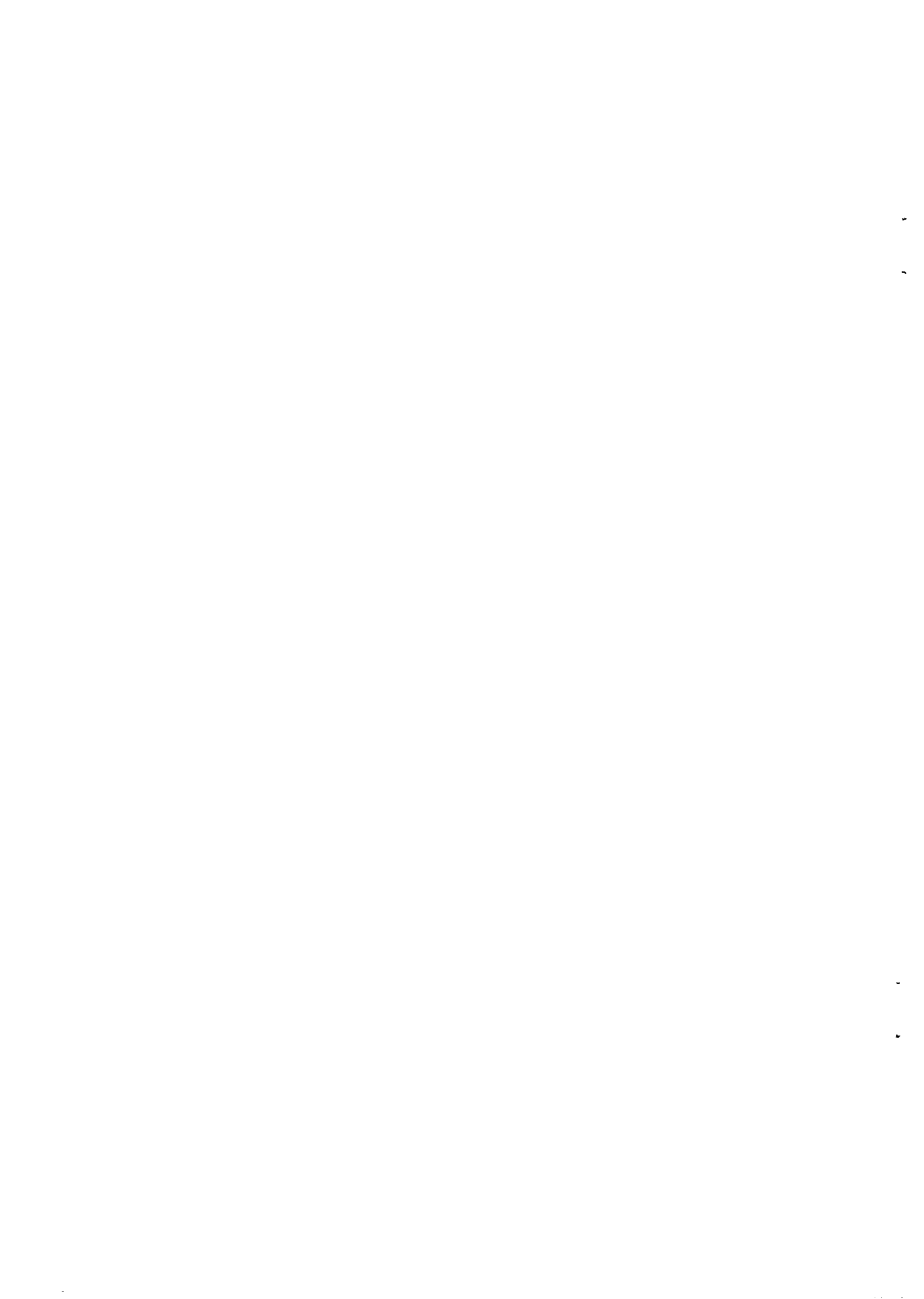

3.1

DRY SANITATION IN MORELOS, MEXICO

George Anna Clark, Environmental Program Coordinator, Espacio de Salud, A.C., A.P. 1-1576 Cuernavaca, Morelos 62001, MEXICO (esac@laneta.apc.org)

Introduction

I will present the experience of César Añorve, who promotes a modified version of the Vietnamese double-vault toilet in Mexico. His innovations include an up-scale urine-diverting toilet seat and a variety of applications, including adapting the toilet within the home. Finally, I'd like to share some reflections on the economic and political implications of appropriate technologies based on our experiences, and I'll briefly describe an urban gardening project using human urine as fertilizer.

My involvement in this project began when I met César nine years ago. I work for Espacio de Salud, a Mexican non-governmental organization working in health and environment. In addition to providing training and developing programmes in appropriate technologies and sustainable agriculture, I'm the proud owner of a "dry toilet".

Background

In Mexico, half of the population goes without sewage services and more than 30% does not have water piped into their homes. On a national scale only 13% of wastewater is treated, and only 2.6% of the total is processed in treatment plants that function adequately (Merino and Guevara, 1991).

Gastrointestinal infections are the second cause of infant mortality (Centro de Estudios de Población y Salud, 1987). Many people believe these infections are caused primarily by a lack of sanitation services.

Although it's true that the lack of sanitation systems has serious community health consequences, water pollution is, nevertheless, caused in large part by conventional sanitation systems. The massive quantity of water required by these systems also contributes to the general scarcity of this vital element. Such ecological costs are unsustainable in the long term.

It's also impossible for the entire population to be connected to the sewage system. The water and financial resources available are inadequate for the entire urban population to receive potable water, piping for the evacuation of wastes and costly treatment plants for domestic wastewater in the foreseeable future.

The metropolitan area of Cuernavaca, Morelos' largest city and capital, sits in the foothills of the Chichinautzin mountains, which run west and east and separate Cuernavaca from Mexico City to the north. Heavy rains fall on the oak- and pine-covered forest in the mountains. Where topsoil removal and clear-cutting haven't taken their toll, the water filters into the subsoil and travels to natural aquifers made of volcanic rock in the subtropical valley to the south. Unfortunately, this subterranean water route is covered on the surface by houses - houses with latrines, houses with inadequate septic tanks, houses with sewage water spilling directly over ravines and even some houses which send their sewage water to treatment plants, but unfortunately the plants are seriously ineffective.

As a result, the springs, wells and irrigation canals are heavily contaminated with faecal material. This results in waterborne epidemics such as cholera, infectious hepatitis, gastroenteritis, dysentery and typhoid fever, as well as the spread of skin diseases. In one city, old sewage and potable water pipes disintegrate, leading to the mixing of the waters, and consequently a cholera epidemic. For people of few economic resources, the problem has been literally fatal.

Urbanization and industrialization during the past 20 years in the state of Morelos have caused severe ecological problems. The population density has increased dramatically since 1985, with immigration of peasants escaping the rural crisis of neighbouring states, as well as many from Mexico City escaping air pollution and the threat of another earthquake.

In the periurban areas of Morelos' major cities, the lack of adequate infrastructure results in pollution and serious health risks. Wastewater eventually mixes with irrigation water which, until 1991, was used in vegetable production.

Because of the resulting high faecal content in vegetables, the government has prohibited irrigation for vegetable production, and has threatened to destroy crops and jail peasant farmers. This affects 43,271 hectares of rich agricultural land (MOCEDMA, 1993), where rain falls for only four months out of the year. The prohibition has intensified the crisis facing farmers, prompting them to sell their lands in small parcels, which further increases urbanization without the necessary infrastructure, and thus means more pollution.

This situation has earned Morelos its reputation as one of the most polluted states in the Republic. Fortunately, its other "claim to fame" is its active social organization. Morelos has been a hotbed of popular movements since the beginning of this century, when a poor peasant farmer, Emiliano Zapata, organized other peasants and led the Revolution in southern Mexico. The revolution of the last 25 years has been that of the Roman Catholic church, with poor members embracing Liberation Theology, organizing their communities, analysing the Bible according to their reality and working towards social transformation. Still another factor is Cuernavaca's reputation as a meeting ground for intellectuals. One of the results of this rich history of struggle and organization is the formation of a variety of popular movements and organizations.

Many groups, which initially organized around themes such as social, economic and political injustice, have also become aware of environmental concerns, especially as epidemics have increasingly affected their low-income constituency. They often request technical assistance to facilitate critical analysis of the causes, problems and alternative solutions. Their promoters are trained in popular education methodologies as well as technical aspects of dry sanitation in order to facilitate analysis, and provide training and follow-up in their communities.

Morelos gives us the perfect context for successful dry sanitation: widespread gastrointestinal epidemics, agricultural crisis, lack of water infrastructure, social organization and awareness on the part of popular sectors, and finally, the ever-worsening economic crisis which Mexico has suffered for over two decades.

César Añorve, an architect and entrepreneur, began promoting the Vietnamese double-vault toilet in Mexico approximately 15 years ago. Many individuals, groups and organizations have collaborated with him over the years, at times formally, at times informally. Although we don't share a common organization or name, we do share the following general goals.

Goals (environmental, social and economic)

- 1 Reduce water consumption and causes of water pollution. Because the dry toilet doesn't use water it attacks the root of water pollution problems, rather than merely treating the symptoms. One argument in favour of the dry toilet is that it avoids the costs of supplying 100-150 litres of water per person per day, as well as the corresponding infrastructure costs. And it means less water will be extracted from aquifers.
- 2 Facilitate the capture and absorption of water on-site. Domestic grey water, without excrement, can easily be returned to local soils, thereby recharging the water table.
- 3 Transform excrement into soil conditioner and fertilizer. This alternative permits cities to become once again a source of cultivable land. Dried excrement mixed with soil rich in minerals typical of the Cuernavaca valley produces a high-quality arable soil. The contribution of thousands of ecological toilets could also be a "gold mine" of fertilizer for parks, as well as the city's nurseries and gardens.
- 4 Enhance the credibility of alternative sanitation. Our projects go beyond the idea that alternative systems should be relegated to those areas without conventional systems. By encouraging the on-site treatment of human waste and water in the countryside and in low-income urban neighbourhoods, we demonstrate what could be a practical alternative for the entire city.
- 5 Foster local autonomy by reducing dependence on centralized services. Often low-income communities, especially squatter settlements, organize themselves around issues which evolve into demands for services from the government. This struggle and commitment, the unity of the community, is then transformed into a dependency upon the government. The service is eventually offered, but with political, economical and environmental strings attached. On the other hand, the dry toilet is a daily reminder that people are capable of providing their own services.
- 6 Strengthen the local economy - explained below.
- 7 Demonstrate the capability of civil society to organize itself and use its imagination. Communities make suggestions, introduce modifications, and create their own promotional and training strategies. This process of empowerment spills over into other aspects of community life, including other environmental issues, health, education and democracy (Añorve, 1994).

Accomplishments

Major accomplishments include the design of the toilet seat itself, its application in urban areas, and non-technical innovations.

Toilet seat design

When César began promoting the dry toilet, he advocated squatting (as in the original Vietnamese model) rather than using seats, for health reasons. However, the users convinced him that adopting the dry toilet was enough of a change for them - he should not push his luck. César therefore began converting 16 litre buckets, wrapping them with chicken wire to which cement was applied, and adding a funnel for urine diversion.

A period of experimentation with several models and different materials followed. However, interest and sales increased greatly in 1989, when he began to produce colourful toilet seats which copied the "conventional" design. We feel this innovation has been a major factor in the success of the project, as even the poorest sectors aspire to modern conveniences.

Client feedback brought modifications in the seat design. They complained that the first model was too small - they commented that it was probably adequate for César, but César is quite short!

Women were concerned that the urine diverter was also too small - aiming was difficult! The second was too big and much too heavy, but the latest is both of adequate size and aesthetically pleasing. Men, however, complain about having to sit down while urinating, so César again adapted the technology, designing a domestic urinal.

César designs and builds his own moulds for use in his seat production workshop, and he also distributes them to other independent workshops. After drawing the toilet seat design, a prototype is built by hand out of pressed board and covered with plaster. After drying, César applies fibreglass, in order to produce the mould.

The vast majority of toilet seats produced in his workshop are made of cement and sand. He has also used fibreglass or a polyester resin/sand mixture to make high-quality, extra-light seats. However, these are quite costly and more harmful to the environment.

A few ceramic seats have also been produced, but financial resources have been inadequate for purchasing an industrial kiln. A plastic recycling workshop is interested in producing recycled plastic seats, but the required mould (made of steel) is financially prohibitive.

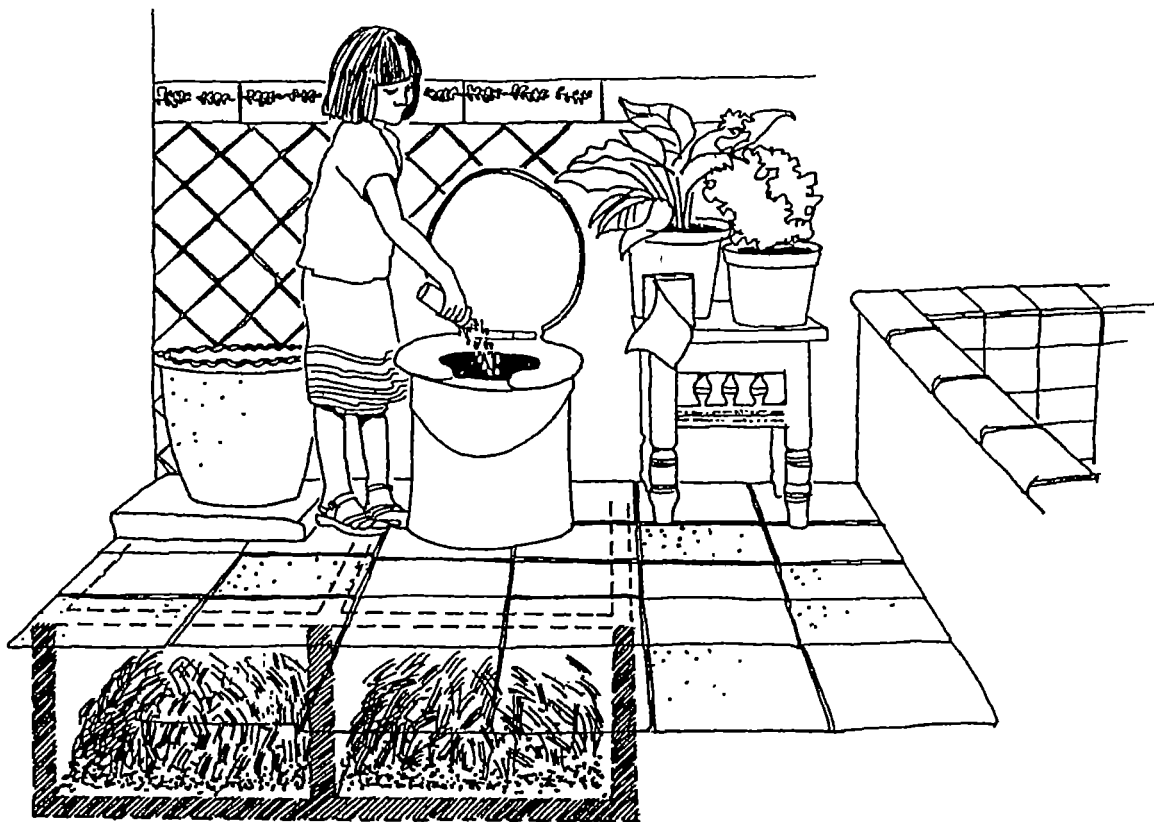

Figure 1. The bathroom in César Anorve's house in Cuernavaca: A double-vault, dehydrating toilet with urine diversion. The seat-riser is movable. The vault not in use is covered with a ceramic tile and a pot for used toilet paper.

The toilets are sold for 130 pesos (less than US\$18). The cost of production is 80 pesos. The profit is used to cover expenses incurred in providing technical assistance. An average of 30 toilet seats are produced per week in the workshop in Cuernavaca, which employs up to seven persons who produce, paint and deliver the seats, as well as giving technical assistance and follow-up.

The total cost for building the entire structure, with brick chambers and superstructure plus a cement roof is approximately \$1200 Mexican pesos (US\$150+), including materials and labour. This is about 1/10 of its conventional counterpart when compared on a domestic level. If the cost of sewage pipes in the streets, treatment plants etc. is added to this equation, the difference increases astronomically.

Application of the technology

We have explored and documented several applications: in rural areas, suburban zones, cities, residential neighbourhoods and even apartments. We encourage architectural inventiveness in order to offer civil society a broader range of options, for example dry toilets incorporated into the interior of a house in an urban setting. At the same time, we attempt to enrich the range of technical solutions according to the characteristics of the physical setting (slope, flooding etc.). We also try to diversify appropriate technologies and create access channels or stimulate existing networks.

Our state of Morelos offers a clear example of the adaptability of this technology to several climates. Dry latrines have been installed in each of the 36 municipalities, within three distinct climatic zones.

Northern Morelos has a humid, temperate climate, with an altitude of 2000-3000 m above sea level, an average temperature between 9 and 12°C, and precipitation over 1400 mm annually. Central Morelos drops to approximately 1500 m. It has a humid, semitropical climate with rainfall averaging between 1000 and 1500 mm and a mean temperature between 18 and 21°C. Dropping even further towards sea level, in southern Morelos rainfall averages less than 900 mm, with a mean temperature greater than 22°C (Mariaca and Narváez, 1992).

Most of the demand for dry sanitation comes from rural communities without access to water or conventional systems and/or financial resources to pay for them. Before installing the toilets, we encourage users to analyse other factors. Women tend to recognize environmental and health advantages more readily than men, and are also more active in organization and promotion. This is not surprising, as they are usually responsible for their children's health as well as managing household affairs.

Rural communities are not restricted by building codes. Although it wasn't our intention to win official recognition (by including the dry toilet technology within municipal regulations), in 1993 César obtained unanimous authorization by the Cuernavaca Public Works Department to build a house with a dry sanitation system. During this process, the State of Morelos Environmental Minister was consulted. Not only did she recommend the decision, but she also offered her support in carrying out bacterial analysis.

At this point we were able to seriously contemplate the inclusion of dry toilets within existing building codes in an innovative manner. Under César's leadership, the Morelos Academy of Architects is planning to lobby the state's municipal governments to modify their codes. The group also intends to invite the other state academies to do the same. Other proposals include incentives to users of appropriate technologies (such as dry toilets, as well as constructed wetlands and rainwater cisterns), through the reduction of water fees and/or tax incentives.

A key element which distinguishes our project from government proposals, as well as several independent projects, is that we believe the dry toilet is not only suitable but necessary in urban areas. It is not just a substitute when other water-based conventional services are not available, but rather it is a radical alternative to our current relationship with water (Añorve, 1994).

In order to encourage this transformation, César has developed modifications to the double-chamber model, including the design of a smaller, mobile system which reuses old washing machines and can be placed in a conventional bathroom, with plastic barrels fitted for large parties, picnics etc.

It is impossible to identify a precise figure for the number of dry toilets built in Mexico. César's workshop in Morelos has sold more than 6000 toilet seats, but many other actors are also involved.

At the federal government level the Secretary of Health and the Mexican Institute of Social Security have contracted César to train their promoters. One hundred local promoters in each of the three zones (north, centre and south) were trained last year, and 300 more will be trained this year. Under the Institute's programme 1337 toilets were built in 17 states in the past year. They also plan to establish local toilet seat workshops.

At the other extreme, approximately 90,000 dry toilets have been built in the state of Oaxaca alone.

A project for a million toilets to be built in the state of Mexico is also at the planning stage, as well as 10,000 in the municipality of Acapulco, Guerrero.

Other innovations

César's vision of the project's self-financing capacity can be compared to the engagement of two cogwheels which represent small economic cycles. The first cycle is the toilet seat construction workshop, which employs from five to seven persons. The second is made up of masonry workers which build the toilets' superstructure.

The first cycle's income comes exclusively from the sale of the toilet seats. The cost covers the organization of training workshops and follow-up. The second cycle is financed by the users as they contract a mason to construct their toilet. The first cycle is a small, family-size business, whereas the second is a local labour exchange.

These two cycles are financially autonomous, but organically linked. The fact that a demand exists for the urine-diverting toilets does not mean that a large industry would be successful in exploiting it. Commercialization without personal follow-up - an inconceivable concept for industrial-scale economies - can only harm and even destroy the project.

The importance of follow-up after carrying out any alternative project cannot be emphasized enough, especially with the dry toilet. First, the necessary confidence in this "new" technology is obtained only after a trial period of several years, before a substantial number of community members will request it. Second, follow-up is a hygienic imperative. Although the technology is incredibly simple, the user must acquire certain habits which are consolidated only over time.

We have chosen to limit ourselves to small-scale production, in which the producer must also promote its use, organize neighbourhood groups interested in adopting dry sanitation, and offer training workshops for masons. In other words, the first cycle will rotate only if the second is put into motion, hence the image of two cogwheels organically linking the two cycles (Añorve, 1994).

One of our most important objectives is to strengthen local economies by creating local jobs, using local materials, requiring minimal investment and using simple technology. We feel the market

should respond to the necessities and aspirations of local communities, protecting the strong ties which still exist in Mexico despite the overwhelming effects of globalization.

Our model offers the alternative of local, independent workshops, now numbering 15 across the country, as an alternative to migration, underemployment and exploitative wages. Our project is a very modest contribution: it is NOT a charity and would never work as such. It is a model which ensures environmental sustainability through the empowerment of local communities and economies.

We believe innovations related to the ecological dry toilet - and to industrial sanitation technology in general - should be institutional, political and economic, and not merely technical. In this sense our project has explored only an infinitely small part of the spectrum of these possible innovations. Raising public awareness is vital - through conferences, newspaper articles, political cartoons, public debates, colourful posters and other educational materials (Añorve, 1994).

Problems

In 1994, the Oaxacan state government and a businessman undertook a project which included large-scale toilet seat production. In addition to the fact that this destroyed the three small-scale toilet seat workshops based in the city of Oaxaca, this initiative produced the false expectation that industrial production would substitute the economic mini-cycles. The government established the objective of building 15,000 toilets within the first year, and 30,000 in each year afterwards.

We believe this project has two objectives: to increase the wealth of the functionaries involved, and to obtain political control. The project never goes beyond giving away the toilets, and lacks serious training and follow-up. Non-governmental organizations have had to step in to rescue this project, as the self-financing, autonomous local workshops have been destroyed.

Rather than the government facilitating the process, i.e. lubricating the motor, its role has been to destroy the initiatives of civil society. The local workshops cannot compete with international financing organizations and the government. Without the income from the sale of toilets, they cannot give away their expertise, training and follow-up (Añorve, 1994).

Another example of how corrupt government destroys local initiatives, rather than encouraging them: in a squatter settlement on the outskirts of Cuernavaca, a neighbourhood group asked for credit from the state public works department in order to build dry latrines. Although the petition was eventually approved, the department "underdelivered" materials (i.e. they stole them), and replaced the skilled mason workers with their own unskilled, lower-paid bricklayers, skimming the excess pay for themselves. As a result, the toilets were left unfinished and incorrectly built, and the residents disgusted and doubtful of the toilets. Nevertheless, the community had the organizational capacity to unite in protest, to finish the majority of the toilets without credit, and to denounce the repayment of the loan.

An example of the way that government doesn't recognize the environmental benefits of dry sanitation but uses it to co-opt communities which have suffered years of inadequate housing and services: 10,000 dry toilets are planned for the municipality of Acapulco, Guerrero. Strangely enough, the design includes a tube "for later connection to the sewage system".

The danger of these projects is that they will become a huge failure, and this impact will spread far beyond that of the geographical limits of these massive projects. It is always much easier to work in communities where dry toilets are an unknown, rather than where they are a known failure.

Plans

Plans for the future include:

- ◆ Link users to community composting centres, in which a service industry is created which empties the chambers, delivers the excrement and even urine to the local composting centre, then later sells the compost. These centres are slowly but surely emerging within the state, and thus far all are convinced of the value of the dry latrine. Some are already composting the product as a part of their work, but this has not yet led to the creation of a service business.
- ◆ Publish several materials, including:
 - + a brief how-to manual on building constructed wetlands for the on-site treatment of domestic grey water;
 - + a summary of our use of participatory methodologies and strategies for use by civil and governmental organizations working in alternative sanitation;
 - + a manual on the agricultural use of the dried excrement as well as urine, facilitated by laboratory analysis. This would include appropriate uses for different plants, and recommendations for processing and use. These products are already being used for agricultural purposes within the state, both in household gardens as well as in the larger-scale production of maize and eggplant, but not on a widespread basis.

Urine has been used in urban, family-scale gardening for a number of years through the ANADEGES network in Mexico City. This project, managed by CEDICAR, an ANADEGES affiliate, involves 1200 families who are producing vegetables in reused containers with worm-composted kitchen waste, urine and leaves.

The participants are restricted by lack of land and financial resources for investing in infrastructure or inputs such as synthetic fertilizers or pesticides. Many also require lightweight growing containers, as the only available space for vegetable production is on top of their roofs.

The plants are grown in used buckets or tyres, filled with deciduous tree leaves, leaving space for a 3-5 cm layer of worm compost, into which seeds or seedlings are placed. A drainage hole is perforated in the side of the container, 5-10 cm from the bottom. Urine, an excellent source of nitrogen, is fermented and then diluted before use in watering the plants. (Ceballos, 1997).

Conclusions

Those of us who participate in this project share the idea that a radical transformation in sanitation is urgent and possible. We believe that it is necessary to change society's current perceptions. The only way to do this is through educating each other - talking with neighbours, farmers, business people, housewives and children - so that we can all, together, change our relationship with water.

References

- César Añorve (1994): *Sociedad civil y tecnología sanitaria alternativa: El caso del excusado seco ecológico, 10 años de actividades en Morelos, México*. Habitat International Coalition, Mexico City.
- Centro de Estudios de Población y Salud (1987): *Encuesta nacional de fecundidad*.
- Yolquetzatl Ceballos (1997). *Organic Food Production in Marginal Urban Areas*. SANRES (Sanitation Research) Project.
- Eduardo Mariaca and Yuriria Narváez (1992): *Soluciones Alternativas Nueva Santa María*.
- Héctor A. Merino and Guevara (1991): *Provisión de agua y drenaje en las ciudades mexicanas. Un reto permanente*. Banco Nacional de Obras y Servicios Públicos (Banobras).

3.2

EL SALVADOR EXPERIENCE WITH DRY SANITATION

Jean Gough, Apartado Postal 1114, San Salvador, El Salvador (jgough@unicef.org)

Introduction

Environmental factors, including a high water table, a long coastal area and low water coverage, have forced the Government of El Salvador to consider the construction of dry toilets. These require no water for the disposal of faeces and achieve almost zero discharge, therefore do not contaminate the scarce drinking water. Dry sanitation systems require that the users have a good understanding of the process involved and critical involvement in their use and maintenance. The dry sanitation concept applied in El Salvador is based on urine diversion, pathogen destruction and reuse. In this approach public health and handling problems are reduced step by step: urine and faeces are collected separately, faeces go through a process of pathogen destruction based on dehydration, and both urine and faeces can be reused.

The double-vault dehydrating toilet: the Hermosa Provincia experience

In 1987, the Ministry of Health of El Salvador, with support from UNICEF, initiated a pilot project on the Pacific coast to determine the cultural acceptance and feasibility of the double-vault dehydrating toilet with urine diversion, called in Spanish *Letrina Abonera Seca Familiar* (LASF). The LASF toilet is based on the Vietnamese double-vault toilet and was introduced in Guatemala in the late 1970s by CEMAT - Centro Mesoamericano de Estudios sobre Tecnología Apropriada - an NGO based in Guatemala. Since then in El Salvador alone more than 100,000 of these toilets have been built.

The LASF toilet is built above ground. The receptacle consists of two compartments (vaults), each with a volume of about 0.6 m³. On top of each vault there is a seat with a urine collector. From the collector the urine flows via a pipe into a soakpit or a jar. In one of the walls there are hatch-covered openings for the removal of the dehydrated faeces, which fall straight down into the vault. After using the toilet the user sprinkles a bulking agent consisting of ashes, lime or soil/lime or sawdust/lime mixture over the faeces. The vault thus receives only faeces and bulking agent. The paper used for anal cleansing is also recommended to be thrown into the vault, although according to Latin tradition the paper is placed in a special container next to the toilet and burnt. Every week the contents of the vault should be stirred with a stick and more ashes added.

When the first vault is nearly full, it should be topped up with soil and the seat closed. The second vault should now be used. A year later, or when the second vault is nearly full, the first vault is opened. It will by now contain about 250 kg of a completely odourless, relatively safe dehydrated faecal material. The double chamber construction allows the contents on one side to dry adequately while the family continues to use the other vault. Studies by CEMAT and the Ministry of Health indicate that after about eight months of storage there is a rapid decline in *Ascaris* eggs, reaching zero after 10-12 months. Harmful bacteria are less hardy than *Ascaris* eggs and are not likely to survive in conditions where *Ascaris* eggs cannot.

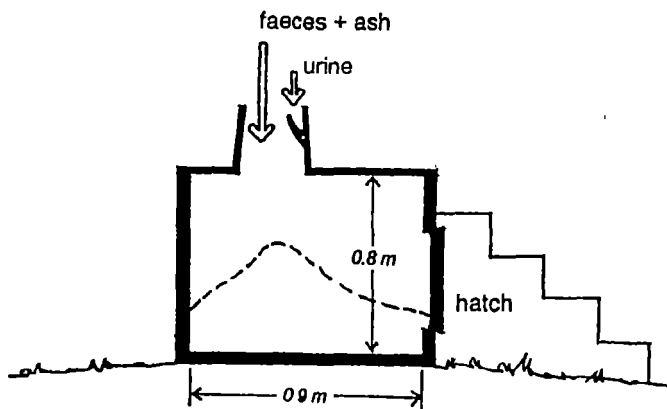

Figure 1. LASF toilet - section

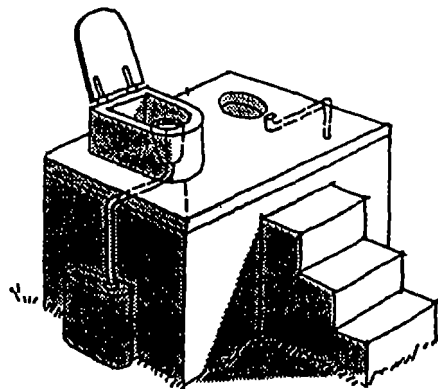

Figure 2. LASF toilet

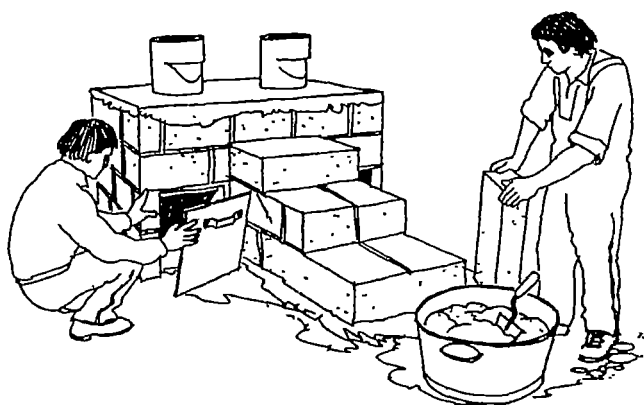

Figure 3. Hatch opening for the removal of dehydrated faeces

This type of sanitation system has been built in rural as well as urban areas of El Salvador. A project worth mentioning is the one developed in Hermosa Provincia, a low-income, high-density urban squatter community in the centre of San Salvador, the capital. Here all the 130 households built LASF toilets five years ago. There is little space between the houses and sometimes no backyards. The LASF is therefore usually attached to the house, sometimes even inside. As result of excellent community organization and adequate education, all units are functioning extremely well. As ash is not available in sufficient quantities, households sprinkle a mixture of sawdust and lime over the faeces. The dehydrated faeces are used to reclaim wasteland and in a nursery garden.



Figure 4. LASF toilet in Hermosa Provincia

Solar-heated dehydrating toilets: the Tecpan experience

On the basis of the experience gained over the past nine years with the LASF toilet a pilot project aimed at improving and expanding the concept was implemented in Tecpan, a semirural community near San Salvador, by the Ministry of Health, UNICEF and with technical assistance from SANRES, an R&D programme funded by Sida. The project attempts to answer the following two questions:

- Can the LASF concept be adapted to a single-chamber toilet?
- Does the addition of a solar-heat collector and/or an evapotranspiration bed improve the performance of an LASF toilet?

A total of 36 units have been tested. The types built were:

Type 1 - single chamber, urine diversion and solar heat collectors (Fig. 5);

Type 2 - single chamber, urine diversion, solar heat collector and evapotranspiration bed;

Type 3 - same as type 1, with vent pipe;

Type 4 - single chamber, urine diversion and solar heat collector, smaller volume and a pusher (Fig. 6).

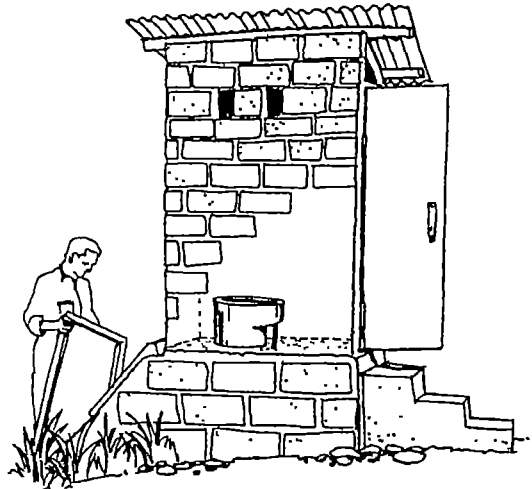

Figure 5. The Tecpan model

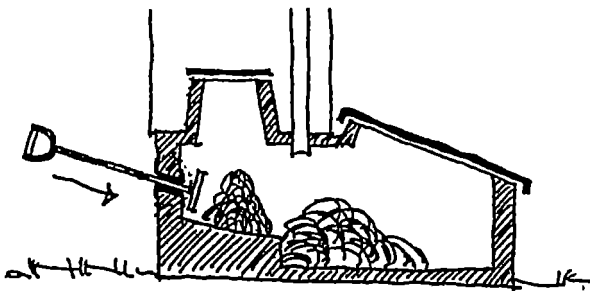

Figure 6. The Tecpan model with pusher model

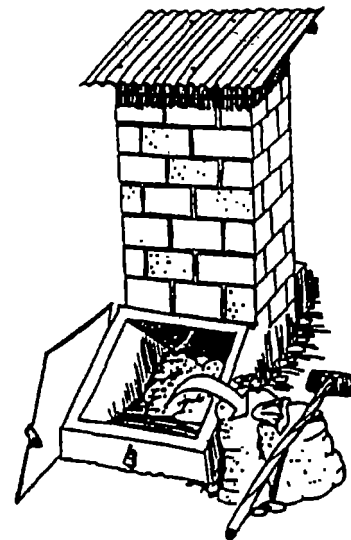

Figure 7. Management of the Tecpan

Toilets are managed as follows:

- ◆ They are used like regular LASF toilets. The input into the single chamber consists of human excreta and wood ash and/or a soil/lime mixture. Urine is piped into a small soakpit

close to the toilet. Toilet paper is placed in a bag or box next to the seat and burnt periodically, according to normal practice in El Salvador.

- ◆ Every one or two weeks the lid acting as a solar-heat collector is removed and the pile of faeces plus ash/lime/soil accumulated under the seat riser is shifted to the rear of the chamber.
- ◆ Once every two months the pile at the rear of the chamber is shifted to a sack and stored outside the toilet for at least 6 months.

From the project the following conclusions are drawn:

- * The test toilets are completely odour-free and there is no fly-breeding.
- * The addition of the vent pipe showed no change in the improvement of the performance of the sanitation system.
- * The 'pusher' is well accepted by the users.
- * The operational instructions have been followed by all the participating households, and both toilet types have worked very well.
- * The Type 2 toilets with evapotranspiration bed show a tendency to be marginally more humid - less dry, rather, as these toilets are extremely dry when operated properly.
- * The storage of the dehydrated faeces has been reported as a problem for some households.

The project demonstrates that careful management of a toilet, resulting from high motivation and understanding on the part of the families involved, can make an extremely simple technology work very well. It is clear that if the same level of care can be maintained over time and at scale, then the dimensions of the toilet chamber can be drastically reduced with the inevitable cost savings. Also, the odour-free character of the toilet suggests that they can be attached to the house, leading to further savings.

In the long term the success of this approach will depend on a successful communication strategy to translate the high motivation of a pilot project to a large-scale project. In Tecpan, because people saw rapid results they were prepared to overcome their initial reluctance to move the pile, and now accept it as normal.

Urine diversion in pit latrines: Chicuma experience

An interesting spin-off of our project in El Salvador is the finding that conventional pit toilets function much better with urine diversion; a test project was therefore carried out by ProVida, an innovative national NGO supported by UNICEF, in the rural community of Chicuma, Chalatenango.

In this community, more than two years ago, 48 single pit latrines with urine diversion were built. A special toilet seat with a collector is used to separate urine from faeces. The urine is channelled to an absorption pit. Pit depth varied from 1.5 to 2.0 m. An evaluation study carried out in May 1997 revealed that:

- * only in 28 units was urine diversion achieved properly, owing to poor construction;
- * ash was added to all units;

- * complete dryness was not possible to achieve, even when urine diversion was functioning properly, owing to geological conditions.

The findings indicate that urine diversion and the addition of ash to increase pH improves performance of the pit latrine, even if complete dryness is not possible to achieve. The improvements are impressive: no smells, no flies, no mosquitoes. The cost per unit is US\$55 without the superstructure.

Risk of not involving communities

The government of El Salvador, through the Social Investment Fund and financed by the Inter-American Development Bank, built 50,263 LASF units between 1992 and 1994, with a total investment of US\$12.5 million. These units were built by contractors without community participation and little or no training. An evaluation carried out in a sample of 6,380 families in 1994 showed that only 39% of the units were being used adequately, 25% were being used inadequately and 36% were not used at all. These findings led to the development of a hygiene education strategy that focuses on personal education for all family members through home visits, the participation of organized women in the implementation of the whole educational process, education materials and monitoring, and evaluation instruments easy to be applied by all actors at the various levels. The impact of this hygiene education model was significant: in a sample of 389 families it was found that only 20% were using the units properly, 58% were using them improperly, and 22% were not using them at all. However, after the completion of the first education module the percentage of proper use increased to 72%, and the latrines that were being used improperly or not at all decreased to 18% and 10%, respectively. The lesson learnt from this whole process is that the problem of dry sanitation is not the technology itself, but the interaction between technology and user. Therefore, the promotion of this type of technology should be on a personal and family basis, in order to provide advice on the spot, stressing the need to achieve behavioural changes, proper use and maintenance.

References

Dudly, E and Winblad, U (1994): Dry latrines for urban areas - the findings of the second SANRES workshop, Mexico City, November 1994.

Fondo de Inversion Social (1994): Diagnostico y recomendaciones proyecto letrinas aboneras, operaciones BID I y II.

Winblad, U and Kilama, W (1985): *Sanitation without water*. London: Macmillan.

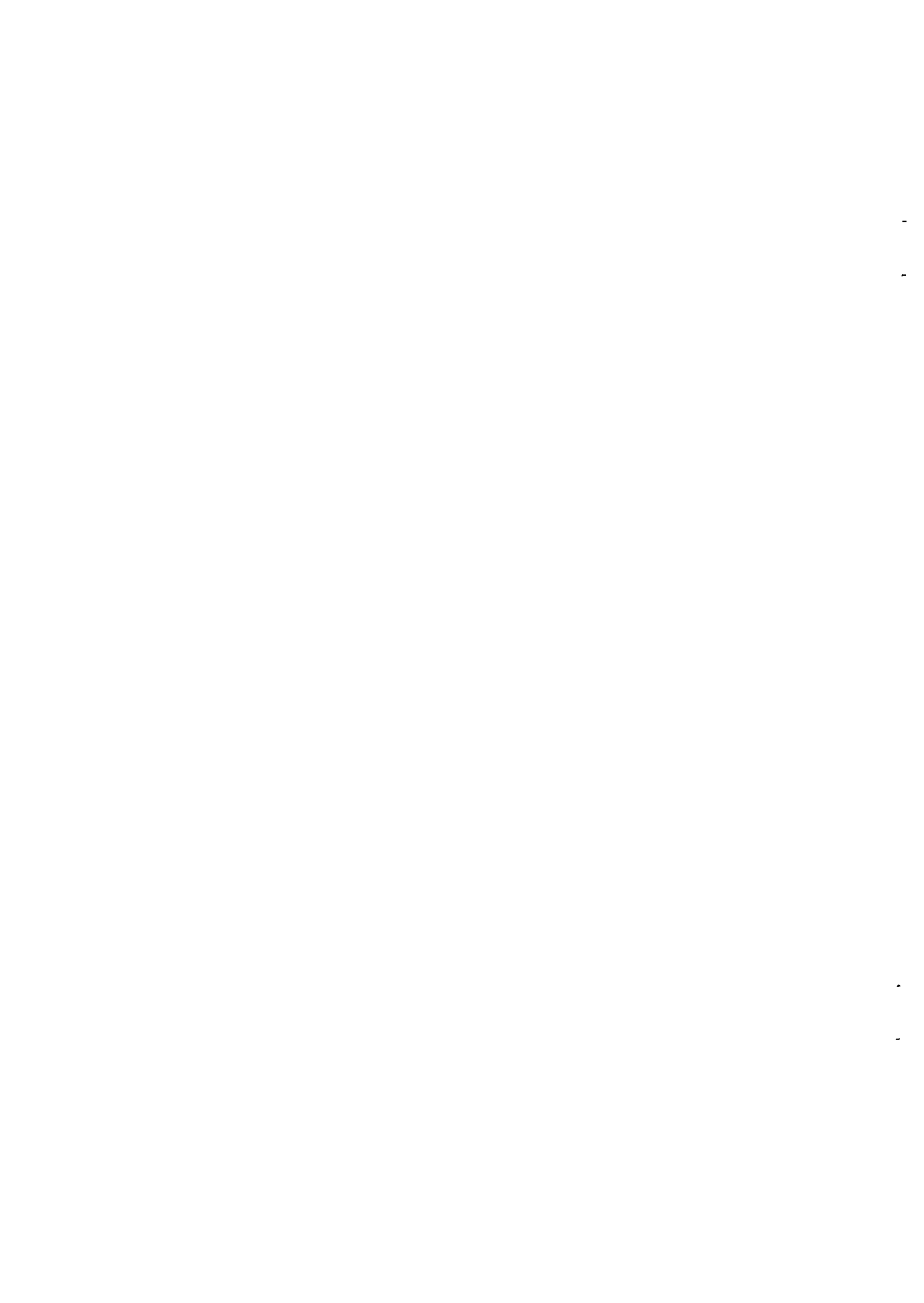

3.3

ZERO-DISCHARGE SANITATION FOR PACIFIC ISLANDS AND OTHER TROPICAL COASTAL ENVIRONMENTS

Dave Rapaport, Vermont Public Interest Research Group, 64 Main Street, Montpelier, Vermont 05602 USA (vpirg@together.net)

Introduction

The failure of conventional sanitation technologies to prevent pollution is of particular concern in small islands, coastal areas, places adjacent to fresh water resources and anywhere with a high water table. For example, nearly every Pacific island nation has identified critical environmental problems resulting from conventional sewage treatment technologies, including algal blooms and eutrophication in lagoons, dying coral reefs and contaminated drinking water. Only a policy of zero-discharge – based upon the presumption that excreta management should not interfere with natural systems, rather than that the environment has the capacity to assimilate contamination – can protect sensitive island environments. Several composting toilet designs have been demonstrated in Pacific island countries which overcome humid conditions to achieve zero-discharge of pollutants while requiring relatively low maintenance from users.

Sewage pollution in the Pacific islands region

In a region of small islands occupying 30 million square kilometers of ocean, it is easy to see that the wellbeing of its people is directly tied to the health of the marine environment. The natural resources provided by coastal habitats and the open ocean are the basis for traditional subsistence as well as growing commercial activity. With the exception of highland regions of Papua New Guinea and elsewhere in Melanesia, the cultures and identities of Pacific island peoples are intimately linked with the ocean. However, because their coastal ecosystems are extremely sensitive to changes in water quality, and because the groundwater tables in populated areas are generally high, Pacific islands are extremely vulnerable to pollution.

Coral reefs, for example, are particularly threatened, since corals flourish in nutrient-poor waters and suffer severe effects from the influx of nutrients from sewage discharges in several ways. The increased BOD which accompanies high levels of nutrients starves reef creatures of oxygen and encourages the growth of aquatic plants, which both benefit from the high nutrient levels and can tolerate low amounts of oxygen. Seaweeds and the growth of phytoplankton populations, which also benefit from the nutrients, prevent light reaching the corals, harming them still further. In addition, large quantities of nitrates are toxic to corals, and high concentrations of phosphates can harm coral directly by inhibiting skeletal growth.

The failure of sanitation technologies to prevent pollution is therefore of particular concern to Pacific island countries. Nearly every Pacific island nation has identified critical environmental and public health problems resulting from the disposal of human excreta. These have included algal blooms and eutrophication in lagoons, dying reefs, contaminated drinking water wells and outbreaks of gastrointestinal disease and cholera. The causes of this pollution include overflowing latrines and privies, water-seal toilets, septic systems, sewage treatment plants, and the complete lack of sanitation facilities in some places.

In fact, pollution from human sewage (along with household garbage) has been labelled by the South Pacific Regional Environment Programme (SPREP) as "perhaps the foremost regional environmental problem of the decade". For example, SPREP's Land-Based Pollutants Inventory found that the discharge of domestic wastes is the largest contributor of contaminants to the region's marine environment, fouling coastal waters with an estimated 21,675 tonnes of BOD, 12,252 tonnes of suspended solids, 10499 tonnes of nitrogen and 1,250 tonnes of phosphorus annually.

Groundwater pollution problems, which were reported by 85% of Pacific island countries in 1991, often also result from conventional on-site disposal technologies that allow nutrients and pathogens to migrate through porous soils into shallow aquifers. In addition to the threat of contamination, the use of water to flush away human excreta can tax valuable and limited freshwater resources. On low-lying atolls and the coastal areas of larger islands this not only wastes water directly, but can cause salt water incursion to the water table. Water shortages were reported by 70% of the region's countries in 1991. Salt water is used for flushing in some systems, such as on Tarawa in the country of Kiribati, but these systems have been notoriously problematic.

The following examples from Pacific island countries serve to illustrate sewage pollution problems across the region:

- ◆ On Raratonga in the Cook Islands, contamination from septic systems is carried laterally by groundwater into the lagoon, contributing to increased algal growth, and high levels of gastrointestinal disease on the country's atolls has raised concern that the use of pour-flush toilets has polluted the shallow water table.
- ◆ Central wastewater treatment plants on Pohnpei and Chuuk in the Federated States of Micronesia, constructed with funds from the US Environmental Protection Agency during the 1970s, have failed owing to the lack of trained personnel and funding for maintenance, discharging essentially raw sewage much of the time. Poorly designed septic systems and simple water-sealed toilets are frequently found directly adjacent to coastal waters, and latrines which overflow in heavy rains are common in rural areas. There is a high prevalence of water-related disease throughout the country, and a number of studies have found sewage pollution to be adversely affecting coral reefs.
- ◆ In Kiribati, high population densities and rapid urbanization have led to groundwater pollution from the percolation of sewage down into the water table, as well as contamination of lagoon water, beaches and shellfish with microorganisms from human excrement.
- ◆ In the Marshall Islands, signs of eutrophication resulting from sewage disposal are evident adjacent to settlements, and particularly near urban centres. Stagnation of lagoon waters, reef degradation and fish kills resulting from the low levels of oxygen have been well documented over the years. There is significant groundwater pollution in the Marshall Islands as well. The Marshall Islands government estimates that over 75% of the rural wells tested are contaminated with coliforms and other bacteria. Cholera, typhoid and various diarrhoeal disorders all occur.

The need for zero discharge

The severe pollution problems in Pacific islands – despite the relatively widespread application of conventional sanitation technologies – offer testimony to the failure of the conventional approach, which seeks to control pollution after it has been created rather than prevent it in the first place. Conventional sanitation technologies simply attempt to send what are considered unwanted wastes underground, or to bodies of water where we cannot see nor accurately predict their impact. This may partially reduce pollution and health problems or shift them from one place to another, but it does not solve them. Instead, it is assumed that the pollution which results from these technologies can be safely assimilated by the environment.

Although it will always be difficult to ascertain the effects of a particular sewage discharge, particularly before they occur, the cumulative evidence of widespread environmental effects resulting from the use of conventional sewage treatment technologies in the Pacific and elsewhere suggests that reliance on the assimilative capacity of the environment has been a mistake. Only a policy of zero discharge of pollution to the environment can guarantee the protection of sensitive environments and human health.

Rather than devoting limited funds to researching how much damage the environment can handle, we should instead find out how little damage we can do. The assumption that the environment has the capacity to assimilate the pollutants in sewage must be replaced by the presumption that the management of human excreta should not interfere with natural systems.

Sewage pollution can be prevented by recovering human excreta as resources rather than disposing of them as waste. In natural systems there is no waste: all the products of living things are used as raw materials by others. By flushing excreta down the toilet and turning them into sewage, we break this cycling of nutrients and create pollution problems. If instead we mimic nature by turning what had been waste into valuable products, there will be no sewage of which to dispose.

This approach is far from radical. Leaders from around the world called for just such changes in 1994, at the Global Conference On The Sustainable Development Of Small Island Developing States in Barbados:

“Given that long-term disposal options are limited and will constrain sustainable development, small island developing states will need to look for ways of minimizing and/or converting wastes, such as sewage, into a resource (e.g. fertilizer for agriculture).” _

Although adopting this new approach will require a change in attitude, it will not require a sacrifice of sanitation or aesthetic standards. As described below, technologies are available which can prevent sewage pollution and still offer the modern convenience of conventional technologies.

Pilot zero-discharge sanitation projects on Pacific islands

In addition to protecting public health and sensitive coastal environments, major design constraints imposed upon sanitation technologies for use in the Pacific include a very humid climate and sociocultural conditions in which a high level of maintenance should generally not be expected from users. Several different composting toilet designs have been demonstrated on Pacific islands in recent years, which attempt to overcome these constraints to achieve zero-discharge and low maintenance requirements.

The CCD Toilet

Following on work initially conducted by Greenpeace in the Federated States of Micronesia in 1992, the Center for Clean Development, a US-based NGO, has developed an aerobic double-vault composting (DVC) toilet with very low maintenance requirements in which faeces are transformed into humus and the urine is evaporated. The CCD toilet consists of two watertight chambers, which may be built above ground or partially buried. As with other DVC toilets, excreta are deposited into one of the two chambers, which are used alternately to provide an extended period of composting time before the humus is removed for use as a soil conditioner.

What distinguishes the design from other DVC toilets is that it promotes aerobic conditions in the digestion chambers without the need for manual turning. Excreta fall on to a mat woven from coconut palm fronds resting on top of a nylon fishing net suspended inside the digestion chamber, separating the solids from the liquids. This "false floor" allows air to penetrate the compost pile from all sides. Bulking agents, such as coconut husks, small wood chips, leaves or vegetable food scraps, are added periodically through the toilet pedestal or squat plate, both to provide a source of carbon and to increase the porosity of the pile so that air can penetrate all the way through.

A large-diameter vent pipe draws air up through the pile from an intake opening located below the net along the rear wall of the chamber. This airflow also helps to evaporate the liquids that accumulate on the floor of the digestion chamber. Evaporation is further enhanced by wicks made from strips of polyester or rayon fiber (from old clothing), which are hung from the net to draw up the liquid from below, increasing the surface area exposed to the air stream.

When the compost pile reaches a height just below the toilet seat, the chamber is closed off by moving the seat to the pedestal on the other chamber and replacing it with a heavy concrete cap. When the second chamber is full, the compost in the first chamber is removed for use as a soil conditioner by scooping it out through an access opening or removing the net entirely. This is the only real maintenance required, besides the regular addition of a bulking agent and periodic cleaning of the seat with soap and a small amount of water. Experience thus far has been that it takes a family of up to ten people over a year to fill one digestion chamber.

A prototype of this design constructed in 1992 out of concrete blocks by Greenpeace and local participants in a pilot project on the island of Yap in the Federated States of Micronesia was used regularly by four adults and three children for 1 ½ years. Four slightly modified units were then built by CCD in 1994 on the island of Pohnpei, for use by individual families of from six to 12 people. Periodic visual inspection indicates that solids in the digestion chamber have undergone biodegradation, and that all excess liquids have been evaporated. In all cases the users have expressed satisfaction with the toilets and reported no foul odours. This is especially noteworthy given the humid climate of Pohnpei, where the average annual rainfall is 4917 mm (193.58 inches).

As of May 1997 all four of the CCD toilets were reported to be functioning well, based on visual inspection and interviews with the owners by a member of the project team. Remarkably, all but one of the demonstration units had gone more than 2 years before switching over to the second digestion chamber, indicating greater than expected capacity. The FSM national government is currently building at least 40 more units in Pohnpei with funds remaining from a rural sanitation programme, and the state's environmental agency has indicated its intention to require their use in environmentally sensitive areas. In December

1996 a CCD toilet was built in Fiji in a pilot project sponsored jointly by the South Pacific Commission and the Fiji School of Medicine.

Based on the initial experience with these limited demonstration projects, it appears that in a tropical environment with relatively high ambient temperatures, the CCD toilet can attain a degree of liquid evaporation and maintenance-free operation not previously reported for DVC toilets. All of the demonstration units have achieved zero discharge of pollutants for at least one and a half years of use. The CCD toilet offers promise as an appropriate solution for providing sanitation where environmental contamination is a major concern, and even in cultural settings in which a high level of maintenance is not likely to be expected, provided there is a supply of appropriate organic bulking agents available, such as leaves, vegetable scraps, coconut husks or wood shavings. Because relatively little compost is generated and no urine is available for use as a fertilizer, it may not be the most appropriate technology in areas where the reuse of excretal nutrients is expected to be a primary motivation for using dry sanitation.

Where water is used for anal cleansing, the CCD toilet may be combined with an evapotranspiration bed to treat excess liquids and still achieve zero discharge. This technology, based on the work of Dr Alfred Bernhart at the University of Toronto, is being commercially marketed in the US as a "Wastewater Garden" by Sustainable Strategies of Concord, Massachusetts. These lined, aerated sand and gravel trenches promote the growth of aerobic bacteria which enhance evaporation through the release of heat generated by their activity, and also make the nutrients in the wastewater more readily available to plants grown in the garden bed. An integrated CCD toilet and wastewater garden has also been designed with added capacity for use in public facilities.

University of Tasmania Centre for Environmental Studies Kiribati project

In a different series of pilot projects, a team from the Centre for Environmental Studies at the University of Tasmania and local counterparts have successfully tested several aerobic batch composting toilet designs in the Pacific island nation of Kiribati. One of these designs was a simple prefabricated "Cage Batch" toilet, developed originally for use in Tasmanian National Parks, which provides a combination of aeration, passive solar heating and insulation to assist the composting process. Another design utilizes modified 240 litre mobile garbage bins as the digestion chambers. The bin is placed below the toilet pedestal to receive excreta, and is replaced with another one when full. Air is drawn into the bin through a cut-out near the base, and comes in contact with the bottom of the compost pile through a mesh false floor. In addition, perforated ventilation pipes running vertically along the inside walls of the bin help to aerate the pile.

The University of Tasmania team has also demonstrated locally built batch toilets made primarily of concrete block. Excreta and bulking agents are deposited into two digestion chambers of approximately 1 m³ each, which are used alternately. The chambers feature a floor grate which allows liquid to drain into a tray below. Air is drawn in through mesh vent holes under the grates, up through the compost pile and exits via ventilation pipes which extend 1.5 m above the roof. Access to the chambers is provided by hinged doors which can be sealed to prevent the entry of insects.

Each of the designs relies primarily on drainage rather than evaporation of excess liquids to maintain aerobic conditions. In at least some of the trials a sealed evapotranspiration trench was used in an effort to achieve zero discharge of pollutants to the water table. The trench

consists of a 2 mm plastic liner placed on a bed of coral aggregate to deter crabs from burrowing underneath, below a perforated drainage pipe which is buried under coral aggregate and a top layer of sand. The surface is mounded to maximize rainfall run-off away from the trench, and the trench and adjacent area are planted with appropriate species, such as papaya and banana, to assist with liquid removal. Preliminary results of the trials on Kiribati indicate that each of these designs have been successful at producing an innocuous humus-like residual, and they seem to be well accepted by local users.

References

Sue Wells and Nick Hanna (1992). *The Greenpeace Book of Coral Reefs*. New York: Sterling Publishing Co.

SPREP, 1991-1995 Action Plan for Managing the Environment of the South Pacific Region, Annex I, South Pacific Regional Environment Programme, April, 1992.

Nancy Convard (1992). Land-Based Pollutants Inventory for the South Pacific Region. Apia: South Pacific Regional Environment Program.

Report of the Global Conference on the Sustainable Development of Small Island Developing States, Bridgetown, Barbados, 26 April-6 May 1994. New York: United Nations, 1994, page 16, Programme Of Action For The Sustainable Development Of Small Island States, paragraph 24.

Alfred P. Bernhart (1985). Evapotranspiration, Nutrient Uptake, Soil Infiltration of Effluent Water. Toronto, A. P. Bernhart.

3.4

NIGHTSOIL COLLECTION AND TREATMENT IN JAPAN

Saburo Matsui PhD, Research Center for Environmental Quality Control, Faculty of Engineering, Kyoto University, Kyoto, Japan (matsui@eql.eqc.kyoto-u.ac.jp)

Introduction

The collection and treatment of nightsoil, i.e. human urine and faeces, is unique to Japan. The key points to understanding this Japanese practice are sanitation and nutrients, which have determined policy development. The policy of handling human excreta is also affected by other factors, such as water, the environment, religion, culture, technology etc. The Japanese experience of nightsoil collection may provide useful suggestions to other countries intending to introduce new sanitation practices.

History

Japan introduced the practice of reusing human faeces and urine for agriculture in about the 12th century, possibly influenced by Zen Buddhist monks who had studied in China. The Chinese reused human excreta in the very early stages of their civilization. Japan introduced various cultures and technologies from China from the 4th century AD, but the introduction of reuse of human excreta was later. There was a need to use human excreta for agriculture, because of human population pressures and food production demand. Nutrients added to agricultural fields greatly increased their productivity. China seemed to be the only civilization that positively used human excreta as nutrients for agriculture, and even food for pigs, from its very earliest development.

There was also a need for urban sanitation, especially in Kyoto City, then the capital of Japan. Every summer there was a spread of waterborne and food poisoning epidemics. People worshipped a god called Gion, who could control such diseases. This worship is still very popular and formalized in the form of a summer festival in Japan. Japanese food culture required the eating of fish influenced by Buddhist ideology, so that fresh water quality, both for drinking and for fish, was very important. The practice of collecting human excreta from urban areas was initiated by farmers, and greatly changed the environmental conditions in urban areas. Cash crops such as vegetables and fruit were grown by those suburban farmers using human excreta.

The practice of reusing human excreta as nutrients for agriculture continued until the middle of the 19th century. Cities were so clean that during the 16th century Portuguese missions reported their astonishment to the Vatican. From the 17th to the middle of the 19th century, Japan was a closed country, which forced Japanese society to be ecologically closed. The reuse and recycling of materials, including human excreta, were very much encouraged. Farmers bought human urine and faeces at different prices from their customers in urban areas. Owing to its closed policy, Japan was not influenced by outbreaks of typhoid, cholera or other communicable diseases.

After the modernization of Japan in the middle of the 19th century, sewage work construction was very delayed by social factors, including war and the economy. Other factors included

strong opposition by farmers to the construction of sewage pipes, demanding that the nutrients in human excreta should not be wasted by discharging them into public sewers. Big cities such as Tokyo, Osaka and Yokohama gradually introduced public sewage works with final treatment plants. Sewage sludge was not used systematically for agriculture. Chemical nutrients were also gradually introduced. However, the end of the second world war changed Japanese society greatly, including its sanitation policy. Japanese farmers began the large-scale use of chemical fertilizers and stopped collecting human excreta, thereby creating critical sanitation conditions in urban areas. In 1954 the government enacted a new law of urban sanitation and the collection of municipal wastes (Public Cleansing Law), in which local authorities became responsible for collecting and treating nightsoil.

Collected nightsoil was very different from raw sewage in quality. Japanese civil engineers had to find a solution for the problem, studying western technology and inventing a new method. Technological development is described below. Finally, a high-technology treatment for collected nightsoil was developed, e.g. introducing membrane filter technology to separate the activated sludge and treated water, allowing bacteria- and virus-free effluent from the treatment plant. Nitrogen and phosphorus are biologically and chemically removed. Partial ozonation is applied for yellow colour removal in the effluent. However, salt cannot be removed from the effluent, so that dilution by groundwater is necessary to avoid affecting rice irrigation water, fish migration in streams, and drinking water sources.

Technology development

Quality of collected nightsoil

Human excreta are stored by each household in dry deposits in a tank. No water flushing is practised. There is a collection service by vacuum truck, once a month. The collected excreta are transferred to a dedicated nightsoil treatment plant, of which there are about 1,800 in Japan. All are operated by cities or towns, or public corporations. Table 1 shows the quality of collected night soil.

Table 1. Quality of collected nightsoil

Items	Average	Range
pH	8	
BOD 5 mg/l	11,000	8,000 - 14,000
CODMn mg/l	6,500	4,000 - 8,000
Suspended solids mg/l	14,000	8,000 - 20,000
Total solids mg/l	27,000	19,000 - 35,000
Total nitrogen mg/l	4,200	3,200 - 5,200
Phosphorus mg/l	480	280 - 680
Chloride mg/l	3,200	1,200 - 4,200

Compared to raw sewage, all items except pH are very concentrated, e.g. BOD5 is 200 mg/l in raw sewage, but 11,000 mg/l in nightsoil. Nitrogen concentration is also very high, with nightsoil being about 50 mg/l compared to sewage. Chloride ion concentration in raw sewage in Japan is about 100-150 mg/l. Phosphate concentration in raw sewage is about 20 mg/l.

Table 2. Performance of treatment plants for nightsoil

Type	Anaerobic digestion/ activated sludge	Aerobic digestion/ activated sludge
Plant capacity kl/day	54- 239	40-200
<i>Input night soil:</i>		
BOD5 mg/l	11,490	10,570
Cl mg/l	3,780	3,590
<i>After digestion process:</i>		
BOD5 mg/l	2,270	2,140
CODMn mg/l	2,790	2,350
Suspended solids mg/l	3,180	4,730
NH ₄ -N mg/l	2,790	1,800
Cl mg/l	3,190	2,840
<i>After activated sludge process:</i>		
BOD5 mg/l	48	26
CODMn mg/l	86	59
Suspended solids mg/l	39	47
NH ₄ -N mg/l	137	73
Cl mg/l	241	161

Evolution of treatment processes

Figure 1 shows the trends in the amount of waste treated and the evolution of treatment processes (Magara and Kawamura, 1992). Because concentrations of all chemical items are so high, it was necessary to develop a new technology for nightsoil treatment. We first introduced anaerobic digestion treatment in 1953. This was a direct introduction of the anaerobic sewage sludge process. This process required dilution of the nightsoil with water before digestion, because of the high ammonia concentration inhibiting the activity of anaerobic bacteria. However, anaerobic digestion could not produce a good-quality effluent that could be used in paddy irrigation so far as BOD, nitrogen and chloride ions were concerned. The activated sludge process followed to treat the effluent from the anaerobic digestion process. The next process was oxidation treatment, which was basically a digestion process in which sludge was aerobically digested at a much faster rate than with the anaerobic process, and nitrification was also introduced.

Table 2 shows the performance of nightsoil treatment plants. Total BOD removal by the anaerobic digestion/activated sludge process is about 93.8%, and by the aerobic digestion/activated sludge process is 94.4%. Chloride ions were not removed but diluted with water by a factor of 13 and 20, respectively, for anaerobic digestion/activated sludge process and aerobic digestion/activated sludge process.

The next process developed was standard denitrification, which eliminated the sludge digestion process and introduced the modified activated sludge process with its two stages of denitrification and nitrification. Figure 2 shows a flowchart of nightsoil treatment in which the effluent is disinfected by chlorination. This was to remove nitrogen from the effluent, which was required by paddy farmers to whom nitrogen control was important: too much nitrogen could cause crop failure. The nitrification process was much improved after developments in

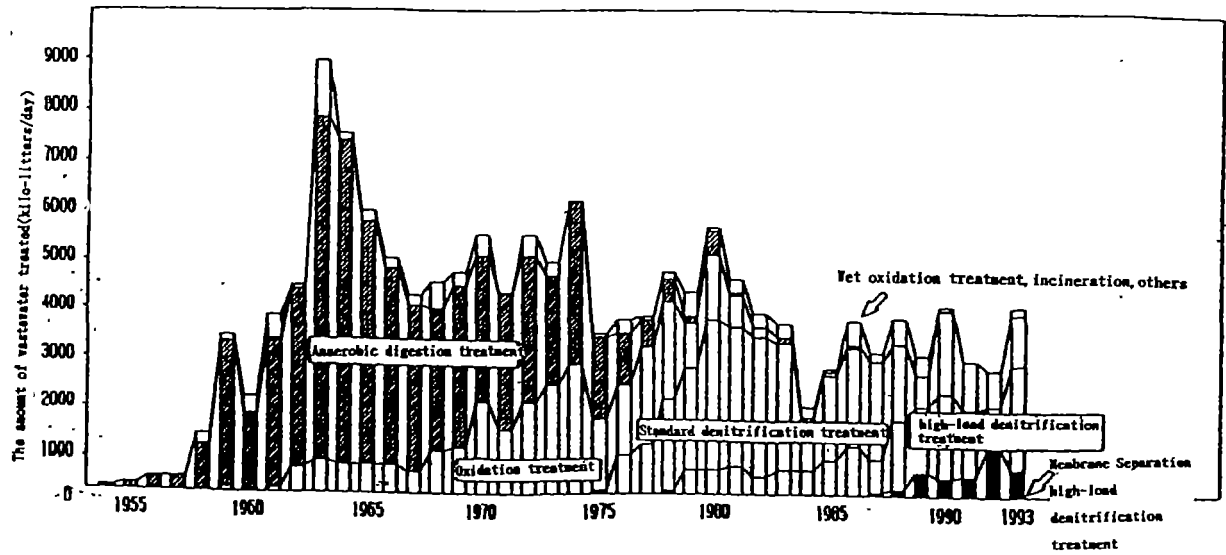

Figure 1. Trends in the amount of human excreta treated at facilities and the evolution of treatment processes

the field of biological wastewater treatment in the 1970s. Japanese scientists and engineers bravely introduced new technology into nightsoil treatment processes rather than sewage treatment processes. A high-load denitrification treatment was introduced in which dilution with water was not involved in the biological processes, but only before discharging the effluent. This process is truly a unique and most advanced biological process. Finally, membrane separation and high-load denitrification came into practice. Membrane separation provided many advantages in nightsoil treatment, such as the complete removal of bacteria and viruses, space saving for plant construction, easy control of odour etc. However, this high technology requires good engineers for operation and maintenance. It is also one of the most advanced technologies in the world.

Wet oxidation oxidates the sludge at high pressure and temperatures, but owing to difficulties in operation and maintenance it is not popular.

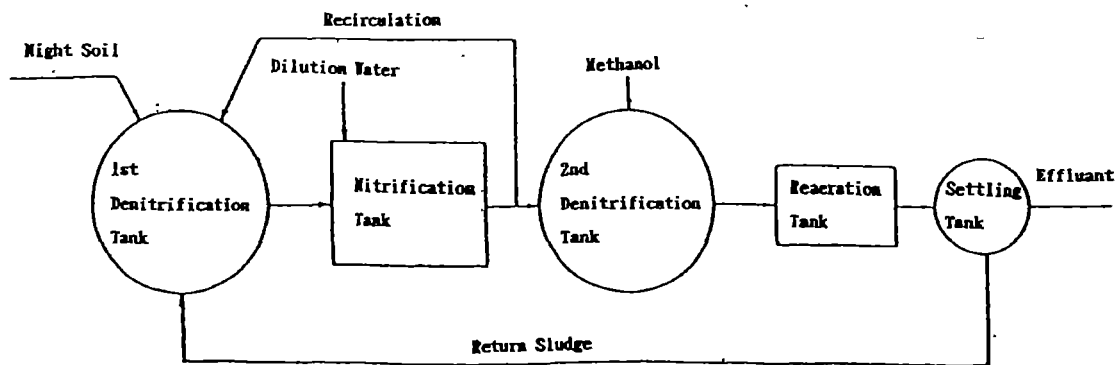

Figure 2. Biological denitrification process for nightsoil

Other approaches to sanitation

Public sewage works

Japan started nationwide sewage work construction in the 1970s, by 1996 50% of the population were covered. This construction trend will continue until early in the next century, when population coverage will reach about 90%. Until then, the collection and treatment of nightsoil is a key practice. Sewage works in Japan are not much different from any in western society, except for the high ratio of sludge incineration and the low agricultural use of treated sludge. The reasons for this are partially heavy metals in the sludge. Among the heavy metals in sludge, zinc is the most important in municipal wastewater treatment plants that do not accept industrial wastewater. Zinc concentration is highest after iron in sewage sludge, which affects plants in agricultural fields. Mercury, cadmium, lead etc. are all found in industrial wastewater, so that careful and effective management is necessary. Zinc contamination of sludge is very important, but not well understood. Human excreta contain most of the heavy metals, including zinc, but Japanese and Chinese experiences of the use of human excreta in agriculture have so far shown no significant influence on crop productivity. Sewage sludge also contains many organic micropollutants that need proper treatment before use in agriculture. However, human excreta have a very low risk compared to sewage.

Tandoku and gappei jokaso

Japan has other alternatives for sanitation than sewage and collective nightsoil treatment, which are tandoku jokaso and gappei jokaso. Tandoku jokaso means a simple treatment facility provided for WCs in each household. Treatment is basically dilution with water and sedimentation of suspended solids. Effluent leaves the household and enters the nearest stream. Regrettably, 20% of the population of Japan follow this practice. Grey water and the effluent from tandoku jokaso now contribute to non-point pollution in Japan. Gappei jokaso was introduced to treat both water-flushed human excreta and household grey water. Gappei jokaso is a compact biological wastewater treatment facility for each household. Treatment efficiencies with BOD₅ and suspended solids are almost equivalent to those of conventional treatment in municipal wastewater plants. However, this practice involves less than 1% of the Japanese population.

Figure 3 shows conceptual figures for a number of Japanese human excreta and grey water treatment systems (Sakurai and Kitawaki, 1994).

Both gappei jokaso and tandoku jokaso need periodic subtraction of excess sludge from the treatment facilities. The sludge is transferred to collective nightsoil treatment plants for further treatment: it is incinerated, or reused in agriculture, or put into municipal solid waste landfill. Agricultural use is not very popular.

Reuse of human excreta in agriculture

Urine

Human urine is different from faeces in terms of sanitation practices and agricultural use. It is clean with respect to bacterial and virus contamination just after discharge from the body, but it soon attracts vigorous bacterial growth. The old Japanese practice of nightsoil recovery from urban areas separated urine and faeces. Urine was a good, fast-working fertilizer. In the middle of the 19th century farmers would place buckets on the street corners to collect free urine from passers by, providing a simple public toilet. Urine should be collected for agricultural use: any feasible system should be created to achieve this.

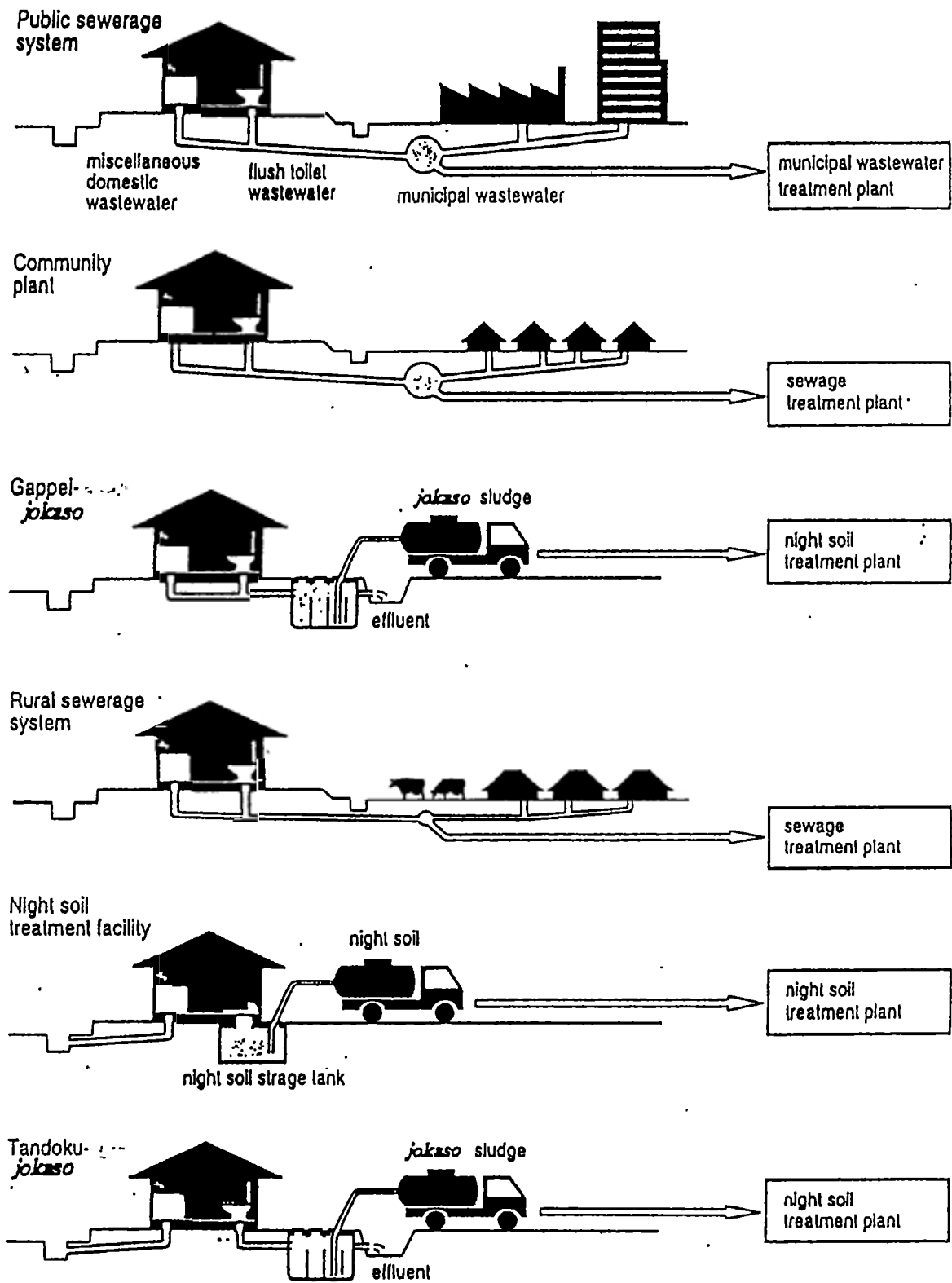

Figure 3. Conceptual sketches of several Japanese human excreta and gray water treatment systems

Faeces

Human faeces are not an easy matter to handle properly as they contain many microbes that are hazardous to health. The simplest treatment for collected faeces is composting. However, this needs good quality control to prevent disease. The basic technology of composting is anaerobic bacterial processes to decompose organic material by non-harmful bacteria, controlling pathogenic bacteria in the process. According to recent Japanese studies of pathogenic bacteria control in sewage sludge, *Enterococcus* sp. are not easy to control compared to faecal coliforms and *Salmonella* sp. (Watanabe et al., 1997). Figure 4 shows remaining faecal coliform groups (MPN/g) in sewage sludge at different levels of treatment. Composting or natural drying was very effective on faecal coliforms. Figure 5 shows remaining *Salmonella* sp. (MPN/g) in sludge. Mechanical dewatering is effective compared to other methods of composting or natural drying. Figure 6 shows remaining *Enterococcus* sp. (MPN/g) in sludge: surprisingly, no method is effective for controlling this pathogen and we must consider a new approach. There are many other pathogens in human faeces: it is obvious that new approaches must be introduced to control them.

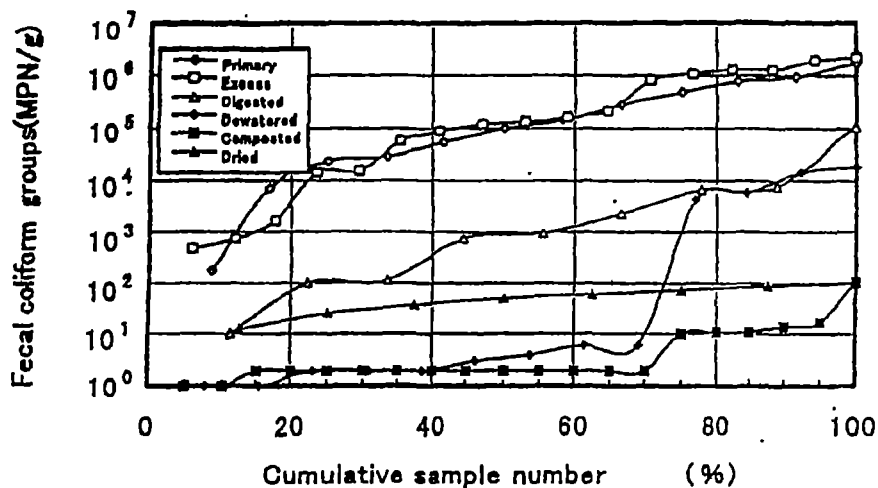

Figure 4. Faecal coliform groups in sewage sludge

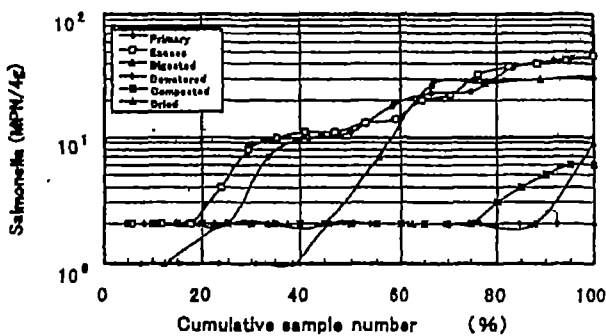

Figure 5. Salmonella in sewage sludge

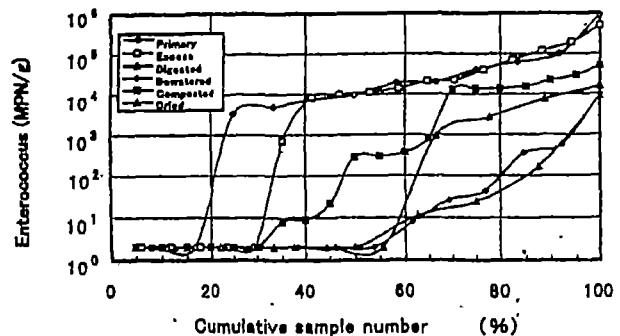

Figure 6. Enterococcus in sewage sludge

Conclusions

The Japanese practice of sanitation is different from western practices that require sewage pipe networks and treatment plants. The collection and treatment of nightsoil requires a very high level of technology to meet the effluent standards of the treatment plants. It is economical compared to public sewage treatment costs in Japan. However, people demand water toilets, which will lead to a gradual decrease in the system of truck collection and treatment of nightsoil in the next century.

When we consider the global environment issues there may be a new approach to sanitation, especially for human excreta. Human excreta have two important aspects, namely sanitation and the potential for agricultural nutrients. Global environmental awareness is an important driving force to change the status of human excreta from a simple hazard to a valuable resource.

References

Magara, Y. and K. Kawamura (1992). *The Role of Collective Night Soil Treatment for Environmental Sanitation*. 4th national Symposium of Environmental Technology and Management, Chiang Mai University & JICA

Sakurai K. and Kitawaki (1994). *Human Excreta and Gray Water Treatment in Japan, Part 1*. International Environmental Planning Center, Department of Urban Engineering, The University of Tokyo.

Watanabe, H., Kitamura, T., Ochi, S. and M. Ozaki (1997). *Inactivation of Pathogenic Bacteria under Mesophilic and Thermophilic Conditions*. Proc. IAWQ 8th International Conf. on Anaerobic Digestion, Vol.2, Sendai, Japan

Steward Henry (1994). *Toilet and Culture* (Toire to Bunka), Bungei Bunko, Bungei Shuppan Co., Printed in Japan, 1994.

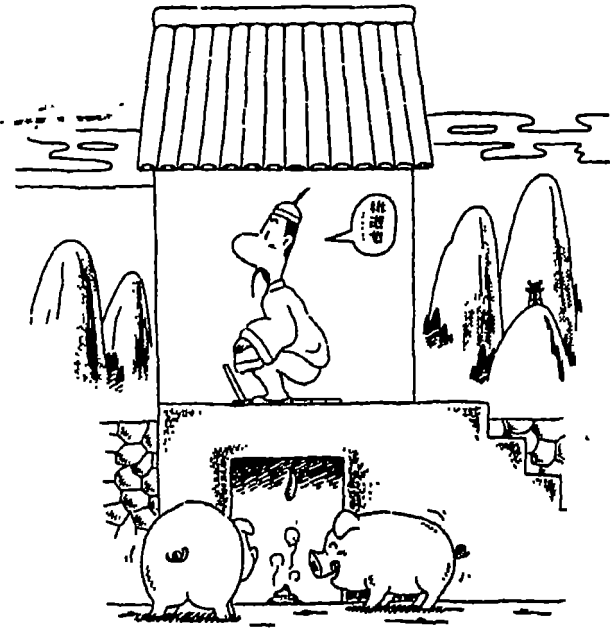

Figure 7. The Chinese developed a pig toilet to use human excreta. The pig toilet has a very long history. Even today there are pig toilets in the northern part of China.

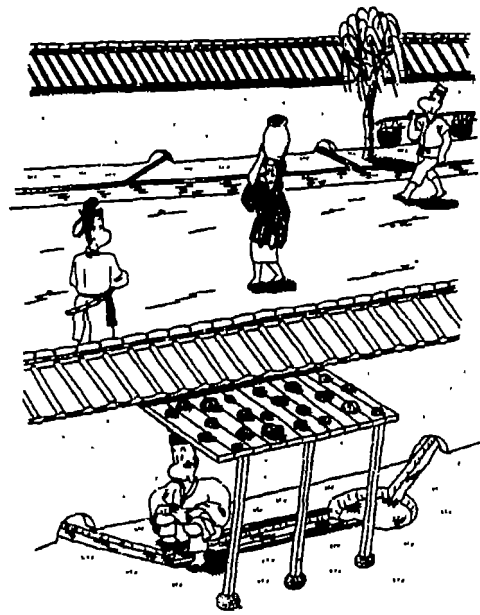

Figure 8. The old Japanese capital, Heijō, used water toilets, showing no evidence of reuse of human excreta. 8th century AD. (After S. Henry, "Toilet and Culture")



Figure 9. A variety of ladles and buckets were developed for the collection and transport of urine and faeces, 18th century AD.



Figure 10. People laughing at a samurai transporting urine on horseback with a specially designed bucket, in the centre of Edo City, 18th century AD.

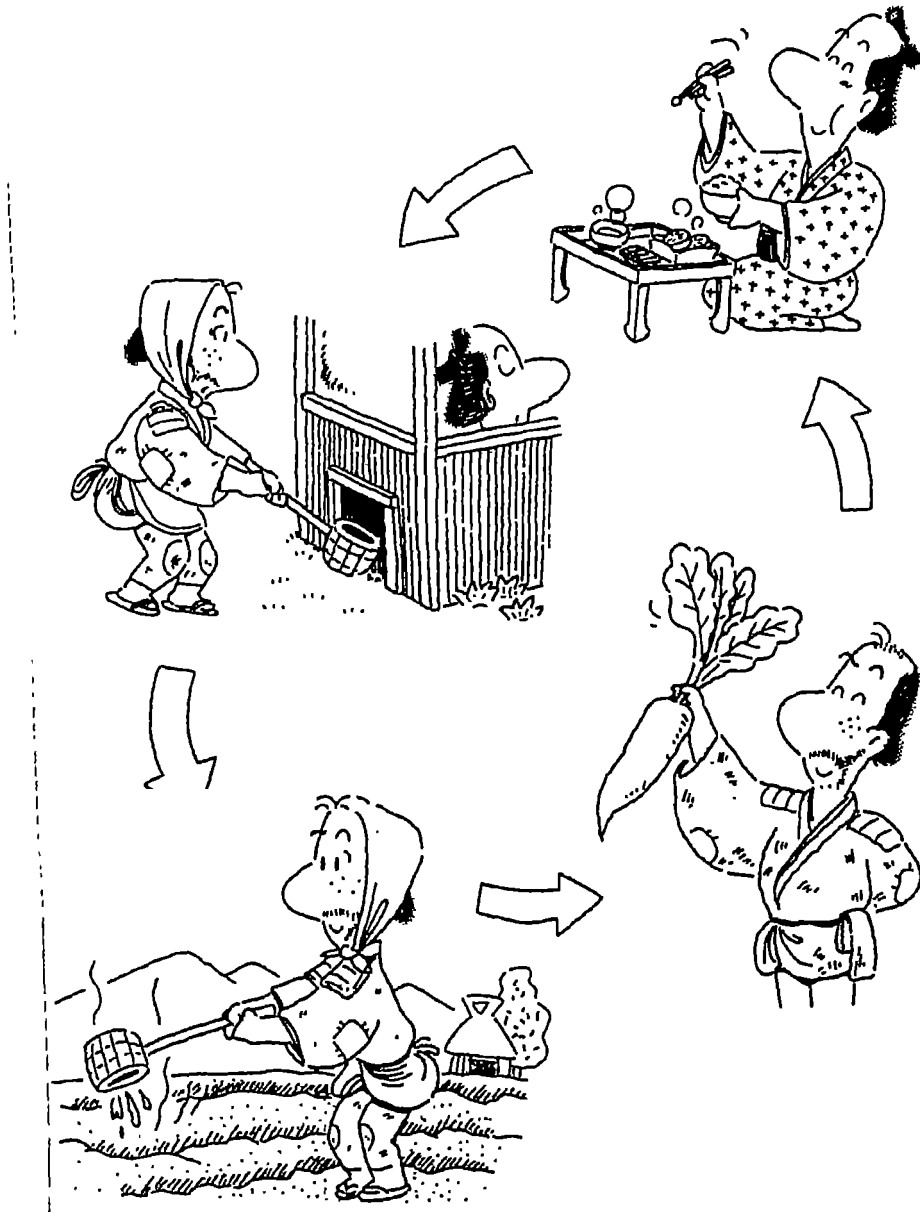

Figure 11. Japanese farmers practised nutrient recycling between food production and human excreta, 15th century AD.

SOME NOTES FROM THE SITES OF THE FIELD VISITS

Clivus Multrum

Clivus Multrum is a composting toilet without urine diversion (Fig.1). It has two chutes, one from the bathroom for faeces, urine, toilet paper and diapers and one from the kitchen for food scraps, peelings etc.

The unit we are visiting is in the house that used to belong to Mr Rikard Lindström, the inventor and developer of the Clivus Multrum system.

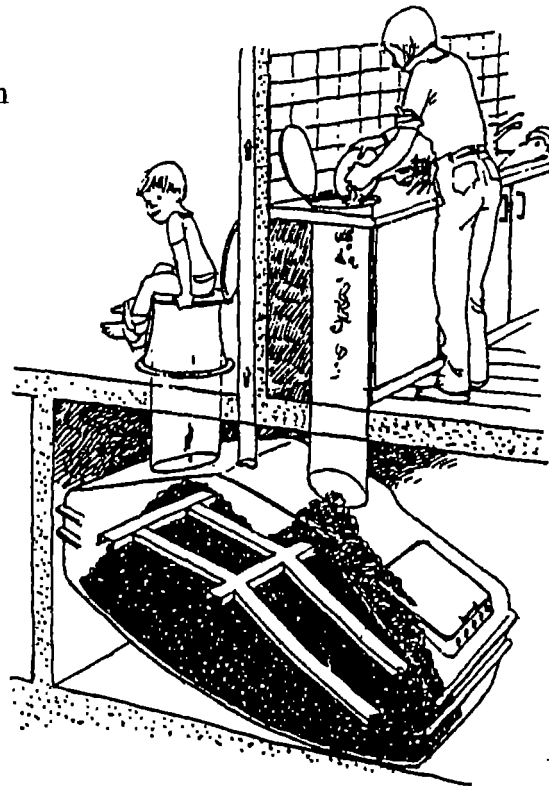

Figure 1: Clivus Multrum

Rikard Lindström described the system in an article in *Compost Science*, vol 6. no 1, 1965:

”The key to the process is that wastes are deposited into a naturally ventilated chamber. They then move by gravity from this chamber into a second chamber. The speed of movement is chosen so that the wastes are substantially decomposed as they reach the second chamber.

... It is possible to achieve with this arrangement an aerobic biological change in wastes of all kinds, such as excrement and refuse, with a first-class manure as an end product. This is all done without mechanisms and without the addition of chemicals or water. ... It serves as the toilet, as garbage container, as the apparatus for biological conversion, and as collection and storage place for the converted wastes (compost). ... The necessary ventilation for the desired treatment and for a complete freedom from odors is achieved through natural ventilation. ... Rich bacterial cultures developing in the mixture of excrement and refuse provide extremely rapid decomposition, considerably faster than with refuse alone.”

Porcelain pour-flush latrine with urine -diversion

Sanitation system with urine diversion, storage of urine in underground tanks, local treatment of faeces and greywater: 44 flats in Understenshöjden, Stockholm, a suburban residential area built 1995.

Three stations were studied: a) the treatment works and storage tanks for urine and the lower pond; b) the upper pond, the leca-trench, the trench to the lower pond and a compost for kitchen refuse; and c) a toilet in one of the flats.

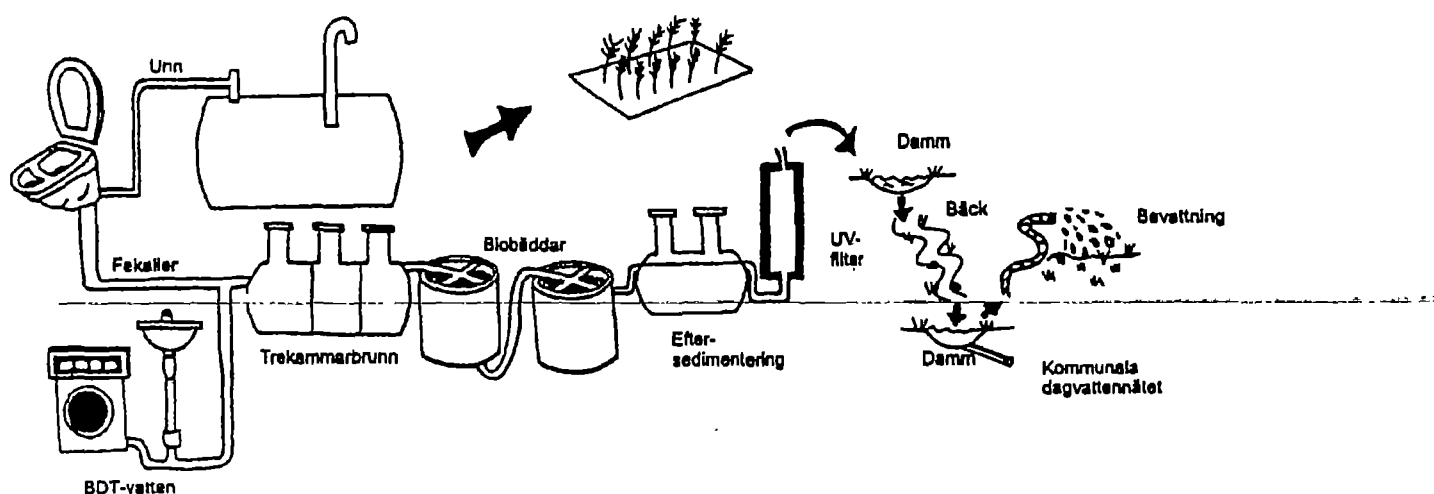

Figure 2: The sanitation system in Understenshöjden

Farm-use of urine as fertilizer

The farm using the urine from households in Understenshöjden is owned by Stockholm Water Company and run by farmers. They collect the urine from households twice a year and store it in three balloon-type tanks, each with a capacity of 150 m³. Most of the urine is used for ordinary farming, but some is used for field experiments. This year the effect of nitrogen from human urine on spring barley is similar to that of chemical fertilizers. Last year a similar results were found for oats.

Urine diversion in flats in the town of Norrköping

Last year 18 households in a multi-storey block of flats installed toilets with urine diversion and local treatment.

This block of flats was originally built in the 1960s. Last year it was converted into an "ecological building". The aim is to reduce energy consumption and to reuse sanitized human excreta. Potable water is taken from the municipal system. Low volume faucets and nozzels reduce the water and energy consumption. Urine is diverted and flushed with 0.2 litres

of water to a storage tank. Faeces are flushed with 4 litres of water to an "Aquatron" separator in the basement of the building. The "Aquatron" separates faeces and toilet paper from flushing water. Faeces and paper are composted together with household garbage for some eight months before the compost is used as a fertilizer in the residents' allotment gardens near the block. The flush water is sanitized with UV light and collected together with greywater in a septic tank. The effluent from the septic tank is filtered into a root zone design. Rainwater is handled locally.

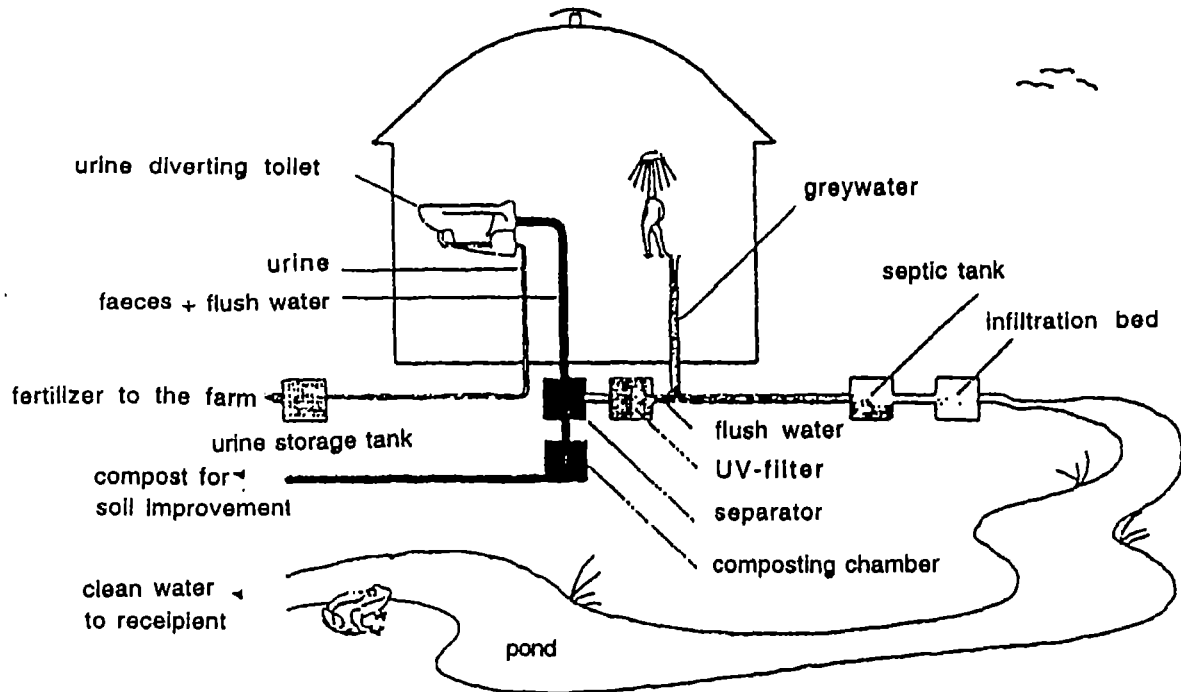

Figure 3: The sanitation system in Norrköping

Public urine-diversion toilet

Staff toilet with urine diversion and dehydration of faeces: Bergianska Botanical Garden, Stockholm. The toilet has a flush only for the urine (0.1 litre). Urine is stored in a tank until used in the garden.

Faeces and toilet paper fall straight down into a bin. There are five bins, each with a volume of 200 litres. The bins are standing on a carousel. When the first bin is full the carousel will automatically place the next bin under the toilet. Each bin has the capacity to receive the deposits from 500-600 visits.

For experimental purposes two of the bins will be provided with worms and and the other bins with some bulking agent.

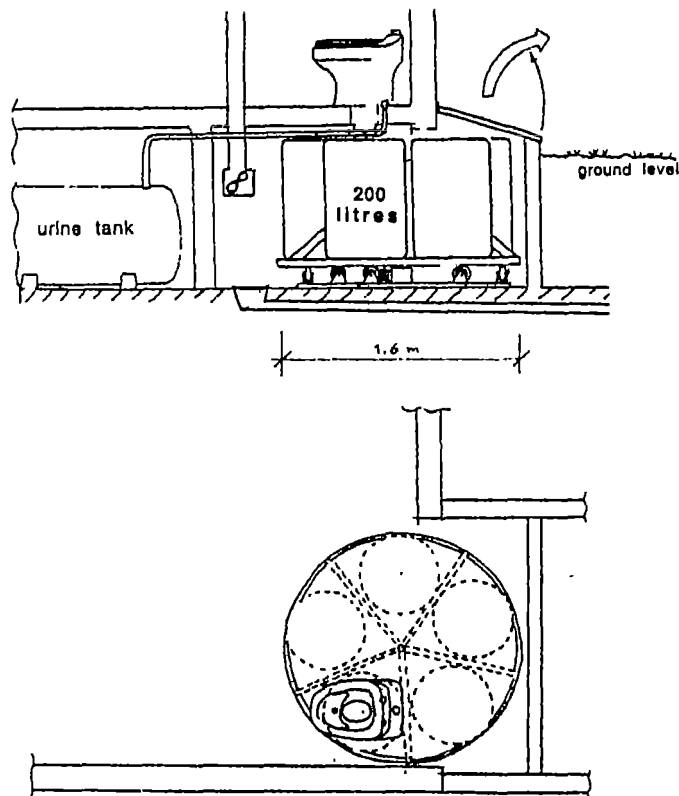

Figure 4: Section and plan of staff toilet at the Bergianska Botanical Garden

Chapter 4

Workshop resolution and summary of group work

4.1

Summary of the outcome of the group-work sessions

Six working groups were formed with delegates having work experience from the same continent in order to strengthen future regional cooperation and networking, as well as to facilitate a focused discussion. All six groups were given the task of identifying 5 favourable features and five obstacles to the introduction of dry systems. After presentations of their findings in plenum, the groups resumed work on ways to overcome the obstacles.

Positive aspects of the no-mix option

The group presentations of favourable features brought up similar aspects. The concept of urine diversion seems to work in both rural and urban areas. The environment, including receiving waters, is cleaner or less polluted. There is no leachate from the system and less or no odour in the house. Water is saved. The conversion of a waste problem into a potential resource as fertilizer is much appreciated. By fertilizing the land one may help to reclaim degraded areas. The perceptions of using excreta in agriculture are very favourable in countries like China, Vietnam and Japan. The no-mix units cost much less than sewerage systems and there is a range of costs for different no-mix alternatives. Another property of the no-mix unit is that the ownership and control lies with the owner of the toilet. This involvement of the people makes the no-mix system robust in social terms also.

Experienced or anticipated obstacles

Interesting differences were found in the presentations of obstacles to introducing dry systems. The Latin America group brought up problems of finance and participation, and also the need for more research on the health impact. The group noted that no-mix systems do not take care of grey water. The two Africa groups pointed to the problem caused by attitudes to excreta in some countries (waterborne being the ultimate solution), but also a supposed lack of discipline among users. One group had doubts whether the dry system would be cheap enough and whether necessary skills are available. The other group also brought up that no-mix units may be dangerous if not well operated. The two groups dealing with Asia stressed that taboos about the use of excreta apply only in some countries (Burma, Thailand, Laos, Indonesia and Cambodia). In Vietnam the opposite problem has arisen: farmers are so eager to collect the compost that they do it too early. The groups worried about the cost for poor areas, and that environmental advantages may not be relevant to the poor. They expected problems in educating people. One group also mentioned the problems with regulations involving many sectors which were anticipated when the no-mix systems are scaled up.

Suggestions to overcome obstacles

The groups came up with suggestions about how to overcome the stated obstacles. One overriding aspect seemed to be that many obstacles could be solved by simultaneous measures in various fields.

Making the option of no-mix toilets known: Promotion and marketing should take place at several levels. The idea should be implemented under Agenda 21, and be part of government promotion generally as well as on a project basis. Cooperation among various sectors, such as health, agriculture, water resources, education, mass media etc. will be necessary. A task group

may be instrumental in organising such cooperation. Numerous training activities geared towards specific groups (ranging from policy makers to children) were suggested by the working groups.

Taboos: Taboos may fade away as a consequence of training activities, credits made available, media and government promotion etc. Another suggestion is that quality control (collective control in collection and distribution of the products) will help overcome taboos by reducing the risk of disease transmission. Another suggestion was that scavengers (dogs etc.) take care of the products. Also pilot projects are important to show user costs and benefits as well as to provide a chance to judge the system's appropriateness and hygienic qualities in practice. Also, initiatives from the private sector should be stimulated to make the no-mix units a commodity like food and bicycles.

Affordability and financial constraints: A no-mix unit can be upgraded step by step and the initial cost can therefore be kept low and affordable. One economic rationale behind the no-mix system is that it provides a cheap fertilizer which can generate an income, and localised reuse will lower transport cost and demands on institutions. Still there is a need for further research into cost reduction and appropriate and applicable methods. These may include group arrangements in terms of work and finance. If more sophisticated solutions are selected, neighbours can push for credit arrangements. If there is a commitment there is always a way out, according to one group.

Further development and research: The number of units already operating gives ample possibilities to do research on various aspects of the operation of toilets and reuse of nutrients. Microbiological and behavioural studies are needed to assess health aspects, agricultural and institutional/economic studies are called for to assess the potentials of the system. The participants also agreed to network regionally and between regions to keep informed about experiences and results coming out.

Preparation of a Statement from the Sanitation Workshop to be presented at the Stockholm Water Symposium

The participants discussed at some length what is the common basis and understanding emerging from the workshop. The fact that urine contains the major part of the nutrients makes the no-mix system an interesting option. The studies so far about the success of sanitizing urine and faeces by storing them for half a year or more show positive results. Thus, there is no reason to wait for more studies before starting up new trials in different countries. In the meantime one should look into the standards for urine-diversion systems in the USA.

The possibility of turning a serious waste problem (eutrophication of lakes etc.) into a resource and input in agricultural production is appreciated and should be explored further.

The participants stressed that the no-mix option is as much dependent on user perceptions and institutional arrangements as on technology. Therefore, the mode of approaching communities and users may vary according to the local conditions. The wide range of no-mix alternatives also provides for a choice by the users according to their priorities and views. Also, cost and equity issues were brought forward as points to look into further.

The participants also pointed out the need for networking among those involved in projects and programmes. The areas which need more research are outlined in the statement itself.

4.2. Workshop Resolution as presented at the Stockholm Water Symposium August 11-15 1997

Introduction

In line with Agenda 21, which promotes a holistic view on water and the vital importance of sanitation, the 1997 Sida Sanitation Workshop was held on:

- ◇ the prevention of sanitation-related diseases;
- ◇ the separation of the components of human excreta (urine and faeces) and its use in agricultural production, based on the don't mix approach; and
- ◇ the conservation and protection of water sources.

The crisis in sanitation

The health of the world's population is increasingly threatened by inadequate sanitation, caused by:

- ◇ continued increase in population densities;
- ◇ lack of access to basic sanitation for the majority of the world's population; and
- ◇ overpromotion of unaffordable and unsustainable sanitation technologies (on site as well as waterborne), which often result in uncontrolled distribution of nutrients and pathogens into the environment.

Waterborne sewage systems in particular focus on reducing risks to public health and, lately, the environment, but should also produce resources which can be used in food production.

Sanitation technologies primarily need to focus on:

- ◇ the prevention of sanitation-related diseases;
- ◇ the need to remove and recycle nutrients to prevent contamination of water supplies, which has become increasingly costly; and
- ◇ the institutional and financial capability to adequately operate and maintain such systems for the entire population. This does not exist in many cases.

A proposed approach

Proven, effective ways to avoid the above problems are:

- ◇ containing urine and faeces at source, thereby reducing the risk of pathogens being spread from one area to another;
- ◇ avoiding mixing urine and faeces; and
- ◇ avoiding mixing excreta and water.

This can reduce treatment costs and provide useful agricultural resources.

Improved sanitation, and especially the don't mix approach, provides the following benefits:

Water

More than one billion people have insufficient water to meet their basic needs. Water supplies are becoming increasingly scarce and the don't mix approach can be used to conserve and protect water resources.

Food

Sustainable food production can benefit from the appropriate use of human urine and faeces, for the following reasons:

- ◇ urine contains a balanced mix of essential minerals, principally nitrogen, phosphorus and potassium, and can be used as a fertiliser; and
- ◇ faeces can be used as a soil conditioner after the destruction of pathogens.

Both have very low levels of heavy metals and are locally available for agricultural purposes.

Health and a healthy environment

Urine contains most of the nutrients and faeces most of the pathogens found in human excreta. By keeping them apart rather than mixing them in a common container or pipe, the handling of each can be simplified.

By avoiding or reducing the water to flush faeces the volume of dangerous material can be further reduced, water conserved and pollution prevented.

Use of urine as a fertiliser has the potential to contribute to the reduction of greenhouse effects.

Implementation

The don't mix approach has been successfully implemented in rural and periurban areas in several parts of the world.

The effective implementation of the don't mix approach, like all other sustainable systems, is enhanced by:

- ◇ the creation of effective political will and legal environments;
- ◇ promotion of decentralised decision-making, planning and implementation;
- ◇ a multidisciplinary partnership of communities, government institutions, research, teaching and training organisations and the private sector;
- ◇ demand-driven, community-based empowerment approaches;
- ◇ mobilisation of local entrepreneurial activities (private sector); and
- ◇ appropriate choices with regard to technical, cultural and socioeconomic considerations.

Research

In order to enhance our understanding of the don't mix approach, research is needed on:

- ◇ applications of the approach which are appropriate to various environmental and socioeconomic conditions;
- ◇ people's attitudes and beliefs with regard to the handling of human urine and faeces;
- ◇ viral transmission;
- ◇ faecal pollution of urine;
- ◇ agricultural production; and
- ◇ applications in areas of high population density.

The way forward

People can join hands to improve access to sanitation and optimise the use of water and nutrients, thereby improving the quality of life.

We recommend that the don't mix approach be further researched, adopted and adapted to other regions of the world and areas of high population density, which requires:

- ◇ the inclusion of a concept within a range of sanitation options;
- ◇ a network of practitioners;
- ◇ further research on agricultural use;
- ◇ pilot projects to test its application in areas of high population density; and
- ◇ participatory research to overcome restrictive attitudes and perceptions with regard to the handling of human urine and faeces.

We invite participants in the Stockholm Water Symposium to engage with other stakeholders in their countries to consider sanitation with regard to sustainability, and to investigate the feasibility of the don't mix approach.

Chapter 5

Abstracts of background papers submitted to the workshop



5.1. LATRINE CONSTRUCTION AND USE OF HUMAN EXCRETA IN CHINA

Pan Shunchang, Wang Junqi and Sun Fengying. Institute of Environmental Health and Engineering, Chinese Academy of Preventive Medicine, Beijing

For thousands of years the Chinese have regarded human excreta as an excellent fertiliser. However, because of the pathogen content of faeces and the potential for disease spread, the Ministry of Health has over the past 40 years implemented a policy of prevention by improving the standard of sanitation.

Four forms of latrine using no water have been developed. The three-compartment septic tank type gradually filters excreta from one tank to the next, finally storing it for at least 30 days, undergoing anaerobic digestion to produce an odour-free and harmless fertiliser. Parasitic ova and bacteria are all destroyed in the process.

The double-urn latrine (earthenware jars) separates urine from faeces. Urine is an excellent fertiliser and the separated faeces have a parasite sedimentation rate of 99.7%, leaving them harmless. A total of 5 million rural families in the Henan Province have constructed such latrines.

The biogas tank latrine integrates household, livestock and farm wastes, producing methane as an energy resource and a high-quality manure for fertiliser, although some ovicidal treatment is needed. Such latrines are excellent for use in rural areas.

The urine separating latrine works on the principle that urine from healthy people is not pathogenic and can be mixed with water for direct use in the vegetable gardens and fields, while faeces are treated separately.

A final option is thermophilic composting, where bacteria are killed by biogenic heat (50-70 °C). The compost is ready for use after 20 days in the summer and up to 60 days in the winter.

China has a problem of scarce water resources as well as a large rural population. Dry sanitation is therefore essential for both health and agricultural reasons.

5.2. EXPERIMENTAL RESEARCH INTO SMALL-SCALE HIGH-TEMPERATURE COMPOSTING FOR PEASANT FAMILIES

Wang Junqi, Xu Guihua, Sun Fengying, Xiao Jun, Xue Jinrong, Wang Youbin and Zhang Yanhong. Institute of Environmental Health and Engineering, Chinese Academy of Preventive Medicine, Beijing; * National Patriotic Health Campaign Committee*

Using organic fertiliser is important for the development of agriculture and the improvement of rural sanitation. If chemical fertiliser is used soil fertility gradually decreases and the ecological balance of farmland is destroyed. Meanwhile, poorly treated excreta pollute the environment and cause disease. We have carried out experimental research into the small-scale high-temperature composting common in rural China in order to discover whether the high temperature necessary can be maintained long enough to produce complete fermentation and harmless manure.

Factors to be considered are ventilation, raw materials, mixing and covering. Good ventilation is essential to create the aerobic conditions and high temperature needed to kill bacteria. The contents of the compost should ideally be 25% each human and livestock excreta, and 25% each vegetable and dry matter. Mixing and turning of the compost ensures an even temperature and thorough

decomposition. Finally, the whole must be covered to keep the surroundings clean and prevent animals digging in the pile.

Under these conditions a pile up to 0.8 m³ can create temperatures in the range 50-60°C and maintain these for up to one week, thereby achieving the required standard for bacteria-free manure.

5.3 SANITARY EVALUATION OF RURAL ALTERNATIVE-SERVICE DOUBLE-PIT DRY LATRINES

Wang Junqi, Xu Guihua, Nan Shan*, Sun Fengying, Xiao Jun, Xue Jinrong, Wang Youbin, Zhang Yanhong, Wang Junjie*, Bian Cimei#, Jiao Lailong+ and Liu Yanxia+*

Institute of Environmental health and Engineering, Chinese Academy of Medicine

**National Patriotic Health Campaign Committee*

#Public Health Bureau of Fuping County

+Sanitation and Antiepidemic Station of Fuping County

The alternative-source double-pit dry latrine is a seepage-resistant, ventilated rural household latrine. After three months in sealed storage the faecal *E. coli* level decreases by 2 orders of magnitude and the death rate of *Ascaris* eggs is near 95%. With improvements this form of sanitation is suitable for arid and semi-arid rural areas. The single-pit dry latrine is also seepage resistant and can produce harmless excreta using high-temperature composting. In northeastern China these types of latrine are becoming increasingly popular and our study was aimed at confirming their suitability for the area.

The construction of both types of latrine meets basic sanitation requirements, being built of brick with a tiled roof and ventilation duct, and concrete-lined pits to prevent seepage. During daily use the excreta are covered with soil to prevent odour and begin the composting process. When one pit is full it is sealed and the second one is used. After 2-3 months the first is emptied and the excreta used as manure.

In single-pit latrines extra high-temperature composting is required to achieve bacteria-free manure.

Faecal *E. coli* levels do not vary with the season, but the longer the storage period the greater the kill rate. We suggest the use of larger pits and longer storage times (6 months) to improve standards and reduce pollution.

5.4. GENERAL SITUATION ON ENVIRONMENTAL HEALTH DEVELOPMENT IN CHINA

Jicheng Dong, Ministry of Health (NPHCCO), No. 44Hou Hai Beiyan, 100725 Beijing, China

In December 1952 the Chinese government set up the Central Patriotic Health Campaign Committee (CPHCC), whose brief was 'to eliminate pests [rats, bedbugs, flies and mosquitoes], pay attention to hygiene and improve sanitation'. This has since become one of the foundations of Chinese health care.

Now known as the NHPCC, this committee has branches all over the country, chaired by local officials responsible for health care. Its brief now also includes health education and municipal planning for infrastructure and the environment. The achievements of the NPHCC have attracted worldwide attention for their part in transforming society and traditions.

With the establishment of New China the country's main task was to restore normality and develop the economy. There was no finance to create an infrastructure, and from the 1950s to the 1970s the PHC's aim was for temporary solutions only.

In the 1980s China adopted a more open policy and greater reforms. The economy began to grow, together with living standards and expectations, leading to systematic development and improvement of sanitation in urban areas. Environmental protection has also become an issue: by the end of 1995 49.6% of urban waste and 20% of wastewater was being rendered harmless. The sanitation quality of 25 major cities is on a level with well developed cities worldwide.

In rural areas advances have a longer-term perspective. Policies and plans have been drawn up in three main areas: drinking water, sanitation and health education, affecting 0.9 billion rural dwellers. The use of composted nightsoil as a fertiliser is encouraged, together with the use of dry latrines of varying types. By the end of 1996 more than 49% of the rural population had such sanitation; the rest use public or community facilities.

China is a very large country which is still largely isolated and backward, despite huge economic improvements. In rural areas in particular developments have been slow, and affected by traditional ways of thinking. Changing this is an arduous task. The Chinese government has undertaken to achieve the goals of 'Health for all' and the '90s National Program for Child Development' by 2000. The NPHCC will continue to be responsible for coordination, mobilisation, propaganda and education; for regulation and control, training and research, and for the exchange of information.

5.5 SANITATION IN BOLIVIA

Enrique Torrico, Saneamiento Basico Rural, DINASBA, Av. 20 de Octubre 2230, La Paz, Bolivia

The Republic of Bolivia is situated in central South America and can be divided into three zones: the highlands, where the climate is cold and dry; the valleys, with a mild, wet climate; and the plains, where it is hot and humid, with high rainfall.

According to the 1992 census Bolivia has 6,420,792 inhabitants, with a density of 5.8 per km². For the first time in its history the urban population is greater than the rural (58% to 42%), and this trend is set to continue. Infant mortality in 1992 was 75/1000 live births before 1 year of age, and 156/1000 before 5 years. Acute diarrhoea, closely related to water usage and sanitation, has long been the main cause of death.

Like other countries in Latin America, Bolivia shows notable differences in its water and sanitation sources, especially between rural and urban areas. In 1992 only 44.5% had such services, mostly in urban areas. In rural areas latrines are commonplace. According to the few diagnoses that exist, sanitation services have problems of implementation, construction, operation and maintenance. A study in 1996 concluded that the majority of latrines are not properly operated or maintained, and that people are reluctant to use them. Intensive action to promote and implement their use is recommended.

The main problems are poor community participation, lack of affordable options, and weakness in implementation and administration. Only 2% of the population in the areas studied were educated about sanitation and hygiene. Projects to study the sociocultural aspects of sanitation and to motivate users are needed to attract finance for implementation.

5.6. SUMMARY REPORT ON WASTEWATER MANAGEMENT IN BOTSWANA

O.M. Serumola, Department of Water Affairs, PI Bag 0029, 267 Gaborone, Botswana

The management of waste water in Botswana is dispersed between a number of different bodies, reducing the possibility of a unified management strategy. Owing to rapid economic development and population growth the demand for water and the amount of subsequent waste has increased substantially, creating problems for those responsible for its management.

Although some wastewater treatment facilities exist they are poorly managed and maintained. Also, for much of the population latrines, septic tanks and soakaways are the only affordable options, despite their limitations, especially in densely populated areas. Leaching of pollutants, which are usually rich in nitrogen, is a serious problem, but the general public approach to waste disposal is careless. The result of course is a reduction in the environment's capacity to assimilate pollution and a consequent threat to public health.

Wastewater treatment systems in use in Botswana can be defined as follows:

- ◇ large stabilisation ponds to treat wastewater from the community in general, run by local authorities. some large institutions have their own ponds;
- ◇ septic tanks, both in institutions and in individual homes;
- ◇ manufacturing companies may have pretreatment tanks to treat effluent before discharging it to the sewers;
- ◇ biological filter systems, sand filters and activated sludge systems.

The problems with these systems generally stem from overloading, causing the system to break down and pollution to increase. Also, there is no practice of separating the waste streams, so that systems become blocked and ineffective. Untreated or poor-quality effluent is also discharged into the sewer network, affecting the biological capacity of the treatment ponds.

Poor maintenance is another major problem - removal of sludge and vegetation is necessary for cleanliness and proper operation. Sludge removal is made more difficult because of the lack of vacuum tankers and the large volumes of sludge. there is also a lack of sludge drying beds, so that even when sludge is removed it is often dumped in unsuitable areas.

In most cases management is on a crisis-only basis, and no routine maintenance is carried out. Solutions are therefore only short term.

The Botswana Department of Water Affairs, in collaboration with the Danish Cooperation for Environment and Development, is to begin a water quality management project with the aim of improving the country's use and treatment of water by promoting public awareness. Strong pollution control measures are needed, with legislation and guidelines for users. Making the polluter pay is important.

A sanitation and waste management department should be established to coordinate local efforts and promote new programmes. Central sewerage schemes should be established for large villages, and local authorities should set up monitoring programmes to control the quality of effluent.

Expanding the capacity of septic tanks or ponds is also essential to prevent biological breakdown of the system. Also the siting and operation of latrines must be supervised, to prevent contamination of aquifers, and the siting of graveyards near rivers discouraged.

5.7. ENVIRONMENTAL SANITATION IN EL SALVADOR

Rafael Mejia, Vice Ministry of Housing and Urban Development, Av. La Capilla 228, Col. San Benito, San Salvador, El Salvador

El Salvador is currently undergoing an economic revival, with consequent increases in demand for resources and in pollution. The aim of any approach to sanitation must be to maintain a balance between resource use and costs, taking into account social inequalities. In urban areas wastewater is not treated and is discharged directly into rivers. A small proportion is discharged into septic tanks. Treatment plants are under construction but not yet functioning.

A certain amount of solid garbage remains uncollected every year and is generally dumped. Of that collected, the method of disposal is landfill of open dumps, although an informal market exists for recycling of products such as paper, glass, iron etc.

The Ministry of Housing and Urban Development has undertaken an ambitious planning project in El Salvador's largest urban areas, the main thrusts of which are sustainable resource management and environmental/sanitation issues. The Environmental Plan defines critical areas for aquifer protection and environmental hazards such as landslides and flooding. The Solid Refuse Programme seeks to provide local authorities with the tools to collect and dispose of garbage.

5.8. ENVIRONMENTAL SANITATION IN NAMIBIA

Ben van der Merwe, Department of the City Engineer (Water Services), PO Box 59, Windhoek, Namibia

Sanitation in Namibia is controlled by the Ministry of Health and Social Services, the Ministry of Regional and Local Government and Housing, and local authorities.

The use of more environmentally friendly sanitation systems is restricted to ventilated improved pit latrines and aqua privies. Both systems are regarded by the local population as inferior and are normally rejected within the urban environment.

During 1992 a major investigation was carried out into the use of alternative sanitation systems for higher-density areas in Windhoek. Various meetings were held with the communities involved. Some of the leaders of the different communities were taken to different sites in South Africa where alternative systems are used. The result was positive and it was decided to install 300 of a more advanced type of aqua privy. All installations were provided with soakaways and users were advised to plant trees to make use of evapotranspiration. The system was installed only in areas where there was no possibility of groundwater pollution. In cases where consumers were able to carry the cost of water connection low flush toilets were installed. The system was in the end rejected by the community, and the aqua privies were sold for use on farms and in some rural areas.

The only system which is acceptable at the moment is based on the principle of incremental construction. Every new township is planned in such a way that water connections and toilets (waterborne sewage) are shared by more than one family. When consumers are able to afford a higher level of service, services can be extended. Affordability remains a critical problem.

In most urban settlements in other towns and villages all alternative sanitation systems which are available are regarded as inferior.

- ◆ The following points need further discussion: alternative systems are not yet developed to such an extent that they can replace waterborne sewage systems.
- ◆ Treatment of wastewater with appropriate technology may provide a cheaper system in the long term.

5.9. VIETNAM ENVIRONMENTAL SANITATION: STATUS AND SOLUTIONS

Professor Pham Song, National Steering Committee for Safe Water Supply and Sanitation

Vietnam is severely affected by environmental degradation caused by poor sanitation practices. Most rivers and water sources are heavily polluted by human excreta and industrial waste, owing to the practice of open defecation and the use of rivers to dispose of garbage and toilet products. Bird populations are depleted by hunting and forests have been destroyed by toxins during the war and by fires caused by carelessness. As a result biodiversity is being lost. Flooding in the Mekong Delta is increasing and the destruction of upstream forests exacerbates the problem. Bucket latrines are common and the contents are used untreated on the fields.

The control of waste is poor, with only 50% of an estimated total 19,315 tonnes per day being collected for disposal. Toxic and domestic wastes are not separated, being all dumped together, leading to serious pollution problems. Legislation to control waste is insufficient and not properly applied.

Untreated wastes are the cause of much disease, affecting health and socioeconomic development. Food hygiene is poor, only 40-50% of samples tested meeting hygiene requirements. In a region where technology is backward occupational safety is also a concern. workers are badly affected by noise, dust and chemicals, and only 15% of enterprises surveyed are attempting to improve the situation.

The protection of water from contamination is becoming a pressing issue. A pilot project in Hanoi is concentrating on the provision of domestic rainwater tanks and the use of biogas tanks and composters for waste disposal.

A project in Phuc Yen is testing the use of bioponds to provide water for irrigation, and domestic sanitation arrangements that create cleaner effluent. Various types of latrine suitable for different areas are being tried in an attempt to prevent pollution while producing safe agricultural fertilisers. It is important to educate users to follow the guidelines carefully and not to use the compost before it has become safe. The construction of public latrines is also a concern.

The use of hydrolysis to speed up composting and the control of chemical fertilisers are other important health issues.

Various public awareness projects are being set up to educate people about hygiene and health, covering waste disposal, food safety, environmental cleanliness, air pollution and industrial safety. Other objectives include strengthening the sanitation companies, monitoring standards of pollution control and protecting the environment.

5.10 URBAN SANITATION, MAHARASHTRA, INDIA

Nandita Kapadia-Kundu, Institute of Health Management, Pachod, India

Maharashtra is the most urbanised state in India. Currently about 40% of its 78 million people live in urban areas, and by the turn of the century this is expected to increase to 50%.

Pune city has a population of 2.5 million (Census of Maharashtra, 1991). Of these, an estimated 40% reside in slums, only half of which are recognised and have a few basic facilities. The unrecognised slums do not have even basic facilities.

Unlike rural India, where the demand for sanitation facilities is low, urban slums rank sanitation as their greatest need. A study (IHMP, 1996) shows that slum women ranked sanitation as their number one problem, higher than water and electricity.

There is a difference between the magnitude of the problem of sanitation in recognised and unrecognised slums. Although facilities do exist in recognised slums, they are highly inadequate and poorly maintained. Unrecognised slums epitomise the exigencies of the urban struggle for survival. Obtaining basic facilities such as water, toilets and electricity is seen as their greatest problem. There is constant friction within the slum community because of the fight for scarce resources.

Problems stated by women from the recognised slums centre on improving and upgrading the available facilities, which are inadequate due to rapid population growth. The overall magnitude of the problems cited by women in the recognised slums was less than in the unrecognised slums.

5.11 ENVIRONMENTAL SANITATION IN THE REPUBLIC OF SOUTH AFRICA

Aussie Austin, Division of Building Technology, CSIR, PO Box 395, Pretoria 0001, South Africa

The current situation in the field of environmental sanitation in South Africa is best understood by referring to the Draft White Paper on a National Sanitation Policy, released by the government in June 1996. This recognised that sanitation needs to be seen in the context of an integrated development strategy. It was thus clear that the task of developing a national sanitation policy could not be assigned to a single government department, and that a cooperative approach was needed. The commitment of the government to making all citizens aware of the importance of sanitation is evidenced by the six departments involved in the preparation of this document, namely:

- Department of Water Affairs and Forestry
- Department of Environment Affairs and Tourism
- Department of Education
- Department of Health
- Department of Housing
- Department of Provincial Affairs and Local Government.

The White Paper recognises that the proper operation of sanitation systems is essential in order to protect the environment. It makes the point that a complicated and expensive system which is poorly maintained can be just as harmful to the environment as having no system at all. It is further stated that inadequate sanitation leads to dispersed pollution of water sources, which in turn increases the cost of downstream water treatment, as well as the risk of disease transmission.

The Department of Water Affairs and Forestry has developed a comprehensive water quality management policy. In evaluating the most appropriate type of sanitation system for a particular situation, the relevant quality objectives for local water resources must be taken into account. The department has further published a number of documents to assist in evaluating the potential impact of sanitation systems on the environment.

The need for public awareness and participation is emphasised, and for information to be presented in an even-handed manner to convey the potential costs and trade-offs. The correct EIA procedures must be followed, while appropriate risk assessment procedures still need to be developed.

Waste recycling is also addressed. Where economically viable and sustainable, the government expects both the liquid and solid constituents of sewage to be recycled for further use. The return of treated effluent to the water cycle is also considered essential.

Environmental education, both formal and informal, is viewed as being of great importance, to create an environmental ethic. Communities are also encouraged to become involved in monitoring the quality of their own water resources.

Finally, it is intended that the provision of adequate sanitation as a prerequisite for sound environmental management will be recognised by legislation. To this end existing legislation, as well as government structure and functions, is currently being reviewed.

Appendices



Sida Sanitation Workshop, Balingsholm 6-9 August 1997

PROGRAMME

Day 0 (Wednesday 6/8)

1800 Registration, dinner, presentation/introduction of participants

Day 1 (Thursday 7/8) (Chair: Ingvar Andersson, rapporteur Jan-Olof Drangert)

0830-0840	Introduction	Ingvar Andersson
0840-0900	Opening speech	Bo Göransson
0900-0945	Closed vs linear flows	Erik Arrhenius
0945-1030	A new paradigm	Mayling Simpson
1030-1045	<i>coffee</i>	
1045-1120	Ecological sanitation: a global overview	Uno Winblad
1130-1205	Ecological sanitation in Sweden	PA Malmqvist
1205-1220	Discussion	
1220-1300	<i>lunch</i>	
1310-1900	Field visit 1	
1915	<i>dinner</i>	
2000-	Informal discussions of field visits etc	

Day 2 (Friday 8/8) (Chair: Mayling Simpson Hébert, rapporteur: Elisabeth Kvarnström.)

0830-0915	System assessment and reuse	Håkan Jönsson
0915-1000	Disease control	Thor Axel Stenström
1000-1020	Discussion	
1020-1035	<i>coffee</i>	
1035-1120	Behavioural aspects	Jan-Olof Drangert
1120-1205	Institutional and financial aspects	Jorge Vargas
1205-1230	Discussion	
1230-1330	<i>lunch</i>	
1330-1400	Case study: Mexico	George Ann Clark
1300-1430	Case study: El Salvador	Jean Gough
1430-1500	Case study: Pacific Islands	Dave Rapaport
1500-1530	Case study: Japan	Saburo Matsui
1530-1545	<i>coffee</i>	
1545-1630	Discussion	
1630 -1800	Group work	
1800	<i>dinner</i>	
1900-2200	Group work continues (by 2030 intermediate reports from working groups to those responsible for preparing draft final statement)	

Day 3 (Saturday 9/8) (Chair: Dave Rapaport, rapporteur: Jorge Vargas)

0800-1300	Field visit 2	
1310-1400	<i>lunch</i>	
1400-1515	Concluding session	
1530	Departure for Field visit 3 and Hotel City/Kungsgatan, Stockholm	
1720	Arrival Hotel City	



Mr. Aws Alouini	INAT Dept. of Rural Engineering , Water and Forestry 43, Avenue Charles Nicolle 1082 Tunis Mahrajene Tunisia	Phone: +216-1 892 785 etc. Fax: +216-1 886 274/799 391 E-mail:
Mr. Ingvar Andersson	Sida NATUR/Afrika 105 25 Stockholm Sweden	Phone: +46-8 698 53 86 Fax: +46-8 698 56 53 E-mail: ingvar.andersson@sida.se
Mr. Erik Arrhenius	Kalmar Högskola/Forskarskola Agenda 21 Naturvetenskapliga institutionen 391 29 Kalmar Sweden	Phone: +46-480 44 62 51 Fax: +46-480 44 62 62 E-mail: Erik.Arrhenius@ng.hik.se Phone/fax (home): +46-485 331 98
Mr. Aussie Austin	CSIR Division of Building Technology P.O. Box 395 0001 Pretoria South Africa	Phone: +27-12 841 2568 Fax: +27-12 841 3400 E-mail: laustin@csir.co.za
Ms. G.K. Bambrah	P.O. Box 38638 Nairobi Kenya	Phone: +254-2 50 63 63 Fax: +254-2 60 59 09/55 69 43 E-mail: awn@elci.gn.apc.org
Mr. Kent Blom	Sida Sveavägen 20 105 25 Stockholm Sweden	Phone: +46-8 698 59 29 Fax: +46-8 698 56 53 E-mail:
Ms. Lisbet Bostrand	Sida, Natur/ALA 105 25 Stockholm Sweden	Phone: +46-8 698 53 28 Fax: +46-8 698 56 53 E-mail: lisbet.bostrand@sida.se
Mr. Björn Brandberg	P.O. Box 66 Mbabane Swaziland	Phone: +268-400 67/432 43 Fax: +268-401 18/421 26 E-mail: 100077.2013@compuserve.com
Mr. Ato Brown	UNDP - World Bank Water and Sanitation Program, World Bank (RWSG-ESA) P.O. Box 30577 Nairobi, Kenya	Phone: +254-2 720 391 Fax: +254-2 720 408 E-mail: fbrown@worldbank.org
Mr. Zigfrids Bruvers	Peldu iela 25 LV 1494 Riga Latvia	Phone: +371-7026 401 Fax: +371-7820 442 E-mail:
Mr. Bui Trong Chien	Pasteur Institute 8 Tran Phu Street Nha Trang Vietnam	Phone: +84-58 22408 Fax: +84-58 27173 E-mail:
Ms. George Anna Clark	Espacio de Salud AP 1-1576 62001 Cuernavaca Morelos Mexico	Phone: +52-73 18 07 20 Fax: +52-73 18 07 20 E-mail: esac@laneta.apc.org
Mr. Jicheng Dong	NPHCCO, Ministry of Health No 44 Hou Hai Beiyuan 100725 Beijing China	Phone: +86-10 64 01 56 20 Fax: +86-10 64 01 56 20 E-mail:

Mr. Brendan Doyle	Unicef ESARO Nairobi G.C.P.O.Box 5747 New York New York NY 10163-5747 USA	Phone: +254-2 622 194 Fax: +254-2 62 26 78 E-mail: brendan.doyle@unicef.unon.org
Mr. Jan-Olof Drangert	Linköping University Dept of Water 581 83 Linköping Sweden	Phone: +46-13 39 61 54 Fax: +46-13 13 36 30 E-mail: jandr@tema.liu.se
Mr. Gunder Edström	SUDEA P.O. Box 50755 Addis Abeba Ethiopia	Phone: +251-1 61 13 44 Fax: +251-1 51 58 30 E-mail: sudea@telecom.net.et
Ms. Jean Gough	Ave. Napoleon Viera Altamirano y Pje Itsmania no 204 P.O. Box 1114, Col Escalon San Salvador El Salvador	Phone: +503-263 3380 Fax: +503-263 3385 E-mail: jgough@unicef.org
Mr. Simon Hartley	Dept. of Water Affairs Private Bag X313 0001 Pretoria South Africa	Phone: +27-12 338 82 74 Fax: +27-12 338 82 75 E-mail: simon@dwaf.pwv.gov.za
Ms. Helvi Heinonen-Tanski	Univ of Kuopio Dept of Environm. Sciences, Box 1627 Kuopio Finland	Phone: +358-17 16 31 52 Fax: +358-17 16 32 30 E-mail: heinotan@uku.fi
Mr. Richard Holden	The Mvula Trust P.O. Box 32351 Braamfontein 2017 Johannesburg South Africa	Phone: +27-11 403 3425 Fax: +27-11 403 1260 E-mail: richard@mvula.co.za
Ms. Caroline Höglund	Swedish Inst. For Infectious Disease Control 105 21 Stockholm Sweden	Phone: +46-8 735 14 38 Fax: +46 8 730 32 48 E-mail: caroline.hoglund@smi.ki.se
Ms. Vathinee Jitjaturunt	c/o Unicef no 12 Sanlitun Lu 100600 Beijing China	Phone: +86-10 65 32 31 31 Fax: +86-10 65 32 31 07 E-mail: vjitjaturunt@unicef.org
Mr. Bengt Johansson	Sida NATUR/Afrika 105 25 Stockholm Sweden	Phone: +46-8 698 5341 Fax: +46-8 698 5653 E-mail: bengt.johansson@sida.se
Mr. Håkan Jönsson	Swedish Agricultural University Dept of Agricultural Engineering 750 07 Uppsala Sweden	Phone: +46-18 67 18 86 Fax: +46-18 67 18 88 E-mail: hakan.jonsson@lt.slu.se

Ms. Nandita Kapadia-Kundu	Institute of Health Management, PACHOD Bombay Sappers Society, Plot no 13 Wadgaon sheri 411 014 Pune India	Phone: +91-212 685 462 Fax: +91-212 685 462 E-mail: ihmp@giaspn01.vsnl.net.in
Mr. Tomas Kjellqvist	Sida Dept for Research Cooperation SAREC 105 25 Stockholm Sweden	Phone: +46-8 698 53 53 Fax: +46-8 698 56 56 E-mail:
Ms. Elisabeth Kvarnström	Luleå Univ. of Techn. Div. of Sanitary Engin. 971 87 Luleå Sweden	Phone: +46-920 721 31 Fax: +46-920 914 93 E-mail: elisabeth.kvarnstrom@sb.luth.se
Mr. Per-Arne Malmqvist	VBB Viak P.O. Box 2203 403 14 Gothenburg Sweden	Phone: +46-31 62 76 07 Fax: +46-31 62 77 22 E-mail: pmt@vbb.se
Mr. Saburo Matsui	Kyoto Univ., Research Centre for Environm. Quality Control 1-2 Yumi hama, Otsu City Japan 520	Phone: +81-775 27 62 20 Fax: +81-775 24 98 69 E-mail: matsui@eq1.eqc.kyoto-u.ac.jp
Mr. Rafael Mejia	Avenida La Capilla #228 Col. San Benito San Salvador El Salvador	Phone: +503-263 8461 Fax: +503-263 8487 E-mail: opes@gbm.net
Ms Karin Metell	UNICEF 3 UN Plaza WES Sechon (TA26A) New York, NY 10017 USA	Phone: +1-212-824 6654 Fax: +1-212-824 6480 E-mail: kmetell@unicef.org
Mr. Peter Morgan	31, Woodhall Road, Marlborough Harare Zimbabwe	Phone: +263-4 301 115 Fax: E-mail: morgan@harare.iafrica.com
Mr. Samuel Dawuna Mutono	c/o Directorate of Water Development P.O. Box 20026 Kampala Uganda	Phone: +256-45 345 37 Fax: +256-45 34592/41 220 775 E-mail: ruwproj@imul.com
Mr. Shunchang Pan	Inst. of Environmental Health & Engineering 29, Nanwei Road 100050 Beijing China	Phone: +86-10 63 03 87 61 Fax: +86-10 63 01 18 75 E-mail: pansc@ccs.capm.ac.cn
Mr. David Proudfoot	Mvuramanzi Trust 1 James Lamb Drive Marlborough Harare Zimbabwe	Phone: +263-4 301 494 Fax: +263-4 301 494 E-mail: MVURAMAN@harare.iafrica.com
Mr. Dave Rapaport	RD 2 P.O Box 1420 Waterbury Vermont 05676 USA	Phone: +1-802 223 5221 Fax: +1-802 223 6855 E-mail: vpirg@together.net

Mr. Jan Runnquist	Sida/Natur 105 25 Stockholm Sweden	Phone: +46-8 698 53 33 Fax: +46-8 698 56 53 E-mail: jan.runnquist@sida.se
Ms. Oarabile Moanza Serumola	Dept of Water Affairs PI BAG 0029 Gaborone Botswana	Phone: +267-360 71 73 Fax: +267-303 508 E-mail:
Ms. Mayling Simpson-Hébert	World Health Organisation 20, Avenue Appia CH-1211 Geneva 27 Switzerland	Phone: +41-22 791 3531 Fax: +41-22 791 4159/07 46 E-mail: simpsonhebertm@who.ch
Mr. Pham Song	37 Lê Dai Hanh Hanoi R.S. Vietnam	Phone: +84-48 216 924 Fax: +84-48 216 339 E-mail:
Mr. Thor Axel Stenström	Swedish Inst. for Infectious Disease Control 105 21 Stockholm Sweden	Phone: +46-8 735 14 39 Mobile phone: +46-70 647 60 47 Fax: +46-8 730 32 48 E-mail: Thor-Axel.Stenstrom@smi.ki.se
Ms. Margaretha Sundgren	Sida 105 25 Stockholm Sweden	Phone: +46-8 698 53 31 Fax: +46-8 698 56 53 E-mail: margaretha.sundgren@sida.se
Ms. Maria Söderberg	Sofiehillsvägen 12 152 57 Södertälje Sweden	Phone: (office) +46-8 550 216 26 Phone: (home) +46-8 550 198 49
Mr. Enrique Torrico	Dirreccion Nacional de Saneamiento Basico Av 20 de Octubre N 2230 Esq Fernando Guachalla 1er Piso La Paz Bolivia	Phone: +591-2 372 249 Fax: +591-2 379 719 E-mail:
Mr. Ben van der Merwe	City of Windhoek P.O. Box 59 Windhoek Namibia	Phone: +264-61 290 2339 Fax: +264-61 290 2114 E-mail: benvdm@iafrica.com.na
Mr. Jorge Vargas	1) SJO 833, Unit C-101 1601 NW 97 st., P.O. Box 025216 Miami, FL 33102-5216, USA 2) P.O. Box 348-2050 Costa Rica	Phone: +1-506 296 1544 Fax: +1-506-234 2063 E-mail: jvcaam@sol.racsa.co.cr
Mr. Jun-qi Wang	Chinese Acad. of Preventive Medicine Inst of Environm. Health & Engineering 29, Nanwei road 100050 Beijing China	Phone: +86-10 63 01 39 87 Fax: +86-10 63 01 18 75 E-mail:
Mr. Rolf Winberg	P.O. Box 30600 Nairobi Kenya	Phone: +254-2 22 90 42 Fax: +254-2 22 08 63 E-mail: rolf.winberg@sida.se
Mr. Uno Winblad	Pataholm 5503 384 92 Ålem Sweden	Phone: +46-499 242 55 Fax: +46-499 242 53 E-mail: uno.win@wkab.se

4
5
6
7

8
9
10
11

Previous publications on Water Resources:

1. Water and Security in Southern Africa
Leif Ohlsson, University of Gothenburg
2. Vattenresurser i sydra Afrika (SADC)
(Water Resources in southern Africa)
Jacob Granit and Bengt Johansson,
Department for Natural Resources and
the Environment
3. Study of Water Resources in Zimbabwe
Yke Nilsson and Amanda Hammer
4. A Liquid More Valuable Than Gold
Pierre Fréling
5. Towards an Ecological Approach to Sanitation
Uno Winblad
6. A Gender Perspective in the Water Resources
Management Sector
Helen Thomas, Johanna Schalkwyk and Beth Woroniuk
7. Most Worthwhile Use of Water
Jan Lundqvist and Klas Sandström
8. The Mighty Mekong Mystery
Joakim Öjendal, Elin Torell



STYRELSEN FÖR INTERNATIONELLT UTVECKLINGSSAMARBETE
105 25 Stockholm, Sweden
Tel. 08-698 50 00. Fax: 08-20 88 64
Hemsida: <http://www.sida.se>

ISBN 91 586 7551 5