

The rope pump in Bolivia

by Timothy Evans

A Bolivian organization devised a simple formula for rating the sustainability of technologies, and they found that, for their circumstances, the rope pump hit the bull's-eye!

LA FUNDACION ANDINA para la Ninez (FAN) had struggled to develop groundwater-based micro-irrigation programmes in several areas of Bolivia's *altiplano*. That effort tested technologies from gasoline-fuelled engines to windmills with 'concrete storage tanks, and from one handpump design to another. Each of the technologies were either too expensive, too hard to maintain, or ineffective for the micro-irrigation needs expressed by the people. Then Jaime Figueroa, Director of FAN, came across a rope pump, a stunning find which may yet become the most significant water-lifting breakthrough to be introduced into the *altiplano* in decades. The process of this discovery is enlightening and worth sharing.

Difficulties with water devices have prompted FAN and its North American collaborator, the Andean Children's Foundation, to establish guidelines by which development facilitators could systematically weed out inappropriate technologies and at the same time prove those showing promise. The criteria are: the technology must be perceived by poor villagers to be useful; it must be accessible to them; and it must be maintainable by them.

Utility + Accessibility = Sustainable
+ Maintainability = technology

That the technology must be environmentally sustainable was also an overriding concern, and was later added as a specific element of the model.

In order to be useful, an innovation must not only provide some perceived benefit, but it must also not cause any

perceived disadvantage. Cultural and environmental considerations are important. Better yields from fewer improved sheep, for example, will be rejected if status among peers is based on the number of head of livestock owned. Improved corn will not be acceptable if traditional tortillas cannot be made with it. In some areas ill-health from a smoky home is accepted because the smoke from traditional stoves is the only available control for termites. In another country, village mothers purposefully keep their children dirty to make them less attractive to an evil *ginn* who steals their spirits.

It was important for FAN to recognize that the rejection of changes to hygiene habits, smokeless stoves, 'improved' agricultural techniques, or any other intervention was not necessarily because of a lack of interest in improved ways, but may be attributable to age-old conventions protecting against what are perceived to be more potent evils. These kinds of attitudes are critical to how villagers perceive the utility of an introduced technology.

FAN understood that the *altiplano* villagers measured risk carefully: it made no sense to invest in commercial fertilizers or improved seed unless the 'more potent evil' of droughts could be mitigated. Otherwise, not only the crop, but also scarce cash reserves are exposed to high risk. This understanding was the basis of FAN's emphasis on micro-irrigation solutions.

In the case of water-lifting devices, FAN found that perceptions of utility were directly proportional to discharge rates. Low-discharge handpumps, al-

though more convenient and hygienic than ropes and buckets, were perceived to have low utility. If the discharge was high enough to irrigate plots during dry spells, then the idea of a pump, whether hand-driven or mechanized, was much more appealing. Once a high-discharge pump was introduced, perceptions of utility also rose dramatically for the greenhouse, the well, and the intensive agriculture technologies which had all been introduced by FAN. This has been termed *synergistic utility*.

Accessibility

The ideas of ownership and control are part of the concept of accessibility. A technology must be either affordable or manufacturable by its recipients, and it must be controllable in such a way that it may be both adopted and adapted to meet individual needs.

Project recipients of introduced technologies may occupy one of several pre-identified levels of technological competence: household (HTC), village (VTC), or centralized (CTC). Although perceived to be useful, the windmill pumps and tanks were too expensive to be owned individually. As village-level projects they were not perceived to be controllable for personal advantage. They were therefore inaccessible as household-level technologies.

Too often, agencies give mechanized technologies to poor people without giving them the means to support these products over time. To FAN this was the opposite of its empowerment ideals. Subsidies, while sometimes necessary to save lives, generally encourage dependency and the loss of traditional skills and know-how. FAN concluded that subsidies must not be interpreted as pertinent to the accessibility equation.

Maintainability

The sum of all the costs, both social and economic, imposed by a given technology on its recipients, is its technological liability. The ability of the recipients to meet that liability or part thereof represents their technological competence. The match-up of technological competence against technological liability defines the maintainability of introduced technologies. FAN has advanced a simple formula to help assess maintainability in terms of this match.

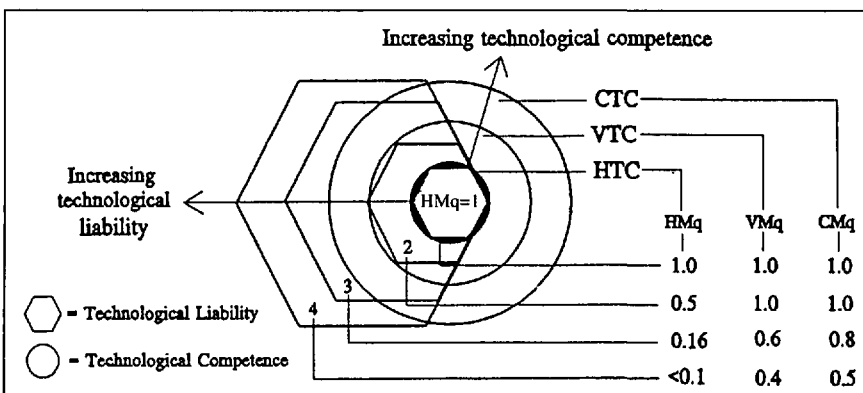

Figure 1. An HMq near or equal to 1 is an ideal match.

Table 1. Search criteria relative to technological sustainability

<i>Elements of technological sustainability</i>	<i>Original search criteria</i>	<i>Achievements to date</i>
Utility	<ul style="list-style-type: none"> ○ Discharge rate >80 litres per minute at 10m lifts; >150 litres per minute at shallow lifts. ○ Water to be available on demand and deliverable to crops at a radius of at least 20 metres. 	<ul style="list-style-type: none"> ○ >100 litres per minute at 10m lifts; >400 litres per minute at 1m lifts. ○ Farmers have irrigated up to 270m away from their well and up to a hectare of land using small channels and furrows radiating from a single well.
Accessibility	<ul style="list-style-type: none"> ○ Must cost less than US\$300. ○ Must be simple enough to copy in local workshops. ○ Must be adaptable to individual needs. 	<ul style="list-style-type: none"> ○ Material costs for shallow pumps including frame <\$35. ○ Farmers and shops have made and sold versions for as low as \$25. The FAN shop has sold pumps from \$70 to \$150. ○ Pump has been adapted as needed by individuals.
Maintainability	<ul style="list-style-type: none"> ○ Must be maintainable by household-level users with basic tools (HMq >0.6). ○ All components must be readily available. ○ Local workshops to make and service pumps. 	<ul style="list-style-type: none"> ○ Most repairs have been made by householders (HMq = 1). ○ All components made in-country including PVC pipe. ○ Local farmers have manufactured their own pumps. Some have set up small shops to make and sell pumps.

helps reduce the technological mismatches so prevalent in intervention situations:

$$Mq = (Ur/Tr)f$$

where *Mq* = Maintainability quotient; *Ur* = user-performed repairs; *Tr* = total number of repairs performed; and *f* = factor based on difficulty and frequency of repairs.

Pumps with quotients near 1 show excellent fit and receive a superior rating; with quotients near 0.5 a fair rating; and with quotients near zero a poor rating. For clarity *Mqs* are prefaced by H, V, or C (for household, village, or centralized) according to the level of technological competence under study.

FAN searched for a pumping device with a technological liability small enough to match the level of technological competence found in typical *altiplano* households. Emphasis was placed on designing a pump which could be manufactured from readily available materials and serviced by household-level users with common tools. The 'bull's-eye' in Figure 1 has an HMq near or equal to 1 and represents the ideal match at the household-level of technological competence sought by FAN.

A pump which could be supported at the village level by a pump caretaker equipped with special tools, parts, and training was deemed inappropriate for the micro-irrigation needs expressed by individual householders. As indicated in Figure 1, a pump at village-level technological competence has a

VMq near 1, while the HMq for the same technology may be near 0.5.

While frequency of repairs will be factored into the equation, durability, in terms of the mean-time-before-failure standard common in industry, is not a major consideration of the maintainability criteria. Rather, mean down-time or availability of the technology for use is to be the major criterion. FAN staff recognized that a well or pump which may be easily repaired by the user, even though it may need repairing more often, is more available, and therefore more reliable, than one which requires outside, often unavailable, support to maintain.

When the search began, it was not certain whether such a pump existed. It was hoped that a pump with an HMq near 0.7 could be found. Column two of Table 1 summarizes the search criteria relative to the three elements of technological sustainability.

Armed with the sustainability equation and a grant from the Thrasher Research Fund, the Foundation staff intensified their search for an appropriate water-lifting device. The needs and ideas of small farmers were taken very seriously. Most mechanized pumps, including windmills, were rejected on price alone. All suction pumps were ineffectual at 13 000 feet.

In his native Peru, Jaime Figueroa discovered an adaptation of the ancient Chinese chain pump which seemed to fulfil the established criteria. FAN is now completing a two-year investigation of the pump in terms of the three elements of sustainability. Among the more remarkable findings are: the

discharge is extremely high, earning a very high perception of utility; farmers are indeed repairing the pumps easily and without delay, using readily available materials independent of outside support; and many farmers have made their own pumps from materials lying around after having seen the prototypes. Frames have been made of crossed poles or adobe columns, and axles of rebar; windlasses have been built from planks bolted to squeeze the inverted sidewalls of tires; pedal mechanisms from bicycles are serving as turn cranks; and discs have been cut from tyres.

Some innovations introduced by ingenious villagers include funnel-shaped guideboxes made from concrete, and no-reverse ratchets made from old circular saw blades. These and other innovations have made the technology exceptionally utilitarian, accessible, and maintainable. Cement and PVC pipe are often the only elements of the pump which need to be purchased new, and even those materials are manufactured locally and are readily available.

Adaptability

Because these are not suction pumps they are practical over a much larger pumping depth. They are slow moving, and have been designed to be operated by women or children. For comparison against the original criteria, column three of Table 1 lists some of the achievements of this remarkable technology.

An interesting challenge for Jaime

and his staff loomed as a result of the burgeoning interest in the pumping technology. Not only are many more wells being constructed because of the appeal of the pump, but the pump out-performs the capacity of most existing wells, which now need to be rebuilt. The difficulty of acquiring and maintaining mechanized pumping equipment to remove water while penetrating deeper into the aquifer became a serious problem. Muddy water damages high speed pumps. Repairs are beyond the reach of most villagers, and had been costly to the Foundation.

Figure 2 depicts a solution to these problems — a special excavation ‘mud pump’, the result of a modification of the basic rope pump design. This tall robust version is adjustable to 1.5 metres below its initial depth, at increments of 20cm or more. Sections of rope and PVC pipe 1.5 metres long may then be added to the mechanism for further penetration if needed. While the pump is not being used for the removal of water and thin mud a pulley may be attached to the frame to lift buckets of more solid debris.

This dynamic synergy of well-digging and water-lifting technologies circumvents much of the need for sophisticated pumping and hoisting equipment. As a result both the motive and the means of well construction are embedded in the emerging rope-pump innovations, opening the door to exciting new self-help opportunities for poor farmers.

Technologies that are accessible and maintainable are clearly more empowering and more consistent with the demands of practical sustainable development. Putting the solution to problems in the hands of the people is not merely the best development policy, but is also supportive of local initiatives, and economically sound. ●

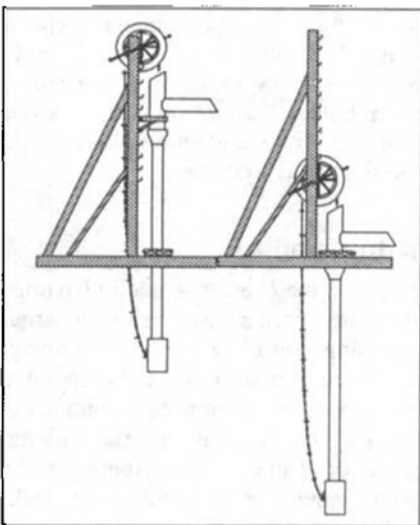

Figure 2. An excavation ‘mud pump’.

Tubing and guide box

The most convenient and effective discharge mechanism is an enlarged extension of the riser tube called a discharge cylinder. It can be made from larger diameter sections of PVC tube, buckets, cans, or even large kitchen pots. A diameter approximately two inches larger than the riser tube with an extension 30 to 40 centimetres above the discharge tube is adequate for high-discharge pumping. The pump is more efficient with an extended discharge cylinder because it reduces splashing and provides pressure to the discharge tube. The discharge tube should be at least 1.2cm larger in diameter than the riser tube for efficient discharge.

Several types of mechanisms have been developed to ease the rope into the riser pipe. A guide box made of wood with a spool rotating on a metal shaft has been used in some areas. It wobbles violently, however, if the pump is operated at speeds desirable for micro-irrigation. It may be stabilized by fastening it to a cross-member attached to the sides of the well, but this diminishes the portability of the pump, and means that the well has to be emptied and someone has to climb down into it to make any repairs or adjustments to the rope. Moreover, wood tends to rot from constant immersion in the water, and the rope may snag between the spool and a warped guide-box frame.

These drawbacks and the scarcity of wood on the *altiplano* have led ingenious farmers to invent a funnel-shaped guide box made of concrete. The figure at bottom right shows two methods of construction using cut, heated, and moulded portions of the PVC tube as slips for the rope and as extensions which hold the tube above the bottom of the well, away from debris which otherwise may be drawn into the tube. The weight of the concrete stabilizes the pump for smooth rapid operation. Also, by lifting both sections of the rope after placing the assembled down-hole portions of the pump into the well, the weight of the block helps orient it properly, eliminating the need to descend into the well. The concrete guide box is trouble-free, durable, and easy to make for farmers used to working with adobe.

Since the rope rather than the vertical pipe bears the load of the water in the column, expensive thick-walled pipes are not needed. The most common tubing in the project is thin PVC, which is manufactured locally. Other materials, such as tin or aluminium sheeting rolled into a tube and then sealed and riveted, or even old cans soldered end-to-end, may be appropriate alternatives.

As long as a metre of PVC above the guide box is a good fit; the upper portion of the riser tube need not fit tightly around the discs. Friction may be reduced this way.

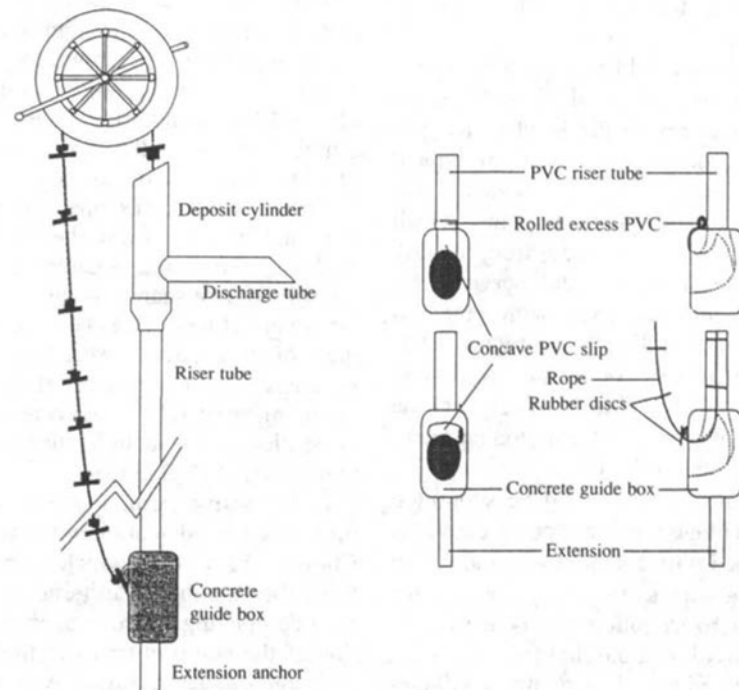

Frame

This simple frame design is easy to manufacture and versatile. The discharge tube may swing through 190 degrees, allowing water to flow into any number of channels which may radiate away from the well to different sections of a cultivated plot. By extending the vertical support the height of the windlass may also become adjustable. This is very helpful during well perforation and in some cases may be useful to adjust the tension of the rope. (See explanation of the excavation pump in main text.)

The purpose of the frame is to hold the windlass steady and about chest-high. That may be accomplished in many ways, as depicted in the drawings below. Wood, metal, adobe, stone, and other masonry have been the most common materials used in the Bolivian *altiplano*. Bamboo and even plastic may be used in areas where it is available. One very simple option is to attach the windlass to an extension of the concrete ring structure used to line the well.

The adobe frames seem to be the least expensive and the easiest for many rural farmers to build. If splashing is not controlled the adobe columns should be coated with a water-shedding stucco.

Virtually any configuration which is sturdy and stable and which allows for free movement of the wheel and rope will work. Trial-and-error experimentation with locally available materials will eventually produce the optimal design for a given area. A ballast of boulders or sacks of sand placed on the base is helpful to stabilize lighter frames.

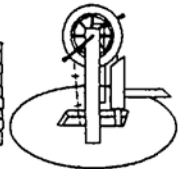
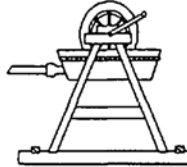
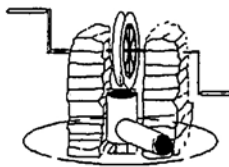
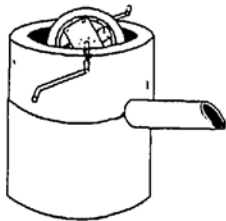
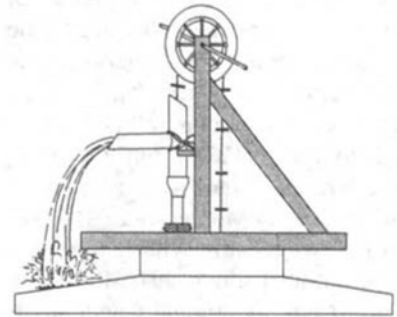
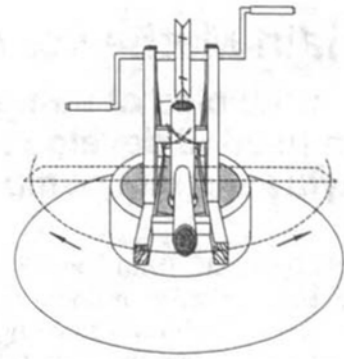

Windlass

The windlass is made from the side walls of tyres. This is an ingenious innovation which brings the pump technology much closer to the level of technological competence of rural peasants. The flexible V-pully grabs the rope and discs as they emerge randomly from the deposit cylinder. This means that the spacing problems associated with close-tolerance sprockets are eliminated, and allows load-stretchable materials such as rope to be used in place of more expensive and hard-to-get ones. (Rope and used tyres are normally readily available.)

Tyres salvaged from wheelbarrows, cars, motorcycles, and large trucks, with inside diameters ranging from six to over twenty inches have been used successfully for these pumps. FAN has found the 13-inch tyre to be practical for most applications. A radius of eight to twelve inches for the turn-crank arm ensures an adequate mechanical advantage for high discharge pumping of average-depth wells, while providing comfortable pumping effort.

Like the frame, the windlass may be constructed from a variety of materials; FAN has experimented with those depicted in the drawings opposite, and with other less successful ones. The welded rebar version with eight spokes is the windlass preferred by Foundation shopworkers. Materials are inexpensive and the design is easy to make using only basic equipment. Farmers who are interested in making their own pumps but who do not have welding equipment tend to use bolted planks or a concrete flywheel. If attached to a set of used bearings the concrete flywheel is ideal for smooth durable operation, but it would wear out wooden bearings. The flywheel and the eight-spoke windlass maintain their symmetry very well, while some of the other designs may lose it over time.

The length of the turn-crank arm and the diameter of the windlass, along with the diameter of the riser pipe and discs, may be adjusted according to the pumping effort desired for a given well depth.



Strap metal



Crossed wooden boards



8 rebar spokes



6 rebar spokes



Concrete flywheel



Wooden planks



Wooden planks with block supports

