

TAG Discussion Paper Number 1
United Nations Development Programme
Interregional Project INT/81/047
Executing Agency: World Bank

MICROFICHE COPY

11434

Report No.: 11434 Type: (MIS)
Title: VENTILATED IMPROVED PIT LATRIN
Author: MORGAN, PETER
Ext.: 0 Room: Dept.:
1985

Ventilated Improved Pit Latrines: Zimbabwean Brick Designs

**Peter R. Morgan, Blair Research Laboratory,
and D. Duncan Mara, Technology Advisory Group**

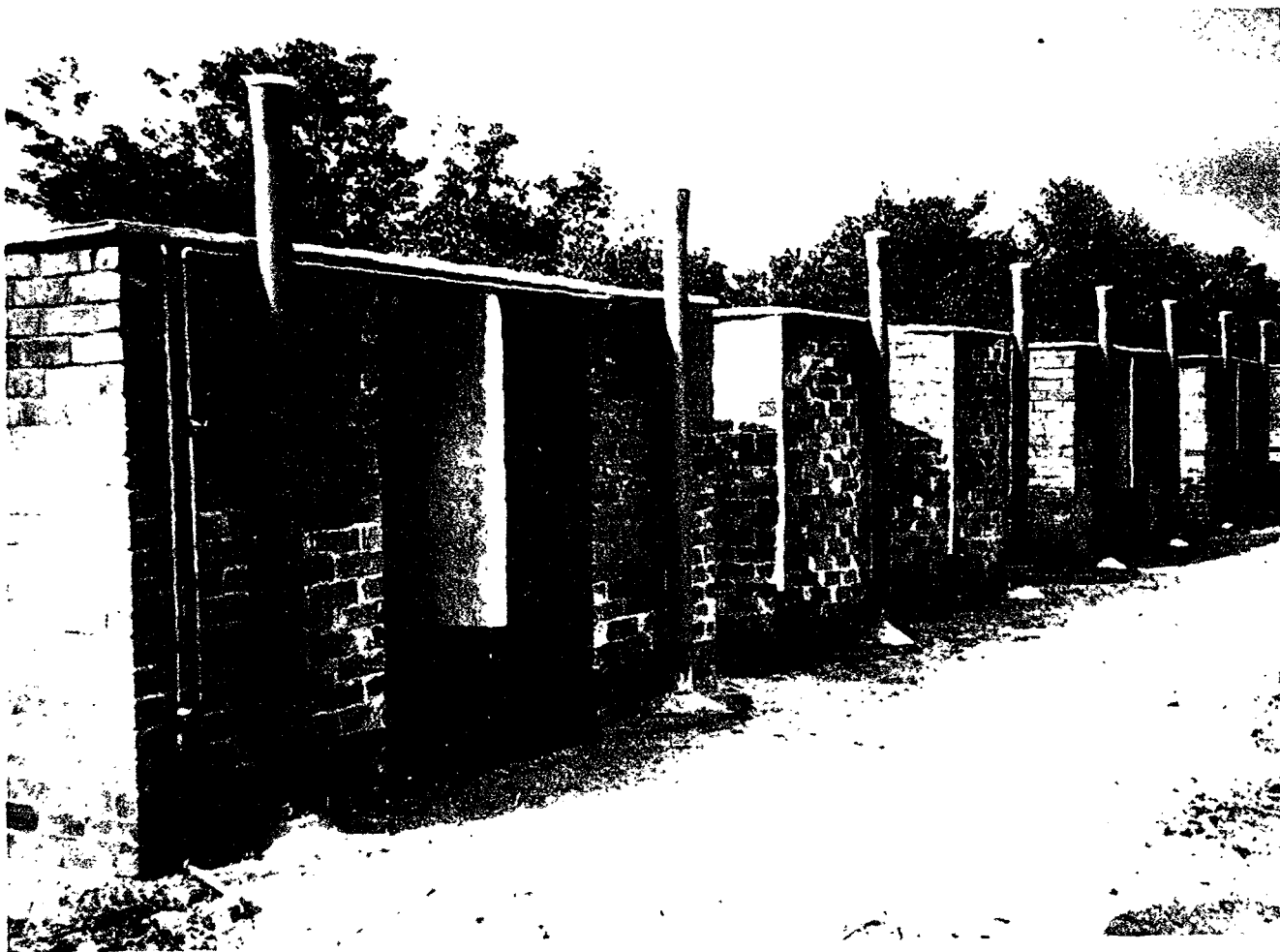

**A joint contribution of the Government of
Zimbabwe, the United Nations Development
Programme, and the World Bank to the International
Drinking Water Supply and Sanitation Decade**

Copyright © 1985
The International Bank for Reconstruction
and Development/THE WORLD BANK
1818 H Street, NW.
Washington, DC 20433, USA

All rights reserved
Manufactured in the United States of America

PREFACE

This Discussion Paper by Peter R. Morgan and D. Duncan Mara describes the latest developments in Zimbabwe in the design of Ventilated Improved Pit (VIP) latrines. These designs, based on the use of brick rather than other construction materials, have proved very popular in rural and periurban areas in Zimbabwe.

It is hoped that other countries will be able to benefit from Zimbabwe's extensive experience in pioneering on-site sanitation systems and will be able to modify these Zimbabwean designs as necessary to suit their own particular sociocultural and physical conditions.

This document is being given a limited distribution as a discussion paper. Comments and suggestions are invited from readers, especially information on the design and cost of improved latrines, the delivery and support systems needed to make sanitation programs effective and on experience in sanitation program design, implementation and replication. TAG is not going to be able to reply to individual correspondents but plans to re /ise this discussion paper in due course to reflect, as appropriate, the comments and contributions received from readers.

The distribution of the Discussion Papers does not imply endorsement by the sector agencies, government, or donor agencies concerned with programs, nor by the World Bank or the United Nations Development Programme.

Enquiries about the TAG program and the publications available, and comments on this and other TAG papers, should be addressed to the Project Manager, UNDP Project INT/81/047, Water Supply and Urban Development Department, The World Bank, 1818 H Street, N.W. Washington, DC 20433.

Richard N. Middleton
Project Manager

1/ TAG: Technology Advisory Group, established under the United Nations Development Programme, UNDP Interregional Project INT/81/047: **Development and Implementation of Low-cost Sanitation Investment Projects** (formerly Global Project GLO/78/006), executed by the World Bank.

TABLE OF CONTENTS

	<u>Page No.</u>
PREFACE.....	(i)
ABSTRACT.....	(iii)
INTRODUCTION.....	1
THE BLAIR BRICK VENTILATED IMPROVED PIT LATRINE	1
Substructure.....	4
Superstructure.....	4
Vent Pipe.....	6
Maintenance.....	8
Costs.....	8
DOUBLE AND MULTICOMPARTMENT VIP LATRINES.....	12
VIP LATRINES WITH SOAKAWAYS.....	12
ANNEXES	
I Working Drawings.....	16
II Bills of Quantities.....	24
III Photographs of a Brick VIP Latrine during construction.....	35

ABSTRACT

This Discussion Paper describes the most recent developments in the design of ventilated improved pit (VIP) latrines in Zimbabwe. It is a supplement to The Technology Advisory Group Working Paper Number 2, entitled: **Ventilated Improved Pit Latrines: Recent Developments in Zimbabwe**, by the same authors (World Bank, Washington, DC: 1982). Since the publication of this Working Paper, there has been a shift away from the construction of both ferrocement and "pole and dagga" (mud and wattle) latrines in favor of brick latrines. This has occurred because brick latrines are less expensive than ferrocement ones and because in rural areas of Zimbabwe wood for the construction of pole and dagga latrines is becoming scarce. The brick latrine has a round or "square spiral" superstructure, a 50 mm thick 1.5 m diameter reinforced concrete cover slab and a 1.2 m diameter pit dug to a depth of 3 m. The pit is lined with either cement mortar or, in unstable soils, open-joint brickwork. The roof of the superstructure is made from thatch or ferrocement and the vent pipe from either brick (internal dimensions; 230 mm square) or PVC (110 or 160 mm external diameter). The top of the vent pipe is covered by a stainless steel (16 mesh; 28 swg) flyscreen. Construction costs vary from about \$50 (equivalent) for the cheapest rural VIP latrine to about US\$250 for the most expensive urban version. Designs for double- and multi-compartment VIP latrines are also discussed; the former are suitable for households where there is a strong sociocultural preference for separate facilities for men and women, and the latter for schools and other institutions. A recent development in Zimbabwe has been the design of VIP latrines with soakaways for use in periurban areas where the household size exceeds 10 persons; these may cost up to US\$350 but are permanent, desludgeable facilities.

(iv)

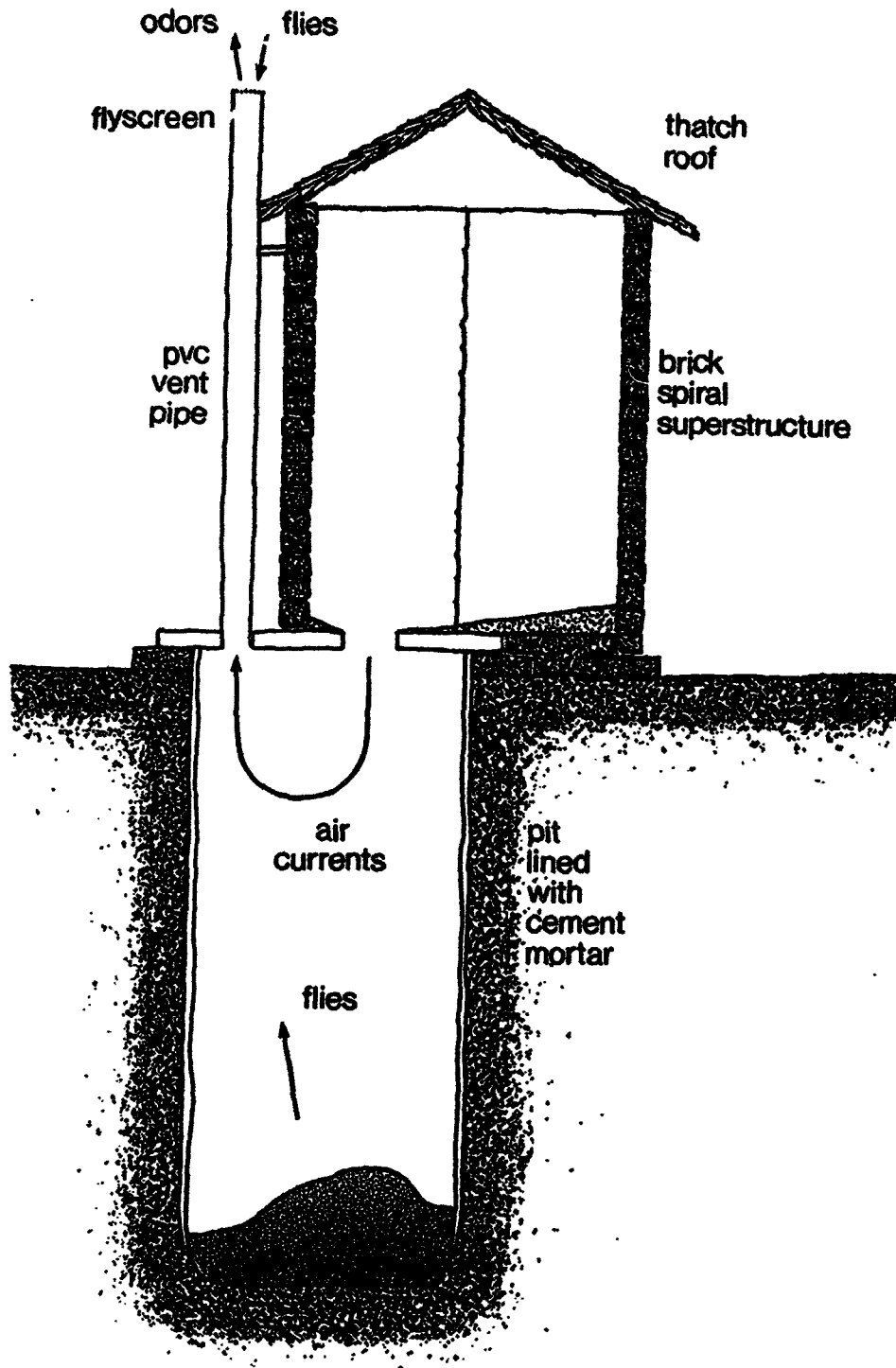

Figure 1. Schematic diagram of a ventilated improved pit latrine.

INTRODUCTION

1. A ventilated improved pit (VIP) latrine was developed in Zimbabwe in the 1970s as an odorless, fly-free toilet suitable for use in both rural and low-density urban areas (Figure 1). The developments in Zimbabwean VIP latrine design up to 1981 are reviewed in a separate Working Paper^{1/}. That publication described the design of single-pit VIP latrines with spiral superstructures of either ferrocement, for urban areas, or "pole and dagga"^{2/} (mud and wattle) for rural areas. The 1981 cost^{3/} for materials and labor was Z\$99 (US\$150) for the ferrocement latrines and only Z\$5 (US\$8) for the materials for the pole and dagga version, which is commonly built by self-help labor. Recently, however, the Blair Research Laboratory (Ministry of Health, Zimbabwe) has developed a number of low-cost brick VIP latrines, which are described in this Discussion Paper. Brick latrines are now preferred in both urban and rural areas of Zimbabwe to the ferrocement and pole and dagga latrines for the following reasons:

- (a) they are cheaper and easier to construct than the ferrocement version in rural areas (see paragraphs 11 and 12 for a detailed breakdown of costs);
- (b) wood for the construction of the pole and dagga latrine is becoming scarce, and for conservation reasons the Government of Zimbabwe is discouraging its removal and use; and
- (c) although its materials cost is higher than that for the pole and dagga latrine, a brick latrine is preferred in the rural areas to the latter as it is a more permanent facility which is generally regarded with pride as a "status symbol" by its owners.

THE BLAIR BRICK VENTILATED IMPROVED PIT LATRINE

2. The Blair brick VIP latrine (Figures 2 and 3) is based on exactly the same principles of design and operation of other Zimbabwean VIP latrines^{1/}. It is a single-pit latrine (see paragraph 14) which comprises: (a) a substructure (the pit, which is lined; the pit collar; and the cover slab); (b) a superstructure; and (c) a vent pipe which is fitted with a flyscreen. These component parts are described in turn below. Working drawings and bills of quantities are given in Annexes I and II respectively, and Annex III contains a photographic record of the construction of a typical Blair brick latrine.

^{1/} P.R. Morgan and D.D. Mara, **Ventilated Improved Pit Latrines: Recent Developments in Zimbabwe**, TAG Working Paper No. 2 (World Bank Washington, DC: 1982).

^{2/} "Dagga" is the local Zimbabwean term for soil taken from termite hills. This material has better adhesive properties and greater durability than ordinary soils.

^{3/} Apart from the 1981 costs in paragraph 1, all costs in this Technical Note have been converted at the September 1983 rate of exchange: Z\$1 = US\$0.95.

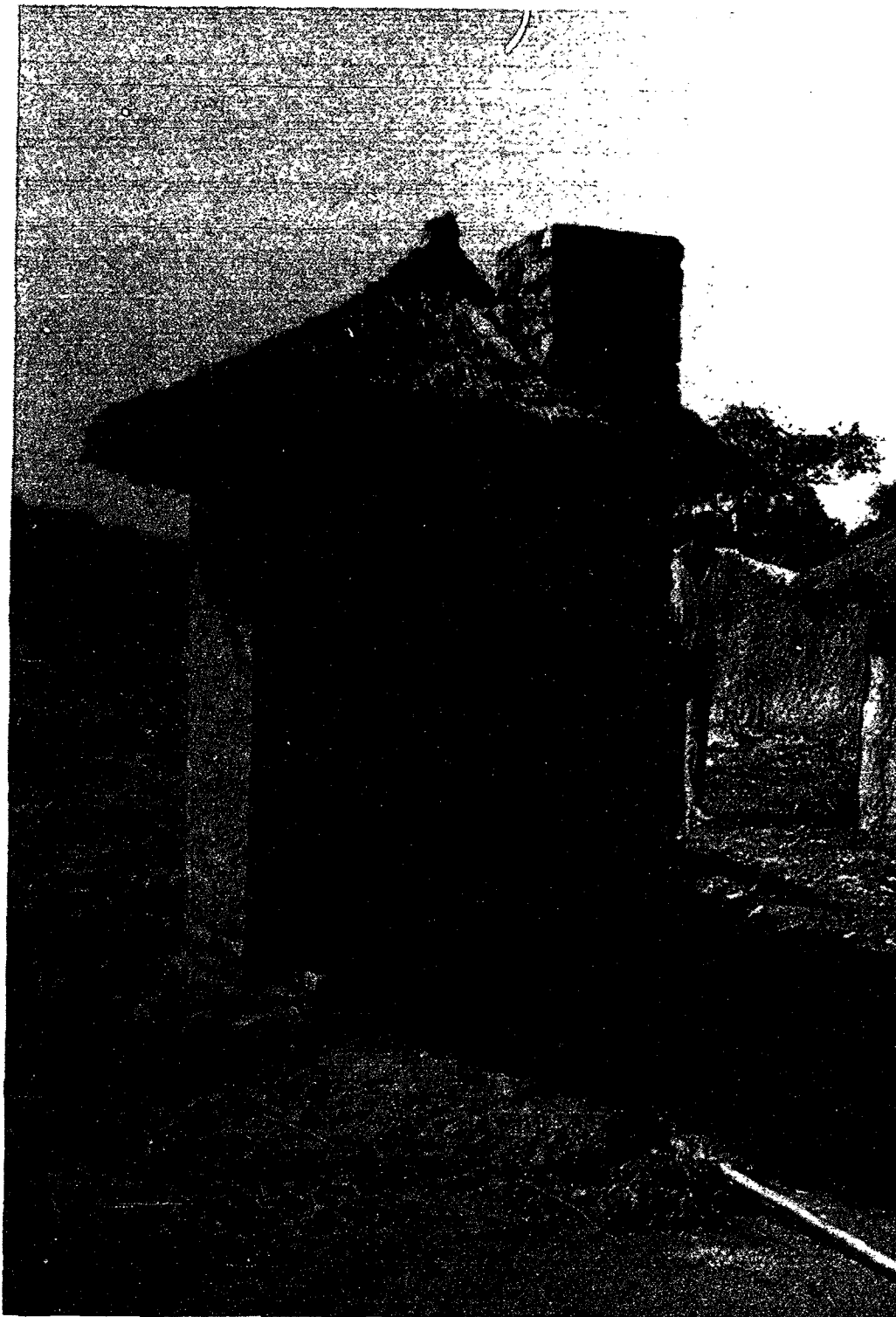

Figure 2. A Blair brick VIP latrine with a brick vent

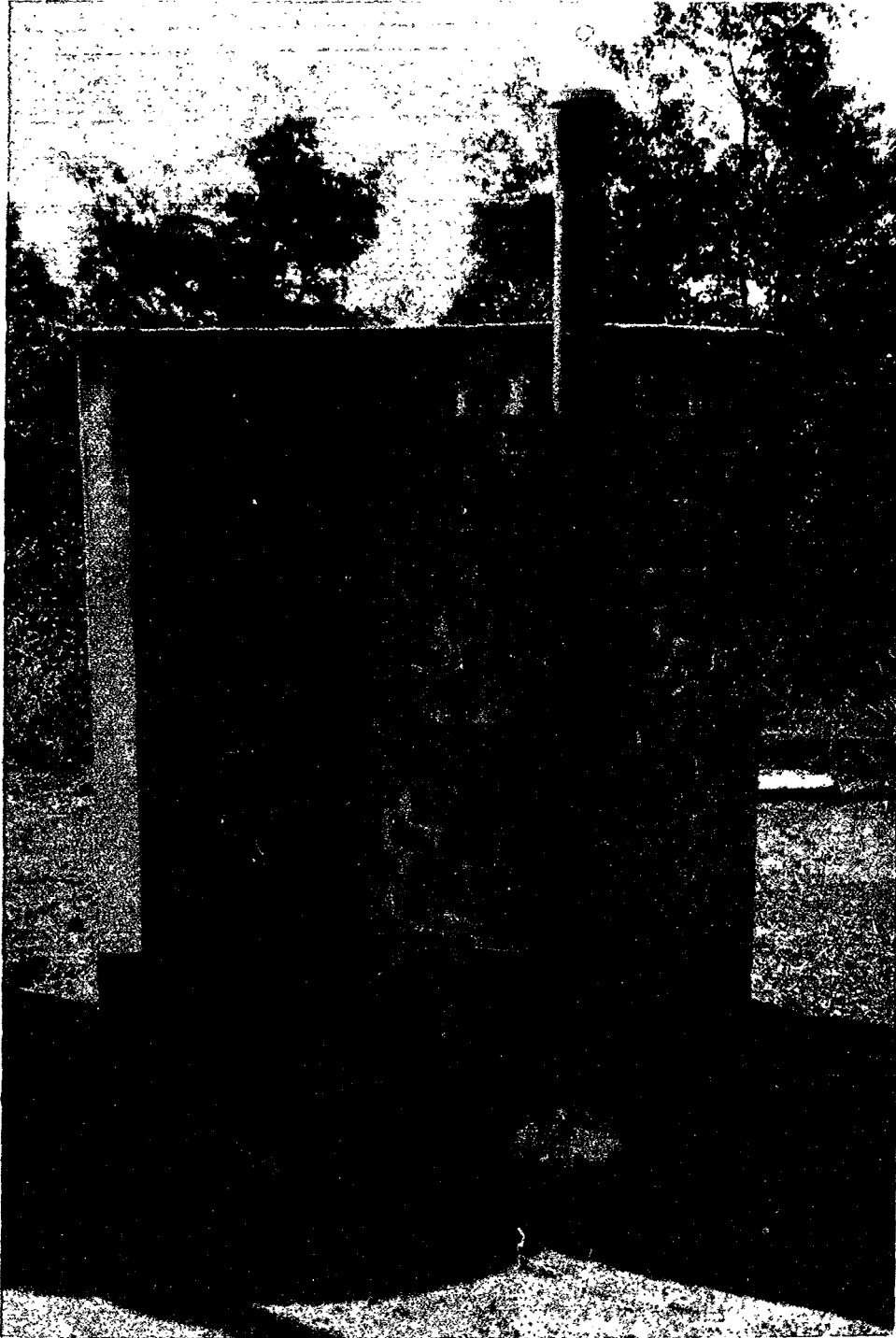

Figure 3. A Blair brick VIP latrine with a PVC vent pipe.

Substructure

3. The substructure differs from that previously described (see footnote 1/ on page 1). The pit has a diameter of 1.2 m and is dug to a depth of at least 3 m. In stable soils the pit is fully lined with cement mortar (1 part cement, 8 parts of river or builder's sand^{4/}); only the base of the pit is left unlined so as to permit infiltration of liquids into the soil^{5/}. In unstable soils the pit is lined in open-joint brickwork. At ground level a circular collar of bricks is laid in cement mortar of the same mix proportions (see Drawing No. ZBVIP/02 in Annex I).

4. The ferrocement (1 part cement, 5 parts river sand) cover slab, which is mortared on the collar, is 1.5 m in diameter and 50 mm thick. The reinforcement is placed at mid-depth and comprises 8 s.w.g. (approximately 3 mm) mild steel rods at 150 mm centers (see Drawing No. ZBVIP/3 in Annex I, which also gives details of the apertures to be left in the slab for the squat hole and the vent pipe). In Zimbabwe it is now becoming more common for the cover slabs to be mass-produced at district-level casting works operated by the Ministry of Health, although they can be easily cast on site. The materials cost of a mass-produced cover slab is Z\$4.20 (US\$4.00).

Superstructure

5. The superstructure has a spiral shape which permits privacy without the need for a door and maintains the inside of the latrine reasonably dark so that newly-emergent flies are attracted up the vent pipe where they are trapped by the flyscreen. There are two basic shapes: a true spiral and a "square spiral" (Figure 4). The choice between these shapes is normally left to the householder but, if the latrine is to be used also as a washroom, as is usual in Zimbabwe, the square shape permits more room and is becoming more common in Zimbabwe for this reason. As shown in Figure 4 (and in more detail in Drawing No. ZBVIP/04 in Annex I) the superstructure is offset from the pit and only part of it lies over the cover slab; the rest of the superstructure is supported on a single course of bricks laid in cement mortar at right angles to the superstructure. Approximately 400 bricks are required for the round spiral superstructure and 600 for the square version. Both designs are built to a height of 20 courses, using cement mortar (1 part cement, 5 parts river sand). The inside of the superstructure is plastered with cement mortar to give a smooth finish.

4/ In southern Africa sand is usually described as either pit (or quarry) sand or river sand to indicate its origin. Pit sand has a high proportion of very fine material, with generally much more than 3% passing a British Standard No. 200 sieve (0.074 mm). Builder's sand refers to pit sand that has been graded to remove most of the fine material so that it closely resembles river sand in its particle size distribution.

5/ Infiltration will also occur through the mortar lining, which is reasonably porous.

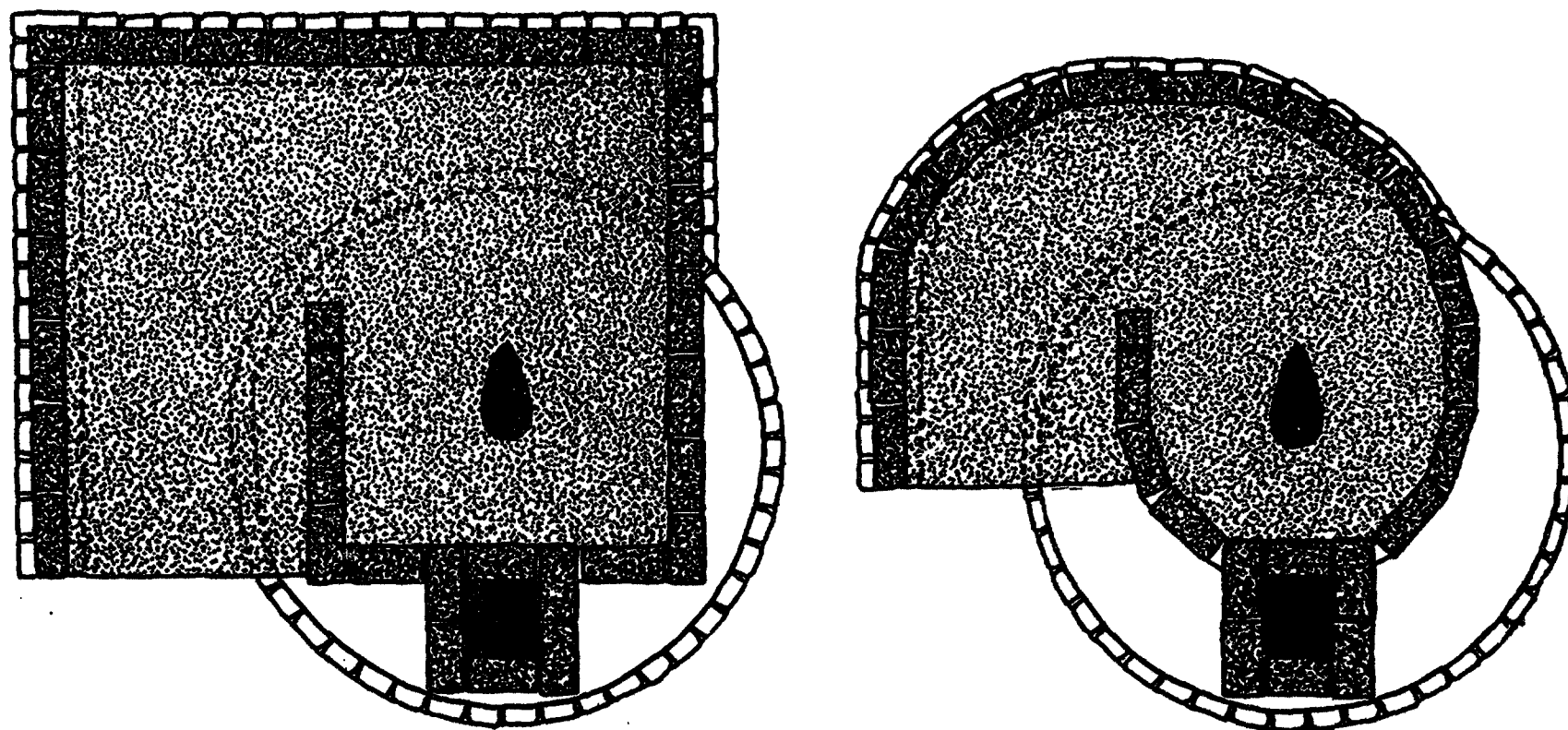

Figure 4. Alternative shapes of spiral superstructure for VIP latrines.

6. The roof may be made from thatch supported on saplings (Figure 2) or ferrocement (Figure 3), although other materials such as corrugated iron or asbestos cement sheeting may be used. In rural areas of Zimbabwe thatch roofs are generally preferred, not only because the materials are freely available but also because they are cooler; it is important that sufficient thatch is used in order to prevent the penetration of light into the superstructure and to achieve good fly control. Ferrocement roofs are made with cement mortar (1 part cement, 3 parts river sand) reinforced with a single layer of chicken mesh; the slab thickness is 25 mm (details are given in Drawing No. ZBVIP/05 in Annex I). After curing the slab is mortared onto the superstructure.

7. Once the roof is in place and a brick step (to keep out rainwater) has been made at the latrine entrance (Figure 5), soil is used to raise the level of the exposed ground within the superstructure to that of the cover slab. When this has been well compacted by tamping, cement mortar (1 part cement, 3 parts river sand) is laid over the compacted soil and the cover slab to a sufficient depth so that the latrine floor slopes towards the squat hole all round. Once it has set, the mortar may be painted to seal the surface.

Vent pipe

8. Either brick or PVC vent pipes are used. The brick vent pipe is built six courses higher than the superstructure; since the superstructure forms one side of the vent pipe (Figure 4), 126 additional bricks are required to build the vent pipe. The internal dimensions of the vent pipe are 225 mm x 225 mm which have been found to give satisfactory ventilation rates for odor control^{6/}. Ultra-violet-stabilized and black-pigmented PVC vent pipes are now commercially available in Zimbabwe; these are 2.5 m long, with an external diameter of either 110 mm or 160 mm which is expanded at the top to either 160 mm or 200 mm respectively^{7/}. The PVC vent pipe must be firmly fixed to the cover slab at its base and to the superstructure; design recommendations are given in a separate Technical Note in this series^{6/}.

9. **Fly screen.** Stainless steel flyscreens are now becoming more popular in Zimbabwe than PVC-coated glass fiber screens. Although more expensive, they are much more durable and can be expected to have a life of at least 20 years. The costs of a 180 mm diameter disc of 16 mesh, 28 s.w.g. stainless steel flyscreen (suitable for use with the 100 mm PVC vent pipe),

6/ B.A. Ryan and D.D. Mara, **Ventilated Improved Pit Latrines: Vent Pipe Design Guidelines**, TAG Technical Note No. 6, 1983.

7/ Fieldwork done in Zimbabwe by the Technology Advisory Group (TAG) (described in 6/) has however shown that such top expansion is not necessary as it does not significantly improve ventilation rates.

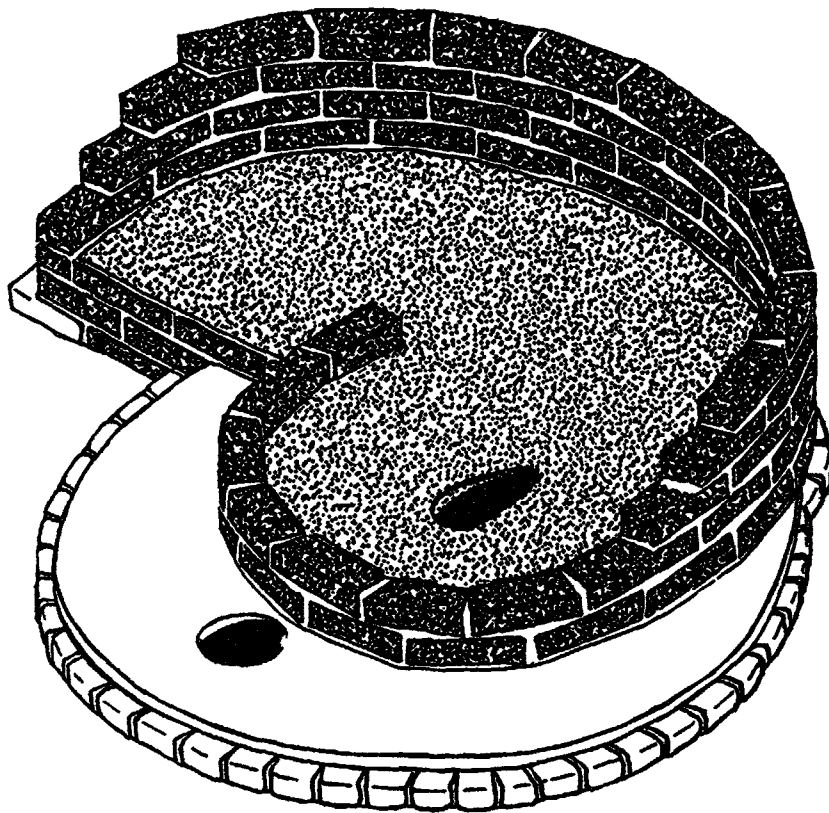

Figure 5. Isometric sketch of a brick VIP latrine during construction.

cut to size by the manufacturers^{8/} is approximately Z\$1 (US\$0.95), which represents only about 2 per cent of the materials cost of the latrine. When used with PVC vent pipes the stainless steel mesh is fixed to the pipe, usually by the pipe manufacturers, as shown in Figure 6. With brick vent pipes, a 300 mm square of stainless steel mesh (costing Z\$4, US\$3.80) is mortared on to the top course (Figure 7).

Maintenance

10. VIP latrines require little maintenance: regular washing of the cover slab, and periodic inspection of the flyscreen and the removal of any leaves or other objects lying on it are all that is required. A simple way to inspect the flyscreen is to use a mirror at the top of a pole (Figure 8). If there are cobwebs inside the vent pipe, they should be removed by pouring a bucketful of water through the flyscreen. The latrine floor will need to be repainted from time to time.

Costs

11. "Rural" brick VIP latrines. The lowest cost brick VIP latrine, which is suitable for use in rural areas, has a thatch roof and a brick vent pipe (Figure 2). Assuming that it is built entirely by self-help labor and that sand and the roofing materials are obtained free from the bush, the material cost of this latrine varies between Z\$48 and Z\$69 (US\$46 and US\$66), depending on whether the soil is stable or unstable and whether the superstructure has a round or square spiral shape; detailed costs are given in Annex II. Labor costs, if self-help labor is not used, add Z\$33 (US\$31).

12. "Urban" brick VIP latrine. The cost of a VIP latrine, suitable for use in urban or periurban areas by single households of around six people (but see paragraph 15), varies between Z\$172 and Z\$260 (US\$163 and US\$247) depending on whether it is built in stable or unstable soil, what shape the superstructure has and whether the vent pipe is made from brick or commercially available PVC or asbestos cement pipes are used; detailed costs are given in Annex II. These costs for urban latrines assume that self-help labor is not used; if it is, then they would be reduced by Z\$57 (US\$54).

13. Latrine life and annual costs. The pit dimensions are 1.2 m diameter x 3 m deep. Assuming the pit is used until it is full to a depth of 2.5 m, its effective volume is 2.83 m³. Solids accumulation rates in Zimbabwe are estimated to be approximately 0.02 m³ per person per year^{9/}, so the latrine will last a family of six (the average household size in Zimbabwe) for

^{8/} The cost quoted is based on a minimum order for 300 discs and includes c.i.f. charges Harare. The material itself costs approximately US\$25 per m² ex-works.

^{9/} This low solids accumulation rate is valid in areas where the latrine is used for personal bodywashing (commonly a "bucket shower" is taken daily, adding some 10-15 litres of water per caput to the pit) and where regular toilet paper is used for anal cleansing.

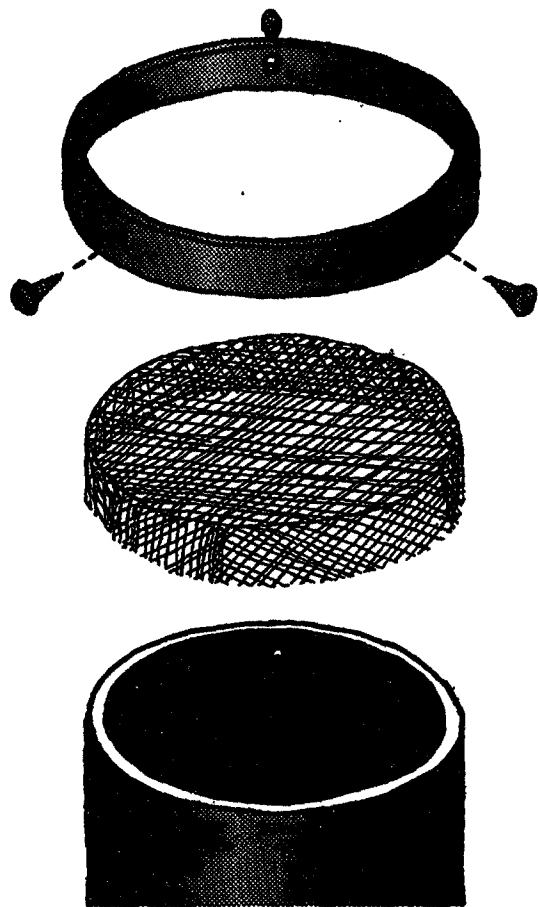

Figure 6. Attachment of flyscreen to PVC vent pipe.

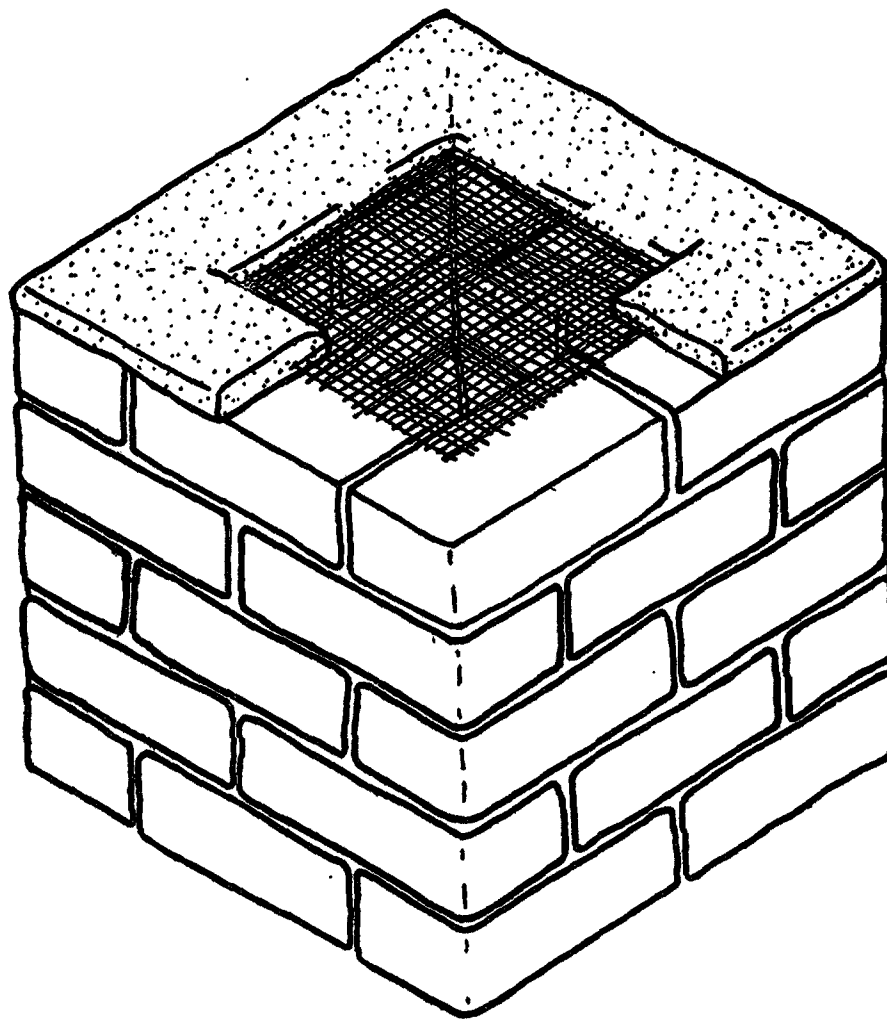

Figure 7. Attachment of flyscreen to brick vent pipe.

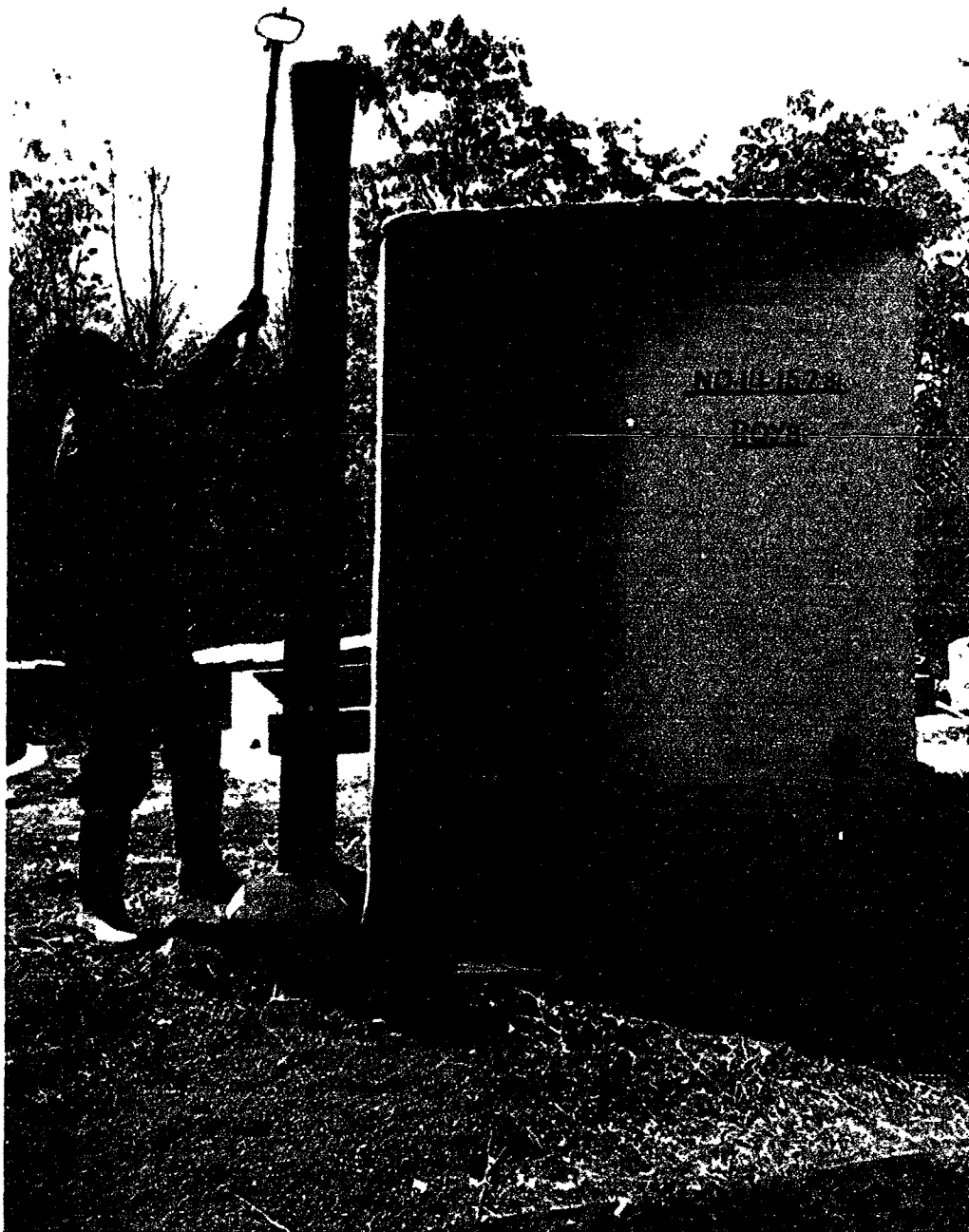

Figure 8. Flyscreen inspection using a mirror on top of a pole.

$[2.83/(00.02 \times 6)] = 23.6$ years. Such a latrine may be considered a permanent fixture and its cost written off after this time. Total annual costs per household for the least expensive (\$48) rural latrine are \$8.40 annually (assuming a 20-year life, discounting at 12 per cent, and including \$2.00 per year for operation and maintenance). The corresponding cost for an urban latrine (Z\$172) is Z\$25.00. Total annual costs for more expensive types of VIP latrines are given in Annex II.

14. **Single-pit and alternating twin-pit VIP latrines.** Experience in Zimbabwe has been limited to single-pit VIP latrines since it has been found in most areas that it is possible to construct these latrines with an effective life of at least 20 years, and there has been no need to resort to alternating twin-pits. There are, however, certain circumstances in which it might be necessary to use the twin-pit option:

- (a) where there is shallow, unpickable, rock; or
- (b) where pollution of shallow groundwater must be avoided because it is the only feasible source of drinking water.

Alternating twin-pit VIPs^{10/} are suitable in these circumstances because their total pit depth can be less than 1 metre. However, a preliminary cost estimate for small twin-pit VIP latrines, each pit having an effective volume of 0.75 m³ and an estimated life of three years^{11/} is Z\$100 (US\$95) for materials only, even using low-cost rural bricks. The recommended Ministry of Health practice, to use single-pit VIP latrines under most conditions, is clearly the most economical solution.

^{10/} J. van Nostrand and J.G. Wilson, **The Ventilated Improved Double-Pit Latrine: A Construction Manual for Botswana**, TAG Technical Note No. 3, 1983.

^{11/} This estimate of effective life is based on a solids accumulation rate of 40 litres per caput per year (lca), twice that found in practice in Zimbabwe when single-pit latrines are used also for taking bucket showers (see footnote 9). The rate of 40 lca is used in Zimbabwe when bucket showers are not taken and when anal cleansing materials other than regular toilet paper are used, and should also be used when designing pits with short lives (3 years or less) since there is evidence that full digestion of the pit contents only occurs with lives of 4 years or more.

The use of values as low as 20 lca is clearly justified in cases such as Zimbabwe where there is ample field experience to support them. In programs in other countries, however, where there is still uncertainty over the effects of diet, anal cleansing materials and pit conditions on the solids accumulation rate, it would be prudent to use the traditional design values (60 lca and 40 lca in wet and dry pits respectively, to be increased by 50 percent where bulky anal cleansing materials are used).

DOUBLE AND MULTICOMPARTMENT VIP LATRINES

15. In areas of Zimbabwe, such as Matabeleland, where there is a strong sociocultural preference for separate latrines for male and female members of the household, double-compartment VIP latrines of the type shown in Figure 9 have been developed. In stable soils each compartment may have its own pit, but in unstable soils a common pit with a fully mortared brick dividing wall is used. In rural areas especially this type of latrine is generally too expensive for one household but, in order to reduce costs to an acceptable level, neighboring households have been willing to share a single latrine of this type, with the men from both households using one of the compartments and the women the other.

16. For schools and other institutions multicompartment VIP latrines have been developed. These are essentially the same as the double-compartment unit but of course with more compartments. The number of compartments depends on the number of users, with a design guideline of 10 persons per unit (20 persons per unit in non-residential institutions). The number of users per unit can be increased to 25 if soakaways are provided as discussed below.

VIP LATRINES WITH SOAKAWAYS

17. In periurban areas in Zimbabwe it is now becoming increasingly common for a single VIP latrine to serve more than six people. This is due to higher household sizes in these areas and also to more than one household sharing the same facility; as a result, the number of people using a single latrine can be as high as 15 or even, exceptionally, 25. Under these circumstances the life of a single-pit VIP latrine will be considerably less than 20 years. In order to prolong the life of single-pit VIP latrines, versions have been designed with adjacent soakaways (Figure 10). The latrine pit, including its base, is completely sealed with cement mortar in stable soils or with fully mortared brickwork in unstable soils. At a point 2.25 m above the pit base a 75 mm diameter^{12/} PVC pipe with a sanitary tee is installed which leads to an adjacent soakaway located at least 1 m away from the pit; the sanitary tee is positioned immediately below the vent pipe, so that it may be inspected (and any blockages cleared by rodding) simply by removing the vent pipe. The soakaway has a diameter of 1.5 m^{13/} and a depth of 2 m; it is lined to a depth

12/ Currently 63 mm diameter pipe is being evaluated.

13/ This diameter was chosen so that the coverslab for the soakaway is the same size as that for the pit, so that the same molds can be used; the soakaway coverslab does not of course have a squat-hole nor a ventpipe hole. The dimensions given above (and in Drawing No. ZBVIP/07 in Annex I) are for units to serve up to 15 users. For latrines designed for up to 25 users the pit diameter is increased to 1.5 m, and the soakaway comprises 1.5 m diameter unmortared brickwork surrounded by 15 cm of annular gravel packing and covered by a 1.8 diameter reinforced concrete slab.

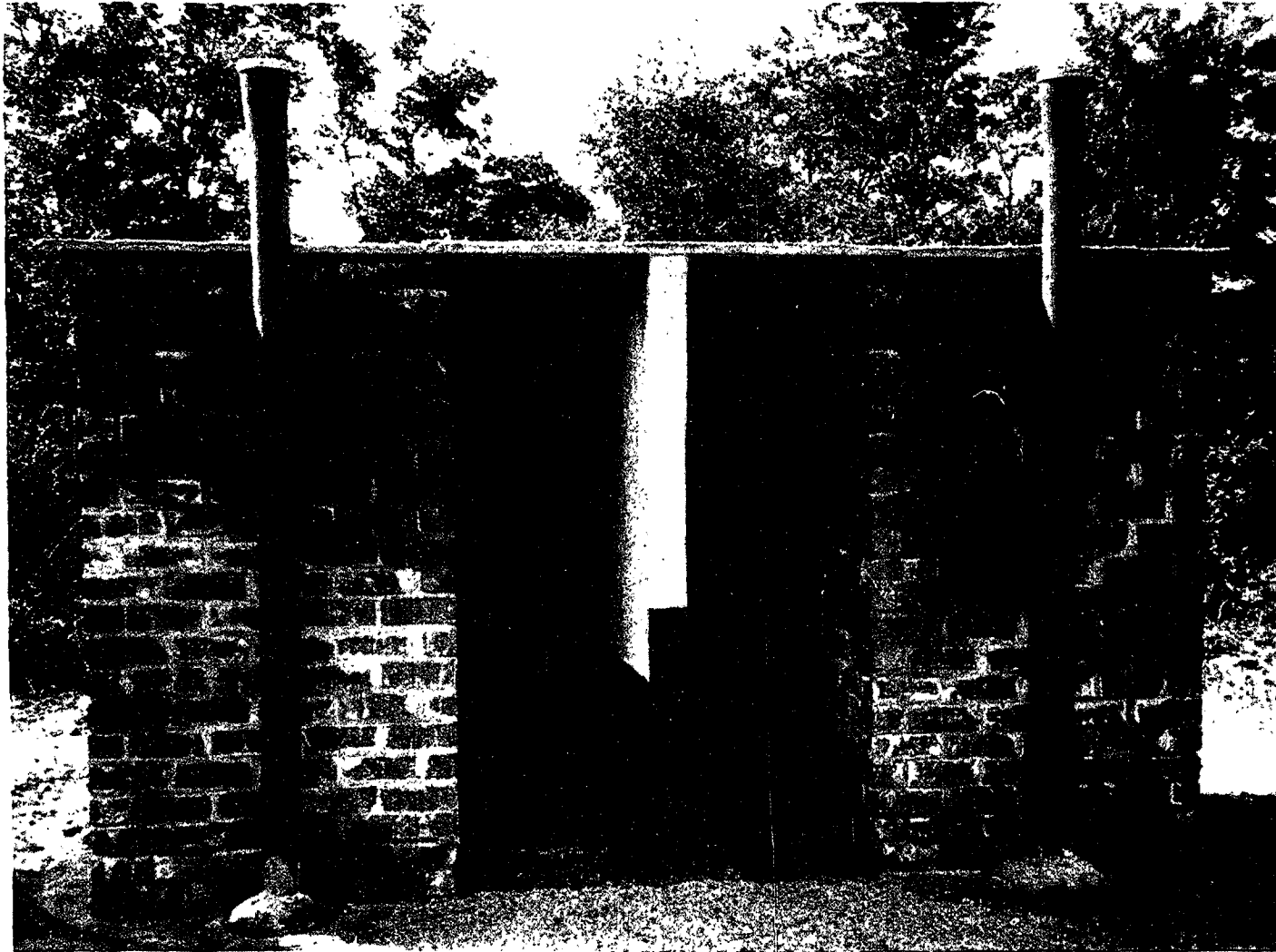

Figure 9. A double-compartment brick VIP latrine.

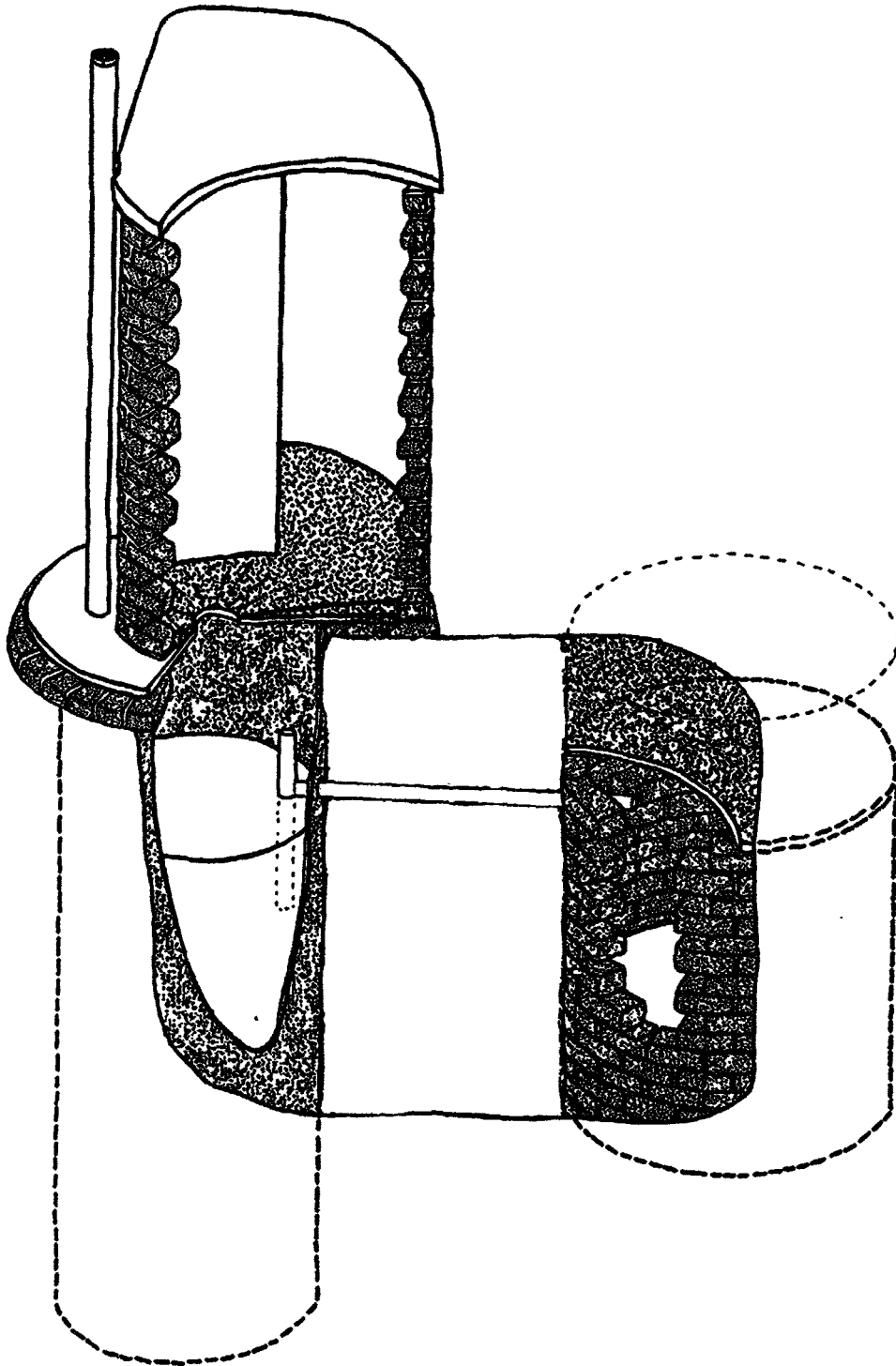

Figure 10. Schematic diagram of VIP latrine with soakaway.

of 1.4 m with unmortared brickwork, 1.2 m diameter, which is surrounded by a 15 cm annular packing of 25 mm gravel. A reinforced concrete cover slab is placed on the bricks and the remaining space above it backfilled (see Drawing ZBVIP/07 in Annex I).

18. The sealed pit is filled with water before the latrine is put into use. Where the latrine is not used as a bathroom, water should be added regularly (at least once a week) to the sealed pit to make up for the water displaced into the soakaway pit. In order to prevent mosquito breeding during the first few months when there is no scum crust present, 0.5 kg of 3-4 mm expanded polystyrene beads is added to the pit; this has been found to be a very effective form of mosquito control^{14/}.

19. This type of pit latrine (which essentially resembles an aqua-privy with a vent pipe in place of the drop-pipe) has only been used in Zimbabwe for the last seven years, so it has not been possible so far to estimate its total useful life. Early indications are that it is performing well in periurban areas, with a sludge accumulation rate of less than 20 lca. With regular desludging of the pit (say, every five years), it can be expected to last much longer than other types of VIP latrines.

20. The additional costs of the soakaway, extra lining of the pit and the PVC pipe and tee-piece, including labor, total Z\$97 (US\$92) in stable soils and Z\$98 (US\$93) in unstable soils. Thus the total cost of a square spiral VIP latrine with soakaway in unstable soil, for example, is Z\$385 (US\$366). A more detailed cost breakdown is given in Annex II.

21. An even more recent development has been to discharge the effluent from a line of VIP latrines into a short small bore sewer (75 mm diameter, laid at a gradient of 1 in 200) which leads to a communal soakaway. This is a very useful option in areas where there is insufficient space on each plot for an individual soakaway. Moreover, it has been possible to upgrade this type of latrine to a low-volume cistern-flush toilet for added user convenience.

14/ P.R. Morgan and D.D. Mara, **Ventilated Improved Pit Latrines: Recent Developments in Zimbabwe**, TAG Working Paper No. 2. (World Bank Washington, DC: 1982).

WORKING DRAWINGS

This Annex contains seven working drawings. Drawing ZBVIP/01 shows the general arrangement of the Blair brick VIP latrine, and drawings ZBVIP/02 and /03 show the pit lining and brick collar details and the cover slabs respectively. The superstructure alternatives (round and square spiral) are detailed on drawing ZBVIP/04 and the roof alternatives (thatch, and ferrocement for round and square spirals) on drawing ZBVIP/05. Vent pipe options are shown on drawing ZBVIP/06. The VIP latrine with soakaway is shown on drawing ZBVIP/07.

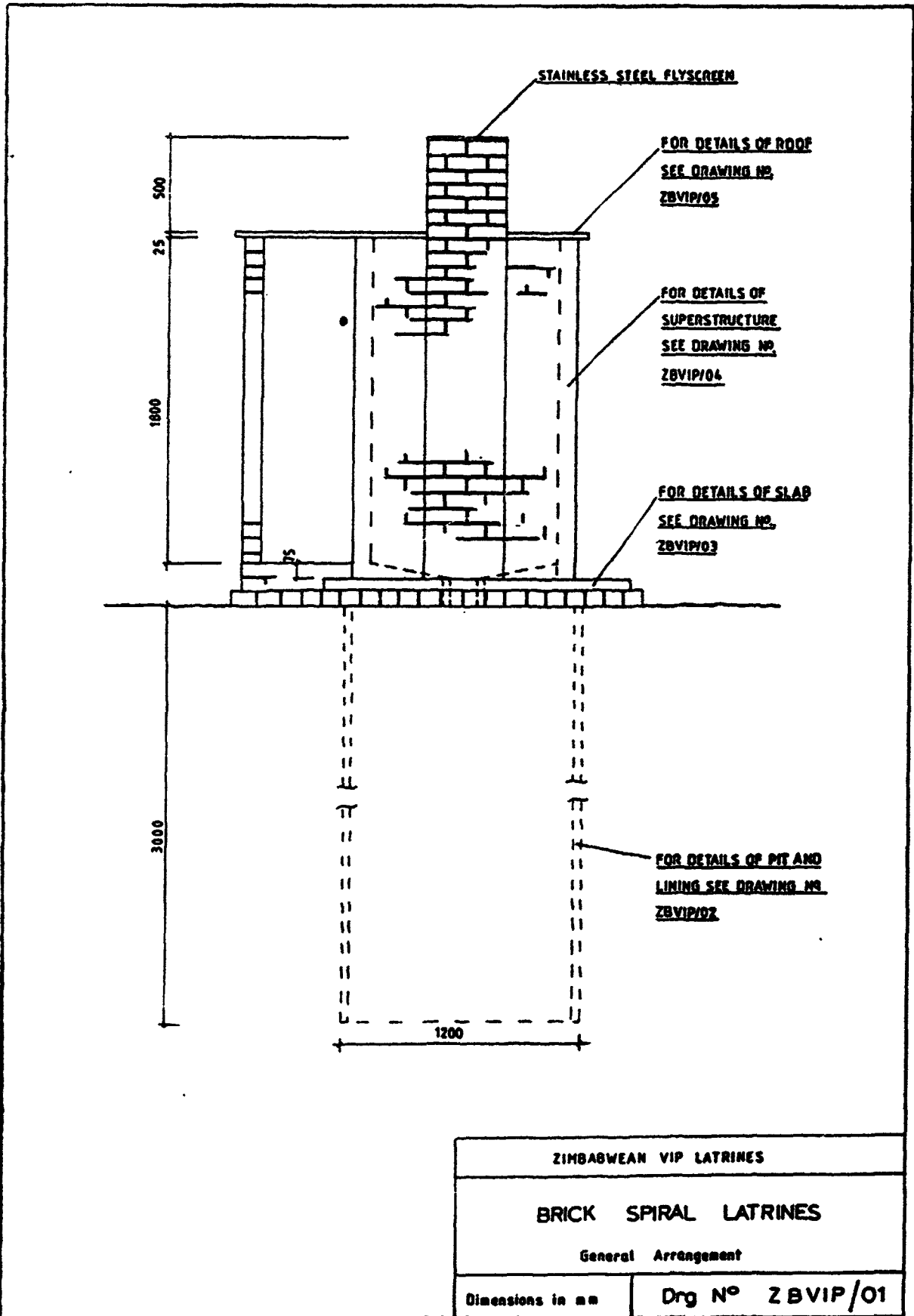

ZIMBABWEAN VIP LATRINES	
BRICK SPIRAL LATRINES	
General Arrangement	
Dimensions in mm	Drg N° ZBVIP/01

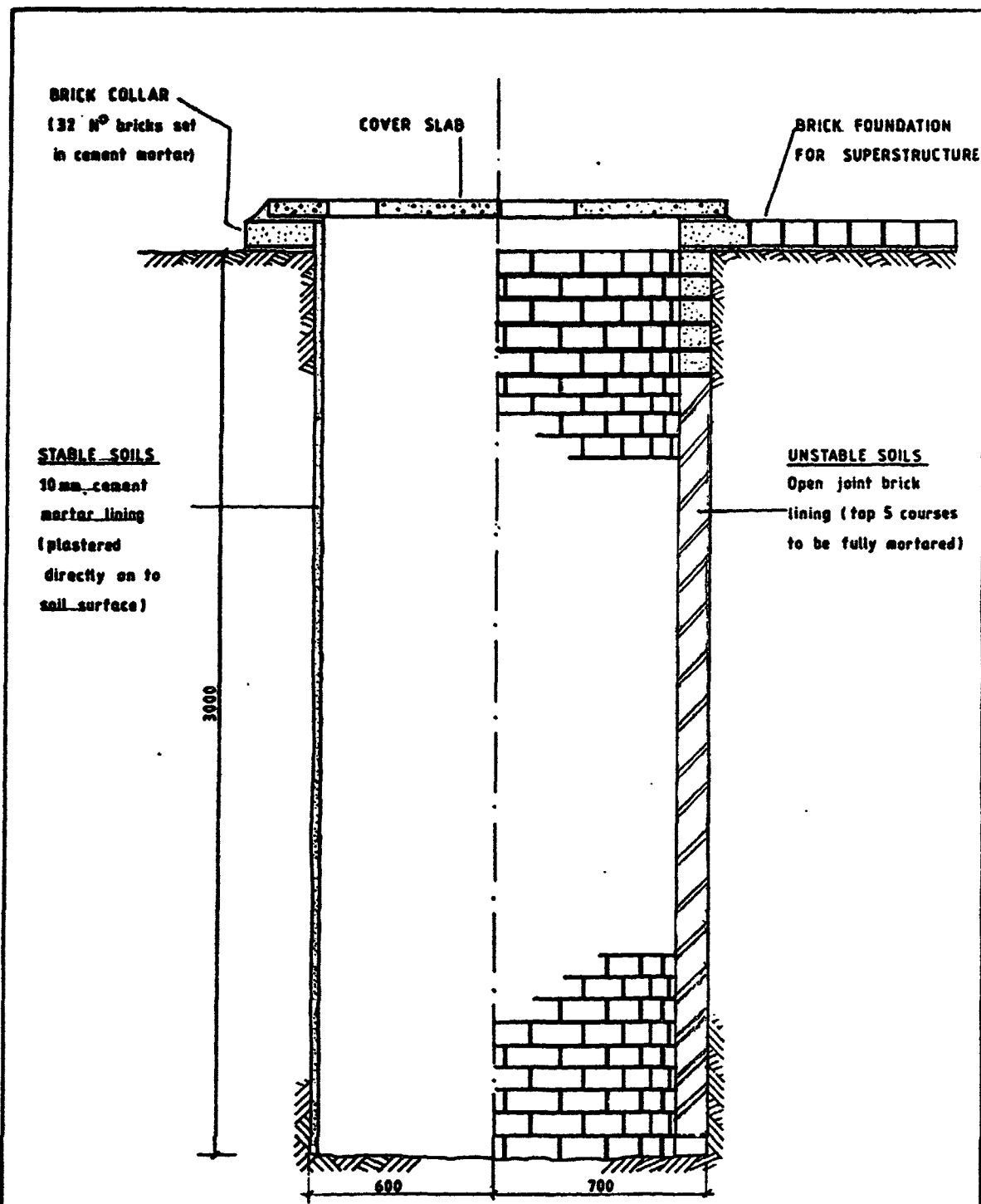

ZIMBABWEAN VIP LATRINES	
BRICK SPIRAL LATRINES	
Foundation and Pit Lining Details	
Dimensions in mm	Drg N° ZBVIP/02

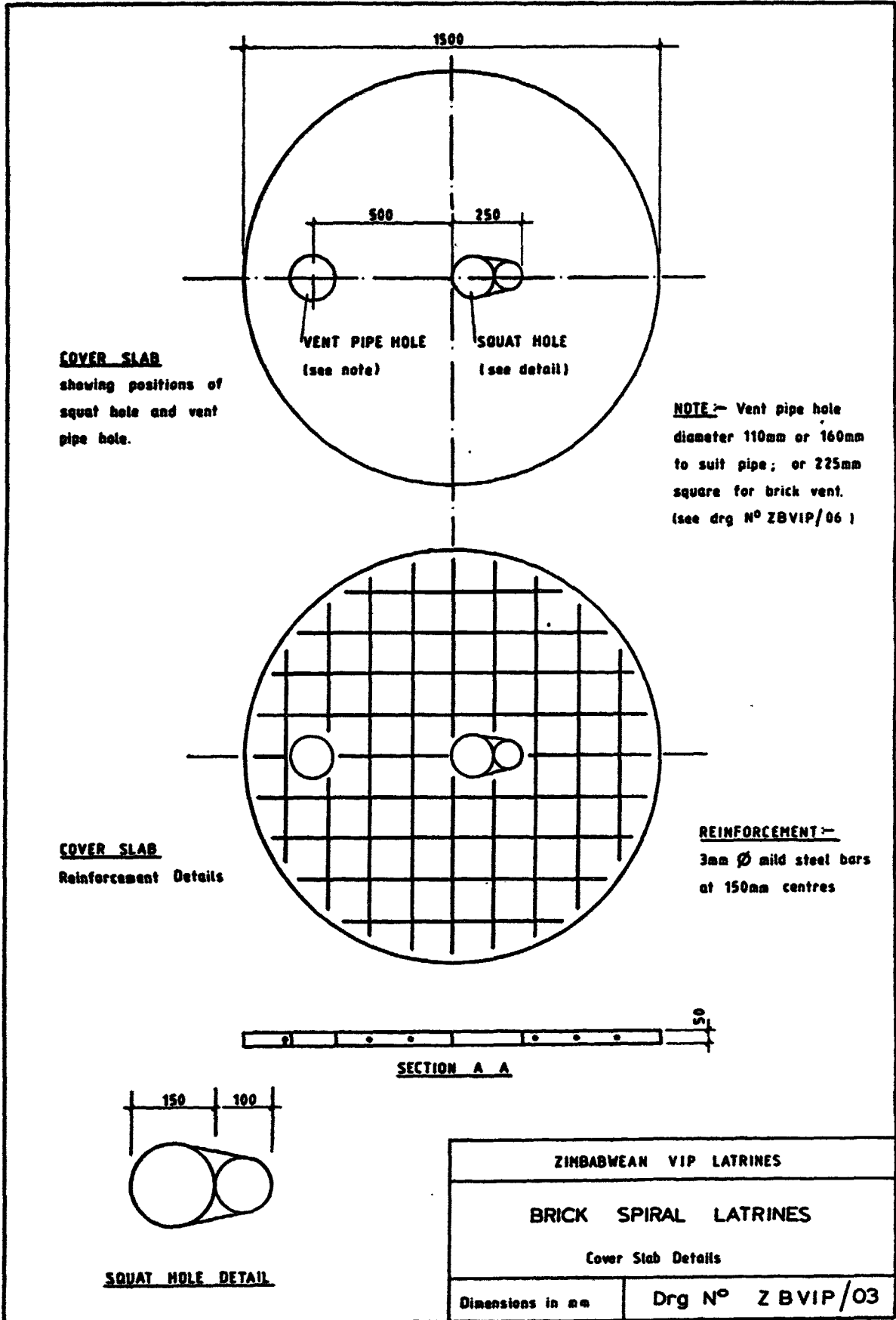

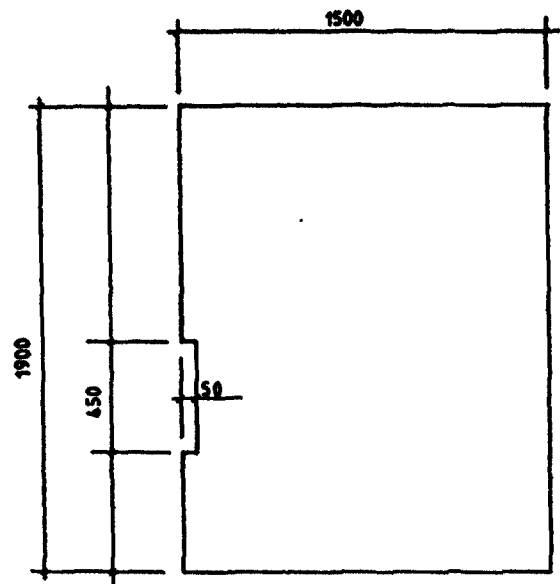

CONCRETE ROOF SLAB FOR "SQUARE" SPIRAL SUBSTRUCTURE WITH BRICK VENT PIPE

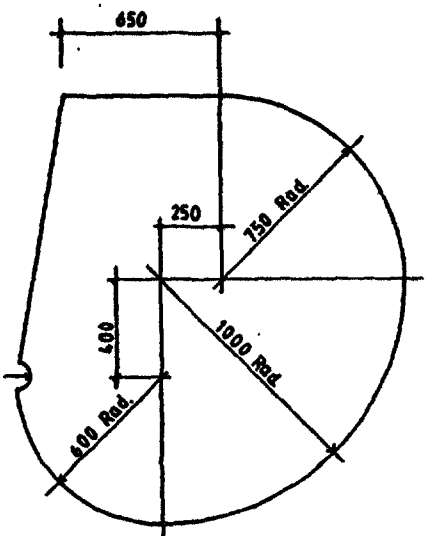

55mm. Red. FOR 110mm Dia. PVC VENT PIPE

CONCRETE ROOF SLAB FOR ROUND SPIRAL SUBSTRUCTURE

NOTE
CONCRETE ROOF SLABS
 (1) 25mm thick
 (2) 1 part cement: 5 parts river sand
 (3) Reinforced with one layer 30mm chicken wire mesh at mid-depth

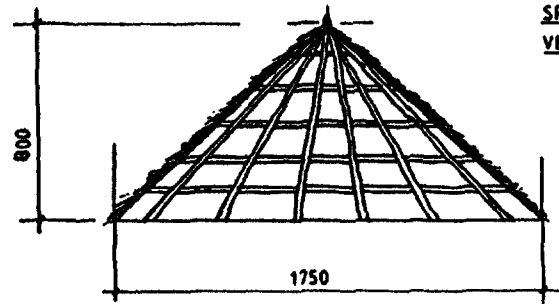

SECTION OF THATCH ROOF

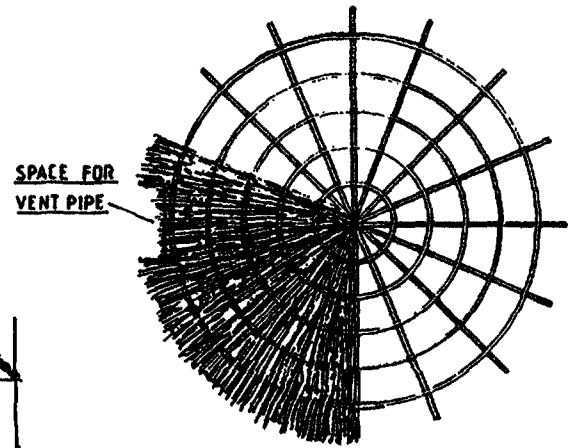

PLAN OF THATCH ROOF

ZIMBABWEAN VIP LATRINES	
BRICK SPIRAL LATRINES	
Details of reinforced concrete and thatch roofs.	
Dimensions in mm	Drg No ZBVIP/05

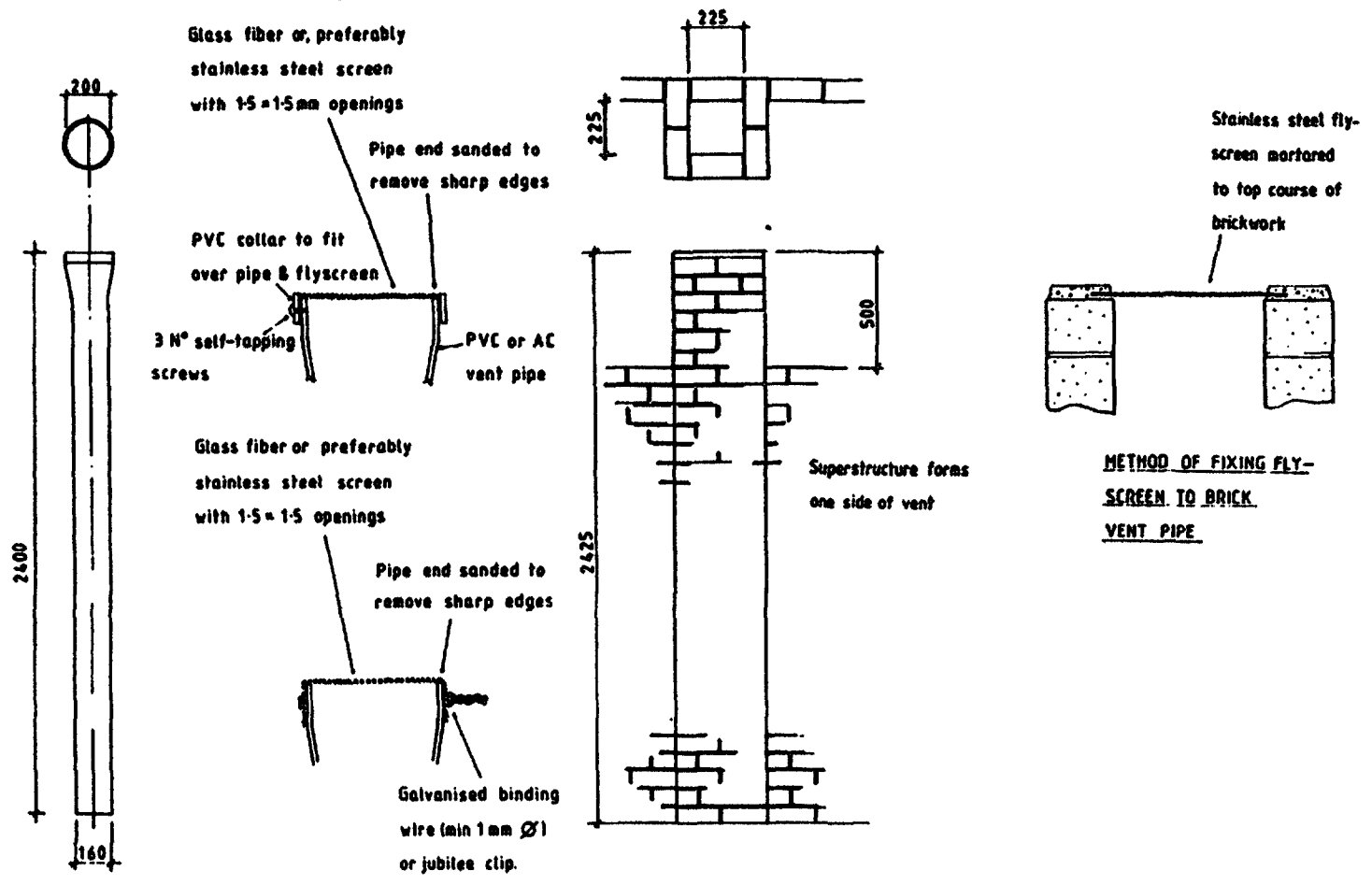

METHOD OF FIXING FLY-SCREEN TO BRICK VENT PIPE

PVC VENT PIPE

ALTERNATIVE METHODS FOR FIXING FLY SCREEN TO PVC VENT PIPE

BRICK VENT PIPE

ZIMBABWEAN VIP LATRINES	
BRICK SPIRAL LATRINES	
Vent Pipe Details — PVC and Brick	
Dimensions in mm	Drg N° ZBVIP/06

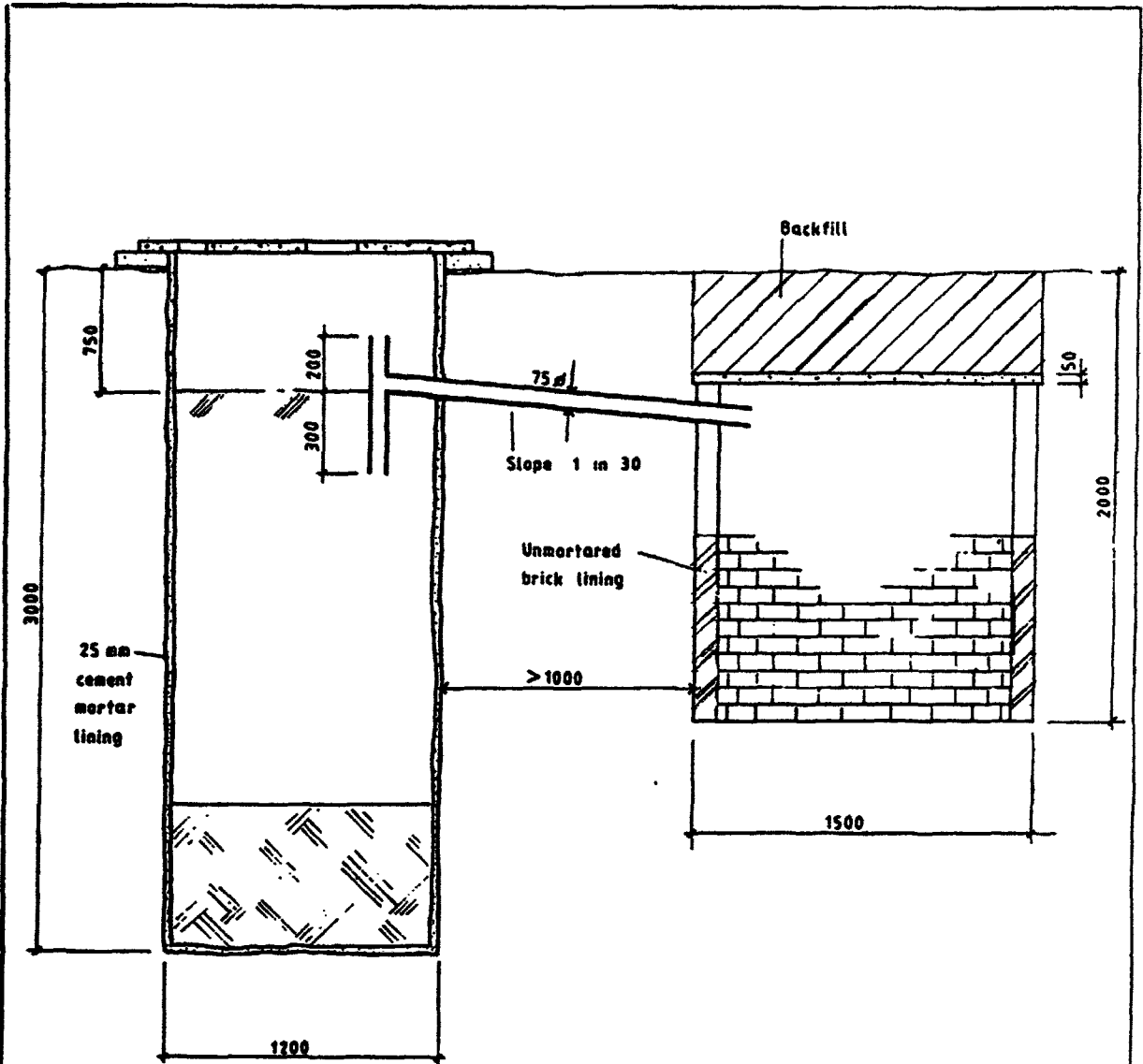

ZIMBABWEAN VIP LATRINES	
BRICK SPIRAL LATRINES	
Substructure Details for VIP Latrine with Soakaway	
Dimensions in mm	Drg N ^o ZBVIP/07

BILLS OF QUANTITIES

This Annex gives the materials and labor, and their September 1983 costs, for various types of Blair brick VIP latrines. Because of the large variation of latrine types, these items are listed under the following headings for both "rural" and "urban" latrines:

- (a) Substructure - stable soils
 - unstable soils
- (b) Coverslab
- (c) Superstructure - round spiral
 - square spiral
- (d) Latrine floor
- (e) Roof - thatch (rural only)
 - ferrocement (round spirals)
 - ferrocement (square spirals)
- (f) Vent pipe - PVC
 - asbestos cement
 - brick
- (g) Labor

Costs for "rural" latrines are given in Table II.1; those for "urban" latrines in Table II.2; and those for the versions with soakaways in Table II.3. From the information given in these tables it is possible to obtain total costs for any desired combination of latrine components. Table II.4 lists the total costs of some of the most common types of VIP latrines used in Zimbabwe.

In Tables II.1 through II.3, the substructure costs includes those for the brick collar and lining with cement mortar (stable soils) or in open-joint brickwork (unstable soils); and the superstructure costs include that for the brick foundation for that part of the superstructure not built on the coverslab. The principal differences between the rural latrine costs (Table II.1) and those for urban latrines (Table II.2) are the costs of bricks (Z\$20 per 1000) in rural areas, but Z\$90 per 1000 in urban areas) and of sand (free in rural areas, but Z\$9 per m³ in urban areas).

Table II.1: Costs of alternative components for "rural" brick VIP latrines
(in Z\$; Z\$1 = US\$0.95)

Item No.	Description	Unit	Rate	Quantity	Cost	Subtotal
A. SUBSTRUCTURE						
(i) Stable soils						
01	Cement	50 kg	5.00	1	5.00	
02	River sand	m ³	(free)	0.3	-	
03	Bricks	1000	20.00	30	0.60	5.60
(ii) Unstable soils						
04	Cement	50 kg	5.00	1.5	7.50	
05	River sand	m ³	(free)	0.5	-	
06	Bricks	1000	20.00	550	11.00	18.50
B. COVERSLAB						
07	Cement	50 kg	5.00	0.5	2.50	
08	River sand	m ³	(free)	0.125	-	
09	Reinforcing steel (3 mm dia.)	kg	0.50	1.5	0.75	3.25
C. SUPERSTRUCTURE						
(i) Round spiral						
10	Cement	50 kg	5.00	2.5	12.50	
11	River sand	m ³	(free)	0.7	-	
12	Bricks	1000	20.00	450	9.00	21.50
(ii) Square spiral						
13	Cement	50 kg	5.00	3	15.00	
14	River sand	m ³	(free)	1	-	
15	Bricks	1000	20.00	600	12.00	27.00

Table II.1 continued

Item No.	Description	Unit	Rate	Quantity	Cost	Subtotal
D. LATRINE FLOOR						
16	Cement	50 kg	5.00	0.5	2.50	
17	River sand	m ³	(free)	0.1	-	
18	Bituminous paint	liter	2.40	0.5	1.20	3.70
E. ROOF						
(i) Thatch						
19	Thatching grass			8 kg)	These items are normally available free in rural areas
20	Timber poles (65 mm dia.)			12 m)	
21	Twine			0.5 m)	
(ii) Ferrocement for round spiral						
22	Cement	50 kg	5.00	0.5	2.50	
23	River sand	m ³	(free)	0.1	-	
24	Chicken wire (40 mm; 1.8 m wide)	m	2.00	1.5	3.00	5.50
(iii) Ferrocement for square spiral						
25	Cement	50 kg	5.00	0.67	3.30	
26	River sand	m ³	(free)	0.1	-	
27	Chicken wire (as above)	m	2.00	1.5	3.00	6.30
F. VENT PIPE						
(i)	PVC vent pipe, 110 mm o.d. (with stainless steel flyscreen)					14.00
(ii)	PVC vent pipe, 160 mm o.d. (with stainless steel flyscreen)					27.00
(iii)	Asbestos cement vent pipe, 150 mm o.d. (with stainless steel flyscreen)					26.00

Table II.1 continued

Item No.	Description	Unit	Rate	Quantity	Cost	Subtotal
(iv) Brick vent pipe (230 x 230 mm internal dimensions)						
28	Cement	50 kg	5.00	0.25	1.25	
29	River sand	m ³	(free)	0.1	-	
30	Bricks	1000	20.00	120	2.40	
31	Flyscreen (stainless steel)	No.	4.00	1	4.00	9.65
G. LABOR						
32	Pit excavation	m depth	3.00	3	9.00	
33	Building latrine (skilled labor)	man day	5.00	3	15.00	
34	Building latrine (unskilled labor)	man day	3.00	3	9.00	33.00

Table II.2: Costs of alternative components for "urban" brick VIP latrines (in Z\$; Z\$1 = US\$0.95)

Item No.	Description	Unit	Rate	Quantity	Cost	Subtotal
A. SUBSTRUCTURE						
(i) Stable soils						
01	Cement	50 kg	4.50	1	4.50	
02	River sand	m ³	9.00	0.33	3.00	
03	Bricks	1000	90.00	30	2.70	10.20
(ii) Unstable soils						
04	Cement	50 kg	4.50	1.5	6.75	
05	River sand	m ³	9.00	0.5	4.50	
06	Bricks	1000	90.00	550	49.50	60.75
B. COVERSLAB						
07	Cement	50 kg	4.50	0.5	2.25	
08	River sand	m ³	9.00	0.125	1.15	
09	Reinforcing steel (3 mm dia.)	kg	0.50	1.5	0.75	4.15
C. SUPERSTRUCTURE						
(i) Round spiral						
10	Cement	50 kg	4.50	2.5	11.25	
11	River sand	m ³	9.00	0.67	6.00	
12	Bricks	1000	90.00	450	40.50	57.75
(ii) Square spiral						
13	Cement	50 kg	4.50	3	13.50	
14	River sand	m ³	9.00	1	9.00	
15	Bricks	1000	90.00	600	54.00	76.50

Table II.2 continued

Item No.	Description	Unit	Rate	Quantity	Cost	Subtotal
D. LATRINE FLOOR						
16	Cement	50 kg	4.50	0.5	2.25	
17	River sand	m ³	9.00	0.1	0.90	
18	Bituminous paint	liter	2.40	0.5	1.20	4.35
E. ROOF						
(i) Ferrocement for round spiral						
19	Cement	50 kg	4.50	0.5	2.25	
20	River sand	m ³	9.00	0.1	0.90	
21	Chicken wire (40 mm; 1.8 m wide)	m	2.00	1.5	3.00	6.15
(ii) Ferrocement for square spiral						
22	Cement	50 kg	4.50	0.67	3.00	
23	River sand	m ³	9.00	0.1	0.90	
24	Chicken wire (as above)	m	2.00	1.5	3.00	6.90
F. VENT PIPE						
(i) PVC vent pipe, 110 mm o.d. (with stainless steel flyscreen)						14.00
(ii) PVC vent pipe, 160 mm o.d. (with stainless steel flyscreen)						27.00
(iii) Asbestos cement vent pipe, 15 mm o.d. (with stainless steel flyscreen)						26.00
(iv) Brick vent pipe (230 x 230 mm internal dimensions)						
25	Cement	50 kg	4.50	0.25	1.12	
26	River sand	m	9.00	0.1	0.90	
27	Bricks	1000	90.00	120	10.80	
28	Flyscreen (stainless steel)	No.	4.00	1	4.00	16.82

Table II.2 continued

Item No.	Description	Unit	Rate	Quantity	Cost	Subtotal
G. LABOR						
29	Pit excavation	m depth	4.00	3	12.00	
30	Building latrine (skilled labor)	man day	10.00	3	30.00	
31	Building latrine (unskilled labor)	man day	5.00	3	15.00	57.00

Table II.3: Costs of alternative components for "urban" brick VIP latrines with soakaways (for up to 15 users) (in Z\$; 1 Z\$ = US\$ 0.95)

Item No.	Description	Unit	Rate	Quantity	Cost	Subtotal
A. SUBSTRUCTURE						
(i) Stable soils						
01	Cement	50 kg	4.50	3	13.50	
02	River sand	m ³	9.00	0.5	4.50	
03	Bricks 1000 90.00	30	2.70			
04	PVC pipe and Tee, 75 mm dia.	No.	12.00	1	12.00	32.70
(ii) Stable soils						
05	Cement 50 kg	4.50	3	13.50		
06	River sand	m ³	9.00	1	9.00	
07	Bricks 1000 90.00	550	49.50			
08	PVC pipe and Tee, 75 mm dia.	No.	12.00	1	12.00	84.00
Items B (Coverslab), C (Superstructure), D (Latrine floor), E (Roof), F (Vent pipe): as in Table II.2.						
G. SOAKAWAY (including coverslab)						
09	Cement 50 kg	4.50	0.5	2.25		
10	River sand	m ³	9.00	0.12	1.10	
11	Reinforcing steel,	kg	0.5	1.5	0.75	
12	Bricks	1000 90		182	16.38	
13	Gravel, 25 mm	m ³ 16		0.75	12.00	32.48

Table II.3 continued

Item No.	Description	Unit	Rate	Quantity	Cost	Subtotal
H. LABOR						
14	Excavation	m depth	6	4.00	24.00	
15	Building latrine (skilled labor)	man day	5	10.00	50.00	
16	Building latrine (unskilled labor)	man day	5	5.00	25.00	99.00

Table II.4: Total costs of common types of VIP latrines in rural and urban areas (in Z\$; Z\$1 = 0.95)

Latrine description	Cost components from Table II.1, II.2 or II.3 as appropriate	Total cost <u>a/</u>	Total annual cost per household <u>b/</u>
A. RURAL LATRINES			
(i) Round spiral VIP latrine - stable soil - thatch roof - brick vent pipe with stainless steel flyscreen - built by householder (ie, no labor costs <u>c/</u>)	A(i), B C(i), D, E(i), F(iv) plus 10% <u>d/</u>	48	8.4
(ii) Round spiral VIP latrine - unstable soil - otherwise as (i)	A(ii), B, C(i), D, E(i), F(iv) plus 10%	63	10.4
(iii) Square spiral VIP latrine - otherwise as (i)	A(i), B C(ii), D, E(i), F(iv) plus 10%	54	9.2
(iv) Square spiral VIP latrine - otherwise as (ii)	A(ii), B, C(ii), D, E(i), F(iv) plus 10%	69	11.2
B. URBAN LATRINES			
(v) Round spiral VIP latrine - stable soil - ferrocement roof - brick vent pipe - built by hired labor	A(i), B, C(i), D, E(i), F(iv), G plus 10%	172	25
(vi) Round spiral VIP latrine - unstable soil - otherwise as (v)	A(ii), B, C(i), D, E(i), F(iv), G plus 10%	228	33
(vii) Square spiral VIP latrine - otherwise as (v)	A(i), B, C(ii), D, E(ii), F(iv), G plus 10%	194	28
(viii) Square spiral VIP latrine - otherwise as (vi)	A(ii), B C(ii), D, E(ii), F(iv), G plus 10%	250	36

Table II.4 continued

	Cost components from Table II.1, II.2 or II.3 as appropriate	Total cost <u>a/</u>	Total annual cost per household <u>b/</u>
(ix) Square spiral VIP latrine <u>e/</u> - unstable soil - PVC vent pipe, 160 mm o.d. - otherwise as in (v)	A(ii), B, C(ii), D, E(ii), F(ii), G plus 10%	260	37
C. URBAN LATRINES WITH SOAKAWAYS			
(x) Round spiral VIP latrine - with soakaway - otherwise as (v)	A(i), B, C(i), D, E(i), F(iv), G, H plus 10%	290	41
(xi) Square spiral VIP latrine - with soakaway - otherwise as (ix)	A(ii), B, C(ii), D, E(ii), F(ii) G, H plus 10%	385	54

a/ Total costs are rounded up to nearest Z\$.

b/ Total costs discounted at 12 percent over 20 years, with an annual operation and maintenance cost of Z\$2.

c/ Labor costs would add an extra Z\$33 to each type of rural latrine and increase the annual cost by Z\$5.

d/ The addition of 10 percent is to allow for transport, contingencies etc.

e/ This type of latrine as it is the most urban expensive version without a soakaway.

**PHOTOGRAPHS OF A BRICK VIP LATRINE
DURING CONSTRUCTION**



Figure A. Marking out the pit.



Figure B. Excavating the pit.

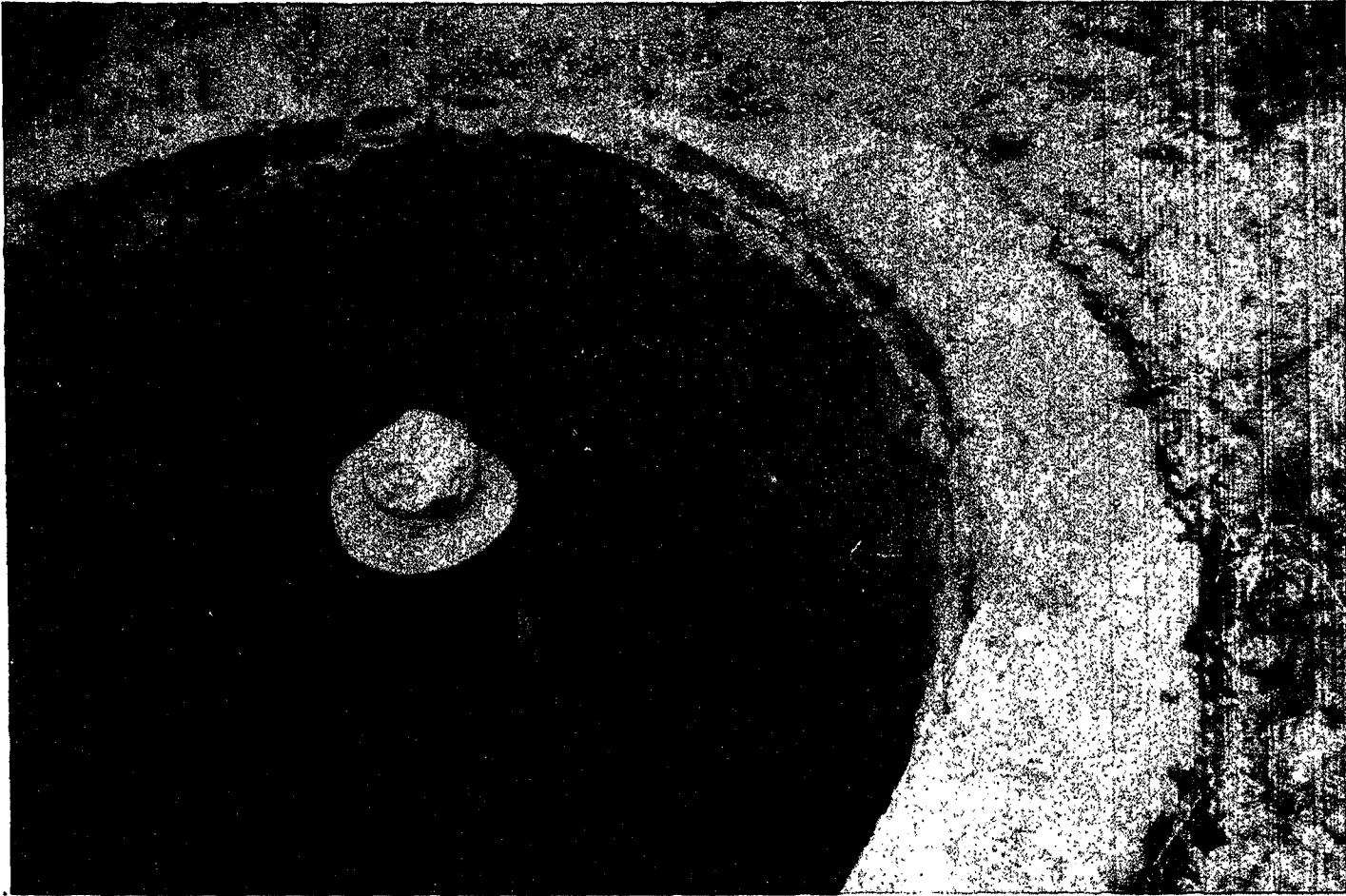

Figure C. Lining the pit wall with cement mortar.



Figure D. Laying the brick collar.

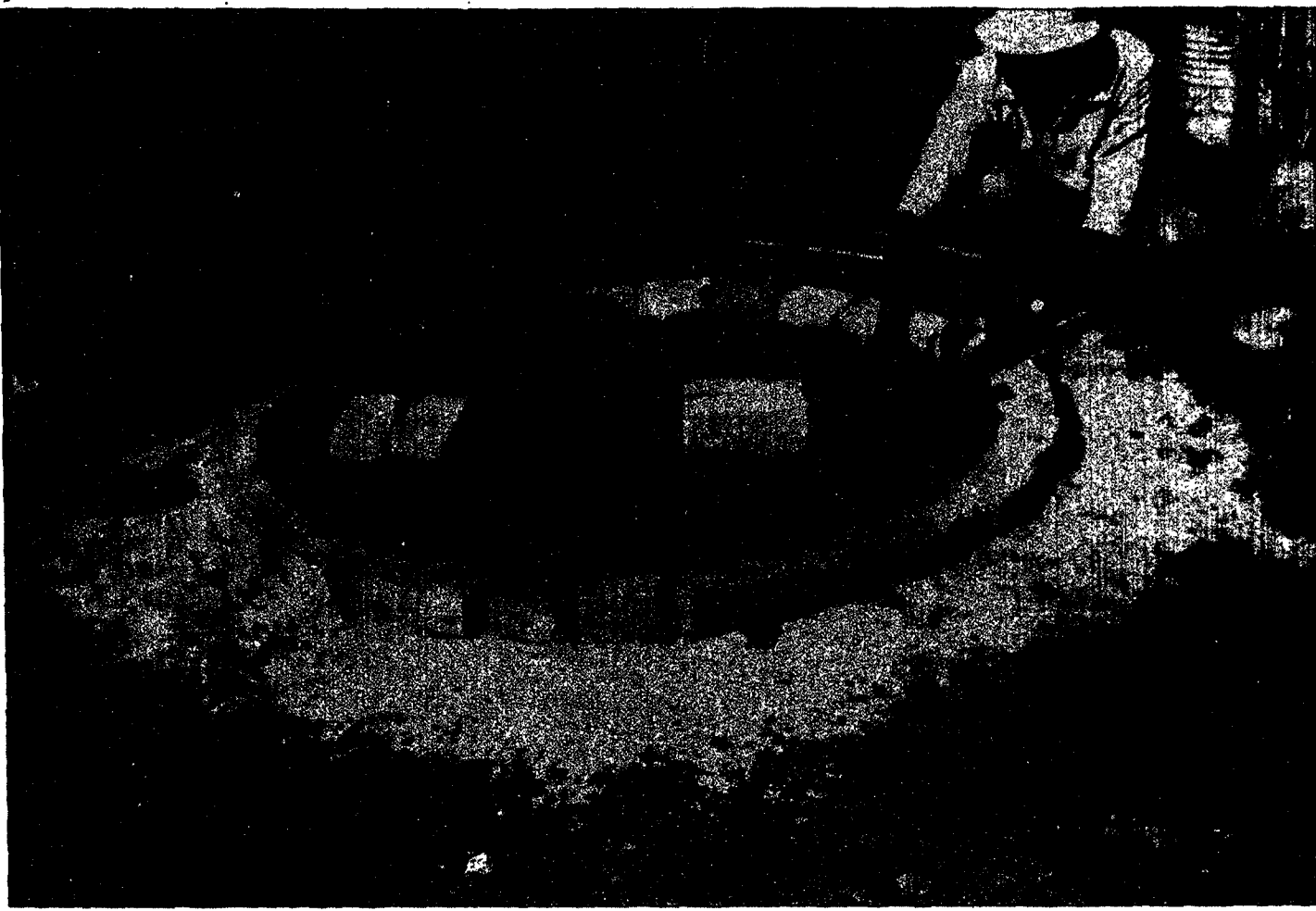

Figure E. Casting the reinforced concrete coverslab on site.



Figure F. Placing the coverslab on the brick collar.



Figure G. Laying the brick foundation for a round spiral superstructure.



Figure H. Building up the superstructure and vent pipe



Figure I. Placing a ferrocement roof in position.

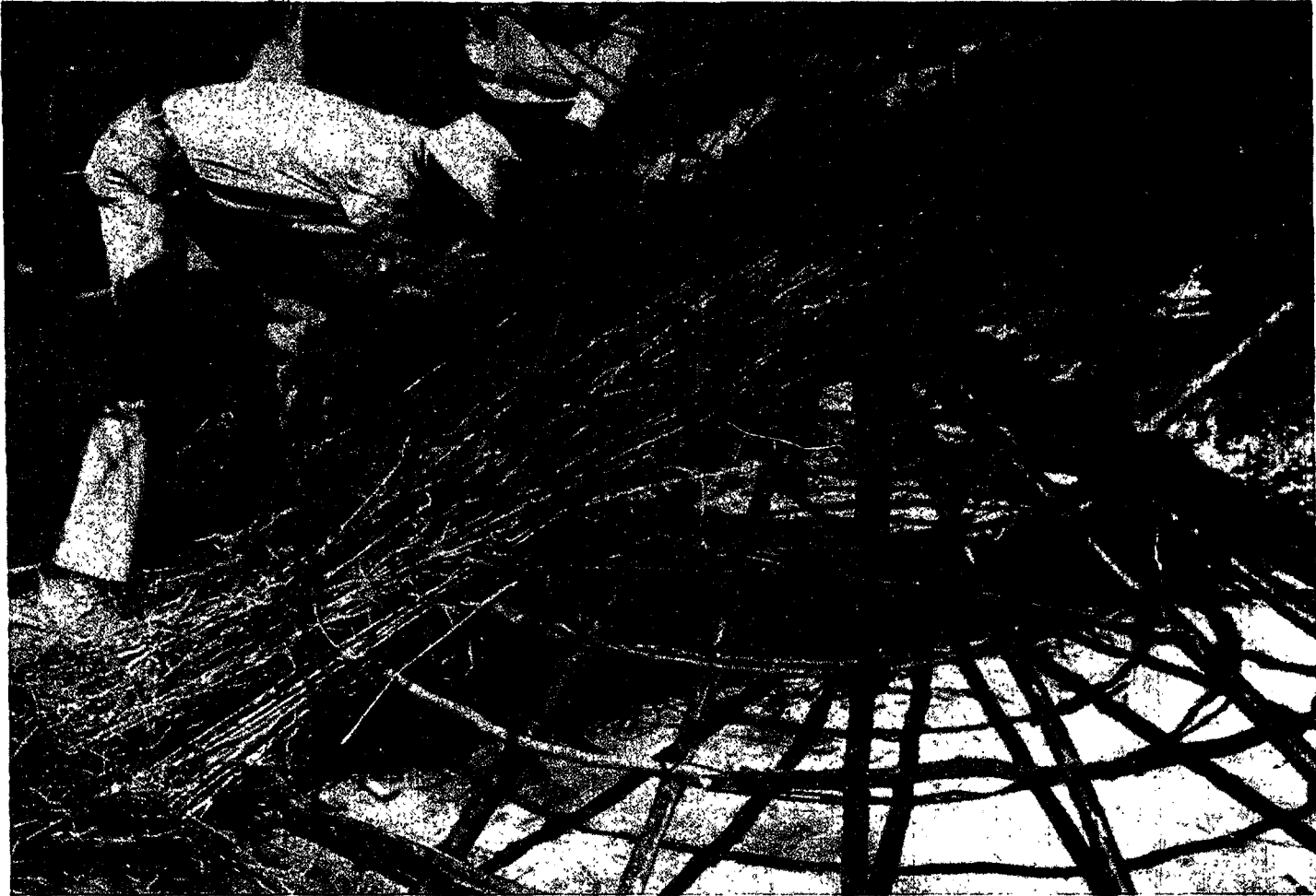

Figure J. Making a thatch roof.



Figure K. Lifting the thatch roof into position.



Figure L. "Dishing" the latrine floor (this procedure would normally be done after the superstructure walls had been completed).



Figure M. Flyscreen mortared to top course of brick vent pipe.

LIST OF PUBLICATIONS BY
THE TECHNOLOGY ADVISORY GROUP (TAG)
UNDP INTERREGIONAL PROJECT INT/81/047

- WP/01 A Model for the Development of a Self-help Water Supply Program;
by Colin Glennie.
- WP/02 Ventilated Improved Pit Latrines: Recent Developments in Zimbabwe;
by Peter Morgan and D. Duncan Mara.
- TN/01 Methods for Gathering Socio-Cultural Data for Water Supply and
Sanitation Projects; by Mayling Simpson-Hebert.
- TN/02 Planning of Communication Support (Information, Motivation and
Education) in Sanitation Projects and Programs; by Heli Perrett.
- TN/03 The Ventilated Improved Double-Pit Latrine: A Construction Manual
for Botswana; by John van Nostrand and James G. Wilson.
- TN/04 Pit Latrine Ventilation: Field Investigation Methodology;
by Beverley Ryan and D. Duncan Mara.
- TN/05 Social Feasibility Analysis of Low-cost Sanitation Projects;
by Heli Perrett.
- TN/06 Ventilated Improved Pit Latrines: Vent Pipe Design Guidelines;
by Beverley Ryan and D. Duncan Mara.
- TN/07 Community-based Workshops for Evaluating and Planning Sanitation
Programs: A Case Study of Primary Schools Sanitation
in Lesotho; by Piers Cross.
- TN/08 Rural Ventilated Improved Pit Latrines: A Field Manual for Botswana;
by John van Nostrand and James G. Wilson.
- TN/09 Handbook for District Sanitation Coordinators; by Keadire Basaako,
Ronald D. Parker, Robert B. Waller and James G. Wilson.
- TN/10 Manual on the Design, Construction and Maintenance of Low-cost
Pour-flush Waterseal Latrines in India; by A.K. Roy.
- TN/11 Monitoring and Evaluation of Communication Support Activities in
Low-cost Sanitation Projects; by Heli E. Perrett.
- TN/12 A Monitoring and Evaluation Manual for Low-cost Sanitation Programs
in India; by Ronald Parlato.
- TN/13 The Design of Ventilated Improved Pit Latrines; by D. Duncan Mara.