

Drainage Principles and Applications

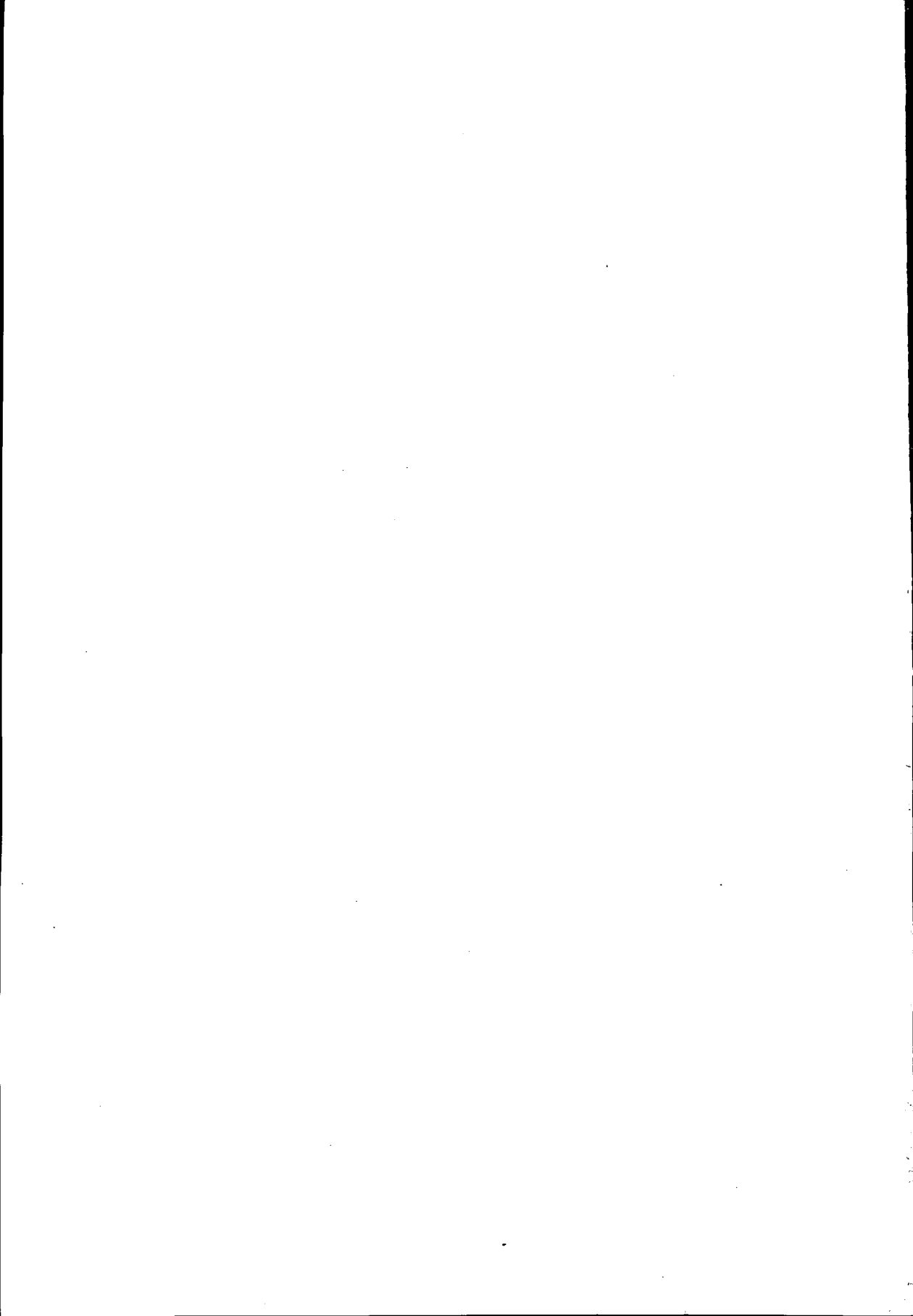



ILRI Publication 16
Second Edition (Completely Revised)

Drainage Principles and Applications

H.P. Ritzema (Editor-in-Chief)



International Institute for Land Reclamation and Improvement,
P.O. Box 45, 6700 AA Wageningen, The Netherlands, 1994

The first edition of this publication was issued in a four-volume series, with the first volume appearing in 1972 and the following three volumes appearing in 1973 and 1974. The second edition has now been completely revised and is published in one volume.

The aims of ILRI are:

- To collect information on land reclamation and improvement from all over the world;
- To disseminate this knowledge through publications, courses, and consultancies;
- To contribute – by supplementary research – towards a better understanding of the land and water problems in developing countries.

© International Institute for Land Reclamation and Improvement/ILRI,
Wageningen, The Netherlands.

This book or any part thereof may not be reproduced in any form without the written permission of ILRI.

ISBN 90 70754 3 39

Printed in The Netherlands

Preface

Thirty-three years ago, the first International Course on Land Drainage was held at ILRI in Wageningen. Since then, almost 1000 participants from more than 100 countries have attended the Course, which provides three months of post-graduate training for professionals engaged in drainage planning, design, and management, and in drainage-related research and training. In the years of its existence, the Course has proved to be the cornerstone of ILRI's efforts to contribute to the development of human resources.

From the beginning, notes of the Course lectures were given to the participants to lend support to the spoken word. Some twenty-five years ago, ILRI decided to publish a selection of these lecture notes to make them available to a wider audience. Accordingly, in 1972, the first volume appeared under the title *Drainage Principles and Applications*. The second, third, and fourth volumes followed in the next two years, forming, with Volume I, a set that comprises some 1200 pages. Since then, *Drainage Principles and Applications* has become one of ILRI's most popular publications, with sales to date of more than 8000 copies worldwide.

In this third edition of the book, the text has been completely revised to bring it up to date with current developments in drainage and drainage technology. The authors of the various chapters have used their lecture-room and field experience to adapt and restructure their material to reflect the changing circumstances in which drainage is practised all over the world. Remarks and suggestions from Course participants have been incorporated into the new material. New figures and a new lay-out have been used to improve the presentation. In addition, ILRI received a vast measure of cooperation from other Dutch organizations, which kindly made their research and field experts available to lecture in the Course alongside ILRI's own lecturers.

To bring more consistency into the discussions of the different aspects of drainage, the four volumes have been consolidated into one large work of twenty-six chapters. The book now includes 550 figures, 140 tables, a list of symbols, a glossary, and an index. It has new chapters on topical drainage issues (e.g. environmental aspects of drainage), drainage structures (e.g. gravity outlets), and the use of statistical analysis for drainage and drainage design. Current drainage practices are thoroughly reviewed, and an extensive bibliography is included. The emphasis of the whole lies upon providing clear explanations of the underlying principles of land drainage, which, wisely applied, will facilitate the type of land use desired by society. Computer applications in drainage, which are based on these principles, are treated at length in other ILRI publications.

The revision of this book was not an easy job. Besides the authors, a large number of ILRI's staff gave much of their time and energy to complete the necessary work. ILRI staff who contributed to the preparation of this third edition were:

Editorial Committee	R. van Aart M.G. Bos H.M.H. Braun K.J. Lenselink H.P. Ritzema
Members prior to 1993	J.G. van Alphen Th. M. Boers R. Kruijne N.A. de Ridder† G. Zijlstra
Language Editors	M.F.L. Roche M.M. Naeff
Drawings	J. van Dijk
Word Processing	J.B.H. van Dillen
Design and Layout	J. van Dijk J. van Manen

I want to thank everyone who was involved in the production of this book. It is my belief that their combined efforts will contribute to a better, more sustainable, use of the world's precious land and water resources.

Wageningen, June 1994

M.J.H.P. Pinkers
Director
International Institute for
Land Reclamation and Improvement/ILRI

Contents

Preface

1	Land Drainage: Why and How?	23
	<i>M.G. Bos and Th.M. Boers</i>	
1.1	The Need for Land Drainage	23
1.2	The History of Land Drainage	24
1.3	From the Art of Drainage to Engineering Science	26
1.4	Design Considerations for Land Drainage	27
	References	30
2	Groundwater Investigations	33
	<i>N.A. de Ridder</i>	
2.1	Introduction	33
2.2	Land Forms	33
2.2.1	Alluvial Plains	34
2.2.2	Coastal Plains	39
2.2.3	Lake Plains	40
2.2.4	Glacial Plains	41
2.3	Definitions	43
2.3.1	Basic Concepts	43
2.3.2	Physical Properties	46
2.4	Collection of Groundwater Data	47
2.4.1	Existing Wells	48
2.4.2	Observation Wells and Piezometers	48
2.4.3	Observation Network	52
2.4.4	Measuring Water Levels	54
2.4.5	Groundwater Quality	56
2.5	Processing the Groundwater Data	59
2.5.1	Groundwater Hydrographs	59
2.5.2	Groundwater Maps	61
2.6	Interpretation of Groundwater Data	65
2.6.1	Interpretation of Groundwater Hydrographs	65
2.6.2	Interpretation of Groundwater Maps	69
	References	74
3	Soil Conditions	77
	<i>H.M.H. Braun and R. Kruijne</i>	
3.1	Introduction	77
3.2	Soil Formation	77
3.2.1	Soil-Forming Factors	78
3.2.2	Soil-Forming Processes	80

3.3	Vertical and Horizontal Differentiation	81
3.3.1	Soil Horizons	81
3.3.2	The Soil Profile	82
3.3.3	Homogeneity and Heterogeneity	83
3.4	Soil Characteristics and Properties	85
3.4.1	Basic Soil Characteristics	85
3.4.2	Soil Properties	90
3.5	Soil Surveys	99
3.5.1	Soil Data Collection	100
3.5.2	Existing Soil Information	101
3.5.3	Information to be Collected	101
3.5.4	Soil Survey and Mapping	103
3.6	Soil Classification	104
3.6.1	Introduction	104
3.6.2	The FAO-UNESCO Classification System	105
3.6.3	The USDA/SCS Classification System	105
3.6.4	Discussion	106
3.6.5	Soil Classification and Drainage	106
3.7	Agricultural Use and Problem Soils for Drainage	107
3.7.1	Introduction	107
3.7.2	Discussion	109
	References	109
4	Estimating Peak Runoff Rates	111
	<i>J. Boonstra</i>	
4.1	Introduction	111
4.2	Rainfall Phenomena	111
4.2.1	Depth-Area Analysis of Rainfall	112
4.2.2	Frequency Analysis of Rainfall	115
4.3	Runoff Phenomena	116
4.3.1	Runoff Cycle	116
4.3.2	Runoff Hydrograph	118
4.3.3	Direct Runoff Hydrograph	120
4.4	The Curve Number Method	121
4.4.1	Derivation of Empirical Relationships	121
4.4.2	Factors Determining the Curve Number Value	124
4.4.3	Estimating the Curve Number Value	126
4.4.4	Estimating the Depth of the Direct Runoff	129
4.5	Estimating the Time Distribution of the Direct Runoff Rate	133
4.5.1	Unit Hydrograph Theory	133
4.5.2	Parametric Unit Hydrograph	136
4.5.3	Estimating Peak Runoff Rates	139
4.6	Summary of the Calculation Procedure	141
4.7	Concluding Remarks	142
	References	143

5	Evapotranspiration	145
	<i>R.A. Feddes and K.J. Lenselink</i>	
5.1	Introduction	145
5.2	Concepts and Developments	145
5.3	Measuring Evapotranspiration	147
5.3.1	The Soil Water Balance Method	147
5.3.2	Estimating Interception	148
5.3.3	Estimating the Evaporative Demand	150
5.4	Empirical Estimating Methods	151
5.4.1	Air-Temperature and Radiation Methods	151
5.4.2	Air-Temperature and Day-Length Method	152
5.5	Evaporation from Open Water: the Penman Method	152
5.6	Evapotranspiration from Cropped Surfaces	156
5.6.1	Wet Crops with Full Soil Cover	156
5.6.2	Dry Crops with Full Soil Cover : the Penman-Monteith Approach	157
5.6.3	Partial Soil Cover and Full Water Supply	161
5.6.4	Limited Soil-Water Supply	163
5.7	Estimating Potential Evapotranspiration	165
5.7.1	Reference Evapotranspiration and Crop Coefficients	165
5.7.2	Computing the Reference Evapotranspiration	167
	References	172
6	Frequency and Regression Analysis	175
	<i>R.J. Oosterbaan</i>	
6.1	Introduction	175
6.2	Frequency Analysis	175
6.2.1	Introduction	175
6.2.2	Frequency Analysis by Intervals	176
6.2.3	Frequency Analysis by Ranking of Data	181
6.2.4	Recurrence Predictions and Return Periods	181
6.2.5	Confidence Analysis	185
6.3	Frequency-Duration Analysis	187
6.3.1	Introduction	187
6.3.2	Duration Analysis	187
6.3.3	Depth-Duration-Frequency Relations	188
6.4	Theoretical Frequency Distributions	191
6.4.1	Introduction	191
6.4.2	Principles of Distribution Fitting	192
6.4.3	The Normal Distribution	193
6.4.4	The Gumbel Distribution	198
6.4.5	The Exponential Distribution	201
6.4.6	A Comparison of the Distributions	203
6.5	Regression Analysis	205
6.5.1	Introduction	205
6.5.2	The Ratio Method	206

6.5.3	Regression of y upon x	209
6.5.4	Linear Two-way Regression	214
6.5.5	Segmented Linear Regression	217
6.6	Screening of Time Series	220
6.6.1	Time Stability versus Time Trend	220
6.6.2	Periodicity of Time Series	222
6.6.3	Extrapolation of Time Series	222
6.6.4	Missing and Incorrect Data	223
	References	223
7	Basics of Groundwater Flow	225
	<i>M.G. Bos</i>	
7.1	Introduction	225
7.2	Groundwater and Watertable Defined	225
7.3	Physical Properties, Basic Laws	226
7.3.1	Mass Density of Water	226
7.3.2	Viscosity of Water	227
7.3.3	Law of Conservation of Mass	228
7.3.4	The Energy of Water	229
7.3.5	Fresh-Water Head of Saline Groundwater	231
7.4	Darcy's Equation	232
7.4.1	General Formulation	232
7.4.2	The K-Value in Darcy's Equation	234
7.4.3	Validity of Darcy's Equation	237
7.5	Some Applications of Darcy's Equation	238
7.5.1	Horizontal Flow through Layered Soil	238
7.5.2	Vertical Flow through Layered Soils	239
7.6	Streamlines and Equipotential Lines	240
7.6.1	Streamlines	240
7.6.2	Equipotential Lines	243
7.6.3	Flow-Net Diagrams	244
7.6.4	Refraction of Streamlines	246
7.6.5	The Laplace Equation	248
7.7	Boundary Conditions	249
7.7.1	Impervious Layers	249
7.7.2	Planes of Symmetry	249
7.7.3	Free Water Surface	250
7.7.4	Boundary Conditions for Water at Rest or for Slowly-Moving Water	251
7.7.5	Seepage Surface	251
7.8	The Dupuit-Forchheimer Theory	252
7.8.1	The Dupuit-Forchheimer Assumptions	252
7.8.2	Steady Flow above an Impervious Horizontal Boundary	255
7.8.3	Watertable subject to Recharge or Capillary Rise	256
7.8.4	Steady Flow towards a Well	257
7.9	The Relaxation Method	259
	References	261

8	Subsurface Flow to Drains	263
	<i>H.P. Ritzema</i>	
8.1	Introduction	263
8.2	Steady-State Equations	263
8.2.1	The Hooghoudt Equation	265
8.2.2	The Ernst Equation	272
8.2.3	Discussion of Steady-State Equations	275
8.2.4	Application of Steady-State Equations	277
8.3	Unsteady-State Equations	283
8.3.1	The Glover-Dumm Equation	284
8.3.2	The De Zeeuw-Hellinga Equation	287
8.3.3	Discussion of Unsteady-State Equations	288
8.3.4	Application of Unsteady-State Equations	288
8.4	Comparison between Steady-State and Unsteady-State Equations	292
8.5	Special Drainage Situations	294
8.5.1	Drainage of Sloping Lands	294
8.5.2	Open Drains with Different Water Levels and of Different Sizes	295
8.5.3	Interceptor Drainage	298
8.5.4	Drainage of Heavy Clay Soils	301
	References	303
9	Seepage and Groundwater Flow	305
	<i>N.A. de Ridder and G. Zijlstra</i>	
9.1	Introduction	305
9.2	Seepage from a River into a Semi-Confined Aquifer	305
9.3	Semi-Confined Aquifer with Two Different Watertables	311
9.4	Seepage through a Dam and under a Dike	312
9.4.1	Seepage through a Dam	312
9.4.2	Seepage under a Dike	313
9.5	Unsteady Seepage in an Unconfined Aquifer	316
9.5.1	After a Sudden Change in Canal Stage	317
9.5.2	After a Linear Change in Canal Stage	324
9.6	Periodic Water-Level Fluctuations	325
9.6.1	Harmonic Motion	325
9.6.2	Tidal Wave Transmission in Unconfined Aquifers	327
9.6.3	Tidal Wave Transmission in a Semi-Confined Aquifer	327
9.7	Seepage from Open Channels	332
9.7.1	Theoretical Models	332
9.7.2	Analog Solutions	334
9.7.3	Canals with a Resistance Layer at Their Perimeters	338
	References	339

10	Single-Well and Aquifer Tests	341
	<i>J. Boonstra and N.A. de Ridder</i>	
10.1	Introduction	341
10.2	Preparing for an Aquifer Test	341
10.2.1	Site Selection	341
10.2.2	Placement of the Pumped Well	342
10.2.3	Placement of Observation Wells	344
10.2.4	Arrangement and Number of Observation Wells	345
10.3	Performing an Aquifer Test	345
10.3.1	Time	346
10.3.2	Head	346
10.3.3	Discharge	347
10.3.4	Duration of the Test	348
10.4	Methods of Analysis	348
10.4.1	Time-Drawdown Analysis of Unconfined Aquifers	350
10.4.2	Time-Drawdown Analysis of Semi-Confined Aquifers	355
10.4.3	Time-Recovery Analysis	360
10.4.4	Distance-Drawdown Analysis of Unconfined Aquifers	365
10.4.5	Distance-Drawdown Analysis of Semi-Confined Aquifers	368
10.5	Concluding Remarks	371
10.5.1	Delayed-Yield Effect in Unconfined Aquifers	371
10.5.2	Partially-Penetrating Effect in Unconfined Aquifers	372
10.5.3	Deviations in Late-Time Drawdown Data	374
10.5.4	Conclusions	375
	References	375
11	Water in the Unsaturated Zone	383
	<i>P. Kabat and J. Beekma</i>	
11.1	Introduction	383
11.2	Measuring Soil-Water Content	383
11.3	Basic Concepts of Soil-Water Dynamics	389
11.3.1	Mechanical Concept	390
11.3.2	Energy Concept	391
11.3.3	Measuring Soil-Water Pressure Head	394
11.3.4	Soil-Water Retention	397
11.3.5	Drainable Porosity	402
11.4	Unsaturated Flow of Water	405
11.4.1	Basic Relationships	405
11.4.2	Steady-State Flow	408
11.4.3	Unsteady-State Flow	410
11.5	Unsaturated Hydraulic Conductivity	410
11.5.1	Direct Methods	412
11.5.2	Indirect Estimating Techniques	413
11.6	Water Extraction by Plant Roots	416
11.7	Preferential Flow	418
11.8	Simulation of Soil-Water Dynamics in Relation to Drainage	419

11.8.1	Simulation Models	420
11.8.2	Mathematical Models and Numerical Methods	420
11.8.3	Model Data Input	424
11.8.4	Examples of Simulations for Drainage	427
	References	432
12	Determining the Saturated Hydraulic Conductivity	435
	<i>R.J. Oosterbaan and H.J. Nijland</i>	
12.1	Introduction	435
12.2	Definitions	435
12.3	Variability of Hydraulic Conductivity	436
12.3.1	Introduction	436
12.3.2	Variability Within Soil Layers	437
12.3.3	Variability Between Soil Layers	439
12.3.4	Seasonal Variability and Time Trend	440
12.3.5	Soil Salinity, Sodicity, and Acidity	440
12.3.6	Geomorphology	441
12.4	Drainage Conditions and Hydraulic Conductivity	441
12.4.1	Introduction	441
12.4.2	Unconfined Aquifers	441
12.4.3	Semi-Confined Aquifers	444
12.4.4	Land Slope	447
12.4.5	Effective Soil Depth	448
12.5	Review of the Methods of Determination	450
12.5.1	Introduction	450
12.5.2	Correlation Methods	451
12.5.3	Hydraulic Laboratory Methods	453
12.5.4	Small-Scale In-Situ Methods	454
12.5.5	Large-Scale In-Situ Methods	456
12.6	Examples of Small-Scale In-Situ Methods	457
12.6.1	The Auger-Hole Method	457
12.6.2	Inversed Auger-Hole Method	461
12.7	Examples of Methods Using Parallel Drains	466
12.7.1	Introduction	466
12.7.2	Procedures of Analysis	467
12.7.3	Drains with Entrance Resistance, Deep Soil	470
12.7.4	Drains with Entrance Resistance, Shallow Soil	471
12.7.5	Ideal Drains, Medium Soil Depth	473
	References	475
13	Land Subsidence	477
	<i>R.J. de Glopper and H.P. Ritzema</i>	
13.1	Introduction	477
13.2	Subsidence in relation to Drainage	477
13.3	Compression and Consolidation	480
13.3.1	Intergranular Pressure	480

13.3.2	Terzaghi's Consolidation Theory	483
13.3.3	Application of the Consolidation Equations	486
13.4	Shrinkage of Newly Reclaimed Soils	489
13.4.1	The Soil-Ripening Process	490
13.4.2	An Empirical Method to Estimate Shrinkage	494
13.4.3	A Numerical Method to Calculate Shrinkage	500
13.5	Subsidence of Organic Soils	503
13.5.1	The Oxidation Process in Organic Soils	503
13.5.2	Empirical Methods for Organic Soils	504
13.6	Subsidence in relation to Drainage Design and Implementation	508
	References	510
14	Influences of Irrigation on Drainage	513
	<i>M.G. Bos and W. Wolters</i>	
14.1	Introduction	513
14.2	Where Water Leaves an Irrigation System	513
14.3	Salinity	519
14.4	Water Balances and Irrigation Efficiencies	521
14.4.1	Irrigation Efficiencies	521
14.4.2	Conveyance and Distribution Efficiency	524
14.4.3	Field Application Efficiency	526
14.5	Combined Irrigation and Drainage Systems	529
	References	530
15	Salinity Control	533
	<i>J.W. van Hoorn and J.G. van Alphen</i>	
15.1	Salinity in relation to Irrigation and Drainage	533
15.2	Soil Salinity and Sodicyty	533
15.2.1	Electrical Conductivity and Soil Water Extracts	533
15.2.2	Exchangeable Sodium	536
15.2.3	Effect of Sodium on Soil Physical Behaviour	537
15.2.4	Classification of Salt-Affected Soils	540
15.2.5	Crop Growth affected by Salinity and Sodicyty	542
15.3	Salt Balance of the Rootzone	544
15.3.1	Salt Equilibrium and Leaching Requirement	544
15.3.2	Salt Storage	548
15.3.3	The Salt Equilibrium and Storage Equations expressed in terms of Electrical Conductivity	549
15.3.4	Example of Calculation	550
15.3.5	Effect of Slightly Soluble Salts on the Salt Balance	556
15.4	Salinization due to Capillary Rise	558
15.4.1	Capillary Rise	558
15.4.2	Fallow Period without Seepage	561
15.4.3	Seepage or a Highly Saline Subsoil	562
15.4.4	Depth of Watertable	565

15.5	Leaching Process in the Rootzone	567
15.5.1	The Rootzone regarded as a Four-Layered Profile	567
15.5.2	The Leaching Efficiency Coefficient	569
15.5.3	The Leaching Efficiency Coefficient in a Four-Layered Profile	573
15.6	Long-Term Salinity Level and Percolation	575
15.7	Sodium Hazard of Irrigation Water	580
15.7.1	No Precipitation of Calcium Carbonate	580
15.7.2	Precipitation of Calcium Carbonate	580
15.7.3	Examples of Irrigation Waters containing Bicarbonate	583
15.7.4	Leaching Requirement and Classification of Sodic Waters	584
15.8	Reclamation of Salt-Affected Soils	588
15.8.1	General Considerations for Reclamation	588
15.8.2	Leaching Techniques	589
15.8.3	Leaching Equations	591
15.8.4	Chemical Amendments	598
	References	600
16	Analysis of Water Balances	601
	<i>N.A. de Ridder and J. Boonstra</i>	
16.1	Introduction	601
16.2	Equations for Water Balances	601
16.2.1	Components of Water Balances	602
16.2.2	Water Balance of the Unsaturated Zone	604
16.2.3	Water Balance at the Land Surface	607
16.2.4	Groundwater Balance	609
16.2.5	Integrated Water Balances	610
16.2.6	Practical Applications	612
16.2.7	Equations for Water and Salt Balances	617
16.3	Numerical Groundwater Models	620
16.3.1	General	620
16.3.2	Types of Models	621
16.4	Examples of Water Balance Analysis	622
16.4.1	Processing and Interpretation of Basic Data	623
16.4.2	Water Balance Analysis With Flow Nets	624
16.4.3	Water Balance Analysis With Models	629
16.5	Final Remarks	631
	References	633
17	Agricultural Drainage Criteria	635
	<i>R.J. Oosterbaan</i>	
17.1	Introduction	635
17.2	Types and Applications of Agricultural Drainage Systems	635
17.2.1	Definitions	635
17.2.2	Classification	637
17.2.3	Applications	639

17.3	Analysis of Agricultural Drainage Systems	640
17.3.1	Objectives and Effects	640
17.3.2	Agricultural Criterion Factors and Object Functions	641
17.3.3	Watertable Indices for Drainage Design	644
17.3.4	Steady-State Versus Unsteady-State Drainage Equations	649
17.3.5	Critical Duration, Storage Capacity, and Design Discharge	651
17.3.6	Irrigation, Soil Salinity, and Subsurface Drainage	652
17.3.7	Summary: Formulation of Agricultural Drainage Criteria	656
17.4	Effects of Field Drainage Systems on Agriculture	657
17.4.1	Field Drainage Systems and Crop Production	657
17.4.2	Watertable and Crop Production	659
17.4.3	Watertable and Soil Conditions	663
17.4.4	Summary	669
17.5	Examples of Agricultural Drainage Criteria	670
17.5.1	Rain-Fed Lands in a Temperate Humid Zone	670
17.5.2	Irrigated Lands in Arid and Semi-Arid Regions	673
17.5.3	Irrigated Lands in Sub-Humid Zones	680
17.5.4	Rain-Fed Lands in Tropical Humid Zones	682
	References	687
18	Procedures in Drainage Surveys	691
	<i>R. van Aart and J.G. van Alphen</i>	
18.1	Introduction	691
18.2	The Reconnaissance Study	692
18.2.1	Basic Data Collection	694
18.2.2	Defining the Land-Drainage Problem	698
18.2.3	Examples	701
18.2.4	Institutional and Economic Aspects	705
18.3	The Feasibility Study	705
18.3.1	Topography	706
18.3.2	Drainage Criteria	706
18.3.3	The Observation Network and the Mapping Procedure	708
18.3.4	The Hydraulic Conductivity Map	714
18.3.5	The Contour Map of the Impervious Base Layer	715
18.3.6	Field-Drainage System in Sub-Areas	715
18.3.7	Climatological and Other Hydrological Data	716
18.3.8	Institutional and Economic Aspects	719
18.4	The Post-Authorization Study	720
18.5	Implementation and Operation of Drainage Systems	722
18.5.1	Execution of Drainage Works	722
18.5.2	Operation and Maintenance of Drainage Systems	722
18.5.3	Monitoring and Evaluating Performance	723
	References	724

19	Drainage Canals and Related Structures	725
	<i>M.G. Bos</i>	
19.1	Introduction	725
19.2	General Aspects of Lay-Out	725
19.2.1	Sloping Lands	726
19.2.2	The Agricultural Area	727
19.2.3	Drainage Outlet	729
19.2.4	Locating the Canal	731
19.2.5	Schematic Map of Canal Systems	732
19.3	Design Criteria	735
19.3.1	Design Water Levels	735
19.3.2	Design Discharge Capacity	736
19.3.3	Influence of Storage on the Discharge Capacity	739
19.3.4	Suitability of Soil Material in Designing Canals	740
19.3.5	Depth of the Canal Versus Width	745
19.3.6	Canal Curvature	749
19.3.7	Canal Profiles	750
19.4	Uniform Flow Calculations	751
19.4.1	State and Type of Flow	751
19.4.2	Manning's Equation	755
19.4.3	Manning's Resistance Coefficient	756
19.4.4	Influence of Maintenance on the n Value	762
19.4.5	Channels with Compound Sections	763
19.5	Maximum Permissible Velocities	764
19.5.1	Introduction	764
19.5.2	The Sediment Transport Approach	765
19.5.3	The Allowable Velocity Approach	768
19.6	Protection Against Scouring	773
19.6.1	Field of Application	773
19.6.2	Determining Stone Size of Protective Lining	773
19.6.3	Filter Material Placed Beneath Rip-Rap	776
19.6.4	Fitting of Sieve Curves	777
19.6.5	Filter Construction	779
19.7	Energy Dissipators	780
19.7.1	Introduction	780
19.7.2	Straight Drop	784
19.7.3	Baffle Block Type Basin	786
19.7.4	Inclined Drop	786
19.7.5	USBR Type III Basin	787
19.8	Culverts	790
19.8.1	General	790
19.8.2	Energy Losses	791
	References	796

22.4.3	Partial Penetration	942
22.4.4	Semi-Confined Aquifers	944
22.5	Design Procedure	944
22.5.1	Design Considerations	944
22.5.2	Well-Field Design	947
22.5.3	Well Design	950
22.5.4	Design Optimization	958
22.6	Maintenance	960
22.6.1	Borehole	960
22.6.2	Pump and Engine	962
	References	963
23	Pumps and Pumping Stations	965
	<i>J. Wijdieks and M.G. Bos</i>	
23.1	General	965
23.2	Pump Types	966
23.2.1	Archimedean Screw	966
23.2.2	Impeller Pumps	970
23.3	Affinity Laws of Impeller Pumps	976
23.4	Cavitation	978
23.4.1	Description and Occurrence	978
23.4.2	Net Positive Suction Head (NPSH)	980
23.5	Fitting the Pump to the System	982
23.5.1	Energy Losses in the System	982
23.5.2	Fitting the System Losses to the Pump Characteristics	984
23.5.3	Post-Adjustment of Pump and System	984
23.6	Determining the Dimensions of the Pumping Station	986
23.6.1	General Design Rules	986
23.6.2	Sump Dimensions	986
23.6.3	Parallel Pumping	987
23.6.4	Pump Selection and Sump Design	990
23.6.5	Power to Drive a Pump	993
23.6.6	Trash Rack	996
23.6.7	The Location of a Pumping Station	997
	References	998
24	Gravity Outlet Structures	1001
	<i>W.S. de Vries and E.J. Huyskens</i>	
24.1	Introduction	1001
24.2	Boundary Conditions	1001
24.2.1	Problem Description	1001
24.2.2	Outer Water Levels	1003
24.2.3	Salt Intrusion	1015
24.2.4	Inner Water Levels	1019
24.3	Design of Gravity Outlet Structures	1020
24.3.1	Types of Gravity Outlet Structures	1020

24.3.2	Location of Outlet Structures	1027
24.3.3	Discharge Capacities of Tidal Drainage Outlets	1027
24.3.4	Design, Construction, Operation, and Maintenance	1037
24.3.5	Other Aspects	1039
	References	1040
25	Environmental Aspects of Drainage	1041
	<i>H.P. Ritzema and H.M.H. Braun</i>	
25.1	Introduction	1041
25.2	Objectives of Drainage	1041
25.3	Environmental Impacts	1042
25.4	Side-Effects Inside the Project Area	1044
25.4.1	Loss of Wetland	1044
25.4.2	Change of the Habitat	1045
25.4.3	Lower Watertable	1046
25.4.4	Subsidence	1046
25.4.5	Salinization	1048
25.4.6	Acidification	1048
25.4.7	Seepage	1049
25.4.8	Erosion	1050
25.4.9	Leaching of Nutrients, Pesticides, and Other Elements	1050
25.4.10	Health	1051
25.5	Downstream Side-Effects	1053
25.5.1	Disposal of Drainage Effluent	1053
25.5.2	Disposal Options	1055
25.5.3	Excess Surface Water	1059
25.5.4	Seepage from Drainage Canals	1059
25.6	Upstream Side-Effects	1060
25.7	Environmental Impact Assessment	1060
	References	1063
26	Land Drainage : Bibliography and Information Retrieval	1067
	<i>G. Naber</i>	
26.1	Introduction	1067
26.2	Scientific Information	1067
26.2.1	Structure	1067
26.2.2	Regulatory Mechanisms that Control the Flow of Literature	1067
26.3	A Land Drainage Engineer as a User of Information	1068
26.3.1	The Dissemination of Information	1069
26.3.2	Retrieval of Information	1070
26.3.3	Document Delivery	1071
26.4	Information Sources on Land Drainage	1072
26.4.1	Tertiary Literature	1072
26.4.2	Abstract Journals	1072
26.4.3	Databases	1072
26.4.4	Hosts or Information Suppliers	1073

26.4.5	Journals	1073
26.4.6	Newsletters	1075
26.4.7	Books	1075
26.4.8	Institutions	1084
26.4.9	Drainage Bibliographies	1086
26.4.10	Multilingual Dictionaries	1086
26.4.11	Proceedings of International Drainage Symposia	1087
26.4.12	Equipment Suppliers	1088
26.4.13	Teaching and Training Facilities	1088
	List of Addresses	1089
	List of Abbreviations	1090
	List of Principal Symbols and Units	1091
	Glossary	1095
	Index	1107

1 Land Drainage: Why and How?

M.G.Bos¹ and Th.M.Boers¹

1.1 The Need for Land Drainage

The current world population is roughly estimated at 5000 million, half of whom live in developing countries. The average annual growth rate in the world population approximates 2.6%. To produce food and fibre for this growing population, the productivity of the currently cultivated area must be increased and more land must be cultivated.

Land drainage, or the combination of irrigation and land drainage, is one of the most important input factors to maintain or to improve yields per unit of farmed land. Figure 1.1 illustrates the impact of irrigation water management and the control of the watertable.

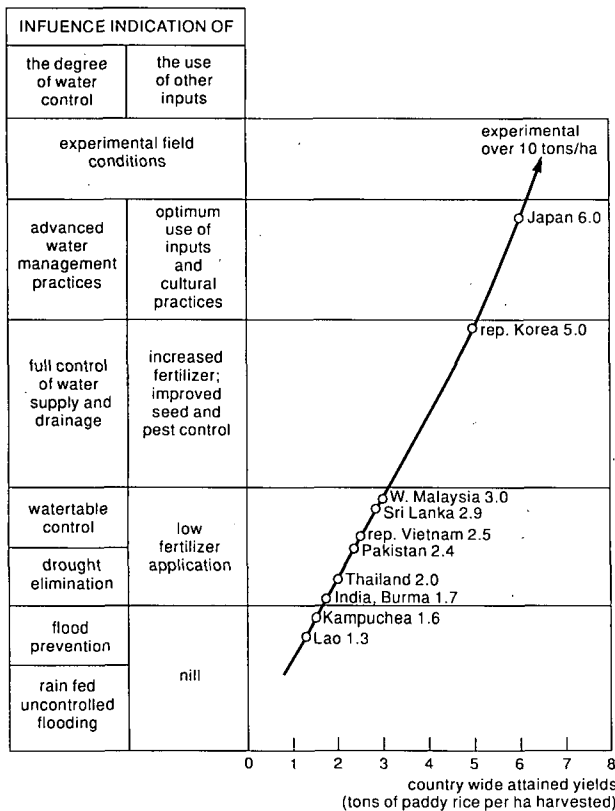

Figure 1.1 Influence of water control, improved management, and additional inputs on yields of paddy rice (FAO 1979)

¹ International Institute for Land Reclamation and Improvement

To enlarge the currently cultivated area, more land must be reclaimed than the land that is lost (e.g. to urban development, roads, and land degradation). In some areas, however, land is a limiting resource. In other areas, agriculture cannot expand at the cost of nature.

Land drainage, as a tool to manage groundwater levels, plays an important role in maintaining and improving crop yields:

- It prevents a decrease in the productivity of arable land due to rising watertables and the accumulation of salts in the rootzone;
- A large portion of the land that is currently not being cultivated has problems of waterlogging and salinity. Drainage is the only way to reclaim such land.

The definition of land drainage, as given in the constitution of the International Commission on Irrigation and Drainage/ICID (1979), reads:

‘Land drainage is the removal of excess surface and subsurface water from the land to enhance crop growth, including the removal of soluble salts from the soil.’

In this publication, we shall adopt the ICID definition because it is generally known and is applicable all over the world. Drainage of agricultural land, as indicated above, is an effective method to maintain a sustainable agricultural system.

1.2 The History of Land Drainage

Records from the old Indus civilizations (i.e. the Mohenjo-Daro and the Harappa) show that around 2500 B.C. the Indus Valley was farmed. Using rainfall and floodwater, the farmers there cultivated wheat, sesame, dates, and cotton. Surplus agricultural produce was traded for commodities imported from neighbouring countries. Irrigation and drainage, occurring as natural processes, were in equilibrium: when the Indus was in high stage, a narrow strip of land along the river was flooded; at low stage, the excess water was drained (Snelgrove 1967).

The situation as sketched for the Indus Valley also existed in other inhabited valleys, but a growing population brought the need for more food and fibre. Man increased his agricultural area by constructing irrigation systems: in Mesopotamia c. 3000 B.C. (Jacobsen and Adams 1958), in China from 2627 B.C. (King 1911, as quoted by Thorne and Peterson 1949), in Egypt c. 3000 B.C. (Gulhati and Smith 1967), and, around the beginning of our era, in North America, Japan, and Peru (Kaneko 1975; Gulhati and Smith 1967).

Although salinity problems may have contributed to the decline of old civilizations (Maierhofer 1962), there is evidence that, in irrigated agriculture, the importance of land drainage and salinity control was understood very early. In Mesopotamia, control of the watertable was based on avoiding an inefficient use of irrigation water and on the cropping practice of weed-fallow in alternate years. The deep-rooted crops *shoq* and *agul* created a deep dry zone which prevented the rise of salts through capillary action (Jacobsen and Adams 1958). During the period from 1122 B.C. to

220 A.D., saline-alkali soils in the North China Plain and in the Wei-Ho Plain were ameliorated with the use of a good irrigation and drainage system, by leaching, by rice planting, and by silting from periodic floods (Wen and Lin 1964).

The oldest known polders and related structures were described by Homer in his *Iliad*. They were found in the Periegesis of Pausanias (Greece). His account is as follows (see Knauss 1991 for details):

‘In my account of Orchomenos, I explained how the straight road runs at first besides the gully, and afterwards to the left of the flood water. On the plain of the Kaphyai has been made a dyke of earth, which prevents the water from the Orchomenian territory from doing harm to the tilled land of Kaphyai. Inside the dyke flows along another stream, in size big enough to be called a river, and descending into a chasm of the earth it rises again ... (at a place outside the polder).’

In the second century B.C., the Roman Cato referred to the need to remove water from wet fields (Weaver 1964), and there is detailed evidence that during the Roman civilization subsurface drainage was also known. Lucius Inunius Moderatus Columella, who lived in Rome in the first century, wrote twelve books entitled: *De Re Rustica* in which he described how land should be made suitable for agriculture (Vučić 1979) as follows:

‘A swampy soil must first of all be made free of excess water by means of a drain, which may be open or closed. In compact soils, ditches are used; in lighter soils, ditches or closed drains which discharge into ditches. Ditches must have a side slope, otherwise the walls will collapse. A closed drain is made of a ditch, excavated to a depth of three feet, which is filled to a maximum of half this depth with stones or gravel, clean from soil. The ditch is closed by backfilling with soil to the surface. If these materials are not available, bushes may be used, covered with leaves from cypress or pine trees. The outlet of a closed drain into a ditch is made of a large stone on top of two other stones.’

During the Middle Ages, in the countries around the North Sea, people began to reclaim swamps and lacustrine and maritime lowlands by draining the water through a system of ditches. Land reclamation by gravity drainage was also practised in the Far East, for instance in Japan (Kaneko 1975). The use of the windmill to pump water made it possible to turn deeper lakes into polders, for example the 7000-ha Beemster Polder in The Netherlands in 1612 (Leeghwater 1641). The word polder, which originates from the Dutch language, is used internationally to indicate ‘a low-lying area surrounded by a dike, in which the water level can be controlled independently of the outside water’.

During the 16th, 17th, and 18th centuries, drainage techniques spread over Europe, including Russia (Nosenko and Zonn 1976), and to the U.S.A. (Wooten and Jones 1955). The invention of the steam engine early in the 19th century brought a considerable increase in pumping capacity, enabling the reclamation of larger lakes such as the 15 000-ha Haarlemmermeer, southwest of Amsterdam, in 1852.

In the 17th century, the removal of excess water by closed drains, essentially the same as described above by Columella, was introduced in England. In 1810, clay tiles started to be used, and after 1830 concrete pipes made with portland cement (Donnan 1976). The production of drain pipes was first mechanized in England and, from there, it spread over Europe and to the U.S.A. in the mid-19th century (Nosenko and Zonn 1976). Excavating and trenching machines, driven by steam engines, made their advent in 1890, followed in 1906 by the dragline in the U.S.A. (Ogrosky and Mockus 1964).

The invention of the fuel engine in the 20th century has led to the development of high-speed installation of subsurface drains with trenching or trenchless machines. This development was accompanied by a change from clay tiles to thick-walled, smooth, rigid plastic pipes in the 1940's, followed by corrugated PVC and polyethylene tubing in the 1960's. Modern machinery regulates the depth of drains with a laser beam.

The high-speed installation of subsurface drains by modern specialized machines is important in waterlogged areas, where the number of workable days is limited, and in intensively irrigated areas, where fields are cropped throughout the year. In this context, it is good to note that mechanically-installed subsurface drainage systems are not necessarily better than older, but manually-installed systems. There are many examples of old drains that still function satisfactorily, for example a 100-year-old system draining 100 ha, which belongs to the Byelorussian Agricultural Academy in Russia (Nosenko and Zonn 1976).

Since about 1960, the development of new drainage machinery was accompanied by the development of new drain-envelope materials. In north-western Europe, organic filters had been traditionally used. In The Netherlands, for example, pre-wrapped coconut fibre was widely applied. This was later replaced by synthetic envelopes. In the western U.S.A., gravel is more readily available than in Europe, and is used as drain-envelope material. Countries with arid and semi-arid climates similar to the western U.S.A. (e.g. Egypt and Iraq) initially followed the specifications for the design of gravel filters given by the U.S. Bureau of Reclamation/USBR (1978). The high transport cost of gravel, however, guided designers to pre-wrapped pipes in countries like Egypt (Metzger et al. 1992), India (Kumbhare et al. 1992), and Pakistan (Honeyfield and Sial 1992).

1.3 From the Art of Drainage to Engineering Science

As was illustrated in the historical sketch, land drainage was, for centuries, a practice based on local experience, and gradually developed into an art with more general applicability. It was only after the experiments of Darcy in 1856 that theories were developed which allowed land drainage to become an engineering science (Russell 1934; Hooghoudt 1940; Ernst 1962; Kirkham 1972; Chapter 7). And although these theories now form the basis of modern drainage systems, there has always remained an element of art in land drainage. It is not possible to give beforehand a clear-cut theoretical solution for each and every drainage problem: sound engineering judgement on the spot is still needed, and will remain so.

The rapid development of theories from about 1955 to about 1975 is well illustrated by two quotations from Van Schilfhaarde. In 1957 he wrote:

‘Notwithstanding the great progress of recent years in the development of drainage theory, there still exists a pressing need for a more adequate analytical solution to some of the most common problems confronting the design engineer.’

In 1978, the same author summarized the state of the art for the International Drainage Workshop at Wageningen (Van Schilfhaarde 1979) as:

‘Not much will be gained from the further refinement of existing drainage theory or from the development of new solutions to abstractly posed problems. The challenge ahead is to imaginatively apply the existing catalogue of tricks to the development of design procedures that are convenient and readily adapted by practising engineers.’

With the increasing popularity of computers, many of these ‘tricks’ are combined in simulation models and in design models like SWATRE (Feddes et al. 1978; Feddes et al. 1993), SALTMOD (Oosterbaan and Abu Senna 1990), DRAINMOD (Skaggs 1980), SGMP (Boonstra and de Ridder 1981), and DrainCAD (Liu et al. 1990). These models are powerful tools in evaluating the theoretical performance of alternative drainage designs. Nowadays, however, performance is not only viewed from a crop-production perspective, but increasingly from an environmental perspective. Within the drained area, the environmental concern focuses on salinity and on the diversity of plant growth. Downstream of the drained area, environmental problems due to the disposal of drainage effluent rapidly become a major issue.

Currently, about 170 million ha are served by drainage and flood-control systems (Field 1990). In how far the actual performance of these systems can be forecast by the above models, however, is largely unknown. There is a great need for field research in this direction.

The purpose of this manual is, in accordance with the aims of ILRI, to contribute to improving the quality of land drainage by providing drainage engineers with ‘tools’ for the design and operation of land drainage systems.

1.4 Design Considerations for Land Drainage

In the ICID definition of drainage, ‘the removal of excess water’ indicates that (land) drainage is an action by man, who must know how much excess water should be removed. Hence, when designing a system for a particular area (Figure 1.2), the drainage engineer must use certain criteria (Chapter 17) to determine whether or not water is in excess. A (ground-)water balance of the area to be drained is the most accurate tool to calculate the volume of water to be drained (Chapter 16).

Before the water balance of the area can be made, a number of surveys must be undertaken, resulting in adequate hydrogeological, hydrogeological, and topographic maps (Chapters 2, 3, and 18, respectively). Further, all (sub-)surface water inflows and outflows must be measured or estimated (Chapters 4, 10, and 16). Precipitation

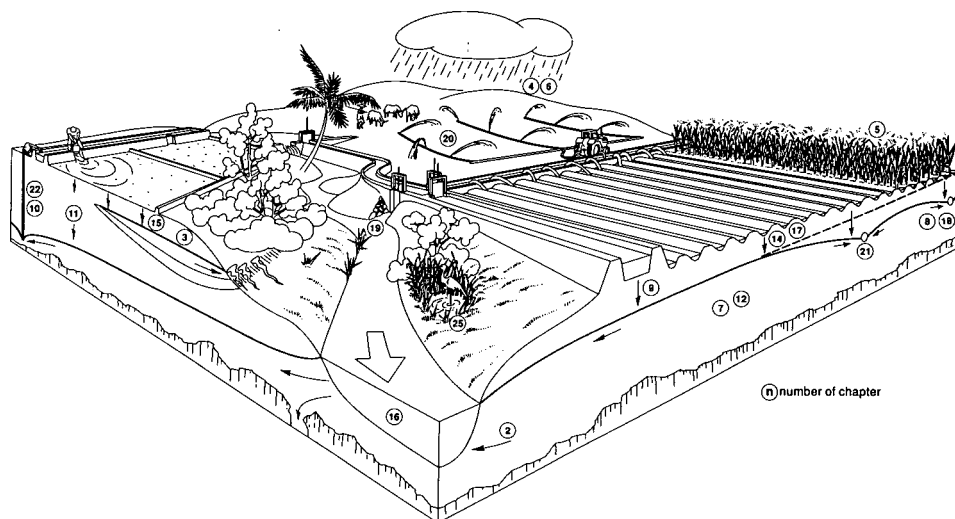

Figure 1.2 The interrelationship between the chapters of this manual

and the relevant evapotranspiration data from the area must be analyzed (Chapters 4, 5, and 6). In addition, all relevant data on the hydraulic properties of the soil should be collected (Chapter 12). The above processes in drainage surveys should be based on a sound theoretical knowledge of a variety of subjects. The importance of this aspect of drainage engineering is stressed by the fact that seventeen of the twenty-six chapters of this book deal with surveys, procedures, and theory.

In some cases, the proper identification of the source of 'excess water' will avoid the construction of a costly drainage system. For example:

- If irrigation water causes waterlogging, the efficiency of water use in the water-supply system and at field level should be studied in detail and improved (Chapters 9 and 14);
- If surface-water inflow from surrounding hills is the major cause of excess water in the area, this water could be intercepted by a hillside drain which diverts the water around the agricultural area (Chapters 19 and 20);
- If the problem is caused by the inflow of (saline) groundwater, this subsurface inflow could be intercepted by a row of tubewells (Chapter 22), which dispose of their effluent into a drain that bypasses the agricultural area;
- If the area is partially inundated because a natural stream has insufficient discharge capacity to drain the area, a reconstruction of the stream channel may solve the drainage problem (Chapter 19).

If, however, the origin of the excess water lies in the agricultural area itself (e.g. from excess rainfall or extra irrigation water that must be applied to satisfy the leaching requirement for salinity control; Chapters 11 and 15), then the installation of drainage facilities within the agricultural area should be considered. Usually, these facilities consist of (Figure 1.3) (i) a drainage outlet, (ii) a main drainage canal, (iii) some collector drains, and (iv) field drains.

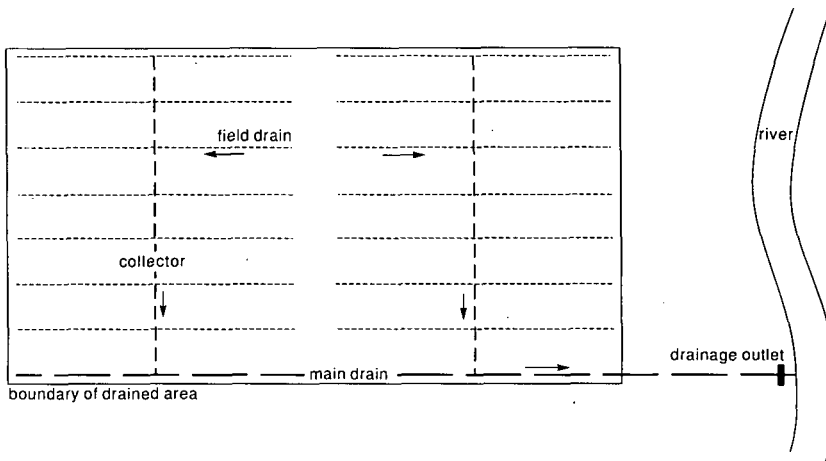

Figure 1.3 Schematic drainage system

The main drainage canal (ii) is often a canalized stream which runs through the lowest parts of the agricultural area. It discharges its water via a pumping station or a tidal gate into a river, a lake, or the sea at a suitable outlet point (i) (Chapters 23 and 24).

Main drainage canals collect water from two or more collector drains. Although collector drains (iii) preferably also run through local low spots, their spacing is often influenced by the optimum size and shape of the area drained by the selected field-drainage system. The layout of the collector drains, however, is still rather flexible since the length of the field drains can be varied, and sub-collector drains can be designed (Chapter 19). The length and spacing of the field or lateral drains (iv) will be as uniform as is applicable. Both collector and field drains can be open drains or pipe drains. They are determined by a wide variety of factors such as topography, soil type, farm size, and the method of field drainage (Chapters 20, 21, and 22).

The three most common techniques used to drain excess water are: a) surface drainage, b) subsurface drainage, and c) tubewell drainage.

- a) Surface drainage can be described as (ASAE 1979) 'the removal of excess water from the soil surface in time to prevent damage to crops and to keep water from ponding on the soil surface, or, in surface drains that are crossed by farm equipment, without causing soil erosion'. Surface drainage is a suitable technique where excess water from precipitation cannot infiltrate into the soil and move through the soil to a drain, or cannot move freely over the soil surface to a (natural) channel. This technique will be discussed in Chapter 20;
- b) Subsurface drainage is the 'removal of excess soil water in time to prevent damage to crops because of a high groundwater table'. Subsurface field drains can be either open ditches or pipe drains. Pipe drains are installed underground at depths varying from 1 to 3 m. Excess groundwater enters the perforated field drain and flows by gravity to the open or closed collector drain. The basics of groundwater flow will be treated in Chapter 7, followed by a discussion of the flow to subsurface

drains in Chapter 8. The techniques of subsurface drainage will be dealt with in Chapter 21.

- c) Tubewell drainage can be described as the 'control of an existing or potential high groundwater table or artesian groundwater condition'. Most tubewell drainage installations consist of a group of wells spaced with sufficient overlap of their individual cones of depression to control the watertable at all points in the area. Flow to pumped wells, and the extent of the cone of depression, will be discussed in Chapter 10. The techniques of tubewell drainage systems will be treated in Chapter 22.

When draining newly-reclaimed clay soils or peat soils, one has to estimate the subsidence to be expected, because this will affect the design. This problem, which can also occur in areas drained by tubewells, is discussed in Chapter 13.

Regardless of the technique used to drain a particular area, it is obvious that it must fit the local need to remove excess water. Nowadays the 'need to remove excess water' is strongly influenced by a concern for the environment. The design and operation of all drainage systems must contribute to the sustainability of agriculture in the drained area and must minimize the pollution of rivers and lakes from agricultural return flow (Chapter 25).

References

- ASAE, Surface Drainage Committee 1979. Design and construction of surface drainage systems on farms in humid areas. Engineering Practice EP 302.2, American Society of Agricultural Engineers, Michigan, 9 p.
- Boonstra, J. and N.A. de Ridder 1981. Numerical modelling of groundwater basins : a user-oriented manual. ILRI Publication 29, Wageningen. 226 p.
- Donnan, W.W. 1976. An overview of drainage worldwide. In: Third National Drainage Symposium; proceedings. ASAE Publication 1-77, St. Joseph, pp. 6-9.
- Ernst, L.F. 1962. Grondwaterstromingen in de verzadigde zone en hun berekening bij aanwezigheid van horizontale evenwijdige open leidingen. Verslagen Landbouwkundige Onderzoekingen 67-15. PUDOC, Wageningen, 189 p.
- Feddes, R.A., P.J. Kowalik and H. Zaradny 1978. Simulation of field water use and crop yield. Simulation Monographs, PUDOC, Wageningen, 189 p.
- Feddes, R.A., M. Menenti, P. Kabat and W.G.M. Bastiaansen 1993. Is large-scale modelling of unsaturated flow with areal average evaporation and surface soil moisture as estimated from remote sensing feasible? Journal Hydrology 143, pp.125-152.
- Field, W.P. 1990. World irrigation. Irrigation and Drainage Systems, 4, 2, pp. 91-107.
- FAO 1979. The on-farm use of water. FAO Committee on Agriculture, Rome, 22 p.
- Gulhati, N.D. and W.Ch. Smith 1967. Irrigated agriculture : a historical review. In: R.M. Hagan, H.R. Haise and T.W. Edminster (eds.), Irrigation of agricultural lands. Agronomy 11, American Society of Agronomy, Madison. pp. 3-11.
- Hooghoudt, S.B. 1940. Algemeene beschouwing van het probleem van de detailontwatering en de infiltratie door middel van parallel loopende drains, greppels, slooten en kanalen. Verslagen van landbouwkundige onderzoekingen 46 (14) B, Algemeene Landsdrukkerij, 's-Gravenhage, 193 p.
- Honeyfield, H.R. and B.A. Sial 1992. Envelope design for sub-surface drainage system for Fordwah Eastern Sadiqia (South) Project. In: W.F. Vlotman, Proceedings 5th international drainage workshop : subsurface drainage on problematic irrigated soils : sustainability and cost effectiveness. International Waterlogging and Salinity Research Institute, Lahore, pp. 5.26-5.37
- ICID 1979. Amendments to the constitution, Agenda of the International Council Meeting at Rabat. International Commission on Irrigation and Drainage, Morocco. ICID, New Delhi, pp. A-156-163.

- Jacobsen, Th. and R.M. Adams 1958. Salt and silt in ancient mesopotamian agriculture. *Science* 128, 3334, pp. 1251-1258.
- Kaneko, R. 1975. Agricultural engineering activities in Japan. Irrigation and drainage course, Japan International Cooperation Agency. Uchiyama International Agricultural Training Centre, 160 p.
- King, F.H. 1911. Farmers of forty centuries, or permanent agriculture in China, Korea and Japan. Rodale, Emmaus, 441 p.
- Kirkham, D. 1972. Problems and trends in drainage research, mixed boundary conditions. *Soil Science* 113, 4, pp. 285-293.
- Knauss, J. 1991. Arkadian and Boiotian Orchomenos, centres of Mycenaean hydraulic engineering. *Irrigation and Drainage Systems* 5, 4, pp. 363-381.
- Kumbhare, P.S., K.V. Rao, K.V.G. Rao, H.S. Chauhan and R.J. Oosterbaan 1992. Performance of some synthetic drain filter materials in sandy loam soils. In: W.F. Vlotman, Proceedings 5th international drainage workshop : subsurface drainage on problematic irrigated soils : sustainability and cost effectiveness. International Waterlogging and Salinity Research Institute, Lahore, pp. 5.97-5.104.
- Leeghwater, J.A. 1641. In: *Haarlemmermeerboek*, 1838 13e dr. Amsterdam, 192 p.
- Lin, F., P. Campling and P. Pauwels 1990. Drain CAD: a comprehensive and flexible software package for the automation of the drainage design of agricultural drainage systems. User Manual. Center for Irrigation Engineering, Leuven, Belgium. 101. p.
- Maierhofer, C.R. 1962. Drainage in irrigation : a world problem I and II. *The reclamation era*, 48, 3, pp. 73-76 and 4, pp. 103-105.
- Metzger, J.F., J. Gallichand, M.H. Amer and J.S.A. Bricchieri-Colombi 1992. Experiences with fabric envelope selection in a large subsurface drainage project in Egypt. In: W.F. Vlotman, Proceedings 5th international drainage workshop : subsurface drainage on problematic irrigated soils : sustainability and cost effectiveness. International Waterlogging and Salinity Research Institute, Lahore, pp. 5.77-5.87.
- Nosenko, P.P. and I.S. Zonn 1976. Land drainage in the world. *ICID Bulletin*, 25, 1, pp. 65-70.
- Ogrosky, H.O. and V. Mockus 1964. Hydrology of agricultural lands. In: V.T. Chow (ed.), *Handbook of applied hydrology*. McGraw-Hill, New York, 22, pp. 21-97.
- Oosterbaan, R.J. and M. Abu Senna 1990. Using SALTMOD to predict drainage and salinity in the Nile Delta. In: *Annual Report 1990*, ILRI, Wageningen, pp. 63-74.
- Russell, J.L. 1934. Scientific research in soil drainage. *Journal Agricultural Science* 24, pp. 544-573.
- Skaggs, R.W. 1980. Drainmod-reference report: Methods for design and evaluation of drainage water management systems for soils with high water tables. U.S.D.A. Soil Cons. Service, Forth Worth, 190 p.
- Snelgrove, A.K. 1967. Geohydrology in the Indus River in West Pakistan. Sind University Press, Hyderabad, 200 p.
- Thorne, D.W. and H.B. Peterson 1949. Irrigated soils, their fertility and management. The Blakiston Company, Philadelphia, 288 p.
- USBR 1978. Drainage manual. U.S. Department of the Interior, Bureau of Reclamation, Denver, 286 p.
- Van Schilfgaarde, J. 1957. Approximate solutions to drainage flow problems. In: J.N. Luthin (ed.), *Drainage of Agricultural Lands*. Agronomy 7. American Society of Agronomy, Madison, pp. 79-112.
- Van Schilfgaarde, J. 1979. Progress and problems in drainage design. In: J. Wesseling (ed.), *Proceedings of the International Drainage Workshop*. ILRI Publication 25, Wageningen, pp. 633-644.
- Vučić, N. 1979. Irrigation of agricultural crops. Faculty of Agriculture, Novi Sad, 567 p.
- Weaver, M.M. 1964. History of tile drainage. Weaver, New York, 343 p.
- Wen, H.J. and C.L. Lin 1964. The distribution and reclamation of saline-alkali soils of the North China Plain and the Wei-Ho Plain in the period of the Chou-Han Dynasties. *Acta Pedologica Sinica* 12, 1, pp. 1-9. (In Chinese with English abstract).
- Wooten, H.H. and L.A. Jones 1955. The history of our drainage enterprises. In: *Water, the Yearbook of agriculture*. U.S. Department of Agriculture, Washington, 478-491 p.

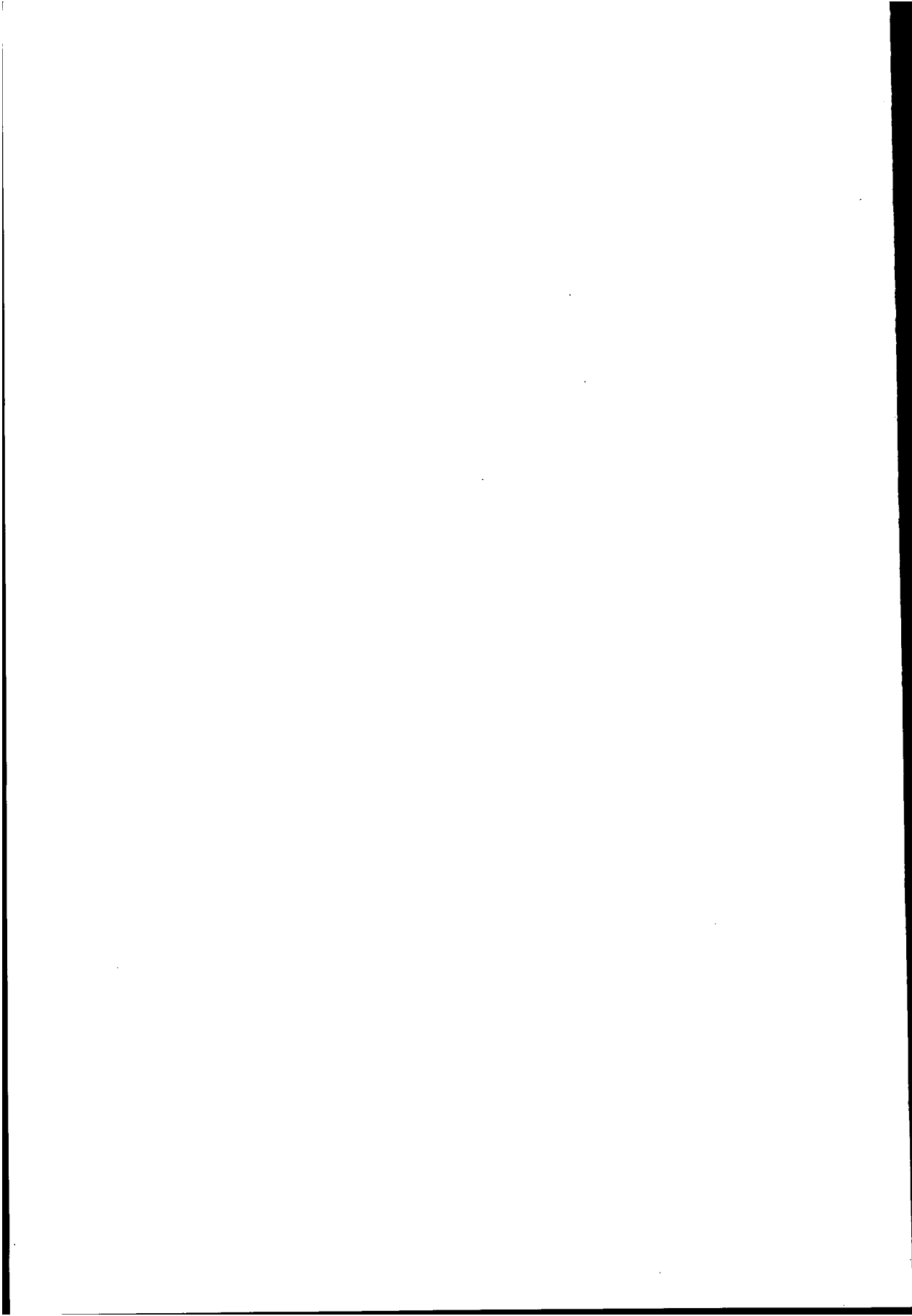

2 Groundwater Investigations

N.A. de Ridder^{1†}

2.1 Introduction

Successful drainage depends largely on a proper diagnosis of the causes of the excess water. For this diagnosis, one must consider: climate, topography, pedology, surface water hydrology, irrigation, and groundwater hydrology (or hydrogeology). Each of these factors – either separately, or more often in combination – may create a surface drainage problem (flooding, ponding) or a subsurface drainage problem (shallow watertable, waterlogging), or a combination of these problems. Most of these factors are treated separately elsewhere in this book.

In this chapter, we shall concentrate on some hydrogeological aspects of drainage problems, particularly those of subsurface drainage. Although each area has its own specific groundwater conditions, a close relationship exists between an area's groundwater conditions and its geological history. So, first, we shall discuss this relationship. For more information reference is made to Davis and De Wiest 1966 and Freeze and Cherry 1979.

We shall then explain how to conduct a groundwater investigation, describing how to collect, process, and evaluate the groundwater data that are pertinent to subsurface drainage, for more details see UN 1967. For further reading Mandel and Shifan 1981, Matthes 1982, Nielsen 1991, Price 1985 and Todd 1980 are recommended.

2.2 Land Forms

Land forms are the most common features encountered by anyone engaged in drainage investigations. If land forms are properly interpreted, they can shed light upon an area's geological history and its groundwater conditions.

The two major land forms on earth are mountains and plains. Plains are areas of low relief and have our main interest because they usually have rich agricultural resources that can be developed, provided their water management problems are solved. This does not mean that the drainage engineer can neglect the mountains bordering many such plains. Mountain ranges are the source of the sediments occurring in the plains. They are also the source of the rivers that carry the detritus to the plains where it is deposited when the rivers flood.

Not all plains are of the same type; their source area, transporting agent, and depositional environment will differ. We recognize the following types of plains:

- Alluvial plains, formed by rivers;
- Coastal plains, formed by the emergence of the sea floor;
- Lake plains, formed by the emergence of a lake floor;
- Glacial plains, formed by glacial ice.

¹ International Institute for Land Reclamation and Improvement

The above list is not complete but covers the types of plains that are important for agriculture; they are also areas where drainage problems are common. Their main geological features and groundwater conditions will now be briefly described. For more information on land forms reference is made to Thornbury 1969.

2.2.1 Alluvial Plains

Alluvial plains are formed by rivers and usually have a horizontal structure. The larger alluvial plains, however, are downwarped and often faulted. They may contain alluvial sediments that are hundreds or even thousands of metres thick. Along the course of the river, from the mountains to the sea, we recognize three types of alluvial plains:

- Alluvial fan;
- River plain;
- Delta plain.

Alluvial Fans

An alluvial fan is a cone-like body of alluvial materials laid down by a river debouching from a mountain range into lowland (Figure 2.1). Alluvial fans are found in both the humid and the arid zones. They occur in all sizes, the size being largely determined by the size and geology of the river catchment and the flow regime of the river. Boulders, gravel, and very coarse sand dominate the sediments at the fan head. The sediments usually become finer towards the distal end of the fan, where they may be silt or fine sandy loam.

Because of the variability of a river's flow regime, alluvial fans are subject to rapid changes, with channels shifting laterally over a wide area, and channels alternating, cutting, and filling themselves. The mud-flow deposits extend as a continuous sheet over large areas, whereas the sand and gravel deposits are usually restricted to former channels.

Because of the very coarse materials at the head of the fan and the many diverging stream channels, substantial quantities of river water percolate to the underground. The head of the fan is therefore a recharge zone. The middle part of the fan is mainly a transmission zone. The distal end of the fan is a zone of groundwater discharge. Owing to the presence of mud-flow deposits of low permeability, the groundwater in the deep sand and gravel deposits is confined (i.e. the water level in a well that penetrates the sand and gravel layers stands above these layers).

The watertable, which is deep in the head of the fan, gradually becomes shallower towards the distal end, where it may be at, or close to, the surface. In arid zones, substantial quantities of groundwater are lost here by capillary rise and evaporation, which may turn the distal fan into a true salt desert.

Whereas subsurface drainage problems are restricted to the distal fan, surface drainage problems may occasionally affect major parts of an alluvial fan, especially when heavy rains evacuate highly sediment-charged masses of water from the mountains.

River Plains

River plains are usually highly productive agricultural areas. Rivers occur in different

bird's-eye view

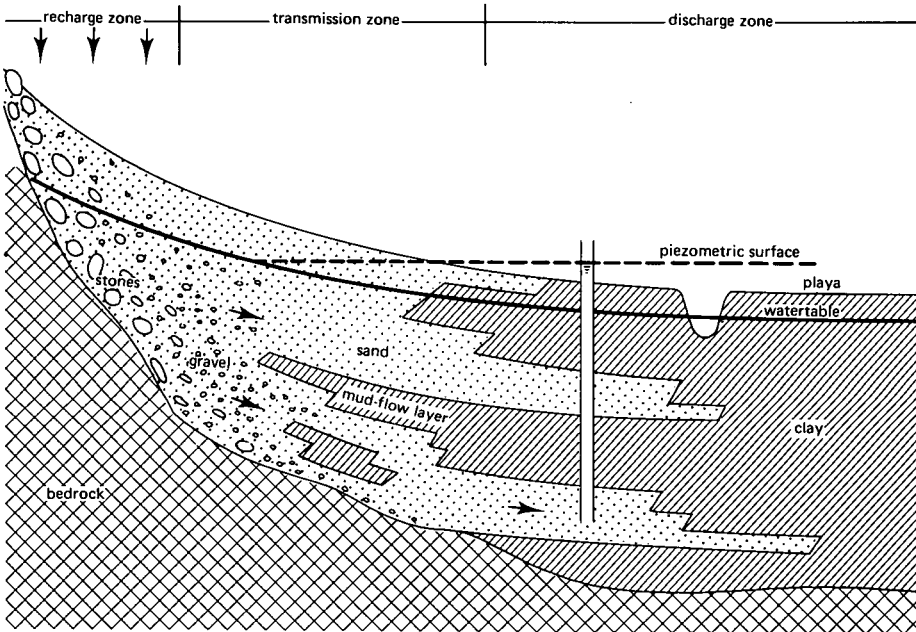
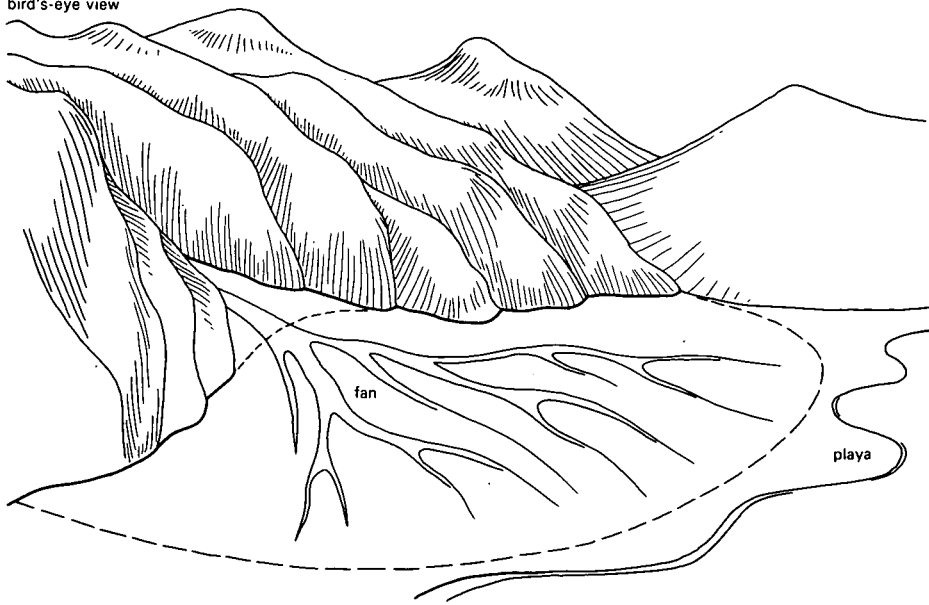

Figure 2.1 Bird's-eye view and idealized cross-section of an alluvial fan showing the flow of groundwater from the recharge zone to the discharge zone

sizes and stages of development (Strahler 1965), but a common type is the graded river, which has reached a state of balance between the average supply of rock waste to the river and the average rate at which the river can transport the load. At this stage, the river meanders, cutting only sideways into its banks, thus forming a flat valley floor. In the humid zones, most of the large rivers have formed wide flood plains. Typical morphological features of a flood plain are the following (Figure 2.2):

- Immediately adjacent to the river are the natural levees or the highest ground on the flood plain;
- On the slip-off slope of a meander bend are point bars of sandy materials;
- Oxbow lakes or cut-off meander bends contain water;
- Some distance away from the river are backswamps or basin-like depressions;
- Terraces along the valley walls represent former flood plains of the river.

Flood plain deposits vary from coarse sand and gravel immediately adjacent to the river, to peat and very heavy clays in the backswamps or basins (Figure 2.3A). In the quiet-water environments of these basins, layers of peat, peaty clay, and clay are deposited; they may be some 5 to 10 m thick. In many flood plains in the humid climates, a coarsening of sediments downward can be observed; continuous layers of coarse sand and gravel underlie most of those plains. These coarse materials were deposited under climatological conditions that differ from those of the present. At that time, the river was supplied with more rock waste than it could carry. Instead of flowing in a single channel, the river divided into numerous threads that coalesced and redivided. Such a river is known as a braided river. The channels shift laterally over a wide area; existing channels are filled with predominantly coarse sand and gravel, and new ones are cut. In cross-section, the sediments of braided rivers show a characteristic cut-and-fill structure (Figure 2.3B).

A flood plain, as the name implies, is regularly flooded at high river stages, unless it is protected by artificial levees (dikes). Deforestation in the catchment area of the river aggravates the floodings. Subsurface drainage problems are common in such plains, especially in those of the humid climates. Shallow watertables and marshy conditions prevail in the poorly drained backswamps and other depressions. Seepage

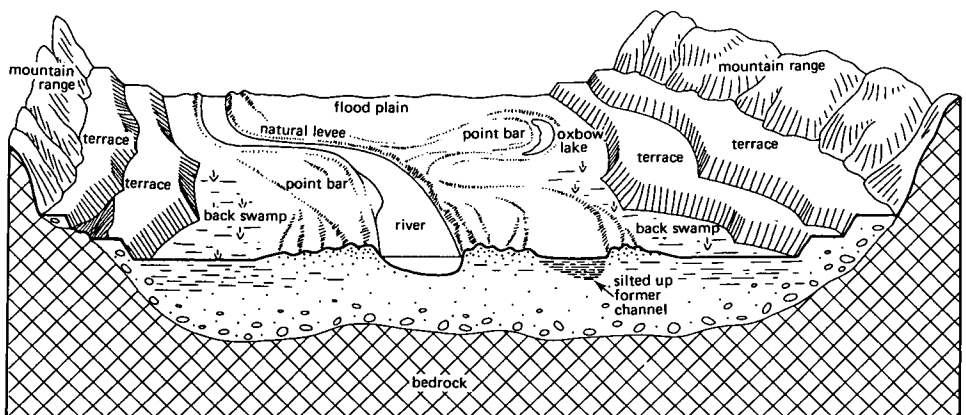

Figure 2.2 A broad river valley plain of the humid zone, with its typical morphological features

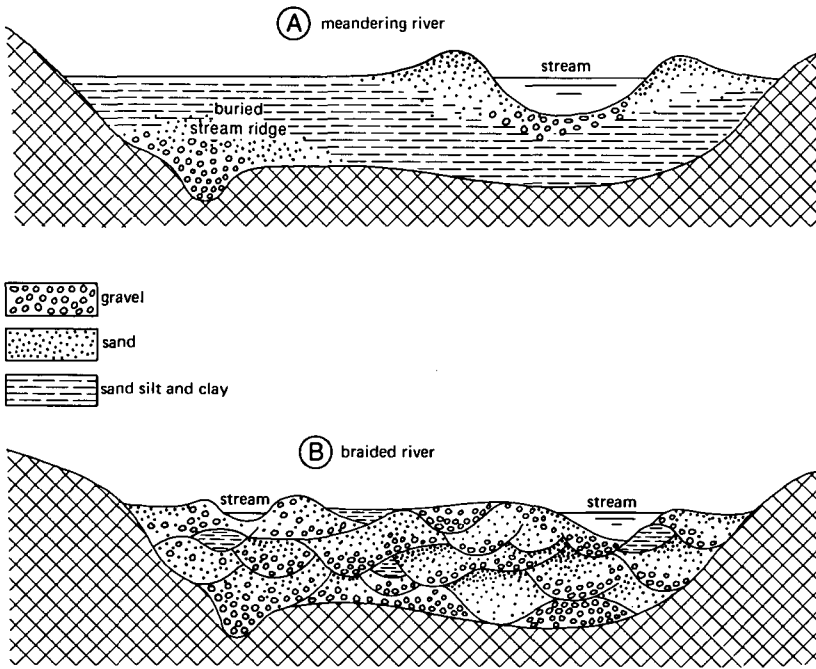

Figure 2.3 Cross-sections over a valley with:
A: A meandering river; B: A braided river

from the river, when it is at high stage, contributes to the subsurface drainage problems of the plain. (This will be discussed further in Chapter 9.)

Delta Plains

Deltas are discrete shoreline protuberances formed where rivers enter the sea or a lake and where sediments are supplied more rapidly than they can be redistributed by indigenous processes. At the river mouth, sediment-laden fluvial currents suddenly expand and decelerate on entering the standing water body. As a result, the sediment load is dispersed and deposited, with coarse-grained bedload sediment tending to accumulate near the river mouth, whilst the finer-grained sediment is transported offshore in suspension, to be deposited in deeper water.

Delta plains are extensive lowlands with active and abandoned distributary channels. Between the channels is a varied assemblage of bays, flood plains, tidal flats, marshes, swamps, and salinas (Figure 2.4).

In the humid tropics, a luxuriant vegetation of saline mangroves usually covers large parts of a delta plain. In contrast, delta plains in arid and semi-arid climates tend to be devoid of vegetation; salinas with gypsum (CaSO_4) and halite (NaCl) are common, as are aeolian dune fields.

Some delta plains are fluvial-dominated because they are enclosed by beach ridges at the seaward side; others are tide-dominated because tidal currents enter the distributary channels at high tides, spilling over the channel banks and inundating the adjacent areas. But even in areas with moderate to high tidal ranges, the upper

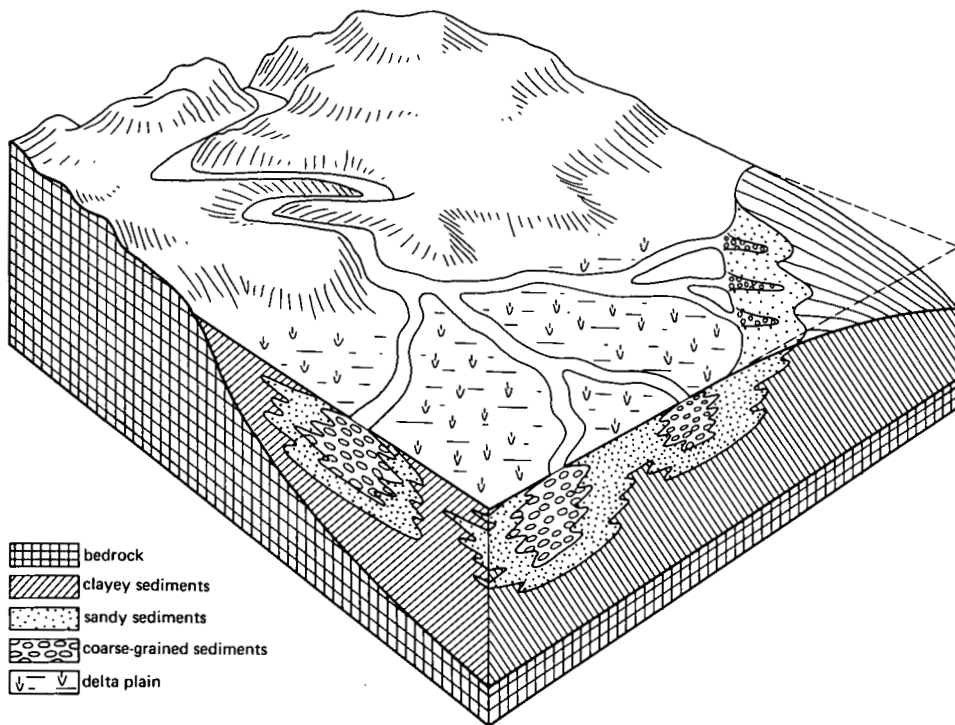

Figure 2.4 A typical delta

delta plain is fluvial-dominated; the lower delta plain may be tide-dominated, and the delta front may be either tide- and/or wave-dominated.

The groundwater in the upper delta is usually fresh and the watertable is relatively deep; problems of subsurface drainage and soil salinization do not occur there. In the lower delta, however, such problems do occur because the watertable is close to the surface, the groundwater is salty or brackish, and salinized soils are widespread, especially in arid deltas.

Figure 2.5 shows the groundwater flow and groundwater conditions in a delta plain.

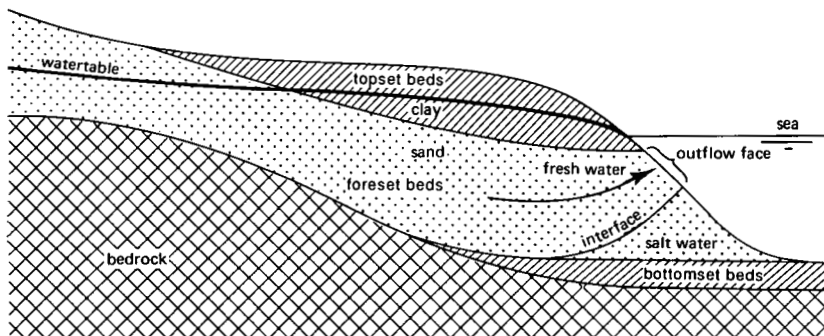

Figure 2.5 Cross-section of a delta plain, showing the interface of fresh and salt water and the outflow face at the delta front

The fresh groundwater of the upper delta moves seaward because its phreatic level is above sea level; it flows out in a narrow zone at the delta front. Owing to diffusion and dispersion, the initially sharp interface between fresh and salt water bodies gradually passes into a brackish transition layer. The rate at which this transition layer develops depends on various factors, one of which is the permeability of the delta sediments (Jones 1970).

2.2.2 Coastal Plains

From a geological point of view, coastal plains are an entirely different type of plain because they are recently-emerged parts of the sea floor. If the sea floor emerged in the remote geological past, coastal plains can be found far from the sea and are then called 'interior plains'. The structure of coastal plains can be simple, consisting of a continuous sequence of beds, or complex as a result of several advances and retreats of the sea (Figure 2.6).

Coastal plains may be narrow or even fragmentary strips of the former sea floor,

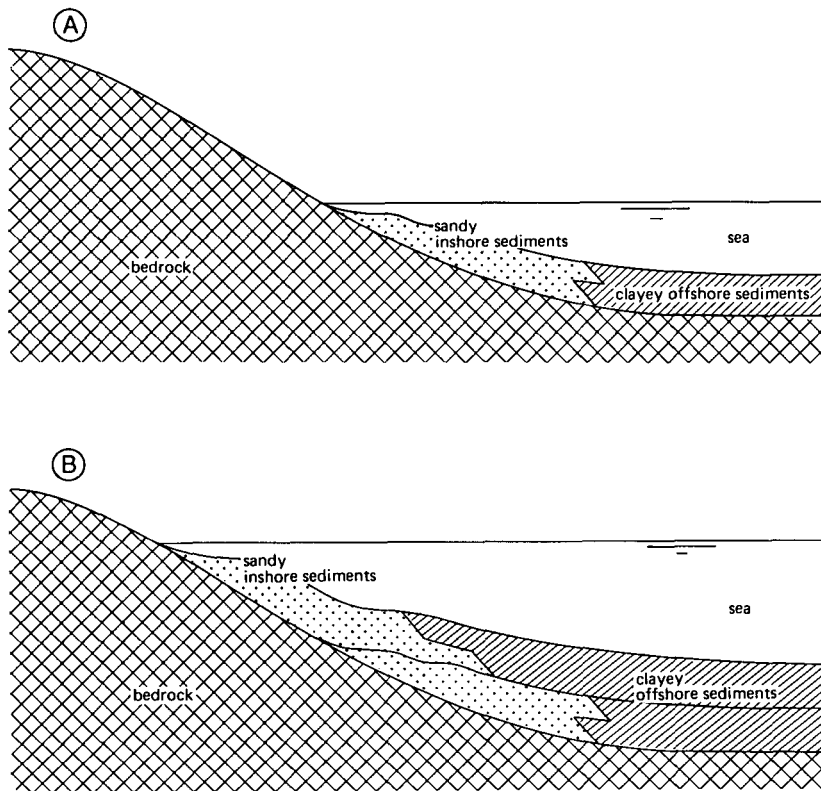

Figure 2.6 Schematic section perpendicular to a coast, showing the formation of belts of coastal sediment and their shift during submergence.

A: Constant sea level; B: Sea rises to new level and remains there, depositing sediments as in A. New sediment overlies the older sediment (after Longwell et al. 1969)

exposed along the margins of an old land area, or they may be vast, almost featureless plains, fringing hundreds of kilometres of coastline. Gently sloping coastal plains are attacked by the waves offshore and, as a result, sand bars may form parallel to the coast. Some plains are enclosed by dunes at the seaward side. The land enclosed by the dunes and by the natural levees of rivers that traverse the coastal plain is a true basin, containing lakes and swamps. In contrast to the upper coastal plain, the lower coastal plain may suffer from severe surface drainage problems.

The groundwater conditions of coastal plains are complex. The watertable in the upper part of the plain is usually deep, but gradually becomes shallower towards the coast. The soils in the upper part are usually sandy and permeable, so that subsurface drainage problems do not occur. Here we find outcrops of the sand layers that dip seaward under the lower coastal plain (Figure 2.7).

Because there is a seaward fining of sediments and because the sand layers are (partly) overlain and underlain by clayey deposits, the groundwater in the sand layers of the lower plain is confined. The seaward thinning of the sand layers contributes to the confined groundwater conditions. As a result, there is upward seepage from the deeper sandy layers through the clay layers to the surface. Both surface and subsurface drainage problems are common in lower coastal plains.

2.2.3 Lake Plains

Lakes originate in different ways; they may be river-made, glacial, volcanic, fault-basin, and landslide lakes. Most lakes are small and ephemeral. Those formed in active tectonic areas persist for long periods of geological time. Some lakes fall dry because of a change in their water balance.

Emerged lake floors are flat, almost featureless plains. In arid zones, surface water collects in the lower parts of the plains, where it evaporates, leaving behind the suspended sediments, mixed with fine salt crystals (halite, gypsum, carbonates). The sediments of such ephemeral water bodies commonly build up clay-surface plains of extraordinary flatness; these are called playas.

Most of the clastic sediment deposited in lakes is transported there by rivers, either in suspension or as bed load. Where the river water spreads out upon entering the

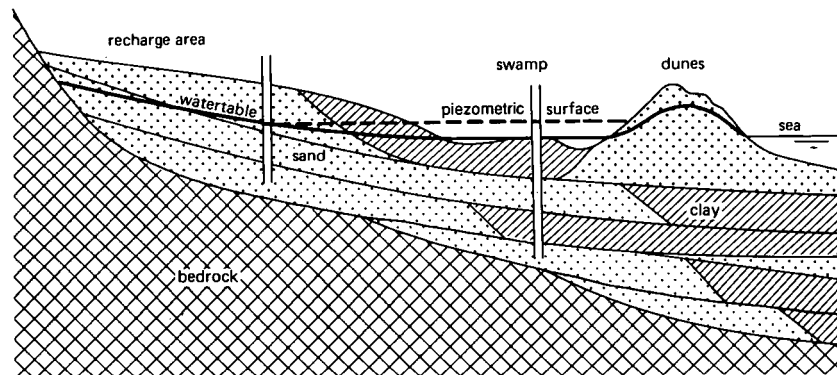

Figure 2.7 Groundwater conditions of a coastal plain

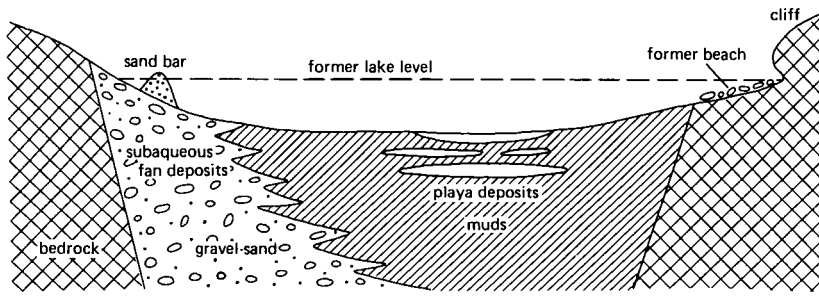

Figure 2.8 Geological section through the sediments of a former lake

lake, bed load, and coarse materials of the suspended load will be deposited first. Further away from the river mouth, there will be a distal fining of sediment, as in marine deltas. Where water densities allow underflow of the river water, coarse sediment may be spread out over the lake floor. Eventually, this may lead to the development of subaqueous fans in front of the river mouth. In the deepest parts of lake basins, clastic deposition is almost entirely from suspension.

Several morphological features can provide evidence of the former existence of a lake (Figure 2.8): for instance, a cliff on the hard rocks bordering the former lake, lake terraces at the foot of the cliff, and beaches and sand ridges, representing spits and sand bars formed by wave action near the lake margin.

Lake plains in humid climates usually have a shallow watertable that must be controlled if the land is to be used for agriculture. In lake plains in arid climates, the watertable is deep, except where rivers enter the former lake. If the river water is used for irrigation, the watertable may be very shallow in most of the irrigated areas. Because of the low permeability of the lake sediments, groundwater movement is slow, resulting in large watertable gradients at the margins between irrigated and non-irrigated lands.

2.2.4 Glacial Plains

At present, some 10 per cent of the earth's surface is covered by glacial ice. During the Quaternary glaciation, the maximum coverage was about 30 per cent and the resulting sediments were distributed over vast areas.

A characteristic sediment of the basal or subglacial zone – the contact zone of ice and bed(rock) – is till, a glacially-deposited mixture of gravel, sand, and clay-sized particles. Its texture is extremely variable. Massive tills occur as sheets, tongues, and wedges, but locally cross-sections appear as blankets (Figure 2.9). The erodibility of the substrata largely controls the thickness of till deposits. Where there was considerable local relief, the till is thick in depressions and in deeply incised channels, and is thin or absent on highs.

Another characteristic subglacial deposit is that of eskers. These are formed in melt-water tunnels at the base of the glacial ice. Eskers are mainly composed of sandy materials and appear in the landscape as ridges.

Around the margin of glacial ice – and strongly influenced by the ice – is the

proglacial environment, which may be glaciofluvial, glaciolacustrine, or glaciomarine environments (i.e. produced by, or belonging to, rivers, lakes, or seas, respectively). Typical examples of the glaciofluvial environment are the outwash deposits, which may cover substantial areas marginal to glaciated regions. Outwash deposits are composed of sand and gravel; they form where meltwater is abundant and coarse material is available. These sediments are deposited by braided streams. Extensive outwash fans occur along the margin of a stationary glacier.

Lakes are a common feature in a proglacial landscape. They develop because rivers are dammed by the ice and because of the formation of irregular topography by glacially-deposited or eroded land forms. In cross-section, filled glacial lakes show the classical structure of steeply inclined foreset beds, chiefly made up of coarse sands, and gently sloping bottomset beds made up of fine-grained lake-floor deposits (mud, silt, and clay). The lake-bottom deposits typically consist of varves, each varve

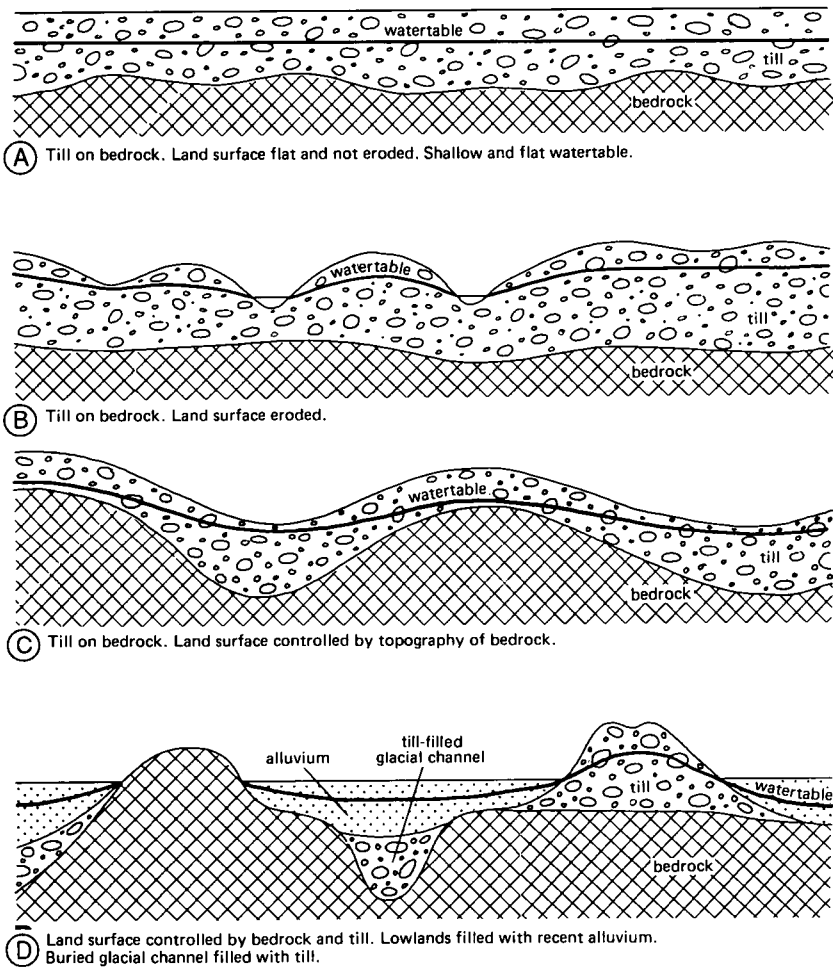

Figure 2.9 Cross-sections showing various relationships between bedrock and till deposits

consisting of a lower coarse layer of very fine sand-to-silt and an upper layer of clay.

Both climatic instability and powerful winds contribute to aeolian activity around a glacier or ice sheet. Sand reworked from glacial deposits is shaped into aeolian dunes. Silt is also readily picked up from glacial outwash and is deposited down-wind as loess, which is generally well-sorted and poorly stratified or non-stratified. Loess deposits can form blankets up to tens of metres thick and can extend hundreds of kilometres from the ice margin.

Young glacial plains are often characterized by poor drainage. This is mainly due to the low permeability of the till deposits and the undeveloped drainage systems. Once a drainage system has developed, the drainage of the higher grounds will be better. Excess water from rainfall and from surface runoff may collect in local depressions and lowlands, causing flooding and high watertables.

2.3 Definitions

2.3.1 Basic Concepts

The water in the zone of saturation, called groundwater, occurs under different conditions.

Where groundwater only partly fills an aquifer (a permeable layer), the upper surface of the saturated zone, known as the watertable, is free to rise and fall. The groundwater in such a layer is said to be unconfined, or to be under phreatic or watertable conditions (Figure 2.10A).

Where groundwater completely fills a permeable layer that is overlain and underlain by aquicludes (i.e. impermeable layers), the upper surface of the saturated zone is fixed. Groundwater in such a layer is said to be confined, or to be under confined or artesian conditions (Figure 2.10B). The water level in a well or borehole that penetrates into the permeable layer stands above the top of that layer, or, if the artesian pressure is high, even above the land surface. Relative to a chosen reference level,

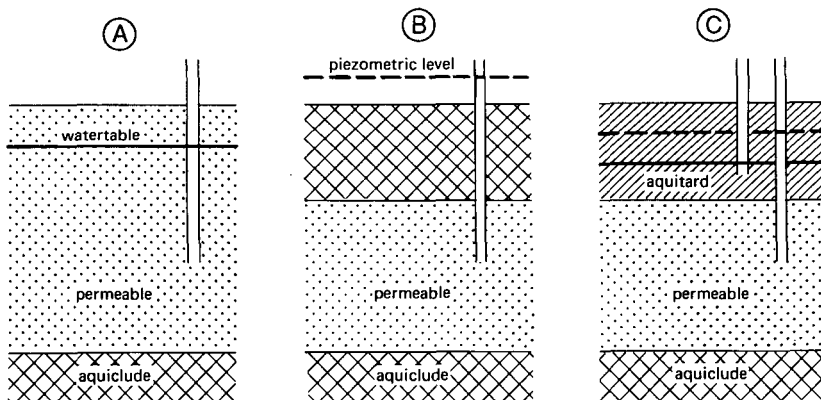

Figure 2.10 Different groundwater conditions:

A: Unconfined (watertable, phreatic) conditions; B: Confined (artesian) conditions; C: Semi-confined conditions

the height of the water column in the well is called hydraulic head, being the sum of pressure head and elevation head. (This will be discussed further in Chapter 7.) Truly impermeable layers are not common in nature; most fine-textured layers possess a certain, though low, permeability.

Where groundwater completely fills a permeable layer that is overlain by an aquitard (a poorly permeable layer) and underlain by an aquiclude or aquitard, the groundwater in the permeable layer is said to be semi-confined (Figure 2.10C). In the overlying aquitard, the groundwater is under unconfined conditions because it is free to rise and fall. The water level in a well or borehole that penetrates the permeable layer stands above the top of that layer or even above the land surface if the pressure is high. This type of groundwater condition is very common in nature. Three different situations can be recognized:

- The water level in the well stands at the same height as the watertable in the overlying aquitard, which means that there is no exchange of water between the two layers;
- The water level stands above the watertable in the aquitard, which means that there is an exchange of water between the two layers, with the permeable layer losing water to the aquitard; here, one speaks of upward seepage through the aquitard;
- The watertable stands below the watertable in the aquitard; here, the permeable layer receives water from the aquitard, and one speaks of downward seepage (or natural drainage) through the aquitard.

These three groundwater conditions can also occur in combination (e.g. in stratified soils, where permeable and less permeable layers alternate, or, besides seepage through the poorly permeable top layer, there may also be seepage through an underlying layer).

In some areas, drainage problems can be caused by a perched watertable. The watertable may be relatively deep, but a hardpan or other impeding layer in the soil profile creates a local watertable above that layer or hardpan.

It will be clear by now that an area's groundwater conditions are closely related to its geological history. As the geology of an area is usually variable, so too are its groundwater conditions. In a practical sense, the problem is one of identifying and evaluating the significance of boundaries that separate layers of different permeability. In subsurface drainage studies, we are interested primarily in the spatial distribution and continuity of permeability.

In solutions to groundwater problems, permeable, poorly permeable, or impermeable layers are usually assumed to be infinite in extent. Obviously, no such layers exist in nature; all water-transmitting and confining layers terminate somewhere and have boundaries. Hydraulically, we recognize four types of boundaries:

- Impermeable boundaries;
- Head-controlled boundaries;
- Flow-controlled boundaries;
- Free-surface boundaries.

An impermeable boundary is one through which no flow occurs or, in a practical sense, a boundary through which the flow is so small that it can be neglected. A

permeable sand layer may pass laterally (by interfingering) into a low-permeable or impermeable clay layer, as we saw in Section 2.2.2 when discussing the geology of coastal plains. As the transition of the two layers, we have an impermeable boundary. Other examples of impermeable boundaries are a sand layer that terminates against a valley wall of impermeable hardrock, or a fault that brings a permeable and an impermeable layer in juxtaposition (Figure 2.11).

A head-controlled boundary is a boundary with a known potential or hydraulic head, which may or may not be a function of time. Examples are streams, canals, lakes, or the sea, which are in direct hydraulic contact with the water-transmitting layers. Note that an ephemeral stream in arid zones is not a head-controlled boundary because part or most of the time it does not contain water, and when it does, the water in the stream is not in contact with the groundwater, which may be many metres below the stream bed.

A flow-controlled boundary, also called a recharge boundary, is a boundary through which a certain volume of groundwater enters the water-transmitting layer per unit of time from adjacent strata whose hydraulic head and permeability are not known. The quantity of water transferred in this way usually has to be estimated from rainfall and runoff data. A typical example is the underflow entering the head of an alluvial fan (Section 2.2.1). Note that an impermeable boundary is a special type of flow-controlled boundary: the flow is zero.

A free-surface boundary is the boundary between the zones of aeration and saturation (i.e. the watertable is free to rise and fall). In subsurface drainage studies, this boundary is of primary importance.

Many subsurface drainage projects cover only a portion of an alluvial, coastal, or glacial plain. Project boundaries therefore do not usually coincide with hydraulic boundaries.

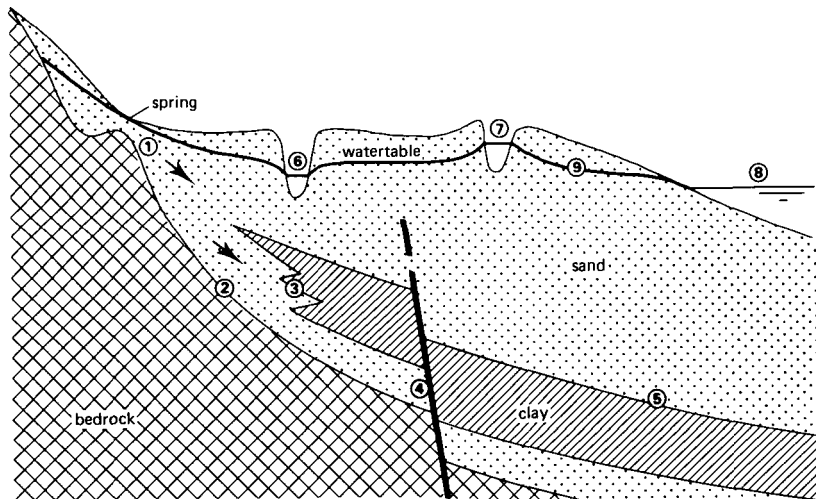

Figure 2.11 Examples of hydraulic boundaries:
 1: Flow-controlled boundary; 2, 3, 4, and 5: Impermeable boundaries; 6, 7, and 8: Head-controlled boundaries; 9: Free-surface boundary

2.3.2 Physical Properties

To describe the flow of water through the different layers, one needs data on the following physical properties: hydraulic conductivity, saturated thickness, transmissivity, drainable pore space, storativity, specific storage, hydraulic resistance, and the leakage factor. These will be briefly explained.

Hydraulic Conductivity

The hydraulic conductivity, K , is the constant of proportionality in Darcy's law and is defined as the volume of water that will move through a porous medium in unit time under a unit hydraulic gradient through a unit area measured at right angles to the direction of flow. Hydraulic conductivity can have any units of length/time (e.g. m/d). Its order of magnitude depends on the texture of the soil (Chapter 3) and is affected by the density and viscosity of the groundwater (Chapter 7).

Saturated Thickness

For confined aquifers, the saturated thickness, H , is equal to the physical thickness of the aquifer between the aquicludes above and below it (Figure 2.10B). The same is true for a semi-confined aquifer bounded by an aquiclude and an aquitard (Figure 2.10C). In both these cases, the saturated thickness is a constant. Its order of magnitude can range from several metres to hundreds or even thousands of metres. For unconfined aquifers (Figure 2.10A), the saturated thickness, D' , is equal to the difference in level between the watertable and the aquiclude. Because the watertable is free to rise and fall, the saturated thickness of an unconfined aquifer is not constant, but variable. It may range from a few metres to some tens of metres.

Transmissivity

The transmissivity, KH , is the product of the average hydraulic conductivity, K , and the saturated thickness of the aquifer, H . Consequently, the transmissivity is the rate of flow under a hydraulic gradient equal to unity through a cross-section of unit width and over the whole saturated thickness of the water-bearing layer. It has the dimensions of length²/time and can, for example, be expressed in m²/d. Its order of magnitude can be derived from those of K and H .

Drainable Pore Space

The drainable pore space, μ , is the volume of water that an unconfined aquifer releases from storage per unit surface area of aquifer per unit decline of the watertable. Small pores do not contribute to the drainable pore space because the retention forces in them are greater than the weight of water. Hence, no groundwater will be released from small pores by gravity drainage.

Drainable pore space is sometimes called specific yield, drainable porosity, or effective porosity. It is a dimensionless quantity, normally expressed as a percentage. Its value ranges from less than 5 per cent for clayey materials to 35 per cent for coarse sands and gravelly sands (Chapter 3).

Storativity

The storativity, S , of a saturated confined aquifer is the volume of water released

from storage per unit surface area of aquifer per unit decline in the component of hydraulic head normal to that surface. In a vertical column of unit area extending through the confined aquifer, the storativity, S , equals the volume of water released from the aquifer when the piezometric surface drops over a unit decline distance. The storativity is a dimensionless quantity. It is the algebraic product of an aquifer thickness and specific storage and its value in confined aquifers ranges from 5×10^{-5} to 5×10^{-3} .

Specific Storage

The specific storage, S_s , of a saturated confined aquifer is the volume of water that a unit volume of the aquifer releases from storage under a unit decline in head. This release of water under conditions of decreasing hydraulic head stems from two mechanisms:

- The compaction of the aquifer due to increasing effective stress;
- The expansion of water due to decreasing water pressure (see also Chapter 9).

For a certain location, the specific storage can be regarded as a constant. It has the dimension of length⁻¹.

Hydraulic Resistance

The hydraulic resistance, c , characterizes the resistance of an aquitard to vertical flow, either upward or downward. It is the ratio of the saturated thickness of the aquitard, D' , and its hydraulic conductivity for vertical flow (K) and is thus defined as

$$c = \frac{D'}{K} \quad (2.1)$$

The dimension of hydraulic resistance is time; it can, for example, be expressed in days. Its order of magnitude may range from a few days to thousands of days. Aquitards with c -values of 1000 days or more are regarded as aquicludes, although, theoretically, an aquiclude has an infinitely high c -value.

Leakage Factor

The leakage factor, L , describes the spatial distribution of leakage through an aquitard into a semi-confined aquifer, or vice versa. It is defined as

$$L = \sqrt{KHc} \quad (2.2)$$

High values of L originate from a high transmissivity of the aquifer and/or a high hydraulic resistance of the aquitard. In both cases, the contribution of leakage will be small and the area over which leakage takes place, large. The leakage factor has the dimension of length and can, for example, be expressed in metres.

2.4 Collection of Groundwater Data

To obtain data on the depth and configuration of the watertable, the direction of groundwater movement, and the location of recharge and discharge areas, a network of observation wells and/or piezometers has to be established.

2.4.1 Existing Wells

Existing wells offer ready-made sites for watertable observations. Many villages and farms have shallow, hand-dug wells that can offer excellent observation points. Because they are hand-dug, one can be sure that they will not penetrate more than slightly below the lowest expected level to which the groundwater will fall. They will thus truly represent the watertable.

Their location, however, may not always fit into an appropriate network; they may be sited on topographic highs, for example, or their water levels may be deeper than 2 m below the land surface. Another possible disadvantage is that such wells usually have a large diameter. This means that they have a large storage capacity, implying that the water level in the well will take some time to respond to changes in the watertable, or to recover when water is taken from them in substantial quantities. Other causes of erroneous data may be a clogged well screen or a low permeability of the water-transmitting layer.

Relatively deep wells piercing alternating layers of sand and clay below the watertable must be considered with caution; their water levels may be a composite of the different hydraulic heads that occur in the pierced sandy layers.

Before existing wells are included in the network of observation wells, therefore, information should be collected on their depth, diameter, construction, layers penetrated, and frequency of use.

2.4.2 Observation Wells and Piezometers

In addition to properly selected existing wells, a number of watertable observation wells should be placed at strategic points throughout the project area. They may be cased or uncased wells, depending on the stability of the soil at each location.

Uncased Wells

Uncased wells can easily be made with a hand auger as used in soil surveys, and can be 50 to 80 mm in diameter (Figure 2.12A). They can be used successfully in soils

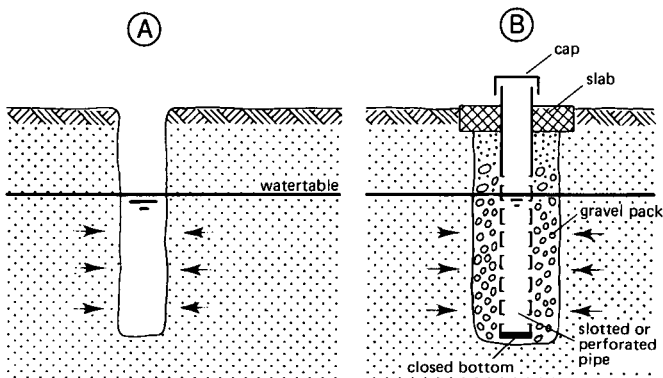

Figure 2.12 Observation wells:

A: Uncased well in stable soil; B: Cased well in unstable soil

that are stable enough to prevent the borehole from collapsing. They are also a cheap means of measuring watertable levels during the first phase of a project (reconnaissance survey), when the primary objective is to obtain a rough idea of the groundwater conditions in the project area.

Cased Wells

When making an observation well in unstable soil, one has to use a temporary casing, say 80 or 100 mm in diameter. The casing prevents sloughing and caving and makes it possible to bore a hole that is deep enough to ensure that it always holds water. Whatever casing material is locally available can be used: sheet metal, drain pipe, or standard commercial types of well casing (steel or PVC).

One starts making a borehole by hand auger or other light-weight boring equipment until one reaches the watertable. After lowering a casing, at least 80 mm in diameter, into the hole, one deepens the hole by bailing out the material inside the casing. When there is difficulty in keeping the sand from heaving inside the casing, this can be overcome by adding water to keep the water level in the pipe above the water level in the water-bearing layer.

When the borehole has reached the required depth, a pipe at least 25 mm in diameter is then lowered inside the casing to the bottom of the hole. Centering this pipe in the casing is important. The pipe's lower end must contain slots or perforations over a length equal to the distance over which the watertable is suspected to fluctuate.

The next step is to fill the space between the pipe and the casing (annular space) with graded coarse sand or fine gravel up to some distance above the upper limit of the slots or perforations; the remaining annular space can be backfilled with parent materials. A properly placed gravel pack facilitates the flow of groundwater into the pipe, and vice versa, and prevents the slots or perforations from becoming clogged by fine particles like clay and silt.

Finally, one pulls out the casing and places a concrete slab around the pipe to protect it from damage (Figure 2.12B).

A gravel pack is not always needed (e.g. if the whole soil profile consists of sand and gravel, free of silt and clay). Wrapping a piece of jute or cotton around the perforated part of the pipe may then suffice. It is advisable to remove any muddy water from the completed well by bailing.

Piezometers

A piezometer is a small-diameter pipe, driven into, or placed in, the subsoil so that there is no leakage around the pipe and all water enters the pipe through its open bottom. Piezometers are particularly useful in project areas where artesian pressures are suspected or in irrigated areas where the rate of downward flow of water has to be determined. A piezometer indicates only the hydrostatic pressure of the groundwater at the specific point in the subsoil at its open lower end.

In a partly saturated homogeneous sand layer, vertical flow components are usually lacking or are of such minor importance that they can be neglected. Hence, at any depth in such a layer, the hydraulic head corresponds to the watertable height; in other words, in measuring the watertable, it makes no difference how far the piezometer penetrates into the sand layer, as is shown in Figure 2.13A. In such cases, a single piezometer will suffice.

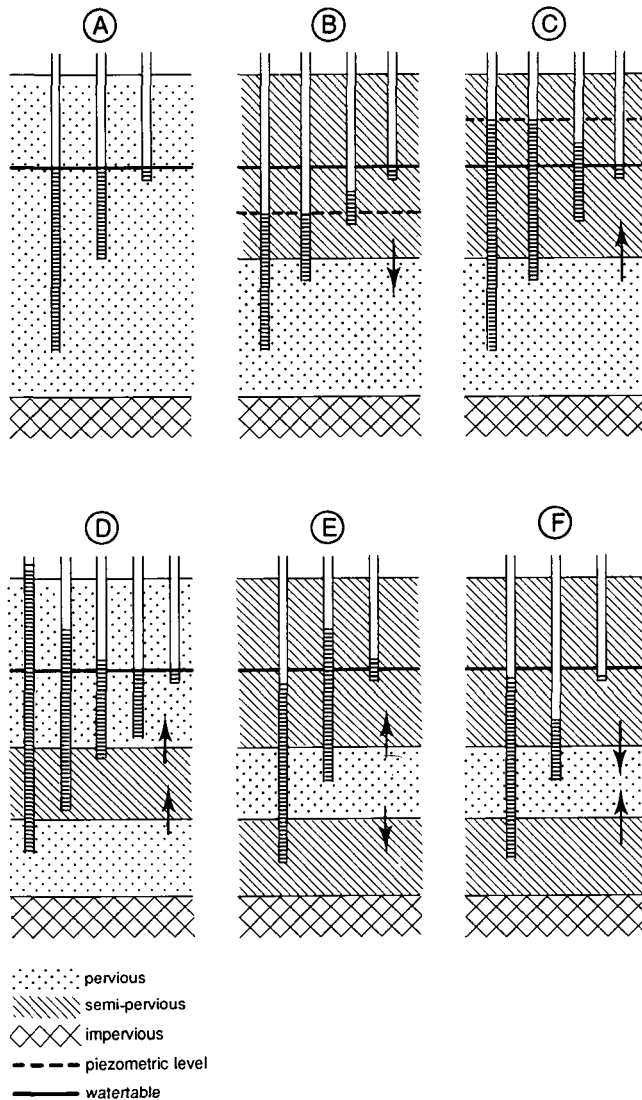

Figure 2.13 Examples of water levels in piezometers for different conditions of soil and groundwater

The same applies to a fully saturated confined sand layer. As it is generally assumed that the flow of groundwater through such a layer is essentially horizontal and that vertical flow components can be neglected, the distribution of hydraulic head in the layer is the same everywhere in the vertical plane. It suffices therefore to place only one piezometer in such a layer. Its water level is known as the hydraulic head of the layer, or the piezometric head or the potential head (Chapter 7).

In stratified soils, piezometers are useful in determining whether the groundwater is moving upward or downward. They are also useful in determining whether any natural drainage occurs in the project area. The piezometers of Figure 2.13B and F

indicate that there is natural drainage through the sand layer.

Since the flow of groundwater through confining layers (clay, loamy clay, clay loam, silty clay loam) is mainly vertical, the water level in a piezometer that penetrates into such a layer is a function of its depth of penetration (Figure 2.13B, C, and D).

Piezometers can be installed by driving or jetting them into position with a high-velocity water jet. If more than a few piezometers are to be installed, the jetting technique is recommended. Although this technique is fast, a disadvantage is that it does not provide precise information on the pierced materials, unless the piezometers are installed at the location of a borehole whose log is available. Another method of installing piezometers is to make a borehole 100 to 200 mm in diameter and then install three or four piezometers at different depths (Figure 2.14). To prevent leakage, care should be taken that pierced clay layers are properly sealed.

The lower end of a piezometer can easily become clogged by fine materials that enter the pipe. This can be avoided by perforating the lower 0.3 to 0.5 m of the pipe. To prevent fine soil particles from clogging the tiny holes, some jute or cotton can be wrapped around the perforations and the lower open end sealed with a plug. Graded coarse sand or fine gravel placed around the perforated part of the pipe will facilitate the flow of water into the pipe and vice versa. Strictly speaking, a perforated pipe cannot be called a piezometer, but because the perforations cover only the lower few decimetres of the pipe, we shall retain the term piezometer.

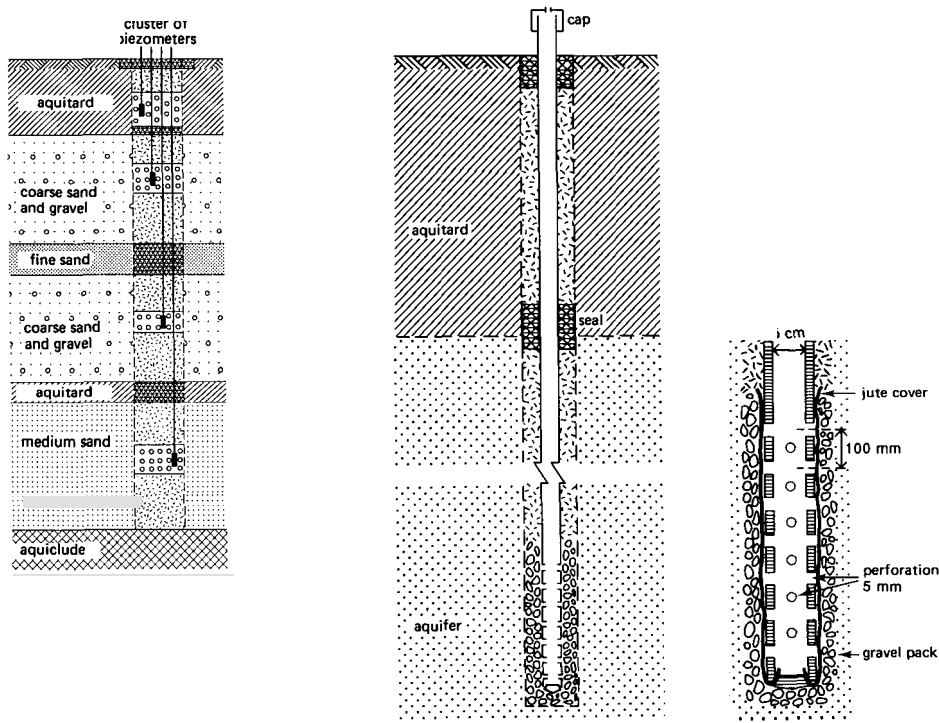

Figure 2.14 Multiple piezometer well and the cross-section of a piezometer

2.4.3 Observation Network

Layout

To save costs, observation wells and piezometers should be installed concurrently with soil borings that are needed to explore the shallow subsurface. These borings are usually made on a rectangular grid pattern that is laid out on the basis of information on topography, geology, soils, and hydrology collected during the early phase of the project. Figure 2.15 shows some examples of grid systems.

Soil borings should be spaced rather close together to make it possible to correlate subsurface layers. It is not necessary to transform each soil boring into an observation well because the watertable is a smooth surface. Nevertheless, abrupt changes in the configuration of the watertable do occur, due to discontinuities of soil layers, outflow of groundwater into streams, pumping from wells, and local irrigation. So, in planning a network of observation wells, one should note that they will be required:

- Along, and perpendicular to, lines of suspected groundwater flow;
- At locations where changes in the slope of the watertable occur or are suspected;
- On the banks of streams or other open water courses and along lines perpendicular to them;
- In areas where shallow watertables occur or can be expected in the future (areas with artesian pressure and areas with a high intensity of irrigation);
- Along and perpendicular to the (project) area's boundaries.

Surface water bodies in direct hydraulic contact with the groundwater should be included in the network. These surface waters are either fed by the groundwater or they are feeding the groundwater (Figure 2.16A and B). If the watertable lies below the bottom of the stream, the water level of the stream does not represent any point of the watertable (Figure 2.16C). The stream is then losing water that percolates

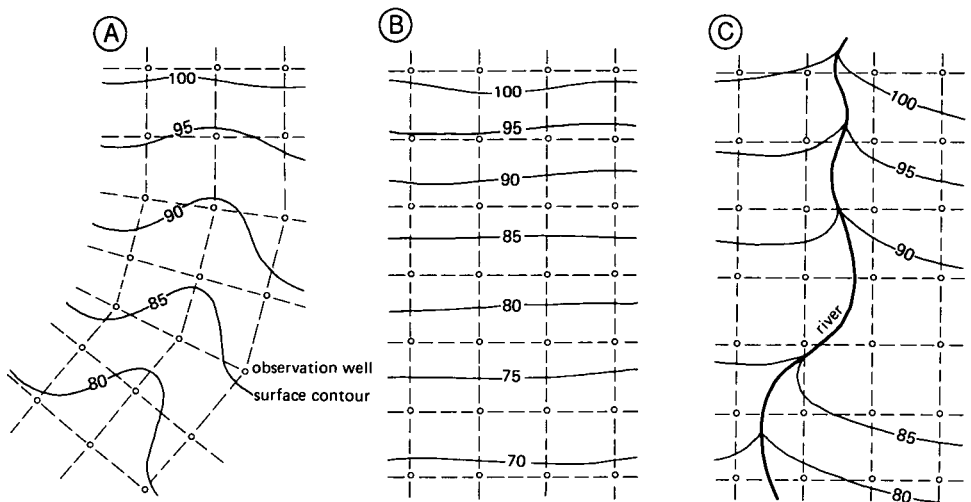
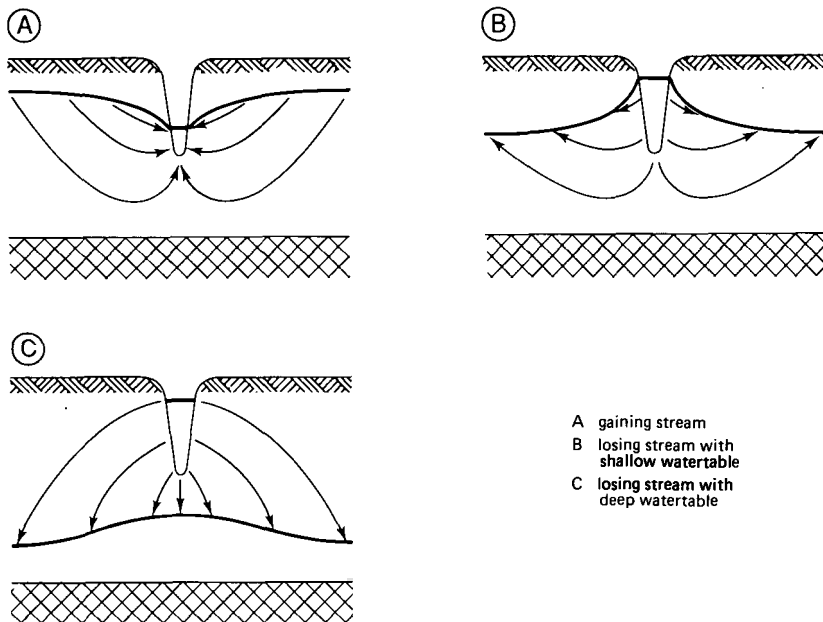

Figure 2.15 Different layouts of grid systems:

A: For a narrow valley; B: For a uniformly sloping area; C: For an almost level alluvial plain



- A gaining stream
- B losing stream with shallow watertable
- C losing stream with deep watertable

Figure 2.16 Gaining and losing streams

through the unsaturated zone to the deep watertable. A local mound is built up under the stream and its height can be measured by placing an observation well on the bank of the stream.

Water levels of streams or other water courses represent local mounds or depressions in the watertable and consequently are of great importance in a study of groundwater conditions. At strategic places in these water courses, therefore, staff gauges should be installed.

Density

No strict rule can be given as to the density of the observation network, because this depends entirely on the topographic, geological, and hydrological conditions of the area, and on the type of survey (reconnaissance, semi-detailed, detailed). As the required accuracy is generally inversely proportional to the size of the area, the relation given in Table 2.1 may serve as a rough guide.

In areas where the subsurface geology is fairly uniform, the watertable is usually smooth and there will be no abrupt changes. In such areas, the observation wells can be spaced farther apart than in areas where the subsurface geology is heterogeneous. Near lines of recharge or discharge (e.g. streams or canals), the spacing of the wells could be decreased in approximately the following sequence: 1000, 500, 250, 100, 40, 15, 5 m.

Depth

The depth of observation wells should be based on the expected lowest groundwater level. This will ensure that the wells do not fall dry in the dry season and that readings

Table 2.1 Relation between size of area and number of observation points

Size of area under study (ha)	No. of observation points	No. of observation points per 100 ha
100	20	20
1000	40	4
10 000	100	1
100 000	300	0.3

can be taken throughout a full hydrological year. The lowest water level can only be estimated, unless data from previous investigations are available. Generally, watertables deeper than about 3 m are not interesting from the viewpoint of planning a drainage system. Observation wells to this depth are therefore adequate in most flat lands. In areas with a rolling topography, deeper observation wells may be needed on the topographic highs to obtain a complete picture of the groundwater conditions.

In stratified soils and particularly in areas where artesian pressure exists or can be suspected, a number of deep piezometers are needed in addition to the shallow ones. No rule can be given as to how many of these should be placed or how deep they should be, because this depends on the hydrogeological conditions in the area. It is a matter of judgement as the investigations proceed. In profiles as shown in Figure 2.13B and C, double piezometer wells may suffice: one in the covering low-permeable layer and the other in the underlying sand layer.

In many alluvial plains, the covering layer is made of alternating layers of heavy and light-textured materials, or even peat. The total thickness of this layer can be many metres. In this case, a multipiezometer well can best be made, containing 3 to 5 piezometers placed at different depths (e.g. at 2, 5, 8, 12, and 15 m). The deepest piezometer should be placed in the underlying coarse sand layer, where groundwater is under artesian pressure. It will be obvious that, in making such wells, one will need power augers or jetting equipment.

Well Elevations

To determine the elevation of the observation wells and piezometers and thus be able to correlate watertable levels with land surface levels, a levelling survey must be made.

Water levels in the wells are measured from a fixed measuring point, which, for cased wells, can be the rim of the casing; for uncased wells, a measuring point must be made (e.g. a piece of steel, wood, or stone).

2.4.4 Measuring Water Levels

Methods

Water-level measurements can be taken in various ways (Figure 2.17):

- The wetted tape method (Figure 2.17A): A steel tape (calibrated in millimetres), with a weight attached to it, is lowered into the pipe or borehole to below the water

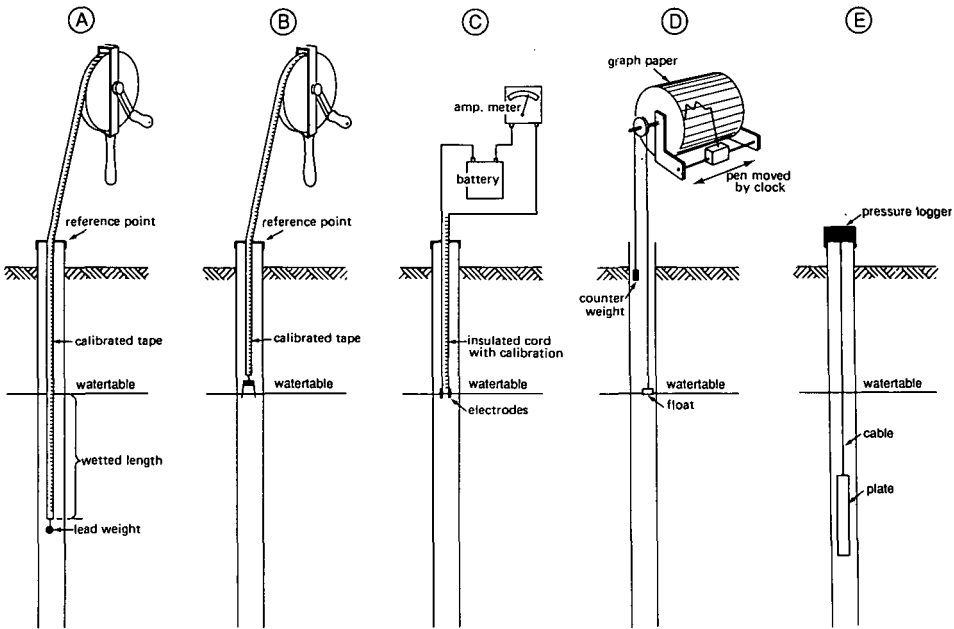

Figure 2.17 Various ways of measuring depth to water level in wells or piezometers

- level. The lowered length of tape from the reference point is noted. The tape is then pulled up and the length of its wetted part is measured. (This is facilitated if the lower part of the tape is chalked.) When the wetted length is subtracted from the total lowered length, this gives the depth to the water level below the reference point;
- With a mechanical sounder (Figure 2.17B): This consists of a small steel or copper tube (10 to 20 mm in diameter and 50 to 70 mm long), which is closed at its upper end and connected to a calibrated steel tape. When lowered into the pipe, it produces a characteristic plopping sound upon hitting the water. The depth to the water level can be read directly from the steel tape;
 - With an electric water-level indicator (Figure 2.17C): This consists of a double electric wire with electrodes at their lower ends. The upper ends of the wire are connected to a battery and an indicator device (lamp, mA meter, sounder). When the wire is lowered into the pipe and the electrodes touch the water, the electrical circuit closes, which is shown by the indicator. If the wire is attached to a calibrated steel tape, the depth to the water level can be read directly;
 - With a floating level indicator or recorder (Figure 2.17D): This consists of a float (60 to 150 mm in diameter) and a counterweight attached to an indicator or recorder. Recorders can generally be set for different lengths of observation period. They require relatively large pipes. The water levels are either drawn on a rotating drum or punched in a paper tape;
 - With a pressure logger or electronic water-level logger (Figure 2.17E): This measures and records the water pressure at one-hour intervals over a year. The pressure recordings are controlled by a microcomputer and stored in an internal, removable memory block. At the end of the observation period or when the memory block

- has reached capacity, it is removed and replaced. The recorded data are read by a personal computer. Depending on the additional software chosen, the results can be presented raw or in a calculated form. Pressure loggers have a small diameter (20 to 30 mm) and are thus well suited for measurements in small-diameter pipes;
- The water levels of open water surfaces are usually read from a staff gauge or a water-level indicator installed at the edge of the water surface. A pressure logger is most convenient for this purpose, because no special structures are required; the cylinder need only be anchored in the river bed.

Frequency of Measurements

The watertable reacts to the various recharge and discharge components that characterize a groundwater system and is therefore constantly changing. Important in any drainage investigation are the (mean) highest and the (mean) lowest watertable positions, as well as the mean watertable of a hydrological year. For this reason, water-level measurements should be made at frequent intervals for at least a year. The interval between readings should not exceed one month, but a fortnight may be better. All measurements should, as far as possible, be made on the same day because this gives a complete picture of the watertable.

Each time a water-level measurement is made, the data should be recorded in a notebook. It is advisable to use pre-printed forms for this purpose. An example is shown in Figure 2.18. Even better is to enter the data in a computerized database system. Recorded for each observation are: date of observation, observed depth of the water level below the reference point, calculated depth below ground surface (for free watertables only), and calculated water-level elevation (with respect to a general datum plane, e.g. mean sea level). Other particulars should also be noted (e.g. number of the well, its location, depth, surface elevation, reference point elevation).

If one wants to study the effect that a rainshower or an irrigation application has on the watertable, daily or even continuous readings may be needed. A pressure logger or an automatic recorder should then be installed in a representative large-diameter well; depending upon the type of recorder selected the well should have a certain minimum diameter, e.g. 7 cm.

2.4.5 Groundwater Quality

For various reasons, a knowledge of the groundwater quality is required. These are:

- Any lowering of the watertable may provoke the intrusion of salty groundwater from adjacent areas, or from the deep underground, or from the sea. The drained area and its surface water system will then be charged daily with considerable amounts of dissolved salts;
- The disposal of the salty drainage water into fresh-water streams may create environmental and other problems, especially if the water is used for irrigation and/or drinking;
- In arid and semi-arid regions, soil salinization is directly related to the depth of the groundwater and to its salinity;
- Groundwater quality dictates the type of cement to be used for hydraulic structures, especially when the groundwater is rich in sulphates;

GENERAL DATA OBSERVATION POINT NO.....

MAP NO. COORDINATES: X = Y =

MUNICIPALITY PROVINCE

OWNER INSTALLATION DATE TYPE¹

DEPTH SCREENED PART AQUIFER TYPE²

WELL LOG: FILE NO. WATER SAMPLES: FILE No.

SURFACE ELEVATION REFERENCE POINT ELEVATION

OBSERVATIONS

DATE	READING ³	ELEVATION ⁴	DEPTH ⁵	REMARKS ⁶

- 1 e.g. village well, open borehole, piezometer
- 2 e.g. unconfined aquifer, semi-confined aquifer, semi-pervious covering layer
- 3 with respect to reference point
- 4 with respect to general datum, for example mean sea level
- 5 below ground surface (for phreatic levels only)
- 6 data on water sample, irrigation, water at the surface, flow from wells, water withdrawal (pumping), etc.

Figure 2.18 Example of a form for recording water levels

– Agricultural crops are affected by groundwater quality if the groundwater approaches the rootzone.

Sources of Salinity

All groundwater contains salts in solution. The type of salts depends on the geological environment, the source of the groundwater, and its movement. The weathering of primary minerals is the direct source of salts in groundwater. Bicarbonate (HCO₃)

is usually the primary anion in groundwater and forms as a result of the solution of carbon dioxide in water. Carbon dioxide is a particularly active weathering agent for such source rocks as limestone and dolomite.

Sodium in the water originates from the weathering of feldspars (albite), clay minerals, and the solution of evaporites (halite and mirabilite). Evaporites are also the major natural source of chloride in groundwater, while sulphate originates from the oxidation of sulphide ores or the solution of gypsum and anhydrite. Such primary minerals as amphiboles (hornblende), apatite, fluorite, and mica are the sources of fluoride in groundwater. The mineral tourmaline is the source of boron.

In the groundwater of coastal and delta plains, the sea is the source of salinity.

Groundwater quality is also related to the relief of the area. Fresh groundwater usually occurs in topographic highs which, if composed of permeable materials, are areas of recharge. On its way to topographic lows (areas of discharge), the groundwater becomes mineralized through the solution of minerals and ion exchange. Groundwater salinity varies with the texture of sediments, the solubility of minerals, and the contact time. Groundwater salinity tends to be highest where the movement of the groundwater is least, so salinity usually increases with depth.

Irrigation also acts as a source of salts in groundwater. It not only adds salts to the soil, but also dissolves salts in the root zone. Water that has passed through the root zone of irrigated land usually contains salt concentrations several times higher than that of the originally applied irrigation water.

Evapotranspiration tends to concentrate the salinity of groundwater. Highly saline groundwater can therefore be found in arid regions with poor natural drainage and consequently a shallow watertable.

The choice of a method for measuring groundwater salinity depends on the reason for making the measurements, the size of the area – and thus the number of samples to be taken and measured – and the time and the budget available for doing the work.

Once the network of observation wells, boreholes, and piezometers has been established, water samples should be taken in a representative number of them. Sampling can often best be combined with other drainage investigations, such as measuring hydraulic conductivity in open boreholes. The sample is then taken after a sufficient quantity of water has been bailed from the hole.

Electrical Conductivity

A rapid determination of the salinity of groundwater can be made by measuring its electrical conductivity, EC. Conductivity is preferred rather than its reciprocal, resistance, because the EC increases with the salt content. Electrical conductivity defines the conductance of a cubic centimetre of water at a standard temperature of 25°C. It is expressed in decisiemens per metre (dS/m), formerly in millimhos per centimetre (mmhos/cm). Expressing the results in terms of specific electrical conductivity makes the determination independent of the size of the water sample. Conductivity cannot simply be related to the total dissolved solids because groundwater contains a variety of ionic and undissociated species. An approximate relation for most groundwater with an EC-value in the range of 0.1 to 5 dS/m is: $1 \text{ dS/m} \approx 640 \text{ mg/l}$ (Chapter 15).

Major Chemical Constituents

The EC expresses the total concentration of soluble salts in the groundwater, but gives no information on the types of salts. Needed for this purpose are laboratory determinations of such constituents as calcium, magnesium, sodium, carbonate, bicarbonate, chloride, sulphate, and nitrate. Since these chemical analyses are costly, not all the observation points need be sampled for detailed analysis. A selection of sites should be made, based on the results of the EC measurements.

For more information on groundwater quality reference is made to Hem 1970.

2.5 Processing the Groundwater Data

Before any conclusions can be drawn about the cause, extent, and severity of an area's drainage problems, the raw groundwater data on water levels and water quality have to be processed. They then have to be related to the geology and hydrogeology of the area. The results, presented in graphs, maps, and cross-sections, will enable a diagnosis of the problems to be made.

We shall assume that such basic maps as topographic, geological, and pedological maps are available.

The following graphs and maps have to be prepared that are discussed hereunder:

- Groundwater hydrographs;
- Watertable-contour map;
- Depth-to-watertable map;
- Watertable-fluctuation map;
- Head-differences map;
- Groundwater-quality map.

2.5.1 Groundwater Hydrographs

When the amount of groundwater in storage increases, the watertable rises; when it decreases, the watertable falls. This response of the watertable to changes in storage can be plotted in a hydrograph (Figure 2.19). Groundwater hydrographs show the water-level readings, converted to water levels below ground surface, against their corresponding time. A hydrograph should be plotted for each observation well or piezometer.

In land drainage, it is important to know the rate of rise of the watertable, and even more important, that of its fall. If the groundwater is not being recharged, the fall of the watertable will depend on:

- The transmissivity of the water-transmitting layer, KH ;
- The storativity of this layer, S ;
- The hydraulic gradient, dh/dx .

After a period of rain (or irrigation) and an initial rise in groundwater levels, they then decline, rapidly at first, and then more slowly as time passes because both the hydraulic gradient and the transmissivity decrease. The graphical representation of

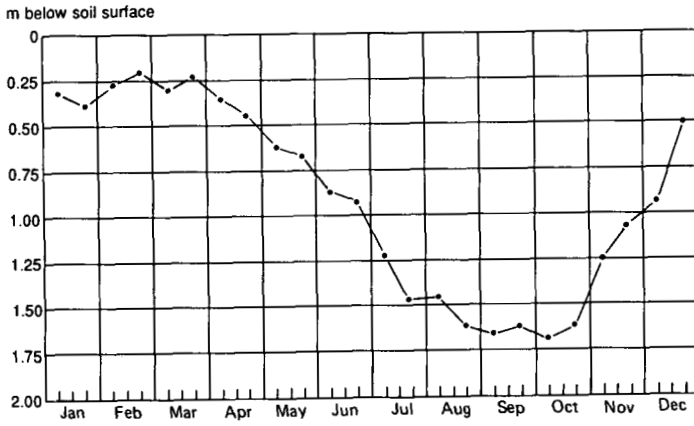

Figure 2.19 Hydrograph of a watertable observation well

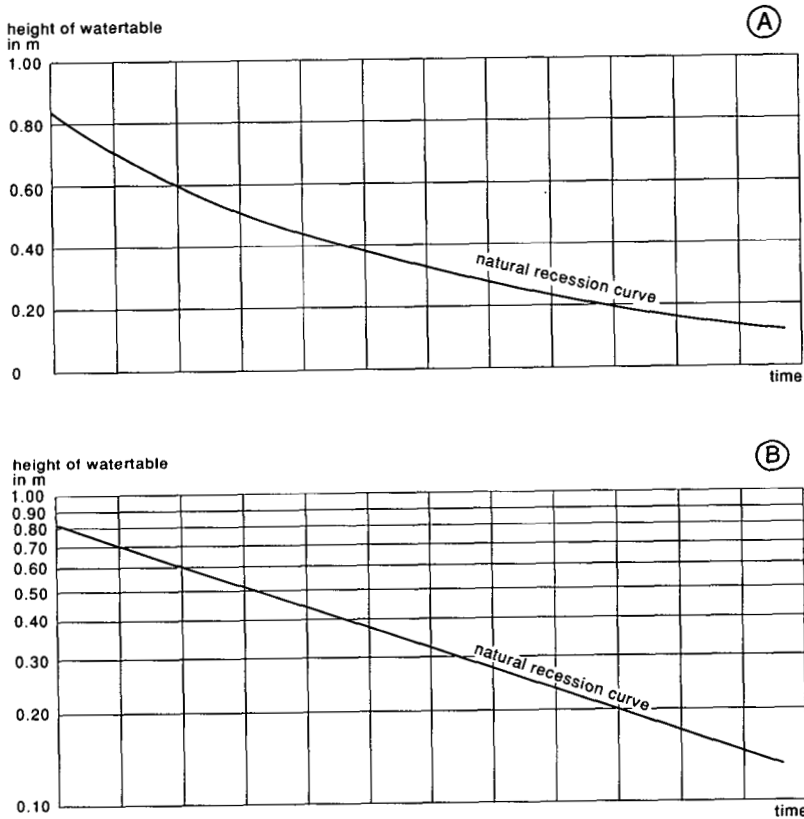

Figure 2.20 Natural recession of groundwater level:
A: Linear scale; B: Logarithmic scale

the watertable decline is known as the natural recession curve. It can be shown that the logarithm of the watertable height decreases linearly with time. Hence, a plot of the watertable height against time on semi-logarithmic paper gives a straight line (Figure 2.20). Groundwater recession curves are useful in studying changes in groundwater storage and in predicting future groundwater levels.

2.5.2 Groundwater Maps

Watertable-Contour Map

A watertable-contour map shows the elevation and configuration of the watertable on a certain date. To construct it, we first have to convert the water-level data from the form of depth below surface to the form of watertable elevation (= water level height above a datum plane, e.g. mean sea level). These data are then plotted on a topographic base map and lines of equal watertable elevation are drawn. A proper contour interval should be chosen, depending on the slope of the watertable. For a flat watertable, 0.25 to 0.50 m may suit; in steep watertable areas, intervals of 1 to 5 m or even more may be needed to avoid overcrowding the map with contour lines.

The topographic base map should contain contour lines of the land surface and should show all natural drainage channels and open water bodies. For the given date, the water levels of these surface waters should also be plotted on the map. Only with these data and data on the land surface elevation can watertable contour lines be drawn correctly (Figure 2.21).

To draw the watertable-contour lines, we have to interpolate the water levels between the observation points, using the linear interpolation method as shown in Figure 2.22.

Instead of preparing the map for a certain date, we could also select a period (e.g. a season or a whole year) and calculate the mean watertable elevation of each well for that period. This has the advantage of smoothing out local or occasional anomalies in water levels.

A watertable-contour map is an important tool in groundwater investigations because, from it, one can derive the gradient of the watertable (dh/dx) and the direction

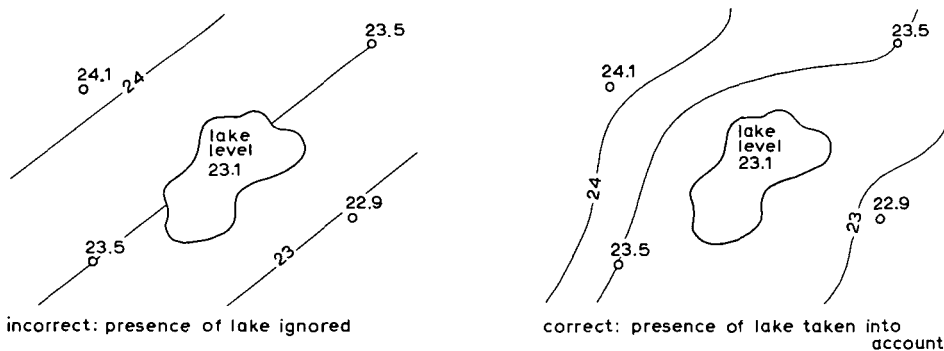

Figure 2.21 Example of watertable-contour lines
A: Incorrectly drawn; B: Correctly drawn

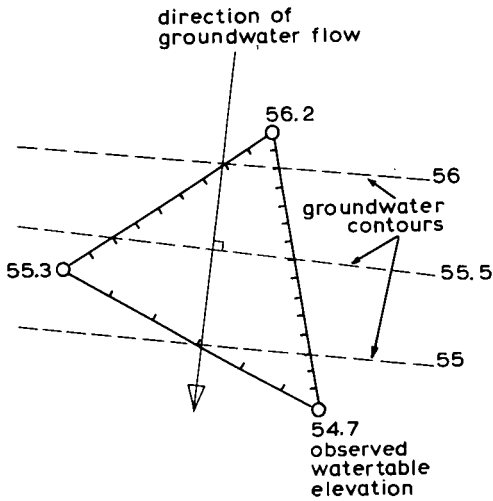

Figure 2.22 Construction of watertable-contour lines by linear interpolation

of groundwater flow, which is perpendicular to the watertable-contour lines.

Figure 2.23A presents an example of a topographical base map of an irrigated area with its grid system of observation points; Figure 2.23B shows the watertable contour map.

For artesian or irrigation areas in which two or more piezometers have been installed at the same location, with the bottom of each at a different depth in a different soil layer (as in Figure 2.14), contour maps of the hydraulic head in each layer should be made.

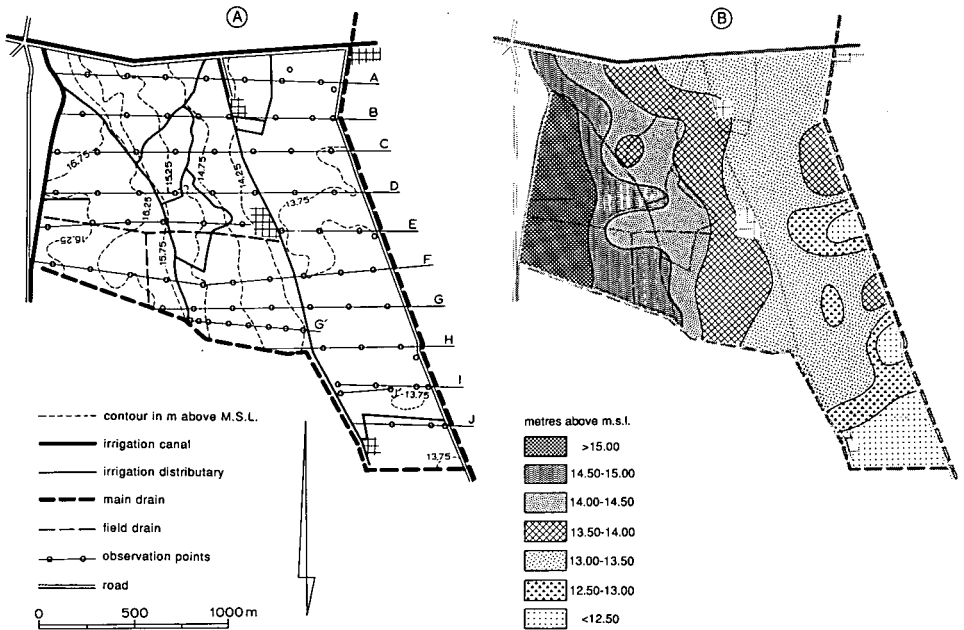

Figure 2.23 A: Topographic base map of an irrigated area; B: Its watertable contour map

Depth-to-Watertable Map

A depth-to-watertable map, or isobath map, as these names imply, shows the spatial distribution of the depth of the watertable below the land surface. It can be prepared in two ways. The water-level data from all observation wells for a certain date are first converted to water levels below land surface. (The reference point from which the readings were taken need not necessarily be the land surface.) One then plots the converted data on a topographic base map and draws isobaths or lines of equal depth to groundwater (Figure 2.24). A suitable contour interval could be 0.50 m.

The other way of preparing this map is by superimposing a watertable-contour map made for a certain date on the topographic base map showing contour lines of the land surface. From the two families of contour lines, the difference in elevation at contour intersections can be read. These data are then plotted on a clean topographic map, and the isobaths are drawn.

Depth-to-watertable maps are usually prepared for critical dates (e.g. when farming operations have to be performed or when the crops are expected to be most sensitive to high watertables). Instead of preparing the isobath map for a special date, one can also choose a season and prepare a map showing the mean depth-to-watertable for that season. Periods or seasons during which the watertables are highest and lowest can be read from groundwater hydrographs (Figure 2.19)

Watertable-Fluctuation Map

A watertable-fluctuation map is a map that shows the magnitude and spatial distribution of the change in watertable over a period (e.g. a whole hydrological year). Using such graphs as shown in Figure 2.19, we calculate the difference between the highest and the lowest watertable height (or preferably the difference between the mean highest and the mean lowest watertable height for the two seasons). We then plot these data on a topographic base map and draw lines of equal change in watertable, using a convenient contour interval.

A watertable-fluctuation map is a useful tool in the interpretation of drainage

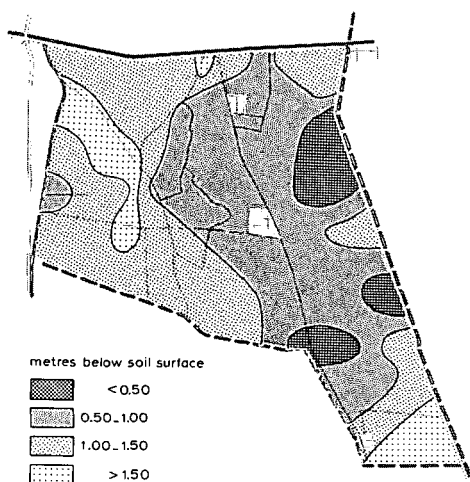

Figure 2.24 Example of a depth-to-watertable (or isobath) map

problems in areas with large watertable fluctuations, or in areas with poor natural drainage (or upward seepage) and permanently high watertables (i.e. areas with minor watertable fluctuations).

Head-Differences Map

A head-differences map is a map that shows the magnitude and spatial distribution of the differences in hydraulic head between two different soil layers. Let us assume a common situation as shown in Figure 2.13B or 2.13C. We then calculate the difference in water level between the shortest piezometer and the longest, and plot the result on a map. After choosing a proper contour interval (e.g. 0.10 or 0.20 m), we draw lines of equal head difference.

Another way of drawing such a map is to superimpose a watertable-contour map on a contour map of the piezometric surface of the underlying layer. We then read the head differences at contour line intersections, plot these on a base map, and draw lines of equal head difference. The map is a useful tool in estimating upward or downward seepage.

Groundwater-Quality Map

A groundwater-quality or electrical-conductivity map is a map that shows the magnitude and spatial variation in the salinity of the groundwater. The EC values of all representative wells (or piezometers) are used for this purpose (Figure 2.25).

Groundwater salinity varies not only horizontally but also vertically; a zonation of groundwater salinity is common in many areas (e.g. in delta and coastal plains, and in arid plains). It is therefore advisable to prepare an electrical-conductivity map not only for the shallow groundwater but also for the deep groundwater.

Other types of groundwater-quality maps can be prepared by plotting different quality parameters (e.g. Sodium Adsorption Ratio (SAR) values; see Chapter 15).

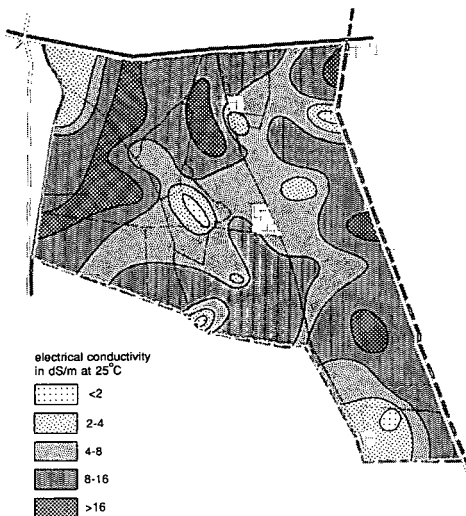

Figure 2.25 Example of a groundwater-quality map of shallow groundwater

2.6 Interpretation of Groundwater Data

It must be emphasized that a proper interpretation of groundwater data, hydrographs, and maps requires a coordinate study of a region's geology, soils, topography, climate, hydrology, land use, and vegetation. If the groundwater conditions in irrigated areas are to be properly understood and interpreted, cropping patterns, water distribution and supply, and irrigation efficiencies should be known too.

2.6.1 Interpretation of Groundwater Hydrographs

Watable changes are of two kinds:

- Changes due to changes in groundwater storage;
- Changes due to other influences (e.g. changes in atmospheric pressure, deformation of the water-transmitting layer, earthquakes).

In drainage studies, we are primarily interested in watertable changes due to changes in groundwater storage because they are the result of the groundwater regime (i.e. the way by which the groundwater is recharged and discharged). Rising watertables indicate the periods when recharge is exceeding discharge and falling watertables the periods when discharge is exceeding recharge (Figure 2.26).

Rather abrupt changes in the amount of water stored in the subsoil will be found in land adjacent to stream channels because that land will be influenced by the rise and fall of the stream stage (Figure 2.27), and in areas of relatively shallow watertables influenced by precipitation or irrigation.

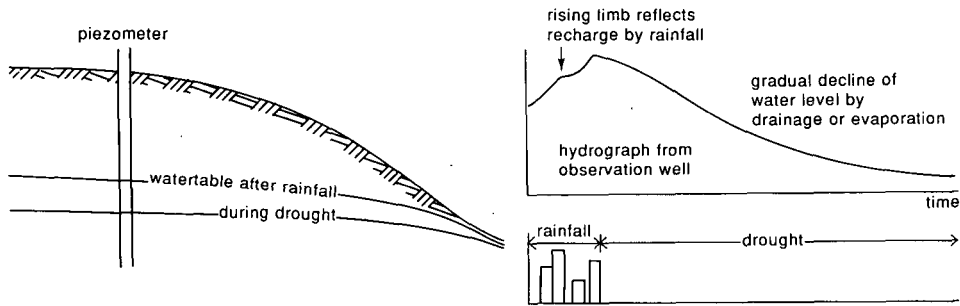

Figure 2.26 Groundwater hydrograph showing a rise of the watertable during recharge by rain and its subsequent decline during drought

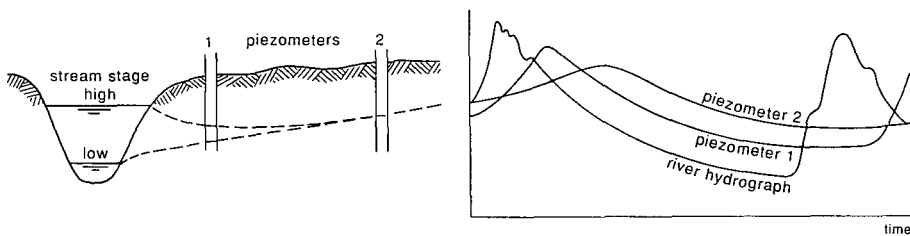

Figure 2.27 Influence of the stream stage on the watertable in adjacent land. Note that the influence diminishes with increasing distance from the stream

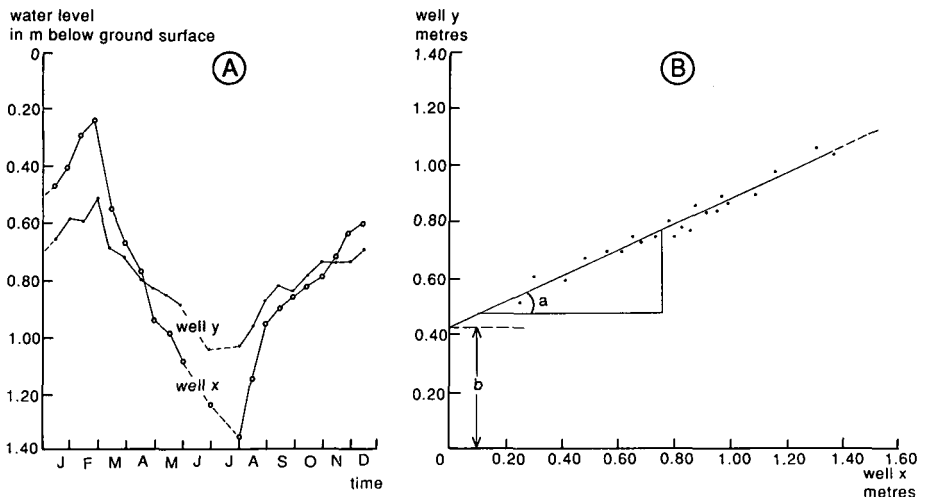

Figure 2.28 A: Hydrographs of observation wells x and y; B: Correlation of the water levels in these wells, showing the regression line obtained by a linear regression of y upon x

Although the effect of precipitation on the watertable is usually quite clear, an exact correlation often poses a problem because:

- Differences in drainable pore space of the soil layers in which the watertable fluctuates will cause the watertable to rise or fall unevenly;
- Part of the precipitation may not reach the watertable at all because it evaporates or because it is discharged as surface runoff and/or is stored in the zone of aeration (soil water);
- The groundwater-flow terms may result in a net recharge or a net discharge of the groundwater, thus affecting the watertable position.

The groundwater hydrographs of all the observation points should be systematically analyzed. A comparison of these hydrographs enables us to distinguish different groups of observation wells. Each well belonging to a certain group shows a similar response to the recharge and discharge pattern of the area. By a similar response, we mean that the water level in these wells starts rising at the same time, attains its maximum value at the same time, and, after recession starts, reaches its minimum value at the same time. The amplitude of the water level fluctuation in the various wells need not necessarily be exactly the same, but should show a great similarity (Figure 2.28A). Areas where such wells are sited can then be regarded as hydrological units (i.e. sub-areas in which the watertable reacts to recharge and discharge everywhere in the same way).

The water-level readings of a certain well in a group of wells can be correlated with those of another well in that group, as is shown in Figure 2.28B. To calculate the correlation of two wells, the method of linear regression is used (Chapter 6). If the two wells correlate satisfactorily, one of the two can be dropped from the network. Such an analysis may lead to the selection of a number of standard observation wells only, and the network can thus be reduced. From the water-level readings in these standard wells, which form the base network, the water levels in the other observation

Table 2.2 Hydrological sub-areas with their mean depths to groundwater for the wet and dry seasons, in m below soil surface

	Hydrological sub-area (groundwater depth group)					
	A	B	C	D	E	F
Mean depth to groundwater in the wet season	0.30	0.45	0.60	0.80	1.10	1.90
Mean depth to groundwater in the dry season	0.60	0.80	1.00	1.20	1.50	2.40

wells that were dropped can be calculated from the established regression equation.

For further evaluation of the groundwater conditions in each hydrological sub-area, we can calculate the mean depth to groundwater for the wet season and that for the dry season, using the water-level measurements of all wells in the sub-areas. Table 2.2 shows an example of such a grouping of levels.

Figure 2.29 shows the depth to groundwater for the hydrological sub-areas A, D, and F in an experimental field of sandy soils in the eastern part of The Netherlands over the period 1961 to 1967 (Colenbrander 1970).

Sub-area A is a typical seepage area characterized by shallow watertables that are influenced by a seasonal precipitation surplus. Sub-area F is a typical area with good natural drainage; seasonal rains do cause the watertable to rise, but seldom higher than 1.50 m below the ground surface. Sub-area D takes a somewhat intermediate position between the other two; the mean depths to groundwater in the wet and dry

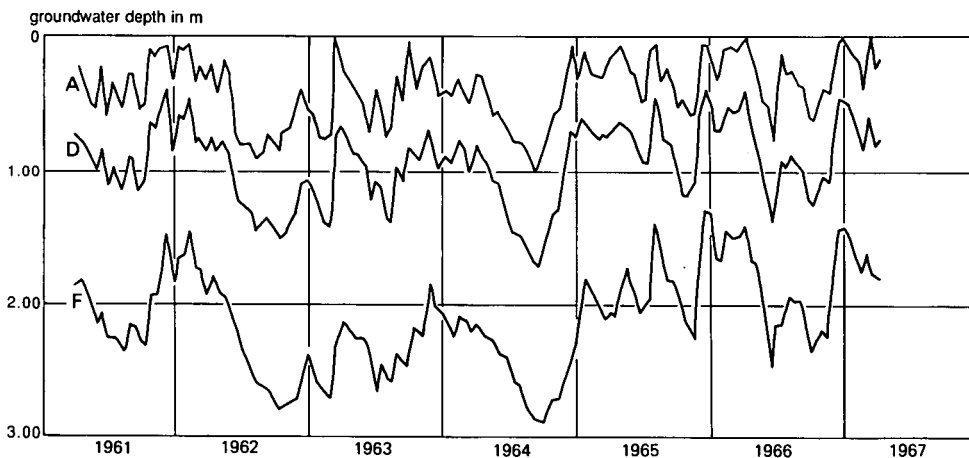

Figure 2.29 Mean depth to watertable in three homogeneous hydrological sub-areas over the period 1961 to 1967 (after Colenbrander 1970)

seasons (0.80 and 1.20 m, respectively) do not pose special problems to agriculture, but an incidental precipitation surplus during the wet season may cause the watertable to rise to about 0.50 m or less below the ground surface.

Variations in stream flow are closely related to the groundwater levels in land adjacent to a stream. Stream flow originating from groundwater discharge is known as groundwater runoff or base flow. During fair-weather periods, all stream flow may be contributed by base flow. To estimate the base flow from an area with fairly homogeneous hydrogeological conditions, the mean groundwater levels of the area are plotted against the stream flow during periods when all flow originates from groundwater. We thus obtain a rating curve of groundwater runoff for the area in question (Figure 2.30).

Groundwater hydrographs also offer a means of estimating the annual groundwater recharge from rainfall. This, however, requires several years of records on rainfall and watertables. An average relationship between the two can be established by plotting the annual rise in watertable against the annual rainfall (Figure 2.31). Extending the straight line until it intersects the abscis gives the amount of rainfall below which there is no recharge of the groundwater. Any quantity less than this amount is lost by surface runoff and evapotranspiration.

Percolating rainwater is not the only reason why watertables fluctuate. Daily fluctuations of the watertable may also be observed in coastal areas due to the tides. Sinusoidal fluctuations of groundwater levels in such areas occur in response to tides.

Finally, changes in atmospheric pressure produce fluctuations in water levels of wells that penetrate confined waterbearing layers. An increase in atmospheric pressure produces a decline of the water level, and vice versa. This phenomenon is due to the

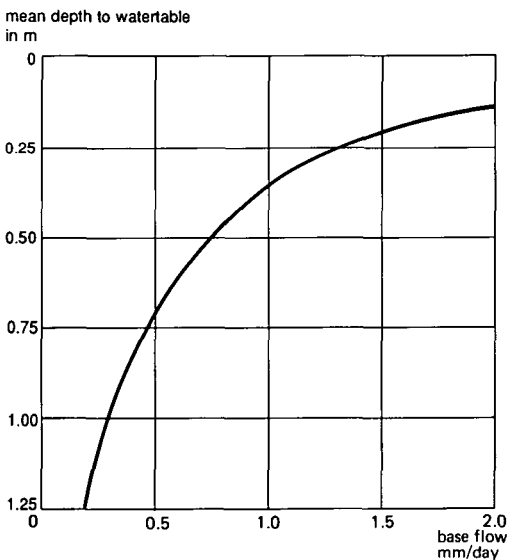

Figure 2.30 Rating curve: Relationship between mean depth to watertable and groundwater runoff (base flow)

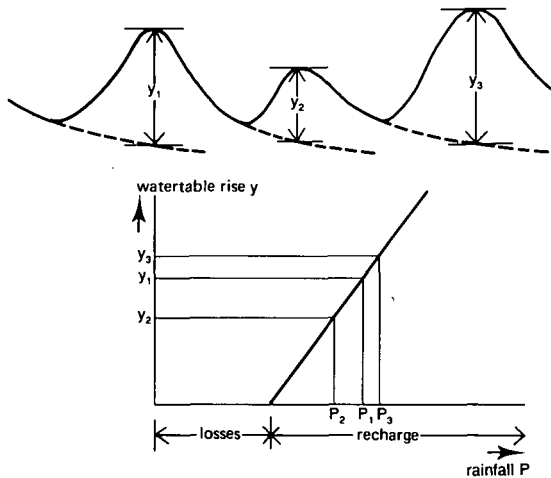

Figure 2.31 Relationship between annual groundwater recharge and rainfall

elasticity of these waterbearing layers.

Continuous or intermittent pumping from wells produces changes in the watertable (or piezometric surface) in the vicinity of such wells. This will be further elaborated in Chapter 10.

2.6.2 Interpretation of Groundwater Maps

Watertable-Contour Maps

Contour maps of the watertable are graphic representations of the relief and slope of the watertable. They are the basis for determining the direction and rate of groundwater flow, the drainage of groundwater from all sources, and the variations in percolation rates and in the permeability of the alluvial materials.

Under natural conditions, the watertable in homogeneous flat areas has little relief and is generally sloping smoothly and gently to low-lying zones of groundwater discharge. In most areas, however, minor relief features in the watertable are common; they consist of local mounds or depressions that may be natural or man-made (Figure 2.32). Groundwater flow is always in the downslope direction of the watertable and, if permeability is assumed to be constant, the fastest movement and largest quantity of groundwater flow are in the direction of maximum slope.

A local mound in the watertable may be due to local recharge of the groundwater by irrigation or by upward seepage. Local depressions may be due to pumping from wells or to downward seepage. Upward or downward seepage is common in alluvial plains underlain by karstic limestones. Buried sinkholes and karstic channels in the limestone are usually sites of recharge or discharge of the overlying alluvial deposits.

The topography of the area under study is important because it controls the configuration of the watertable. The shape of the watertable can be convex or concave. In an area dissected by streams and natural drainage channels, the watertable between adjacent streams (i.e. the interfluves) is convex. In the vicinity of a losing stream, it is concave (Figure 2.33).

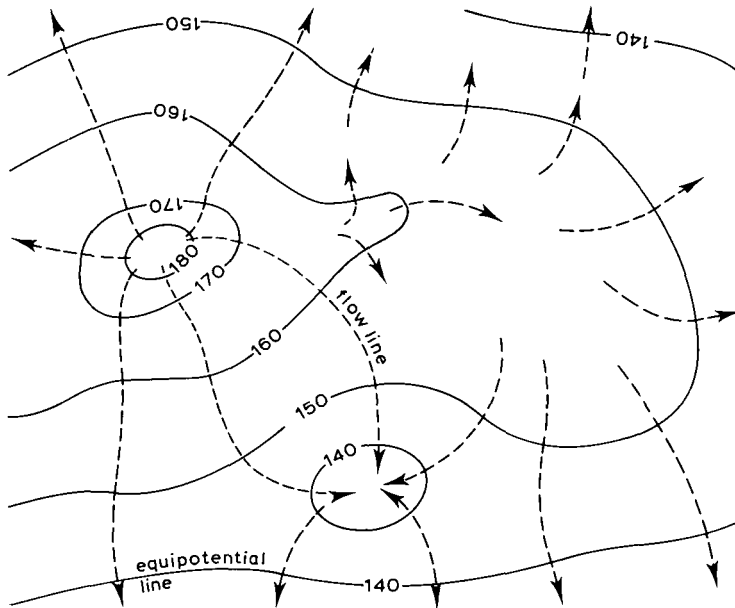

Figure 2.32 A watertable-contour map showing a local mound and a depression in the watertable and the direction of groundwater flow

In areas where a stream is losing water to the underground, the watertable contours have bends in downstream direction. At places where the contours are at right angles to the stream, groundwater is flowing neither towards nor from the stream but down the general slope of the watertable. In areas where groundwater is flowing into the stream, the watertable contours have bends in upstream direction.

The bends in watertable contours near streams and drainage channels may have different shapes due to differences in the resistance to radial flow; the longer and narrower the bends, the higher this flow resistance is. Obviously, to determine the shape of the bends, water-level readings in several observation wells in the near vicinity of the stream are required, as outlined earlier.

Ernst (1962) has presented an equation to estimate the value of the radial resistance, which is the resistance that groundwater has to overcome while flowing into a stream or drainage channel because of the contraction of the flow lines in the vicinity of the stream.

For a proper interpretation of a watertable-contour map, one has to consider not only the topography, natural drainage pattern, and local recharge and discharge patterns, but also the subsurface geology. More specifically, one should know the spatial distribution of permeable and less permeable layers below the watertable. For instance, a clay lens impedes the downward flow of excess irrigation water or, if the area is not irrigated, the downward flow of excess rainfall. A groundwater mound will form above such a horizontal barrier (Figure 2.34).

The surface of the first effective impermeable layer below the watertable can be undulating and, when viewed over greater distances, it can be dipping. At some places, the impermeable layer may rise to or close to the land surface. If such a ridge of tight

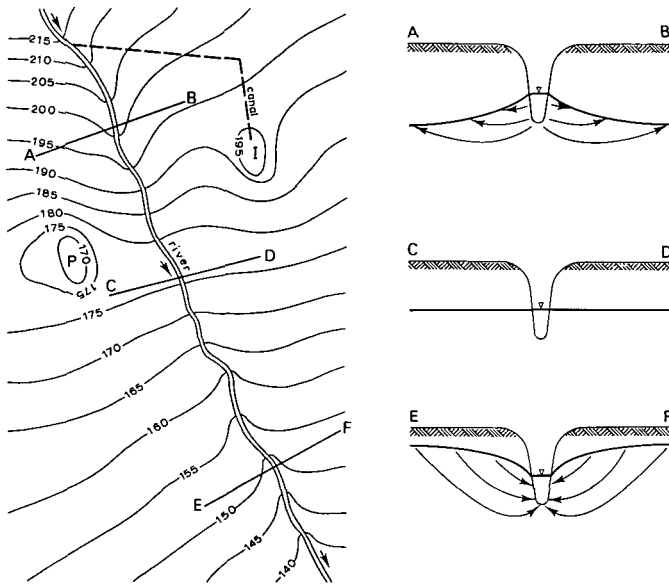

Figure 2.33 A watertable-contour map showing a stream that is losing water in its upstream part and gaining water in its downstream part; in its middle part, it is neither gaining nor losing water. I: Irrigation causes local mound in the watertable; P: Pumping causes local depression in the watertable

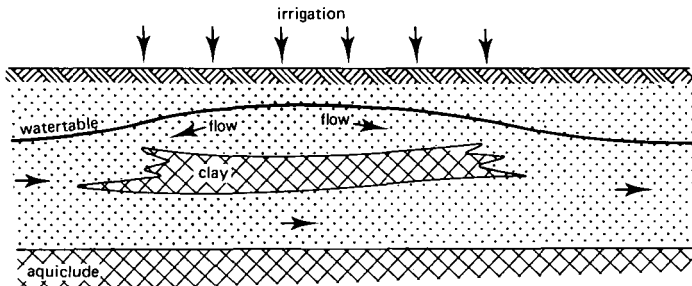

Figure 2.34 A clay lens under an irrigated area impedes the downward flow of excess irrigation water

clay occurs at right angles to the general groundwater flow, the natural drainage will be blocked (Figure 2.35).

Watertable-contour maps are graphic representations of the hydraulic gradient of the watertable. The velocity of groundwater flow (v) varies directly with the hydraulic gradient (dh/dx) and, at constant flow velocity, the gradient is inversely related to the hydraulic conductivity (K), or $v = -K(dh/dx)$ (Darcy's law). This is a fundamental law governing the interpretation of hydraulic gradients of watertables. (For a further discussion of this law, see Chapter 7.) Suppose the flow velocity in two cross-sections of equal depth and width is the same, but one cross-section shows a greater hydraulic gradient than the other, then its hydraulic conductivity must be lower. A steepening of the hydraulic gradient may thus be found at the boundary of fine-textured and coarse-textured material (Figure 2.36A), or at a fault where the thickness of the water-bearing layers changes abruptly (Figure 2.36B).

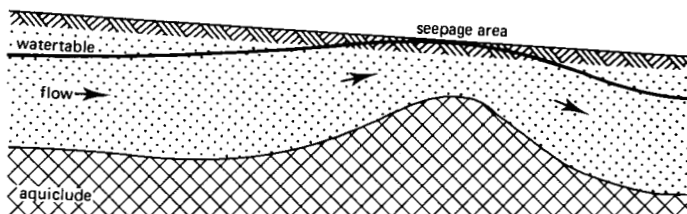

Figure 2.35 Effect of an impermeable barrier on the watertable

Characteristic groundwater conditions can be found in river plains. In the humid zones, such plains usually have the profile shown in Figure 2.37A. Silted-up former stream channels are common in these plains, and if their sand body is in direct contact with an underlying coarse sand and gravel layer whose groundwater is under pressure, they form important leaks in the low-permeable covering layer. Figure 2.37B shows the distribution of the piezometric head/watertable elevation at different depths in a row of piezometers perpendicular to the buried stream channel.

Depth-to-Watertable Maps

From our discussions so far, it will be clear that a variety of factors must be considered if one is to interpret a depth-to-groundwater or isobath map properly. Shallow watertables may occur temporarily, which means that the natural groundwater runoff cannot cope with an incidental precipitation surplus or irrigation percolation. They may occur (almost) permanently because the inflow of groundwater exceeds the outflow, or groundwater outflow is lacking as in topographic depressions. The depth and shape of the first impermeable layer below the watertable strongly affect the height of the watertable. To explain differences and variations in the depth to watertable, one has to consider topography, surface and subsurface geology, climate, direction and rate of groundwater flow, land use, vegetation, irrigation, and the abstraction of groundwater by wells.

Watertable-Fluctuation Maps

The watertable in topographic highs is usually deep, whereas in topographic lows it is shallow. This means that on topographic highs there is sufficient space for the watertable to change. This space is lacking in topographic lows where the watertable

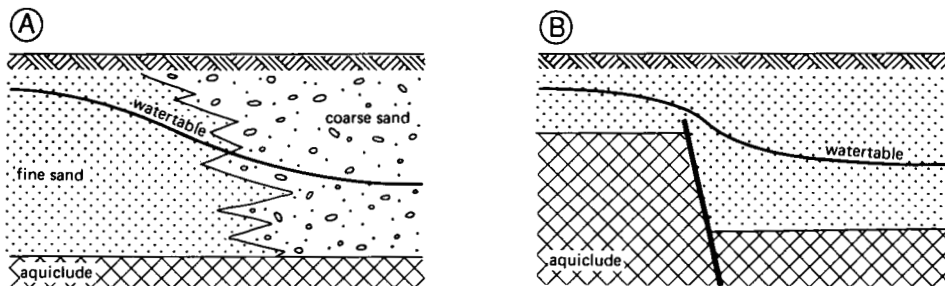

Figure 2.36 Examples of the effect on the hydraulic gradient
A: Of permeability; B: Of bed thickness

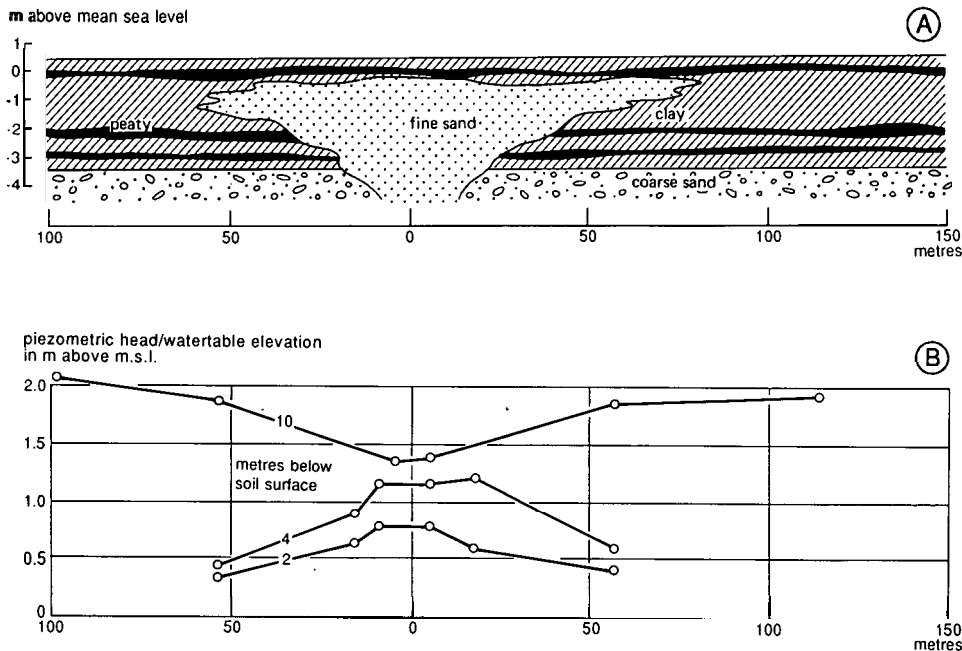

Figure 2.37 Characteristic groundwater condition in river plain

A: Cross-section of a Holocene silted-up former stream channel of the River Waal (after Verbraeck and de Ridder 1962); B: Distribution of hydraulic heads at 2, 4, and 10 m below ground surface along a line perpendicular to a sand-filled former river channel as shown in Figure 2.37A. The water level in the nearby River Waal at the time of observation was 3.70 m above mean sea level (after Colenbrander 1962)

is often close to the surface. Watertable fluctuations are therefore closely related to depth to groundwater.

Another factor to consider in interpreting watertable-fluctuation maps is the drainable pore space of the soil. The change in watertable in fine-textured soils will differ from that in coarse-textured soils, for the same recharge or discharge.

Head-Differences Maps

The difference in hydraulic head between the shallow and the deep groundwater is directly related to the hydraulic resistance of the low-permeable layer(s). Because such layers are seldom homogeneous and equally thick throughout an area, the hydraulic resistance of these layers varies from one place to another. Consequently, the head difference between shallow and deep groundwater varies. Local 'leaks' in low-permeable layers may result in anomalous differences in hydraulic heads, as was demonstrated in Figure 2.37B. The hydraulic resistance is especially of interest when one is defining upward seepage or natural drainage (Chapters 9 and 16) or the possibilities for tubewell drainage (Chapters 10 and 22).

Groundwater-Quality Maps

Spatial variations in groundwater quality are closely related to topography, geological

environment, direction and rate of groundwater flow, residence time of the groundwater, depth to watertable, and climate. Topographic highs, especially in the humid zones, are areas of recharge if their permeability is fair to good. The quality of the groundwater in such areas almost resembles that of rainwater. On its way to topographic lows (areas of discharge), the groundwater becomes more mineralized because of the dissolution of minerals. Although the water may be still fresh in discharge areas, its electrical conductivity can be several times higher than in recharge areas.

The groundwater in the lower portions of coastal and delta plains may be brackish to extremely salty, because of sea-water encroachment and the marine environment in which all or most of the mass of sediments was deposited. Their upper parts, which are usually topographic highs, are nowadays recharge areas and consequently contain fresh groundwater.

In the arid and semi-arid zones, shallow watertable areas, as can be found in the lower parts of alluvial fans, coastal plains, and delta plains, may contain very salty groundwater because of high rates of evaporation. Irrigation in such areas may contribute to the salinity of the shallow groundwater through the dissolution of salts accumulated in the soil layers.

Sometimes, however, irrigated land can have groundwater of much better quality than adjacent non-irrigated land. Because of the irrigation percolation losses, the watertable under the irrigated land is usually higher than in the adjacent non-irrigated land. Consequently, there is a continuous transport of salt-bearing groundwater from the irrigated to the non-irrigated land. This causes the watertable in the non-irrigated land to rise to close to the surface, where evapo(transpi)ration further contributes to the salinization of groundwater and soil (Chapter 15).

References

- Colenbrander, H.J. 1962. Een berekening van hydrologische bodemconstanten, uitgaande van een stationaire grondwaterstroming. In: De waterbehoefte van de Tielerwaard-West. Commissie ter bestudering van de waterbehoefte van de Gelderse landbouwgronden, Wageningen. pp. 55-59.
- Colenbrander, H.J. 1970. Waarneming en bewerking van grondwaterstand en bodemvochtgegevens. In: Hydrologisch Onderzoek in het Leerinkbeek gebied, Wageningen. pp. 145-175.
- Davis, S.N. and R.J.M. de Wiest 1966. Hydrogeology. Wiley, New York, 463 p.
- Ernst, L.F. 1962. Grondwaterstromingen in de verzadigde zone en hun berekening bij aanwezigheid van horizontale evenwijdige open leidingen. Verslagen landbouwkundige onderzoekingen 67.15. Pudoc, Wageningen, 189 p.
- Freeze, R.A. and J.A. Cherry 1979. Groundwater. Prentice-Hall, Englewood Cliffs, New Jersey, 604 p.
- Hem, J.D. 1970. Study and interpretation of the chemical characteristics of natural water. 2nd ed. Geological survey, water supply paper 1473. U.S. Department of the Interior, Washington, 363 p.
- Jones, P.H. 1970. Hydrology of quaternary delta deposits of the Mississippi River. In: Hydrology of deltas: proceedings of the Bucharest symposium. Studies and reports in hydrology 9. UNESCO, Paris. pp. 49-63.
- Longwell, C.R., R.F. Flint and J.E. Sanders 1969. Physical geology. Wiley, New York, 685 p.
- Mandel, S. and Z.L. Shiftan 1981. Groundwater resources : investigations and development. Academic Press, New York, 269 p.
- Matthess, G. 1982. The properties of groundwater. Wiley, New York, 406 p.
- Nielsen, D.M. (ed.) 1991. Practical handbook of groundwater monitoring, Lewis Publishers, Chelsea, 717 p.
- Price, M. 1985. Introducing groundwater. Allan and Unwin, London, 195 p.
- Strahler, A.N. 1965. Introduction to physical geography. Wiley, New York, 455 p.
- Thornbury, W.D. 1969. Principles of geomorphology. Wiley, New York, 594 p.

Todd, D.K. 1980. Groundwater hydrology. Wiley, New York, 535 p.

UN 1967. Methods and techniques of groundwater investigation and development. Economic Commission for Asia and the Far East, Water resources series 33, New York, 206 p.

Verbraeck, A. and N.A. de Ridder 1962. De geologische geschiedenis van de Tielerswaard-West en haar betekenis voor de waterhuishouding. In: De waterbehoefte van de Tielerswaard-West. Commissie ter bestudering van de waterbehoefte van de Gelderse landbouwgronden, Wageningen. pp. 43-54.

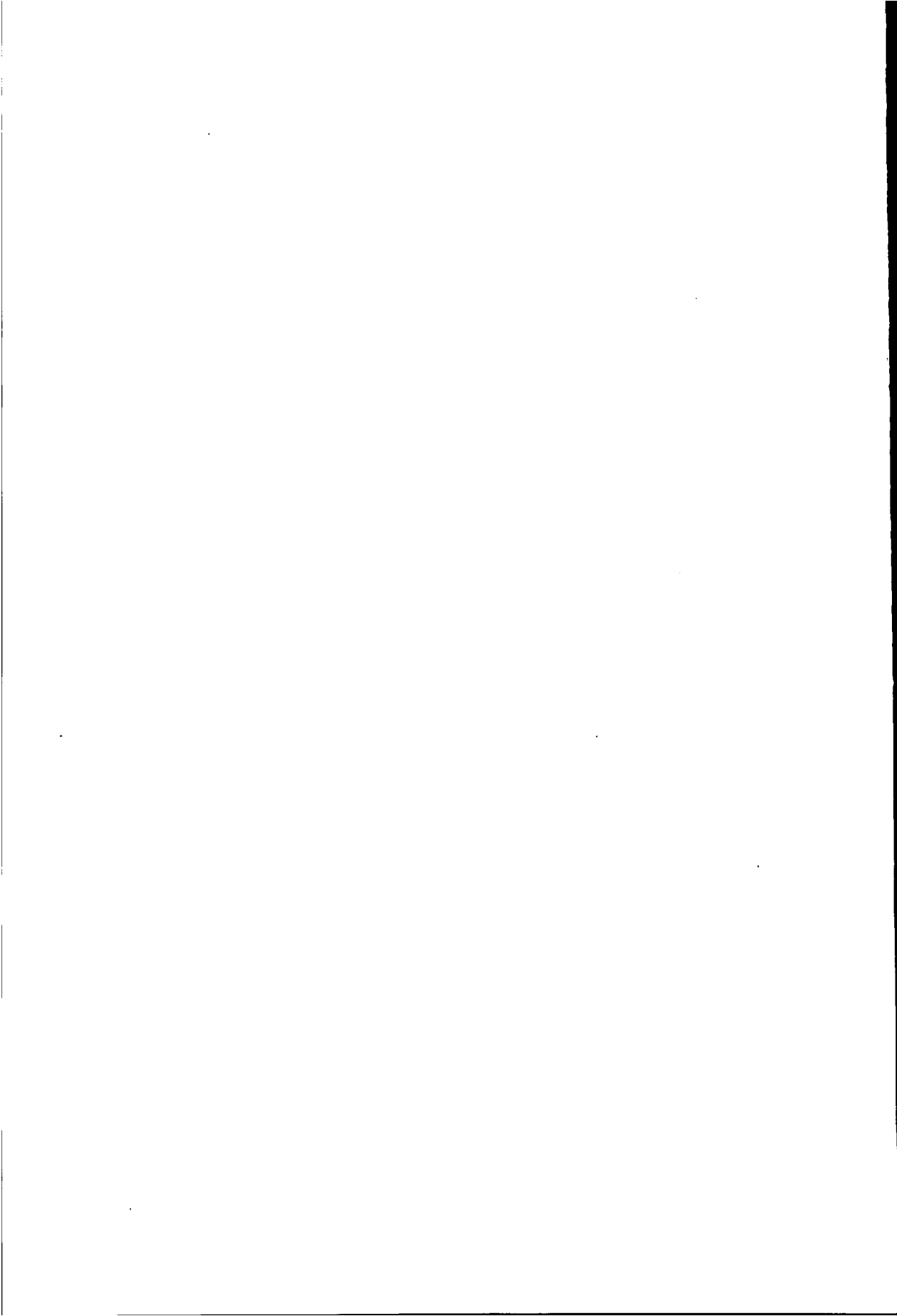

3 Soil Conditions

H.M.H. Braun¹ and R. Kruijne²

3.1 Introduction

The process of drainage takes place by water flowing over the land surface and through the soil. Obviously, therefore, the properties of the soil to conduct water both horizontally and vertically are of major importance for drainage. Drainage, however, is only one of the possible crop-improvement practices and should not be considered in isolation. Other aspects of soil, such as water retention, workability, and fertility, strongly affect plant productivity, and need to be assessed or studied in conjunction with drainage.

Soils provide a 'foothold' for plants, supply them with water, oxygen, and nutrients, and form an environment for many kinds of fauna. Section 3.2 discusses the influence of soil-forming factors and the various physical, chemical, and biological processes taking place in the parent material of soils, leading to the transformation and translocation of constituents in the developing soil. The resulting heterogeneity of soil characteristics and properties is treated in Section 3.3. Section 3.4 discusses the basic characteristics of soils and their related properties. Changes in the hydrological conditions affect land use by removing or adding constraints to crop growth. Anyone considering drainage applications will benefit from an understanding of soil genesis, and of general and specific soil conditions; a soil survey is therefore a prerequisite for planning and designing land-improvement projects (Section 3.5). Two widely applied soil classification systems are presented in Section 3.6. Section 3.7 looks into a number of soils with particular water-management problems, and briefly discusses the role of the soil scientist and drainage engineer in drainage surveys.

This chapter can only briefly deal with various aspects of soil that are important for drainage purposes. For a more extensive treatise of various subjects the reader is referred to textbooks and other documents mentioned in the reference list (e.g. Ahn 1993; Brady 1990; FAO 1979, 1985; FitzPatrick 1986; Jury et al. 1991; Klute et al. 1986).

3.2 Soil Formation

The word 'soil' means different things to people with different backgrounds, interests, or disciplines. To illustrate this point, three simplified views of soils will be given: from the angles of agronomy, drainage engineering, and soil science (or pedology):

- In agronomy, soil is the medium in which plant roots anchor and from which they extract water and nutrients;
- In drainage engineering, soil is a matrix with particular characteristics of water entry and permeability;

¹ International Institute for Land Reclamation and Improvement

² Winand Staring Centre for Integrated Land, Soil and Water Research

- In pedology, soil is that part of the earth's crust where soil has formed as a result of various interactive processes. This section discusses the pedological base of soil formation.

Soils are formed in the upper part of the earth's crust from 'parent material' that consists of rock, sediment, or peat. Soil formation is more than the weathering of rocks and minerals, because the interactions between the soil-forming factors are manifold. FitzPatrick (1986) gives a highly readable account of soil formation.

Table 3.1 presents an overview of the factors and processes by which soils are formed, the basic soil characteristics and properties, and the related agricultural qualities of land and soil.

3.2.1 Soil-Forming Factors

To a large extent, the soil-forming factors in Table 3.1 are interdependent, influencing one another in different ways. This explains the occurrence of a wide variety of soils. For example, the organisms (vegetation and fauna) are strongly influenced by the climate, and topography is influenced by parent material and time.

Climate

Climate has a major influence on soil formation, the two main factors being temperature and precipitation.

In warm moist climates, the rate of soil formation is high, because of rapid chemical weathering and because such conditions are conducive to biological agents that produce and transform organic matter. This rapid soil formation in warm moist climates often leads to deep, strongly weathered soils.

In cold dry climates, the rate of soil development is low, because chemical weathering is slow, and because biological agents do not thrive in cold or dry environments.

In warm dry environments, soils develop because of physical weathering through the heating and cooling that breaks up rocks.

In cold moist climates, soils develop through the physical effects of freezing and thawing on rocks and soil constituents. Soils formed under cold conditions are generally thin and only slightly weathered.

Parent Material

Soils develop in a certain climate, within a particular landform, and on a particular parent material or parent rock. The nature of the underlying parent rock from which the soil develops greatly determines the intermediate or final product of the pedogenetic (= soil-forming) process. For example, a sandstone develops into a sand; acid rock develops into a poor acid soil. Because the parent material is so important for soil formation, the rock type is often chosen as a criterion for subdividing or grouping soils (Section 3.6).

Topography

Soil forms within a topography that can be flat, nearly flat, slightly sloping, moderately sloping, or steeply sloping. Each landform is characterized by a particular slope or

Table 3.1 Soil forming factors and processes, basic soil characteristics and properties, and the agricultural qualities of soil and land (after Van Beers 1979)

Soil forming factors (Section 3.2.2)		Parent material Topography Climate Organisms (flora and fauna) Time Human activity
Soil forming processes (Section 3.2.3)		Physical Chemical Biological
Vertical and horizontal differentiation (Section 3.3)		Soil profile Heterogeneity
Basic soil characteristics (Section 3.4.1)		Texture Mineral composition Physico-chemical characteristics of clay Organic matter
Soil properties (Section 3.4.2)		Physical, chemical and biological properties of the solid, liquid and gaseous phase
Agricultural qualities	Land	Climate Topography, slope Hydrology Soil pattern Accessibility, trafficability
	Whole soil	Nutrient availability or fertility: - Cation exchange capacity - Acidity Salinity and sodicity Water retention Groundwater depth & quality Vertical variation in texture
	Topsoil	Infiltration Structure stability Workability Erodibility
	Subsoil	Depth Water transmission

sequence of slopes, and also by a particular parent material. Soil formation is related to the geomorphology (or landform), mainly because the movement of water and solids is affected by the slope of the land. The hydrological conditions play an important role in soil formation. These conditions alter when irrigation or artificial drainage is introduced. Thus, human interference will in time lead to changes in soil properties.

Organisms

The organisms that influence soil formation can conveniently be subdivided into higher plants (natural vegetation or crops), micro-organisms (moulds and other fungi), vertebrates (burrowing animals like moles), and meso-fauna (earthworms, ants, termites). These organisms mix the soil matrix and lead to the formation of organic matter. Moist conditions and high soil temperatures have a favourable effect on biological activity. Organisms are partly responsible for transforming and translocating organic matter and other soil constituents. They also improve aeration and permeability by the holes and channels they form.

Time

Time is a passive factor in the process of soil formation. In slightly sloping areas in humid tropical regions, where high rainfall and high temperatures cause intensive weathering and leaching, time is a predominant soil-forming factor. In other circumstances, the influence of time is less pronounced, but exists nonetheless.

Human Activities

From a pedological point of view, human activities do not have a major impact on soils, since they have taken place only over a relatively short time. From an agricultural point of view, however, they have a great impact, since soil properties are often seriously changed by human intervention. Hence, human activities are mentioned here as a separate factor. Examples of the results of human activities are:

- A changed soil-water regime with the introduction of irrigation or drainage;
- The mixing of horizons with different properties by ploughing;
- A changed nutrient status by fertilization or exhaustion;
- Salinization by unbalanced water management;
- Soil erosion due to the cultivation of sloping lands.

3.2.2 Soil-Forming Processes

Physical, chemical, and biological processes of soil formation are highly interactive. The physical processes involve changes in properties such as water content, volume, consistency, and structure. The chemical processes involve changes in the chemical and physico-chemical compounds of the soil. The biological processes involve changes influenced by the organisms living in the soil.

The major processes are summarized below. More details are given in the discussion on soil profiles (Section 3.3) and the characteristics and properties of soils (Section 3.4).

Physical Processes

The main physical processes of soil formation are:

- The translocation of water and dissolved salts, or of suspended clay particles;
- The formation of aggregates, which is a major cause of soil-structure development;
- Expansion and contraction as a result of wetting and drying of clay particles with a 2:1 type mineral (Section 3.3);

- Freezing and thawing, which causes soil-structure development in cold and temperate climates.

Chemical Processes

Chemical processes of soil formation worth mentioning are:

- The solution of salts;
- The oxidation of organic matter, or, in the formation of acid sulphate soils, of pyrite;
- The reduction of organic matter or iron compounds;
- The formation of clay minerals.

Biological Processes

The processes in which organisms, especially micro-organisms, affect soil formation are:

- Humification (i.e. the decomposition of organic matter and the formation of humus);
- The transformation of nitrogen by ammonification, nitrification, denitrification, and nitrogen fixation;
- Homogenization of the soil resulting from the activities of small animals (e.g. earthworms, termites, moles).

As a result of the soil-forming processes taking place, soil characteristics and properties vary in a vertical direction. Because of the variability in the soil-forming factors (particularly in parent material, landform, and groundwater conditions), soil properties also vary horizontally. These vertical and horizontal variations, which will be treated in more detail in the next section, have great practical implications and are worthwhile studying.

3.3 Vertical and Horizontal Differentiation

3.3.1 Soil Horizons

A soil horizon is defined as a layer of soil or soil material approximately parallel to the land surface and differing from adjacent, genetically-related layers in physical, chemical, and biological properties or characteristics such as colour, structure, texture, consistency, and degree of acidity or alkalinity (SSSA 1987).

Soil horizons that develop as a result of the soil-forming processes are called 'pedogene layers'. When layering is the result of a succession or variation in the parent material, we speak of 'geogene layers'. In young soils with only limited profile development, it is generally easy, at least to the trained eye, to distinguish between pedogene and geogene layering. In old soils with a strong profile development, it is often difficult or impossible to assess whether the layering is due to soil formation only or to a combination of pedogene and geogene layering.

Layers and horizons can have a great impact on drainage conditions because their occurrence determines the flow path that water will take through the soil. Horizons, layers, and their transitions can be identified by differences in texture, structure,

consistency, porosity, colour, and various other less easily noticeable differences like calcareousness, salinity, and acidity.

Sometimes, transitions in colour, structure, or texture are conspicuous or distinct, particularly when the soil is dry. More often, however, these transitions are rather diffuse. Though it requires some experience to see these differences, it is unlikely that any important physical transitions are present in case no differences in texture, structure, or porosity can be observed. Chemical differences, or the chemical properties of the soil as such, are rarely directly observable (with the exception of salt crystals). Sometimes, however, chemical differences can be inferred from the shape and size of soil aggregates or from the soil colour. Examples will be given in Section 3.4.2.

3.3.2 The Soil Profile

The soil profile is defined as a vertical section of the soil, through all its horizons, and extending into the parent material (SSSA 1987).

Describing and sampling soil profiles are essential parts of a soil investigation. The soil scientist uses 'master horizons' to describe the vertical sequence of horizons and layers. These are denoted by the capital letters H, O, A, E, B, C, and R. A brief description of these master horizons is as follows:

- H is a wet (anaerobic) organic horizon. Its organic-matter content is more than 30% in clay soils, and more than 20% in sandy soils (Buringh 1979);
- O is a dry (aerobic) organic horizon;
- A is a mineral surface horizon with an accumulation of organic matter;
- E is a mineral horizon from which clay particles, iron oxides, and aluminium oxides have disappeared (also called an eluvial horizon);
- B is a mineral horizon enriched by the translocation of clay particles, organic matter, or iron oxides and aluminium oxides (often called an illuvial horizon);
- C is a mineral horizon of unconsolidated material from which the soil is formed;
- R is a parent rock.

These master horizons can be further divided by suffixes (e.g. 'g' for mottling, 'r' for reduction), or prefixes. For a complete list of definitions and explanations, see the FAO/UNESCO Legend (FAO 1988).

Though soil-science jargon is not very complicated, the non-soil-scientist often has difficulty interpreting the meaning of the horizon codes or is confused by these codes. The major difficulty is how to assess or infer whether a horizon needs designation as, or shows signs of, eluviation (i.e. the leaching of physical and/or chemical soil constituents) or illuviation (i.e. an enrichment due to the accumulation of soil constituents).

The most common horizon sequence of a soil profile is A-B-C. Another horizon sequence found in many highly-developed soils is A-E-B-C (Figure 3.1). For the drainage engineer, B-horizons, and particularly Bt-horizons, are important because such horizons can hinder the flow of water. A Bt-horizon is a texture B-horizon with a higher clay content than the horizon above it.

Horizon sequences can best be observed in specially-dug soil-profile pits at sites

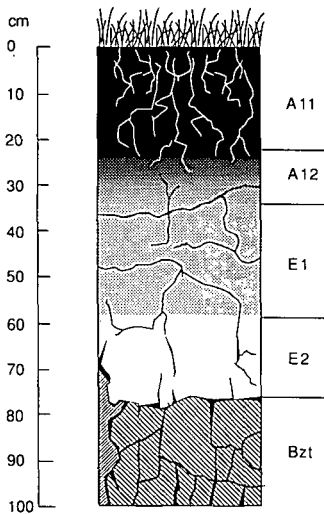

Figure 3.1 Example of a soil profile with an A-E-B horizon sequence (drawn after profile EAK 20 at the International Soil Reference and Information Centre, ISRIC, Wageningen)

that give a representative range of the landscape and vegetation. Alternatively, observations can be made in existing pits or from roadsides or augerings. The various observable characteristics of the soil profile can be described. The data obtained from these observations can be of great help to the drainage or irrigation engineer.

After the profile has been described, samples of each horizon should be taken and sent to the laboratory for chemical, physical, and/or mineralogical analysis.

Apart from the master horizons discussed above, there are also 'diagnostic horizons'. These are used for soil classification, and will be discussed in Section 3.6.

3.3.3 Homogeneity and Heterogeneity

Soil is hardly ever uniform or homogeneous in the vertical direction, and often varies in the horizontal direction as well. For instance, a 'slowly permeable' horizon is hardly ever found at a constant depth. So when using soil maps or making observations, we have to keep in mind that homogeneity in soil characteristics is the exception rather than the rule. Both vertical and horizontal variations are major points of investigation in soil surveys (Section 3.5).

From a pedological point of view, one characteristic that defines a soil is that a certain degree of change has taken place in the profile. A deposit that is uniform from top to bottom cannot, pedologically speaking, be considered a soil because no development of the parent material has taken place. From an agricultural point of view, however, the deposit would be regarded as a homogeneous soil.

A vertical variation in a soil can be partly due to a layered composition of the parent material, but is more commonly the result of profile development (or pedogenesis). Through this development, any vertical homogeneity that might have existed in the parent material disappears. Examples of profile development are the formation and

subsequent translocation of organic matter, or the eluviation of clay particles and other compounds along with percolating water.

In soil science and soil surveys, vertical variations and their effects on land use and productivity are the subject of observation and study. They also feature in the keys of various soil-classification systems. Dealing adequately with vertical heterogeneity is not easy, mainly because inferring the quantitative implications for agriculture is so complicated.

Horizontal variations in soil properties are common at any scale, even at less than 1 m. In some cases, the change in colour, salinity, texture, structure, or stoniness/rockiness observable at the soil surface is quite sharp, but, more generally, the transition is gradual. Saline/sodic conditions, in particular, can vary dramatically over short distances; a very saline and sodic profile can change, – within a few metres in the horizontal direction –, to a non-saline, non-sodic profile (e.g. Figure 17.14).

The horizontal variability in soil properties can be studied by various quantitative techniques, which are referred to as 'geostatistics' (Burrough 1986). Geostatistics enable the spatial dependence of data to be determined. This can be used to decide on optimum sampling schemes, to interpolate or extrapolate point observations, and to evaluate how accurately data have been interpolated and extrapolated.

Anisotropy

Anisotropy means that a substance has different physical properties when measured in different directions. In one direction, for example, soil permeability may be higher or lower than in the other direction. Anisotropy can be expected to occur both within a complete soil profile and within soil layers and horizons.

For drainage, it is important to note that the vertical movement of water through the soil is limited by the layer of lowest permeability, whereas the horizontal movement of water is governed by the layer of highest permeability. The vertical movement of water and dissolved salts in the topsoil is determined by water retention and unsaturated hydraulic conductivity (Section 3.4). When considering the general flow path to subsurface drains (Chapter 8), we have to assess whether a soil profile has layers of low permeability, particularly in the topsoil, and layers of high permeability, particularly in the subsoil. The magnitude of the saturated hydraulic conductivity, which is the measure of permeability, will be discussed in Chapter 7, in relation to the shape, size, and orientation of soil grains.

Many structural elements (e.g. prismatic, columnar, and platy structures) are oriented in one direction. This may have its effect on the water-transmitting properties of a soil horizon. In horizons consisting of prisms or columns, there is a similar resistance to vertical and horizontal flow, because the voids around prismatic and columnar elements are interconnected. In surface horizons that contain platy structures, however, the voids mostly occur in the horizontal plane. As a consequence, the horizontal permeability is usually considerably greater than the vertical permeability. In many soils with surface horizons that exhibit surface sealing, the permeability is strongly anisotropic.

Animal activity, particularly when it results in vertical wormholes and the like, can greatly increase the vertical permeability and thus obscure the anisotropy that results from soil horizons or sediment layers having differing permeabilities. Root holes, and cracks in swelling clay soils may have a similar effect.

3.4 Soil Characteristics and Properties

Basic soil characteristics result from the interactions of the soil-forming factors discussed in the previous section. These basic soil characteristics will be discussed in Section 3.4.1. The interactions between them affect a number of physical and chemical properties, which will be discussed in Section 3.4.2.

3.4.1 Basic Soil Characteristics

We distinguish the following basic soil characteristics: texture, mineral composition, physico-chemical characteristics of clay, organic matter.

Soil Texture

The soil consists of primary mineral particles of widely varying sizes. The size distribution of these particles defines the soil's texture. Common names for particle sizes are clay, silt, sand, gravel, stone, and boulder. There are variations in the particle-size limits used by the various disciplines that deal with soils. The USDA/SCS boundary values (Soil Survey Staff 1951, 1975) are listed in Table 3.2A. The major class limits of that USDA/SCS system (i.e. 0.002, 0.050 and 2.0 mm) are widely accepted among soil scientists (see the values used until recently by the FAO in Table 3.2B). Some soil survey organizations (e.g. in the Netherlands), geologists and civil engineers use slightly or completely different boundary values between clay, silt and sand. See for instance the values quoted in Table 3.2C (from the Public Roads Administration in the U.S.) and the new boundary limits recently adopted by FAO (FAO-ISRIC 1990), which apparently are in line with ISO (International Standardization Office) standards (Table 3.2.D).

Texture refers to the particle-size distribution of the 'fine earth' of the soil. These are particles less than 2 mm in diameter (i.e. clay, silt, and sand as defined in Table 3.2A and B).

The textural class of a soil is determined by the relative proportions of sand, silt, and clay in it. The names given to the particular compositions of the sand, silt, and clay fractions vary. Usually these textural classes are presented in a texture triangle. Figure 3.2 shows the textural classification used by many soil survey organizations throughout the world (Soil Survey Staff 1951, 1975; FAO-ISRIC 1990).

The results of particle size distribution from a laboratory analysis can also be presented in the form of a cumulative grain-size curve. Well-graded soils show a good cross-section of particle sizes, ranging from small to large, whereas poorly-graded soils show a uniform particle size or lack medium-sized particles.

Soils are sometimes classified according to their workability. Hence, a coarse-textured soil, in which sand is the dominant fraction, may be referred to as 'light' or 'sandy', and a fine-textured soil, in which clay-particles are the dominant fraction, as 'heavy' or 'clayey'.

Soil texture is important because other properties (e.g. consistency, workability, water retention, permeability, and fertility) are in many cases related to it. If we know

the texture of the various layers of soil, we generally have a good idea of the soil's physical properties and its agricultural qualities.

Table 3.2A Particle size limits (Soil Survey Staff 1975)

Soil particle size	Size limits (diameter in mm)		
Clay	< 0.002		
Silt	0.002	-	0.050
Very fine sand	0.050	-	0.100
Fine sand	0.10	-	0.25
Medium sand	0.25	-	0.50
Coarse sand	0.50	-	1.00
Very coarse sand	1.00	-	2.00
Gravel	2.00	-	75
Cobble	75	-	250
Stone or Boulder	> 250		

Table 3.2B Particle size limits (FAO 1977)

Soil particle size	Size limits (diameter in mm)		
Clay	< 0.002		
Silt	0.002	-	0.050
Sand	0.050	-	2
Gravel	2	-	75
Stone	75	-	250
Boulder	> 250		

Table 3.2C Particle size limits of the US Public Roads Administration (quoted by Brady 1990)

Soil particle size	Size limits (diameter in mm)		
Clay	< 0.005		
Silt	0.005	-	0.050
Fine sand	0.050	-	0.25
Coarse sand	0.25	-	2.0
Gravel	2.0	-	?

Table 3.2D Particle size limits (FAO-ISRIC 1990)

Soil particle size	Size limits (diameter in mm)	
Clay	< 0.002	
Fine silt	0.002	- 0.020
Coarse silt	0.020	- 0.063
Very fine sand	0.063	- 0.125
Fine sand	0.125	- 0.20
Medium sand	0.20	- 0.63
Coarse sand	0.63	- 1.25
Very coarse sand	1.25	- 2.00
Fine gravel	2.00	- 6.0
Medium gravel	6	- 20
Coarse gravel	20	- 60
Stones	60	- 200
Boulders	200	- 600
Large boulders	> 600	

Mineral Composition

Two main groups of minerals can be distinguished, depending on particle size:

- Minerals in the sand and silt fraction;
- Minerals in the clay fraction.

The mineral components of the sand and silt fraction are determined by the soil's parent material and its state of weathering. Its composition determines the reserve

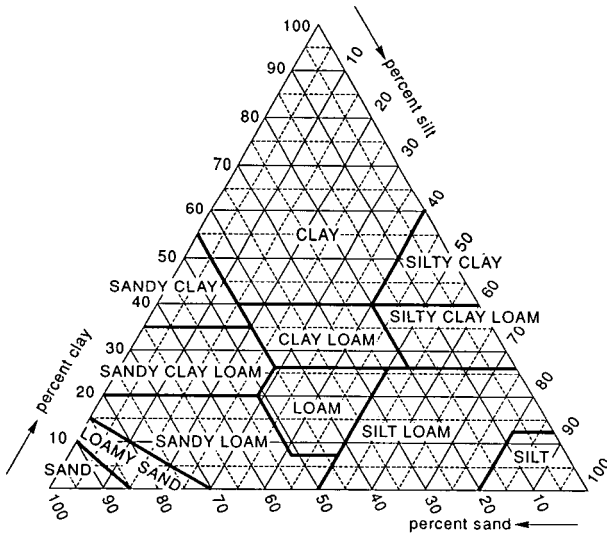

Figure 3.2 Textural classification (Soil Survey Staff 1975)

of minerals available as plant nutrients. The most common component of the sand fraction is silica or quartz which is physically and chemically inert.

The mineral components of the clay fraction consist of crystalline hydrous aluminosilicates. In strongly-weathered tropical soils, we also find crystalline and amorphous iron and aluminium oxides and hydroxides. Hydrous aluminosilicates have a layered structure; they are composed of sheets of silicon oxide and sheets of aluminium hydroxide. A combination of one silicon sheet and one aluminium hydroxide sheet gives a 1:1 type clay mineral. A combination of two silicon sheets, sandwiching an aluminium hydroxide sheet, gives a 2:1 type clay mineral. This layered structure explains why clay minerals occur in plate-shaped crystals. In reality, there are many different clay types that deviate from the ideal 1:1 and 2:1 combinations of silicon oxide and aluminium hydroxide sheets.

The mineral composition of the clay fraction has a direct impact on nutrient availability. Fixation of phosphorus is high in soils with high concentrations of iron and aluminium oxide and hydroxide. Potassium is fixed by clay minerals, the least by tropical kaolinitic clays (see next section) and considerably more by illitic clays (Mitra et al. 1958).

Physico-Chemical Characteristics of Clay

Clays have pronounced physico-chemical properties because of two factors: a large specific surface area, and an electrical charge. The large specific surface (i.e. the surface area per unit mass) results from the platy or fibrous morphology of clay minerals (Table 3.3).

The electrical charge results from a process of isomorphous substitution when the clay minerals were being formed. During that process, some of the silicon and aluminium ions in the crystal structure are replaced by cations of lower valency.

Another factor that creates an electrical charge is the ionization of water on the aluminium sheets into hydroxyl (OH^-) groups. As a consequence, clay particles possess a negative charge at their surface, although some positive charges may occur at the edges of the sheets. This negative surface charge is compensated by the adsorption of positively-charged cations like calcium (Ca^{2+}), magnesium (Mg^{2+}), sodium (Na^+), potassium (K^+), hydrogen (H^+), ammonia (NH_4^+), and aluminium (Al^{3+}). These cations are present in the so-called 'diffuse double-layer' between clay particles, and their concentration is much higher near the surface of the clay particle than away from it. The adsorbed cations are exchangeable with the cations in the soil solution.

Table 3.3 Specific surface area of various clay minerals

Clay mineral	Specific surface area (m^2/g)
Kaolinite (1:1)	1 - 40
Illite (2:1, non-expanding)	50 - 200
Smectite or montmorillonite (2:1, expanding)	400 - 800

The cation exchange capacity (CEC) refers to this process of mutual replacement (Section 3.4.2).

Thus clay particles are generally platy-shaped and have a high specific surface area. As a result of their chemical composition and spatial arrangement, the 2:1 type clays, such as the montmorillonite (belonging to the smectite group of clay minerals) of subtropical and tropical Vertisols (Section 3.6.5), have substantial electrical charges that bring with them properties like a large CEC, and swelling and shrinking.

The 1:1 types of clays, such as the kaolinite of many tropical clay soils, do not have these electrical charges. These clays have a low CEC and do not swell or shrink.

Many types of clay have properties intermediate between these two extremes. This aspect of clay mineralogy complicates the interpretation of soil-texture data. A soil containing 40% of montmorillonitic clay, for example, behaves quite differently, and also feels finer and heavier, than a soil containing 40% of kaolinitic clay. The latter may feel like a loam and often is called loam (e.g. a Kikuyu red loam which texturally is a clay).

Organic Matter

Organic matter is that part of the soil that consists of organic carbon compounds (i.e. the material derived from the remains of living organisms). When fresh organic matter is incorporated into the soil, part of it is rapidly decomposed by the action of micro-organisms. The residue is called humus, which decomposes slowly and consists of a mixture of brown to black amorphous substances.

Even when present in small amounts, organic matter has a great influence on the physical and chemical properties of soils. Organic matter promotes the stability of soil aggregates, thereby improving the structure of the soil. Chemically, organic matter plays a role in extracting plant nutrients from minerals. The humus component of organic matter increases the CEC of the soil. Moreover, there can be a fixation of nitrogen from the air by micro-organisms, which obtain their energy from decomposed plant tissue.

In some cases, small amounts of organic matter (i.e. of the order of 1%) can have a pronounced effect on soil fertility, but it should be emphasized that a large amount of organic matter does not necessarily make a good soil.

Peat is accumulated organic matter, often to a large degree undecomposed. A combination of a wet climate and poor natural drainage often results in the formation of peat because, under these conditions, the quantity of organic matter produced exceeds the quantity decomposed. By volume, peat soils have an organic-matter content of more than 0.50, muck soils have between 0.50 and 0.20, organic soils between 0.20 and 0.15, and mineral soils less than 0.15 (organic matter as a fraction of dry solids).

Large organic-matter percentages are generally associated with a particular mode of soil formation. When organic matter has accumulated under conditions of poor drainage, the reclamation of such soils often creates problems, such as soil subsidence (Chapter 13), or a very low soil fertility (see Beek et al. 1980).

For a more comprehensive evaluation of the role of organic matter in (tropical) soil fertility, see Sanchez (1976).

3.4.2 Soil Properties

Soil Consistency

The consistency of the soil refers to the effect of the physical forces of 'cohesion' and 'adhesion' within the soil at various water contents. The terminology used ranges from 'loose' to 'extremely hard' in dry soil, from 'loose' to 'extremely firm' in moist soil, and from 'non-sticky, non-plastic' to 'very sticky, very plastic' in wet soil. For more details, see the guidelines for soil-profile description (FAO-ISRIC 1990).

Consistency is related to the type of clay mineral and to the soil chemical status. The consistency is generally lower for coarse-textured soils than for fine-textured, lower for kaolinitic clays than illitic clays, and lower for sodic (see further) than for non-sodic clays. Consistency may be useful in identifying sodicity. Consistency has relevance for soil workability.

In engineering, the classification of soils is often based on texture and plasticity. For this classification, two consistency limits (known as the Atterberg limits) are defined:

- The liquid limit, w_L , which is the minimum water content at which a soil-water mixture changes from a viscous fluid to a plastic solid;
- The plastic limit, w_p , which is somewhat arbitrarily determined in the laboratory as the smallest water content at which soil can be rolled into a 3 mm diameter thread without crumbling.

The plasticity index, PI, equals the liquid limit minus the plastic limit, thereby defining the range of water contents at which the soil behaves like a plastic solid. The plasticity index has relevance for the soil's bearing capacity.

Soil Structure

The structure of a soil is the binding together of soil particles into aggregates or peds, which are separated from each other by cracks. Many wet soils, and also all sandy soils, lack soil cracks and are thus structureless. Structural elements (i.e. the aggregates or peds) can vary in size from a few millimetres to tens of centimetres. The peds can be smooth-edged or sharp-edged, granular, blocky, platy, prismatic, or columnar

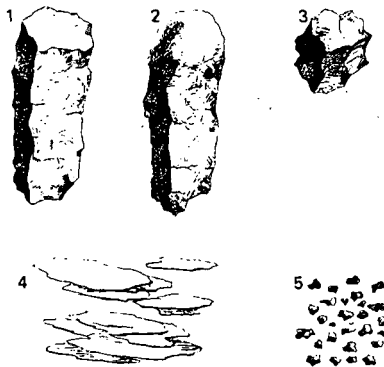

Figure 3.3 Drawings illustrating some types of structural elements (at different scales): 1) prismatic, 2) columnar, 3) blocky, 4) platy, and, 5) granular (Soil Survey Staff 1975)

(Figure 3.3). As the clay content increases, the edges of aggregates get sharper and more prismatic. Structure is related to texture and consistency. It has a positive effect on aeration and permeability.

Particular structures or structural sequences are characteristic of certain soil types (Section 3.6.5).

Soil Colour

Soil colours are primarily due to coatings on the surface of soil particles. The colours can be described according to the Munsell Colour Chart or something similar.

Colour depends on the nature of the parent material from which the soil was formed, on the drainage conditions, and on the prevailing soil temperatures.

Colour variation, whether between soils or within a soil profile, is a useful guide in making a first assessment of general soil conditions. Well-drained and poorly-drained soils have different colours: well-drained soils are redder or browner than poorly-drained soils, which, under similar climatic conditions, are greyer. Black usually indicates organic matter, except in dark-coloured montmorillonite, which generally has a low organic-matter content. In tropical or subtropical regions, red indicates well-drained soils. Yellow may indicate sand or sandy soil in any climate, or, in semi-arid or arid areas, that little soil development has taken place.

Mottling (i.e. the presence of brownish/rusty and bluish/greyish spots) is characteristic of soils in which the watertable fluctuates. Brownish spots occur in the higher parts of layers that are alternately oxidized and reduced as a result of wetting and drying. Bluish/greyish spots occur in the lower part of the groundwater fluctuation zone. In the permanently wet zone, the mottles disappear and uniform grey colours prevail. These bluish grey colours result from the reduction of iron; the reduced conditions are referred to as 'gley'.

Mottles are quite stable and often remain even when the drainage conditions have been improved. Hence, care has to be exercised in interpreting mottles.

Soil Phases, Definitions

The soil consists of three phases: the solid phase, the liquid phase, and the gaseous phase. Methods of quantifying the distribution of the soil phases will be discussed in Chapter 11.

The definitions of some physical soil properties are summarized below.

A volume of soil, V , contains a volume of solids, V_s , a volume of water, V_w , and a volume of air, V_a .

$$V = V_s + V_w + V_a \quad (3.1)$$

The liquid and gaseous phases together form the pore space of the soil, which is occupied by the volume of voids, V_v .

$$V_v = V_w + V_a \quad (3.2)$$

If the voids are completely filled with water, the soil is said to be saturated. The porosity, ε , is defined as the volume of voids as a fraction of the volume of soil.

$$\varepsilon = V_v / V \quad (3.3)$$

A sample of soil can also be divided into mass fractions. Thus, a mass of soil, m , consists of a mass of solids, m_s , a mass of water, m_w , and a mass of air, m_a . In general, m_a can be neglected, so we can write

$$m = m_s + m_w + m_a \approx m_s + m_w \quad (3.4)$$

The wet bulk density, ρ_{wb} , is defined as the mass of soil divided by the volume of the sample.

$$\rho_{wb} = (m_s + m_w) / V \quad (3.5)$$

The dry bulk density or bulk density, ρ_b , is defined as the mass of oven-dried soil, m_s , divided by the volume of the sample.

$$\rho_b = m_s / V \quad (3.6)$$

The soil porosity, ε , can be determined from the density of solids, ρ_s (m_s/V_s , i.e. the mass of solids per unit of volume of solids), and the dry bulk density, ρ_b , according to the equation

$$\varepsilon = (1 - \rho_b / \rho_s) \quad (3.7)$$

The density of dry solids of mineral soils usually varies between 2500 and 2800 kg/m³. A fair average is 2660 kg/m³. The density of soils that are rich in organic matter, is lower.

The soil-water content on a volume basis is defined as

$$\theta = V_w / V \quad (3.8)$$

and on a mass basis as

$$w = m_w / m_s \quad (3.9)$$

Coarse and medium-textured mineral soils have dry bulk densities generally varying between 1300 and 1700 kg/m³. The porosity may thus range from 0.36 to 0.51. In fine-textured soils the dry bulk density is generally somewhat lower than in coarse/medium-textured soils and can be as low as 1100 kg/m³ (with a porosity as high as $1 - 1100/2660 = 0.60$) in young clay soils. Peat soils have bulk densities lower than that of water (i.e. less than 1000 kg/m³). Since ρ_s is lower in peat than in mineral soils, the porosity of a peat soil exceeds the range of values indicated for mineral soils.

The bulk density and the porosity cannot be directly related to other soil properties (e.g. permeability). There is the seeming paradox that many soils with a high bulk density and a low porosity have a high permeability, while other soils with a low bulk density and high porosity have a low permeability. This is related to the pore-size distribution.

Pore-Size Distribution

Big pores retain little or no water, but are very effective in conducting water under saturated or nearly saturated conditions (flooding, ponding rain). The opposite is true for small pores, which have a function in water retention, and conduct water slowly. Part of the water in these pores can be taken up by plant roots. When considering

the size and the function of the pores, we make a distinction between micro-pores (3 to 30 μm diameter), meso-pores (30 to 100 μm diameter), and macro-pores (> 100 μm diameter).

A soil with an optimum pore-size distribution for plant growth has sufficient micro- and meso-pores to retain water, and sufficient macro-pores to evacuate excess water. Macro-pores are mainly created by soil fauna (earthworms etc.), so increasing the populations of soil fauna is one way of improving the drainage conditions and aerating soils.

The pore-size distribution, which strongly influences a soil's water-retaining and water-transmitting properties, is of great importance for the physical processes of transport in soil. It can be qualitatively assessed by visual observation in soil profiles. Macro-pores are visible to the naked eye; meso-pores are visible at a magnification of 10; micro-pores are not visible, but their presence can sometimes be deduced from the faces of the aggregates, a rough surface indicating the presence of many micro-pores. No field methods are available for quantitative assessments of the pore distribution.

Soil-Water Retention

In a soil, the solid phase usually controls the form or spatial distribution of the liquid and the gas phases. The solid phase is therefore called the 'soil matrix' (Figure 3.4).

Over most of the wetness range in which plant roots normally function, all properties of soil-water retention and transmission are determined by forces associated with the soil matrix. Interactions between the soil matrix and the water are basically due to the forces of adhesion and cohesion. For more details, see Chapter 11.

The availability of soil water is related to its energy status, which is referred to as the 'water potential'. The water potential is governed by the matric forces and by the force of gravity. Other factors may also affect the water potential: the osmotic pressure of dissolved salts, the external gas pressure, and the pressure arising from the swelling of clay. For our purposes, we define the water potential as the sum of the matric potential and the gravitational potential.

The existence of the matric potential can be demonstrated by means of a tensiometer placed in the soil (Figure 3.5). Provided the soil is not saturated, water will move from the porous cup of the tensiometer into the soil. At equilibrium, a negative pressure is measured on the tensiometer.

If we express the soil-water potential per unit weight, we obtain the hydraulic head,

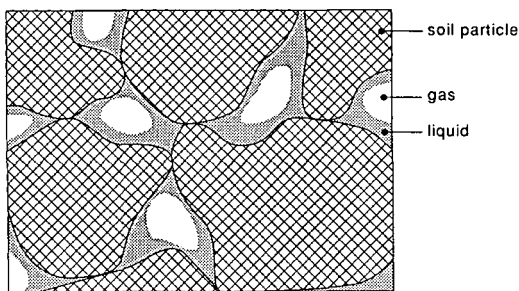

Figure 3.4 Cross-section of soil; soil particles forming soil pores, partly filled with liquid and gas

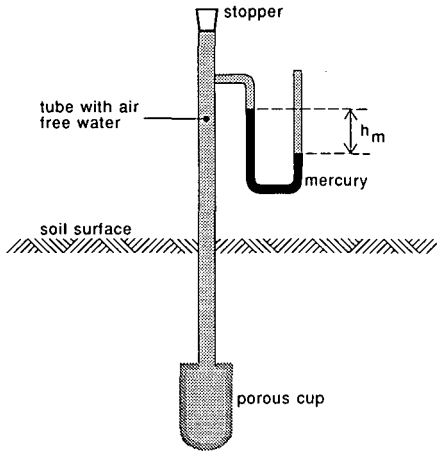

Figure 3.5 A tensiometer

h , being the sum of the pressure head, $p/\rho g$, and the elevation head, z . The pressure head of water in the unsaturated zone is commonly called the 'matric head', h_m . Thus we can write

$$h = h_m + z \quad (3.10)$$

The elevation head depends on the difference between the level of the point where we define the energy status of the water, and a reference level. Usually, the watertable is taken as the reference level.

Above the watertable, the matric head has a negative value because work is needed to extract soil water from the soil pores against the action of the matric forces. This requires a negative pressure or suction. The matric forces decrease sharply when the radius of the pores increases.

The matric head is a function of the soil-water content. At the level of the watertable, the matric head $h_m = 0$, and in oven-dried soil $h_m = -10^7 \text{ cm} (= -10^5 \text{ m})$. The graphic presentation of the relation between the matric head and the volumetric soil-water content is called a 'soil-water retention curve' (Figure 3.6). The matric head is conveniently expressed as pF , according to

$$pF = \log |h_m| \quad (3.11)$$

in which h_m is the numerical value of the matric head in cm and pF a number between 0 and 7.

Imagine that free drainage occurs in a soil that has become saturated after a heavy rainstorm. If the soil has large pores in which the matric forces are small, these pores will release water by gravity flow. After this water is released, the soil is at 'field capacity', corresponding with a volumetric soil-water content at a matric head somewhere between -100 and -200 cm ($2.0 < pF < 2.3$). The soil-water content will further decrease by crop transpiration and evaporation at the soil surface. The remaining soil water redistributes by flow through capillaries and flow along the walls of empty pores. When the matric head $h_m = -16000 \text{ cm}$ ($pF = 4.2$), the soil is at

'wilting point', because plant roots cannot extract water from the soil when the matric head falls below this point. The soil water stored between field capacity and wilting point is called the 'available soil water' or the soil's 'water-holding capacity'.

Figure 3.6 shows the soil-water retention curves of three different soils. Usually, pF-curves are measured by the stepwise drying of a wet sample (desorption). When a dry soil sample is wetted (adsorption), a somewhat different pF-curve will be obtained. This effect is due to pore geometry, and is called 'hysteresis' (Chapter 11).

When the watertable is at shallow depth, the matric head at field capacity is less well-defined, because, if the watertable influences the soil-water conditions in the rootzone, free drainage will be prevented.

If the watertable is lowered, a certain amount of water in the unsaturated part of the soil profile will be released by gravity flow. The 'drainable pore space', μ , indicates the ratio between the change in the amount of soil water and the corresponding change in the level of the watertable.

$$\mu = \frac{\text{change in the amount of soil moisture storage}}{\text{change in watertable depth}} \quad (3.12)$$

Note that the drainable pore space is not a constant for the entire soil profile, but depends on the depth of the watertable.

The drainable pore space is equivalent to the 'specific yield', which was defined in Chapter 2. It is also called 'drainable porosity', or 'effective porosity'.

The drainable pore space of a soil can be found by simultaneously measuring watertable fluctuations and drain discharges over a number of weeks or months. Such measurements integrate the effect of spatial variability of other soil properties. The drainable pore space can also be found from the pF-curve, provided this curve is determined on undisturbed soil samples. Methods of determining the drainable pore space will be discussed in Chapter 11.

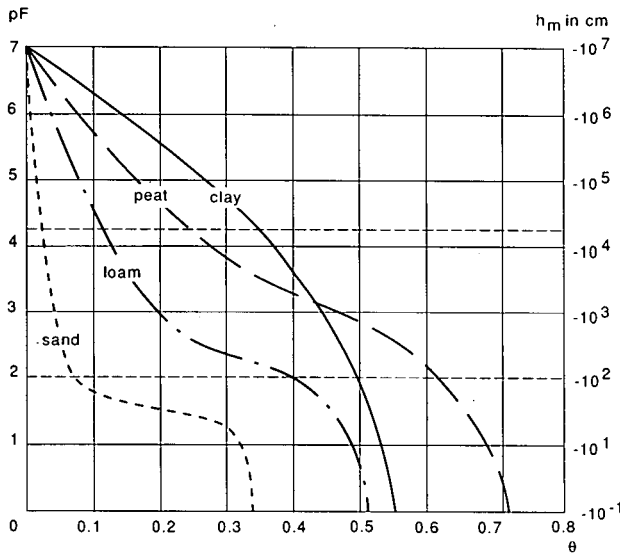

Figure 3.6 Soil-water retention curves for different soil types

Water-Transmitting Properties

Water-transmitting properties of soils can be discerned on the basis of the direction of flow, the position in the soil profile, and the soil-water conditions. The rate of water movement in the soil is governed by the hydraulic head and by the permeability of the soil.

The term 'permeability' has a general meaning and refers to the readiness with which a soil conducts or transmits water. Permeability is expressed by the hydraulic conductivity, which is the proportionality factor in Darcy's Law (Chapter 7). The hydraulic conductivity for saturated flow, K , was defined in Chapter 2. The hydraulic conductivity for unsaturated flow is a function of the matric head, $K(h)$, or the soil-water content, $K(\theta)$ (Chapter 11).

The hydraulic conductivity for unsaturated flow, $K(\theta)$, decreases very rapidly with decreasing soil-water content. One practical consequence is that the flow rates at low soil-water contents are much lower than the potential crop-transpiration rate. In other words, only a part of the available soil water (i.e. the water between field capacity and wilting point) is readily available for plant growth.

'Infiltration' and 'percolation' are processes in which water flows downward at unsaturated or nearly saturated conditions. Infiltration refers to the entry of water into the soil at the surface; percolation refers to the passage of water through the various soil layers. The amount of water percolating through the entire soil profile and recharging the groundwater is called 'deep percolation'.

In small pores, water will rise until the matric forces exerted by the soil particles are in equilibrium with the gravitational force, a phenomenon known as 'capillary rise'. Especially in well-graded soils, capillary rise can reach a height of several metres above the watertable, where water is taken up by plant roots or lost by evaporation at the soil surface. If there is no groundwater recharge, capillary rise causes the watertable to fall until the capillary flow finally stops. If the groundwater is recharged by lateral or vertical inflow (seepage), the capillary flow can continue throughout the season and may transport large amounts of dissolved salts to the rootzone or the soil surface. These accumulated salts can only be removed by percolation which implies a downward movement of water.

Soil Air

Plant roots and most micro-organisms utilize oxygen (O_2) from the soil air and release or respire carbon dioxide (CO_2). A continuous supply of oxygen is needed for a sustained respiration process. An insufficient supply will limit plant growth.

When soil air and atmospheric air are compared, the nitrogen (N_2) content in both is about the same (79%), but the carbon-dioxide content in the soil is higher than in the atmosphere, and the oxygen content in the soil is lower than in the atmosphere. Under conditions of waterlogging, the carbon-dioxide content rises and oxygen may be in short supply.

The interchange of gases between soil and atmosphere takes place by 'diffusion' and by 'mass flow'. Mass flow plays a role when the pressure between the soil air and the atmospheric air differs. These pressure differences may be induced by soil-water flow. With diffusion, gases move in response to their own partial pressure differences. The rate of diffusion is determined by the porosity, and especially by the continuity of the pores. Pore size has little effect on the rate of diffusion, but compacted

layers in the topsoil or crusts at the soil surface have a strong adverse effect on soil aeration.

Soil Temperature

Soil temperature is an important growth factor. Below a temperature of 10°C, microbiological activity is restricted; above 10°C, the activity increases greatly. Germination depends on the temperature of the topsoil. A low subsoil temperature limits root growth in early spring.

Soil temperature depends, among other factors, on the 'specific heat capacity' of the soil. The specific heat capacity of a dry mineral soil is only one-fifth of the specific heat capacity of water. This large difference explains why wet soils do not warm up as quickly as dry soils. In temperate and mediterranean climates, poorly-drained soils often have soil temperatures 5°C below the temperature of well-drained soils.

Soil Depth

The term 'soil depth' refers to the rootable depth of the soil. The depth to which plant roots can penetrate into the soil and obtain water and minerals is of great importance for plant growth. When only a very thin soil layer is available for rooting, most plants will experience a deficiency in water and nutrients.

Root penetration is hampered, among other causes, by permanent wetness, by layers of contrasting texture, and, in shallow soils, by cemented or rocky layers. Permanent wetness is easily diagnosed and can, under certain conditions, be remedied by drainage. Similarly, contrasting texture is easy to diagnose and sometimes to remedy by (deep) ploughing. The depth of cemented layers and rock is not difficult to establish either. A cemented layer, however, is often fractured, and plant roots can penetrate through and beyond it.

The effect of a cemented layer or any other type of obstruction to root penetration (e.g. extreme acidity, salinity, sodicity or permanent wetness) needs to be carefully assessed. In practice it is often not easy to establish the actual and potential rooting depth but good observation can help to make the relevant and right estimate.

Cation Exchange Capacity

The 'cation exchange capacity' (CEC) of a soil is defined as the amount of cations that can be adsorbed per unit mass (in cmol/kg or meq/100g). The higher the cation exchange capacity, the more the soil solution is buffered against additions of particular cations, because an exchange of cations can occur between the soil solution and the exchange complex. A small CEC means that small amounts of cations (e.g. hydrogen ions from plant roots) have a pronounced effect on the cation balance of the soil solution.

The range in cation exchange capacity for three kinds of clays and organic matter is given in Table 3.4.

Kaolinite has a low CEC and organic matter a very high CEC. Soils that are characterized by kaolinite as the predominant clay mineral and the absence of appreciable amounts of organic matter, have a very low CEC. Such conditions are common in many tropical soils.

Table 3.4 Cation exchange capacity (CEC) of various clay minerals and organic matter (Young 1976)

Component	CEC (meq/100 g)	
Kaolinite	3	- 15
Illite	10	- 40
Montmorillonite	100	- 150
Organic matter	100	- 350

Base Saturation

The 'base saturation' refers to that part of the cation exchange capacity which is saturated with basic cations

$$BS = \frac{\gamma_{Ca} + \gamma_{Mg} + \gamma_K + \gamma_{Na}}{CEC} \quad (3.13)$$

where γ_{Ca} , γ_{Mg} , γ_K and γ_{Na} refer to the amounts (in cmol/kg) of the exchangeable calcium, magnesium, potassium and sodium cations. Low values of the base saturation indicate intense leaching.

Salinity

The presence of soluble salts in the soil solution can affect plant growth, depending on the salt concentration and the susceptibility of the plant or crop. Except in cases of very high salinity where salt crystals can be readily seen, the presence of harmful amounts of salt in the soil is generally not observable to the eye. Soil salinity is appraised by measuring the electrical conductivity or salt concentration in soil-water extracts (Chapter 15). Recently, methods have been developed to measure soil salinity directly in the field (Rhoades et al. 1990).

Some plants, called halophytes, can withstand, or even like, saline soils. So, in many cases, the vegetation can be a useful guide in identifying salinity, and particularly salinity patterns. Salinity is mostly associated with a near-neutral, slightly alkaline, soil reaction, unless appreciable amounts of sodium are present, when soil reaction is pronouncedly alkaline.

Sodicity

Sodicity refers to the presence of sodium (Na) ions on the exchange complex and in the soil solution. When sodium is present, the soil aggregates are unstable and are likely to disperse. This lack of stability can cause open drains to collapse or pipe drains to silt up. Other major effects are a reduction in soil permeability, a disturbance of nutrient equilibrium, and toxicity to plants. The physical behaviour of sodic soils will be discussed in Chapter 15. Sodicity, usually expressed by the 'exchangeable sodium percentage' (ESP) and/or the 'sodium adsorption ratio' (SAR), is assessed in the laboratory. The slaking of soil aggregates when wetted can indicate sodicity, and, as remarked earlier, the presence of a columnar structure points to high sodicity.

Sodicity is associated with an alkaline soil reaction. When the pH of the soil solution is higher than 8.2, appreciable amounts of sodium are likely to be present.

Soil Acidity and Alkalinity

Acidity is a general term that refers to the amount of hydrogen ions in the soil solution. Acidity is indicated by the pH, which is the negative logarithm of the H-ion concentration. A neutral solution has a pH = 7, an acid solution a pH < 7, and an alkaline solution a pH > 7. The pH of the soil strongly affects the availability of nutrients to plants. Near neutrality (6 < pH < 7.5), there are seldom problems. At pH < 4.5 and at pH > 8.5, there are always problems with the availability of some nutrients and/or with the toxicity of other elements.

The pH is generally measured in the laboratory, although instruments are now available that allow it to be measured in the field. There are also kits that allow an estimate of the pH by the addition of fluids, but these procedures are not always reliable.

The acidity or alkalinity of a soil cannot generally be observed in the field. Extremely alkaline conditions in so-called black alkali soils, however, can sometimes be inferred from the presence of hygroscopic sodium salts. Very acid conditions can be inferred during field observations from the presence of bleak brown jarosite colours in acid sulphate soils.

Low pH values are associated with strong leaching in a wet environment, whereas high pH values are associated with the absence of leaching and, in arid environments, with the presence of sodium ions.

Fertility

Soil fertility is a compound characteristic of a soil. The fertility of a soil, i.e. the ability to supply the nutrients needed by plants for agricultural production (Ahn 1992), depends on characteristics like clay and organic matter content, cation exchange capacity, base saturation, soil acidity and amount of weatherable minerals, but aspects like workability and tilth, may also be included. It should be emphasized also that an evaluation of fertility depends on the socio-economic setting. In an environment where fertilizers are relatively expensive, the chemical aspects of fertility play a more prominent role than the physical aspects. Where fertilizers are cheap, good physical soil conditions are more highly valued than the chemical ones.

3.5 Soil Surveys

This section discusses the role played in soil surveys by field observations, field measurements, and laboratory analyses. It should be emphasized that, to be useful for drainage purposes, a soil map requires additional information. The information embodied in such a soil map should include:

- The topography;
- The soil texture of topsoil, subsoil, and sublayer, preferably to a depth of several metres;
- The occurrence of any layers that would disturb the flow of soil water and rooting;
- Historical watertable fluctuations (hydromorphic properties);
- Hydraulic conductivity;
- Soil-water retention;

- Salinity and sodicity status;
- Soil-mechanical properties.

When combined with geohydrological information, this soil map provides integrated information on the natural conditions in the project area. Chapter 18 elaborates on the procedures to be followed in drainage surveys.

3.5.1 Soil Data Collection

During a first field visit, observations can be made on land use, vegetation, crop performance, micro-relief, surface ponding, and the natural drainage conditions. In soil pits excavated at representative sites, the soil characteristics and properties discussed in Section 3.4 can be studied. Horizontal or vertical differences in these properties are of particular importance.

Other features of the soil or the land cannot be observed directly, but data can be obtained from field measurements. Examples are surface infiltration, permeability (hydraulic conductivity), salinity (electrical conductivity/EC), acidity (pH), crop yield, and topography.

Still other data need to be obtained from laboratory analyses. Depending on the analyses required, disturbed samples can be taken from soil pits or by auger. If needed, undisturbed samples can be taken, usually in special sampling cylinders. The disturbed samples can be used to analyze the particle-size distribution (texture), CEC, electrical conductivity of the saturation extract or other soil-water mix ratios, pH, organic-matter content, nutrients, and micro-nutrients. Undisturbed soil samples are usually analyzed for bulk density, soil-water retention, porosity, saturated and unsaturated hydraulic conductivity. Methods of soil analysis are extensively described by Klute et al. (1986).

Some properties can be measured both in the field and in the laboratory. In general, the results of laboratory analyses are more accurate, but cost more to obtain. In cases where laboratory measurements are preferred, a combination of a large number of field measurements, complemented by a few laboratory measurements, could be the right approach. Hydraulic conductivity measurements obtained from small samples often show a wide scatter due to the heterogeneity of the soil. The large-scale field methods that will be discussed in Chapter 12, however, can incorporate the effect of soil heterogeneity.

Though many visual observations yield only a qualitative picture, this picture can be highly relevant. Quite often, lengthy and costly measurements can be omitted if, prior to the start of a measuring and sampling programme, some field observations are made. These can be done quickly and at low cost. Even so, the possibilities and advantages of visual observations often seem to be overlooked. It is emphasized that these three procedures (i.e. the collection of qualitative information during field visits, the collection of data from field measurement programmes, and the collection of data from laboratory analyses) are complementary. Hence, in making proper assessments from soil surveys conducted for drainage purposes, each of these techniques should be used to its full advantage.

3.5.2 Existing Soil Information

When a tract of land has a drainage problem and consideration is being given to improving that situation, a proper inventory and description of the existing drainage conditions first has to be made. One has to understand the way in which these conditions are affecting the present land use. Subsequently, the factors that are causing the deficient drainage conditions have to be identified. Only when the problem has been properly diagnosed can a remedy be devised.

Possible sources of information that may already be available in the area are aerial photographs and satellite imagery, topographic maps, soil maps, vegetation or land-use maps, and farmers' experiences.

The existence and pattern of a natural drainage system in the area can be inferred from aerial photographs, satellite images, and topographic maps.

Soil maps often provide information on drainage conditions, and if they are available, they should always be consulted. In The Netherlands, the soil maps provided by the Soil Survey Institute indicate the soil texture and also the groundwater-fluctuation class. Other soil maps may give no explicit information on drainage conditions, depending, of course, on the purpose for which the soil maps were made. Nevertheless, many soil maps do contain information that refers implicitly to the drainage conditions. If the map includes a descriptive legend of the soil-mapping units, more information on drainage can be retrieved. If the legend is based on a soil classification system, a soil scientist can assist in fully interpreting the map.

Vegetation and land-use maps can provide a good impression of the extent of areas with particular drainage problems. The natural vegetation of well-drained soils is characterized by different species than the natural vegetation of poorly-drained soils. Differences in the morphology and physiognomy (appearance) of the vegetation also indicate differences in drainage conditions. Similarly, arable crops are generally cultivated on well-drained soils, while poorly-drained soils are often used for grazing or for meadow grassland. Vegetation does not, however, give direct information on the feasibility of improving drainage.

Farmers and other residents who have often lived all their lives in or around the area of interest can provide the drainage engineer with useful information. Farmers try to use all kinds of land and are therefore generally able to provide information that will assist the engineer in assessing the technical or financial feasibility of particular drainage improvements. Farmers can provide historical data on floods, on trials and experiences with different forms of land use, and on attempts to improve the drainage conditions of waterlogged soils.

3.5.3 Information to be Collected

After interpreting the information collected from the sources discussed above, one can establish a measurement program to collect the required additional data. What one basically has to obtain is a good insight into all those environmental aspects that one needs to judge the feasibility and the design of an improved drainage situation. A comprehensive list of the relevant soil and land features is presented in Tables 3.5A, 3.5B and 3.6.

Table 3.5A Soil features relevant to subsurface drainage (after Van Beers 1979)

Main aspects	Mechanism to be characterized or predicted	Depth being considered (m)	Some soil characteristics and properties, and other data to be interpreted
Intake at the land surface	Surface infiltration	0 - 0.3 Upper root zone mainly	Infiltration rate Soil texture Swelling of clays Organic matter content Presence of free carbonates Soil structure Structure stability Soil crusts Soil pH Soil colour Soil consistency Visible pores and cracks Root density
Vertical flow through the soil profile	Percolation to the groundwater	0.3 - 1.2 Lower root zone	In addition to the items mentioned above; Rooting depth and root development Particular layers impeding vertical flow
	Capillary rise from the groundwater		Seasonal fluctuations of the watertable Height of capillary rise Unsaturated hydraulic conductivity Electrical conductivity and chemical composition of the groundwater
Horizontal flow mainly	Flow to drains	1.2 - 5.0 Shallow substratum	Soil texture of substrata Depth and thickness of impervious layer(s) Depth and thickness of pervious layer(s) Hydraulic conductivity of permeable and impermeable layers Transmissivity (KD value) Groundwater depth Chemical composition of the groundwater Soil structure and structure stability
	Groundwater flow	> 5.0 Deep substratum	Transmissivity Groundwater quality Sources of salinity

Artificial drainage is implemented to prevent or alleviate waterlogging and subsequent salinization of irrigated areas in arid and semi-arid regions, and to prevent or alleviate waterlogging in the humid tropical and the temperate regions. Although the principles of drainage in both cases are the same, differences in the nature of soils and the processes prevailing in these soils warrant a different approach in soil surveys and other investigations. In semi-arid and arid climates, for example, one has to assess the capillary-rise flux of saline water, whereas, in humid tropical and temperate areas, this process is often less relevant.

As will be shown in the subsequent chapters of this book, the nature of the drainage

Table 3.5B Soil features relevant to surface drainage (after Van Beers 1979)

Main aspects	Mechanisms to be characterized or predicted	Depth being considered	Some soil characteristics and properties, and other data to be interpreted
Horizontal flow	Overland flow Surface channel flow Soil erosion	Land surface only	Slope (degree and length) Vegetation cover (herb, shrub and tree layer) Natural stream channels (distribution, size, depth, gradient) Channel obstructions Roads and culverts Micro-topography or surface irregularity
Water storage or soil water retention	Drainable pore space Storage capacity Land use Cultivation practice Antecedent water conditions	Both the land surface and the root zone	Soil water profiles during high and low groundwater levels Soil water retention curves Soil texture Soil structure

problem and other conditions determine which of the data presented in Tables 3.5 and 3.6 have to be considered for further observation and measurements. The essential task is to assess the water movement and a water balance of the area (Chapter 16), both under the present conditions and after possible improvements.

3.5.4 Soil Survey and Mapping

The availability of a topographic base, preferably in the form of a topographic map with contour lines, is the first requirement for a soil survey. The topographic base serves for choosing observation sites, for plotting observations and drawing boundaries, and for checking the correctness of soil boundaries. If a topographic base is not available, some of the topographic information needed can be derived from recent aerial photographs or satellite pictures.

When soil changes are associated with transitions at the soil surface or in the vegetation cover, and these form a pattern, one speaks of a 'soil association'. When these changes are unpredictable and cannot be mapped, – sometimes because the surveyor has been unable to identify the components through lack of time –, one speaks of a 'soil complex' (e.g. a valley complex).

In practice, the topography is often a very good aid in locating changes in soils. Conversely, it is common practice to compare the soil pattern with the topography. Wherever a soil boundary and a contour line are approximately perpendicular to each other, one has reason to make a careful check whether the soil boundaries are correct. Similarly, the quality of a soil map is doubtful if it shows no signs of a broad relation between soils and topography.

A recent development in The Netherlands is to use soil-survey data to improve the assessment of the soil-hydrological properties of land areas (Wösten et al. 1985, 1988).

Table 3.6 Soil and land features relevant to changes in soil properties as a result of drainage practices

Main aspects	Mechanisms to be characterized or predicted	Depth being considered (m)	Some soil characteristics and properties, and other data to be interpreted
Soil physical properties	Subsidence	0 - 5.0	Presence of mud and peat deposits (thickness, water content, organic matter content, soil texture) Drainage base (field drainage system, main drainage system, and outlet)
	Soil ripening	0 - 2.0	Crack and biopore development Aeration mottles Irreversible water losses Hydraulic conductivity
Soil chemical properties	Oxidation of pyrites	0 - 1.2	Presence of pyrites
	(De)salinization and (de)sodification		Electrical conductivity and chemical composition of soil water extracts Sodium adsorption ratio Exchangeable sodium percentage Structure stability

The methodology relates these soil-hydrological properties (i.e. the relation between soil-water content and matric head, and the unsaturated hydraulic conductivity) with other soil properties (e.g. the clay, silt, and organic-matter content, the median particle size of the sand fraction, and the bulk density). The relationships are established for soil horizons, but not for soil profiles or soil mapping units. Based on these relationships, soil maps can be translated into maps of particular soil-hydrological constants.

3.6 Soil Classification

3.6.1 Introduction

This section will briefly explain how the most widely-used soil classification systems work and will indicate what useful information the drainage engineer can obtain from soil classifications.

Unfortunately, unlike the taxonomy of flora and fauna for which the Linnean system is universally accepted, no system of soil classification can yet claim worldwide acceptance. Most countries had already developed a national soil-classification system prior to the formulation of the FAO- UNESCO 'Legend to the Soil Map of the World', which – although not officially called a classification system – is at present the only taxonomic system with a truly worldwide outlook (FAO-UNESCO 1974; FAO 1988). Another system of near-worldwide application is the Soil Taxonomy System of USDA Soil Conservation Service (Soil Survey

Staff 1975) (Section 3.6.3). Both systems are updated regularly. For a broader spectrum of review, see for instance Young (1976).

3.6.2 The FAO-UNESCO Classification System

FAO has attempted to integrate the useful aspects of various national classification systems into a universal system (FAO-UNESCO 1974; FAO 1988).

The revised legend of the FAO-UNESCO Soil Map of the World (FAO 1988) distinguishes two taxonomic levels: 'major soil groupings' and 'soil units'. There are 28 major soil groupings. The system works by distinguishing groupings and units of soils with characteristics deviant from the other soils. The classification is based on an elimination system: if a soil to be classified does not qualify for the first grouping, the second grouping is checked; if it does not qualify for the second grouping, the third is checked, and so on.

Each major soil grouping is composed of a number of units ranging from 2 to 9. This yields a total of 153 units. The name of a unit consists of an adjective ending in '-ic' and the noun signifying a major grouping (e.g. 'Thionic Fluvisols', which are alluvial soils with a high sulphur content, also known as acid sulphate soils). The FAO-UNESCO Classification System uses 40 different adjectives. For an explanation of the meaning of the names of the major soil groupings and the unit name adjectives, see FAO (1988).

The major soil groupings and soil units are identified with a key, which uses the following differentiating criteria: 7 master horizons, 16 diagnostic horizons, and 28 diagnostic properties. The master horizons were presented in Section 3.3.2. Some diagnostic properties which explicitly refer to the drainage conditions of soils are presented in Section 3.6.5.

Finally, soil units can be subdivided into soil phases. This division at the third level is made in view of soil management, and is based on rooting depth, groundwater depth, hydraulic conductivity, layers of high salinity, etc.

3.6.3 The USDA/SCS Classification System

In contrast to the FAO Legend, the USDA/SCS Soil Taxonomy (Soil Survey Staff 1975; 1992) distinguishes four taxonomic levels: 'orders', 'suborders', 'great groups', and 'subgroups'. The Soil Taxonomy naming system makes use of root suffixes for the orders, prefixes for the suborders, prefixes for the great groups, and adjectives for the subgroups. The system uses lengthy criteria for separation at each of the four levels. It has a total of nearly 2000 subgroups. The Thionic Fluvisol used as an example for the FAO/UNESCO System would, in this classification, be:

- Order: ENTisol (soils with only limited profile development);
- Suborder AQUENT (wet entisols);
- Great group SULFAQUENT (wet entisols with sulphidic (= acid sulphate) properties in the profile);
- And two subgroups:
 - The haplic Sulfaquent with a good bearing capacity; and
 - The typic Sulfaquent with a poor bearing capacity.

3.6.4 Discussion

The major soil groupings identified in the FAO legend are to a large extent genetic types (i.e. they are related to the formation of the soil). Though the system of classification is artificial, it leads to more or less natural groupings, many of which have been recognized in earlier soil classification systems. Moreover, the groupings are in general identifiable in the field, and most groupings exhibit particular characteristics that are relevant for agricultural use.

The USDA Classification is a morphometric system, which means that all properties used to describe the soils can be measured in the field or in the laboratory. The great detail of the USDA Classification makes it a classification to be used only by, and for, soil specialists. For more general purposes, the FAO-UNESCO System deserves preference. Young (1976) and FitzPatrick (1986) discuss the differences between the two classification systems.

The FAO-UNESCO Classification System combines the first- and second-level separation of soil groups and soil units in one key, whereas the USDA/SCS Soil Taxonomy uses a key for each level of separation. The key for first-level separation in the USDA/SCS System has no relation to the drainage conditions of the soil.

3.6.5 Soil Classification and Drainage

The soils described in this section are major soil groupings and units from the FAO/UNESCO Classification System. These are soils that often pose problems for drainage (Section 3.7). The characteristics mentioned below may also be identified at soil-unit level (i.e. when a soil is classified into another major soil grouping).

Histosols are all organic soils or peat soils with an organic layer at least 0.40 m thick.

Vertisols are heavy, often dark, clay soils (more than 30% clay), which develop large and deep cracks. Intensive alternating shrinkage and swelling result in a typical micro-relief of mounds (gilgai) and slickensides at some depth. In the topsoil of *Vertisols*, the common structure sequence shows granular structure elements on top of prismatic elements.

Fluvisols are young soils developed on recent alluvial deposits in river valleys and deltas, former lakes, and coastal regions (fluvial, lacustrine, and marine deposits, respectively). Most *Fluvisols* consist of stratified layers with different textures. *Thionic Fluvisols*, known as acid sulphate soils, have a sulphuric horizon or sulphidic material, or both, at less than 1.25 m depth.

Solonchaks are saline soils with a high content of soluble salts, mainly chlorides and sulphates. Saline soils are defined by the electrical conductivity of the saturation extract (Chapter 15).

Gleysols are soils dominated by hydromorphic properties in the upper 0.50 m of the profile (i.e. soils with a shallow watertable). (For a description of gleyic properties, see below.)

Planosols are soils with a heavily leached surface soil (E-horizon) over a clayey impermeable pan that is often an argillic or natric B-horizon. The surface layer shows stagnic properties (see below). *Planosols* have a structureless surface layer on top of prismatic structure elements.

Solonetz are soils with a natric B-horizon, which is an argillic horizon (accumulation of alluvial clay) with an Exchangeable Sodium Percentage ESP > 15% (Chapter 15). Solonetz or sodic soils have granular structure elements on top of columnar structure elements.

Plinthosols are soils containing plinthite (i.e. a clayey soil material with intense red mottles, rich in iron and poor in organic matter). Plinthite irreversibly hardens if it dries out, and is then called ironstone. Ironstone often occurs as a hardpan.

The worldwide occurrence of these major groupings can be appreciated from the 1:5 000 000 FAO-UNESCO Soil Map of the World (FAO-UNESCO 1974) and the more recent World Soil Resources Map at scale 1:25 000 000 (FAO 1991).

Soil units that have deficient drainage are those with gleyic or stagnic properties. Gleyic properties are bluish grey colours caused by conditions of semi-permanent reduction, present within 1.00 m of the surface. Stagnic properties are brown mottles caused by temporary reduction or alternating wetting and drying, present within 0.50 m of the surface.

Apart from gleyic and stagnic properties, other properties may refer implicitly to the drainage conditions (e.g. abrupt textural changes, or shallow soils).

3.7 Agricultural Use and Problem Soils for Drainage

3.7.1 Introduction

Many soils throughout the world are unsuitable, or only marginally suitable, for agricultural use. Apart from limitations related to climate, the major soil-related problems are low fertility, excessive salinity and sodicity, limited depth or excessive stoniness, and deficient drainage conditions. Limited soil fertility is, on a worldwide scale, probably the greatest problem, and is often associated with excess acidity. Many tropical soils of limited fertility are only suitable for the cultivation of flooded rice.

Attempts were made to describe the suitability of soils for specific types of land use by land capability classifications (Klingebiel and Montgomery 1961) and land evaluation (FAO 1976, 1985). These techniques, however, are only qualitative and depend strongly on the (often intuitive) judgement of the expert. Present developments are towards computerized quantified techniques with simulation of crop production for different scenarios (Feddes et al. 1978; Driessen and Konijn 1992). These techniques, however, form only an approximation since it is virtually impossible to describe the complete interactive soil-water-crop-atmosphere system with mathematical correctness. Moreover, the data required for such a description are never available on a project scale. Even so, these techniques do enable long-term performance evaluation of agricultural interventions and a reasonable cost-benefit analysis.

The soils that most often pose problems for drainage, or create problems when artificial drainage is introduced, are peat soils, Vertisols, fine-textured alluvial soils, acid sulphate soils, saline soils, sodic soils, and Planosols. Beek et al. (1980) extensively

discuss the properties of these soils, and their potentials for improvement. The effects of their soil characteristics and properties on drainage are given in Table 3.6.

Peat Soils

Peat soils, organic soils, or Histosols vary widely in their physical and chemical properties. The high porosity of peat soils creates problems if peats that are almost saturated with water are reclaimed for the cultivation of dry-land crops. Considerable subsidence can be expected when peat soils and soils with peat layers are drained (Chapter 13). The water regime induced by an artificial drainage system may affect the hydraulic properties of the peat, requiring an adjustment of the drainage system after some years of operation. In addition, increased aeration may adversely affect other physical properties of peat.

Vertisols

Vertisols, also known as black cotton soils, owe their specific properties to the dominance of swelling clay minerals, mainly montmorillonite. In the dry season, these soils develop wide and deep cracks, which close when the clay swells after the first rains. Dry Vertisols may have a high infiltration rate, but, when wetted, they become almost impermeable. Most Vertisols are subject to surface-water stagnation at some period of the year. Under these poor drainage conditions, leaching of soluble components is severely restricted. The optimum soil-water range for tillage is narrow.

Fine-Textured Alluvial Soils

Soil conditions in river plains, deltas, and coastal areas are highly variable because of the type and pattern of sedimentation of the parent material. Lacustrine deposits are more uniform. In general, most Fluvisols with fine-textured layers are deficient in drainage. Loosely-packed muds are found where fine sediments are deposited under permanently submerged conditions. When they are drained, a specific type of initial soil formation takes place, called 'soil ripening'. Soil ripening involves the change of a reduced mud into a normal oxidized soil, and has physical, chemical, and biological aspects (Chapter 13; Pons and Zonneveld 1965).

Acid Sulphate Soils

Acid sulphate soils are formed in marine or brackish sediments. During sedimentation, sulphate (SO_4^{2-}) from sea water is reduced in the presence of organic matter to form pyrite (FeS_2). Further sedimentation gradually changes the environment into a swamp forest, which is waterlogged for most of the year because of poor drainage. Under these conditions, the mineral soil is often covered by a peat layer.

Upon exposure to the air, the pyrite in the soil profile oxidizes to form sulphuric acid, rendering the soil unsuitable for agricultural use. Important characteristics of acid sulphate soils are a pH below 4 and a high clay content. The main problem with potential acid sulphate soils is that they are waterlogged and unripe. If these soils are to be used for agriculture, some drainage has to take place. In this reclamation, great care has to be taken because excessive drainage – often in combination with burning (which destroys the peat layer) – can have a strongly negative impact. Dent (1986) gives a detailed description of the physical and chemical processes that take place in acid sulphate soils, and presents alternative management strategies for

different physical environments. Such strategies aim at preventing acidification of these soils, through a combination of careful water management, a proper choice of crops, liming, and fertilization.

Saline and Sodic Soils

Saline soils and sodic soils, the latter formerly called 'alkali soils', are most widespread in irrigated areas in arid and semi-arid regions, but also occur in the more humid climates, especially in coastal areas. The salts or exchangeable sodium in saline and sodic soils hinder crop growth. For efficient crop production, these salts must be leached from the rootzone. This procedure itself is often problematic because, in most regions where these soils occur, irrigation water is scarce. In addition, many sodic soils have a poor structure and a very low hydraulic conductivity. The physical behaviour of salt-affected soils and techniques for their reclamation are dealt with in Chapter 15.

Planosols

Planosols typically have lower clay contents in their surface horizons than in their slowly-permeable deeper horizons. Planosols are deficient in drainage. Seasonal waterlogging, which hampers plant growth, alternates with drought conditions, whose severity depends on local climatic conditions. Many Planosols have a low natural fertility.

3.7.2 Discussion

The deficiencies of these soils for drainage vary enormously in magnitude, depending, among other things, on the degree of soil development. The scope for improvement can also vary greatly. Well-developed Planosols and Solonetz have poor to very poor drainage characteristics that can hardly be improved. As a consequence, the reclamation of these soils is scarcely worthwhile. On the other hand, fine-textured Fluvisols and Vertisols are often agriculturally usable without drainage measures, and certain Fluvisols and Gleysols can be improved by artificial drainage. In general, for many fine-textured soils, especially those with a high content of montmorillonite clay, the permeability and other properties related to the texture cannot be improved. Under special conditions, however, reclamation may lead to the development of a good and stable porosity and good drainage conditions. The reclaimed parts of Lake IJssel in The Netherlands are proof of this.

References

- Ahn, P.M. 1993. Tropical soils and fertiliser use. Intermediate Tropical Agriculture Series. Longman, Harlow, 264 p.
- Beek, K.J., W.A. Blokhuis, P.M. Driessen, N. van Breemen, R. Brinkman and L.J. Pons 1980. Problem soils: their reclamation and management. In: Land Reclamation and Water Management: Developments, Problems, and Challenges. ILRI Publication 27, Wageningen, pp. 43-72
- Brady, N.C 1990. The nature and properties of soils, 10th ed. Macmillan, New York, 621 p.
- Buringh, P. 1979. Introduction to the soils in tropical and subtropical regions. 3rd ed. PUDOC, Wageningen, 124 p.

- Burrough, P.A. 1986. Principles of geographical information systems for land resources assessment. Clarendon press, Oxford, 193 p.
- Dent, D. 1986. Acid sulphate soils : a baseline for research and development. ILRI Publication 39, Wageningen, 204 p.
- Driessen, P.M. and N.T. Konijn 1992. Land-use systems analysis. Wageningen Agricultural University, Wageningen, 230 p.
- FAO 1976. A framework for land evaluation. Soils Bulletin 32. FAO, Rome, 119 p.
- FAO 1977. Guidelines for soil profile description, 2nd ed. FAO, Rome, 66 p.
- FAO 1979. Soil survey investigations for irrigation. Soils Bulletin 42. FAO, Rome, 188 p.
- FAO 1985. Guidelines: Land evaluation for irrigated agriculture. FAO Soils Bulletin 55. FAO, Rome, 231 p.
- FAO 1988. FAO-UNESCO soil map of the world. Revised Legend. World Soil Resources Report 60. FAO, Rome, 119 p.
- FAO 1991. World soil resources; an explanatory note on the FAO World Soil Resources Map at scale 1:25 000 000. World Soil Resources Reports 66. FAO, Rome, 58 p. + maps.
- FAO-ISRIC 1990. Guidelines for soil profile description, 3rd ed. FAO, Rome, 70 p.
- FAO-UNESCO 1974. Soil map of the world 1:5 000 000. Volume I Legend. (For revised legend, see FAO 1988.). UNESCO, Paris, 59 p.
(Volumes II-IV America, V Europe, VI Africa, VII-IX Asia, X Australasia; reports with maps).
- Feddes, R.A., P.J. Kowalik, and H. Zaradny 1978. Simulation of field water use and crop yield. PUDOC, Wageningen, 89 p.
- FitzPatrick, E.A. 1986. An introduction to soil science. 2nd ed. Longman Scientific and Technical, London, 255 p.
- Jury, W.A., W.R. Gardner and W.H. Gardner 1991. Soil physics. 5th ed. Wiley, New York, 328 p.
- Klingebiel, A.A. and P.H. Montgomery 1961. Land capability classification. U.S. Dept. of Agric., Soil Conserv. Service. Agric. Handbook 210, Washington, 21 p.
- Klute, A., R.C. Dinauer, A.L. Page, R.H. Miller and D.R. Keeney (eds.) 1986. Methods of soil analysis. Part 1 Physical and mineralogical methods (1986); Part 2 Chemical and microbiological methods (1982). Agronomy Monogr. 9. American Society of Agronomy, Madison, 1182 + 1159 p.
- Mitra, G.N., V.A.K. Sharma, and B. Ramamoorthy 1958. Comparative studies on the potassium fixation capacities of Indian soils. Journal of the Indian Society of Soil Science, 6, pp. 1-6.
- Pons, L.J. and I.S. Zonneveld 1965. Soil ripening and soil classification; initial soil formation of alluvial deposits with a classification of the resulting soils. ILRI Publication 13, Wageningen, 128 p.
- Rhoades, J.D., P.J. Shouse, U.J. Alves, Nahid A. Manteghi and S.M. Tesch 1990. Determining soil salinity from soil electrical conductivity using different methods and estimates. Soil Sci. Soc. Am. J., 54, pp. 46-54.
- Sanchez, P.A. 1976. Properties and management of soils in the tropics. Wiley, New York, 618 p.
- Soil Survey Staff 1951. Soil survey manual. USDA Handbook 18. U.S. Department of Agriculture, Washington D.C., 503 p.
- Soil Survey Staff 1975. Soil taxonomy : a basic system of soil classification for making and interpreting soil surveys. Agriculture Handbook 436. USDA Soil Conservation Services, Washington D.C., 754 p.
- Soil Survey Staff 1992. Keys to soil taxonomy. SMSS Technical Monograph 19. 5th edition. Agency for International Development/United States Department of Agriculture, Soil Conservation Service, Soil Management Support Services. Pocahontas Press, Blacksburg, 541 p.
- SSSA 1987. Glossary of soil science terms. Soil Science Society of America, Madison, 38 p.
- Van Beers, W.F.J. 1979. Soils and soil properties. In: Drainage principles and applications, 2nd edition. ILRI, Wageningen, 4 vols.
- Wösten, J.H.M., J. Bouma, and G.H. Stoffelsen 1985. Use of soil survey data for regional soil water simulation models. Soil Sci. Soc. Am. J., 49, pp. 1238-1244.
- Wösten, J.H.M., and M.Th. van Genuchten 1988. Using texture and other soil properties to predict the unsaturated soil hydraulic functions. Soil Sci. Soc. Am. J., 52, pp. 1762-1770
- Young, A. 1976. Tropical soils and soil survey. Cambridge University Press, Cambridge, 468 p.

4 Estimating Peak Runoff Rates

J. Boonstra¹

4.1 Introduction

When designing a drainage project, we have to know the peak runoff rate, for designing the cross-sections of main drainage canals, culverts, and siphons or the capacity of pumping stations. The source of peak runoff is sometimes water from drainage basins surrounding the project area, or it can be water from the project area itself. The source of peak runoff can also be melting snow, possibly in combination with high rainfall. Because this source of peak runoff occurs very locally, we shall not discuss it here. Anyone wanting more information on this subject should refer to the literature (e.g. Chow 1964).

The magnitude of the peak runoff rate is related to the frequency of occurrence; the higher the peak runoff rate, the less frequently it will occur. In drainage projects, the design return period usually ranges from 5 to 25 years.

In this chapter, we shall discuss the rainfall frequency approach. It involves performing a statistical analysis of the recorded rainfall data and then making an estimate of the design return period. Using certain rainfall-runoff relationships, we then convert this design rainfall into a design runoff; the runoff is thus considered indirectly.

4.2 Rainfall Phenomena

The amount of rain that falls in a certain period is expressed as a depth (in mm) to which it would cover a horizontal plane. Rainfall depth is considered a statistical variate, because it differs according to the season of the year, the duration of the observation period, and the area under study.

Rainfall analysis for drainage design can be restricted to that part of the year when excess rainfall may cause damage. If the drainage problem is one of surface drainage for crop protection, the growing season may be the critical period. If the problem is that of surface drainage for erosion control, the off-season may be critical because of the erosion hazard on bare soils. If the problem is one of accommodating peak runoff, the whole hydrological year may be critical.

Rainfall intensity is expressed as a depth per unit of time. This unit can be an hour, a day, a month, or a year. The type of problem will decide which unit of time to select for analysis. For surface drainage, the critical duration is often of the order of some days, depending on the storage capacity of the system and the discharge intensity of the drainage area. For erosion control and the accommodation of peak runoff in small drainage basins, the storage capacities will be small and information on hourly rainfalls may be required.

Rainfall is measured at certain points. It is likely that the rainfall in the vicinity

¹ International Institute for Land Reclamation and Improvement

of a measurement point will be approximately the same, but farther away from the point this will not be true. Point rainfall can be considerably higher than areal rainfall, depending on the duration of the rainfall and the size of the area. The shorter the duration and the larger the area, the smaller the areal rainfall will be with respect to the point rainfall. So, information on areal rainfall is often also required.

To be able to estimate the design rainfall, we need depth-frequency curves of daily rainfall data or depth-duration-frequency curves that are representative of the area under study. This implies that we have to analyze the depth-area and depth-frequency of the recorded rainfall data.

4.2.1 Depth-Area Analysis of Rainfall

The analysis of rainfall is understood here to mean the analysis of area averages of point rainfalls. Usually, one of the following three methods is employed (Figure 4.1):

- The arithmetic mean of rainfall depths recorded at measuring stations located inside the area under consideration;

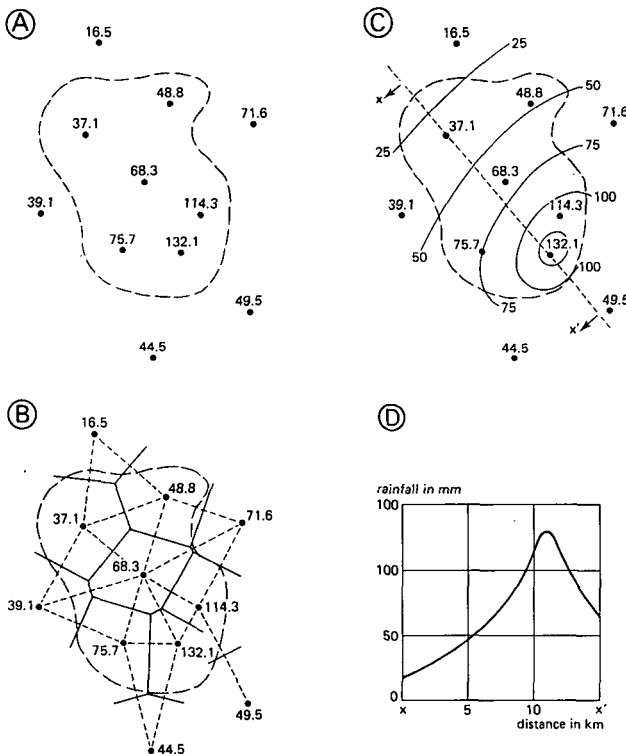

Figure 4.1 Methods of computing areal rainfall: (A) Arithmetic mean method; (B) Thiessen method; (C) Isohyetal method; and (D) Section X-X' of Figure 4.1.C

- The weighted mean of rainfall depths at stations both inside the area and in its immediate surroundings, the weight being determined by polygons constructed according to the Thiessen method;
- The weighted mean of average rainfall depths between isopluvial lines, the weight being the area enclosed by the isopluvials.

An advantage of the arithmetic mean is its simplicity. The method can only be used in a relatively flat area, where no irregular changes occur in isopluvial spacing and where the stations are evenly distributed, thus being equally representative of the area. With this method, the areal rainfall is calculated as follows

$$\frac{37.1 + 48.8 + 68.3 + 114.3 + 75.7 + 132.1}{6} = 79.4 \text{ mm}$$

The Thiessen method assumes that the rainfall recorded at a station is representative of the area half-way to the stations adjoining it. Each station is connected to its adjacent stations by straight lines, the perpendicular bisectors of which form a pattern of polygons. The area for which each station is representative is the area of its polygon, and this area is used as a weight factor for its rainfall. To get the weighted average rainfall, we have to divide the sum of the products of station areas and rainfalls by the total area covered by all stations. With this method, the areal rainfall is calculated as follows:

Rainfall (mm)	Area (km ²)	Area (%)	Weighted rainfall (mm)
16.5	18	1	0.2
37.1	311	19	7.0
48.8	282	17	8.3
68.3	311	19	13.0
39.1	52	3	1.2
75.7	238	15	11.4
132.1	212	13	17.2
114.3	194	12	13.7
Total	1618	99	72.0

The Thiessen method can be used when the stations are not evenly distributed over the area. As the method is rather rigid, however, excluding as it does possible additional information on local meteorological conditions, its use is restricted to relatively flat areas.

When the rainfall is unevenly distributed over the area (e.g. because of differences in topography), the isohyetal method can be applied. This method consists of drawing lines of equal rainfall depth, isopluvials or isohyets, by interpolation between observed rainfall depths at stations. Any additional information available can be used to adjust the interpolation. With this method, the areal rainfall is calculated as follows:

Isohyet (mm)	Rainfall between isohyets (mm)	Area (km ²)	Area (%)	Weighted rainfall (mm)
125	129.5	33	2	2.6
100	112.5	199	12	13.5
75	87.5	300	19	16.6
50	62.5	507	31	19.4
25	37.5	499	31	11.6
<25	23.0	80	5	1.2
Total		1618	100	64.9

From the weighted mean of average rainfalls between two isohyets, the weight being the area enclosed between the isohyets, the areal rainfall is calculated. The reliability of the method depends on the accuracy with which the isopluvials can be drawn.

These methods can be applied when rainfall stations are situated within the study area and in its intermediate surroundings. If there is only one rainfall station in or nearby the study area, we can convert the single station data to areal rainfall data by using empirical relationships established from dense networks elsewhere. Many countries have such depth-area-duration curves available, which can be used in case of a single rainfall station.

Figure 4.2 shows an example of depth-area-duration curves. The average areal rainfall is shown as a percentage of the point rainfall. A different relationship is seen for each duration, with steeper gradients for the shorter durations. These relationships are also influenced by other variables such as return period and total rainfall depth; the effect of these variables on the areal rainfall, however, is often obscured.

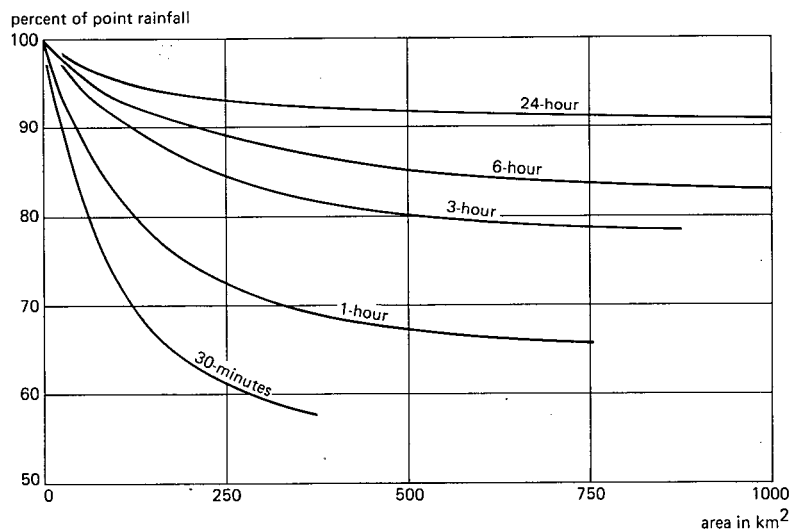

Figure 4.2 Example of depth-area-duration curves (after U.S. Weather Bureau 1958)

Finally, it should be noted that while the curves of Figure 4.2 indicate a reduction for all sizes of area, point rainfalls are often used without reduction for areas up to 25 km².

4.2.2 Frequency Analysis of Rainfall

Basically, rainfall is measured with two types of gauges: non-recording gauges and recording gauges.

In non-recording gauges (or pluviometers), the rainfall is measured by periodical readings of the rain that has accumulated in them. This is generally done every 24 hours, which implies that the distribution of rainfall within the interval of observation remains unknown.

Recording gauges (or pluviographs) give continuous readings of the rain being caught in them. They enable the rainfall depth over any period to be read and are a prerequisite if short-duration rainfalls are to be determined.

Anyone wanting more information on rainfall gauges, including networks, should refer to the literature (e.g. Gray 1973).

On the basis of daily rainfall data, depth-frequency curves can be constructed for successive n-day total rainfalls. (These calculation procedures are discussed in Chapter 6.) Depth-duration-frequency curves that provide information on periods longer than one day are usually sufficient for calculating the design capacity of surface drainage systems.

Depth-duration-frequency curves are often required for durations of less than one day. In such cases, continuous records of rainfall should be available. Sometimes rainfall intensity is used instead of rainfall depth. Figure 4.3 gives an example of an intensity-duration-frequency curve. The two types of curves that provide information

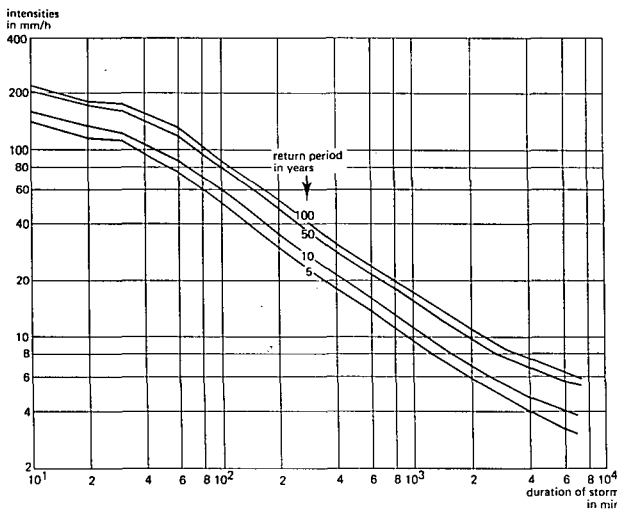

Figure 4.3 Example of intensity-duration-frequency curves

Table 4.1 Ratio of rainfall depth to 2-year 1-hour rainfall depth for different durations and return periods

Rainfall duration	Return period in years				
	2	5	10	25	50
5 min	0.28	0.39	0.48	0.57	0.65
10 min	0.43	0.61	0.73	0.88	1.01
15 min	0.54	0.76	0.91	1.11	1.25
30 min	0.78	1.05	1.35	1.57	1.79
1 h	1	1.35	1.65	2.00	2.25
2 h	1.40	1.89	2.34	2.80	3.15
3 h	1.50	2.02	2.47	3.00	3.37
4 h	1.60	2.16	2.64	3.20	3.60
6 h	1.65	2.25	2.70	3.30	3.70
24 h	2.40	3.25	3.95	4.80	5.40

on any rainfall duration are the basis on which to determine the design rainfall for estimates of peak runoff rates of small areas.

When continuous records of rainfall are not available, the relationships between long and very short duration maximum intensities derived from other sites can be used. Many such relationships exist; they have in common that they plot as straight lines on log-log paper.

Another approach is to use generalized ratios of maximum rainfall of certain durations with certain return periods to 2-year, 1-hour rainfall. Table 4.1 gives an example of such relationships; they give fairly good estimates for countries as different as the U.S.A., Tunisia, Indonesia (Java), and The Netherlands. It will be clear that using these kinds of relationships for arbitrarily chosen areas can yield appreciable errors in the design rainfall.

It should be noted that available rainfall records that are representative of an area often encompass too short a period for a reliable frequency analysis. If no information such as that in Table 4.1 is available, the following procedure can be used. The rainfall data of the station with the short period of records is compared with the corresponding data of a station with a sufficiently long period of records. This is done with a regression analysis as is discussed in Chapter 6. The results of the frequency analysis made for the station with the long period of records can then be converted to frequency data representative of the area under study.

4.3 Runoff Phenomena

4.3.1 Runoff Cycle

The runoff cycle, which is a part of the hydrological cycle, is shown in Figure 4.4. Part of the rainfall will be temporarily stored on the vegetation; this interception will eventually evaporate or reach the soil as stem flow. Rainfall actually reaching the

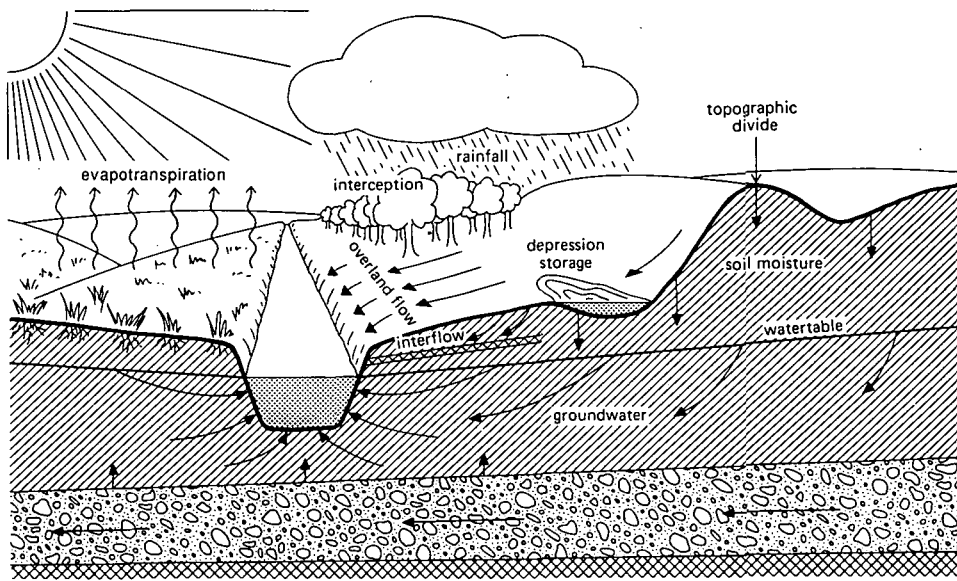

Figure 4.4 Schematization of the runoff cycle

soil may infiltrate into it and part of it will merely become soil moisture, only to be lost again by transpiration or evaporation.

The soil moisture excess will percolate to the watertable and replenish the groundwater system. The groundwater system is slow to respond to the additional supply of infiltrating rain water. When this water is finally discharged into the channel system, it makes up the groundwater runoff, or base flow. Although its contribution to peak runoff is generally small, groundwater runoff in some areas represents the greater part of the annual runoff and is the only source of stream flow during protracted dry spells.

For short high-intensity rainfalls or for prolonged periods of medium-intensity rainfall, the rainfall rate can exceed the soil's maximum infiltration rate. The surplus rainfall will then build up in topographic depressions, from which it will infiltrate or evaporate when the rainfall ceases. If the topographic depressions fill up and begin to overflow, overland flow starts and this water reaches the channel system via rivulets and rills. In areas with deep, highly permeable soils, overland flow may not occur at all, even after rainfalls of the highest intensities. Peak runoff rates are then exclusively attributable to groundwater runoff.

There are thus two main paths by which rainfall water moves to the channel system: over the soil surface and through the groundwater system. Short circuits, however, must also be expected to occur. Water that has already infiltrated into the soil may move over a shallow layer of low permeability, to be forced out again at a lower point of the slope where it changes into overland flow; this process is called interflow. On the other hand, water moving over the soil surface may still become groundwater if it enters an area with a high infiltration capacity, where it infiltrates into the soil.

Overland flow and interflow together make up the direct runoff, which moves swiftly through the drainage basin to the outlet. This direct runoff, together with the groundwater runoff, yields the total runoff from a drainage basin.

For a constant rainfall on a relatively dry basin, Figure 4.5 shows the time variations of the above hydrological components. The rain that falls on the channel system itself is not considered a separate component of runoff, because it is usually a relatively small amount and is included in the direct runoff.

In general, the direct runoff is the major cause of the peak runoff; the shaded area in Figure 4.5 represents this volume. The direct runoff, in its turn, is caused by the excess rainfall (i.e. that part of the total rainfall that contributes to the direct runoff). Thus, as far as the direct runoff is concerned, the difference between excess rainfall and total rainfall are 'losses', which comprise interception, depression storage, and that part of the infiltrated water that either evaporates or percolates to the groundwater system.

4.3.2 Runoff Hydrograph

A drainage basin is the entire area drained by a stream in such a way that all streamflow originating in the area is discharged through a single outlet. The topographic divide that encloses the drainage basin designates the area in which overland flow will move towards the drainage system and ultimately become runoff at the outlet. Topographic maps or aerial photographs are used to determine the actual size of a drainage basin.

According to Chow (1964), the main characteristics of a basin are:

- Geometric factors (e.g. size, shape, slope, and stream density);
- Physical factors: land use and cover, surface infiltration conditions, soil type, geological conditions (e.g. permeability and capacity of the groundwater system), topographic conditions (e.g. the presence of lakes and swamps), artificial drainage;
- Channel characteristics (e.g. size and shape of cross-section, slope, roughness, length).

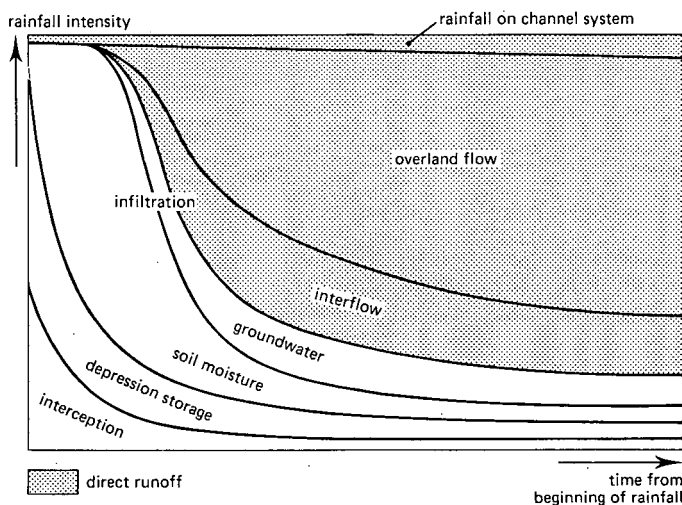

Figure 4.5 Distribution of the total rainfall with time over the various components of the runoff cycle

A graph showing the total runoff at the outlet of a drainage basin with time is called a hydrograph. The hydrograph includes the integrated contributions from overland flow, interflow, and groundwater flow, defining the complexities of the basin characteristics by a single empirical curve.

A typical hydrograph produced by a concentrated high-intensity rainfall is a single-peak skew distribution curve (Figure 4.6). If multiple peaks appear in a hydrograph, they may indicate abrupt variations in rainfall intensity, a succession of high-intensity rainfalls, or other causes.

All single-peaked hydrographs follow the same general pattern (Figure 4.6). This pattern shows a period of rise, culminating in a peak runoff rate, followed by a period of decreasing runoff. Three principal parts can be distinguished:

- A rising limb from Point A, which represents the beginning of direct runoff, to Point B, the first inflection point; its geometry depends on the duration and intensity distribution of the rainfall, the antecedent moisture condition in the drainage basin, and the shape of the basin;
- A crest segment from the first Inflection Point B to the second Inflection Point D, including the peak of the total runoff hydrograph, Point C. The peak runoff represents the highest concentration of the runoff. It usually occurs at a certain time after the rainfall has ceased; this time depends on the areal distribution of the rainfall and its duration;
- A recession limb from Point D onwards. Point D is commonly assumed to mark the cessation of overland flow and interflow at the outlet of the drainage basin. The recession limb represents the withdrawal of water from storage: surface storage, channel storage, and groundwater storage.

The drainage basin, with all its specific characteristics, can thus be regarded as the 'intermediate agent' that turns rainfall on the basin into runoff at the outlet.

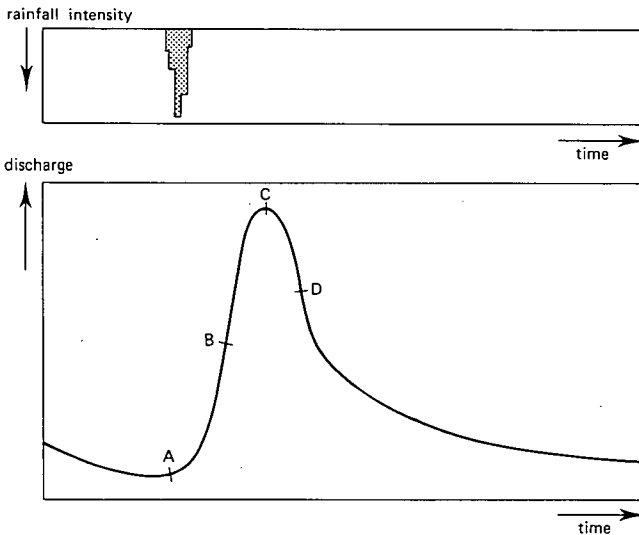

Figure 4.6 A single-peaked hydrograph of total runoff

4.3.3 Direct Runoff Hydrograph

Any hydrograph of total runoff can be considered a hydrograph of direct runoff, superimposed on a hydrograph of groundwater runoff. Methods of estimating peak runoff rates, which are based on the volume of direct runoff, have been developed. It is thus logical to attempt to separate the total runoff hydrograph into two parts, so that the phenomenon of direct runoff can be analyzed independently.

Let us consider a single-peaked hydrograph of total runoff as shown in Figure 4.7A. The sharp departure at Point A designates the arrival of direct runoff at the point of measurement. The start of direct runoff can usually be determined from a visual inspection of the hydrograph of total runoff.

Locating the end of the direct runoff is less straightforward, but we make use of the fact that the recession limb of a hydrograph of total runoff represents the depletion of water from different storages, as was mentioned in the previous section. When

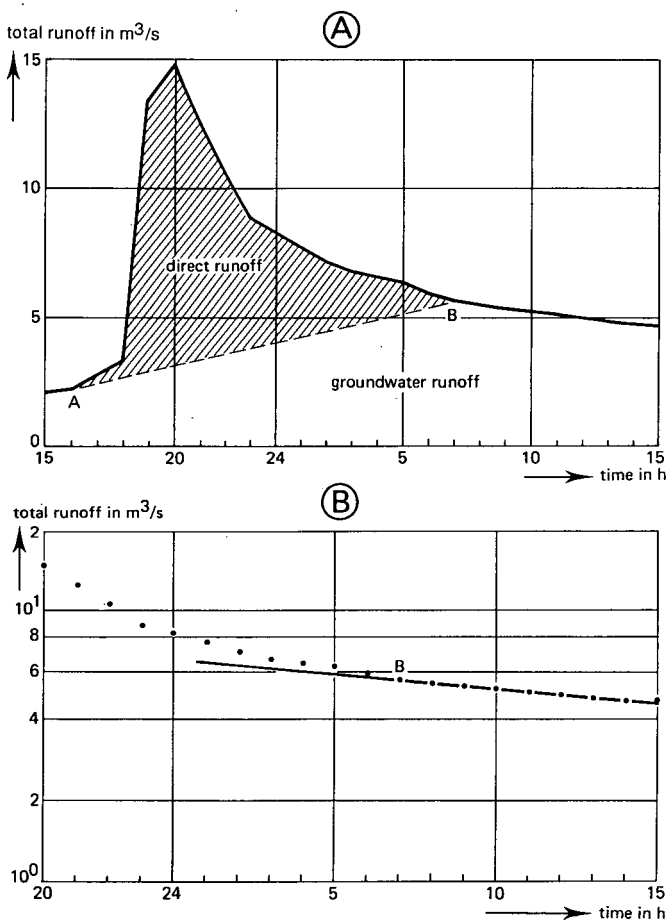

Figure 4.7 Observed hydrograph of total runoff: (A) Separation into direct runoff and groundwater runoff; and (B) Recession limb of hydrograph of total runoff with groundwater depletion curve (straight line)

surface and channel storage have been depleted, the depletion of the groundwater system continues. Thus the recession limb of the hydrograph of total runoff will eventually merge into the groundwater depletion curve. It is commonly assumed that the depletion of a groundwater system can be described by an exponential function; in other words, the groundwater depletion curve should produce a straight line when plotted on semi-logarithmic paper. So, the point where the recession limb of the hydrograph of total runoff merges into a straight line when plotted on semi-log paper, designates the time when both surface and channel storage have been depleted and direct runoff has come to an end (Point B in Figure 4.7B).

A simplified procedure to separate the direct runoff from the groundwater runoff is to draw a straight line between Points A and B (Figure 4.7A). The shaded area in Figure 4.7.A represents the total volume of direct runoff, which is the sum of overland flow and interflow. The time interval (A) – (B) designates the duration of direct runoff and is called the base length of the hydrograph of direct runoff.

4.4 The Curve Number Method

For drainage basins where no runoff has been measured, the Curve Number Method can be used to estimate the depth of direct runoff from the rainfall depth, given an index describing runoff response characteristics.

The Curve Number Method was originally developed by the Soil Conservation Service (Soil Conservation Service 1964; 1972) for conditions prevailing in the United States. Since then, it has been adapted to conditions in other parts of the world. Although some regional research centres have developed additional criteria, the basic concept is still widely used all over the world.

From here on, runoff means implicitly direct runoff.

4.4.1 Derivation of Empirical Relationships

When the data of accumulated rainfall and runoff for long-duration, high-intensity rainfalls over small drainage basins are plotted, they show that runoff only starts after some rainfall has accumulated, and that the curves asymptotically approach a straight line with a 45-degree slope.

The Curve Number Method is based on these two phenomena. The initial accumulation of rainfall represents interception, depression storage, and infiltration before the start of runoff and is called initial abstraction. After runoff has started, some of the additional rainfall is lost, mainly in the form of infiltration; this is called actual retention. With increasing rainfall, the actual retention also increases up to some maximum value: the potential maximum retention.

To describe these curves mathematically, SCS assumed that the ratio of actual retention to potential maximum retention was equal to the ratio of actual runoff to potential maximum runoff, the latter being rainfall minus initial abstraction. In mathematical form, this empirical relationship is

$$\frac{F}{S} = \frac{Q}{P - I_a} \quad (4.1)$$

where

- F = actual retention (mm)
- S = potential maximum retention (mm)
- Q = accumulated runoff depth (mm)
- P = accumulated rainfall depth (mm)
- I_a = initial abstraction (mm)

Figure 4.8 shows the above relationship for certain values of the initial abstraction and potential maximum retention. After runoff has started, all additional rainfall becomes either runoff or actual retention (i.e. the actual retention is the difference between rainfall minus initial abstraction and runoff).

$$F = P - I_a - Q \quad (4.2)$$

Combining Equations 4.1 and 4.2 yields

$$Q = \frac{(P - I_a)^2}{P - I_a + S} \quad (4.3)$$

To eliminate the need to estimate the two variables I_a and S in Equation 4.3, a regression analysis was made on the basis of recorded rainfall and runoff data from small drainage basins. The data showed a large amount of scatter (Soil Conservation Service 1972). The following average relationship was found

$$I_a = 0.2 S \quad (4.4)$$

Combining Equations 4.3 and 4.4 yields

$$Q = \frac{(P - 0.2 S)^2}{P + 0.8 S} \text{ for } P > 0.2 S \quad (4.5)$$

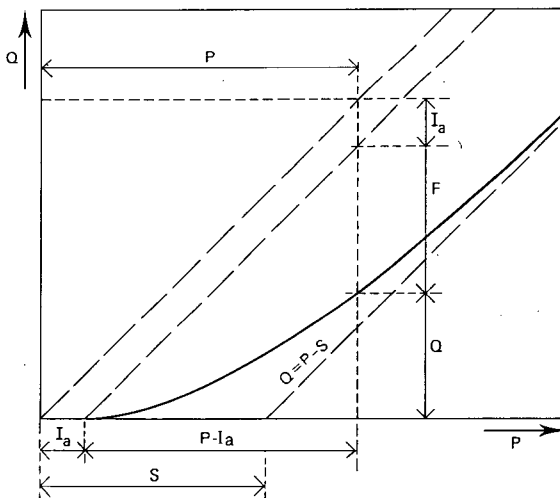

Figure 4.8 Accumulated runoff Q versus accumulated rainfall P according to the Curve Number Method

Equation 4.5 is the rainfall-runoff relationship used in the Curve Number Method. It allows the runoff depth to be estimated from rainfall depth, given the value of the potential maximum retention S . This potential maximum retention mainly represents infiltration occurring after runoff has started. This infiltration is controlled by the rate of infiltration at the soil surface, or by the rate of transmission in the soil profile, or by the water-storage capacity of the profile, whichever is the limiting factor.

The potential maximum retention S has been converted to the Curve Number CN in order to make the operations of interpolating, averaging, and weighting more nearly linear. This relationship is

$$CN = \frac{25400}{254 + S} \tag{4.6}$$

As the potential maximum retention S can theoretically vary between zero and infinity, Equation 4.6 shows that the Curve Number CN can range from one hundred to zero.

Figure 4.9 shows the graphical solution of Equation 4.5, indicating values of runoff depth Q as a function of rainfall depth P for selected values of Curve Numbers. For paved areas, for example, S will be zero and CN will be 100; all rainfall will become runoff. For highly permeable, flat-lying soils, S will go to infinity and CN will be zero; all rainfall will infiltrate and there will be no runoff. In drainage basins, the reality will be somewhere in between.

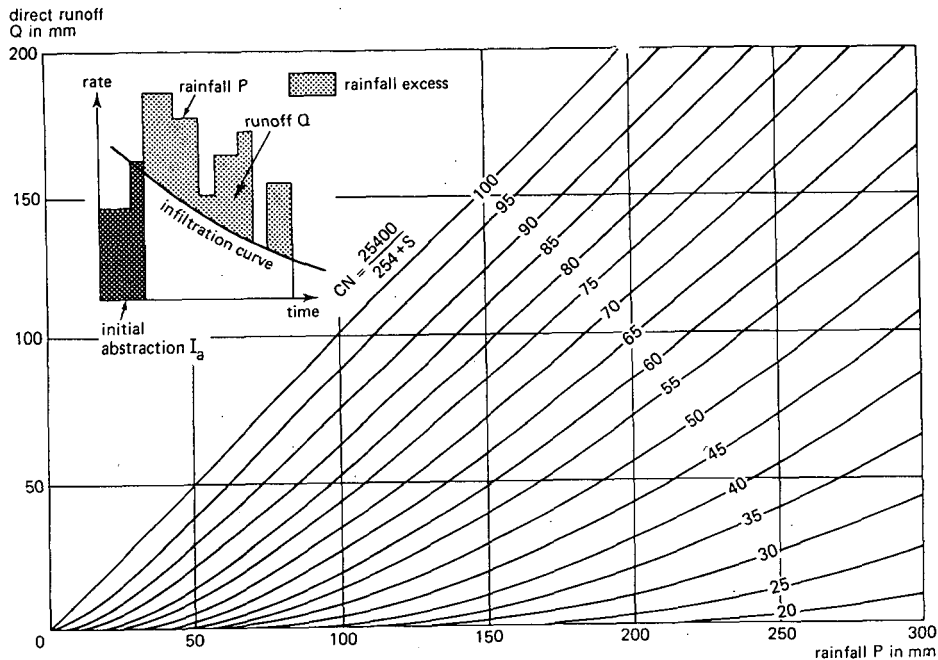

Figure 4.9 Graphical solution of Equation 4.5 showing runoff depth Q as a function of rainfall depth P and curve number CN (after Soil Conservation Service 1972)

Remarks

- The Curve Number Method was developed to be used with daily rainfall data measured with non-recording rain gauges. The relationship therefore excludes time as an explicit variable (i.e. rainfall intensity is not included in the estimate of runoff depth);
- In the Curve Number Method as presented by Soil Conservation Service (1964; 1972), the initial abstraction I_a was found to be 20% of the potential maximum retention S . This value represents an average because the data plots showed a large degree of scatter. Nevertheless, various authors (Aron et al. 1977, Fogel et al. 1980, and Springer et al. 1980) have reported that the initial abstraction is less than 20% of the potential maximum retention; percentages of 15, 10, and even lower have been reported.

4.4.2 Factors Determining the Curve Number Value

The Curve Number is a dimensionless parameter indicating the runoff response characteristic of a drainage basin. In the Curve Number Method, this parameter is related to land use, land treatment, hydrological condition, hydrological soil group, and antecedent soil moisture condition in the drainage basin.

Land Use or Cover

Land use represents the surface conditions in a drainage basin and is related to the degree of cover. In the SCS method, the following categories are distinguished:

- Fallow is the agricultural land use with the highest potential for runoff because the land is kept bare;
- Row crops are field crops planted in rows far enough apart that most of the soil surface is directly exposed to rainfall;
- Small grain is planted in rows close enough that the soil surface is not directly exposed to rainfall;
- Close-seeded legumes or rotational meadow are either planted in close rows or broadcasted. This kind of cover usually protects the soil throughout the year;
- Pasture range is native grassland used for grazing, whereas meadow is grassland protected from grazing and generally mown for hay;
- Woodlands are usually small isolated groves of trees being raised for farm use.

Treatment or Practice in relation to Hydrological Condition

Land treatment applies mainly to agricultural land uses; it includes mechanical practices such as contouring or terracing, and management practices such as rotation of crops, grazing control, or burning.

Rotations are planned sequences of crops (row crops, small grain, and close-seeded legumes or rotational meadow). Hydrologically, rotations range from poor to good. Poor rotations are generally one-crop land uses (monoculture) or combinations of row crops, small grains, and fallow. Good rotations generally contain close-seeded legumes or grass.

For grazing control and burning (pasture range and woodlands), the hydrological condition is classified as poor, fair, or good.

Pasture range is classified as poor when heavily grazed and less than half the area is covered; as fair when not heavily grazed and between one-half to three-quarters of the area is covered; and as good when lightly grazed and more than three-quarters of the area is covered.

Woodlands are classified as poor when heavily grazed or regularly burned; as fair when grazed but not burned; and as good when protected from grazing.

Hydrological Soil Group

Soil properties greatly influence the amount of runoff. In the SCS method, these properties are represented by a hydrological parameter: the minimum rate of infiltration obtained for a bare soil after prolonged wetting. The influence of both the soil's surface condition (infiltration rate) and its horizon (transmission rate) are thereby included. This parameter, which indicates a soil's runoff potential, is the qualitative basis of the classification of all soils into four groups. The Hydrological Soil Groups, as defined by the SCS soil scientists, are:

- Group A: Soils having high infiltration rates even when thoroughly wetted and a high rate of water transmission. Examples are deep, well to excessively drained sands or gravels.
- Group B: Soils having moderate infiltration rates when thoroughly wetted and a moderate rate of water transmission. Examples are moderately deep to deep, moderately well to well drained soils with moderately fine to moderately coarse textures.
- Group C: Soils having low infiltration rates when thoroughly wetted and a low rate of water transmission. Examples are soils with a layer that impedes the downward movement of water or soils of moderately fine to fine texture.
- Group D: Soils having very low infiltration rates when thoroughly wetted and a very low rate of water transmission. Examples are clay soils with a high swelling potential, soils with a permanently high watertable, soils with a clay pan or clay layer at or near the surface, or shallow soils over nearly impervious material.

Antecedent Moisture Condition

The soil moisture condition in the drainage basin before runoff occurs is another important factor influencing the final CN value. In the Curve Number Method, the soil moisture condition is classified in three Antecedent Moisture Condition (AMC) Classes:

- AMC I: The soils in the drainage basin are practically dry (i.e. the soil moisture content is at wilting point).
- AMC II: Average condition.
- AMC III: The soils in the drainage basins are practically saturated from antecedent rainfalls (i.e. the soil moisture content is at field capacity).

These classes are based on the 5-day antecedent rainfall (i.e. the accumulated total rainfall preceding the runoff under consideration). In the original SCS method, a distinction was made between the dormant and the growing season to allow for differences in evapotranspiration.

4.4.3 Estimating the Curve Number Value

To determine the appropriate CN value, various tables can be used. Firstly, there are tables relating the value of CN to land use or cover, to treatment or practice, to hydrological condition, and to hydrological soil group. Together, these four categories are called the Hydrological Soil-Cover Complex. The relationship between the CN value and the various Hydrological Soil-Cover Complexes is usually given for average conditions, i.e. Antecedent Soil Moisture Condition Class II. Secondly, there is a conversion table for the CN value when on the basis of 5-day antecedent rainfall data the Antecedent Moisture Condition should be classified as either Class I or Class III.

Hydrological Soil-Cover Complex

For American conditions, SCS related the value of CN to various Hydrological Soil-Cover Complexes. Table 4.2 shows this relationship for average conditions (i.e. Antecedent Moisture Condition Class II). In addition to Table 4.2, Soil Conservation Service (1972) prepared similar tables for Puerto Rico, California, and Hawaii. Rawls and Richardson (1983) prepared a table quantifying the effects of conservation tillage on the value of the Curve Number. Jackson and Rawls (1981) presented a table of Curve Numbers for a range of land-cover categories that could be identified from satellite images.

All the above-mentioned tables to determine Curve Numbers have in common that slope is not one of the parameters. The reason is that in the United States, cultivated land in general has slopes of less than 5%, and this range does not influence the Curve Number to any great extent. However, under East African conditions, for example, the slopes vary much more. Five classes to qualify the slope were therefore introduced (Sprenger 1978):

I	< 1%	Flat
II	1 – 5%	Slightly sloping
III	5 – 10%	Highly sloping
IV	10 – 20%	Steep
V	> 20%	Very steep

The category land use or cover was adjusted to East African conditions and combined with the hydrological condition. Table 4.3 shows the Curve Numbers for these Hydrological Soil-Cover Complexes.

With the aid of tables such as Tables 4.2 and 4.3 and some experience, one can estimate the Curve Number for a particular drainage basin. The procedure is as follows:

- Assign a hydrological soil group to each of the soil units found in the drainage basin and prepare a hydrological soil-group map;
- Make a classification of land use, treatment, and hydrological conditions in the drainage basin according to Table 4.2 or 4.3 and prepare a land-use map;
- Delineate the main soil-cover complexes by superimposing the land-use and the soil-group maps;
- Calculate the weighted average CN value according to the areas they represent.

Table 4.2 Curve Numbers for Hydrological Soil-Cover Complexes for Antecedent Moisture Condition Class II and $I_a = 0.2 S$ (after Soil Conservation Service 1972)

Land use or cover	Treatment or practice	Hydrological condition	Hydrological soil group			
			A	B	C	D
Fallow	Straight row	Poor	77	86	91	94
Row crops	Straight row	Poor	72	81	88	91
	Straight row	Good	67	78	85	89
	Contoured	Poor	70	79	81	88
	Contoured	Good	65	75	82	86
	Contoured/terraced	Poor	66	74	80	82
	Contoured/terraced	Good	62	71	78	81
Small grain	Straight row	Poor	65	76	84	88
	Straight row	Good	63	75	83	87
	Contoured	Poor	63	74	82	85
	Contoured	Good	61	73	81	84
	Contoured/terraced	Poor	61	72	79	82
	Contoured/terraced	Good	59	70	78	81
Close-seeded legumes or rotational meadow	Straight row	Poor	66	77	85	89
	Straight row	Good	58	72	81	85
	Contoured	Poor	64	75	83	85
	Contoured	Good	55	69	78	83
	Contoured/terraced	Poor	63	73	80	83
	Contoured/terraced	Good	51	67	76	80
Pasture range		Poor	68	79	86	89
		Fair	49	69	79	84
		Good	39	61	74	80
	Contoured	Poor	47	67	81	88
	Contoured	Fair	25	59	75	83
	Contoured	Good	6	35	70	79
Meadow (permanent)		Good	30	58	71	78
Woodlands (farm woodlots)		Poor	45	66	77	83
		Fair	36	60	73	79
		Good	25	55	70	77
Farmsteads			59	74	82	86
Roads, dirt			72	82	87	89
Roads, hard-surface			74	84	90	92

Table 4.3 Curve Numbers for Hydrological Soil-Cover Complexes for Antecedent Moisture Condition Class II and $I_a = 0.2 S$ (after Sprenger 1978)

Land use or cover	Slopes	Hydrological soil group			
		A	B	C	D
Rice fields or mangroves or swamps	I	0	0	3	5
	II	0	5	8	10
	III	5	10	13	15
	IV		non-existent		
	V		non-existent		
Pasture or range in good hydrological condition	I	33	55	68	74
	II	39	61	74	80
	III	42	64	77	83
	IV	44	66	79	85
	V	45	67	80	86
Woods in poor hydrological condition	I	39	60	71	77
	II	45	66	77	83
	III	49	70	81	87
	IV	52	73	84	90
	V	54	75	86	92
Pasture or range in poor hydrological condition	I	63	74	81	84
	II	68	79	86	89
	III	71	82	89	92
	IV	73	84	91	94
	V	74	85	92	95

Antecedent Moisture Condition Class

By using Tables 4.2 and 4.3, we obtain a weighted average CN value for a drainage basin with average conditions (i.e. Antecedent Moisture Condition Class II). To determine which AMC Class is the most appropriate for the drainage basin under consideration, we have to use the original rainfall records. The design rainfall that was selected in the frequency analysis usually lies between two historical rainfall events. The average of the 5-day total historical rainfall preceding those two events determines

Table 4.4 Seasonal rainfall limits for AMC classes (after Soil Conservation Service 1972)

Antecedent Moisture Condition Class	5-day antecedent rainfall (mm)		
	Dormant season	Growing season	Average
	1	2	3
I	< 13	< 36	< 23
II	13 – 28	36 – 53	23 – 40
III	> 28	> 53	> 40

the AMC Class. Table 4.4 shows the corresponding rainfall limits for each of the three AMC Classes.

Columns 2 and 3 give the values as they are used under American conditions, specified for two seasons. Column 4 gives the values under East African conditions; they are the averages of the seasonal categories of Columns 2 and 3.

When, according to Table 4.4, the AMC Class is not Class II, the Curve Number as determined from Tables 4.2 or 4.3 should be adjusted according to Table 4.5.

Remarks

Used as antecedent precipitation index in the original Curve Number Method is the 5-day antecedent rainfall. In the literature, other periods have been reported to be more representative. Hope and Schulze (1982), for example, used a 15-day antecedent period in an application of the SCS procedure in the humid east of South Africa, and Schulze (1982) found a 30-day antecedent period to yield better simulations of direct runoff in humid areas of the U.S.A., but a 5-day period to be applicable in arid zones.

4.4.4 Estimating the Depth of the Direct Runoff

Once the final CN value has been determined, the direct runoff depth can be calculated.

Table 4.5 Conversion table for Curve Numbers (CN) from Antecedent Moisture Condition Class II to AMC Class I or Class III (after Soil Conservation Service 1972)

CN AMC II	CN AMC I	CN AMC III	CN AMC II	CN AMC I	CN AMC III
100	100	100	58	38	76
98	94	99	56	36	75
96	89	99	54	34	73
94	85	98	52	32	71
92	81	97	50	31	70
90	78	96	48	29	68
88	75	95	46	27	66
86	72	94	44	25	64
84	68	93	42	24	62
82	66	92	40	22	60
80	63	91	38	21	58
78	60	90	36	19	56
76	58	89	34	18	54
74	55	88	32	16	52
72	53	86	30	15	50
70	51	85	25	12	43
68	48	84	20	9	37
66	46	82	15	6	30
64	44	81	10	4	22
62	42	79	5	2	13
60	40	78	0	0	0

This can be done in two ways:

- Graphically, by using the design rainfall depth in Figure 4.9 and reading the intercept with the final CN value;
- Numerically, by using Equation 4.6 to determine the potential maximum retention S and substituting this S value and the design rainfall depth into Equation 4.5.

Flat Areas

In flat areas, the problem is to remove a certain depth of excess surface water within an economically determined period of time. Applying the Curve Number Method for different durations of design rainfall will yield corresponding depths of direct runoff. These values in fact represent layers of stagnant water which are the basis for determining the capacity of surface drainage systems. Example 4.1 shows such an application of the Curve Number Method.

Example 4.1

Suppose we have an ungauged drainage basin of flat rangeland. The soils have a low infiltration rate and a dense grass cover. As rainfall data, we shall use the intensity-duration-frequency curves shown in Figure 4.3. For this basin, we would like to know the depth of the direct runoff with a return period of 10 years for Antecedent Moisture Condition Class II.

First, we estimate the CN value for this basin. The land use is given as rangeland and the treatment practice is taken as contoured since the area is flat. Because of the dense grass cover, we select the hydrological condition 'good'. The infiltration rate of the soils is described as low and we therefore select the Hydrological Soil Group C. Using Table 4.2, we now find a CN value of 71 for AMC Class II. When we use Table 4.3, we have to define the slope category. Since we have contoured rangeland, we take slope category I. According to Table 4.3, the CN value is 68 for AMC Class II. So, a CN value of 70 seems a realistic estimate. Using Equation 4.6, we obtain for this value a potential maximum retention S of some 109 mm.

Next, we determine the appropriate rainfall data. From Figure 4.3, we can determine the depth of design rainfall as a function of its duration for the given return period of 10 years. This information is shown in Columns 1, 2, and 3 of Table 4.6.

We can now calculate the depth values of the direct runoff by substituting into Equation 4.5 the above S value and the rainfall depth data in Column 3 of Table 4.6. The data in Column 4 of Table 4.6 show the results of these calculations. These direct-runoff-depth data as a function of the duration of the design rainfall are the basis on which to determine the capacity of surface drainage systems in flat areas (as will be discussed in the Chapters 19 and 20).

Remarks

If we assume that the antecedent moisture condition in the drainage basin is not characterized as Class II but as Class III, the CN value of 70 should be adjusted according to Table 4.5. This yields an adjusted CN value of 85. The potential maximum retention S then changes to some 45 mm.

The data in Column 5 of Table 4.6 show the corresponding direct-runoff-depth data. From these data, it can be seen that changing the AMC Class from II to III

Table 4.6 Values of rainfall depth and corresponding direct runoff depth as a function of rainfall duration and AMC Class for a design return period of 10 years

Design rainfall			Direct runoff	
Duration (h)	Intensity (mm/h)	Depth (mm)	Depth (mm) AMC II	Depth (mm) AMC III
1	2	3	4	5
1	88	88	25	50
2	53	106	37	66
3	39	117	44	76
4	32	128	52	86
5	27	135	58	93
24	8.7	209	118	163
48	5.6	269	172	222
72	4.6	331	229	283

will result in direct-runoff-depth-data which are up to 100% greater. This illustrates the importance of selecting the appropriate AMC Class. The depth of direct runoff changes greatly when the CN value is adjusted to either AMC Class I or III. This is due to the discrete nature of the AMC Classes. Hawkins (1978) developed an alternative method to adjust the CN value on the basis of a simplified moisture-accounting procedure; the advantage of this method is that no sudden jumps in CN value are encountered.

Sloping Areas

In sloping areas, the problem is to accommodate the peak runoff rate at certain locations in the drainage basin. This peak runoff rate will determine the required cross-sections of main drainage canals, culverts, bridges, etc. Applying the Curve Number Method is now a first step in the calculation procedure. It gives only the depth of 'potential' direct runoff, but not how this direct runoff, following the topography and the natural drainage system, will produce peak runoff rates at certain locations. Example 4.2 shows an application of the Curve Number Method in such a situation.

Example 4.2

Suppose we have an ungauged drainage basin of highly sloping pasture land. The soils have a high infiltration rate and the hydrological condition can be characterized as poor because of heavy grazing. From Tables 4.2 and 4.3, we find a CN value of 68 and 71, respectively. So, again a CN value of 70 seems a realistic estimate.

Suppose we select from Table 4.6 a design rainfall with a duration of 3 hours. In the next section, it will be shown that, to apply the Unit Hydrograph Method, it is often necessary to split up the rainfall duration into a number of consecutive 'unit storm periods'. Suppose this unit storm period is calculated as 30 minutes. For each of these periods, the depths of direct runoff are then required for AMC Class II. The procedure to do this will now be explained.

Table 4.7 Values of rainfall depth and corresponding depth of direct runoff for a rainfall of 117 mm and a duration of 3 hours for a design return period of 10 years

Duration (h)	Rainfall (accumulated) (mm)	Direct runoff (accumulated) (mm)	Half-hour period	Direct runoff depth (mm)
1	2	3	4	5
0.0	0.0	0.0		
0.5	19.5	0.0	1	0.0
1.0	39.0	2.4	2	2.4
1.5	58.5	9.3	3	6.9
2.0	78.0	19.2	4	9.9
2.5	97.5	31.1	5	11.9
3.0	117.0	44.4	6	13.3

If no information is available on how the amount of design rainfall (117 mm) is distributed over the 3-hour period, the usual assumption is that the intensity will be uniformly distributed. This gives a rainfall intensity of 39 mm/h. Columns 1 and 2 of Table 4.7 give the accumulated rainfall amounts for 6 consecutive half-hour periods.

We can now calculate the depth values of direct runoff by substituting into Equation 4.5 the S value of 109 mm and the rainfall-depth data in Column 2 of Table 4.7. The data in Column 3 of Table 4.7 represent the accumulated direct-runoff-depth data. The direct runoff depth per half hour period can now be calculated (Columns 4 and 5 in Table 4.7).

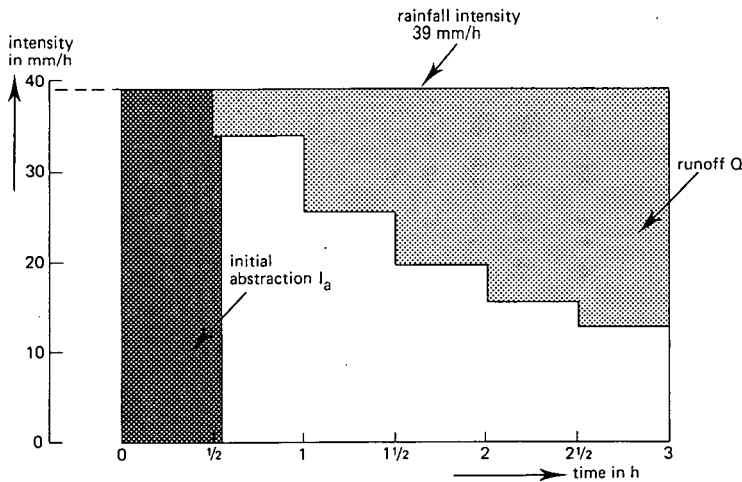

Figure 4.10 Graphical representation of the design rainfall and corresponding runoff for a selected duration of 3 hours

Figure 4.10 shows these results graphically by presenting the values of rainfall and runoff as intensities instead of depths. It can be seen from Figure 4.10 that the duration of direct runoff is shorter than the rainfall duration; the lower the CN value, the shorter the direct runoff duration will be with respect to the rainfall duration. Figure 4.10 can be compared with the inset of Figure 4.9; both were constructed in an identical manner, but the inset shows a historical rainfall with varying intensities within its duration.

So, by applying the above procedure, we can specify the direct runoff for a succession of arbitrarily chosen periods within the selected duration of the design rainfall. These data are the basis on which to determine the peak runoff rate in sloping areas, as will be discussed in the next sections.

4.5 Estimating the Time Distribution of the Direct Runoff Rate

To estimate the time distribution of the direct runoff rate at a specific location in the drainage basin, we apply the Unit Hydrograph Method. For drainage basins where no runoff has been measured, the Method is based on a parametric unit hydrograph shape.

The concept of the unit hydrograph has been the subject of many papers. Unit hydrograph procedures have been developed, from graphical representations such as those presented by Sherman (1932), to generalized mathematical expressions. In the following, we shall explain the Unit Hydrograph Method on the basis of Sherman's approach.

The direct runoff discussed in the previous section as representing a depth uniformly distributed over the drainage basin is renamed 'excess rainfall' to differentiate it from the direct runoff rate that will pass a certain point in the drainage basin, which is the subject of this section.

4.5.1 Unit Hydrograph Theory

Since the physical characteristics of a basin (shape, size, slope, etc.) remain relatively constant, one can expect considerable similarity in the shape of hydrographs resulting from similar high-intensity rainfalls. This is the essence of the Sherman theory.

Sherman first introduced the unit hydrograph as the hydrograph of direct runoff resulting from 1 mm of excess rainfall generated uniformly over the basin area at a uniform rate. By comparing unit hydrographs of drainage basins with similar physical characteristics, he found that the shape of these unit hydrographs was still not similar due to differences in the duration of the excess rainfall of 1 mm.

Sherman next introduced a specified period of time for the excess rainfall and called it the 'unit storm period'. He found that for every drainage basin there is a certain unit storm period for which the shape of the hydrograph is not significantly affected by changes in the time distribution of the excess rainfall over this unit storm period.

This means that equal depths of excess rainfall with different time-intensity patterns produce hydrographs of direct runoff which are the same when the duration of this

excess rainfall is equal to or shorter than the unit storm period. So, assuming a uniformly distributed time-intensity for the excess rainfall will not affect the shape of the hydrograph of direct runoff. This implies that any time-intensity pattern of excess rainfall can be represented by a succession of unit storm periods, each of which has a uniform intensity.

This unit storm period varies with characteristics of the drainage basin; in general, it can be taken as one-fourth of the time to peak (i.e. from the beginning to the peak of the hydrograph of direct runoff).

Sherman, after analyzing a great number of time-intensity graphs (hyetographs) of excess rainfall with a duration equal to or smaller than the unit storm period, concluded that the resulting hydrographs for a particular drainage basin closely fit the following properties:

- The base length of the hydrograph of direct runoff is essentially constant, regardless of the total depth of excess rainfall;
- If two high-intensity rainfalls produce different depths of excess rainfall, the rates of direct runoff at corresponding times after the beginning of each rainfall are in the same proportion to each other as the total depths of excess rainfall;
- The time distribution of direct runoff from a given excess rainfall is independent of concurrent runoff from antecedent periods of excess rainfall.

The principle involved in the first and second of these statements is known as the principle of proportionality, by which the ordinates of the hydrograph of direct runoff are proportional to the depth of excess rainfall. The third statement implies that the hydrograph of direct runoff from a drainage basin due to a given pattern of excess rainfall at whatever time it may occur, is invariable. This is known as the principle of time invariance.

These fundamental principles of proportionality and time invariance make the unit hydrograph an extremely flexible tool for developing composite hydrographs. The total hydrograph of direct runoff resulting from any pattern of excess rainfall can be built up by superimposing the unit hydrographs resulting from the separate depths of excess rainfall occurring in successive unit time periods. In this way, a unit hydrograph for a relatively short duration of excess rainfall can be used to develop composite hydrographs for high-intensity rainfalls of longer duration. Figure 4.11 shows the above principles graphically.

Suppose that the excess rainfall period can be schematized by three successive unit storm periods with, respectively, 1, 3, and 1.5 mm excess rainfall. Applying the principles of proportionality and time invariance results in three separate hydrographs for each of the amounts of excess rainfall in the individual unit storm periods, as follows:

- The first hydrograph is identical to the unit hydrograph, because the depth of excess rainfall during this period is 1 mm;
- The second hydrograph has ordinates that are three times as high as those of the unit hydrograph and starts one unit storm period later than the first hydrograph;
- The third hydrograph has ordinates that are one-and-a-half times as high as those of the unit hydrograph and starts two unit storm periods later than the first hydrograph.

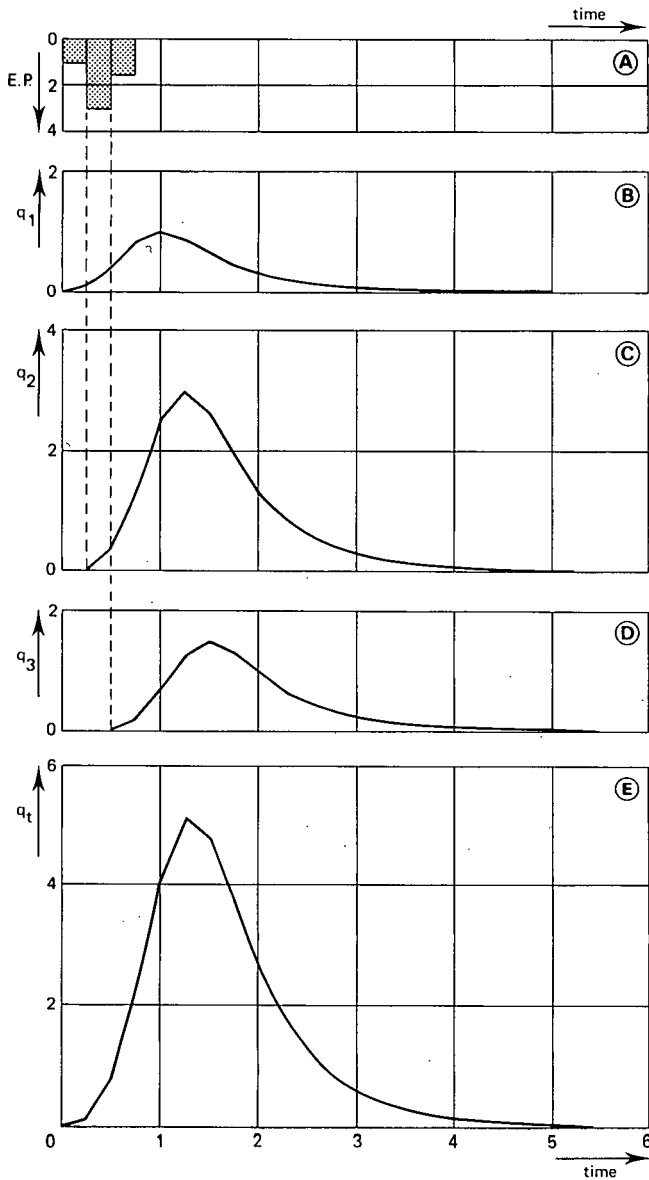

Figure 4.11 Graphical representation of the principles of proportionality, time invariance, and superposition: (A) Time intensity pattern excess rainfall (EP); (B) Hydrograph of runoff due to first unit storm period; (C) Hydrograph of runoff due to second unit storm period; (D) Hydrograph of runoff due to third unit storm period; and (E) Composite hydrograph of runoff due to the succession of the three unit storm periods

Applying the principle of superposition results in one composite hydrograph of direct runoff for the total excess rainfall period of three successive unit storm periods. Graphically, this is done by adding the ordinates of the three separate hydrographs at corresponding times.

So, if we know the shape of the unit hydrograph, we can convert any historical or statistical rainfall into a composite hydrograph of direct runoff by using the Curve Number Method to calculate the excess rainfall depths and the Unit Hydrograph Method to calculate the direct runoff rates as a function of time.

4.5.2 Parametric Unit Hydrograph

Numerous procedures to construct a unit hydrograph for ungauged basins have been developed. In general, these procedures relate physical characteristics (parameters) of a drainage basin to geometric aspects of the unit hydrograph. Most attempts to derive these relationships were aimed at determining time to peak, peak flow, and base length of the unit hydrograph. Here, we present only one of these procedures.

The dimensionless unit hydrograph used by the Soil Conservation Service (1972) was developed by Mockus (1957). It was derived from a large number of natural unit hydrographs from drainage basins varying widely in size and geographical locations. The shape of this dimensionless unit hydrograph predetermines the time distribution of the runoff; time is expressed in units of time to peak T_p , and runoff rates are expressed in units of peak runoff rate q_p . Table 4.8 shows these time and runoff ratios numerically and Figure 4.12 (solid line) shows them graphically.

To change this dimensionless unit hydrograph into a dimensional unit hydrograph, we have to know both the time to peak T_p and the peak runoff rate q_p of the basin. To reduce this two-parameter problem to a one-parameter problem, Mockus (1957) used an equivalent triangular unit hydrograph with the same units of time and runoff as the curvilinear unit hydrograph. Figure 4.12 shows these two hydrographs; both have in common that they have identical peak runoff rates and times to peak. Since the area under the rising limb of the curvilinear unit hydrograph represents 37.5 per cent of the total area, the time base T_b of the triangular unit hydrograph equals $1/0.375 = 2.67$ in order to have also the same total areas under both hydrographs, representing 1 mm of excess rainfall.

Using the equation of the area of a triangle and expressing the volumes in m^3 , we obtain for the dimensional triangular unit hydrograph

$$10^6 A \times 10^{-3} Q = 1/2 (3600 \times q_p) \times 2.67 T_p \quad (4.7)$$

Table 4.8 Dimensionless time and runoff ratios of the SCS parametric unit hydrograph (after Soil Conservation Service 1972)

t/T_p	q_t/q_p	t/T_p	q_t/q_p	t/T_p	q_t/q_p
0	0	1.75	0.45	3.50	0.036
0.25	0.12	2.00	0.32	3.75	0.026
0.50	0.43	2.25	0.22	4.00	0.018
0.75	0.83	2.50	0.15	4.25	0.012
1.00	1.00	2.75	0.105	4.50	0.009
1.25	0.88	3.00	0.075	4.75	0.006
1.50	0.66	3.25	0.053	5.00	0.004

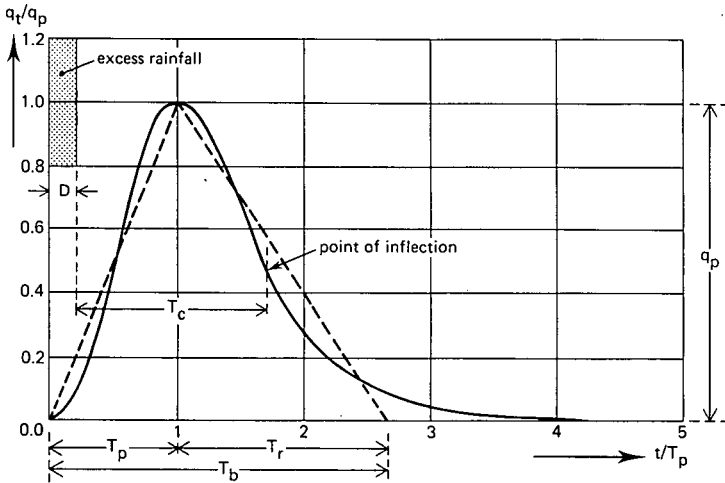

Figure 4.12 Dimensionless curvilinear unit hydrographs (solid line) and equivalent triangular unit hydrograph (dashed line) (after Soil Conservation Service 1972)

where

- A = area of drainage basin (km²)
- Q = excess rainfall (mm)
- q_p = peak runoff rate unit hydrograph (m³/s)
- T_p = time to peak runoff unit hydrograph (h)

Rearranging Equation 4.7 and making q_p explicit yields

$$q_p = 0.208 \frac{A Q}{T_p} \quad (4.8)$$

In Equation 4.8, the only unknown parameter is time to peak T_p. This can be estimated in terms of time of concentration T_c.

The time of concentration is defined as the time for runoff to travel from the hydraulically most distant point in the drainage basin to the outlet or point of interest; it is also defined as the distance between the end of excess rainfall and the inflection point in the recession limb of the dimensionless curvilinear unit hydrograph. Figure 4.12 shows that the inflection point lies at a distance of approximately 1.7 times T_p. Taking the duration of the excess rainfall equal to 0.25 times T_p (unit storm period) gives the following relationship

$$T_p = 0.7 T_c \quad (4.9)$$

For small drainage basins of less than 15 km², the time to peak is regarded as being equal to the time of concentration. This relationship is based on another empirical method, the Rational Method (Chow 1964).

Quite a number of formulas exist for deriving T_c from the physical characteristics of a drainage basin. One of these empirical formulas is given by Kirpich (1940)

$$T_c = 0.02 L^{0.77} S^{-0.385} \quad (4.10)$$

where

T_c = time of concentration (min)

L = maximum length of travel (m)

S = slope, equal to H/L where H is the difference in elevation between the most remote point in the basin and the outlet

The parameters to estimate the time of concentration can be derived from a topographic map. So, by estimating T_c , we can calculate the time to peak T_p and consequently the peak runoff rate q_p . Thus, a dimensional unit hydrograph for a particular basin can be derived from the dimensionless curvilinear unit hydrograph. Example 4.3 shows the calculation procedure.

Example 4.3

Suppose a drainage basin has the shape of a pear. The maximum length of travel in it is about 7600 m and the elevation difference is 25 m. Its area is 2590 ha. For this basin, we would like to know the unit hydrograph.

First, we calculate the time of concentration. Substituting $L = 7600$ m and $H = 25$ m into Equation 4.10 gives

$$T_c = 0.02 (7600)^{0.77} (25/7600)^{-0.385} = 176 \text{ min} = 2.9 \text{ h}$$

Substituting this value of T_c into Equation 4.9 gives

$$T_p = 0.7 \times 2.9 = 2.0 \text{ h}$$

Substituting $A = 25.9 \text{ km}^2$, $Q = 1 \text{ mm}$, and $T_p = 2.0 \text{ h}$ into Equation 4.8 gives

$$q_p = 0.208 \frac{25.9 \times 1}{2.0} = 2.7 \text{ m}^3/\text{s}$$

So the peak runoff rate is $2.7 \text{ m}^3/\text{s}$ for an excess rainfall of 1 mm.

Next, we convert the SCS dimensionless curvilinear unit hydrograph into a dimensional unit hydrograph for this basin. Substituting the above values of T_p and q_p into Table 4.8 gives the runoff rates of this unit hydrograph. Table 4.9 shows these rates.

Table 4.9 shows that the unit hydrograph for this drainage basin has a time base of

Table 4.9 Dimensional time and runoff of the unit hydrograph

t (h)	q_t (m^3/s)	t (h)	q_t (m^3/s)	t (h)	q_t (m^3/s)
0	0	3.5	1.22	7.0	0.10
0.5	0.32	4.0	0.86	7.5	0.07
1.0	1.16	4.5	0.59	8.0	0.05
1.5	2.24	5.0	0.41	8.5	0.03
2.0	2.7	5.5	0.28	9.0	0.02
2.5	2.38	6.0	0.20	9.5	0.02
3.0	1.78	6.5	0.14	10.0	0.01

approximately 10 hours, a time to peak of 2 hours, and a peak runoff rate of 2.7 m³/s.

4.5.3 Estimating Peak Runoff Rates

To obtain the hydrograph of direct runoff for a design storm, we can use the SCS dimensionless unit hydrograph in the same way as the unit hydrograph of Sherman (by the principle of superposition). Example 4.4 explains the calculation procedure.

Example 4.4

In this example, we want to know the peak runoff rate for a design rainfall with a return period of 10 years and a duration of 3 hours. We shall use the information obtained in the previous three examples.

In Example 4.3, we found the unit hydrograph for that basin by using the dimensionless curvilinear unit hydrograph. Since its time to peak is 2 hours, the unit storm period of the excess rainfall should be equal to or less than one-fourth of the time to peak. Suppose we make it equal to half an hour. We then split up the design rainfall duration of 3 hours into six consecutive unit storm periods.

In Example 4.2, we already calculated the depth of direct runoff (= excess rainfall) for each of the six half-hour periods. So we can use the data directly.

By applying the principles of Sherman's Unit Hydrograph Method, we can now calculate the composite hydrograph of direct runoff for the time-intensity pattern of excess rainfall shown in Figure 4.10. This procedure is shown numerically in Table 4.10. The composite hydrograph is plotted in Figure 4.13. As can be seen, the peak runoff rate is approximately 101 m³/s and will occur 4 hours after the start of the design rainfall.

It should be noted that the relationships formulated for the unit hydrograph are not applicable for the composite hydrograph of direct runoff. Its time to peak will always be greater than the time to peak of the unit hydrograph. Another feature is that the total duration of excess rainfall that produces the composite hydrograph of direct runoff will always be greater than one-fourth of its time to peak.

In Example 4.1, we selected from the depth-intensity curves a design rainfall with a return period of 10 years. The total amount of this design rainfall is related to its duration as was shown in Table 4.6. This implies that the above calculation procedures should be repeated for various durations. Table 4.11 shows the results of these calculations. Only one combination of duration and amount of design rainfall will give the highest peak runoff rate for the basin.

Table 4.11 shows that the peak runoff rates increase with increasing duration of the design rainfall, up to a duration of 4 hours; this duration produces the highest peak runoff rate. For durations longer than 4 hours, the peak runoff rate will start to decrease and will continue to decrease. This phenomenon of first increasing peak runoff rates reaching a highest peak runoff rate followed by decreasing peak runoff rates will occur in all basins, but the duration that will produce the highest peak runoff rate cannot be determined beforehand. This implies that the above calculation procedure should be repeated for design rainfalls of increasing duration. Once the peak runoff rates start to decrease, one can stop the calculations.

Table 4.10 Contribution of individual hydrographs for the six consecutive unit storm periods of half an hour, yielding the total composite hydrograph of direct runoff

Unit storm period	1	2	3	4	5	6	
Excess rainfall (mm)	0	2.4	6.9	9.9	11.9	13.3	

Time (h)	Unit hydrograph (m ³ /s)	Hydrographs of unit storm period						Composite hydrograph (m ³ /s)
		1	2	3	4	5	6	
0	0	0						0
0.5	0.32	0	0					0
1.0	1.16	0	0.8	0				1
1.5	2.24	0	2.8	2.2	0			5
2.0	2.70	0	5.4	8.0	3.2	0		17
2.5	2.38	0	6.5	15.5	11.5	3.8	0	37
3.0	1.78	0	5.7	18.6	22.2	13.8	4.3	65
3.5	1.22	0	4.3	16.4	26.7	26.7	15.4	90
4.0	0.86	0	2.9	12.3	23.6	32.1	29.8	101
4.5	0.59	0	2.1	8.4	17.6	28.3	35.9	92
5.0	0.41	0	1.4	5.9	12.1	21.2	31.7	72
5.5	0.28	0	1.0	4.1	8.5	14.5	23.7	52
6.0	0.20	0	0.7	2.8	5.8	10.2	16.2	36
6.5	0.14	0	0.5	1.9	4.1	7.0	11.4	25
7.0	0.10	0	0.3	1.4	2.8	4.9	7.8	17
7.5	0.07	0	0.2	1.0	2.0	3.3	5.5	12
8.0	0.05	0	0.2	0.7	1.4	2.4	3.7	8
8.5	0.03	0	0.1	0.5	1.0	1.7	2.7	6
9.0	0.02	0	0.1	0.3	0.7	1.2	1.9	4
9.5	0.02	0	0.0	0.2	0.5	0.8	1.3	3
10.0	0.01	0	0.0	0.1	0.3	0.6	0.9	2
10.5			0.0	0.1	0.2	0.4	0.7	1
11.0				0.1	0.2	0.2	0.4	1
11.5					0.1	0.2	0.3	1
12.0						0.1	0.3	0
12.5							0.1	0

Table 4.11 Peak runoff rates of the composite hydrograph of direct runoff for different durations of the design rainfall with a return period of 10 years

Duration (h)	Design rainfall		Peak runoff rate
	Duration (h)	Depth (mm)	(m ³ /s)
1		88	66
2		106	93
3		117	101
4		128	108
5		135	106
24		209	53

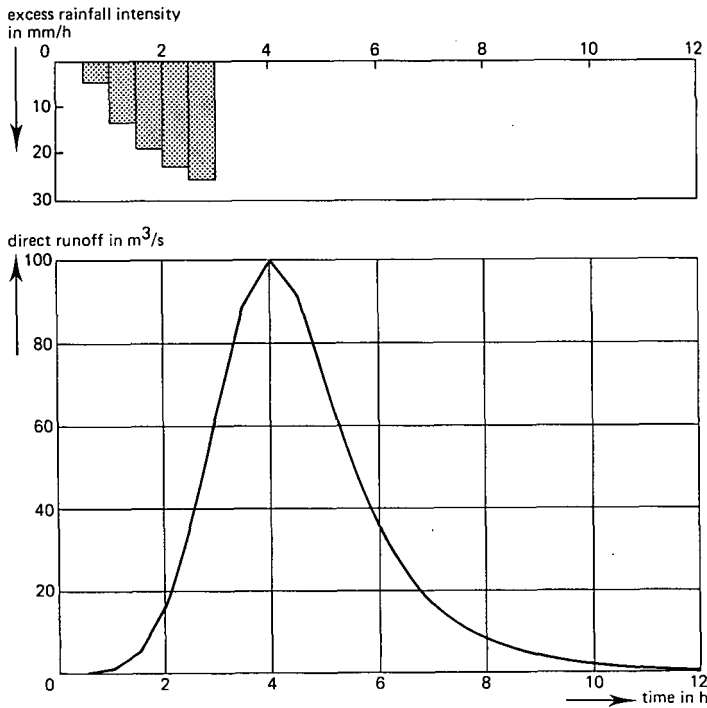

Figure 4.13 Time-intensity pattern of excess rainfall and corresponding composite hydrograph of direct runoff for a return period of 10 years

4.6 Summary of the Calculation Procedure

The calculation procedure discussed in the previous sections is based on the situation where no runoff records are available and a design peak runoff rate has to be estimated from rainfall-runoff relations. This calculation procedure can be summarized in the following steps:

- 1 Select a design frequency. The process of selecting such a frequency (or return period) is not discussed in this chapter; it involves a decision that is fundamental to the designer's intention and to the criteria for the satisfactory performance and safety of the works under consideration. In drainage works, the design return period usually ranges from 5 to 25 years.
- 2 From depth-duration-frequency curves or intensity-duration-frequency curves available for rainfall data and representative for the drainage basin under consideration, select the curve with the frequency that corresponds to the design return period selected in Step 1.
- 3 From the curve selected in Step 2, read the total depths or intensities of rainfall for various durations. Convert intensity data, if available, to depth data. Steps 2 and 3 are illustrated in Example 4.1 of Section 4.4.4. Select one duration with a corresponding total depth of rainfall; this is called the design rainfall.
- 4 Calculate the time to peak of the unit hydrograph for the drainage basin under

- consideration, using empirical relationships as were formulated in Equations 4.9 and 4.10. Step 4 is illustrated in Example 4.3 of Section 4.5.2.
- 5 Split up the duration of design rainfall as selected in Step 3 into a number of consecutive unit storm periods. This unit storm period should be equal to or less than one-fourth of the time to peak as calculated in Step 4.
 - 6 Determine the Curve Number value for the drainage basin under consideration, using Tables 4.2 and/or 4.3. Adjust this CN value, if necessary according to AMC Class I or III, using Tables 4.4 and 4.5. Step 6 is illustrated in Example 4.1 of Section 4.4.4.
 - 7 Calculate the depths of excess rainfall (= direct runoff), using the Curve Number Method for design rainfall depths of accumulated unit storm periods as determined in Step 5 and the CN value as determined in Step 6. For each of the successive unit storm periods, calculate the contribution of excess rainfall depth. Steps 5, 6, and 7 are illustrated in Example 4.2 of Section 4.4.4.
 - 8 Calculate the peak runoff rate of the unit hydrograph for the drainage basin under consideration, using the empirical relationship as was formulated in Equation 4.8.
 - 9 Calculate the ordinates of the dimensional unit hydrograph, using the dimensionless ratios as given in Table 4.8, and time to peak and peak runoff rate values as calculated in Steps 4 and 8, respectively. Steps 8 and 9 are illustrated in Example 4.3 of Section 4.5.2.
 - 10 Calculate the ordinates of the individual hydrographs of direct runoff for each of the unit storm periods, using the ordinates of the unit hydrograph as calculated in Step 9 and the corresponding excess rainfall depths as calculated in Step 7.
 - 11 Calculate the ordinates of the total composite hydrograph of direct runoff by adding the ordinates of the individual hydrographs of direct runoff as calculated in Step 10. The ordinates of these individual hydrographs are lagged in time one unit storm period with respect to each other.
 - 12 Determine the highest value from the ordinates of the total composite hydrograph as calculated in Step 11. This represents the peak runoff rate for a design rainfall with a duration as selected in Step 3.
 - 13 Select durations of design rainfall different from the initial one as selected in Step 3 and read the corresponding total depths of rainfall as determined in Step 3. Repeat Steps 4 to 12. This will yield a set of peak runoff rates. The highest value represents the design peak runoff rate for the drainage basin under consideration. Steps 10 to 13 are illustrated in Example 4.4 of Section 4.5.3.

Remark

The contribution of groundwater runoff is not included in this procedure to estimate the design peak runoff rate. Because the calculation procedure is based on the assumption that no runoff has been measured, this groundwater runoff cannot be determined.

4.7 Concluding Remarks

The availability of depth-duration-frequency or intensity-duration frequency curves as mentioned in Step 2 of the calculation procedure is essential for small drainage

basins. High-intensity rainfalls of short duration (i.e. a few hours) will then produce the highest peak runoff rates. For drainage basins of less than 1300 km², hourly rainfall data are required. It should be noted that this maximum size should be treated as an indication, not as an absolute value.

The above also implies that applying the calculation procedure only on the basis of daily rainfall frequency data will consistently underestimate the peak runoff rate, unless the size of the drainage basin is large. Large in this respect means at least 2500 km².

The reliability of the estimate of the design peak runoff rate depends largely on a proper estimate of the final CN value and the time to peak of the dimensional unit hydrograph.

With regard to the CN value, it can be stated that both its determination from the characteristics of a drainage basin and the selection of the proper Antecedent Moisture Condition Class are crucial. Errors in the latter can result in peak runoff rates up to 100% in error.

With regard to the time to peak of the dimensional unit hydrograph, it can be stated that it is derived from the time of concentration. Because the use of different formulas for deriving the time of concentration results in a wide range of values, and because the relationship between time of concentration and time to peak also varies, the design peak runoff rate with respect to an incorrect value of the time to peak of the unit hydrograph can be more than 100% in error.

The calculation procedure presented will therefore gain substantially in reliability when the above two parameters can be determined from field observations. One should therefore measure at least one, but preferably more flood hydrographs with concurrent rainfall in the drainage basin.

The procedure to determine the CN value for each observed flood hydrograph can be summarized as follows. By hydrograph separation, the area under the thus derived hydrograph of direct runoff can be calculated. This area represents the volume of direct runoff and can be converted to a depth value by dividing it by the area of the drainage basin. Substituting this latter value and the observed concurrent rainfall into the Curve Number equation will yield the potential maximum retention and finally the corresponding Curve Number.

The procedure to determine the time to peak of the unit hydrograph and, with that, its actual shape involves an inverse application of the unit hydrograph theory. Anyone wanting more information on this subject is referred to the literature (Chow et al 1988).

References

- Aron, G.M., A.C. Miller and D.F. Lakatos 1977. Infiltration formula based on SCS curve number. *Journal of Irrigation and Drainage Division*, 103, pp. 419-427.
- Chow, V.T. 1964. *Handbook of applied hydrology*. McGraw-Hill, London, 1418 p.
- Chow, V.T., D.R. Maidment and L.W. Mays 1988. *Applied hydrology*. McGraw-Hill, New York, 572 p.
- Fogel, M.M., L.H. Hekman and L. Duckstein 1980. Predicting sediment yield from strip-mined land. *Symposium on Watershed Management*, Boise, Idaho. Irrigation and Drainage Division of ASCE, pp. 176-187.
- Gray, D.M. 1973. *Handbook on the principles of hydrology*. Water Information Center, Washington, 591 p.

- Hawkins, R.H. 1978. Runoff curve numbers with varying site moisture. *Journal of Irrigation and Drainage Division*, 104, pp. 389-398.
- Hope, A.S. and R.E. Schulze 1982. Improved estimates of stormflow volumes using the SCS curve number method. In: V.P. Singh (ed.), *Rainfall-runoff relationships*. Water Resources Publications, Littleton. pp. 419-431.
- Jackson, T.J. and W.J. Rawls 1981. SCS urban curve numbers from landsat data bases. *Water Resources Bulletin*, 17, pp. 857-862.
- Kirpich, Z.P. 1940. Time of concentration of small agricultural watersheds. *Civil Engineering*, 10, 6, pp. 362.
- Mockus, V. 1957. Use of storm and watershed characteristics in synthetic hydrograph analysis and application. American Geophysical Union, Southwest Region Meeting, Sacramento, California.
- Rawls, W.J. and H.H. Richardson 1983. Runoff curve numbers for conservation tillage. *Journal of Soil and Water Conservation*, 38, pp. 494-496.
- Schulze, R.E. 1982. The use of soil moisture budgeting to improve stormflow estimates by the SCS curve number method. University of Natal, Department of Agricultural Engineering, Report 15, Pietermaritzburg, 63 p.
- Sherman, L.K. 1932. Streamflow from rainfall by the unit-graph method. *Eng. News Record*, 108, pp. 501-505.
- Soil Conservation Service 1964. National engineering handbook, Section 4, Hydrology. Department of Agriculture, Washington, 450 p.
- Soil Conservation Service 1972. National engineering handbook, Section 4, Hydrology. Department of Agriculture, Washington, 762 p.
- Sprenger, F.D. 1978. Determination of direct runoff with the 'Curve Number Method' in the coastal area of Tanzania/East Africa. *Wasser und Boden*, 1, pp. 13-16.
- Springer, E.P., B.J. McGurk, R.H. Hawkins and G.B. Coltharp 1980. Curve numbers from watershed data. Symposium on Watershed Management, Boise, Idaho. Irrigation and Drainage Division of ASCE, pp. 938-950.
- U.S. Weather Bureau 1958. Rainfall intensity-frequency regime. U.S. Weather Bureau, Technical Paper 29, Washington.

5 Evapotranspiration

R.A. Feddes¹ and K.J. Lenselink²

5.1 Introduction

Evapotranspiration is important as a term in the hydrological cycle, e.g. in soil water and groundwater balances (Chapter 16), and in salinization (Chapter 15). In land drainage engineering, we therefore need to devote proper attention to its determination, particularly in arid and semi-arid areas. This applies not only to the various surveys and investigations that precede a drainage design, but also to the subsequent monitoring of the effects of drainage measures on parameters like watertable depth, soil salinity, and, ultimately, on crop yield.

In addition, agriculturists want to have information on the effects of a water supply on crop production. As there is often a direct relation between the ratio of actual to potential evapotranspiration and actual to potential crop yield, agriculturists want to know the specific water requirements of a crop, and whether these requirements are being met under the prevailing environmental conditions. Regular estimates of evapotranspiration may reveal water shortages and/or waterlogging, which can then lead to technical measures to improve irrigation and drainage, and, again ultimately, to an increase in crop yields.

This chapter, after explaining some basic concepts (in Section 5.2), provides brief information on how to measure actual evapotranspiration in the field and on how to estimate the evaporative demand of the atmosphere. Actual evapotranspiration can be measured with the soil water balance approach, or with micro-meteorological methods. These will be briefly discussed in Section 5.3. Actual evapotranspiration can also be estimated with computer models or remote-sensing techniques (Section 5.6.4).

A few empirical, temperature-based methods for estimating potential evapotranspiration are briefly discussed (Section 5.4). The theory of Penman's open water evaporation is treated fairly extensively in Section 5.5. This is followed by the recently accepted Penman-Monteith method of estimating the potential evapotranspiration from cropped surfaces, distinguishing between wet and dry crops, between full and partial soil cover, and between full and limited water supply (Section 5.6). How the preceding theory is applied in practice is explained in Section 5.7, with the use of a reference evapotranspiration and crop coefficients.

5.2 Concepts and Developments

In the past, many empirical equations have been derived to calculate potential evapotranspiration (i.e. evapotranspiration from cropped soils with an optimum water

¹ Agricultural University, Wageningen

² International Institute for Land Reclamation and Improvement

supply). Only two of these methods will be described: one based on air temperature and day length (Blaney and Criddle 1950), and another based on air temperature and solar radiation (Turc 1954; Jensen and Haise 1963).

These empirical correlation methods are often only valid for the local conditions under which they were derived; they are hardly transferable to other areas. Nowadays, therefore, the focus is mainly on physically-based approaches, which have a wider applicability.

For the process of evapotranspiration, three basic physical requirements in the soil-plant-atmosphere continuum must be met. There must be:

A: A continuous supply of water;

B: Energy available to change liquid water into vapour;

C: A vapour gradient to maintain a flux from the evaporating surface to the atmosphere.

The various methods of determining evapotranspiration are based on one or more of these requirements. For example, the soil water balance approach is based on A, the energy balance approach on B, and the combination method (energy balance plus heat and mass transfer) on parts of B and C.

Penman (1948) was the first to introduce the combination method. He estimated the evaporation from an open water surface, and then used that as a reference evaporation. Multiplied by a crop factor, this provided an estimate of the potential evapotranspiration from a cropped surface.

The combination method requires measured climatic data on temperature, humidity, solar radiation, and wind speed. Because even this combination method contains a number of empirical relationships, numerous modifications to adjust it to local conditions have been proposed by a host of researchers.

Analyzing a range of lysimeter data worldwide, Doorenbos and Pruitt (1977) proposed the FAO Modified Penman method, which has found worldwide application in irrigation and drainage projects. These authors adopted the same two-step approach as Penman to estimate crop water requirements (i.e. estimating a reference evapotranspiration, selecting crop coefficients per crop and per growth stage, and then multiplying the two to find the crop water requirements). They replaced Penman's open water evaporation by the evapotranspiration from a reference crop. The reference crop of Doorenbos and Pruitt was defined as 'an extended surface of an 8 to 15 cm tall green grass cover of uniform height, actively growing, completely shading the ground, and not short of water'. There was evidence, however, that the method sometimes over-predicted the crop water requirements.

Using similar physics as Penman did, Monteith (1965) derived an equation that describes the transpiration from a dry, extensive, horizontally-uniform vegetated surface, which is optimally supplied with water. In international literature, this equation is known as the Penman-Monteith equation. In The Netherlands, the name of Rijtema has been added, because this author independently derived a similar formula (Rijtema 1965).

Recent comparative studies (e.g. those by Jensen et al. 1990, who analyzed various methods of estimating potential evapotranspiration) have shown the convincing performance of the Penman-Monteith approach under varying climatic conditions, thereby confirming the results of many individual studies reported over the past years.

An expert consultation on procedures to revise the prediction of crop water

Table 5.1 Meteorological and crop input data that are required for the various computation methods of potential evapotranspiration

Method	Rainfall	Air temperature	Solar radiation	Relative humidity	Wind speed	Aero-dynamic resistance	Basic canopy resistance
Blaney and Criddle (1950)		+					
Jensen and Haise (1963)		+	+				
Turc (1954)	+	+	+				
Penman (1948)		+	+	+	+	+	
Penman-Monteith (1965)		+	+	+	+	+	+

requirements was held in Rome (Smith 1990). There, it was agreed to recommend the Penman-Monteith approach as the currently best-performing combination equation. Potential and actual evapotranspiration estimates would, in principle, be possible with the Penman-Monteith equation, through the introduction of canopy and air resistances to water vapour diffusion.

This direct, or one-step, approach is increasingly being followed nowadays, especially in research environments. Nevertheless, since accepted canopy and air resistances may not yet be available for many crops, a two-step approach is still recommended under field conditions.

The reference crop evapotranspiration in the Penman-Monteith approach is defined as 'the evapotranspiration from a hypothetical crop fully covering the ground, and not short of water, with an assumed crop height of 12 cm, a fixed canopy resistance (70 s/m), and a canopy reflection coefficient of 0.23'. Details of the various parameters to be used in estimating this new reference evapotranspiration were worked out during the Rome meeting and are presented in Section 5.7.2.

The method selected to estimate potential evapotranspiration often depends on what meteorological data are available; the empirical approaches need fewer data than the physically-based methods. Table 5.1 indicates the meteorological input data that are needed for the computation methods discussed in this chapter.

5.3 Measuring Evapotranspiration

5.3.1 The Soil Water Balance Method

Both potential and actual evapotranspiration can be measured with the soil water balance method. The water balance of the soil accounts for the incoming and outgoing fluxes of a soil compartment. This compartment can be one-dimensional (e.g. the rootzone, or the soil profile to a greater depth). The soil water balance equation over a certain period (e.g. 7-10 days) can then be written as the change in water storage, ΔW . Defining ΔW as 'In - Out', we obtain, for a certain period of time

$$\Delta W = I + P - P_i + G - R - ET \quad (5.1)$$

where

- I = irrigation (mm)
- P = precipitation (mm)

- P_i = intercepted precipitation (mm)
- G = upward flow through the bottom (mm)
- R = percolation through the bottom (mm)
- ET = evapotranspiration (mm)

Re-arranging Equation 5.1 yields

$$ET = I + P - P_i + G - R - \Delta W \quad (5.2)$$

Because the soil water distribution over the profile is usually not uniform, ΔW in Equation 5.2 can be written as

$$\Delta W = \sum_{i=1}^n \Delta\theta_i D_i \quad (5.3)$$

where

- n = number of soil layers (-)
- $\Delta\theta_i$ = change in volumetric soil water content of layer i (-)
- D_i = depth of the i -th soil layer (mm)

It is obvious that all errors in estimating the terms of Equation 5.2 will be reflected in the estimate of ET .

The problem with Equation 5.2 is that it is difficult to evaluate the quantity $G - R$ properly. If there is no groundwater within reach of the bottom of the profile, this flow practically equals percolation, R . If a watertable influences the moisture conditions in the rootzone, however, capillary rise must also be considered.

For a proper evaluation of $G - R$ (and the other terms of the water balance), one needs a lysimeter (Aboukhaled et al. 1982). A lysimeter is an isolated undisturbed column of soil, with or without a crop, in which one or more terms of the water balance can be assessed (Figure 5.1). There are two kinds of lysimeters: weighable and non-weighable. With a weighable lysimeter, ΔW can simply be determined by weighing. A reliable measurement of ET can only be obtained if the soil moisture conditions in the lysimeter are the same as those in the field. These conditions can be satisfied if the lysimeter is provided with a drainage system and a system to maintain the water potential of the soil at the bottom of the lysimeter at the same level as the water potential in the adjacent field.

In addition to the soil water balance method, there are various micro-meteorological methods to measure ET over periods of short duration. They are based on relationships concerning the energy balance, mass transfer, eddy correlation, or a combination of these. For an overview, see e.g. Jensen et al. (1990).

5.3.2 Estimating Interception

The amount of water that can adhere to the surface of the leaves of a crop depends on factors like intensity, amount and distribution of precipitation, evaporation flux, and the shape, stand, size, and nature of the leaves.

The amount of water intercepted by a crop can be measured by covering the ground below and around a number of individual plants with plastic sheets. The amounts

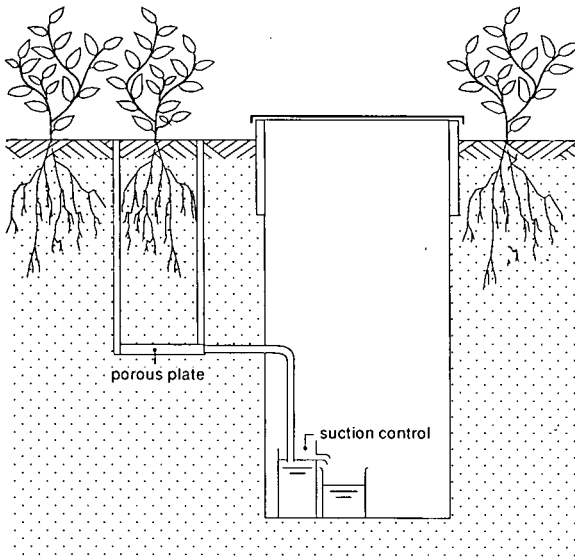

Figure 5.1 Example of a non-weighable lysimeter with suction control at the bottom

of water reaching these sheets (i.e. the throughfall) can be compared with measured rainfall to give the interception. Figure 5.2 illustrates measured interception for a small crop like grass (Rijtema 1965) and for a broad-leaved crop like red cabbage (Feddes 1971).

The scatter of the red cabbage data is largely due to variations in the different environmental factors. A smooth line was drawn through the points and, as is apparent from Figure 5.2, for a precipitation of less than 1 mm from one shower, 50 to 100% adhered to the leaves. With higher rainfall (> 5 mm), only 15% was intercepted by the leaves. Taking the scatter in the various data into account, we see that the curves for red cabbage and grass do not show significant differences.

Interception is especially important in periods of reduced evaporation. Interception

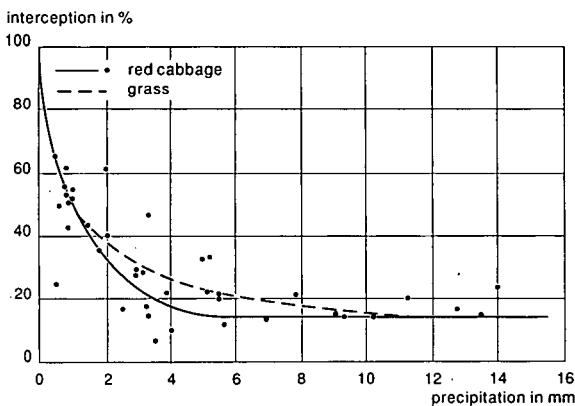

Figure 5.2 Relation between interception and rainfall depth for grass (after Rijtema 1965) and for red cabbage (after Feddes 1971)

increases the total evapotranspiration but, because part of the energy is used for the evaporation of the intercepted water (E_i), it reduces the transpiration of the crop. It should be noted that, when a relatively large error is made in estimating E_i , this leads to only a relatively small error in the final calculation of evapotranspiration.

Von Hoyningen-Hüne (1983) and Braden (1985) measured interception for various crops. On the basis of their data, a general equation can be given for the amount of water intercepted by the crop, P_i , (which is again considered to evaporate as E_i) as a function of precipitation amount, P , and leaf area index, I_l . It reads

$$P_i = a I_l \left(1 - \frac{1}{1 + \frac{bP}{a I_l}} \right) \quad (5.4)$$

where

P_i = interception (mm)

a = a physical parameter, representing the crop-dependent saturation value (mm)

I_l = leaf area index (-)

b = degree of soil cover (-)

P = precipitation (mm)

5.3.3 Estimating the Evaporative Demand

Pan Evaporation

The evaporation from the free water surface of an open pan (Figure 5.3A) is widely used as an indicator of the evaporative demand of the atmosphere. Evaporation is given by the change in the water level inside the pan, after allowance is made for precipitation. Pan evaporation depends on the dimensions and exposure of the pan, the materials from which it has been constructed, and its colour, as well as on all the meteorological conditions.

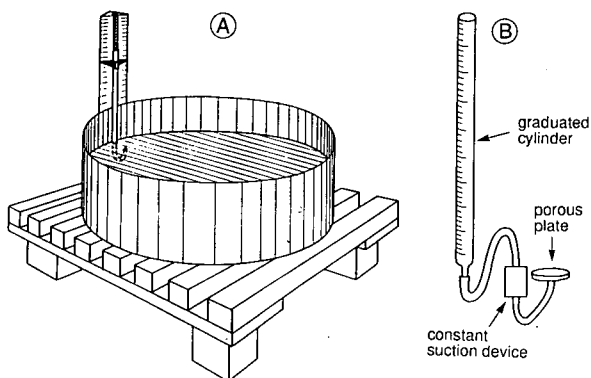

Figure 5.3 Example of an evaporation pan (A) and an atmometer (B)

The Class A pan of the U.S. Weather Bureau (122 cm in diameter and 25.4 cm high) is widely used as the standard pan (Doorenbos 1976). Because of the absorption of radiation through the pan wall and the transfer of sensible heat between the air and the pan wall, the above-ground pan receives an additional amount of energy, which results in higher evaporation rates than those calculated from meteorological data. Sunken pans might then be expected to give more reliable results, but heat exchange between the pan wall and the surrounding soil, and surface roughness effects, limit the accuracy of their results. Empirical correlations (e.g. pan factors) are required to convert measured pan evaporation rates into potential evapotranspiration rates of crops.

Atmometers

Atmometers are instruments with a porous surface connected to a supply of water in such a way that evaporation occurs from the porous surface (Figure 5.3B). A common atmometer is the Piche atmometer, made from a flat, horizontal disc of wetted blotting paper, with both sides exposed to the air. Another is the Bellani black-plate atmometer, which consists of a flat, black porous ceramic plate as the upper face of a non-porous hemisphere. Evaporation from an atmometer is affected by heat conduction through the water from the supply system. Furthermore, the transfer of sensible heat from the air is much greater with atmometers than with vegetation because the atmometer is usually placed at some height above the crop. Nevertheless, in many instances, satisfactory correlations have been found between the evaporation from an atmometer and the potential evapotranspiration from crops.

5.4 Empirical Estimating Methods

5.4.1 Air-Temperature and Radiation Methods

The formula by Turc (1954) reads

$$ET_p = \frac{P + 80}{\sqrt{1 + \left(\frac{P + 45}{L^{Tc}}\right)^2}} \quad (5.5)$$

where

ET_p = 10-day potential evapotranspiration (mm)

P = 10-day precipitation (mm)

L^{Tc} = evaporative demand of the atmosphere, calculated as

$$L^{Tc} = \frac{(T_a + 2)\sqrt{R_s}}{11.1} \quad (5.6)$$

in which

T_a = average air temperature at 2 m (°C)

R_s = incoming short-wave radiation (W/m^2)

The Jensen-Haise (1963) formula, with adjusted units, reads

$$ET_p = (0.025T_a + 0.08) \frac{R_s}{28.6} \quad (5.7)$$

where

ET_p = potential evapotranspiration rate (mm/d)

R_s = incoming short-wave radiation (W/m^2)

T_a = average air temperature at 2 m ($^{\circ}C$)

Equations 5.5 and 5.7 generally underestimate ET_p during spring, and overestimate it during summer, because T_a is given too much weight and R_s too little.

5.4.2 Air-Temperature and Day-Length Method

The formula of Blaney-Criddle (1950) was developed for the western part of the U.S.A. (i.e. for a climate of the Mediterranean type). It reads

$$ET_p = k p (0.457T_{am} + 8.13) (0.031T_{aa} + 0.24) \quad (5.8)$$

where

ET_p = monthly potential evapotranspiration (mm)

k = crop coefficient (-)

p = monthly percentage of annual daylight hours (-)

T_{am} = monthly average air temperature ($^{\circ}C$)

T_{aa} = annual average air temperature ($^{\circ}C$)

The last term, with T_{aa} , was added to adapt the equation to climates other than the Mediterranean type. The method yields good results for Mediterranean-type climates, but in tropical areas with high cloudiness the outcome is too high. The reason for this is that, besides air temperature, solar radiation plays an important role in evaporation. For more details, see Doorenbos and Pruitt (1977).

More commonly used nowadays are the more physically-oriented approaches (i.e. the Penman and Penman-Monteith equations), which give a much better explanation of the evaporation process.

5.5 Evaporation from Open Water: the Penman Method

The Penman method (1948), applied to open water, can be briefly described by the energy balance at the earth's surface, which equates all incoming and outgoing energy fluxes (Figure 5.4). It reads

$$R_n = H + \lambda E + G \quad (5.9)$$

where

R_n = energy flux density of net incoming radiation (W/m^2)

H = flux density of sensible heat into the air (W/m^2)

λE = flux density of latent heat into the air (W/m^2)

G = heat flux density into the water body (W/m^2)

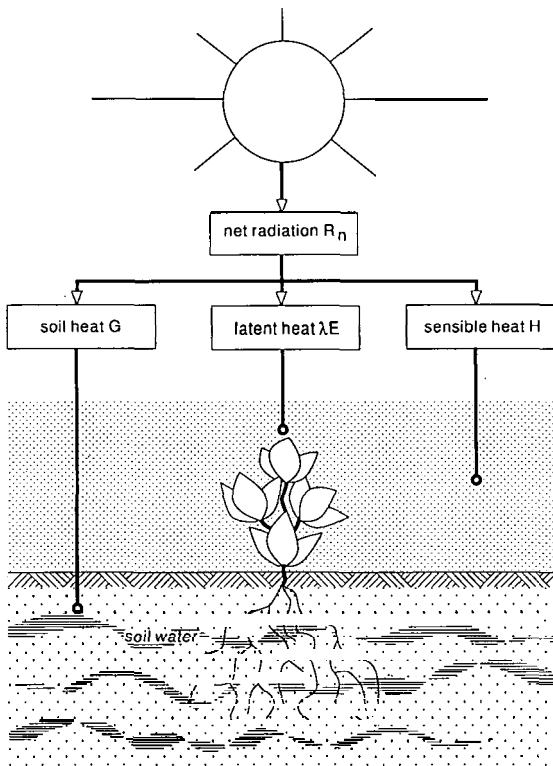

Figure 5.4 Illustration of the variables involved in the energy balance at the soil surface

The coefficient λ in λE is the latent heat of vaporization of water, and E is the vapour flux density in $\text{kg}/\text{m}^2 \text{ s}$. Note that the evapo(transpi)ration in Equation 5.1 is expressed in mm water depth (e.g. over a period of one day). To convert the above λE in W/m^2 into an equivalent evapo(transpi)ration in units of mm/d, λE should be multiplied by a factor 0.0353. This factor equals the number of seconds in a day (86 400), divided by the value of λ ($2.45 \times 10^6 \text{ J}/\text{kg}$ at 20°C), whereby a density of water of $1000 \text{ kg}/\text{m}^3$ is assumed.

Supposing that R_n and G can be measured, one can calculate E if the ratio $H/\lambda E$ (which is called the Bowen ratio) is known. This ratio can be derived from the transport equations of heat and water vapour in air.

The situation depicted in Figure 5.4 and described by Equation 5.9 shows that radiation energy, $R_n - G$, is transformed into sensible heat, H , and water vapour, λE , which are transported to the air in accordance with

$$H = c_1 \frac{(T_s - T_a)}{r_a} \quad (5.10)$$

$$\lambda E = c_2 \frac{(e_s - e_d)}{r_a} \quad (5.11)$$

where

- $c_1, c_2 = \text{constants}$
- $T_s = \text{temperature at the evaporating surface } (^{\circ}\text{C})$
- $T_a = \text{air temperature at a certain height above the surface } (^{\circ}\text{C})$
- $e_s = \text{saturated vapour pressure at the evaporating surface (kPa)}$
- $e_d = \text{prevailing vapour pressure at the same height as } T_a \text{ (kPa)}$
- $r_a = \text{aerodynamic diffusion resistance, assumed to be the same for heat and water vapour (s/m)}$

When the concept of the similarity of transport of heat and water vapour is applied, the Bowen ratio yields

$$\frac{H}{\lambda E} = \frac{c_1 (T_s - T_a)}{c_2 (e_s - e_d)} \quad (5.12)$$

where

$$c_1/c_2 = \gamma = \text{psychrometric constant (kPa}/^{\circ}\text{C)}$$

The problem is that generally the surface temperature, T_s , is unknown. Penman therefore introduced the additional equation

$$e_s - e_a = \Delta (T_s - T_a) \quad (5.13)$$

where the proportionally constant Δ (kPa/ $^{\circ}\text{C}$) is the first derivative of the function $e_s(T)$, known as the saturated vapour pressure curve (Figure 5.5). Note that e_a in Equation 5.13 is the saturated vapour pressure at temperature T_a . Re-arranging gives

$$\Delta = \frac{e_s - e_a}{T_s - T_a} \approx \frac{de_a}{dT_a} \quad (5.14)$$

The slope Δ in Figure 5.5 can be determined at temperature T_a , provided that $(T_s - T_a)$ is small.

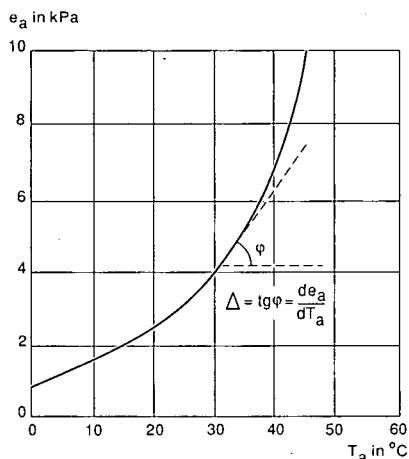

Figure 5.5 Saturated water vapour pressure e_a as a function of air temperature T_a .

From Equation 5.13, it follows that $T_s - T_a = (e_s - e_a)/\Delta$. Substitution into Equation 5.12 yields

$$\frac{H}{\lambda E} = \frac{\gamma e_s - e_d}{\Delta e_s - e_a} \quad (5.15)$$

If $(e_s - e_a)$ is replaced by $(e_s - e_d - e_a + e_d)$, Equation 5.15 can be written as

$$\frac{H}{\lambda E} = \frac{\gamma}{\Delta} \left[1 - \frac{e_a - e_d}{e_s - e_d} \right] \quad (5.16)$$

Under isothermal conditions (i.e. if no heat is added to or removed from the system), we can assume that $T_s \approx T_a$. This implies that $e_s \approx e_a$. If we then introduce this assumption into Equation 5.11, the isothermal evaporation, λE_a , reads as

$$\lambda E_a = c_2 \frac{e_a - e_d}{r_a} \quad (5.17)$$

Dividing Equation 5.17 by Equation 5.11 yields

$$\frac{E_a}{E} = \frac{e_a - e_d}{e_s - e_d} \quad (5.18)$$

The ratio on the right also appeared in Equation 5.16, which can now be written as

$$\frac{H}{\lambda E} = \frac{\gamma}{\Delta} \left(1 - \frac{E_a}{E} \right) \quad (5.19)$$

From Equation 5.9, it follows that $H = R_n - \lambda E - G$. After some rearrangement, and writing E_o (subscript o denoting open water) for E , substitution into Equation 5.19 yields the formula of Penman (1948)

$$E_o = \frac{\Delta(R_n - G)/\lambda + \gamma E_a}{\Delta + \gamma} \quad (5.20)$$

where

- E_o = open water evaporation rate ($\text{kg}/\text{m}^2 \text{ s}$)
- Δ = proportionality constant de_a/dT_a ($\text{kPa}/^\circ\text{C}$)
- R_n = net radiation (W/m^2)
- λ = latent heat of vaporization (J/kg)
- γ = psychrometric constant ($\text{kPa}/^\circ\text{C}$)
- E_a = isothermal evaporation rate ($\text{kg}/\text{m}^2 \text{ s}$)

The term $\frac{\Delta}{\Delta + \gamma} (R_n - G)/\lambda$ is the evaporation equivalent of the net flux density of radiant energy to the surface, also called the radiation term. The term $\frac{\Delta}{\Delta + \gamma} E_a$ is the corresponding aerodynamic term. Equation 5.20 clearly shows the combination of the two processes in one formula.

For open water, the heat flux density into the water, G , is often ignored, especially for longer periods. Also note that the resulting E_o in $\text{kg}/\text{m}^2 \text{ s}$ should be multiplied by 86 400 to give the equivalent evaporation rate E_o in mm/d .

As was mentioned in Section 5.2, E_o has been used as a kind of reference evaporation

for some time, but the practical value of estimating E_o with the original Penman formula (Equation 5.20) is generally limited to large water bodies such as lakes, and, possibly, flooded rice fields in the very early stages of cultivation.

The modification to the Penman method introduced by Doorenbos and Pruitt in FAO's Irrigation and Drainage Paper 24 (1977) started from the assumption that evapotranspiration from grass also largely occurs in response to climatic conditions. And short grass being the common surroundings for agrometeorological observations, they suggested that the evapotranspiration from 8 – 15 cm tall grass, not short of water, be used as a reference, instead of open water. The main changes in Penman's formula to compute this reference evapotranspiration, ET_g (g for grass), concerned the short-wave reflection coefficient (approximately 0.05 for water and 0.25 for grass), a more sensitive wind function in the aerodynamic term, and an adjustment factor to take into account local climatic conditions deviating from an assumed standard. The adjustment was mainly necessary for deviating combinations of radiation, relative humidity, and day/night wind ratios; relevant values can be obtained from a table in Doorenbos and Pruitt (1977).

If the heat flux, G , is set equal to zero for daily periods, the FAO Modified Penman equation can be written as

$$ET_g = c \left[\frac{\Delta}{\Delta + \gamma} R'_n + \frac{\gamma}{\Delta + \gamma} 2.7 f(u) (e_a - e_d) \right] \quad (5.21)$$

where

- ET_g = reference evapotranspiration rate (mm/d)
- c = adjustment factor (-)
- R'_n = equivalent net radiation (mm/d)
- $f(u)$ = wind function; $f(u) = 1 + 0.864 u_2$
- u_2 = wind speed (m/s)
- $e_a - e_d$ = vapour pressure deficit (kPa)
- Δ, γ = as defined earlier

Potential evapotranspiration from cropped surfaces was subsequently found from appropriate crop coefficients, for the determination of which Doorenbos and Pruitt (1977) also provided a procedure.

5.6 Evapotranspiration from Cropped Surfaces

5.6.1 Wet Crops with Full Soil Cover

In analogy with Section 5.5, which described evaporation from open water, evapotranspiration from a wet crop, ET_{wet} , can be described by an equation very similar to Equation 5.20. However, one has to take into account the differences between a crop surface and a water surface:

- The albedo (or reflection coefficient for solar radiation) is different for a crop surface (say, 0.23) and a water surface (0.05 – 0.07);

- A crop surface has a roughness (dependent on crop height and wind speed), and hence an aerodynamic resistance, r_a , that can differ considerably from that of a water surface.

Following the same reasoning as led to Equation 5.17, and replacing the coefficient c_2 by its proper expression, we can write E_a for a crop as

$$E_a = \frac{\varepsilon \rho_a (e_a - e_d)}{p_a r_a} \quad (5.22)$$

where

- ε = ratio of molecular masses of water vapour and dry air (-)
- p_a = atmospheric pressure (kPa)
- ρ_a = density of moist air (kg/m³)

For a wet crop surface with an ample water supply, the Penman equation (5.20) can then be modified (Monteith 1965; Rijtema 1965) to read

$$ET_{\text{wet}} = \frac{\frac{\Delta(R_n - G)}{\lambda} + \gamma \frac{\varepsilon \rho_a (e_a - e_d)}{p_a r_a}}{\Delta + \gamma} \quad (5.23)$$

Because the psychrometric constant $\gamma = c_p p_a / \lambda \varepsilon$, Equation 5.23 reduces to

$$ET_{\text{wet}} = \frac{\Delta(R_n - G) + c_p p_a \frac{(e_a - e_d)}{r_a}}{(\Delta + \gamma)\lambda} \quad (5.24)$$

where

- ET_{wet} = wet-surface crop evapotranspiration rate (kg/m² s)
- c_p = specific heat of dry air at constant pressure (J/kg K)

This ET_{wet} can easily be converted into equivalent mm/d by multiplying it by 86 400.

Note that evapotranspiration from a completely wet crop/soil surface is not restricted by crop or soil properties. ET_{wet} thus primarily depends on the governing atmospheric conditions.

5.6.2 Dry Crops with Full Soil Cover : the Penman-Monteith Approach

Following the discussion of De Bruin (1982) on Monteith's concept for a dry vegetated surface, we can treat the vegetation layer simply as if it were one big leaf. The actual transpiration process (liquid water changing into vapour) takes place in cavities below the stomata of this 'big leaf', and the air within these cavities will be saturated (pressure e_s) at leaf temperature, T_s (Figure 5.6). Water vapour escapes through the stomata to the outer 'leaf' surface, where a certain lower vapour pressure reigns. It is assumed that this vapour pressure at leaf temperature T_s equals the saturated vapour pressure e_a at air temperature T_a . During this diffusion, a 'big leaf' stomatal resistance, r_s , is

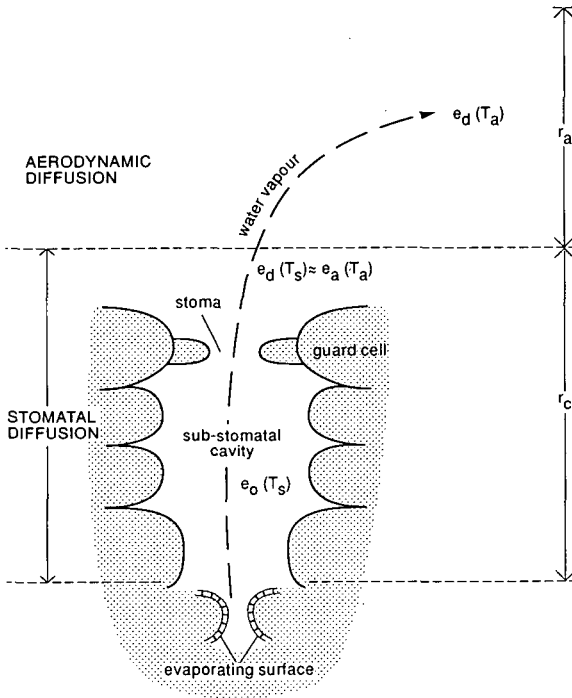

Figure 5.6 The path of water vapour through a leaf stoma, showing relevant vapour pressures, temperatures, and resistances

encountered. As the vapour subsequently moves from the leaf surface to the external air, where actual vapour pressure, e_d , is present, an aerodynamic resistance is encountered. When the vapour diffusion rate through the stomata equals the vapour transport rate into the external air, we can write

$$E_a = \frac{\varepsilon \rho_a e_o - e_a}{p_a r_c} = \frac{\varepsilon \rho_a e_a - e_d}{p_a r_a} = \frac{\varepsilon \rho_a e_o - e_d}{p_a r_c + r_a} \quad (5.25)$$

where, in addition to the earlier defined ε , ρ_a , and p_a

E_a = isothermal evapotranspiration rate from the canopy ($\text{kg/m}^2 \text{s}$)

e_o = internal saturated vapour pressure at T_s (kPa)

e_a = saturated vapour pressure at the 'leaf' surface at T_a (kPa)

e_d = vapour pressure in the external air (kPa)

r_a = aerodynamic resistance (s/m)

r_c = canopy diffusion resistance (s/m)

From Equation 5.25, it follows that a canopy with r_c can be formally described with the same equation as ET_{wet} , if the vapour pressure difference ($e_a - e_d$) in Equation 5.24 is replaced by

$$e_a - e_d = \frac{e_o - e_d}{1 + \frac{r_c}{r_a}} \quad (5.26)$$

According to Monteith (1965), the same effect is obtained if γ is replaced by γ^*

$$\gamma^* = \gamma \left(1 + \frac{r_c}{r_a} \right) \quad (5.27)$$

The equation of Monteith for a dry vegetation then reads

$$ET = \frac{\frac{\Delta (R_n - G)}{\lambda} + \frac{c_p \rho_a}{\lambda} \frac{e_a - e_d}{r_a}}{\Delta + \gamma^*} \quad (5.28)$$

where

$$\begin{aligned} ET &= \text{evapotranspiration rate from a dry crop surface (kg/m}^2 \text{ s)} \\ \gamma^* &= \text{modified psychrometric constant (kPa/}^\circ\text{C)} \end{aligned}$$

This Penman-Monteith equation is valid for a dry crop completely shading the ground.

Note that for a wet crop covered with a thin water layer, r_c becomes zero and the wet-crop formulation (Equation 5.24) is obtained again.

Equation 5.28 is, in principle, not able to describe the evapotranspiration from sparsely-cropped surfaces. With a sparsely-cropped surface, the evaporation from the soil might become dominant.

It appears that the canopy resistance, r_c , of a dry crop completely covering the ground has a non-zero minimum value if the water supply in the rootzone is optimal (i.e. under conditions of potential evapotranspiration). For arable crops, this minimum amounts to $r_c = 30$ s/m; that of a forest is about 150 s/m.

The canopy resistance is a complex function of incoming solar radiation, water vapour deficit, and soil moisture. The relationship between r_c and these environmental quantities varies from species to species and also depends on soil type. It is not possible to measure r_c directly. It is usually determined experimentally with the use of the Penman-Monteith equation, where ET is measured independently (e.g. by the soil water balance or micro-meteorological approach). The problem is that, with this approach, the aerodynamic resistance, r_a , has to be known. Owing to the crude description of the vegetation layer, this quantity is poorly defined. It is important, however, to know where to determine the surface temperature, T_s . Because, in a real vegetation, pronounced temperature gradients occur, it is very difficult to determine T_s precisely. In many studies, r_a is determined very crudely. This implies that some of the r_c values published in literature are biased because of errors made in r_a (De Bruin 1982).

Alternatively, one sometimes relates r_c to single-leaf resistances as measured with a porometer, and with the leaf area index, I_l , according to $r_c = r_{\text{leaf}}/0.5I_l$. If such measurements are not available, a rough indication of r_c can be obtained from taking r_{leaf} to be 100 s/m.

The aerodynamic resistance, r_a , can be represented as

$$r_a = \frac{\ln \left(\frac{z-d}{z_{om}} \right) \ln \left(\frac{z-d}{z_{ov}} \right)}{K^2 u_z} \quad (5.29)$$

where

- z = height at which wind speed is measured (m)
- d = displacement height (m)
- z_{om} = roughness length for momentum (m)
- z_{ov} = roughness length for water vapour (m)
- K = von Kármán constant (-); equals 0.41
- u_z = wind speed measured at height z (m/s)

One recognizes in Equation 5.29, the wind speed, u , increasing logarithmically with height, z . The canopy, however, shifts the horizontal asymptote upwards over a displacement height d , and u_z becomes zero at a height $d + z_o$ (Figure 5.7). Displacement d is dependent on crop height h and is often estimated as

$$d = 0.67 h; \text{ with } z_{om} = 0.123 h; \text{ and } z_{ov} = 0.1 z_{om}$$

In practice, Equation 5.28 is often applied to calculate potential evapotranspiration ET_p , using the mentioned minimum value of r_c and the relevant value of r_a . It can also be used to demonstrate the effect of a sub-optimal water supply to a crop. The reduced turgor in the leaves will lead to a partial closing of the stomata, and thus to an increase in the canopy resistance, r_c . A higher r_c leads to a higher γ^* , and consequently to a lower ET than ET_p .

The superiority of the Penman-Monteith approach (Equation 5.28) over the FAO Modified Penman approach (Equation 5.21) is clearly shown in Figure 5.8. The Penman-Monteith estimates of monthly evapotranspiration of grass or alfalfa agreed better with lysimeter-measured values than FAO Modified Penman estimates.

Equation 5.28 is also used nowadays to calculate a reference evapotranspiration, ET_h . The reference crop is then the aforementioned (Section 5.2) hypothetical crop, with a canopy resistance r_c , and fully covering the ground. This crop is not short of water, so that the minimum r_c of 70 s/m applies. It has a crop height of 12 cm, so that the displacement height d and also the roughness lengths z_{om} and z_{ov} are fixed. For the standard measuring height $z = 2$ m and applying Equation 5.29 we find that

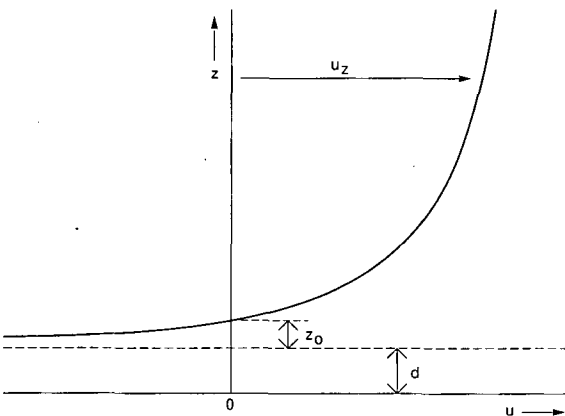

Figure 5.7 The aerodynamic wind profile, illustrating the displacement, d , and the roughness length, z_o

calculated evapotranspiration
in mm/d

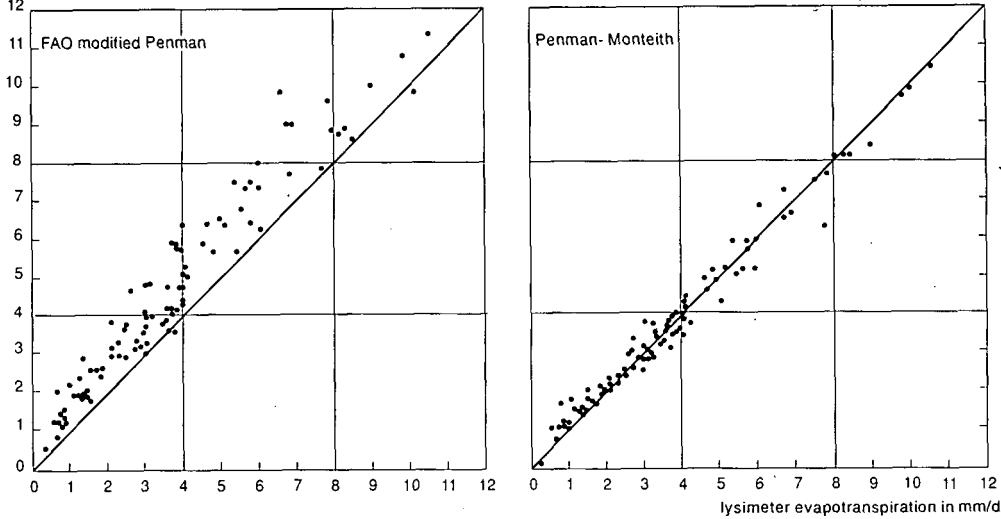

Figure 5.8 Comparison of monthly average lysimeter data for 11 locations with computed evapotranspiration rates for the FAO Modified Penman method and the Penman-Monteith approach (after Jensen et al. 1990)

$r_a = 208/u_2$. In that case, $\gamma^* = (1 + 0.337 u_2)\gamma$. These values and values for other constants can be entered into Equation 5.28, which then produces, with the proper meteorological data, a value for the reference evapotranspiration, denoted by ET_h (see Section 5.7.2).

Potential evapotranspiration from other cropped surfaces could be calculated with minimum values of r_c and the appropriate crop height. As long as minimum r_c values are not available, one may use the above reference evapotranspiration, ET_h , and multiply it by the proper crop coefficient to arrive at the ET_p of that particular crop, as will be discussed further in Section 5.7.1.

5.6.3 Partial Soil Cover and Full Water Supply

If, under the governing meteorological conditions, enough water is available for evapotranspiration from the soil and the crop (and if the meteorological conditions are unaffected by the evapotranspiration process itself), we may consider evapotranspiration to be potential: ET_p . Hence, we can write

$$ET_p = E_p + T_p \quad (5.30)$$

where

E_p = potential soil evaporation
 T_p = potential plant transpiration

As argued before, the Penman-Monteith approach (Equation 5.28) works only under the condition of a complete soil cover.

If we want to estimate the potential evaporation of a soil under a crop cover, we can compute it from a simplified form of Equation 5.24 by neglecting the aerodynamic term and taking into account only that fraction of R_n which reaches the soil surface (Ritchie 1972)

$$E_p = \frac{\Delta}{(\Delta + \gamma)\lambda} R_n e^{-kI_1} \quad (5.31)$$

where

E_p = potential soil evaporation rate ($\text{kg}/\text{m}^2 \text{ s}$)

R_n = net radiation flux density reaching the soil (W/m^2)

I_1 = leaf area index (m^2 leaf area/ m^2 soil area) (-)

k = a proportionality factor, which may vary according to the geometrical properties of a crop (-)

Ritchie (1972) took $k = 0.39$ for crops like sorghum and cotton; Feddes et al. (1978) applied this value to crops like potatoes and grass. More recent views are based on considerations of the extinction coefficient for diffuse visible light, K_D , which varies with crop type from 0.4 to 1.1. A satisfactory relationship for k might be $k = 0.75 K_D$.

By subtracting E_p (Equation 5.31) from ET_p obtained through Equation 5.28, using minimum r_c values, we can then derive T_p from Equation 5.30 as $T_p = ET_p - E_p$. On soils with partial soil cover (e.g. row crops in their early growth stage), the condition of the soil - dry or wet - will considerably influence the partitioning of ET_p over E_p and T_p . Figure 5.9 gives an idea of the computed variation of T_p/ET_p as a function of the leaf area index, I_1 , for a potato crop with optimum water supply to the roots for a dry and a wet soil, respectively, as computed by the simulation program SWATRE of Belmans et al. (1983).

If we assume that ET_p is the same for both dry and wet soil, it appears that for $I_1 < 1$, with increasing drying of the soil and thus decreasing E_p , T_p will increase by a factor of approximately 1.5 to 2 per unit I_1 . For $I_1 > 2-2.5$, E_p is small and virtually independent of the moisture condition of the soil surface. This result agrees with the findings on red cabbage by Feddes (1971) that the soil must be covered for about 70 to 80% ($I_1 = 2$) before E_p becomes constant. Similar results are reported for measurements on sorghum and cotton.

The above results show that the Penman-Monteith approach (Equation 5.28) can be considered reasonably valid for leaf area indices $I_1 > 2$. Below this value, one can regard it as a better-than-nothing approximation.

Note: The partitioning of ET_p into T_p and E_p is important if one is interested in the effects of water use on crop growth and crop production. Crop growth is directly related to transpiration. (For more details, see Feddes 1985.)

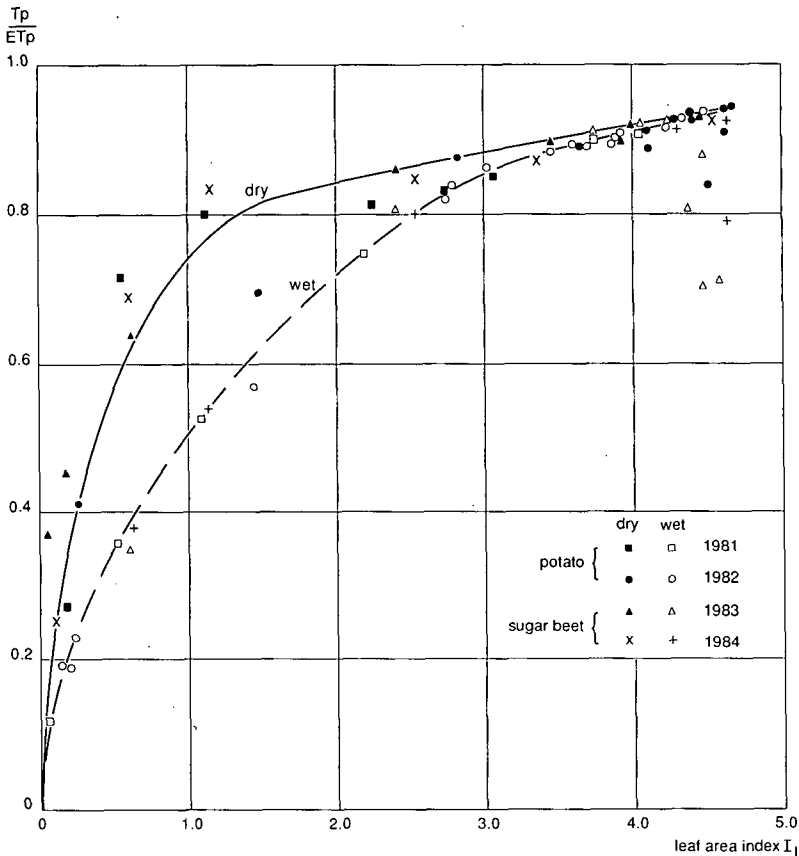

Figure 5.9 Potential transpiration, T_p , as a fraction of potential evapotranspiration, ET_p , in relation to the leaf area index, I_l , for a daily-wetted soil surface and for a dry soil surface

5.6.4 Limited Soil-Water Supply

Under limited soil-water availability, evapotranspiration will be reduced because the canopy resistance increases as a result of the partial closure of the stomata. Such a limitation in available soil water occurs naturally if soil water extracted from the rootzone by evapotranspiration is not replenished in time by rainfall, irrigation, or capillary rise. Another reason for a reduced water availability is a high soil-water salinity, whereby the osmotic potential of the soil solution prevents water from moving to the roots in a sufficient quantity.

Actual evapotranspiration, ET , can be determined from soil water balances by lysimetry, and with micro-meteorological techniques, as were discussed in Section 5.3.

For large areas, remote sensing can provide an indirect measure of ET . Using reflection images to detect the type of crop, and thermal infra-red images from satellite or airplane observations for crop surface temperatures, one can transform these data into daily evapotranspiration rates using surface-energy-balance models (e.g. Thunnissen and Nieuwenhuis 1989; Visser et al. 1989). The underlying principle is

that, for the same crop and growth stage, a below-potential evapotranspiration means a partial closure of the stomata (and increased r_c), a lower transpiration rate inside the sub-stomatal cavities, and hence a higher leaf/canopy temperature (Section 5.6.2).

Another way to estimate ET is by using a soil-water-balance model such as SWATRE (Feddes et al. 1978; Belmans et al. 1983), which describes the transient water flow in the heterogeneous soil-root system that may or may not be influenced by groundwater.

An example of the output of such a model is presented in Figure 5.10. It shows the water-balance terms of the rootzone and the subsoil of a sandy soil that was covered with grass during the very dry year 1976 in The Netherlands. A relatively shallow watertable was present. Over 1976, the potential evapotranspiration, ET_p , was 502 mm, actual ET was 361 mm, which implies a strong reduction of potential evapotranspiration. Net infiltration, I , amounted to 197 mm. Water extraction from the rootzone in this rather light soil was 56 mm, which is only 16% of ET. The decrease in water storage in the subsoil amounted to 206 mm, of which 107 mm (30% of ET) had been delivered by capillary rise towards the rootzone, and 99 mm had been lost to the saturated zone by deep percolation.

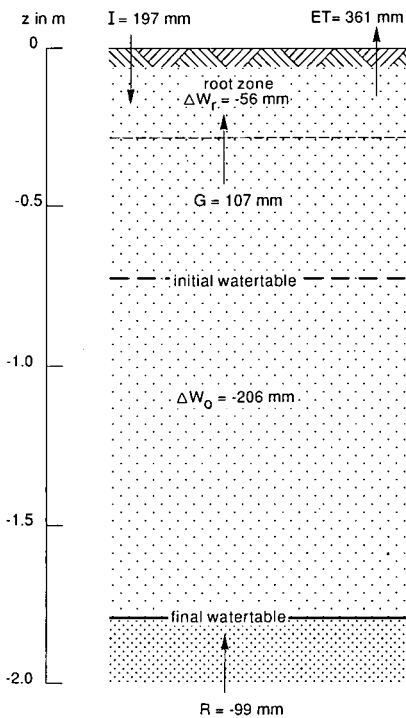

Figure 5.10 Schematic presentation of the water balance terms (mm) of the rootzone (0-0.3 m) and the subsoil (0.3-2.0 m) of a sandy soil over the growing season (1 April – 1 October) of the very dry year 1976 in The Netherlands. The watertable dropped from 0.7 m to 1.8 m during the growing season (after De Graaf and Feddes 1984)

The input data for SWATRE consist of:

- Data on the hydraulic conductivity and moisture retention curves of the major soil horizons;
- Rooting depths and watertables (if present);
- Calculated potential evapotranspiration;
- Precipitation and/or irrigation.

If such a water-balance model is coupled with a crop-growth and crop production model, the actual development of the crop over time can be generated. Hence, actual evapotranspiration can be determined, depending on the every-day history of the crop. Such a model can be helpful in irrigation scheduling, but it can also be used to analyze drainage situations.

5.7 Estimating Potential Evapotranspiration

5.7.1 Reference Evapotranspiration and Crop Coefficients

To estimate crop water requirements, one can relate ET_p from the crop under consideration to an estimated reference evapotranspiration, ET_{ref} , by means of a crop coefficient

$$ET_p = k_c ET_{ref} \quad (5.32)$$

where

ET_p = potential evapotranspiration rate (mm/d)

k_c = crop coefficient (-)

ET_{ref} = reference evapotranspiration rate (mm/d)

The reference evapotranspiration could, in principle, be any evaporation parameter, such as pan evaporation, the Blaney-Criddle ET (Equation 5.8 without the crop coefficient, k), the Penman open water evaporation, E_o (Equation 5.20), the FAO Modified Penman ET_g (Equation 5.21), or the Penman-Monteith ET_h (Equation 5.28).

For the calculation of ET_g and the corresponding crop coefficients, extensive procedures have been given by Doorenbos and Pruitt (1977). Smith (1990) concluded that the sound and practical methods of determining crop water requirements as introduced by Doorenbos and Pruitt (1977) are to a large extent still valid. And so, too, are their lists of crop factors for various crops at different growth stages, if used in combination with ET_g .

In the Penman-Monteith approach, we do not have sufficient data on minimum canopy resistance to apply Equation 5.28 generally, by inserting crop-specific minimum r_c values. Therefore, for the time being, a two-step approach may be followed, in which we represent the effects of climate on potential evapotranspiration by first calculating ET_h , and adding a crop coefficient to account for crop-specific influences on ET_p .

In the two-step approach, the crop coefficient, k_c , depends not only on the characteristic of the crop, its development stage, and the prevailing meteorological

conditions, but also on the selected ET_{ref} method. Choosing the Penman-Monteith approach means that crop coefficients related to this method should be used.

Although it is recognized that alfalfa better resembles an average field crop, the new hypothetical reference crop closely resembles a short, dense grass cover, because most standard meteorological observations are made in grassed meteorological enclosures. In this way, the measured evapotranspiration of (reference) crops used in the various lysimeter and other evaporation studies (grass, alfalfa, Kikuyu grass) can be more meaningfully converted to the imaginary reference crop in the Penman-Monteith approach.

Standardization of certain parameters in the Penman-Monteith equation has led to the following definition (Smith 1990):

'The reference evapotranspiration, ET_h , is defined as the rate of evapotranspiration from an hypothetical crop with an assumed crop height (12 cm), and a fixed canopy resistance (70 s/m), and albedo (0.23), which would closely resemble evapotranspiration from an extensive surface of green grass cover of uniform height, actively growing, completely shading the ground, and not short of water.'

Procedures to calibrate measured potential evapotranspiration to the newly-adopted standard ET_h values in accordance with the above definition are then required.

To convert the Doorenbos and Pruitt (DP) crop factors, k_c^{DP} , to new crop factors, k_c^{PM} , and supposing that ET_p is the same in both cases, we can write

$$ET_p = k_c^{DP} ET_g = k_c^{PM} ET_h \quad (5.33)$$

from which

$$k_c^{PM} = \frac{ET_g}{ET_h} k_c^{DP} \quad (5.34)$$

The conversion factor ET_g/ET_h can easily be derived from long-term meteorological records (e.g. per 10-day period).

Note that crop factors are generally derived from fields with different local conditions and agricultural practices. These local effects may thus include size of fields, advection, irrigation and cultivation practices, climatological variations in time, distance, and altitude, and soil water availability. One should therefore always be careful in applying crop coefficients from experimental data.

As mentioned above, ET_{ref} is sometimes estimated with the pan evaporation method. Extensive use and testing of the evaporation from standardized evaporation pans such as the Class A pan have shown the great sensitivity of the daily evaporation of the water in the pan. It can be influenced by a range of environmental conditions such as wind, soil-heat flux, vegetative cover around the pan, painting and maintenance conditions, or the use of screens. Using the pan evaporation method to estimate reference evapotranspiration can only be recommended if the instrumentation and the site are properly calibrated and managed.

5.7.2 Computing the Reference Evapotranspiration

Accepting the definition of the reference crop as given in Section 5.7.1, we can find the reference evapotranspiration from the following combination formula, which is based on the Penman-Monteith approach (Verhoef and Feddes 1991)

$$ET_h = \frac{\Delta}{\Delta + \gamma^*} R'_n + \frac{\gamma}{\Delta + \gamma^*} E_a \quad (5.35)$$

where

- ET_h = reference crop evapotranspiration rate (mm/d)
- Δ = slope of vapour pressure curve at T_a (kPa/°C)
- γ = psychrometric constant (kPa/°C)
- γ^* = modified psychrometric constant (kPa/°C)
- R'_n = radiative evaporation equivalent (mm/d)
- E_a = aerodynamic evaporation equivalent (mm/d)

This formula is generally applicable, but, to apply it in a certain situation, we have to know what meteorological data are available. As was indicated in Table 5.1, the Penman-Monteith approach requires data on air temperature, solar radiation, relative humidity, wind speed, aerodynamic resistance, and basic canopy resistance. For the computation method that will be presented in this section, we assume that we have the following information:

- General information:
 - The latitude of the station in degrees (positive for northern latitudes and negative for southern latitudes);
 - The altitude of the station above sea level;
 - The measuring height of wind speed and other data is 2 m above ground level;
 - The month of the year for which we want to compute the reference evapotranspiration;
- Crop-specific information:
 - The canopy resistance equals 70 s/m;
 - The crop height is 12 cm;
 - The reflection coefficient equals 0.23;
- Meteorological data:
 - Minimum and maximum temperatures (°C);
 - Solar radiation (W/m²);
 - Relative duration of bright sunshine (-);
 - Average relative humidity (%);
 - Wind speed (m/s).

To this situation, we apply the following computation procedure.

The weighting terms $\Delta/(\Delta + \gamma^*)$ and $\gamma/(\Delta + \gamma^*)$ in front of the radiation and aerodynamic evapotranspiration terms of Equation 5.35 contain γ , γ^* , and Δ . These variables are found as follows.

The psychrometric constant, γ

$$\gamma = 1615 \frac{p_a}{\lambda} \quad (5.36)$$

where

$$\begin{aligned} p_a &= \text{atmospheric pressure (kPa)} \\ \lambda &= \text{latent heat of vaporization (J/kg); value } 2.45 \times 10^6 \\ 1615 &= c_p/\epsilon, \text{ or } 1004.6 \text{ J/kg K divided by } 0.622 \end{aligned}$$

The atmospheric pressure is related to altitude

$$p_a = 101.3 \left(\frac{T_a + 273.16 - 0.0065H}{T_a + 273.16} \right)^{5.256} \quad (5.37)$$

where

$$H = \text{altitude above sea level (m)}$$

The modified psychrometric constant, γ^* , can be found from Equation 5.27. We can insert the standard value of 70 s/m for the reference crop and use Equation 5.29 to find r_a . With the appropriate values, we find $r_a = 208/u_2$, so that

$$\gamma^* = (1 + 0.337 u_2)\gamma \quad (5.38)$$

The slope of the vapour pressure curve, Δ

$$\Delta = \frac{4098 e_a}{(T_a + 237.3)^2} \quad (5.39)$$

where

$$\begin{aligned} T_a &= \text{average air temperature (}^\circ\text{C); } T_a = (T_{\max} + T_{\min})/2 \\ e_a &= \text{saturated vapour pressure (kPa), which follows from} \end{aligned}$$

$$e_a = 0.6108 \exp\left(\frac{17.27 T_a}{T_a + 237.3}\right) \quad (5.40)$$

The radiative evaporation equivalent follows from

$$R'_n = 86400 \frac{R_n - G}{\lambda} \quad (5.41)$$

where

$$\begin{aligned} R_n &= \text{net radiation at the crop surface (W/m}^2\text{)} \\ G &= \text{heat flux density to the soil (W/m}^2\text{); zero for periods of 10-30 days} \\ \lambda &= \text{latent heat of vaporization (J/kg); value } 2.45 \times 10^6 \end{aligned}$$

Note that the number of seconds in a day (86 400) appears, and that the density of water (1000 kg/m³) has been omitted on the right, because it is numerically cancelled out by the conversion from m to mm.

Net radiation is composed of two parts: net short-wave and net long-wave radiation: $R_n = R_{ns} - R_{nl}$. Net short-wave radiation can be described by

$$R_{ns} = (1 - \alpha)R_s \quad (5.42)$$

where

R_{ns} = net short-wave radiation (W/m^2)

α = albedo, or canopy reflection coefficient (-); value 0.23 for the standard reference crop

R_s = solar radiation (W/m^2)

The net long-wave radiation is represented by

$$R_{nl} = (0.9 \frac{n}{N} + 0.1) (0.34 - 0.139\sqrt{e_d}) \sigma \frac{(TK_{max}^4 + TK_{min}^4)}{2} \quad (5.43)$$

where

R_{nl} = net long-wave radiation (W/m^2)

n = daily duration of bright sunshine (h)

N = day length (h)

e_d = actual vapour pressure (kPa)

TK_{max} = maximum absolute temperature (K)

TK_{min} = minimum absolute temperature (K)

σ = Stefan-Boltzmann constant ($W/m^2 K^4$); equals 5.6745×10^{-8}

The actual vapour pressure, e_d , is found from

$$e_d = \frac{RH}{100} e_a \quad (5.44)$$

where

RH = relative humidity percentage (-)

The aerodynamic evaporation equivalent is computed from

$$E_a = \frac{900}{(T_a + 275)} u_2 (e_a - e_d) \quad (5.45)$$

where

u_2 = wind speed measured at 2 m height (m/s)

e_a = saturated vapour pressure (kPa)

e_d = actual vapour pressure (kPa)

We arrive at Equation 5.45 by applying Equation 5.25, with $(e_a - e_d)$. The ratio of the molecular masses of water vapour and dry air equals 0.622. In addition, the density of moist air can be expressed as

$$\rho_a = \frac{p_a}{0.287 (T_a + 275)} \quad (5.46)$$

in which 0.287 equals R_a , the specific gas constant for dry air (0.287 kJ/kg K), and where the officially needed virtual temperature has been replaced by its approximate equivalent $(T_a + 275)$. Moreover, we can find r_a from Equation 5.29 by applying the standard measuring height of 2 m and the reference crop height of 0.12 m, which gives, as was indicated in Section 5.6.2, $r_a = 208/u_2$. Hence, calculating $0.622 \times 86400 / 0.287 \times 208$ produces the factor 900.

The vapour pressure deficit in the aerodynamic term is $e_a - e_d$.

This calculation procedure may seem cumbersome at first, but scientific calculators and especially micro-computers can assist in the computations. Micro-computer programs that use the above equations to find the reference evapotranspiration are available. One example is the program REF-ET, which is a reference evapotranspiration calculator that calculates ET_{ref} according to eight selected methods (Allen 1991). These methods include Penman's open water evaporation, the FAO Modified Penman method, and also the Penman-Monteith approach. The program CROPWAT (Version 5.7) not only calculates the Penman-Monteith reference ET, but also allows a selection of crop coefficients to arrive at crop water requirements (Smith 1992). The program further helps in calculating the water requirements for irrigation schemes and in irrigation scheduling. For this program, a suitable database (CLIMWAT) with agro-meteorological data from many stations around the world is available. Verhoef and Feddes (1991) produced a micro-computer program in FORTRAN, which allows the rapid calculation of the reference crop evapotranspiration according to nine different methods, including the Penman-Monteith equation, and for a variety of available data.

The above mentioned computation methods contain a few empirical coefficients, which may be estimated differently by different authors. In the Penman-Monteith crop reference procedure presented here, however, we have used the recommended relationships and coefficients (Smith 1990), as were also used by Shuttleworth (1992). This procedure should reduce any still-existing confusion.

Calculation Examples

Table 5.2 shows the results of applying the above procedure to one year's monthly data from two meteorological stations in existing drainage areas: one in Mansoura, Egypt, and the other in Hyderabad, Pakistan, both from the database used by Verhoef and Feddes (1991). The relevant input data are listed as well as the calculated reference evapotranspiration.

A comparison of the ET_h -values for the two stations clearly shows the importance of wind speed, or, more generally, of the aerodynamic term. Radiation, sunshine duration, and temperatures do not differ greatly at the two stations, yet the ET_h for Hyderabad is up to twice that for Mansoura. This is mainly due to a large difference in wind speed, and, to a lesser extent, in relative humidity, which together determine the aerodynamic term.

It should be realized that the described procedure would be slightly different for other data availability. If solar radiation is not measured, R_s can be estimated from sunshine duration and radiation at the top of the atmosphere (extra-terrestrial radiation). Also, if relative humidity data are not available, the actual vapour pressure can be estimated from approximate relationships. Minimum and maximum temperatures may not be available, but only averages. Such different data conditions can be catered for (see e.g. Verhoef and Feddes 1991). We shall not mention all possible cases. The main computational structure for finding 10-day or monthly average ET_h -values has been adequately described above, and only one different condition (i.e. that of missing data on solar radiation) is discussed below.

Table 5.2 Computed reference evapotranspiration for two meteorological stations, following the described Penman-Monteith procedure

Month	T _{min} (°C)	T _{max} (°C)	R _s (W/m ²)	n/N (-)	RH (%)	u ₂ (m/s)	ET _h (mm/d)
Mansoura, Egypt (Altitude 30 m)							
January	7.0	19.5	133	0.69	68	1.3	1.5
February	7.5	20.5	167	0.71	59	1.4	2.2
March	9.3	23.2	212	0.73	61	1.7	3.1
April	12.0	27.1	250	0.75	51	1.5	4.1
May	15.6	33.2	279	0.78	43	1.5	5.3
June	18.6	33.6	303	0.85	55	1.5	5.6
July	20.5	32.6	295	0.84	66	1.3	5.2
August	20.5	33.5	280	0.86	66	1.3	5.0
September	19.0	32.5	245	0.85	61	1.1	4.2
October	17.1	28.7	200	0.83	63	1.0	3.0
November	14.0	25.8	153	0.77	63	1.1	2.1
December	9.2	21.2	122	0.66	64	1.1	1.5
Hyderabad, Pakistan (Altitude 28 m)							
January	10.1	24.2	169	0.79	45	2.2	3.1
February	12.8	28.4	201	0.81	41	2.2	4.1
March	17.7	34.2	243	0.84	37	2.7	6.0
April	22.2	39.4	253	0.74	36	3.4	7.8
May	25.9	42.3	284	0.81	41	5.4	10.3
June	27.9	40.6	262	0.68	53	7.1	9.9
July	27.5	37.5	255	0.66	60	6.6	8.3
August	26.5	36.1	235	0.62	62	6.4	7.5
September	25.1	36.8	240	0.76	59	5.4	7.3
October	21.5	37.1	223	0.86	44	2.7	5.8
November	16.2	32.2	183	0.83	42	1.8	3.8
December	11.8	26.4	167	0.86	47	2.0	3.0

Missing Radiation Data

Many agrometeorological stations that do not have a solarimeter to record the solar radiation do have a Campbell-Stokes sunshine recorder to record the duration of bright sunshine. In that case, R_s can be conveniently estimated from

$$R_s = \left(a + b \frac{n}{N} \right) R_A \quad (5.47)$$

where

- R_s = solar radiation (W/m²)
- a = fraction of extraterrestrial radiation on overcast days (-)
- a + b = fraction of extraterrestrial radiation on clear days (-)
- R_A = extraterrestrial radiation, or Angot value (W/m²)
- n = duration of bright sunshine (h)
- N = day length (h)

Although a distinction is sometimes made between (semi-)arid, humid tropical, and other climates, reasonable estimates of the Angstrom values, a and b , for average climatic conditions are $a = 0.25$ and $b = 0.50$. If locally established values are available, these should be used. The day length, N , and the extraterrestrial radiation, R_A , are astronomic values which can be approximated with the following equations. As extra input, they require the time of year and the station's latitude

$$R_A = 435 d_r (\omega_s \sin\phi \sin\delta + \cos\phi \cos\delta \sin \omega_s) \quad (5.48)$$

where

- d_r = relative distance between the earth and the sun (-)
- ω_s = sunset hour angle (rad)
- δ = declination of the sun (rad)
- ϕ = latitude (rad); northern latitude positive; southern negative

The relative distance, d_r , is found from

$$d_r = 1 + 0.033 \cos \frac{2\pi J}{365} \quad (5.49)$$

where

- J = Julian day, or day of the year ($J = 1$ for January 1); for monthly values, J can be found as the integer value of $30.42 \times M - 15.23$, where M is the number of the month (1-12)

The declination δ is calculated from

$$\delta = 0.4093 \sin \left(2\pi \frac{J + 284}{365} \right) \quad (5.50)$$

The sunset-hour angle is found from

$$\omega_s = \arccos(-\tan\phi \tan\delta) \quad (5.51)$$

The maximum possible sunshine hours, or the day length, N , can be found from

$$N = \frac{24}{\pi} \omega_s \quad (5.52)$$

For the Mansoura station (Table 5.2), which lies at 31.03° northern latitude, supposing that R_s is not available and that $n = 7.1$ hours, this amended procedure produces a January $ET_h = 1.7$ mm/d, not much different from the 1.5 mm/d mentioned in Table 5.2.

References

- Aboukhaled, A., A. Alfaro, and M. Smith 1982. Lysimeters. Irrigation and Drainage Paper 39. FAO, Rome. 68 p.
- Allen, R.G. 1991. REF-ET Reference evapotranspiration calculator, version 2.1. Utah State University, Logan. 39 p.
- Belmans, C., J.G. Wesseling and R.A. Feddes 1983. Simulation model of the water balance of a cropped soil. J. Hydrol. 63(3/4), pp. 271-286.

- Blaney, H.F. and W.D. Criddle 1950. Determining water requirements in irrigated areas from climatological and irrigation data. USDA Soil Cons. Serv. SCS-TP 96. Washington, D.C. 44 p.
- Braden, H. 1985. Energiehaushalts- und Verdunstungsmodell für Wasser- und Stoffhaushaltsuntersuchungen landwirtschaftlich genutzter Einzugsgebiete. Mitteilungen der Deutschen Bodenkundlichen Gesellschaft 42, pp. 254-299.
- De Bruin, H.A.R. 1982. The energy balance of the earth's surface : a practical approach. Thesis, Agricultural University, Wageningen, 177 p.
- De Graaf, M. and R.A. Feddes 1984. Model SWATRE. Simulatie van de waterbalans van grasland in het Hupselse beekgebied over de periode 1976 t/m 1982. Nota Inst. voor Cultuurtechniek en Waterhuishouding, Wageningen. 34 p.
- Doorenbos, J. 1976. Agrometeorological field stations. Irrigation and Drainage Paper 27. FAO, Rome, 94 p.
- Doorenbos, J. and W.O. Pruitt 1977. Guidelines for predicting crop water requirements. Irrigation and Drainage Paper 24, 2nd ed., FAO, Rome, 156 p.
- Feddes, R.A. 1971. Water, heat, and crop growth. Thesis, Agricultural University, Wageningen. 184 p.
- Feddes, R.A. 1985. Crop water use and dry matter production: state of the art. In: A. Perrier and C. Kiou (Eds), Proceedings Conference Internationale de la CIID sur les Besoins en Eau des Cultures, Paris, 11-14 September 1984: pp. 221-235.
- Feddes, R.A., P.J. Kowalik and H. Zaradny 1978. Simulation of field water use and crop yield. Simulation Monographs. PUDOC, Wageningen, 189 p.
- Jensen, M.E. and H.R. Haise 1963. Estimating evapotranspiration from solar radiation. J. Irrig. and Drain. Div., ASCE 96, pp. 25-28.
- Jensen, M.E., R.D. Burman and R.G. Allen 1990. Evapotranspiration and irrigation water requirements. ASCE manuals and reports on engineering practice 70. ASCE, New York, 332 p.
- Monteith, J.L. 1965. Evaporation and the Environment. In: G.E. Fogg (ed.), The state and movement of water in living organisms. Cambridge University Press. pp. 205-234.
- Penman, H.L. 1948. Natural evaporation from open water, bare soil, and grass. Proceedings, Royal Society, London 193, pp. 120-146.
- Rijtema, P.E. 1965. An analysis of actual evapotranspiration. Thesis Agricultural University, Wageningen. 111 p.
- Ritchie, J.T. 1972. Model for predicting evaporation from a row crop with incomplete cover. Water Resources Research 8, pp. 1204-1213.
- Shuttleworth, W.J. 1992. Evaporation. In: D.R. Maidment (ed.), Handbook of hydrology. McGraw Hill, New York, pp. 4.1-4.53.
- Smith, M. 1990. Draft report on the expert consultation on revision of FAO methodologies for crop water requirements. FAO, Rome, 45 p.
- Smith, M. 1992. CROPWAT : A computer program for irrigation planning and management. Irrigation and Drainage Paper 46, FAO, Rome, 126 p.
- Thunnissen, H.A.M. and G.J.A. Nieuwenhuis 1989. An application of remote sensing and soil water balance simulation models to determine the effect of groundwater extraction on crop evapotranspiration. Agricultural Water Management 15, pp. 315-332.
- Turc, L. 1954. Le bilan d'eau des sols. Relations entre les précipitations, l'évaporation et l'écoulement. Ann. Agron. 6, pp. 5-131.
- Verhoef, A. and R.A. Feddes 1991. Preliminary review of revised FAO radiation and temperature methods. Department of Water Resources Report 16. Agricultural University, Wageningen, 116 p.
- Visser, T.N.M., M. Menenti and J.A. Morabito 1989. Digital analysis of satellite data and numerical simulation applied to irrigation water management by means of a database system. Report Winand Staring Centre, Wageningen. 9 p.
- Von Hoyningen-Hüne, J. 1983. Die Interception des Niederschlags in landwirtschaftlichen Beständen. Schriftenreihe des DVWK 57, pp. 1-53.

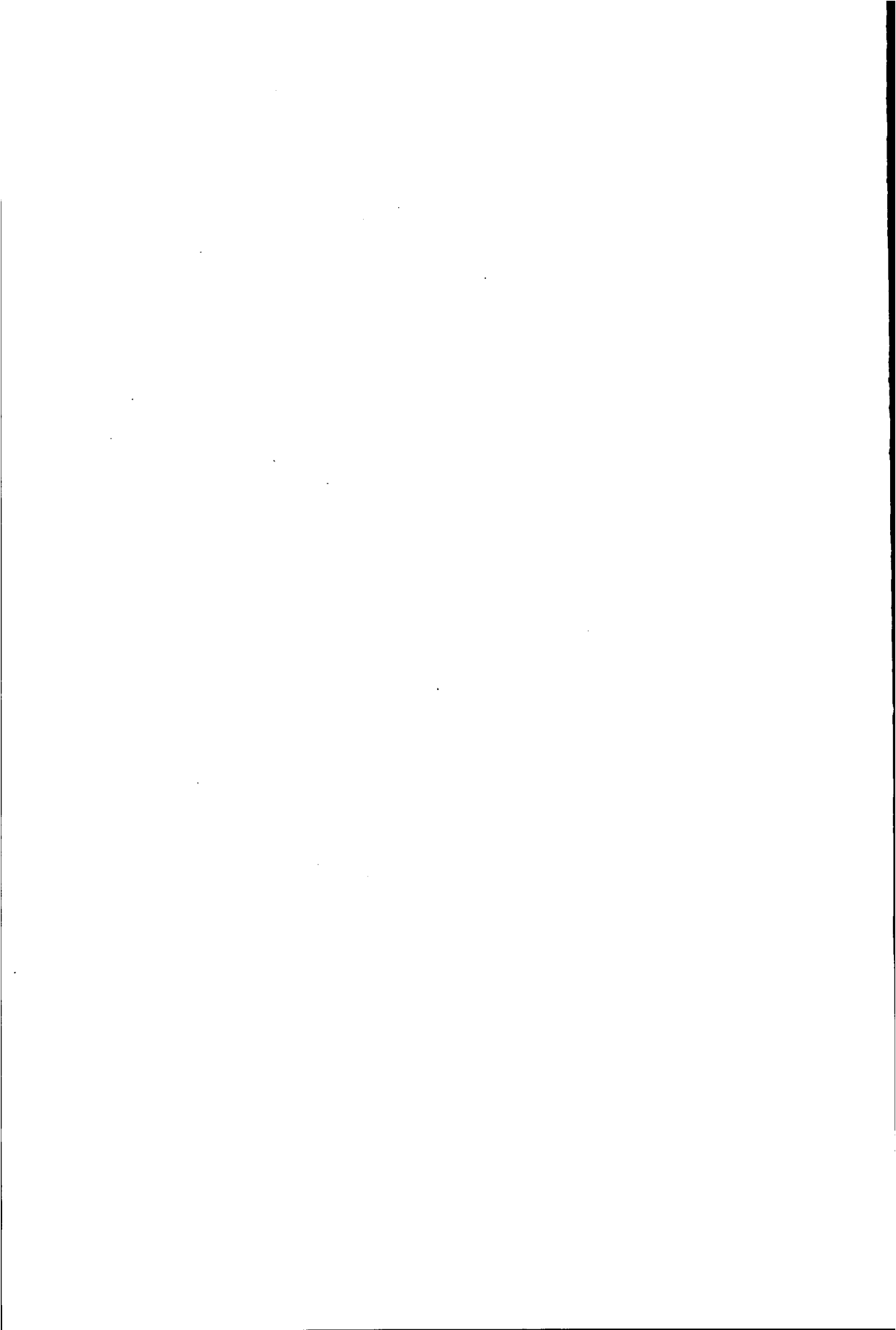

6 Frequency and Regression Analysis

R.J. Oosterbaan¹

6.1 Introduction

Frequency analysis, regression analysis, and screening of time series are the most common statistical methods of analyzing hydrologic data.

Frequency analysis is used to predict how often certain values of a variable phenomenon may occur and to assess the reliability of the prediction. It is a tool for determining design rainfalls and design discharges for drainage works and drainage structures, especially in relation to their required hydraulic capacity.

Regression analysis is used to detect a relation between the values of two or more variables, of which at least one is subject to random variation, and to test whether such a relation, either assumed or calculated, is statistically significant. It is a tool for detecting relations between hydrologic parameters in different places, between the parameters of a hydrologic model, between hydraulic parameters and soil parameters, between crop growth and watertable depth, and so on.

Screening of time series is used to check the consistency of time-dependent data, i.e. data that have been collected over a period of time. This precaution is necessary to avoid making incorrect hydrologic predictions (e.g. about the amount of annual rainfall or the rate of peak runoff).

6.2 Frequency Analysis

6.2.1 Introduction

Designers of drainage works and drainage structures commonly use one of two methods to determine the design discharge. These are:

- Select a design discharge from a time series of measured or calculated discharges that show a large variation;
- Select a design rainfall from a time series of variable rainfalls and calculate the corresponding discharge via a rainfall-runoff transformation.

Frequency analysis is an aid in determining the design discharge and design rainfall. In addition, it can be used to calculate the frequency of other hydrologic (or even non-hydrologic) events.

Because high discharges and rainfalls are comparatively infrequent, the selection of the design discharge can be based on the low frequency with which these high values are permitted to be exceeded. This frequency of exceedance, or the design frequency, is the risk that the designer is willing to accept. Of course, the smaller the risk, the more costly are the drainage works and structures, and the less often their full capacity

¹ International Institute for Land Reclamation and Improvement

will be reached. Accordingly, the design frequency should be realistic – neither too high nor too low.

The following methods of frequency analysis are discussed in this chapter:

- Counting of the number of occurrences in certain intervals (interval method, Section 6.2.2);
- Ranking of the data in ascending or descending order (ranking method, Section 6.2.3);
- Application of theoretical frequency distributions (Section 6.4).

Recurrence predictions and the determination of return periods on the basis of a frequency analysis of hydrologic events are explained in Section 6.2.4.

A frequency – or recurrence – prediction calculated by any of the above methods is subject to statistical error because the prediction is made on the basis of a limited data series. So, there is a chance that the predicted value will be too high or too low. Therefore, it is necessary to calculate confidence intervals for each prediction. A method for constructing confidence intervals is given in Section 6.2.5.

Frequency predictions can be disturbed by two kinds of influences: periodicity and a time trend. Therefore, screening of time series of data for stationarity, i.e. time stability, is important. Although screening should be done before any other frequency analysis, it is explained here at the end of the chapter, in Section 6.6.

6.2.2 Frequency Analysis by Intervals

The interval method is as follows:

- Select a number (k) of intervals (with serial number i , lower limit a_i , upper limit b_i) of a width suitable to the data series and the purpose of the analysis;
- Count the number (m_i) of data (x) in each interval;
- Divide m_i by the total number (n) of data in order to obtain the frequency (F) of data (x) in the i -th interval

$$F_i = F(a_i < x \leq b_i) = m_i/n \quad (6.1)$$

The frequency thus obtained is called the frequency of occurrence in a certain interval. In literature, m_i is often termed the frequency, and F_i is then the relative frequency. But, in this chapter, the term frequency has been kept to refer to F_i .

The above procedure was applied to the daily rainfalls given in Table 6.1. The results are shown in Table 6.2, in Columns (1), (2), (3), (4), and (5). The data are the same data found in the previous edition of this book.

Column (5) gives the frequency distribution of the intervals. The bulk of the rainfall values is either 0 or some value in the 0-25 mm interval. Greater values, which are more relevant for the design capacity of drainage canals, were recorded on only a few days.

From the definition of frequency (Equation 6.1), it follows that the sum of all frequencies equals unity

$$\sum_{i=1}^k F_i = \sum_{i=1}^k m_i/n = n/n = 1 \quad (6.2)$$

Table 6.1 Daily rainfall in mm for the month of November in 19 consecutive years

Year	Day															Total	Max	
	1	2	3	4	5	6	7	8	9	10	11	12	13	14	15			16
1948	-	-	-	3	3	45	15	-	1	5	-	-	4	6	-	-	134	45
1949	-	-	2	10	9	4	10	-	-	-	-	-	-	-	-	-	35	10
1950	11	3	-	2	13	-	8	26	12	1	5	6	-	-	-	-	223	67
1951	29	-	6	99	4	3	-	-	-	-	-	-	5	3	1	-	245	99
1952	111	8	8	21	1	-	11	11	26	1	-	-	-	-	-	-	312	111
1953	-	-	-	-	1	14	4	33	3	-	12	-	11	15	3	-	235	38
1954	-	-	-	-	-	-	-	1	-	1	5	1	7	-	1	-	64	36
1955	-	-	-	10	-	23	3	-	49	12	57	2	-	1	-	-	235	57
1956	-	-	2	9	-	-	-	6	3	-	-	2	-	-	9	-	100	30
1957	4	-	41	46	-	-	-	-	-	-	23	7	1	18	8	-	231	46
1958	92	3	-	2	-	-	-	9	6	5	-	13	-	-	1	-	294	92
1959	-	65	19	-	35	3	27	10	-	13	32	1	16	2	-	-	243	65
1960	-	-	-	-	9	10	-	-	-	-	-	-	-	-	-	-	114	28
1961	41	158	1	-	10	-	6	11	-	-	1	-	7	1	13	-	278	158
1962	-	9	-	10	-	4	-	-	2	5	-	13	16	24	2	-	422	200
1963	74	7	-	2	4	-	10	-	-	-	-	42	11	-	-	-	242	74
1964	7	23	4	-	1	13	29	40	13	14	1	4	-	-	-	-	240	40
1965	11	13	-	2	-	-	-	3	-	8	56	3	44	5	-	-	169	56
1966	11	-	-	-	-	3	-	-	2	54	65	16	-	-	-	-	201	65

Year	Day														Total	Max		
	17	18	19	20	21	22	23	24	25	26	27	28	29	30				
1948	40	12	-	-	-	-	-	-	-	-	-	-	-	-	-	-	134	45
1949	-	-	-	-	-	-	-	-	-	-	-	-	-	-	-	-	35	10
1950	-	-	-	-	-	-	7	4	-	22	5	31	67	-	-	-	223	67
1951	-	1	-	-	-	-	-	-	-	19	5	3	21	46	-	-	245	99
1952	-	-	-	5	7	4	8	2	53	3	6	1	3	21	-	-	312	111
1953	21	-	-	2	11	-	2	18	38	-	5	4	7	6	-	-	235	38
1954	4	-	-	-	4	-	-	1	-	3	-	-	-	-	-	-	64	36
1955	18	3	-	-	-	-	11	4	-	1	1	23	15	2	-	-	235	57
1956	14	9	-	-	-	-	-	-	-	-	-	-	-	-	30	-	100	30
1957	4	-	-	6	38	3	14	2	-	-	-	-	1	13	-	-	231	46
1958	22	3	1	20	-	20	7	14	1	1	22	1	22	12	-	-	294	92
1959	-	-	-	-	-	-	1	-	-	-	-	-	7	12	-	-	243	65
1960	7	3	3	-	-	-	-	-	28	24	22	-	-	-	8	-	114	28
1961	11	-	-	2	4	-	-	-	-	-	-	-	-	-	-	-	278	158
1962	-	-	-	-	200	94	4	-	5	1	12	14	-	-	-	-	422	200
1963	4	1	14	-	4	8	-	-	20	5	-	30	5	-	-	-	242	74
1964	-	3	2	-	-	-	-	-	20	4	37	15	6	4	-	-	240	40
1965	-	-	4	4	2	3	-	-	-	11	-	-	0	-	-	-	169	56
1966	19	14	-	-	9	-	-	-	-	-	-	-	1	7	-	-	201	65

In hydrology, we are often interested in the frequency with which data exceed a certain, usually high design value. We can obtain the frequency of exceedance $F(x > a_i)$ of the lower limit a_i of a depth interval i by counting the number M_i of all rainfall values x exceeding a_i , and by dividing this number by the total number of rainfall data. This is shown in Table 6.2, Column (6). In equation form, this appears as

$$F(x > a_i) = M_i/n \tag{6.3}$$

Table 6.2 Frequency analysis of daily rainfall, based on intervals, derived from Table 6.1 (Column numbers are in brackets)

Serial number	Depth interval (mm)		Number of observations with $a_i < x \leq b_i$	Frequency $F(a_i < x \leq b_i)$	Exceedance frequency $F(x > a_i)$	Cumulative frequency $F(x \leq a_i) = 1 - F(x > a_i)$	Return period	
	Lower limit a_i excl.	Upper limit b_i incl.					T_r (days) n/M_i	T_r (years) $\frac{n/30}{M_i}$
i			m_i	m_i/n (Eq. 6.1)	M_i/n (Eq. 6.3)	= 1-(6) (Eq. 6.5)	= 1/(6) (Eq. 6.9)	= (8)/30 (Eq. 6.10)
(1)	(2)	(3)	(4)	(5)	(6)	(7)	(8)	(9)
1	< 0	0	285	0.500	1.000	0.000	1	0.033
2	0	25	246	0.432	0.500	0.500	2	0.067
3	25	50	25	0.0439	0.0684	0.932	15	0.49
4	50	75	8	0.0140	0.0246	0.975	41	1.4
5	75	100	3	0.00526	0.0105	0.989	95	3.2
6	100	125	1	0.00175	0.00526	0.995	190	6.3
7	125	150	0	0.00000	0.00351	0.996	285	9.5
8	150	175	1	0.00175	0.00351	0.996	285	9.5
9	175	200	1	0.00175	0.00175	0.998	570	19

$$k = 9$$

$$n = \sum m_i = 570$$

Frequency distributions are often presented as the frequency of non-exceedance and not as the frequency of occurrence or of exceedance. The frequency of non-exceedance is also referred to as the cumulative frequency. We can obtain the frequency of non-exceedance $F(x \leq a_i)$ of the lower limit a_i by calculating the sum of the frequencies over the intervals below a_i .

Because the sum of the frequencies over all intervals equals unity, it follows that

$$F(x > a_i) + F(x \leq a_i) = 1 \quad (6.4)$$

The cumulative frequency (shown in Column (7) of Table 6.2) can, therefore, be derived directly from the frequency of exceedance as

$$F(x \leq a_i) = 1 - F(x > a_i) = 1 - M_i/n \quad (6.5)$$

Columns (8) and (9) of Table 6.2 show return periods. The calculation of these periods will be discussed later, in Section 6.2.4.

Censored Frequency Distributions

Instead of using all available data to make a frequency distribution, we can use only certain selected data. For example, if we are interested only in higher rainfall rates, for making drainage design calculations, it is possible to make a frequency distribution only of the rainfalls that exceed a certain value. Conversely, if we are interested in water shortages, it is also possible to make a frequency distribution of only the rainfalls that are below a certain limit. These distributions are called censored frequency distributions.

In Table 6.3, a censored frequency distribution is presented of the daily rainfalls, from Table 6.1, greater than 25 mm. It was calculated without intervals $i = 1$ and $i = 2$ of Table 6.2.

The remaining frequencies presented in Table 6.3 differ from those in Table 6.2 in that they are conditional frequencies (the condition in this case being that the rainfall is higher than 25 mm). To convert conditional frequencies to unconditional frequencies, the following relation is used

$$F = (1 - F^*)F' \quad (6.6)$$

where

F = unconditional frequency (as in Table 6.2)

F' = conditional frequency (as in Table 6.3)

F^* = frequency of occurrence of the excluded events (as in Table 6.2)

As an example, we find in Column (7) of Table 6.3 that $F'(x \leq 50) = 0.641$. Further, the cumulative frequency of the excluded data equals $F^*(x \leq 25) = 0.932$ (see Column (7) of Table 6.2). Hence, the unconditional frequency obtained from Equation 6.6 is

$$F(x \leq 50) = (1 - 0.932) \times 0.641 = 0.0439$$

This is exactly the value found in Column (5) of Table 6.2.

Table 6.3 Censored frequency distribution of daily rainfalls higher than 25 mm, based on intervals, derived from Table 6.1 (column numbers are in brackets)

Serial number	Depth interval (mm)		Number of observations with $a_i < x \leq b_i$	Conditional frequency	Conditional frequency	Conditional frequency	Conditional return period	
	Lower limit a_i excl.	Upper limit b_i incl.		$F'(a_i < x \leq b_i)$	$F'(x > a_i)$	$F'(x \leq a_i) = 1 - F(x > a_i)$	T'_r (days) n/M_i	T'_r years $\frac{n/30}{M_i}$
i			m_i	m_i/n	M_i/n	= 1-(6)	= 1/(6)	= (8)/30
(1)	(2)	(3)	(4)	(5)	(6)	(7)	(8)	(9)
1	25	50	25	0.641	1.000	0.000	1.0	0.033
2	50	75	8	0.205	0.359	0.641	2.8	0.093
3	75	100	3	0.0769	0.154	0.846	6.5	0.22
4	100	125	1	0.0256	0.0769	0.923	13.0	0.43
5	125	150	0	0.0000	0.0513	0.949	19.5	0.65
6	150	175	1	0.0256	0.0513	0.949	19.5	0.65
7	175	200	1	0.0256	0.0256	0.974	39.0	1.3

k = 7

n = $\Sigma m_i = 39$

6.2.3 Frequency Analysis by Ranking of Data

Data for frequency analysis can be ranked in either ascending or descending order. For a ranking in descending order, the suggested procedure is as follows:

- Rank the total number of data (n) in descending order according to their value (x), the highest value first and the lowest value last;
- Assign a serial number (r) to each value x ($x_r, r = 1, 2, 3, \dots, n$), the highest value being x_1 and the lowest being x_n ;
- Divide the rank (r) by the total number of observations plus 1 to obtain the frequency of exceedance

$$F(x > x_r) = \frac{r}{n + 1} \quad (6.7)$$

- Calculate the frequency of non-exceedance

$$F(x \leq x_r) = 1 - F(x > x_r) = 1 - \frac{r}{n + 1} \quad (6.8)$$

If the ranking order is ascending instead of descending, we can obtain similar relations by interchanging $F(x > x_r)$ and $F(x \leq x_r)$.

An advantage of using the denominator $n + 1$ instead of n (which was used in Section 6.2.2) is that the results for ascending or descending ranking orders will be identical.

Table 6.4 shows how the ranking procedure was applied to the monthly rainfalls of Table 6.1. Table 6.5 shows how it was applied to the monthly maximum 1-day rainfalls of Table 6.1. Both tables show the calculation of return periods (Column 7), which will be discussed below in Section 6.2.4. Both will be used again, in Section 6.4, to illustrate the application of theoretical frequency distributions.

The estimates of the frequencies obtained from Equations 6.7 and 6.8 are not unbiased. But then, neither are the other estimators found in literature. For values of x close to the average value (\bar{x}), it makes little difference which estimator is used, and the bias is small. For extreme values, however, the difference, and the bias, can be relatively large. The reliability of the predictions of extreme values is discussed in Section 6.2.5.

6.2.4 Recurrence Predictions and Return Periods

An observed frequency distribution can be regarded as a sample taken from a frequency distribution with an infinitely long observation series (the 'population'). If this sample is representative of the population, we can then expect future observation periods to reveal frequency distributions similar to the observed distribution. The expectation of similarity ('representativeness') is what makes it possible to use the observed frequency distribution to calculate recurrence estimates.

Representativeness implies the absence of a time trend. The detection of possible time trends is discussed in Section 6.6.

It is a basic law of statistics that if conclusions about the population are based on a sample, their reliability will increase as the size of the sample increases. The smaller

Table 6.4 Frequency distributions based on ranking of the monthly rainfalls of Table 6.1

Rank r	Rainfall (descending) x_r x_r^2 *		Year	$F(x > x_r)$ r/(n+1)	$F(x \leq x_r)$ 1-r/(n+1)	T_r (years) (n+1)/r
(1)	(2)	(3)	(4)	(5)	(6)	(7)
1	422	178084	1962	0.05	0.95	20
2	312	97344	1952	0.10	0.90	10
3	294	86436	1958	0.15	0.85	6.7
4	278	77284	1961	0.20	0.80	5.0
5	245	60025	1951	0.25	0.75	4.0
6	243	59049	1959	0.30	0.70	3.3
7	242	58564	1964	0.35	0.65	2.9
8	240	57600	1963	0.40	0.60	2.5
9	235	55225	1953	0.45	0.55	2.2
10	235	55225	1955	0.50	0.50	2.0
11	231	53361	1957	0.55	0.45	1.82
12	223	49729	1950	0.60	0.40	1.67
13	201	40401	1966	0.65	0.35	1.54
14	169	28561	1965	0.70	0.30	1.43
15	134	17956	1948	0.75	0.25	1.33
16	114	12996	1960	0.80	0.20	1.25
17	100	10000	1956	0.85	0.15	1.18
18	64	4096	1954	0.90	0.10	1.11
19	35	1225	1949	0.95	0.05	1.05

$$n = 19 \quad \sum_{r=1}^n x_r = 4017 \quad \sum_{r=1}^n x_r^2 = 1003161$$

* Tabulated for parametric distribution-fitting (see Section 6.4)

the frequency of occurrence of an event, the larger the sample will have to be in order to make a prediction with a specified accuracy. For example, the observed frequency of dry days given in Table 6.2 (0.5, or 50%) will deviate only slightly from the frequency observed during a later period of at least equal length. The frequency of daily rainfalls of 75-100 mm (0.005, or 0.5%), however, can be easily doubled (or halved) in the next period of record.

A quantitative evaluation of the reliability of frequency predictions follows in the next section.

Recurrence estimates are often made in terms of return periods (T), T being the number of new data that have to be collected, on average, to find a certain rainfall value. The return period is calculated as $T = 1/F$, where F can be any of the frequencies discussed in Equations 6.1, 6.3, 6.5, and 6.6. For example, in Table 6.2, the frequency F of 1-day November rainfalls in the interval of 25-50 mm equals 0.04386, or 4.386%. Thus the return period is $T = 1/F = 1/0.04386 = 23$ November days.

In hydrology, it is very common to work with frequencies of exceedance of the variable x over a reference value x_r . The corresponding return period is then

$$T_r = \frac{1}{F(x > x_r)} \tag{6.9}$$

Table 6.5 Frequency distributions based on ranking of the maximum 1-day rainfalls per month of Table 6.1

Rank	Rainfall (descending)		Year	$F(x > x_r)$	$F(x \leq x_r)$	T_r (years)
r	x_r	x_r^2 *		$r/(n+1)$	$1-r/(n+1)$	$(n+1)/r$
(1)	(2)	(3)	(4)	(5)	(6)	(7)
1	200	40000	1962	0.05	0.95	20
2	158	24964	1961	0.10	0.90	10
3	111	12321	1952	0.15	0.85	6.7
4	99	9801	1951	0.20	0.80	5.0
5	92	8464	1958	0.25	0.75	4.0
6	74	5476	1963	0.30	0.70	3.3
7	67	4489	1950	0.35	0.65	2.9
8	65	4225	1966	0.40	0.60	2.5
9	65	4225	1959	0.45	0.55	2.2
10	57	3249	1955	0.50	0.50	2.0
11	56	3136	1965	0.55	0.45	1.82
12	46	2116	1957	0.60	0.40	1.67
13	45	2025	1948	0.65	0.35	1.54
14	40	1600	1964	0.70	0.30	1.43
15	38	1444	1953	0.75	0.25	1.33
16	36	1296	1954	0.80	0.20	1.25
17	30	900	1956	0.85	0.15	1.18
18	28	784	1960	0.90	0.10	1.11
19	10	100	1949	0.95	0.05	1.05

$$n = 19 \quad \sum_{r=1}^n x_r = 1317 \quad \sum_{r=1}^n x_r^2 = 130615$$

* Tabulated for parametric distribution-fitting (see Section 6.4)

For example, in Table 6.2 the frequency of exceedance of 1-day rainfalls of $x_r = 100$ mm in November is $F(x > 100) = 0.00526$, or 0.526%. Thus the return period is

$$T_{100} = \frac{1}{F(x > 100)} = \frac{1}{0.00526} = 190 \text{ (November days)}$$

In design, T is often expressed in years

$$T(\text{Years}) = \frac{T}{\text{number of independent observations per year}} \tag{6.10}$$

As the higher daily rainfalls can generally be considered independent of each other, and as there are 30 November days in one year, it follows from the previous example that

$$T_{100}(\text{years}) = \frac{T_{100}(\text{November days})}{30} = \frac{190}{30} = 6.33 \text{ years}$$

This means that, on average, there will be a November day with rainfall exceeding 100 mm once in 6.33 years.

If a censored frequency distribution is used (as it was in Table 6.3), it will also be

necessary to use the factor $1-F^*$ (as shown in Equation 6.6) to adjust Equation 6.10. This produces

$$T(\text{Years}) = \frac{T' / (1-F^*)}{\text{number of independent observations per year}} \quad (6.11)$$

where T' is the conditional return period ($T' = 1/F'$).

In Figure 6.1, the rainfalls of Tables 6.2, 6.4, and 6.5 have been plotted against their respective return periods. Smooth curves have been drawn to fit the respective points as well as possible. These curves can be considered representative of average future frequencies. The advantages of the smoothing procedure used are that it enables interpolation and that, to a certain extent, it levels off random variation. Its disadvantage is that it may suggest an accuracy of prediction that does not exist. It is therefore useful to add confidence intervals for each of the curves in order to judge the extent of the curve's reliability. (This will be discussed in the following section.)

From Figure 6.1, it can be concluded that, if T_r is greater than 5, it makes no significant difference if the frequency analysis is done on the basis of intervals of all 1-day rainfalls or on the basis of maximum 1-day rainfalls only. This makes it possible to restrict the analysis to maximum rainfalls, which simplifies the calculations and produces virtually the same results.

The frequency analysis discussed here is usually adequate to solve problems related to agriculture. If there are approximately 20 years of information available, predictions for 10-year return periods, made with the methods described in this section, will be reasonably reliable, but predictions for return periods of 20 years or more will be less reliable.

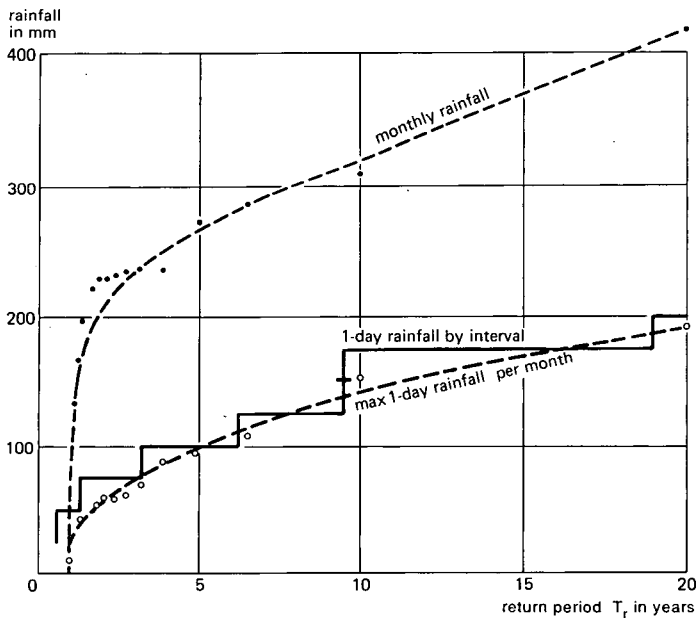

Figure 6.1 Depth-return period relations derived from Tables 6.2, 6.4, and 6.5

6.2.5 Confidence Analysis

Figure 6.2 shows nine cumulative frequency distributions that were obtained with the ranking method. They are based on different samples, each consisting of 50 observations taken randomly from 1000 values. The values obey a fixed distribution (the base line). It is clear that each sample reveals a different distribution, sometimes close to the base line, sometimes away from it. Some of the lines are even curved, although the base line is straight.

Figure 6.2 also shows that, to give an impression of the error in the prediction of future frequencies, frequency estimates based on one sample of limited size should be accompanied by confidence statements. Such an impression can be obtained from Figure 6.3, which is based on the binomial distribution. The figure illustrates the principle of the nomograph. Using $N = 50$ years of observation, we can see that the 90% confidence interval of a predicted 5-year return period is 3.2 to 9 years. These values are obtained by the following procedure:

- Enter the graph on the vertical axis with a return period of $T_r = 5$, (point A), and move horizontally to intersect the baseline, with $N = \infty$, at point B;

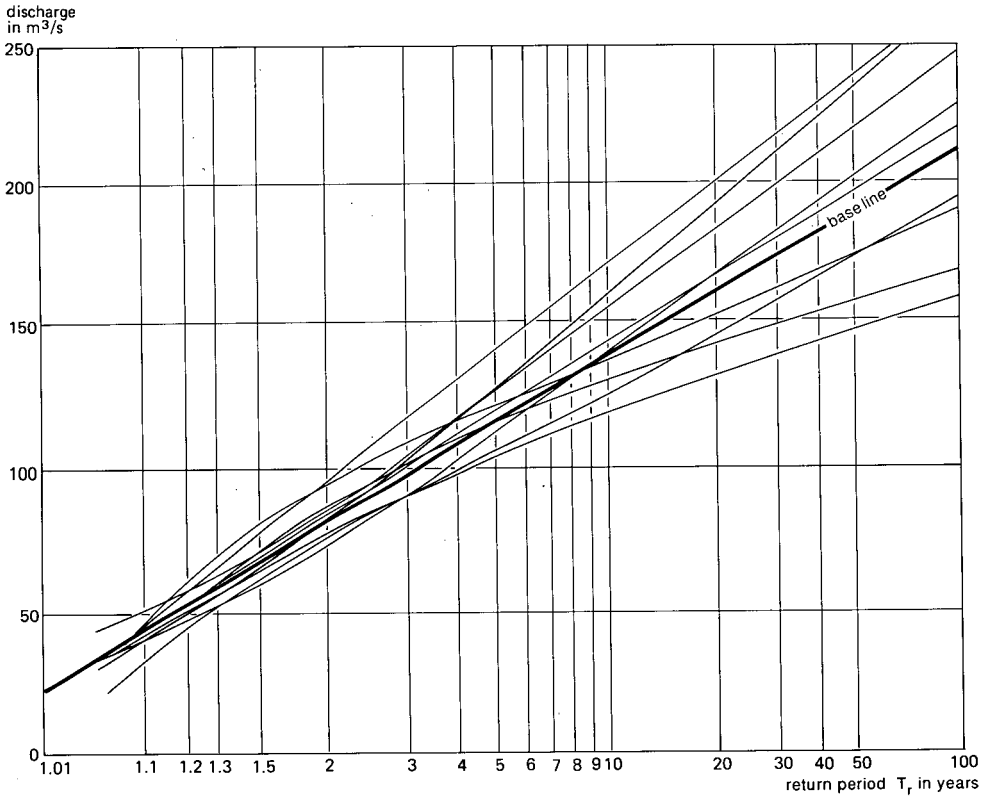

Figure 6.2 Frequency curves for different 50-year sample periods derived from the same base distribution (after Benson 1960)

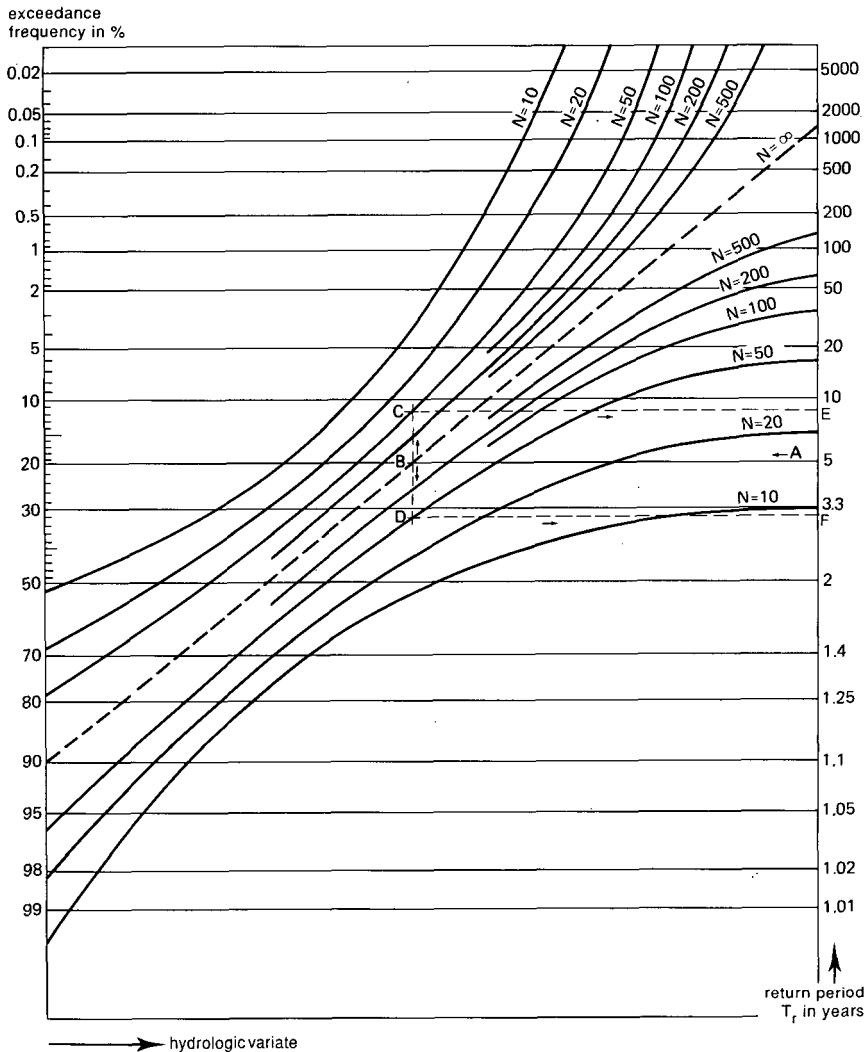

Figure 6.3 90% Confidence belts of frequencies for different values of sample size N

- Move vertically from the intersection point (B) and intersect the curves for $N = 50$ to obtain points C and D;
- Move back horizontally from points C and D to the axis with the return periods and read points E and F;
- The interval from E to F is the 90% confidence interval of A, hence it can be predicted with 90% confidence that T_r is between 3.2 and 9 years. Nomographs for confidence intervals other than 90% can be found in literature (e.g. in Oosterbaan 1988).

By repeating the above procedure for other values of T_r , we obtain a confidence belt.

In theory, confidence belts are somewhat wider than those shown in the graph. The reason for this is that mean values and standard deviations of the applied binomial

distributions have to be estimated from a data series of limited length. Hence, the true means and standard deviations can be either smaller or larger than the estimated ones. In practice, however, the exact determination of confidence belts is not a primary concern because the error made in estimating them is small compared to their width.

The confidence belts in Figure 6.3 show the predicted intervals for the frequencies that can be expected during a very long future period with no systematic changes in hydrologic conditions. For shorter future periods, the confidence intervals are wider than indicated in the graphs. The same is true when hydrologic conditions change.

In literature, there are examples of how to use a probability distribution of the hydrologic event itself to construct confidence belts (Oosterbaan 1988). There are advantages, however, to use a probability distribution of the frequency to do this. This method can also be used to assess confidence intervals of the hydrologic event, which we shall discuss in Section 6.4.

6.3 Frequency-Duration Analysis

6.3.1 Introduction

Hydrologic phenomena are continuous, and their change in time is gradual. Because they are not discrete in time, like the yield data from a crop, for example, they are sometimes recorded continuously. But before continuous records can be analyzed for certain durations, they must be made discrete, i.e. they must be sliced into predetermined time units. An advantage of continuous records is that these slices of time can be made so small that it becomes possible to follow a variable phenomenon closely. Because many data are obtained in this way, discretization is usually done by computer.

Hydrologic phenomena (e.g. rainfall) are recorded more often at regular time intervals (e.g. daily) than continuously. For phenomena like daily rainfall totals, it is difficult to draw conclusions about durations shorter than the observation interval. Longer durations can be analyzed if the data from the shorter intervals are added. This technique is explained in the following section.

The processing of continuous records is not discussed, but the principles are almost the same as those used in the processing of measurements at regular intervals, the main distinction being the greater choice of combinations of durations if continuous records are available.

Although the examples that follow refer to rainfall data, they are equally applicable to other hydrologic phenomena.

6.3.2 Duration Analysis

Rainfall is often measured in mm collected during a certain interval of time (e.g. a day). For durations longer than two or more of these intervals, measured rainfalls can be combined into three types of totals:

- Successive totals;
- Moving totals;
- Maximum totals.

date	1	2	3	4	5	6	7	8	9	10	11	12	13	14	15	16	17	18	19	20	
rainfall in mm	1	15	5	20	56	66	22	15	0	6	10	27	33	5	3	0	0	0	6	9	
successive 5-day totals	← 97			← 109				← 78					← 15								
moving 5-day totals	← 97	← 162	← 169	← 179	← 159	← 109	← 53	← 58	← 76	← 81	← 78	← 41	← 8	← 9	← 15						
maximum 5-day totals			← 179																		

Figure 6.4 Illustration of various methods for the composition of 5-day totals

Examples of these combining methods are given in Figure 6.4 for 5-day totals that are made up of 1-day rainfalls.

To form successive 5-day totals, break up the considered period or season of measurement into consecutive groups of 5 days and calculate the total rainfall for each group. Successive totals have the drawback of sometimes splitting periods of high rainfall into two parts of lesser rainfall, thus leading us to underestimate the frequency of high rainfall.

To form moving 5-day totals, add the rainfall from each day in the considered period to the totals from the following 4 days. Because of the overlap, each daily rainfall will be represented 5 times. So even though, for example, in November there are 26 moving 5-day totals, we have only 6 non-overlapping totals (the same as the number of successive 5-day totals) to calculate the return period. The advantage of the moving totals is that, because they include all possible 5-day rainfalls, we cannot underestimate the high 5-day totals. The drawbacks are that the data are not independent and that a great part of the information may be of little interest.

To avoid these drawbacks, censored data series are often used. In these series, the less important data are omitted (e.g. low rainfalls – at least when the design capacity of drainage canals is being considered), and only exceedance series or maximum series are selected. Thus we can choose, for example, a maximum series consisting of the highest 5-day moving totals found for each month or year and then use the interval or ranking procedure to make a straightforward frequency distribution or return-period analysis for them. We must keep in mind, however, that the second highest rainfall in a certain month or year may exceed the maximum rainfall recorded in some other months or years and that, consequently, the rainfalls estimated from maximum series with return periods of less than approximately 5 years will be underestimated in comparison with those obtained from complete or exceedance series. It is, therefore, a good idea not to work exclusively with maximum series when making calculations for agriculture.

6.3.3 Depth-Duration-Frequency Relations

Having analyzed data both for frequency and for duration, we arrive at depth-duration-frequency relations. These relations are valid only for the point where the observations were made, and not for larger areas. Figure 6.5A shows that rainfall-return period relations for short durations are steeper for point rainfalls than for area

rainfalls, but that, for longer durations, the difference is less. Figure 6.5B illustrates qualitatively the effect of area on the relation between duration-frequency curves. It shows how rainfall increases with area when the return period is short ($T_r < 2$), whereas, for long return periods ($T_r > 2$), the opposite is true. It also shows that larger areas have less variation in rainfall than smaller areas, but that the mean rainfall is the same. Note that, in both figures, the return period of the mean value is $T_r \approx 2$. This means an exceedance frequency of $F(x > x_r) = 1/T_r \approx 0.5$, which corresponds to the median value. So it is assumed that the mean and the median are about equal.

Instead of working with rainfall totals of a certain duration, we can work with the average rainfall intensity, i.e. the total divided by the duration (Figure 6.6).

Procedure and Example

The data in Table 6.1 are from a tropical rice-growing area. November, when the rice seedlings have just been transplanted, is a critical month: an abrupt rise of more than 75 mm (the maximum permissible storage increase) of the standing water in the paddy fields due to heavy rains would be harmful to the seedlings. A system of ditches is to be designed to transport the water drained from the fields.

To find the design discharge of the ditches, we first use a frequency-duration analysis to determine the frequency distributions of, for example, 1-, 2-, 3-, and 5-day rainfall totals. From this analysis, we select and plot these totals with return periods of 5, 10, and 20 years (Figure 6.7).

To find the required design discharge in relation to the return period (accepted risk of inadequate drainage), we draw tangent lines from the 75-mm point on the depth axis to the various duration curves. The slope of the tangent line indicates the design discharge. If we shift the tangent line so that it passes through the zero point of the coordinate axes, we can see that, for a 5-year return period, the drainage capacity should be 25 mm/d. We can see that the maximum rise would then equal the permissible rise (75 mm), and that it would take about 5 days to drain off all the water from this rainstorm. If we take the design return period as 10 years, the discharge capacity

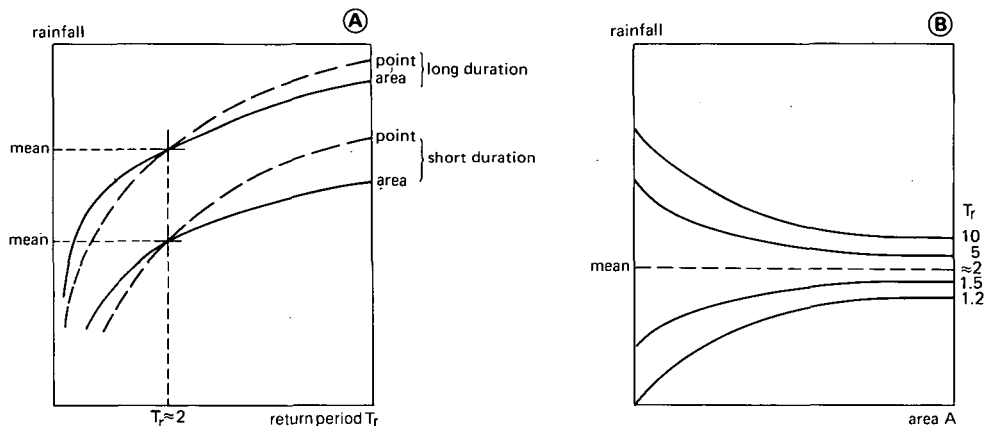

Figure 6.5 The influence of area size on frequency-duration relations of rainfall. A: Flattening effect of the duration on area rainfalls as compared with point rainfalls. B: Flattening effect of the size of the area on area rainfalls of various return periods as compared with point rainfalls

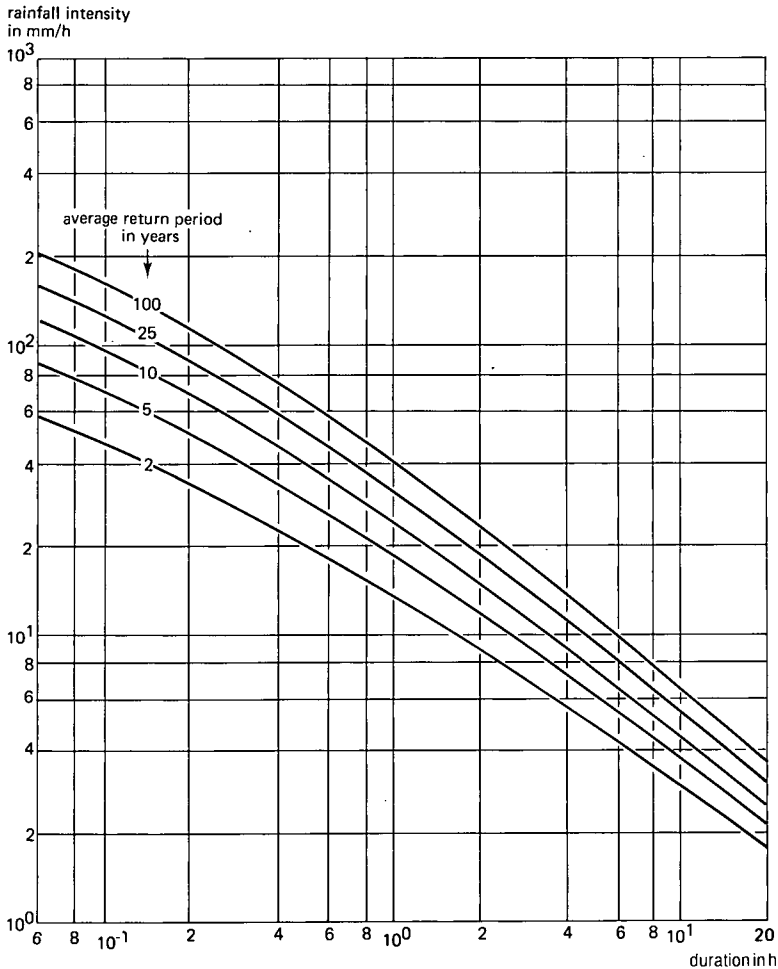

Figure 6.6 Intensity-duration-frequency relations of rainfall (Fresno, California, U.S.A. 1903-1941)

would be 50 mm/d, and for 20 years it would be 150 mm/d. We can also see that the critical durations, indicated by the tangent points, become shorter as the return period increases (to about 1.4, 0.9, and 0.4 days). In other words: as the return period increases, the design rainfall increases, the maximum permissible storage becomes relatively smaller, and we have to reckon with more intensive rains of shorter duration.

Because the return periods used in the above example are subject to considerable statistical error, it will be necessary to perform a confidence analysis.

So far, we have analyzed only durations of a few days in a certain month. Often, however, it is necessary to expand the analysis to include longer durations and all months of the year. Figure 6.8 illustrates an example of this that is useful for water-resources planning.

In addition to deriving depth-duration-frequency relations of rainfall, we can use these same principles to derive discharge-duration-frequency relations of river flows.

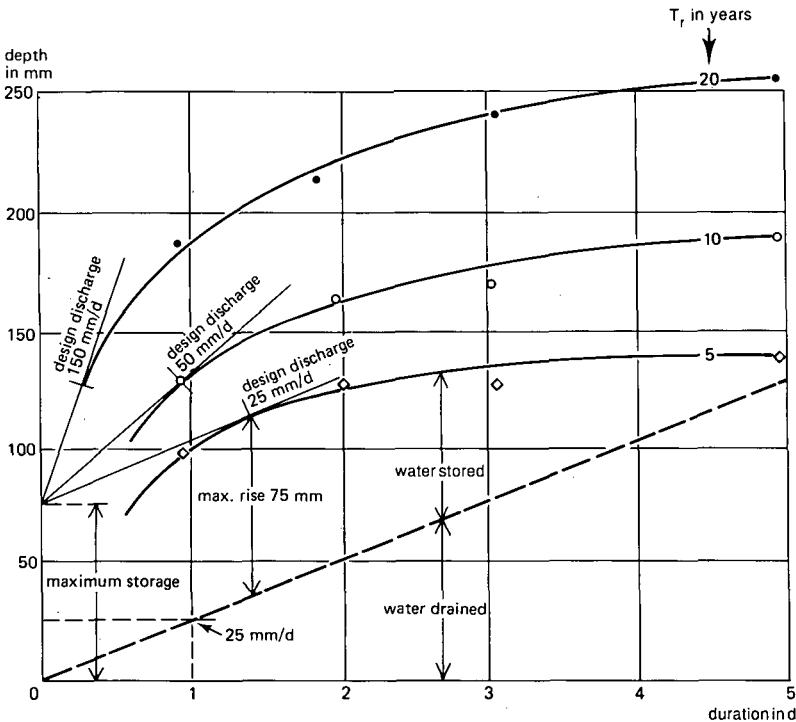

Figure 6.7 Depth-duration-frequency relation derived from Table 6.1 and applied to determine the design discharge of a surface drainage system

6.4 Theoretical Frequency Distributions

6.4.1 Introduction

To arrive at a mathematical formula for a frequency distribution, we can try to fit a theoretical frequency distribution (given by a mathematical expression) to the data series. If the theoretical distribution fits the data reasonably well, it can be used to convert the confidence limits of frequencies or return periods into the confidence limits of the hydrologic phenomenon studied (Section 6.4.6). Further, the fitted distribution can be used not only to interpolate, but also to extrapolate, i.e. to find return periods of extreme values that were not apparent during the relatively short period of observation. We should, however, be very cautious with such extrapolations because:

- Observed frequencies are subject to random variation and so, consequently, the same is true of the fitted theoretical distribution;
- The error will increase as the phenomenon becomes more extreme or exceptional;
- Many different theoretical distributions can be made to fit the observed distribution well, but they can lead to different predictions for extrapolated values.

Of the many existing theoretical frequency distributions, only three have been selected for discussion in this chapter. They are:

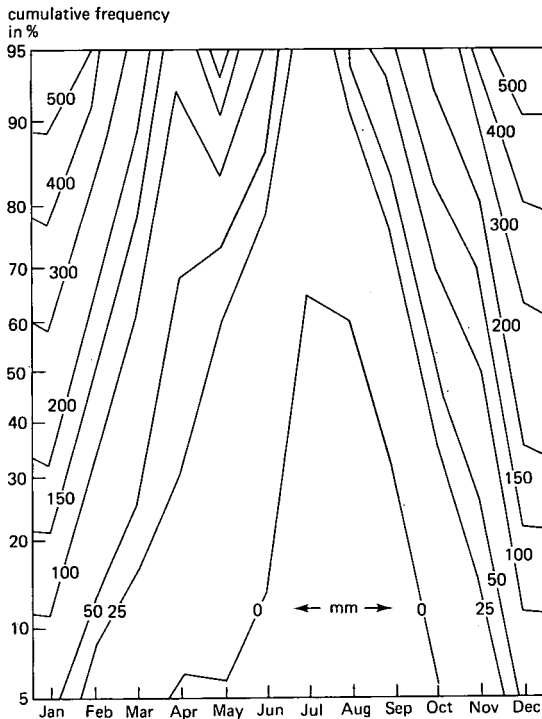

Figure 6.8 Frequencies of monthly rainfalls (Antalya, Turkey, 15 years of observations)

- The normal distribution, which is widely applicable and which forms the basis of many frequency analyses;
- The Gumbel distribution, which is very often used to analyze the frequency of maximum series;
- The exponential distribution, which is very simple and which can often be used instead of the Gumbel distribution.

The majority of hydrologic frequency curves can be described adequately with these few theoretical frequency distributions. The choice of the most appropriate theoretical distribution is a matter of judgement.

6.4.2 Principles of Distribution Fitting

There are two methods of fitting theoretical distributions to the data. They are:

- The plotting, graphic, or regression method. Plot the results obtained from the ranking method on probability paper of a type that corresponds to the selected theoretical distribution and construct the best-fitting line;
- The parametric method. Determine the parameters of the theoretical distribution (e.g. the mean and standard deviation) from the data.

Examples of distribution fitting are given in the following sections. The emphasis will be on the parametric method.

It has been observed that hydrologic data averaged over a long duration (e.g. average yearly discharges) often conform to the normal distribution. Similarly, the maxima inside long-time records (e.g. the maximum 1-day discharge per year) often conform to the Gumbel or to the exponential distribution. According to probability theory, this conformation becomes better as the records from which the maximum is chosen become longer, long records being the best guarantee of a reliable distribution fitting.

Determining the Parameters

For theoretical frequency distributions, the following parameters (characteristics of the distribution) are used:

- μ , the mean value of the distribution;
- σ , the standard deviation of the distribution, which is a measure for the dispersion of the data.

These parameters are estimated from a data series with Estimate (μ) = \bar{x} and Estimate (σ) = s , where \bar{x} and s are determined from

$$\bar{x} = \frac{1}{n} \sum x_i \quad (6.12)$$

$$s^2 = \frac{1}{n-1} \sum (x_i - \bar{x})^2 = \frac{1}{n-1} \left\{ \sum x_i^2 - \frac{(\sum x_i)^2}{n} \right\} \quad (6.13)$$

where x_i is the value of the i -th observation of phenomenon x , and n is the total number of observations. Hence, $i = 1, 2, 3, \dots, n$.

Once \bar{x} and s are known, estimated frequencies can be calculated from the theoretical distributions for each value of x . The estimated parameters, like the frequency, are subject to random error, which becomes smaller as n increases.

In this chapter, the parametric method is preferred over the plotting method because the estimates of \bar{x} and s (Equations 6.12 and 6.13) are unbiased, whereas the advance estimates of frequencies, which are needed for the plotting method, are probably not unbiased. Moreover, the parametric method is simpler and more straightforward.

The plotting method introduces an artificially high correlation between the data and the frequencies because of the ranking procedure, and the relatively small deviations of the plotting positions from the fitted distribution are no measure of reliability (Section 6.4.6).

6.4.3 The Normal Distribution

The normal frequency distribution, also known as the Gauss or the De Moivre distribution, cannot be expressed directly as a frequency of occurrence. Hence, it is expressed as a frequency density function

$$f(x) = \frac{1}{\sigma\sqrt{2\pi}} \exp \left\{ -\frac{(x - \mu)^2}{2\sigma^2} \right\} \quad (6.14)$$

where

- $f(x)$ = the normal frequency density function of x
- x = the normal variate ($-\infty < x < \infty$)
- μ = the mean of the distribution
- σ = the standard deviation of the distribution.

A frequency of occurrence in a certain interval a - b can be found from

$$F(a < x < b) = \int_a^b f(x) dx \quad (6.15)$$

so that the cumulative (or non-exceedance) frequency of x_r equals

$$F(x < x_r) = \int_{-\infty}^{x_r} f(x) dx$$

and the exceedance frequency of x_r equals

$$F(x > x_r) = \int_{x_r}^{\infty} f(x) dx$$

To solve this, it is necessary to use tables of the standard normal distribution, as analytic integration is not possible.

Because $\int_{-\infty}^{\infty} f(x) dx = 1$ (compare with Equation 6.2), it follows that

$$F(x > x_r) = 1 - F(x \leq x_r) \quad (6.16)$$

which is comparable to Equation 6.4.

Figure 6.9A illustrates a normal frequency density function. We can see that the density function is symmetric about μ . The mode u , i.e. the value of x where the function is maximum, coincides with the mean μ . The frequency of both the exceedance and the non-exceedance of μ and u equals 0.5, or 50%. Therefore, the median g , i.e. the

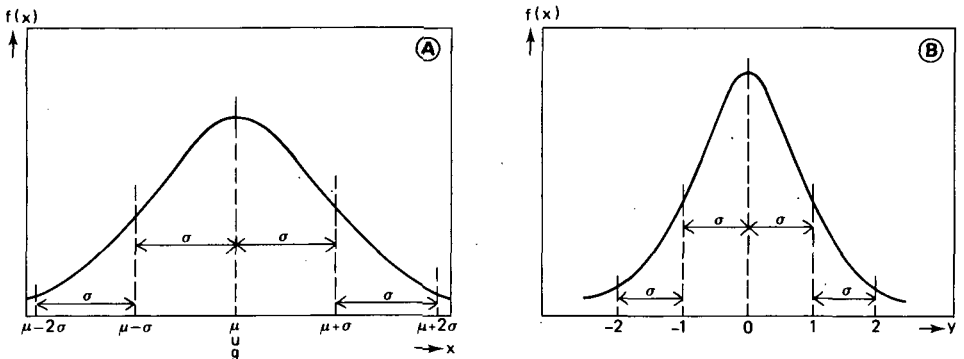

Figure 6.9 Normal distributions and some common properties. A: Normal frequency density function. B: Standard normal frequency density function

Table 6.6 Frequencies of exceedance f of the standard normal variate y (positive y values only)

y	f	y	f	y	f
0.0	.50	1.0	.16	2.0	.023
0.1	.46	1.1	.14	2.1	.018
0.2	.42	1.2	.12	2.2	.014
0.3	.38	1.3	.097	2.3	.011
0.4	.34	1.4	.081	2.4	.008
0.5	.31	1.5	.067	2.5	.006
0.6	.27	1.6	.055	2.6	.005
0.7	.24	1.7	.045	2.7	.004
0.8	.21	1.8	.036	2.8	.003
0.9	.18	1.9	.029	2.9	.002

value of x that indicates exactly 50% exceedance and non-exceedance, also coincides with the mean.

If $\mu = 0$ and $\sigma = 1$, the distribution is called a standard normal distribution (Figure 6.9B). Further, using the variate y instead of x to indicate that the distribution is a standard normal distribution, we see that the density function (Equation 6.14) changes to

$$f(y) = \frac{1}{\sqrt{2\pi}} \exp(-y^2/2) \tag{6.17}$$

Tables of frequencies $f(y)$ can be found in statistical handbooks (e.g. Snedecor and Cochran 1986). If we use either of the transformations $x = \mu + \sigma y$ or $y = (x - \mu)/\sigma$ or, if we use the estimated values \bar{x} for μ and s for σ (Equation 6.12 and 6.13)

$$x = \bar{x} + s.y \quad \text{or} \quad y = (x - \bar{x})/s \tag{6.18}$$

we can use the tabulated standard distribution (e.g. Table 6.6) to find any other normal distribution.

The central limit theory states that, whatever the distribution of x , in a sample of size n the arithmetic mean (\bar{x}_n) of x will approach a normal distribution as n increases.

An annual rainfall, being the sum of 365 daily rainfalls x_i , equals $365\bar{x}_i$. Because n is large (365), annual rainfalls are usually normally distributed. The general effect of the duration on the shape of the frequency distribution is illustrated in Figure 6.10.

If there is a sample series available that is assumed to have a normal distribution, we can estimate μ and σ using Equations 6.12 and 6.13. The standard error $\sigma_{\bar{x}}$ of the arithmetic mean \bar{x} of the sample is smaller than the standard deviation σ_x of the individual values of the distribution. So, for independent data x_1, \dots, x_n , we obtain

$$\sigma_{\bar{x}} = \frac{\sigma_x}{\sqrt{n}} \tag{6.19}$$

Hence, the estimated value $s_{\bar{x}}$ of $\sigma_{\bar{x}}$ equals

$$s_{\bar{x}} = \frac{s_x}{\sqrt{n}} \tag{6.20}$$

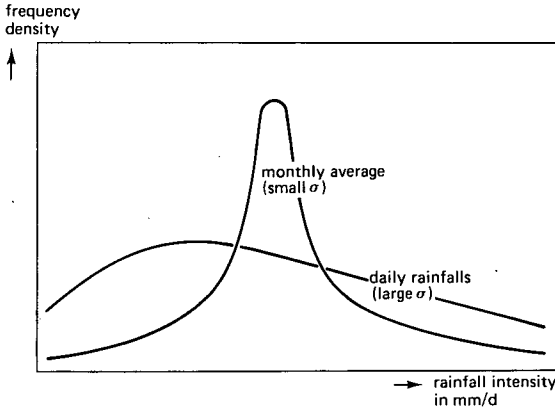

Figure 6.10 Monthly average rainfall intensities (in mm/d) have a narrower, more peaked, and more symmetrical frequency distribution than daily rainfalls

For example, the average monthly rainfall intensity, expressed in mm/d, has a standard deviation $\sqrt{30}$ times smaller than that of the individual daily rainfalls. In other words, the average monthly rainfall intensity has a frequency distribution that is narrower, but more highly peaked, than the average daily rainfall intensity (Figure 6.10).

If the distribution is skewed, i.e. asymmetrical, we can often work with the root-normal or with the log-normal distribution (B in Figure 6.11), simply by using $z = \sqrt{x}$ or $z = \log x$ and then by applying the principles of the normal distribution to z instead of to x . If, however, there are many observations with zero values (of which no logarithm can be taken), we should use a censored normal distribution without the small values of x (A in Figure 6.11).

Procedure and Example

For an idea of how to use the normal distribution, let us look at Figure 6.12, where the monthly totals of Table 6.4 have been plotted on normal probability paper. The probability axis has been constructed to present the cumulative normal distribution as a straight line. The parameters have been estimated from Table 6.4, according to

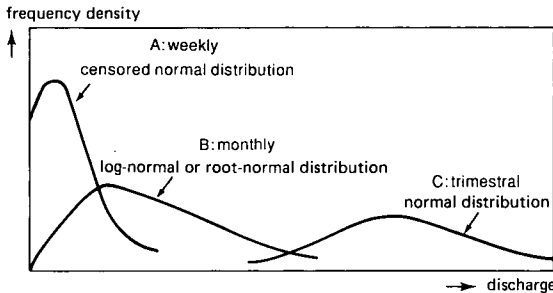

Figure 6.11 Frequency distributions of total discharge of different durations: weekly, monthly, and trimestral

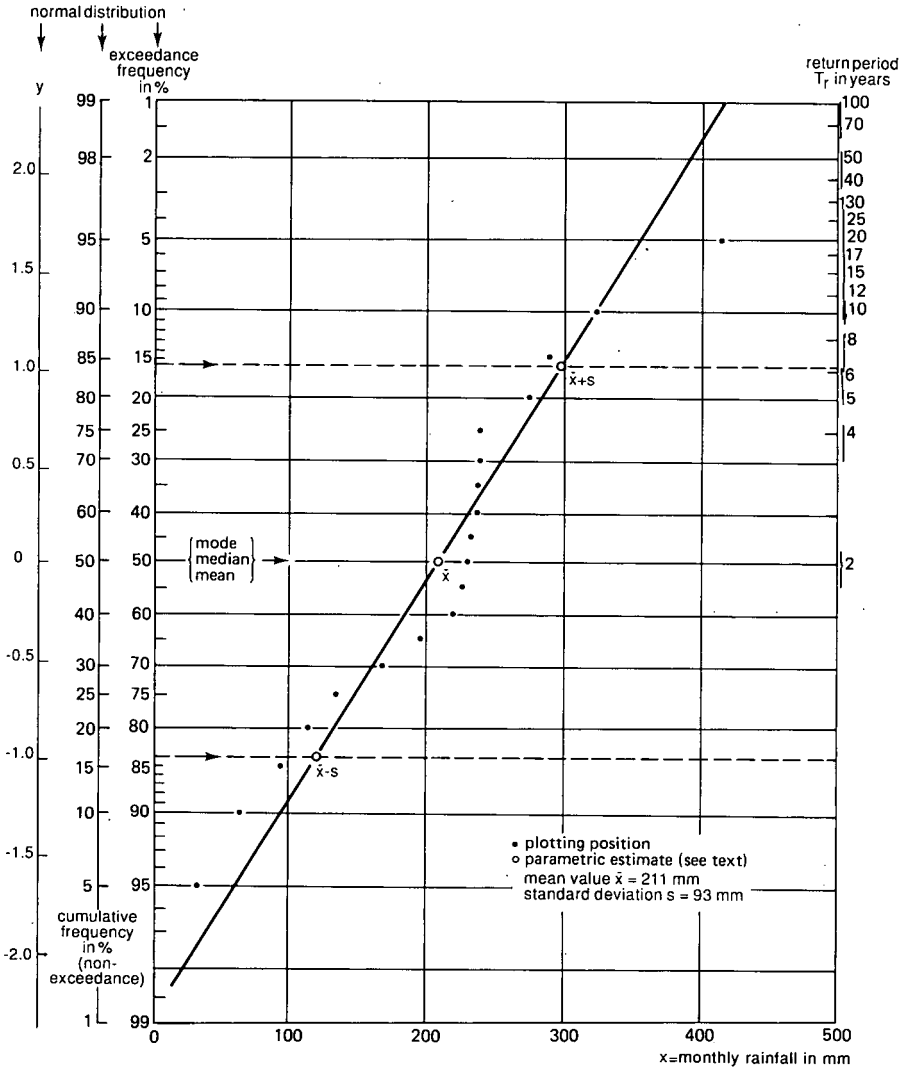

Figure 6.12 Monthly rainfalls, plotted on normal probability paper with a fitted line, based on the parametric method (derived from Table 6.4)

Equations 6.12 and 6.13, as

$$\bar{x} = \frac{\sum x}{n} = \frac{4017}{19} = 211$$

$$s = \sqrt{\frac{\sum x^2 - n(\bar{x})^2}{n-1}} = \sqrt{\frac{1003161 - 19 \times (211)^2}{18}} = 93$$

The value $x = \bar{x} + s = 211 + 93 = 304$ has a corresponding y value equal to 1 (Equation 6.18). Table 6.6 shows that this y value corresponds to a frequency of

exceedance of $f = 0.16$, or 16%, from which it follows that the cumulative (non-exceedance) frequency is 0.84, or 84% (Equation 6.16). Because the normal distribution is symmetrical, we find that the value $x = \bar{x} - s = 211 - 93 = 118$ should correspond to a frequency of non-exceedance of $1 - 0.84 = 0.16$, or 16%, and a y value equal to -1 .

Accordingly, in Figure 6.12, the values $x = 304$ and $x = 118$ are plotted against the 84% and 16% non-exceedance (cumulative) frequencies. The mean value $\bar{x} = 211$ (for which $y = 0$, as in Equation 6.18) can be plotted against the 50% cumulative frequency (Table 6.6). A straight line can be drawn through the above three points.

We can conclude that the estimated return period of the observed monthly rainfall total of 422 mm is approximately 100 years instead of the 20 years we find in Table 6.4. There is, however, a 10% chance that the return period of this rainfall is smaller than 7 years or greater than 5000 years (Figure 6.3). This will be discussed further in Section 6.4.6.

The Log-Normal Distribution

An example of the application of the log-normal distribution is given in Figure 6.13. The data used here are derived from Table 6.5, which shows monthly maximum one-day rainfalls.

Because we can expect the maximum 1-day rainfalls to follow a skewed distribution, we are using the log-values ($z = \log x$) of the rainfall instead of the real values (x), the assumption being that this transformation will make the frequency distribution symmetrical.

The procedure for normal distribution fitting is now exactly the same as before. So with the data from Table 6.5, we can calculate that $\bar{z} = 1.75$ and that $s = 0.29$, meaning that, if we plot the value $z = \bar{z} + s = 2.04$ against the 16% ($y = 1$) exceedance frequency and the value $z = \bar{z} - s = 1.46$ against the 84% ($y = -1$) exceedance frequency, we can draw a straight line through these points, as shown in the figure.

The figure also shows that a rainfall of 200 mm, for which $z = \log 200 = 2.30$, has a return period of about 30 years, whereas in Table 6.5 this return period is about 20 years.

In addition to the log-normal distribution, the figure shows a confidence belt that was constructed according to the principles of confidence analysis. From this belt, we can see that a rainfall of 100 mm (point A) has a 90% confidence interval, ranging from 70 mm (point B) to 180 mm (point C). The return period of this rainfall (5 years) has a confidence interval that ranges from 2.5 years (point D) to almost 15 years (point E).

We shall interpret the data in Figure 6.13 further in Section 6.4.6.

6.4.4 The Gumbel Distribution

The Gumbel distribution (Gumbel 1954), also called the Fisher-Tippett Type I distribution of extreme values, can be written as a cumulative frequency distribution

$$F(x_N < x_r) = \exp \{-\exp(-y)\} \quad (6.21)$$

where

x_N = the maximum x from a sample of size N

x_r = a reference value of x_N

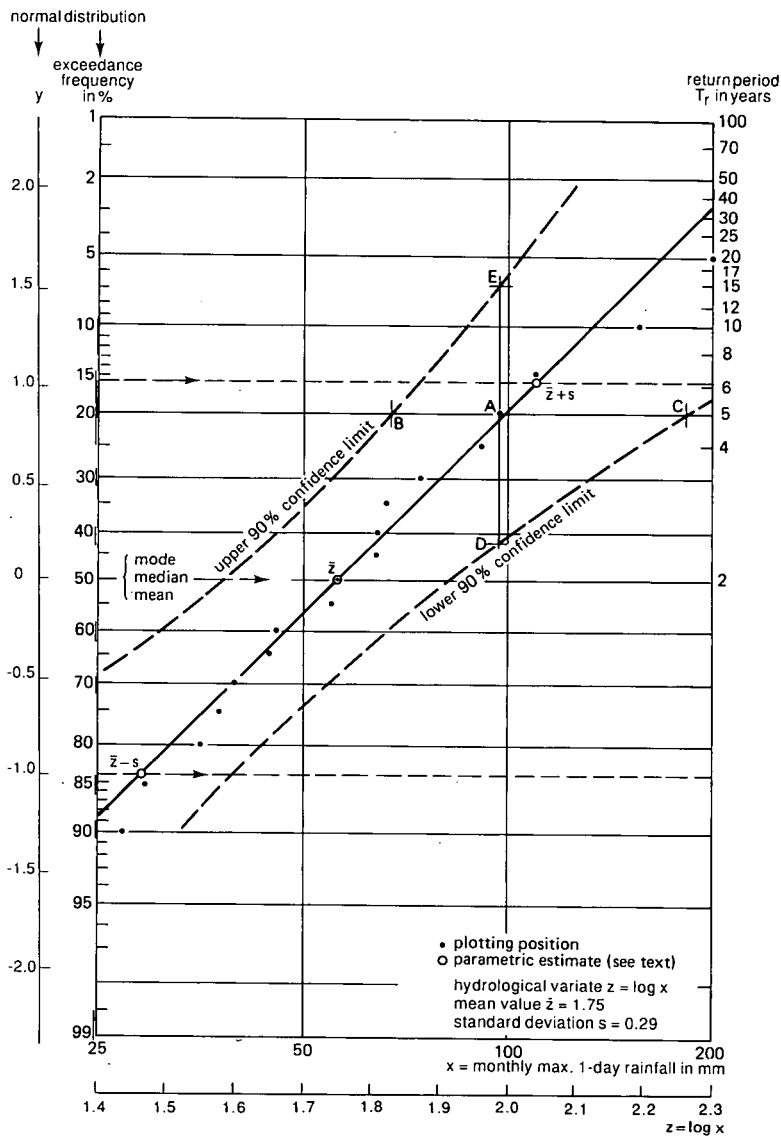

Figure 6.13 The log values of the data of Table 6.5, plotted on normal probability paper with a fitted line, based on the parametric method

$y = \alpha(x_r - u)$, the reduced Gumbel variate

$u = \mu - c/\alpha$, the mode of the Gumbel distribution

μ = mean of the Gumbel distribution

c = Euler's constant = 0.577

$$\alpha = \frac{\pi}{\sigma\sqrt{6}}$$

σ = the standard deviation of the Gumbel distribution.

By estimating μ and σ (Equations 6.12 and 6.13), we can determine the entire frequency distribution.

The Gumbel distribution is skewed to the right, with $u < \mu$ and the median g in between. The introduction of $x_r = u$ into the equation for the Gumbel distribution yields

$$F(x_N < u) = e^{-1} = 0.37 \quad (6.22)$$

Therefore the probability of non-exceedance of the mode u equals 0.37, or 37%, and the probability of exceedance is $1 - 0.37 = 0.63$, or 63%.

The cumulative probability distribution of the maximum value in a sample of size N , drawn from an exponential distribution will asymptotically approach the Gumbel distribution as N increases. Hydrologists assume that this asymptotic approach occurs when $N > 10$, and so they frequently use the Gumbel distribution to find annual or monthly maxima of floods or to find rainfalls of short duration (less than 1/10 of a year or of a month).

To determine the Gumbel distribution, we need several (n) samples of size N (total $n \times N$ data) from which to select the n maxima. In this way, annual, monthly, or seasonal maximum series can be composed for various durations (each duration containing at least $N = 10$ independent data from which to choose the maximum).

Taking natural logarithms twice, we can write the Gumbel distribution as

$$y = \alpha(x_r - u) = -\ln \{-\ln F(x_N < x_r)\} \quad (6.23)$$

Gumbel probability paper is constructed to allow plotting of cumulative frequencies on a $-\ln(-\ln)$ scale, which yields a linear relationship with x_N . A straight line of best fit can thus be drawn or calculated by regression analysis.

Procedure and Example

For this example, the monthly maximum 1-day rainfalls presented in Table 6.5 are used. Figure 6.14 shows the cumulative frequencies plotted on Gumbel probability paper and a straight line calculated from Equation 6.23. As estimates of μ and σ , we get

$$\bar{x} = \Sigma x/n = 1317/19 = 69 \text{ (Equation 6.12)}$$

$$s^2 = \frac{1}{n-1} (\Sigma x^2 - n\bar{x}^2) = \frac{1}{18} (130615 - 19 \times 69^2) = 2231 \text{ (Equation 6.13)}$$

$$s = \sqrt{2231} = 47$$

so that, according to Equation 6.21

$$\alpha = \pi/s\sqrt{6} = \pi/47\sqrt{6} = 0.027$$

$$u = \bar{x} - c/\alpha = 69 - 0.577/0.027 = 48$$

Substitution of the above estimates into the equation $y = \alpha(x_r - u)$ gives $y = 0.027(x_r - 48)$. This is the expression of a straight line on Gumbel probability paper (Equation 6.23). Determination of two arbitrary points gives

$$y = 0 \rightarrow x_r = u = 48 \text{ mm, and } F(x_N < 48) = 0.37$$

$$y = 3 \rightarrow x_r = 159 \text{ mm, and } F(x_N < 159) = 0.95$$

The plotting of these two points produces the straight line that characterizes the Gumbel distribution (Figure 6.14).

6.4.5 The Exponential Distribution

The exponential distribution can be written as an exceedance frequency distribution

$$F(x > x_r) = \exp \{-\lambda(x_r - a)\} \quad (6.24)$$

where

- x_r = a reference value of x
- a = the minimum value of x_r
- $\lambda = 1/(\mu - a)$
- μ = the mean of the distribution.

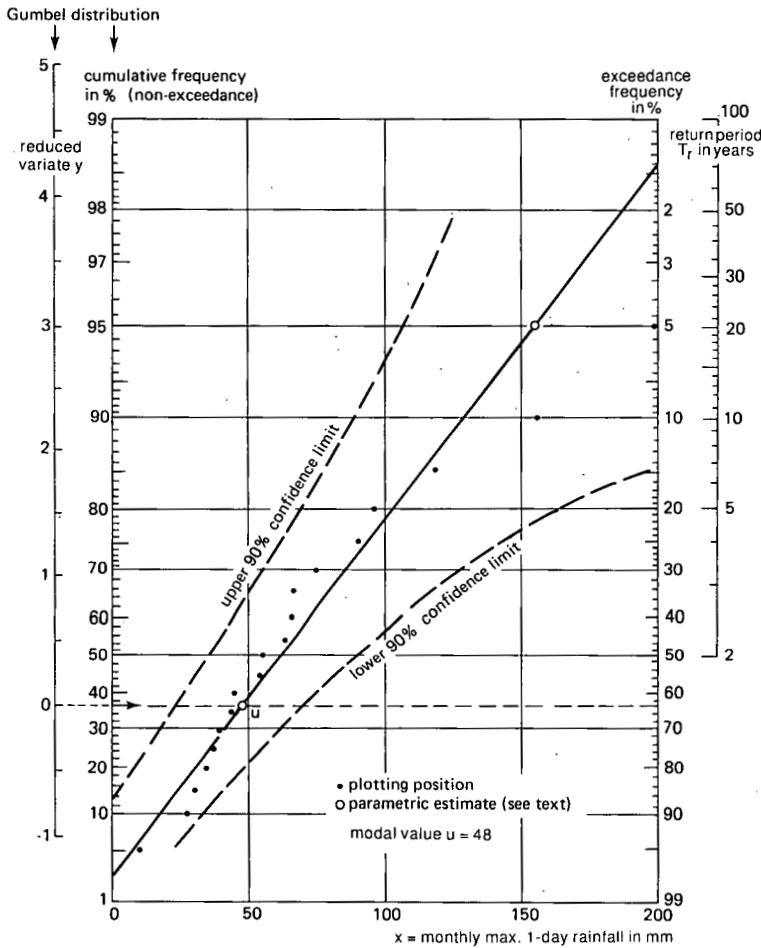

Figure 6.14 The data of Table 6.5, plotted on Gumbel probability paper with a fitted line, based on the parametric method. The 90% confidence limits are shown

Theoretically, the value of the standard deviation equals $\sigma = \mu = a + 1/\lambda$. Hence we need to know either σ or μ . Contrary to the normal distribution and the Gumbel distribution, both of which have two parameters, the exponential distribution has only one parameter if a is known.

For $x_r = \mu$, we find from Equation 6.24 that $F(x > \mu) = e^{-1} = 0.37$. Hence, the mean and the median are not equal, and the distribution is skewed.

The exponential distribution can be used for maxima selected from certain series of data, just as we saw for the Gumbel distribution in the previous section, or it can be used for selected values that surpass a certain minimum value (censored series).

Equation 6.24 can also be written as

$$\lambda(x_r - a) = -\ln \{F(x > x_r)\} \quad (6.25)$$

meaning that a plot of x_r or $(x_r - a)$ versus $-\ln \{F(x > x_r)\}$ will yield a straight line. For $x_r = \mu$, we find from Equation 6.25 that $-\ln F(x > \mu) = 1$.

Procedure and Example

Let us apply an exponential distribution to the maximum monthly 1-day rainfalls given in Table 6.5. The estimate of μ is

$$\bar{x} = \Sigma x/n = 1317/19 = 69 \text{ mm (Equation 6.12)}$$

Using $a = 10$ (the lowest maximum rainfall recorded), we find that $\lambda = 1/(\mu - a) = 1/(69 - 10) = 0.017$. The exponential distribution for the data of Table 6.5 is now expressed as

$$F(x > x_r) = \exp \{-0.017(x_r - 10)\}$$

Using $x_r = 150$ mm and $x_r = 75$ mm, we find that $F(x > 150) = 0.09$ and that $F(x > 75) = 0.33$, so that $\ln F(x > 150) = -2.4$ and $\ln F(x > 75) = -1.1$. On the basis of the linearity shown in Equation 6.25, these points can be plotted and connected by a straight line (Figure 6.15).

Note that the baseline used by Benson (Figure 6.2) stems from an exponential distribution. The line can be described by the equation $x = \alpha \ln T_r + a$, where α and a are constants. This equation can also be written as $\lambda(x - a) = \ln T_r$ where $\lambda = 1/\alpha$. Because, according to Equation 6.9, $T_r = 1/F(x > x_r)$, and, therefore, $\ln T_r = -\ln\{F(x > x_r)\}$, the baseline can also be expressed as $\lambda(x - a) = -\ln\{F(x > x_r)\}$, which is identical to the expression of the exponential distribution given by Equation 6.25.

The Log-Exponential Distribution

Figure 6.16 shows a depth-return period relation of 1-day rainfalls. These rainfalls were derived from the a_i values of Table 6.2 and plotted on double-logarithmic paper. The line represents a log-exponential distribution, for which the rainfall x was transformed into $z = \log x$ in the same way the log-normal distribution was transformed previously.

The straight line can be expressed as

$$\ln T_r = \alpha + \lambda \log x_r$$

where α and λ are constants, and x_r is a certain value of the rainfall x . With $T_r = 1/F(x > x_r)$, this equation changes to

$$-\ln\{F(x > x_r)\} = \lambda(\log x_r + \alpha/\lambda)$$

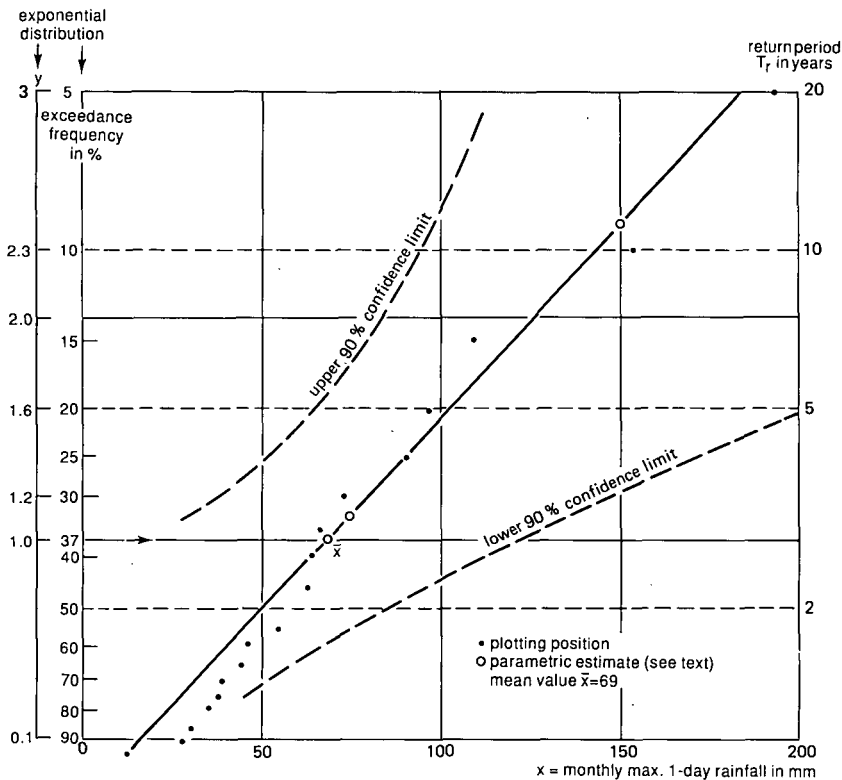

Figure 6.15 The data of Table 6.5, plotted on linear graph paper against the natural logarithm of the exceedance frequency to obtain an exponential frequency distribution. The fitted line, based on the parametric method, and the 90% confidence limits are shown

If we compare this with Equation 6.25, we see that $a = -\alpha/\lambda$, and that the only difference remaining is the presence of $\log x_r$ instead of x_r .

This means that, if the data conform, the log-exponential distribution can be used instead of the exponential distribution. The best fit to the data will determine which distribution to use.

6.4.6 A Comparison of the Distributions

The monthly maximum 1-day rainfalls from Table 6.5 were used to derive the log-normal, the Gumbel, and the exponential frequency distributions, along with their confidence intervals (Figures 6.13, 6.14, and 6.15). We can see that the data, all of which were plotted with the ranking method, do not lie on the straight lines calculated with the parametric estimates of the frequency distributions. Nevertheless, they are fully within the confidence belts. Hence, in this case at least, it is difficult to say whether there is a significant difference between the ranking procedure and the parametric method.

The figures show that the relatively small scatter of the plotting positions around

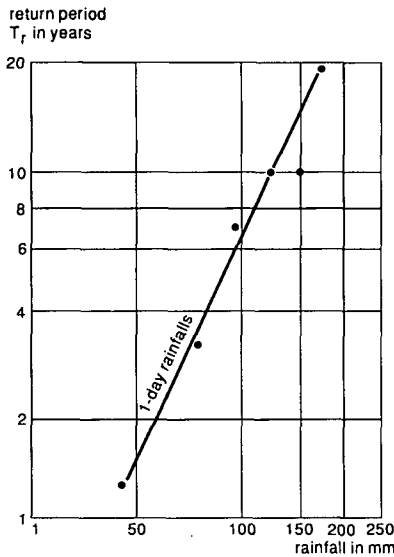

Figure 6.16 Depth-return period relation of 1-day rainfalls derived from Table 6.2, plotted on double-logarithmic paper

the straight line is no measure of the width of the confidence belt. This is owing to the artificially high correlation that the ranking method introduces between the data and the frequencies.

Table 6.7 shows the different return periods of the 200 mm rainfalls estimated with the different theoretical distributions, including the 90% confidence interval (Figures 6.13 and 6.14, and 6.15).

The table shows that the different distributions give different return periods for the same rainfall. Owing to the limited number of available data (19), the confidence intervals are very wide, and the predicted return periods are all well inside all the confidence intervals. Hence, the differences in return period are not significant, and one distribution is no better or worse than the other.

We can prepare a table of confidence limits not only for the return period of a certain rainfall (Table 6.7), but also for the rainfall with a certain return period (Table 6.8). This can be done, however, only after a graphical or a theoretical relation between rainfall and frequency has been established.

Table 6.7 Estimates of the return periods (in years) and the confidence intervals of the 200-mm rainfall of Table 6.5, as calculated according to 4 different methods

Estimation method	Return period (T_r)	90% confidence interval of T_r	
		Lower limit	Upper limit
Ranking method	20	5	400
Log-normal distribution	30	6	500
Exponential distribution	25	5.5	400
Gumbel distribution	60	7	5000

Table 6.8 Maximum daily November rainfalls (in mm), with a return period of 5 years, as calculated according to 3 different distributions

Estimation method	Rainfall with $T_r = 5$	90% confidence limits	
		Lower limit	Upper limit
Log-normal distribution (Figure 6.13)	98	69	191
Gumbel distribution (Figure 6.14)	104	71	173
Exponential distribution (Figure 6.15)	105	71	206

The data in the two tables indicate that there is no significant difference between the results obtained by the different methods.

6.5 Regression Analysis

6.5.1 Introduction

Regression analysis was developed to detect the presence of a mathematical relation between two or more variables subject to random variation, and to test if such a relation, whether assumed or calculated, is statistically significant. If one of these variables affects the other, that variable is called the independent variable. The variable that is affected is called the dependent variable.

Often we do not know if one variable is directly affected by another, or if both variables are influenced by common causative factors that are unknown or that were not observed. Then we have to choose the (in)dependent variables arbitrarily. We shall consider here relations with only one dependent and one independent variable. For this, we shall use a two-variable regression. For relations with several independent variables, a multivariate regression is used.

Linear two-variable regressions are made according to one of two methods. These are:

- The ratio method (Section 6.5.2);
- The 'least squares' method (Section 6.5.3).

The ratio method is often used when the random variation increases or decreases with the values of the variables. If this is not the case, the least-squares method is used. The ratio method, as we use it here, consists of two steps, namely:

- Calculate the ratio $p = y/x$ of the two variables y and x ;
- Calculate the average ratio \bar{p} , its standard error $s_{\bar{p}}$, and its upper and lower confidence limits \bar{p}_u and \bar{p}_v , to obtain the expected range of \bar{p} of repeated samples.

The least squares method consists of finding a mathematical expression for the relation between two variables x and y , so that the sum of the squared deviations from the mathematical relation is minimized. This method can be used for three types of regressions:

- Regressions of y upon x;
- Regressions of x upon y;
- Two-way regressions.

Regressions of y upon x are made if y is causally influenced by x, or to predict the value of y from a given value of x. In these regressions, the sum of the squared deviations of y to the regression line, i.e. in the y-direction, are minimized.

Regressions of x upon y are made to predict the value of x from a given value of y. Except for the reversal of the variables, the procedure for making these regressions is identical to that for making regressions of y upon x. However, here it is the sum of the squared deviations of x that are minimized.

Two-way regressions are made if no dependent variable can be selected, or if one is more interested in the parameters of the regression line than in the values of the variables. These are intermediate regressions that cover the territory between regressions of y upon x and of x upon y.

The relation between y and x need not be linear. It can be curved. To detect a non-linear relation, it is common practice to transform the values of y and x. If there is a linear relation between the transformed values, a back-transformation will then yield the desired non-linear relation. The majority of these transformations are made by taking log-values of y and x, but other transformations are possible (e.g. square root functions, goniometric functions, polynomial functions, and so on). Curve fitting can be done conveniently nowadays with computer software packages. Further discussion of non-linear regressions is limited to Example 6.3 of Section 6.5.4 and Example 6.4 of Section 6.5.5. For more details, refer to statistical handbooks (e.g. Snedecor and Cochran 1986).

6.5.2 The Ratio Method

If the variation in the data (x, y) tends to increase linearly, the ratio method can be applied. This reads

$$y = p.x + \varepsilon \quad \text{or} \quad \hat{y} = p.x$$

or

$$y/x = p + \varepsilon' \quad \text{or} \quad (\hat{y}/x) = p$$

where

- p = a constant (the ratio)
- \hat{y} = the expected value of y according to the ratio method
- ε and ε' = a random deviation
- (\hat{y}/x) = the expected value of the ratio y/x

Figure 6.17 suggests that there is a linear relation between y and x, with a linearly increasing variation. The envelopes show that the ratio method is applicable. In situations like this, it is best to transform the pairs of data (y, x) into ratios $p = y/x$. The average ratio for n pairs is then calculated as

$$\bar{p} = \frac{1}{n} \sum p \tag{6.26}$$

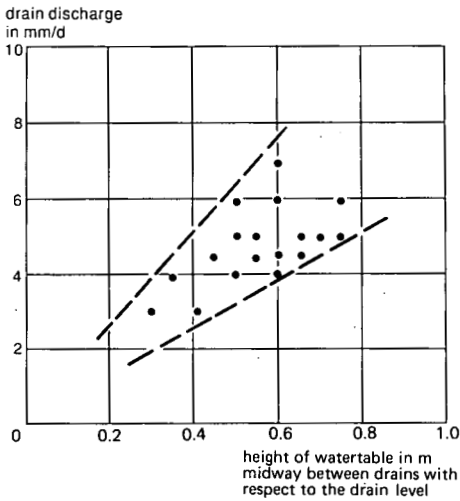

Figure 6.17 The ratio method. The variation of y increases with increasing x

Using Equation 6.13, we find the standard deviation of p from

$$s_p^2 = \frac{1}{n-1} \sum (p - \bar{p})^2 = \frac{1}{n-1} \left(\sum p^2 - \frac{(\sum p)^2}{n} \right) \quad (6.27)$$

and using Equation 6.19, we find the standard error of \bar{p} from

$$s_{\bar{p}} = \frac{s_p}{\sqrt{n}} \quad (6.28)$$

Standard errors of y and \hat{y} can be found from $s_y = x s_p$ and $s_{\hat{y}} = x s_{\bar{p}}$.

The confidence interval of \bar{p} , i.e. the expected range of \bar{p} of repeated samples, is approximated by

$$\bar{p}_u = \bar{p} + t s_{\bar{p}} \quad (6.29)$$

$$\bar{p}_v = \bar{p} - t s_{\bar{p}} \quad (6.30)$$

Here, the subscripts u and v denote the upper and lower confidence limits. The letter t stands for the variate of Student's distribution (Table 6.9) at the frequency of exceedance f . If one wishes an interval with $c\%$ confidence, then one should take $f = 0.5(100 - c)/100$ (e.g. $f = 0.05$ when $c = 90\%$). The value of t depends on the number (n) of observations. For large values of n , Student's distribution approaches the standard normal distribution. For any value of n , the t -distribution is symmetrical about $t = 0$.

If the confidence interval $\bar{p}_u - \bar{p}_v$ contains a zero value, then \bar{p} will not differ significantly from zero at the chosen confidence level c . Although the value of \bar{p} is then called insignificant, this does not always mean that it is zero, or unimportant, but only that it cannot be distinguished from zero owing to a large scatter or to an insufficient number of data.

Table 6.9 Values t of Student's distribution with d degrees of freedom* and frequency of exceedance f

d	$f = 0.10$	0.05	0.025	0.01
5	1.48	2.02	2.57	3.37
6	1.44	1.94	2.45	3.14
7	1.42	1.90	2.37	3.00
8	1.40	1.86	2.31	2.90
9	1.38	1.83	2.26	2.82
10	1.37	1.81	2.23	2.76
12	1.36	1.78	2.18	2.68
14	1.35	1.76	2.15	2.62
16	1.34	1.75	2.12	2.58
20	1.33	1.73	2.09	2.53
25	1.32	1.71	2.06	2.49
30	1.31	1.70	2.04	2.46
40	1.30	1.68	2.02	2.42
60	1.30	1.67	2.00	2.39
100	1.29	1.66	1.99	2.37
200	1.28	1.65	1.97	2.35
∞	1.28	1.65	1.96	2.33

* For the ratio method $d = n - 1$, because variation starts if there is more than one data pair; linear regression requires more than two data pairs, so $d = n - 2$

The confidence interval of \hat{y} is found likewise from $\hat{y}_u = \hat{y} + ts_y$ and $\hat{y}_v = \hat{y} - ts_y$.

Figure 6.18 illustrates situations where y is not zero when $x = 0$. When this occurs, the ratio method can be used if $y - y_0$ is substituted for y , and if $x - x_0$ is substituted for x . In these cases, x_0 and y_0 should be determined first, either by eye or by mathematical optimization.

Example 6.1

A series of measurements of drain discharge and watertable depth are available on an experimental area. The relation between these two variables is supposedly linear, and the variation of the data increases approximately linearly with the x and y values. We shall use the ratio method to find the relation. The data are tabulated in Table 6.10.

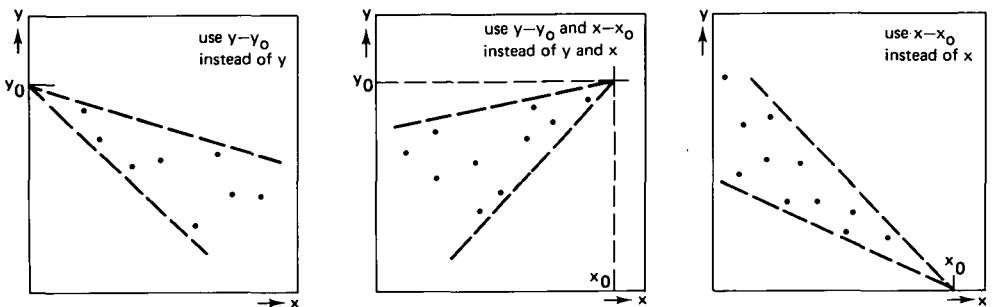

Figure 6.18 Adjustments of the ratio method when y and x are not zero

Table 6.10 Data used in Figure 6.17, where y = drain discharge (mm/d) and x = height of the watertable (m) midway between the drains, with respect to the drain level

no.	y	x	$p = y/x$	no.	y	x	$p = y/x$
1	3.0	0.30	10.0	10	7.0	0.60	11.7
2	4.0	0.35	11.4	11	6.0	0.60	10.0
3	3.0	0.40	7.5	12	4.5	0.60	7.5
4	4.5	0.45	10.0	13	4.0	0.60	6.7
5	6.0	0.50	12.0	14	5.0	0.65	7.7
6	5.0	0.50	10.0	15	4.5	0.65	6.9
7	4.0	0.50	8.0	16	5.0	0.70	7.1
8	5.0	0.55	9.1	17	6.0	0.75	8.0
9	4.5	0.55	8.2	18	5.0	0.75	6.7

Ratio method : $\bar{p} = y/x, \Sigma p = 158.5, \Sigma p^2 = 448, n = 18$

Equation 6.26 : $\bar{p} = 158.5/18 = 8.8$

Equation 6.27 : $s_p = \sqrt{(1448 - 18 \times 8.8^2)/17} = 1.78$

Equation 6.28 : $s_{\bar{p}} = 1.78/\sqrt{18} = 0.42$

Table 6.9 : $f = 0.05$ and $d = 17 \rightarrow t_{90\%} = 1.75$

Equation 6.29 : $\bar{p}_u = 8.8 + 1.75 \times 0.42 = 9.5$

Equation 6.30 : $\bar{p}_v = 8.8 - 1.75 \times 0.42 = 8.1$

The data of Table 6.10 show that parameter \bar{p} is estimated as 8.8, the 90% confidence limits being $\bar{p}_u = 9.5$ and $\bar{p}_v = 8.1$. Hence the ratio p is significantly different from zero. In Chapter 12, the ratio is used to determine the hydraulic conductivity.

6.5.3 Regression of y upon x

The linear regression of y upon x is designed to detect a relation like the following

$$y = ax + b + \epsilon \quad \text{or} \quad \hat{y} = ax + b \quad (6.31)$$

where

a = the linear regression coefficient, representing the slope of the regression line

b = the regression constant, giving the intercept of the regression line on the y axis

ϵ = a random deviation of the y value from the regression line

\hat{y} = the expected value of y according to the regression ($\hat{y} = y - \epsilon$).

This regression is used when the ϵ values are independent of the values of y and x . It is used to predict the value of y from a value of x , regardless of whether they have a causal relation.

Figure 6.19 illustrates a linear regression line that corresponds to 8 numbered points on a graph. A regression line always passes through the central point of the data (\bar{x}, \bar{y}). A straight line through (\bar{x}, \bar{y}) can be represented by

$$(y - \bar{y}) = a(x - \bar{x}) \quad (6.32)$$

where a is the tangent of the angle α in the figure.

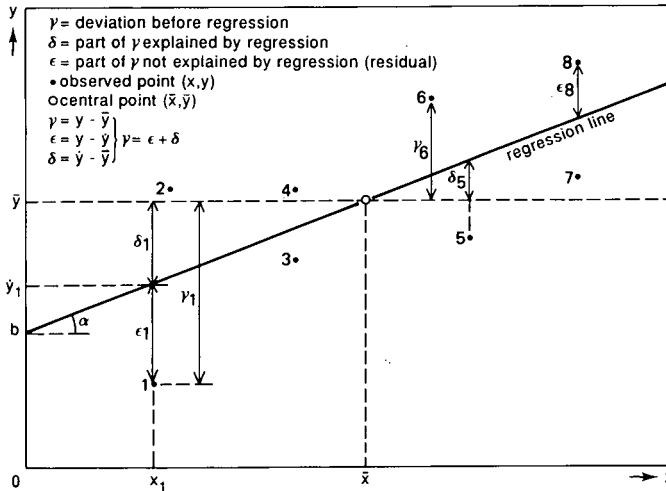

Figure 6.19 Variations in the y-direction

Normally, the data (x, y) do not coincide with the line, so a correct representation of the regression is

$$(y - \bar{y}) = a(x - \bar{x}) + \epsilon \quad (6.33)$$

where ϵ is a vertical distance of the point (x, y) to the regression line. The sum of all the ϵ values equals zero. The difference $y - \epsilon$ gives a y value on the regression line, \hat{y} . Substitution of $\hat{y} = y - \epsilon$ in Equation 6.33 gives

$$(\hat{y} - \bar{y}) = a(x - \bar{x}) \quad (6.34)$$

where a is called the regression coefficient of y upon x . Equation 6.34 can also be written as

$$\hat{y} = a x + \bar{y} - a \bar{x} \quad (6.35)$$

By substituting $b = \bar{y} - a \bar{x}$, we get Equation 6.31.

To determine the regression coefficient, one must minimize the $\Sigma \epsilon^2$ (the least squares method). In other words the regression line must fit the points as well as possible. To meet this condition we must take

$$a = \frac{\Sigma' yx}{\Sigma' x^2} \quad (6.36)$$

where

$$\Sigma' yx = \Sigma(y - \bar{y})(x - \bar{x}) = \Sigma(yx) - \frac{1}{n}(\Sigma y)(\Sigma x) \quad (6.37)$$

$$\Sigma' x^2 = \Sigma(x - \bar{x})^2 = \Sigma(x^2) - \frac{1}{n}(\Sigma x)^2 \quad (6.38)$$

$$\Sigma' y^2 = \Sigma(y - \bar{y})^2 = \Sigma(y^2) - \frac{1}{n}(\Sigma y)^2 \quad (6.39)$$

in which the symbol Σ' means 'reduced sum'. Equation 6.39 was included for use in the ensuing confidence statements.

The coefficient a can be directly calculated from the (x, y) pairs of data. If a is positive, the regression line slopes upward, and an increase in x causes an increase in y , and vice versa. If a is negative, the regression line slopes downward. If the regression coefficient a is zero, then there is no linear relation between y and x , and the line is horizontal.

The following equations give additional definitions (see Equation 6.13 also)

$$s_x^2 = \frac{\Sigma'x^2}{n-1} = \frac{\Sigma(x-\bar{x})^2}{n-1} = \frac{\Sigma x^2 - (\Sigma x)^2/n}{n-1} \quad (6.40)$$

where s_x^2 is called the variance of x

$$s_y^2 = \frac{\Sigma'y^2}{n-1} = \frac{\Sigma(y-\bar{y})^2}{n-1} = \frac{\Sigma y^2 - (\Sigma y)^2/n}{n-1} \quad (6.41)$$

where s_y^2 is called the variance of y

$$s_{xy} = \frac{\Sigma'xy}{n-1} = \frac{\Sigma(x-\bar{x})(y-\bar{y})}{n-1} = \frac{\Sigma xy - \Sigma x \Sigma y/n}{n-1} \quad (6.42)$$

where s_{xy} is called the covariance of x and y .

Therefore, we can also write for Equation 6.36

$$a = \frac{s_{xy}}{s_x^2} \quad (6.43)$$

Confidence Statements, Regression of y upon x

The sum of the squares of the deviations ($\Sigma \epsilon^2$) is minimum, but it can still be fairly large, indicating that the regression is not very successful. In an unsuccessful regression, the regression coefficient a is zero, meaning that variations of x do not explain the variation in y , and $\Sigma \epsilon^2 = \Sigma(y-\bar{y})^2 = \Sigma'y^2$ (compare with Equation 6.39). But if the coefficient a is different from zero, part of the y -variation is explained by regression, and the residual variation drops below the original variation: $\Sigma \epsilon^2 < \Sigma'y^2$. In other words, the residual deviations with regression are smaller than the deviations without regression. The smaller the non-explained variation $\Sigma \epsilon^2$ becomes, the more successful the regression is. The ratio $\Sigma \epsilon^2 / \Sigma'y^2$ equals $1-R^2$, in which R^2 is the coefficient of determination, which is a measure of the success of the regression.

In linear regression, the coefficient R equals the absolute value of the correlation coefficient r . In addition, $r^2 \Sigma'y^2$ equals the linearly explained variation and $(1-r^2) \Sigma'y^2$ is the residual variation, $\Sigma \epsilon^2$. The value of r can be calculated from

$$r = \frac{\Sigma'xy}{\sqrt{(\Sigma'x^2)(\Sigma'y^2)}} = \frac{s_{xy}}{s_x s_y} \quad (6.44)$$

This correlation coefficient is an indicator of the tendency of the y variable to increase (or decrease) with an increase in the x variable. The magnitude of the increase is given by the coefficient a . Both are related as

$$r = a \frac{s_x}{s_y} \quad (6.45)$$

The correlation coefficient r can assume values of between -1 and $+1$. If $r > 0$, the coefficient a is also positive. If $r = 1$ there is a perfect match of the regression line

with the (x, y) data. If $r < 0$, the coefficient a is also negative, and if $r = -1$, there is also a perfect match, although y increases as x decreases and vice versa. If $r = 0$, the coefficient a is also zero, the regression line is parallel to the x -axis, i.e. horizontal, and the y variable has no linear relation with x .

In non-linear relations, the r coefficient is not a useful instrument for judging a relation. The coefficient of determination $R^2 = 1 - \frac{\sum \varepsilon^2}{\sum y^2}$ is then much better (Figure 6.20).

Because the coefficient a was determined with data of a certain random variation, it is unlikely that its values will be the same if it is determined again with new sets of data. This means that the coefficient a is subject to variation and that its confidence interval will have to be determined. For this purpose, one can say that it is $c\%$ probable that the value of a in repeated experiments will be expected in the range delimited by

$$a_u = a + t s_a \quad (6.46)$$

$$a_v = a - t s_a \quad (6.47)$$

with

$$s_a^2 = \frac{\sum \varepsilon^2}{(n-2) \sum x^2} = \frac{(1-r^2) \sum y^2}{(n-2) \sum x^2} \quad (6.48)$$

where

a_u and a_v are the upper and lower confidence limits of a

t = a variable following Student's distribution, with $d = n - 2$ degrees of freedom (Table 6.9)

$f = 0.5(100-c)/100$ is the frequency with which the t value is exceeded (the uncertainty)

s_a = the standard error of the coefficient a

Theoretically, this statement is valid only if the ε deviations are normally distributed and independent of x . But for most practical purposes, the confidence interval thus determined gives a fair idea of the possible variation of the regression coefficient.

One can also say that, in repeated experiments, there is a $c\%$ probability that the y value found by regression (\hat{y} , Equation 6.43) for a given x value, will be in the range limited by

$$\hat{y}_u = \hat{y} + t s_{\hat{y}} \quad (6.49)$$

$$\hat{y}_v = \hat{y} - t s_{\hat{y}} \quad (6.50)$$

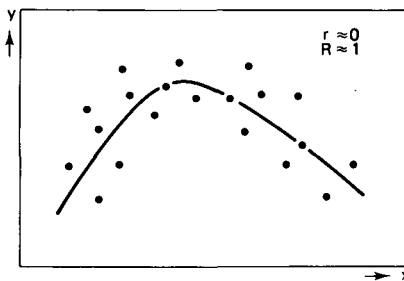

Figure 6.20 A clear relation between y and x , although $r \approx 0$

where \hat{y}_u and \hat{y}_v are the upper and lower confidence limits of \hat{y} , and s_y is the standard error of \hat{y} , equal to

$$s_y = \sqrt{s_y^2 + (x - \bar{x})^2 s_a^2} \quad (6.51)$$

Here, s_y is the standard error of \hat{y} , which is the value of \hat{y} at $x = \bar{x}$

$$s_y = \sqrt{\frac{\sum \varepsilon^2}{(n-2)n}} \quad (6.52)$$

By varying the x value, one obtains a series of \hat{y}_u and \hat{y}_v values, from which the confidence belt of the regression line can be constructed. Taking $x = 0$, one obtains the confidence limits of the regression constant b . In this case, the value of s_y^2 is often relatively small, and so Equation 6.51 can be simplified to

$$s_b = \bar{x} s_a \quad (6.53)$$

and the upper and lower confidence limits of b are

$$b_u = b + t s_b = b + t \bar{x} s_a \quad (6.54)$$

$$b_v = b - t s_b = b - t \bar{x} s_a \quad (6.55)$$

To calculate the confidence interval of a predicted y value from a certain x value one may use, in similarity to Equations 6.49, 6.50 and 6.51, $y_u = \hat{y} + t s_y$ and $y_v = \hat{y} - t s_y$ where $s_y = \sqrt{s_y^2 + (x - \bar{x})^2 s_a^2}$.

With a pocket calculator, it is relatively simple to compute a linear 2-variable regression analysis and the corresponding confidence statements because all the calculations can be done knowing only n , $\sum x$, $\sum y$, $\sum(xy)$, $\sum x^2$, $\sum y^2$. This is illustrated in the following example. Nowadays, personal computers are making regressions even easier, and general software packages like spreadsheets can be conveniently used.

Example 6.2 Regression y upon x

The data from Table 6.11 were used to do a linear regression of y upon x to determine the dependence of crop yield (y) on watertable depth (x): $y = ax + b$. The result is shown in Figure 6.21.

From the table, we see that the confidence limits of the regression coefficient ($a = 1.7$) are $a_u = 2.4$ and $a_v = 1.0$. Hence, although the coefficient is significant, its range is wide. Because $r^2 = 0.42$, we know that the regression explains 42% of the squared variations in y . As the regression equation (Equation 6.41), we get

$$(\hat{y} - 4.7) = a(x - 0.57)$$

With the calculated b , the regression result can also be written as

$$\hat{y} = a x + 3.73 \quad (n = 18, r = 0.65)$$

According to this, every 0.10 m that the watertable drops results in an average crop yield increase of 0.17 t/ha (using $a = 1.7$), with a maximum of 0.24 t/ha (using $a_u = 2.4$) and a minimum of 0.10 t/ha (using $a_v = 1.0$).

Table 6.11 (y, x) data used in Figure 6.21, with y = crop yield (t/ha) and x = seasonal average depth of the watertable (m)

no.	y	x	no.	y	x
1	4.0	0.15	14	4.0	0.50
2	4.5	0.20	15	4.5	0.60
3	3.0	0.20	16	6.0	0.65
4	4.0	0.25	17	4.5	0.65
5	3.7	0.25	18	5.7	0.70
6	3.5	0.32	19	5.0	0.70
7	5.0	0.40	20	5.3	0.75
8	4.5	0.40	21	5.5	0.90
9	4.5	0.40	22	4.7	0.90
10	4.8	0.45	23	5.0	0.91
11	4.5	0.45	24	4.5	1.00
12	5.5	0.47	25	5.7	1.05
13	5.2	0.50	26	5.5	1.08

$$\begin{aligned} \Sigma x &= 14.87 & \Sigma x^2 &= 10.47 & \Sigma xy &= 73.46 \\ \Sigma y &= 122.60 & \Sigma y^2 &= 591.68 & n &= 26 & n - 2 &= 24 \\ \bar{x} &= \Sigma x/n = 14.87/26 = 0.57 \\ \bar{y} &= \Sigma y/n = 122.60/26 = 4.7 \end{aligned}$$

$$\begin{aligned} \text{Equation 6.38: } \Sigma'x^2 &= 10.47 - (14.87)^2/26 = 1.97 \\ \text{Equation 6.39: } \Sigma'y^2 &= 591.68 - (122.60)^2/26 = 13.57 \\ \text{Equation 6.37: } \Sigma'xy &= 73.46 - 14.87 \times 122.60/26 = 3.34 \\ \text{Equation 6.36: } a &= 3.34/1.97 = 1.70 \\ \text{Equation 6.35: } b &= 4.7 - 1.70 \times 0.57 = 3.73 \\ \text{Equation 6.44: } r &= 3.34/\sqrt{1.97 \times 13.57} = 0.65 \rightarrow r^2 = 0.42 \\ \text{Equation 6.48: } \Sigma e^2 &= (1 - 0.42) 13.57 = 7.87 \\ \text{Equation 6.48: } s_a &= \sqrt{7.87/24} \times 1.97 = 0.41 \\ \text{Table 6.9: } f &= 0.05 \text{ and } d = 24 \rightarrow t_{90\%} = 1.71 \\ \text{Equation 6.46: } a_u &= 1.70 + 1.71 \times 0.41 = 2.4 \\ \text{Equation 6.47: } a_v &= 1.70 - 1.71 \times 0.41 = 1.0 \\ \text{Equation 6.53: } s_b &= 0.57 \times 0.41 = 0.23 \\ \text{Equation 6.54: } b_u &= 3.73 + 1.71 \times 0.23 = 4.1 \\ \text{Equation 6.55: } b_v &= 3.73 - 1.71 \times 0.23 = 3.3 \\ \text{Equation 6.52: } s_y &= \sqrt{7.87/24} \times 26 = 0.11 \\ \text{Equation 6.49: } \hat{y}_u &= 4.7 + 1.71 \times 0.11 = 4.9 \\ \text{Equation 6.50: } \hat{y}_v &= 4.7 - 1.71 \times 0.11 = 4.5 \end{aligned}$$

6.5.4 Linear Two-Way Regression

Linear two-way regression is based on a simultaneous regression of y upon x and of x upon y. It is used to estimate the parameters (regression coefficient a and intercept b) of linear relations between x and y, which do not have a causal relation.

Regression of y upon x yields a regression coefficient a. If the regression of x upon y yields a regression coefficient a', we get, analogous to Equation 6.34

$$(\hat{x} - \bar{x}) = a'(y - \bar{y}) \quad (6.56)$$

Normally, one would expect that $a' = 1/a$. With regression, however, this is only true if the correlation coefficient $r = 1$, because

$$a' \cdot a = r^2 \quad (6.57)$$

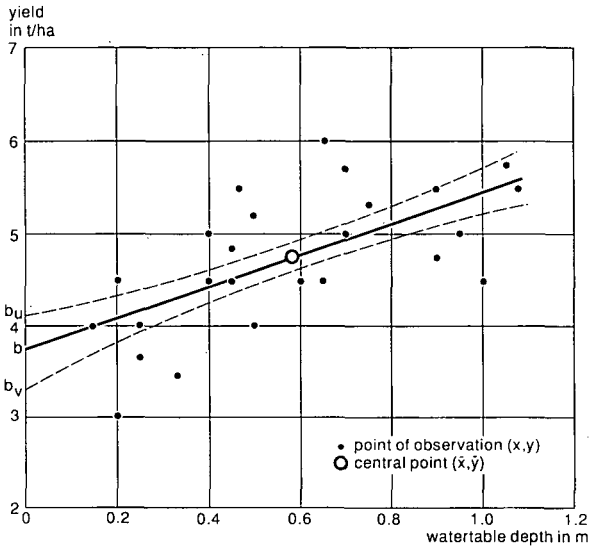

Figure 6.21 Linear regression of y upon x (Example 6.2)

The intermediate regression coefficient a^* becomes

$$a^* = \sqrt{\frac{a}{a'}} \quad (6.58)$$

which gives the geometric mean of the coefficients a and $1/a'$. The expression of the intermediate regression line then becomes

$$(y^* - \bar{y}) = a^*(x^* - \bar{x}) \quad (6.59)$$

or

$$y^* = a^*x^* + b^* \quad (6.60)$$

where

$$b^* = \bar{y} - a^*\bar{x} \quad (6.61)$$

The symbols y^* and x^* are used to indicate the y and x values on the intermediate regression line.

Because the intermediate regression coefficient a^* results from the regression of y upon x and of x upon y , one speaks here of a two-way regression.

The intermediate regression line is, approximately, the bisectrix of the angle formed by the regression lines of y upon x and of x upon y in the central point (\bar{x}, \bar{y}) .

Confidence Interval of the Coefficient a^*

In conformity with Equations 6.46 and 6.47, the confidence limits of the intermediate regression coefficient a^* are given by

$$a^*_u = a^* + t s_{a^*} \quad (6.62)$$

$$a^*_v = a^* - t s_{a^*} \quad (6.63)$$

where the standard error s_{a^*} of a^* is found from

$$s_{a^*} = a^* \frac{s_a}{a} = a^* \frac{s_{a'}}{a'} \quad (6.64)$$

This shows that the relative standard error s_{a^*}/a^* is considered equal to the relative standard error s_a/a or $s_{a'}/a'$. In general, the relative standard errors of all regression coefficients are equal

$$\frac{s_{a^*}}{a^*} = \frac{s_a}{a} = \frac{s_{a'}}{a'} = \frac{s_{1/a'}}{1/a'} = a' s_{1/a'}$$

Confidence Belt of the Intermediate Regression Line

The confidence belt of the intermediate regression line can be constructed from the confidence intervals of y^* or x^* . We shall limit ourselves here to the confidence intervals of y^* .

In conformity with, Equations 6.49, 6.50, and 6.51 we can write

$$y_u^* = y^* + t s_{y^*} \quad (6.65)$$

$$y_v^* = y^* - t s_{y^*} \quad (6.67)$$

where

$$s_{y^*} = \sqrt{s_y^2 + (x^* - \bar{x})^2 s_a^2} \quad (6.68)$$

And in conformity with Equations 6.53, 6.54, and 6.55 we get

$$s_{b^*} = \bar{x} s_{a^*} \quad (6.69)$$

$$b_u^* = b^* + t s_{b^*} \quad (6.70)$$

$$b_v^* = b^* - t s_{b^*} \quad (6.71)$$

An example of how to use these equations follows.

Example 6.3 Two-Way Regression

Let us assume that we wish to determine the hydraulic conductivity of a soil with two different layers. We have observations on drain discharge (q) and hydraulic head (h), and we know that q/h and h are linearly related: $q/h = a^*h + b^*$. The hydraulic conductivity can be determined from the parameters a^* and b^* (Chapter 12), whose values can be found from a two-way regression.

In Table 6.12 one finds the two-way regression calculations, made according to the equations above, in which h replaces x and $z = q/h$ replaces y . Although the values of both a^* and b^* are significantly different from zero, we can see that they are not very accurate. This is owing partly to the high scatter of the data and partly to their limited number (Figure 6.22).

Figure 6.22 shows the confidence intervals of the regression line, which are based on the confidence intervals of b^* , and a^* that were calculated in Table 6.12. Despite the fairly high correlation coefficient ($r = 0.83$), the confidence intervals are quite wide. This problem can be reduced if we increase the number of observations.

Table 6.12 Values of the hydraulic head (h), the discharge (q), and their ratio (z = q/h) in a drainage experimental field

Observation number	q (m/d)	h (m)	z = q/h (d ⁻¹)
1	0.0009	0.17	0.0053
2	0.0011	0.19	0.0058
3	0.0022	0.28	0.0079
4	0.0020	0.30	0.0066
5	0.0034	0.40	0.0085
6	0.0032	0.40	0.0080
7	0.0031	0.42	0.0074
8	0.0035	0.45	0.0078
9	0.0044	0.48	0.0092
10	0.0042	0.51	0.0082
11	0.0057	0.66	0.0086

$$\begin{aligned} \Sigma h &= 4.26 & \Sigma z &= 0.0833 & n &= 11 \\ \bar{h} &= \Sigma h/n = 0.387 & \bar{z} &= \Sigma z/n = 0.00757 \\ \Sigma h^2 &= 1.86 & \Sigma z^2 &= 0.000645 & \Sigma zh &= 0.0337 \\ \text{Equations 6.37, 6.38 and 6.39:} \\ \Sigma' h^2 &= 0.209 & \Sigma' z^2 &= 0.0000145 & \Sigma' zh &= 0.00144 \end{aligned}$$

$$\begin{aligned} \text{Equation 6.36: } a &= 0.00144/0.209 = 0.0069 \\ \text{Equation 6.44: } r &= 0.00144/\sqrt{(0.209 \times 0.0000145)} = 0.83 \\ & r^2 = 0.83^2 = 0.69 \\ \text{Equation 6.51: } a' &= 0.69/0.0069 = 100 \\ \text{Equation 6.53: } a^* &= \sqrt{(0.0069 \times 0.0100)} = 0.0083 \\ \text{Equation 6.48: } \Sigma \epsilon^2 &= (1-0.69) \times 0.0000145 = 0.00000450 \\ \text{Equation 6.48: } s_a &= \sqrt{0.00000450/(11-2) \times 0.209} = 0.00155 \\ \text{Equation 6.64: } s_{a^*} &= 0.0083 \times 0.00155/0.0069 = 0.0019 \\ \text{Table 6.9: } d &= 9; f = 0.05; t_f = 1.83 \\ \text{Equation 6.57: } a_u^* &= 0.0083 + 1.83 \times 0.00186 = 0.0117 \\ \text{Equation 6.58: } a_v^* &= 0.0083 - 1.83 \times 0.00186 = 0.0049 \\ \text{Equation 6.59: } b^* &= 0.00757 - 0.0083 \times 0.387 = 0.0044 \\ \text{Equation 6.69: } s_{b^*} &= 0.387 \times 0.0019 = 0.00074 \\ \text{Equation 6.70: } b_u^* &= 0.0044 + 1.83 \times 0.00074 = 0.0058 \\ \text{Equation 6.71: } b_v^* &= 0.0044 - 1.83 \times 0.00074 = 0.0030 \end{aligned}$$

6.5.5 Segmented Linear Regression

In agriculture, crops will often react to a production factor x within a certain range of x, but not outside this range. One might consider using curvilinear regression to calculate the relation between crop yield (y) and x, but the linear regression theory, in the form of segmented linear regression, can also be used to calculate the relation.

Segmented linear regression applies linear regression to (x,y) data that do not have a linear relation. It introduces one or more breakpoints, whereupon separate linear regressions are made for the resulting segments. Thus, the non-linear relation is

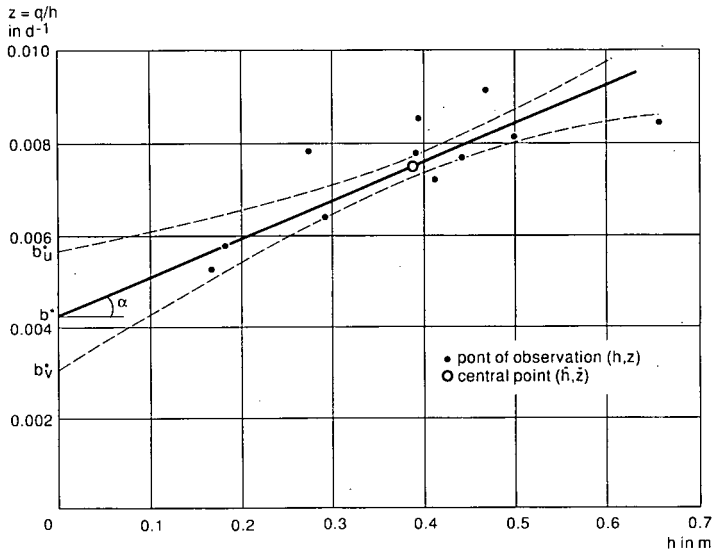

Figure 6.22 Two-way regression with the data of Table 6.12

approximated by linear segments. Nijland and El Guindy (1986) used it to calculate a multi-variate regression. A critical element is the locating of the breakpoint. Oosterbaan et al. (1990) have presented a method for calculating confidence intervals of the breakpoints so that the breakpoint with the smallest interval i.e. the optimum breakpoint, can be selected.

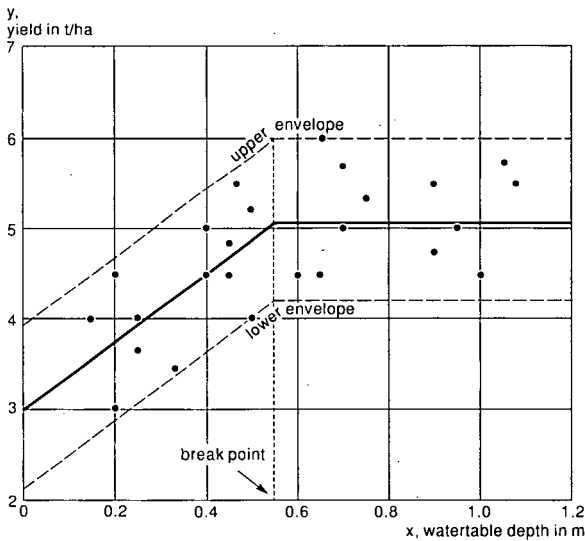

Figure 6.23 Segmented linear regression with the same data as in Figure 6.21

Example 6.4 Segmented Linear Regression with one Breakpoint

Segmented linearization (or broken-line regression) will be illustrated with the data from Figure 6.21 as shown again in Figure 6.23. In this example the optimum breakpoint was at $x = 0.55$ m. The subsequent calculations are presented in Table 6.13.

Discussion

The total $\Sigma\epsilon^2 = 3.57 + 3.06 = 6.63$ in Table 6.13 is lower than the $\Sigma\epsilon^2 = 7.87$ of Example 6.2, which represents the linear regression using all the data without a breakpoint. This means that the segmented regression gives a better explanation of

Table 6.13 Segmented linear regression calculations with the data of Table 6.11

1) Segment with $x < 0.55$ m

$$\begin{aligned} \Sigma x &= 4.94 & \Sigma y &= 60.7 & n &= 14 \\ \bar{x} &= \Sigma x/n = 0.35 \text{ m} & \bar{y} &= \Sigma y/n = 4.3 \text{ t/ha} \\ \Sigma x^2 &= 1.94 & \Sigma y^2 &= 269.26 & \Sigma xy &= 22.12 \end{aligned}$$

Equations 6.38, 6.39 and 6.37 give

$$\Sigma'x^2 = 0.19 \quad \Sigma'y^2 = 6.09 \quad \Sigma'xy = 0.70$$

$$\begin{aligned} \text{Equation 6.36: } a &= 3.62 \\ \text{Equation 6.35: } b &= 3.06 \\ \text{Equation 6.44: } r^2 &= 0.41 \\ \text{Table 6.10: } f &= 0.05 \text{ and } d = 12 \rightarrow t_{90\%} = 1.78 \\ \text{Equation 6.48: } \Sigma\epsilon^2 &= 3.57 \\ \text{Equation 6.46: } a_u &= 5.83 \\ \text{Equation 6.47: } a_v &= 1.40 \\ \text{Equation 6.49: } x &= \hat{y}_u = 4.6 \text{ t/ha} \\ \text{Equation 6.50: } \hat{y}_v &= 4.0 \text{ t/ha} \end{aligned}$$

2) Segment with $x > 0.55$ m

$$\begin{aligned} \Sigma x &= 9.93 & \Sigma y &= 61.9 & n &= 12 \\ \bar{x} &= \Sigma x/n = 0.83 \text{ m} & \bar{y} &= \Sigma y/n = 5.2 \text{ t/ha} \\ \Sigma x^2 &= 8.54 & \Sigma y^2 &= 322.41 & \Sigma xy &= 51.35 \end{aligned}$$

Equations 6.38, 6.39 and 6.37 give

$$\Sigma'x^2 = 0.32 \quad \Sigma'y^2 = 3.11 \quad \Sigma'xy = 0.12$$

$$\begin{aligned} \text{Equation 6.36: } a &= 0.38 \\ \text{Equation 6.35: } b &= 4.84 \\ \text{Equation 6.44: } r^2 &= 0.02 \\ \text{Table 6.10: } f &= 0.05 \text{ and } d = 10 \rightarrow t_{90\%} = 1.81 \\ \text{Equation 6.48: } \Sigma\epsilon^2 &= 3.06 \\ \text{Equation 6.46: } a_u &= 2.15 \\ \text{Equation 6.47: } a_v &= -1.38 \\ \text{Equation 6.49: } x &= \hat{y}_u = 5.5 \text{ t/ha} \\ \text{Equation 6.50: } \hat{y}_v &= 4.9 \text{ t/ha} \end{aligned}$$

the effect of watertable depth on crop yield than does the unsegmented regression. One can test whether this improvement is significant at a certain confidence level by comparing the reduction in Σe^2 with the residual variation after segmented linear regression. One then checks the variance ratio using an F-test, a procedure that is not discussed here. In this example, the improvement is not statistically significant. This difficulty could be obviated, however, by the collection of more data.

The regression coefficient ($a = 0.38$) for the data with $x > 0.55$ is very small and insignificant at the 90% confidence level because $a_v < 0 < a_u$, meaning that no influence of x upon y can be established for that segment.

On the other hand, the regression coefficient ($a = 3.62$) for the data with $x < 0.55$ is significant at the chosen confidence. Hence, the yield (y) is significantly affected by watertables (x) shallower than 0.55 m.

In accordance with Equation 6.31, the regression equations become

$$\hat{y} = \bar{y} = 5.2 \quad [x > 0.55 \text{ m}]$$

$$\hat{y} = 3.62(x-0.35) + 4.3 = 3.62x + 3.1 \quad [x < 0.55 \text{ m}]$$

The intersection point of the two lines need not coincide exactly with the breakpoint; but when the segmented regression is significant, the difference is almost negligible.

Using n_v = number of data with $x < 0.55$ and n_t = total number of data, and assuming that the points in Figure 6.23 represent fields in a planned drainage area, one could say that $n_v/n_t = 14/26 = 54\%$ of the fields would benefit from drainage to bring the watertable depth x to a value of at least 0.55 m, and that 46% would not. An indication of the average yield increase for the project area could be obtained as follows, with \bar{x} being the average watertable depth in the segment $x < 0.55$

$$\Delta y = a(0.55 - \bar{x})n_v/n_t = 3.62(0.55 - 0.35)0.54 = 0.4 \text{ t/ha}$$

with confidence limits $\Delta y_u = 0.6$ and $\Delta y_v = 0.2$, which are calculated with $a_u = 5.83$ and $a_v = 1.40$ instead of $a = 3.62$. From Example 6.2, we know that the average current yield is $y = 4.7$ t/ha. Accordingly, we have a relative yield increase of $0.4/4.7 = 9\%$, with 90% confidence limits of $0.6/4.7 = 13\%$ and $0.2/4.7 = 4\%$.

6.6 Screening of Time Series

6.6.1 Time Stability versus Time Trend

Dahmen and Hall (1990) discuss various established methods of statistical analysis to detect the presence of a significant time trend in time series of hydrologic data. One of the methods they describe involves tests for the time stability of the mean of the data. Time stability can be tested in three ways. These are:

- Spearman's rank correlation method;
- Student's t-test for the means of data in consecutive periods;
- Segmented linear regression of the cumulative data and time (mass curve analysis) or of the cumulative data from two measuring stations (double-mass curve analysis).

In this chapter, we discuss only Student's t-test of the means.

In Figure 6.24, we see a time series of annual maximum water levels of the Chao Phraya river at Bang Sai, Thailand, from 1967 to 1986. The figure suggests that the water levels are, on average, somewhat lower after 1977. The difference in the levels for the two different periods (1967-1977 and 1978-1986) is analyzed in Table 6.14.

The difference $\Delta = \bar{h}_1 - \bar{h}_2 = 0.69$, from Table 6.14, has a standard error s_Δ that can be found from

$$s_\Delta = \sqrt{(s_{h1}^2 + s_{h2}^2)}$$

Hence, it follows that $s_\Delta = 0.22$ m.

From Equations 6.46 and 6.47, we know that to calculate the upper (Δ_u) and lower (Δ_v) confidence limits of Δ , we use

$$\Delta_u = \Delta + ts_\Delta \text{ and } \Delta_v = \Delta - ts_\Delta$$

For the 90% confidence interval, Table 6.9 gives, $t = 1.83$, with $f = 0.05$ and $d = n - 1 = 10 - 1 = 9$. Thus $\Delta_u = 1.09$ and $\Delta_v = 0.28$.

Because both Δ_u and Δ_v are positive, the difference in water levels before and after 1976 is significant. In fact, the difference is the result of the construction of a storage reservoir and electric power station in a tributary of the Chao Phraya river. This should be taken into account if one uses the data of all 20 years to make a frequency analysis. Due to construction and operation of the reservoir, the return period of a certain high water level is underestimated and the water level for a certain return period is overestimated.

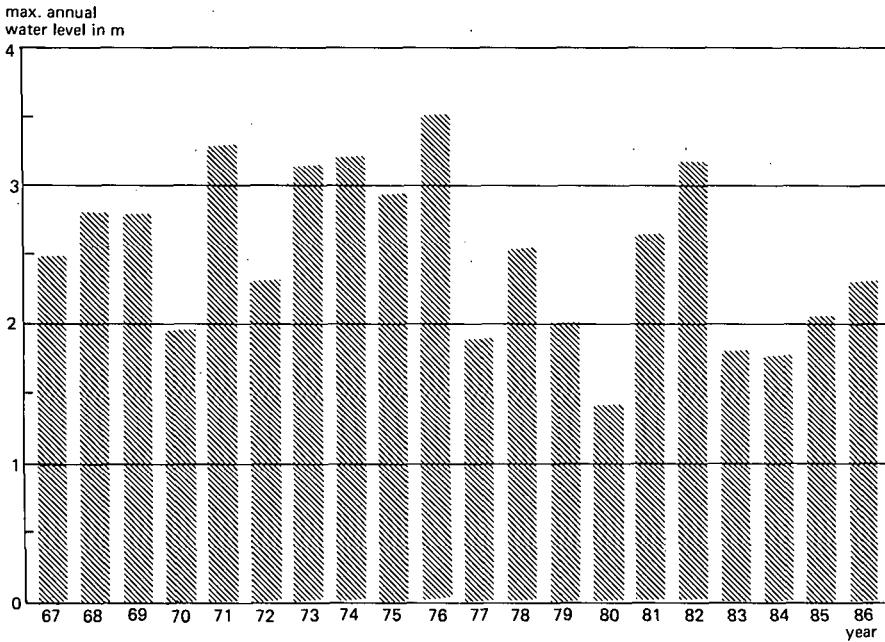

Figure 6.24 Time series of annual maximum water levels of the Chao Phraya river at Bang Sai, Thailand

Table 6.14 Regression analysis of the water levels (m) used in Figure 6.24 to test the difference of the decade means

First decade		Second decade	
Year	Maximum annual water level (h_1)	Year	Maximum annual water level (h_2)
1967	2.49	1977	1.88
1968	2.80	1978	2.54
1969	2.78	1979	1.98
1970	1.95	1980	1.42
1971	3.29	1981	2.63
1972	2.30	1982	3.16
1973	3.14	1983	1.78
1974	3.20	1984	1.76
1975	2.92	1985	2.04
1976	3.51	1986	2.31

n	$= 10$	n	$= 10$
Σh_1	$= 28.38$	Σh_2	$= 21.50$
h_1	$= 2.84$	h_2	$= 2.15$ (Equation 6.12)
Σh_1^2	$= 82.63$	Σh_2^2	$= 48.59$
s_{h1}	$= 0.48$	s_{h2}	$= 0.51$ (Equation 6.13)
$s_{\bar{h}1}$	$= 0.15$	$s_{\bar{h}2}$	$= 0.16$ (Equation 6.20)

6.6.2 Periodicity of Time Series

The periodicity, i.e. the periodic fluctuations, of time series can be tested with the serial correlation coefficient, but only after proving that there is no definite time trend. The serial correlation coefficient (r_s) is defined as

$$r_s = \frac{\Sigma(x_i x_{i+1})}{\Sigma x_i^2}$$

where x_i is the observation at time i and x_{i+1} is the observation at time $i + 1$. This is comparable to Equation 6.44. So if r_s is significant, and a time trend is absent, then one can conclude that there must be a periodicity.

6.6.3 Extrapolation of Time Series

A time series of data from one measuring station can be extended with the help of a series from another station if both series overlap and if there is a good relation between them during the period of overlap. The relation can be determined by the ratio method, by the linear regression method, and by any non-linear regression method, depending on the characteristics of the data.

If the regression shows a significant relation, extrapolation of the shorter data record makes it possible to increase the reliability of frequency predictions. Nevertheless, much depends on the reliability of the ratio or the regression coefficient.

6.6.4 Missing and Incorrect Data

When certain data in a time series are missing or are undoubtedly incorrect, one sometimes tries to fill the gaps by interpolation or by inserting average values. Or one tries to fill in the missing data or to change the incorrect data, using the relation with another, complete, set of data. Although there is, in principle, no objection to such practices, it must be stressed that the supplementary data should not be used in an analysis of confidence or in tests of statistical significance, the reason being that they are not independent. They enlarge correlations (this is called spurious correlation) and lead to statistical bias. Therefore, it is necessary to clearly earmark supplementary data and to omit them from the statistical tests.

The decision to declare certain data with exceptionally large deviations as incorrect must be taken very carefully, because there are always correct data that, due to random variation, deviate strongly from their expected value. If, based on certain non-statistical criteria, it has been decided that some data should be eliminated, it will be necessary to check all data against the same criteria, because there may be seemingly normal data whose values have evolved under the same conditions implied in the criteria of rejection.

For example, if one decides to exclude certain extremely high or low crop yields from a data series on the grounds of specific soil conditions, then all the non-exceptional yields that have been realized under the same soil conditions will have to be eliminated as well. Otherwise, the conclusions drawn from the data series will be incorrect. The remaining data can be analyzed statistically, but it should be stipulated for which conditions the conclusions are valid. For the crop yield data, this means that the conclusion is not valid for the excluded soil conditions.

References

- Benson, M.A. 1960. Characteristics of frequency curves based on a theoretical 1000 year record. In: T. Dalrymple (ed.), Flood frequency analysis. U.S. Geological Survey Water Supply Paper, 1543-A, pp. 51-71
- Dahmen, E.R. and M.J. Hall 1990. Screening of hydrologic data : tests for stationarity and relative consistency. ILRI Publication No. 49, Wageningen, 60 p.
- Gumbel, E.J. 1954. Statistical theory of extreme values and some practical applications. Applied mathematics series 33. U.S. Dep. of Commerce, National Bureau of Standards, Wageningen, 51 p.
- Nijland, H.J. and S. El Guindy 1986. Crop production and topsoil/ surface-water salinity in farmer's rice-fields, the Nile Delta. In: Smith, K.V.H. and D.W. Rycroft (eds.), Hydraulic Design in Water Resources Engineering: Land Drainage. Proceedings of the 2nd International Conference, Southampton University. Springer Verlag, Berlin. pp. 75-84.
- Oosterbaan, R.J. 1988. Frequency predictions and their binomial confidence limits. In: Economic Aspects of flood control and non-structural measures, Proceedings of the Special Technical Session of the International Commission on Irrigation and Drainage (ICID), Dubrovnik, pp. 149-160.
- Oosterbaan R.J., D.P. Sharma and K.N. Singh 1990. Crop production and soil salinity: Evaluation of field data from India by segmented linear regression. Symposium on Land Drainage for Salinity Control in Arid and Semi-Arid Regions, Vol. 3, Cairo, pp. 373-382.
- Snedecor, G.W. and W.G Cochran 1986. Statistical methods. Iowa State University Press. 8th ed., 593 p.

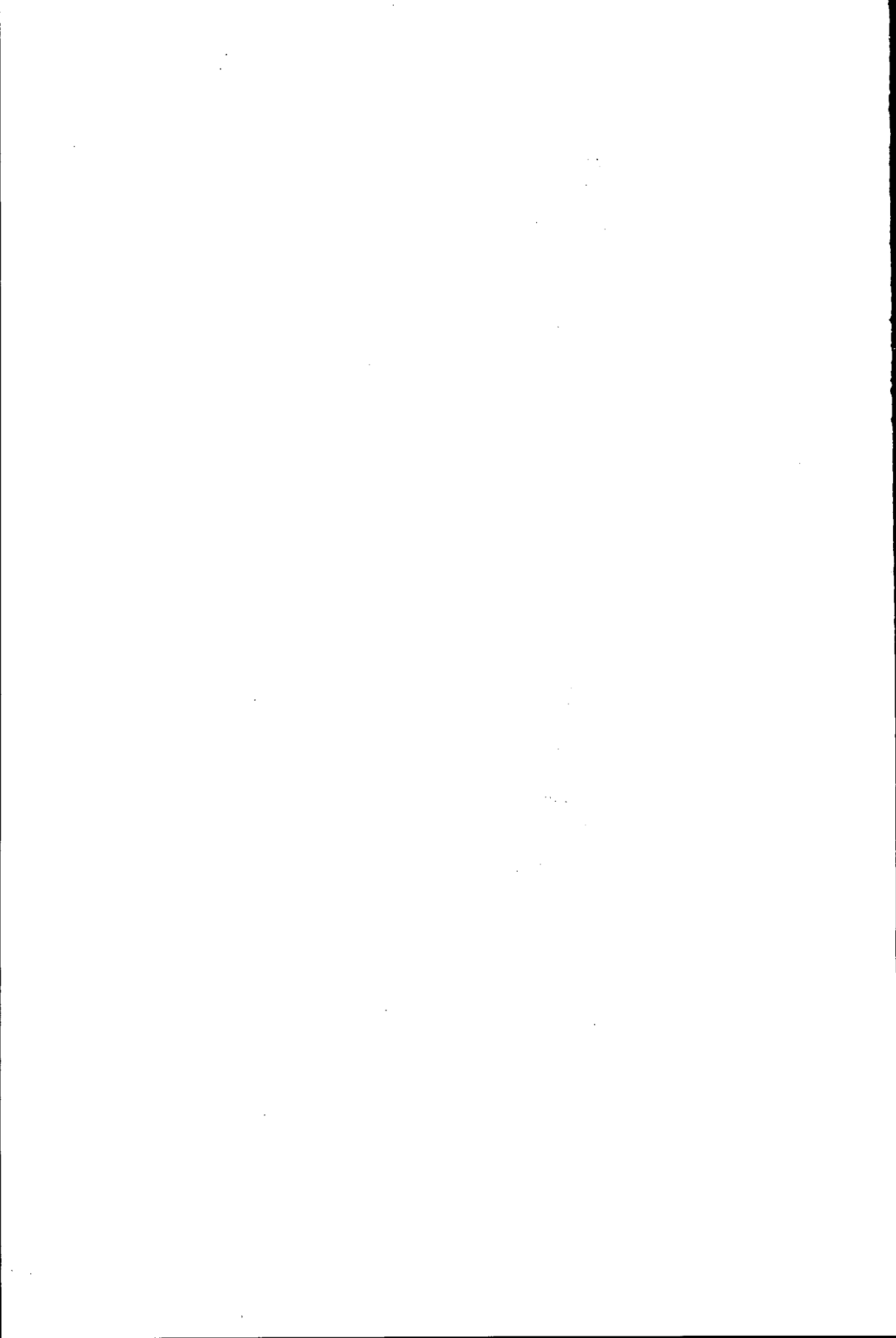

7 Basics of Groundwater Flow

M.G. Bos¹

7.1 Introduction

In drainage studies, we are interested not only in the depth at which the watertable is found and in its rise and fall, but also in the flow of groundwater and the rate at which it flows. The terms groundwater and watertable are defined in Section 7.2. In Section 7.3, because we are dealing with groundwater as a fluid, we present some of its physical properties and the basic laws related to its movement. This movement is governed by well-known principles of hydrodynamics which, in fact, are nothing more than a reformulation of the corresponding principles of mechanics. On the basis of these principles, we shall formulate the equation of continuity and the equations of groundwater movement. We give special attention to Darcy's equation in Section 7.4, to some of its applications in Section 7.5, and to the theory of streamlines and equipotential lines in Section 7.6.

The equations for flow and continuity are partial differential equations which can only be solved if we know the boundaries of the flow regions. These boundaries or 'boundary conditions' are discussed in Section 7.7. Further, to solve groundwater-flow patterns bounded by a free watertable (known as an unconfined aquifer, Chapter 2), we have to make additional assumptions to simplify the flow pattern. The Dupuit-Forchheimer theory, which deals with these assumptions, gives good solutions to problems of flow to parallel drains and pumped wells (Section 7.8). Finally, as an example of an approximate method to solve the partial differential equations, Section 7.9 presents the relaxation method.

It should be noted that the equations in this chapter are not intended for direct use in drainage design, but are expanded upon in subsequent chapters on Subsurface Flow to Drains (Chapter 8), Seepage and Groundwater Flow (Chapter 9), and Single-well and Aquifer Tests (Chapter 10).

7.2 Groundwater and Watertable Defined

The term 'groundwater' refers to the body of water found in soil whose pores are saturated with water. The locus of points in the groundwater where water pressure is equal to atmospheric pressure defines the 'watertable', which is also called the free water surface or the phreatic surface (Figure 7.1). The watertable can be found by measuring the water level in an open borehole that penetrates the saturated zone. Pressure is usually expressed as relative pressure, p , with reference to atmospheric pressure, p_{atm} . At the watertable, by definition, $p = p_{\text{atm}}$.

The groundwater body actually extends slightly above the watertable owing to capillary action, but the water is held there at less than atmospheric pressure. The zone where capillary water fills nearly all of the soil's pores is called the capillary

¹ International Institute for Land Reclamation and Improvement

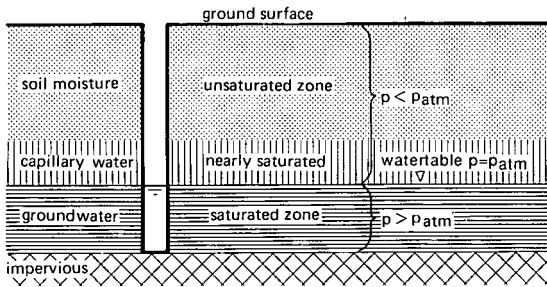

Figure 7.1 Schema of the occurrence of subsurface water

fringe. Although it occurs above the watertable, the capillary fringe is sometimes included in the groundwater body. The capillary water occurring above the capillary fringe belongs to the unsaturated zone, or zone of aeration, where the soil's pores are filled partly with water and partly with air (Chapter 11).

7.3 Physical Properties, Basic Laws

7.3.1 Mass Density of Water

The density of a material is defined as the mass per unit of volume. Mass density may vary with pressure, temperature, and the concentration of dissolved particles. Temperature, for example, causes the mass density of water to vary as follows (see also Table 7.1)

$$\rho = 1000 - \frac{(T - 4)^2}{150} \quad (7.1)$$

where

ρ = density of water (kg/m³)
 T = water temperature (°C)

Table 7.1 Variation in mass density and viscosity of water with temperature

Temperature (°C)	Mass density (kg/m ³)	Dynamic viscosity (kg/m s)	Kinematic viscosity (m ² /s)
0	999.87	1.79×10^{-3}	1.79×10^{-6}
5	999.99	1.52×10^{-3}	1.52×10^{-6}
10	999.73	1.31×10^{-3}	1.31×10^{-6}
15	999.13	1.14×10^{-3}	1.14×10^{-6}
20	998.23	1.01×10^{-3}	1.007×10^{-6}
25	997.07	0.89×10^{-3}	0.897×10^{-6}
30	995.67	0.80×10^{-3}	0.804×10^{-6}
40	992.24	0.65×10^{-3}	0.661×10^{-6}

Because mass density varies with temperature, water of 15°C will not mix spontaneously with water of 20°C, and there will be even less mixing between fresh water and sea water. Because of its salt content, the mass density of sea water is about $\rho_s = 1027 \text{ kg/m}^3$. This variation in mass density must, of course, be taken into account when hydraulic heads are being measured.

7.3.2 Viscosity of Water

In a moving fluid, a fast-moving layer tends to drag a more slowly-moving layer along with it; the slower layer, however, tends to hold back the faster one. Because layers of fluid flow at different velocities, the fluid body opposed by an internal stress will be deformed. The internal stress that causes the deformation of the fluid during flow is called viscosity. Basically, viscosity is the relation between the shear stress acting along any plane between neighbouring fluid elements, and the rate of deformation of the velocity gradient perpendicular to this plane. Thus, if the fluid element A, shown in Figure 7.2, travels at an average velocity, v , in the x -direction, it will be deformed at an angular rate equal to dv/dy . According to Newton, the shear, τ , along plane a - a will then be

$$\tau = \eta \frac{dv}{dy} \quad (7.2)$$

where

τ = shear stress (Pa)

η = the dynamic viscosity of the fluid (kg/m s)

Kinematic viscosity is defined by the relation

$$\nu = \frac{\eta}{\rho} \quad (7.3)$$

where

ν = kinematic viscosity (m^2/s)

Table 7.1 gives the variation in viscosity with temperature.

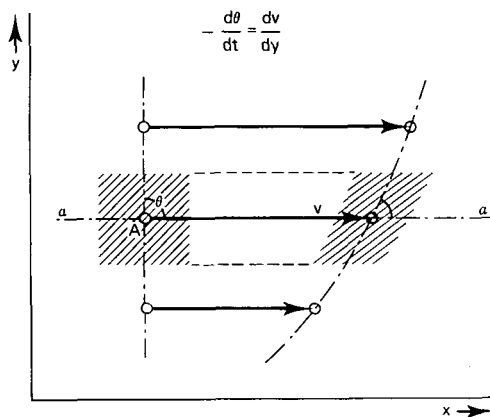

Figure 7.2 Angular deformation of a fluid element (Rouse 1964)

7.3.3 Law of Conservation of Mass

A fundamental law of hydrodynamics is the law of conservation of mass, which states that, in a closed system, fluid mass can be neither created nor destroyed. In other words, a space element, dx, dy, dz , in which the fluid and the flow medium are both incompressible, will conserve its mass over a time, dt . Therefore, the fluid must enter the space element at the same rate (volume per unit time) as it leaves. The rate at which a given volume is transferred across a section equals the product of the velocity component perpendicular to the section and the area of the section.

If the velocity distribution over the flow profile is non-linear, we may assume a linear velocity distribution over the elementary distances, dx, dy , and dz . Hence, we can write the average velocity components perpendicular to the lateral faces of the space element as indicated in Figure 7.3.

The difference between the volume of water leaving the space element and the volume of water entering it in the x -direction over time, dt , equals

$$(v_x + \frac{\delta v_x}{\delta x} dx) dy dz dt - v_x dy dz dt \tag{7.4}$$

or

$$\frac{\delta v_x}{\delta x} dx dy dz dt \tag{7.5}$$

Analogous expressions can be derived for the y - and z -directions

$$\frac{\delta v_y}{\delta y} dy dx dz dt \tag{7.6}$$

and

$$\frac{\delta v_z}{\delta z} dz dx dy dt \tag{7.7}$$

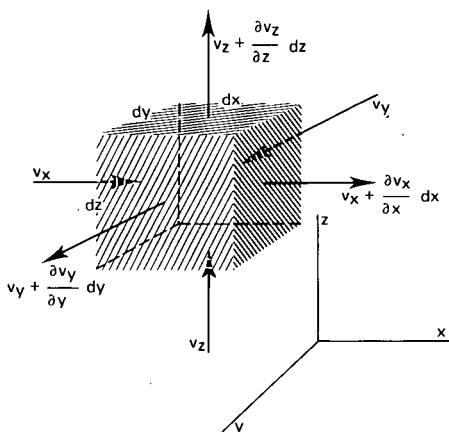

Figure 7.3 Velocity distribution in a fluid space element

According to the law of conservation of mass, the total difference between the volume transferred into the space element and that transferred out of it must equal zero. Hence

$$\frac{\delta v_x}{\delta x} dx dy dz dt + \frac{\delta v_y}{\delta y} dy dx dz dt + \frac{\delta v_z}{\delta z} dz dx dy dt = 0 \quad (7.8)$$

For flow independent of time, ($\partial v/\partial t = 0$), this equation reduces to

$$\frac{\delta v_x}{\delta x} + \frac{\delta v_y}{\delta y} + \frac{\delta v_z}{\delta z} = 0 \quad (7.9)$$

which is a general form of the continuity equation.

In fluid mechanics, it is common practice to select a coordinate system whose x-direction coincides with the direction of the flow vector at a given point. In other words, the x-direction is parallel to the tangent of the path line at that point. Consequently, $v_x = v$, $v_y = 0$, and $v_z = 0$. Because, in these circumstances, there is a transfer of volume in the x-direction only, the difference between the volume of water transferred into and out of the space element, over time, dt, must equal zero. Hence

$$(v_x + \frac{dv_x}{dx} dx) dy dz dt - v_x dy dz dt = 0 \quad (7.10)$$

and because $dA = dy dz$

$$v_{(x+dx)} dA - v_x dA = 0$$

or

$$(vdA)_{(x+dx)} = (vdA)_x = dQ \quad (7.11)$$

Thus, the rate of flow, dQ , is a constant through two elementary cross-sections at an infinitely short distance from each other. In fact, we considered an elementary part of a stream tube, bounded by streamlines, lying on the dx-dy and dx-dz planes.

If we now consider a finite area of flow, A , we can write the continuity equation as

$$Q = \int_A v dA = \bar{v} A \quad (7.12)$$

where \bar{v} is the average velocity component perpendicular to the cross-sectional area of flow.

7.3.4 The Energy of Water

Although heat and noise are types of energy that can influence the flow of water, let us assume for our purposes that they exert no energy. An elementary fluid particle then has three interchangeable types of energy per unit of volume

$$\begin{aligned} \rho v^2/2 &= \text{kinetic energy per unit of volume (Pa)} \\ \rho g z &= \text{potential energy per unit of volume (Pa)} \\ p &= \text{pressure energy per unit of volume (Pa)} \end{aligned}$$

Let us assume that a fluid particle is moving in a time interval, Δt , over a short distance (from Point 1 to Point 2) along a streamline, and is not losing energy through friction or turbulence. Because, on the other hand, the fluid particle is not gaining energy either, we can write

$$\left(\frac{\rho v^2}{2} + \rho g z + p\right)_1 = \left(\frac{\rho v^2}{2} + \rho g z + p\right)_2 = \text{constant} \quad (7.13)$$

This equation is valid for points along a streamline only if the energy losses are negligible and the mass density, ρ , is a constant. According to Equation 7.13

$$\frac{\rho v^2}{2} + \rho g z + p = \text{constant} \quad (7.14)$$

or

$$\frac{v^2}{2g} + \frac{p}{\rho g} + z = H = \text{constant} \quad (7.15)$$

where, as shown in Figure 7.4

$v^2/2g$ = the velocity head (m)

$p/\rho g$ = the pressure head (m)

z = the elevation head (m)

$p/\rho g + z$ = the piezometric head (or potential or hydraulic head) or the water level in the stilling well (m)

H = the total energy head (m)

The latter three heads all refer to the same reference level. The reader should note that each streamline may have its own energy head.

Equations 7.13, 7.14, and 7.15 are alternative forms of the well-known Bernoulli equation.

It is stressed again that these equations are only valid:

- When a fluid particle is moving along a streamline under steady-flow conditions;

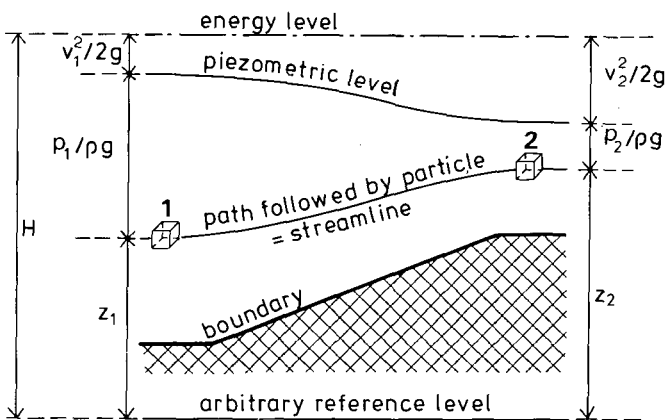

Figure 7.4 The energy of a fluid particle (Bos 1989)

- When the energy losses are negligible;
- When the mass density of the fluid, ρ , is a constant.

Because, in nature, velocities of groundwater flow, v , are usually low, the kinetic energy in Equation 7.15 can be disregarded without any appreciable error. Hence, Equation 7.15 reduces to

$$\frac{p}{\rho g} + z = h \quad (7.16)$$

The physical meaning of Equation 7.16 is illustrated in Figure 7.5. Using Equation 7.16, we can measure the piezometric head at various points in the groundwater body. Subsequently, we can determine the hydraulic gradient and the direction of groundwater flow.

Pressure is usually expressed as relative pressure, p , with reference to atmospheric pressure, p_{atm} . Thus, in this context, p_{atm} equals zero pressure. Mean sea level is sometimes used as a reference level in measuring elevation.

7.3.5 Fresh-Water Head of Saline Groundwater

If heads are measured in piezometers installed in a deep layer containing groundwater of different salt concentrations, these heads should, as a rule, be converted into fresh-water heads so that the true hydraulic gradient can be determined. Expressing the fresh-water head, h_f , as (see Figure 7.6)

$$h_f = z + \frac{p}{\rho_f g}$$

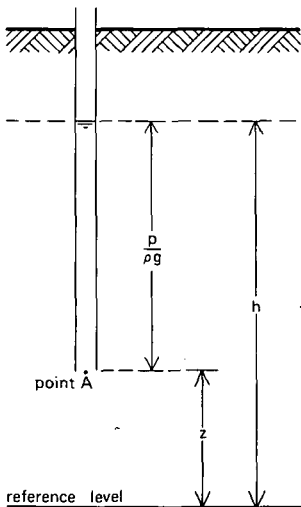

Figure 7.5 Piezometric or hydraulic head, h , at a point A, located at a height z above a reference level

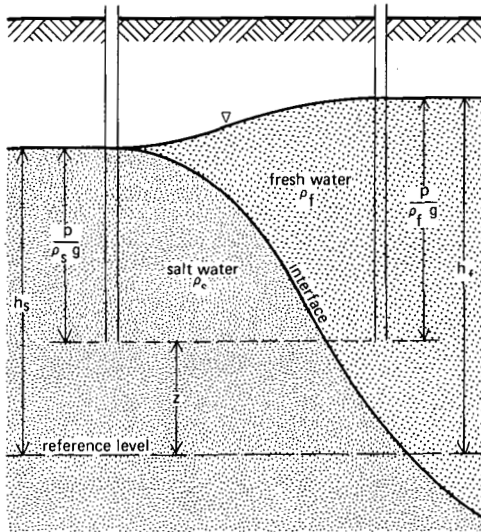

Figure 7.6 Hydraulic heads in bodies of fresh water and salt water

and the saltwater head, h_s , as

$$h_s = z + \frac{p}{\rho_s g}$$

Where ρ_f is the mass density of fresh water and ρ_s is the mass density of salt water, we obtain, after eliminating p/g ,

$$h_r = \frac{h_s \rho_s}{\rho_f} - z \frac{\rho_s - \rho_f}{\rho_f} \quad (7.17)$$

If the reference level coincides with the bottom of the piezometer, i.e. if $z = 0$, the corresponding fresh-water head can be expressed as

$$h_r = h_s \frac{\rho_s}{\rho_f} \quad (7.18)$$

If, for example, the hydraulic head in salt water is 30 m above the reference level that is assumed to coincide with the bottom of the piezometer, and the mass density of the groundwater is 1025 kg/m^3 , then the length of a column of fresh water of the same weight is

$$h_r = 30 \frac{1025}{1000} = 30.75 \text{ m}$$

7.4 Darcy's Equation

7.4.1 General Formulation

The fundamental equation describing the flow of groundwater through soil was

derived by Darcy (1856). He performed his experiments using an instrument like the one shown in Figure 7.7.

Darcy observed that the volume of water flowing through a sand column per unit of time was proportional to the column's cross-sectional area and its difference in head ($h_1 - h_2 = \Delta h$), and inversely proportional to the length of the sand column. This relation can be written as

$$Q = K \frac{\Delta h}{L} A \quad (7.19)$$

where

- Q = the rate of flow through the column (m^3/s)
- Δh = the head loss (m)
- L = the length of the column (m)
- A = the cross-sectional area of the column (m^2)
- K = a proportionality coefficient, called hydraulic conductivity (m/s)

In this context, it should be noted that $Q/A = v$ is not the actual velocity at which a particle of water flows through the pores of the soil. It is a fictitious velocity that is better referred to as the 'discharge per unit area', or 'apparent velocity'. For design purposes, the discharge per unit area is more important than the actual velocity, v_m , at which water moves through the pores ($v_m > v_{\text{apparent}}$).

Nevertheless, the ratio between the apparent velocity and the actual velocity, is directly related to the value of K in Equation 7.19. The v_m -value can be calculated as a function of Q/A and porosity. The porosity of a sample of sand, or any other porous material, is the ratio of the volume of voids, in the sample, V_v , to the total volume of the sample, V .

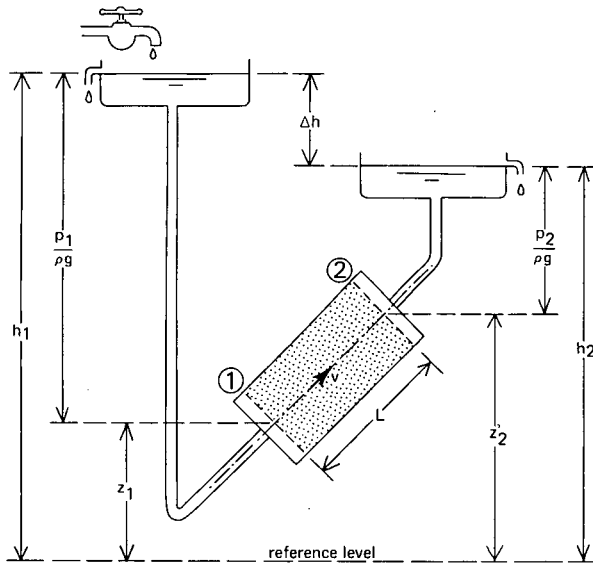

Figure 7.7 Pressure distribution and head loss in flow through a sand column

Porosity was defined in Chapter 3 as

$$\varepsilon = \frac{V_v}{V} \quad (7.20)$$

If a plane section is drawn through a random grain formation, it will intersect the grains and the voids between them. The net area occupied by the voids, a , will then stand in the same proportion to the cross-sectional area, in the sample, A , as the ratio V_v/V does. Therefore

$$\frac{a}{A} = \frac{V_v}{V} = \varepsilon \quad (7.21)$$

and also

$$v_m = \frac{Q}{\varepsilon A} = \frac{v}{\varepsilon} \quad (7.22)$$

In alluvial soils, the porosity, ε , varies from about 0.2 to 0.55 (Chapter 3).

7.4.2 The K-Value in Darcy's Equation

The proportionality coefficient, K , in Equation 7.19 represents the 'discharge per unit area' at unit hydraulic gradient. K depends mainly on the porosity of the material and on the size and shape of the material's grains. To a lesser extent, K depends on the grain-size distribution and the temperature of the water.

The influence of grain size on the velocity at which groundwater flows through pores can best be explained by laminar flow in pipes. This is exceptional because, in nearly all problems of practical hydraulic engineering, the flow is turbulent. The flow of water through a porous medium is possibly the only laminar-flow problem that will confront an irrigation and drainage engineer.

In 1843, Poiseuille published his well-known equation to describe laminar flow in pipes

$$v_p = \alpha s^u \quad (7.23)$$

where

- v_p = laminar flow velocity in the pipe (m/s)
- α = coefficient (m/s)
- s = hydraulic gradient (–)
- u = an exponent that approximates unity (–)

The coefficient, α , in Equation 7.23 can be derived from theoretical considerations. For a circular pipe, for example, Equation 7.23 becomes

$$v_p = \frac{A \rho g}{8 \pi \eta} s \quad (7.24)$$

Because the cross-sectional area of the pipe, A , equals $\pi d^2/4$, where d is the diameter of the pipe, Equation 7.24 can be written as

$$v_p = \frac{d^2 \rho g}{32 \eta} s \quad (7.25)$$

This equation was developed for a straight pipe, but it can also serve for the flow of water through porous material (see Equations 7.19 and 7.22). Equation 7.25 can thus be rewritten as

$$v_p = \frac{Q}{\varepsilon A} = \frac{d^2 \rho g \Delta h}{32 \eta L} \quad (7.26)$$

where d is the mean diameter of the pores between the grains. If we compare Equations 7.19 and 7.26, we find that

$$K = \frac{d^2 \rho g \varepsilon}{32 \eta} \quad (7.27)$$

The influence of porosity, ε , on the hydraulic conductivity, K , is clearly shown in this equation.

We saw in Table 7.1 that both the mass density of water, ρ , and its dynamic viscosity, η , are influenced by the temperature of the water. In practice, the relation between mass density and temperature is ignored, and the value of the mass density is taken as a constant, 1000 kg/m^3 . Nevertheless, as is obvious from Table 7.1, it is not always possible to ignore the influence of temperature on viscosity, and thus on the K -value. We can determine the hydraulic conductivity, K , at a temperature of $x^\circ\text{C}$ if we substitute the value of K measured at $y^\circ\text{C}$ into the following equation

$$K_{x^\circ} = K_{y^\circ} \frac{\eta_{y^\circ}}{\eta_{x^\circ}} \quad (7.28)$$

For example, if the hydraulic conductivity of a soil measured in the laboratory at 20°C is found to be 2 m/d , while the groundwater temperature is 10°C , then

$$K_{10^\circ} = K_{20^\circ} \frac{\eta_{20^\circ}}{\eta_{10^\circ}} = 2 \times \frac{1.01 \times 10^{-3}}{1.31 \times 10^{-3}} = 1.5 \text{ m/d}$$

Figure 7.8A shows a sample of coarse sand, and Figure 7.8B a sample of fine sand. Let the line AB be the path of a water particle flowing through both samples. It is clear that the flow path of the water particle is wider in the coarse sand than in the fine sand. We can thus draw the general conclusion that the hydraulic conductivity of a coarse material is greater than that of a fine one (see Equation 7.27).

Up until now, however, we have tacitly assumed that, in any type of soil, all the grains are of about the same diameter. This would be true for sand that has been carefully sieved, but natural soils usually consist of grains of many different sizes.

The influence of grain-size distribution on hydraulic conductivity is illustrated in Figure 7.9, which shows the flow path of a water particle through a mixture of the fine and coarse sands shown in Figure 7.8A and B. Following the flow path AB, we can see that the mean diameter of the pores in the mixture is determined by the smaller grains, and is only slightly affected by the larger grains. But, the larger grains partially block the passages that were present in the fine sand. Thus, in the mixture, the water particle is forced to travel a longer path to pass around the larger grains. In other words, while the mean diameter of the pores in the fine sand is almost the same as that in the mixture, the porosity of the mixture is less than the porosity of the fine sand. And, although the average size of the grains in the mixture is larger than that in the fine sand, the hydraulic conductivity of the mixture will be less than that of the fine sand.

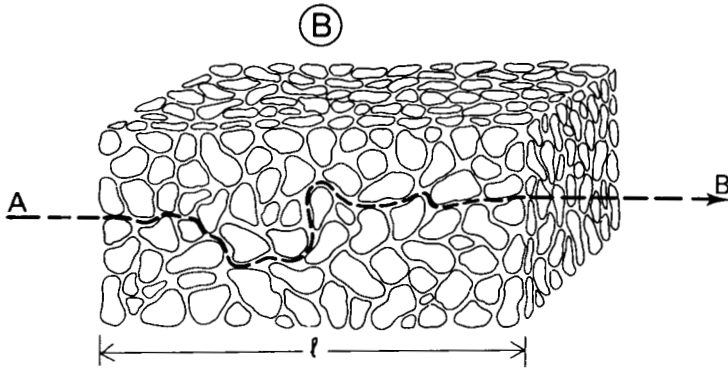
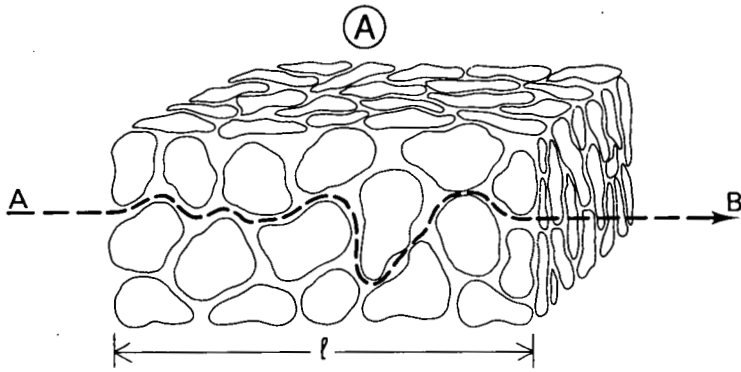

Figure 7.8 Flow path through two samples of sand (Leliavsky 1965)

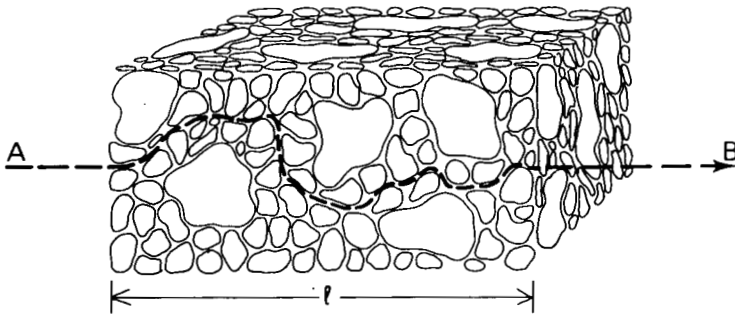

Figure 7.9 Flow path through a mixed sand sample (Leliavsky 1965)

So far, we have considered soils to be isotropic. Isotropy is the condition in which all significant properties are independent of direction. This means that the hydraulic conductivity is the same for any direction of flow. In reality, however, soils are seldom isotropic; instead, they are made up of layers with different hydraulic conductivities. Figure 7.10 presents a simple example of flow through a naturally-deposited, stratified soil. It is clear that a water particle following either flow path AB or CD will meet greater resistance than a water particle following paths EF or GH. The actual flow

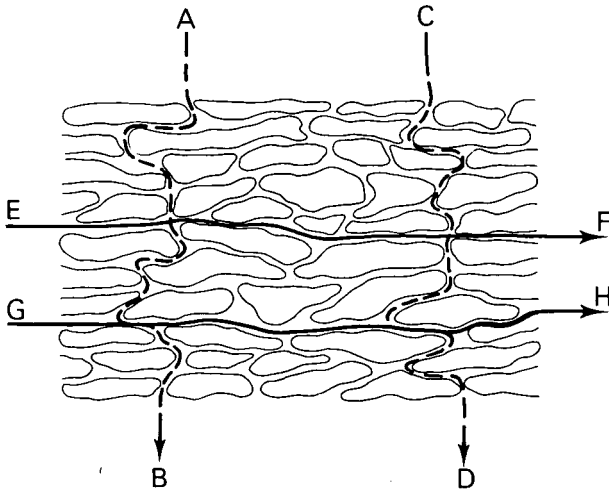

Figure 7.10 Flow through a naturally deposited, stratified soil (after Leliavsky 1955)

Table 7.2 K-values in m/d for granular materials (Davis 1969)

Clay soils (surface)	0.01	-	0.5
Deep clay beds	10^{-8}	-	10^{-2}
Loam soils (surface)	0.1	-	1
Fine sand	1	-	5
Medium sand	5	-	20
Coarse sand	20	-	100
Gravel	100	-	1000
Sand and gravel mixtures	5	-	100
Clay, sand, and gravel mixtures	0.001	-	0.1

paths of AB and CD are longer than those of EF and GH. This means that the hydraulic conductivity of this soil is greater for horizontal flow than for vertical flow.

The difference between horizontal and vertical K-values can only be determined by testing undisturbed samples or by conducting tests in situ (Chapter 12).

The orders of magnitude of K-values for granular materials are listed in Table 7.2.

7.4.3 Validity of Darcy's Equation

Like most empirical equations, Darcy's equation can be applied only within certain limits. Darcy's equation is valid only if the flow is laminar. As a criterion for laminar flow, we use the Reynolds number, Re , which is defined as (see also Chapter 19)

$$Re = \frac{vd_{50} \rho}{\eta} \quad (7.29)$$

where

v = discharge per unit area or the apparent velocity (m/s)

- d_{50} = mean diameter of soil grains (m)
- ρ = mass density (kg/m^3)
- η = dynamic viscosity (kg/m s)

These four parameters thus determine the extent to which Darcy's equation can be applied. For a drainage engineer, it will suffice to accept the validity of Darcy's equation if the Reynolds number is equal to or less than unity (see also Muskat 1946). Hence

$$\text{Re} = \frac{vd_{50} \rho}{\eta} \leq 1 \tag{7.30}$$

If we substitute the known values of ρ and η for water at 10°C into Equation 7.30, we arrive at

$$vd_{50} \leq 1.3 \times 10^{-6} \text{ m}^2/\text{s} \tag{7.31}$$

In natural conditions of groundwater flow, it is unlikely that this limit of application will be exceeded. It may occur, however, if d_{50} is large (coarse gravel), if the hydraulic gradient is steep (close to pumped wells), or if most of the groundwater flows through cavities in (calcareous) soils.

7.5 Some Applications of Darcy's Equation

7.5.1 Horizontal Flow through Layered Soil

Consider Figure 7.11, where water flows from an irrigation canal to parallel drains. In the cross-section, water flows in a horizontal direction through three layers, each of which has a different hydraulic conductivity (K_1 , K_2 , and K_3) and a different thickness (D_1 , D_2 , and D_3). If we assume that there is no flow across the boundaries between the individual layers, then the hydraulic gradient, $s = (h_1 - h_2)/L = \Delta h/L$, applies to the flow through each layer.

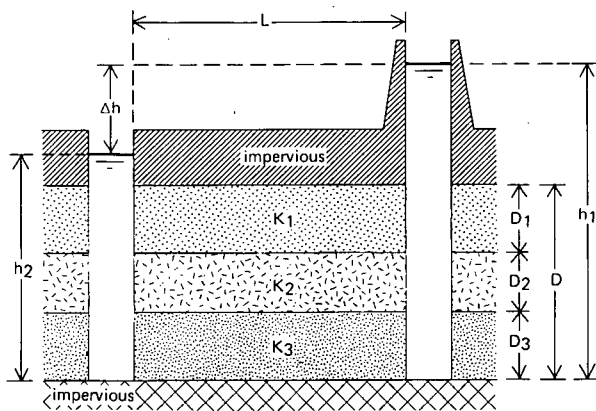

Figure 7.11 Horizontal flow through a layered soil

The flow rate per unit length of canal (q_1 , q_2 , and q_3) can be expressed by

$$\begin{aligned} q_1 &= K_1 D_1 s \\ q_2 &= K_2 D_2 s \\ q_3 &= K_3 D_3 s \end{aligned}$$

and the total flow through the cross-section by

$$q = q_1 + q_2 + q_3 = (K_1 D_1 + K_2 D_2 + K_3 D_3) s \quad (7.32)$$

or

$$q = \sum_{m=1}^n (K_m D_m) s$$

The product, KD , is the transmissivity of a soil layer in which the flow is horizontal. Layers with a high KD -value may thus contribute more to horizontal flow.

7.5.2 Vertical Flow through Layered Soils

Figure 7.12 is a cross-section of an irrigated field (basin with ponded water), where water is flowing vertically downward through a soil profile made up of layers of different thicknesses and different hydraulic conductivities. If we assume that the soil is saturated and no water can escape laterally, the discharge per unit area, i.e. the apparent velocity, is the same for each layer. Hence

$$v = K_1 \frac{h_1 - h_2}{D_1} \quad \text{or} \quad v \frac{D_1}{K_1} = h_1 - h_2$$

$$v = K_2 \frac{h_2 - h_3}{D_2} \quad \text{or} \quad v \frac{D_2}{K_2} = h_2 - h_3$$

$$v = K_3 \frac{h_3 - h_4}{D_3} \quad \text{or} \quad v \frac{D_3}{K_3} = h_3 - h_4$$

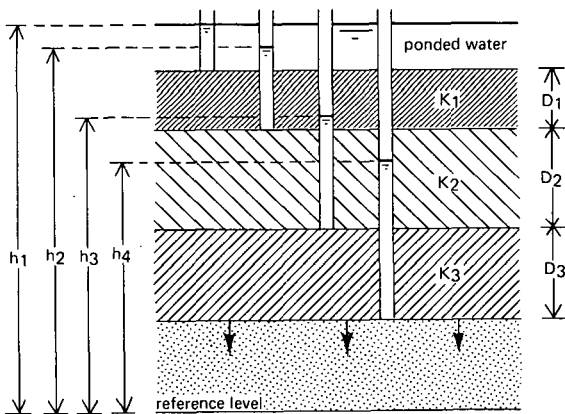

Figure 7.12 Vertical downward flow through layered soil

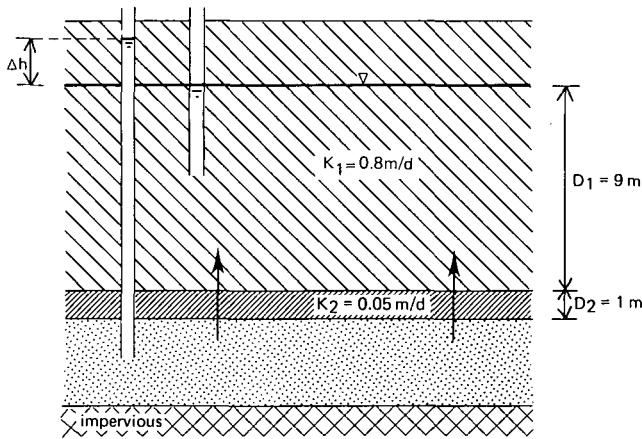

Figure 7.13 Vertical upward flow through two clay layers with different hydraulic conductivities and different thicknesses

Since $(h_1 - h_2) + (h_2 - h_3) + (h_3 - h_4) = h_1 - h_4 = \Delta h$, adding the equations yields

$$\frac{Q}{A} = v = \frac{\Delta h}{\frac{D_1}{K_1} + \frac{D_2}{K_2} + \frac{D_3}{K_3}} \quad (7.33)$$

As an example, let us consider Figure 7.13. It depicts an upper clay layer in which the watertable is assumed to remain stable because of factors such as drainage or evaporation. The saturated thickness of the clay layer is $D_1 = 9$ m; its hydraulic conductivity for vertical flow is $K_1 = 0.8$ m/d. Below this layer is a second clay layer; it is 1 m thick, and its hydraulic conductivity for vertical flow is $K_2 = 0.05$ m/d. The second clay layer rests on a sand layer that contains groundwater whose hydraulic head lies above the watertable in the upper clay layer ($\Delta h = 0.05$ m). The head difference causes a vertical upward flow from the sand layer through the overlying clay layers. According to Equation 7.33, the rate of this upward flow per unit area is

$$\frac{Q}{A} = \frac{0.05}{9/0.8 + 1/0.05} = \frac{0.05}{11.25 + 20} = \frac{0.05}{31.25} = 0.0016 \text{ m/d}$$

This shows that the second layer, with a high K/D -ratio, influences groundwater flow more than the thick first layer.

7.6 Streamlines and Equipotential Lines

7.6.1 Streamlines

In reality, all flow is three-dimensional. In irrigation and drainage engineering, however, we can regard groundwater flow as being essentially two-dimensional. This means that, in the direction normal to the plane of Figure 7.14, the thickness of the aquifer in the analysis equals unity. Such a two-dimensional flow problem is shown

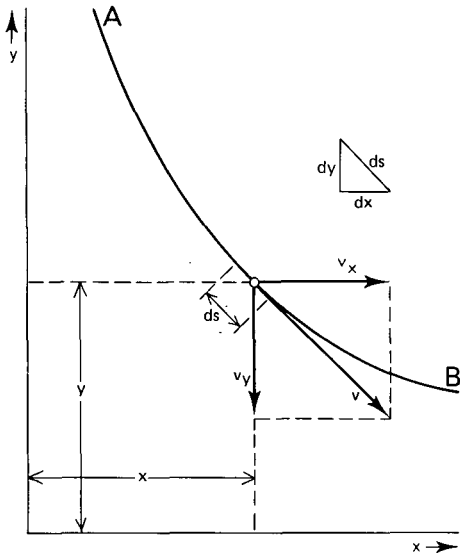

Figure 7.14 Two-dimensional path of a water particle

in Figure 7.14, where AB is the path of a moving particle of water. In this figure, v represents the velocity vector, which is of necessity tangential to the path AB at the point marked. It follows that

$$\frac{v_y}{v_x} = \frac{dy}{dx} \quad (7.34)$$

or

$$-v_y dx + v_x dy = 0 \quad (7.35)$$

This, generally stated, is the equation that describes the streamline AB at time t_1 . If we assume that $v_x = f(x,y)$ and that $v_y = -g(x,y)$, where $f(x,y)$ and $-g(x,y)$ are two functions of the coordinates x and y , then, because of the continuity equation (Equation 7.9), the left-hand part of Equation 7.35 will always be a total differential of a certain function $\Psi(x,y)$. The equation representing a streamline can thus be written as

$$-v_y dx + v_x dy = \frac{\delta\Psi}{\delta x} dx + \frac{\delta\Psi}{\delta y} dy = d\Psi = 0 \quad (7.36)$$

so that

$$v_x = + \frac{\delta\Psi}{\delta y} \quad (7.37)$$

and

$$v_y = - \frac{\delta\Psi}{\delta x} \quad (7.38)$$

It follows from Equation 7.36 that the function $\Psi(x,y)$ is a constant for every streamline. This function is called the 'stream function'. We can therefore draw a number of streamlines, e.g. $(AB)_1$, $(AB)_2$, and so on, each corresponding to a different value of the same stream function Ψ , e.g. Ψ_1 , Ψ_2 , and so on (Figure 7.15).

It is also useful to know the discharge, Δq , which flows between these streamlines. This can be calculated by adding all the elementary discharges, $dq = v_s dn$, passing through a section, ab . Expressed as an equation, this reads

$$\Delta q = \int_a^b dq = \int_a^b v_s dn \quad (7.39)$$

For the s,n -coordinates, Equations 7.37 and 7.38 can be rewritten as

$$v_s = + \frac{d\Psi}{dn} \quad (7.40)$$

and

$$v_n = 0 \quad (7.41)$$

If we substitute Equation 7.40 into Equation 7.39 and adapt the limits of integration, we find that

$$\Delta q = \int_{\Psi_1}^{\Psi_2} \frac{d\Psi}{dn} dn = \Psi_2 - \Psi_1 = -\Delta\Psi \quad (7.42)$$

This is an important result; it shows that the difference between two values of the stream function equals the discharge passing between the two corresponding streamlines. Thus, once the streamlines have been drawn, they show not only the flow direction, but also the relative magnitude of the velocity along the channel between the two streamlines. In other words, because of continuity, the velocity at any point in the stream channel varies in inverse proportion to the spacing of the streamline near that point.

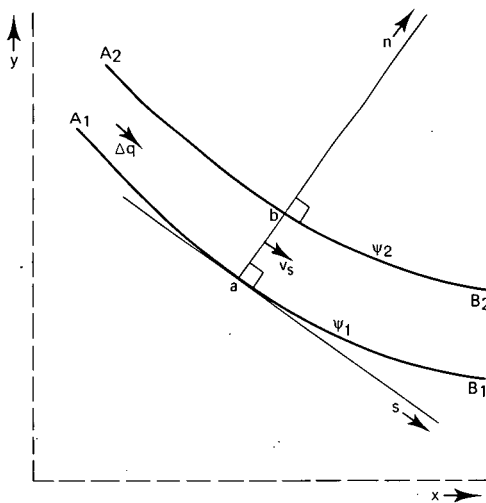

Figure 7.15 Illustration of the stream function Ψ

7.6.2 Equipotential Lines

To express two-dimensional flow in the xy -plane (Figure 7.16), we must rewrite Darcy's equation as

$$v_x = -K \frac{\delta h}{\delta x} \quad \text{and} \quad v_y = -K \frac{\delta h}{\delta y} \quad (7.43)$$

Obviously, the rate of change of $K \times h = K(z + p/\rho g)$ determines the flow velocity. The product Kh can be replaced by Φ , i.e. the 'velocity potential'. Hence, we can rewrite Equation 7.43 as

$$v_x = -\frac{\delta \Phi}{\delta x} \quad \text{and} \quad v_y = -\frac{\delta \Phi}{\delta y} \quad (7.44)$$

For lines with a constant value of $\Phi(x,y)$, i.e. lines that connect points with the same velocity potential, the total differential equals zero. Hence

$$\frac{\delta \Phi}{\delta x} dx + \frac{\delta \Phi}{\delta y} dy = d\Phi = 0 \quad (7.45)$$

If we substitute v_x and v_y as given in Equation 7.44 into Equation 7.45, we see that

$$v_x dx + v_y dy = 0 \quad (7.46)$$

This equation describes a line with a constant value, Φ_1 , of Φ , i.e. an equipotential line.

Following the streamline's tangent, i.e. following the s -direction, we can rewrite Equation 7.44 as

$$v_s = -\frac{d\Phi}{ds} \quad \text{and} \quad v_n = 0 \quad (7.47)$$

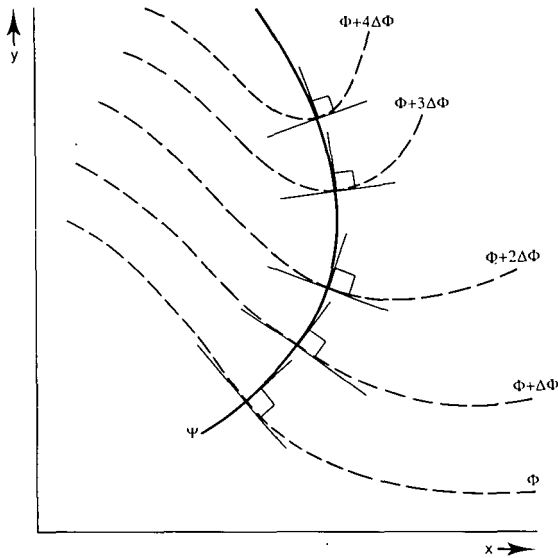

Figure 7.16 Illustration of equipotential lines

Thus, if we draw a set of curves, for each one of which Φ is constant, and if we choose these curves in such a way that the interval between them is $\Delta\Phi$, we obtain a diagram like the one in Figure 7.16. This could, for example, be part of a watertable-contour map.

The equipotential lines describe a surface whose slope, $d\Phi/ds$, is a measure of the velocity, v_s ; so, the closer the equipotentials, the greater the velocity.

7.6.3 Flow-Net Diagrams

If we reconsider both the equation that describes a streamline (Equation 7.35) and the equation that describes an equipotential line (Equation 7.46), we can see that for the streamline

$$\frac{dy}{dx} = \frac{v_y}{v_x}$$

and for the equipotential line

$$\frac{dy}{dx} = -\frac{v_x}{v_y}$$

The product of their slopes equals -1 . Streamlines always intersect equipotential lines at right angles, as we saw in Figure 7.16. Flow patterns can therefore be shown by a family of streamlines that intersects a family of equipotential lines at right angles. An example is shown in Figure 7.17.

It has been explicitly stated that streamlines and equipotential lines are directly

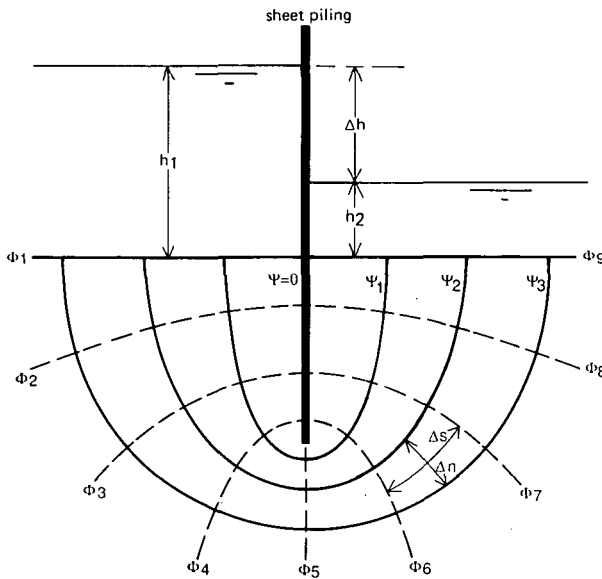

Figure 7.17 Flow-net diagram illustrating two-dimensional seepage under sheet piling in a homogeneous soil

related to each other. In fact, if a family of streamlines is established for a given flow pattern, there will then be only one corresponding family of equipotential lines, and vice versa. This can be seen if we rewrite Equations 7.40 and 7.47 as

$$d\Psi = v_s dn \quad \text{or} \quad \Delta\Psi = v_s \Delta n \quad (7.48)$$

and

$$-d\Phi = v_s ds \quad \text{or} \quad -\Delta\Phi = v_s \Delta s \quad (7.49)$$

If the flow net is constructed in such a way that $\Delta n = \Delta s$, it will consist of 'approximate squares', and

$$\Delta\Psi = -\Delta\Phi \quad (7.50)$$

A flow-net diagram of approximate squares is more convenient to draw and is easier to check for accuracy than a flow net of approximate rectangles. Harr (1962) recommends the following procedure for drawing a flow net:

- 1 Draw the boundaries of the flow region to scale so that all equipotential lines and streamlines that are drawn can be terminated on these boundaries (Figure 7.18A);
- 2 Sketch lightly three or four streamlines, keeping in mind that they are only a few of the infinite number of curves that must provide a smooth transition between the boundary streamlines. As an aid in the spacing of lines, note that the distance between adjacent streamlines increases in the direction of the larger radius of curvature (Figure 7.18B);
- 3 Sketch the equipotential lines, bearing in mind that they must intersect all streamlines, including the boundary streamlines, at right angles, and that the enclosed figures must be approximate squares (Figure 7.18B);
- 4 Adjust the locations of the streamlines and the equipotential lines to satisfy the requirements of Step 3 (Figures 7.18C and D). This is a trial-and-error process with the amount of correction being dependent upon the position of the initial streamlines. The speed with which a successful flow net can be drawn is highly contingent on the experience and judgement of the individual.

In the judgement of the designer, the flow nets shown in Figure 7.18B and C might be 'equally good'. In Figure 7.18D, the two flow nets have been superposed and it appears that the two 'equally good' flow nets do not coincide. The designer of a flow net can improve his design if he realizes that all sides of an approximate square must have a tangent point with a circle drawn within the square (Leliavsky 1955). In addition to the above four rules, it is recommended to:

- 5 Fill the area of Figure 7.18A with auxiliary circles as shown in Figure 7.18E;
- 6 Draw curved lines through the points of contact of the circles (Figure 7.18E) and omit the circles to obtain the flow net diagram (Figure 7.18F);
- 7 As a final check on the accuracy of the flow net, draw the diagonals of the squares. These should also form curves that intersect each other at right angles (Figure 7.18G).

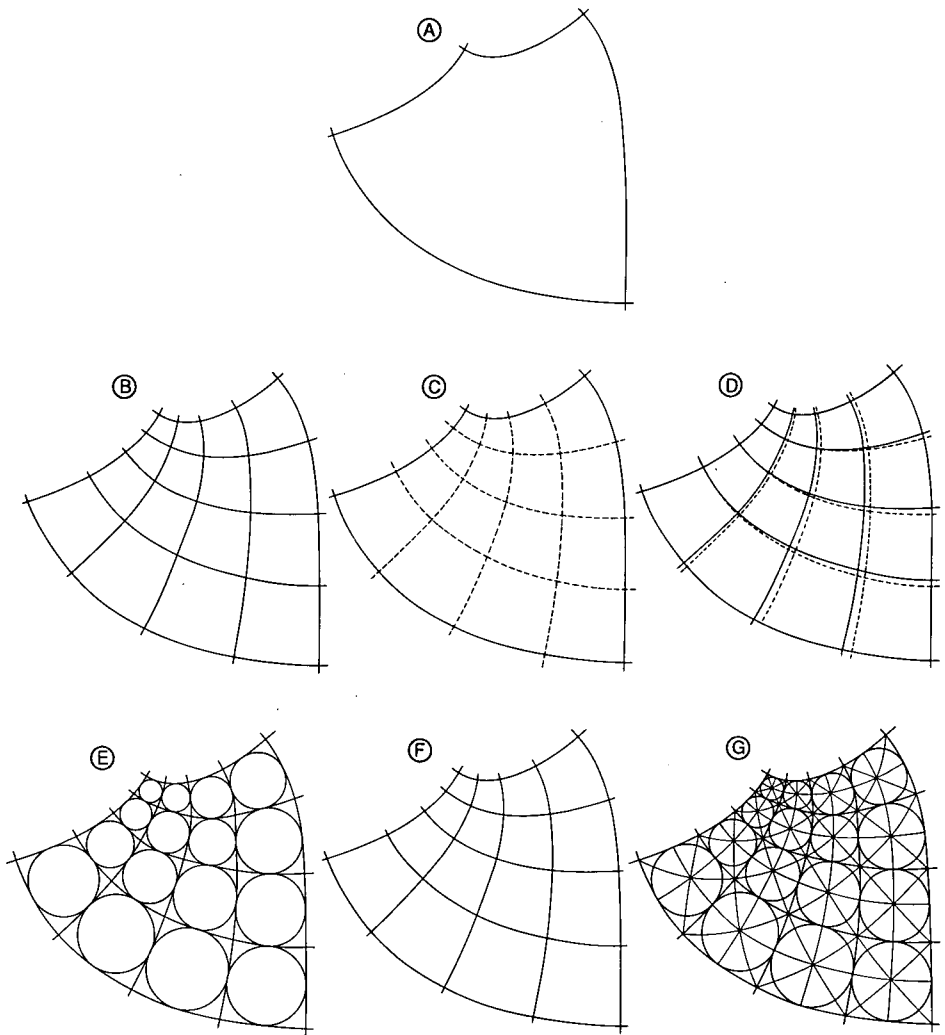

Figure 7.18 Methods of drawing a flow-net diagram (after Leliavsky 1955)

7.6.4 Refraction of Streamlines

When streamlines in a soil layer with a given hydraulic conductivity, K_1 , cross the interface into a layer with a different hydraulic conductivity, K_2 , their flow paths are refracted in the same way as light is refracted (Figure 7.19).

Let us consider two water particles that are following separate streamlines, Ψ_a and Ψ_b . They arrive simultaneously at Points A and C_1 . In the time it takes the second particle to flow from C_1 to B, the first particle has flowed at a different velocity to C_2 ; it has crossed the interface. If we draw the equipotential lines, Φ_1 and Φ_2 , we see that the flow paths of the streamlines have been refracted.

In Figure 7.19, we consider the discharge Δq that flows between two streamlines,

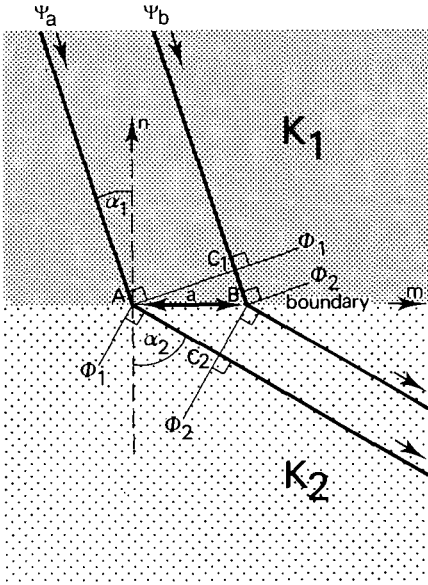

Figure 7.19 Refraction of streamlines

Ψ_a and Ψ_b . From the continuity equation (Equation 7.11), we know that this discharge must be the same in both layers, even though their K -values are different. Hence

$$\Delta q = K_1 s_1 a \cos \alpha_1 = K_2 s_2 a \cos \alpha_2 \quad (7.51)$$

where

α_1 = angle of entry

α_2 = angle of refraction

a = the unit area between Points A and B in Figure 7.19

s_1, s_2 = the respective values of the hydraulic gradient in the two layers, being

$$s_1 = \frac{\Phi_1 - \Phi_2}{a \sin \alpha_1} \quad (7.52)$$

$$s_2 = \frac{\Phi_1 - \Phi_2}{a \sin \alpha_2} \quad (7.53)$$

As can be seen in Figure 7.19, Φ_1 and Φ_2 are two different equipotential lines. Substituting Equations 7.52 and 7.53 into Equation 7.51, we see that

$$K_1 \frac{\Phi_1 - \Phi_2}{a \sin \alpha_1} a \cos \alpha_1 = K_2 \frac{\Phi_1 - \Phi_2}{a \sin \alpha_2} a \cos \alpha_2$$

or

$$\frac{K_1}{K_2} = \frac{\tan \alpha_1}{\tan \alpha_2} \quad (7.54)$$

If $\alpha_1 = 0$, then $\alpha_2 = 0$ as well. This was tacitly assumed in Section 7.5.2. And, Equation 7.54 shows that if $K_2 \gg K_1$, then α_2 is very large compared with $\tan \alpha_1$. Such a situation

is found where a clay layer (K_1) covers a drained sand layer (K_2). In the clay layer, the flow is almost vertical; in the sand layer, it is almost horizontal. This supports the general assumption that, in a semi-confined aquifer, groundwater flow in the sand can be regarded as horizontal, and in the covering clay layer as vertical.

7.6.5 The Laplace Equation

For two-dimensional flow to occur, Equations 7.37, 7.38, and 7.44 dictate that

$$-\frac{\delta\Phi}{\delta x} = \frac{\delta\Psi}{\delta y} \quad (7.55)$$

and

$$\frac{\delta\Psi}{\delta x} = \frac{\delta\Phi}{\delta y} \quad (7.56)$$

These two important conditions are called the Cauchy-Rieman equations. They are necessary, but in themselves are insufficient to calculate two-dimensional flow; the existence and continuity of all partial derivatives of $\Phi(x,y)$ and $\Psi(x,y)$ must be verified as well. We must therefore be able to differentiate Equation 7.55 with respect to x and Equation 7.56 with respect to y . Adding the results, we find that

$$\frac{\delta^2\Phi}{\delta x^2} + \frac{\delta^2\Phi}{\delta y^2} = 0 \quad (7.57)$$

This equation can also be obtained by substituting Equation 7.44 directly into Equation 7.9. The continuity equation for two-dimensional flow would then read

$$\frac{\delta v_x}{\delta x} + \frac{\delta v_y}{\delta y} = 0 \quad (7.58)$$

Equation 7.57 is the well-known Laplace equation for two-dimensional flow. For homogeneous and isotropic soils (hence for $K_x = K_y = K = \text{constant}$), the Laplace equation is often written with h instead of $\Phi = Kh$. Under these conditions, Equation 7.57 reduces to

$$\frac{\delta^2 h}{\delta x^2} + \frac{\delta^2 h}{\delta y^2} = 0 \quad (7.59)$$

Laplace's equation is also written as

$$\nabla^2 h = 0$$

where the symbol ∇ , called 'del', is used to denote the differential operator

$$\frac{\delta}{\delta x} + \frac{\delta}{\delta y} + \frac{\delta}{\delta z}$$

and ∇^2 , called 'del squared', is used for

$$\frac{\delta^2}{\delta x^2} + \frac{\delta^2}{\delta y^2} + \frac{\delta^2}{\delta z^2}$$

which is called the Laplacean operator.

The above equations for flow and continuity are valid for steady flow. When investigating a particular flow problem, we can only determine its solution if we know what happens at the boundaries of the flow region. Hence, the boundary conditions should be properly defined. They may include statements on the hydraulic head, or on the inflow and outflow conditions at the boundary, or that a boundary may be a streamline, and so on.

7.7 Boundary Conditions

From theory, we know that partial differential equations like Laplace's have an infinite number of solutions. So how do we choose the one solution that applies to a given problem? Boundary conditions in problems of groundwater flow describe the specific conditions that are to be imposed at the boundaries of the flow region. These boundaries are not necessarily impervious layers or walls confining the groundwater. Rather, they are geometrical surfaces where, at all points, we know either the flow velocity of the groundwater, or an equipotential line, or a given function of both. Some characteristic boundary conditions will be briefly discussed in the following sections.

7.7.1 Impervious Layers

The boundary of an impervious layer can be regarded as a streamline because there is no flow across it. The flow velocity component normal to such a boundary therefore vanishes, and we have $\Psi = \text{constant}$ and $d\Psi/ds = 0$. In practice, a layer is considered impervious if its hydraulic conductivity is very low compared with the hydraulic conductivity of adjacent layers.

7.7.2 Planes of Symmetry

Planes of symmetry are illustrated in Figure 7.20 by the two lines marked A-B (running vertically through the drain axis) and the boundary line marked C-D (running parallel to A-B, but midway between the drains). Because of the symmetry of the system, the

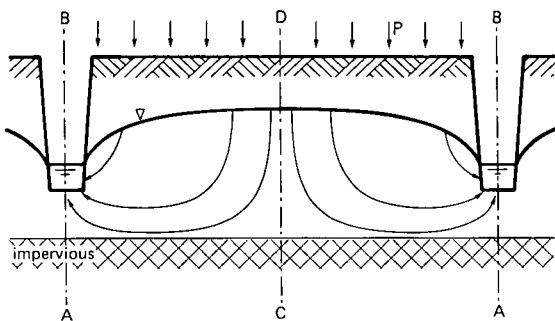

Figure 7.20 Boundary conditions for steady flow to drainage canals

pattern of equipotential lines and streamlines on one side of the 'boundary' mirrors the pattern on the other side. Hence, any horizontal flow velocity component immediately adjacent to that 'boundary' must be matched on the other side by a component in the opposite direction. The net flow across the boundary must therefore be zero, and the plane of symmetry, like an impervious layer, is a streamline of the system.

7.7.3 Free Water Surface

The free water surface is defined as the surface where water pressure equals atmospheric pressure. It is assumed that the free water surface limits the groundwater flow region, i.e. no groundwater flow occurs above this surface. This assumption is untrue in most instances of flow through soils, but it is useful when we are analyzing flow through a layer whose capillary fringe is thin in comparison with its thickness, D .

In a free water surface, the pressure component of the total head, $p/\rho g$, is zero; hence the hydraulic head at the water's surface is equal to the elevation component of this surface at a given point: $h = z$.

If there is no percolation of water towards the free water surface, the flow velocity component normal to that surface is zero and the free water surface then represents a streamline.

If there is percolation, however, the vertical recharge, R , determines the value of the streamlines. In Figure 7.21, a rainfall intensity is assumed, of which R recharges the groundwater body. The free water surface is neither an equipotential line nor a streamline, and the starting points of streamlines are at regular distances from each other.

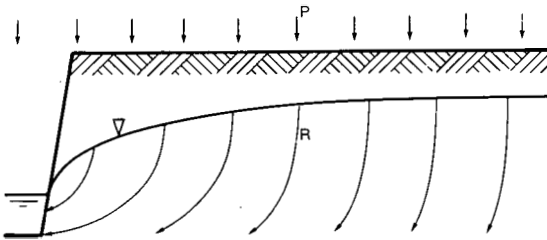

Figure 7.21 Boundary conditions for a free water surface

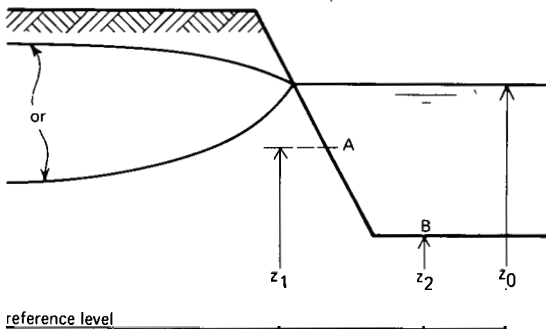

Figure 7.22 Boundary conditions for water at rest or for slowly-moving water

7.7.4 Boundary Conditions for Water at Rest or for Slowly-Moving Water

These boundaries are found along the bottom and side slopes of canals and reservoirs, and where upward groundwater flow meets downward percolating water. The hydrostatic pressure along the bottom or side of a canal, i.e. the pressure due to a certain level of water above the bottom or side of a canal, is expressed by (Figure 7.22)

$$p = \rho g (z_0 - z) \tag{7.60}$$

where

- z = the elevation of a given point above the reference level (m)
- z_0 = the elevation of the water level in the canal (m)

It then follows that

$$h = z_0 = \frac{p}{\rho g} + z \tag{7.61}$$

Now the right-hand expression represents the potential or hydraulic head, so the potential head at each point along the canal is equal to the height of the water level, z_0 , in the canal. In Figure 7.22, we have

Point	Elevation head	$h = z + p/\rho g$	Pressure ($p/\rho g$)
A	z_1	z_0	$z_0 - z_1$
B	z_2	z_0	$z_0 - z_2$

7.7.5 Seepage Surface

At all points in the soil above the watertable, the pressure head is negative, while below the watertable, it is generally positive. An exception occurs if the watertable intersects the surface of the soil, as shown in Figure 7.23. In this case, a seepage surface occurs. A seepage surface is defined as the boundary where water leaves the soil mass and then continues to flow in a thin film along its surface. Seepage surfaces can also occur on the downstream face of dams.

Along a seepage surface, the pressure $p = 0$ (atmospheric pressure). Hence the

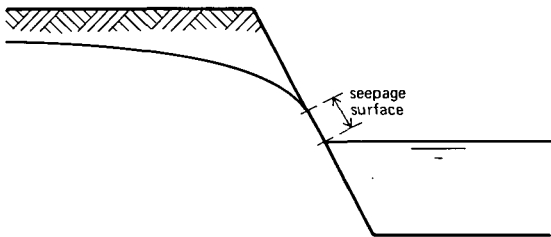

Figure 7.23 Boundary conditions for a seepage surface

hydraulic head at any point on the seepage surface is equal to the elevation at that point, or $h = z$. A seepage surface is not a streamline because, in the interior of the soils mass, the component of the flow-velocity vector perpendicular to the boundary is not zero.

7.8 The Dupuit-Forchheimer Theory

7.8.1 The Dupuit-Forchheimer Assumptions

Groundwater-flow patterns bounded by the watertable (known as unconfined flow patterns) are difficult to calculate. Obtaining a mathematically exact solution with the Laplace equation is complex because the non-linear free water surface is both the boundary condition of, and the solution to, the drainage problem. As a result, complex calculations do not always give better answers than a simplified method because our knowledge of this boundary condition is imprecise, the soil is heterogeneous, and the groundwater recharge from rainfall or irrigation is not uniform.

A method first developed by Dupuit in 1863, and improved by Forchheimer (1930), gives good solutions to problems of flow to parallel canals and to pumped wells. In addition to assuming that:

- The flow pattern is steady;
- Darcy's equation is applicable.

Dupuit also assumed that:

- In a vertical section, MN, of the aquifer, all velocity vectors are horizontal and equal to $v = -K(dy/dx)$ (see Figure 7.24);
- The hydraulic gradient between two infinitely adjacent sections, MN and M'N', exactly equals

$$s = \frac{dy}{MM'} = \sin \theta$$

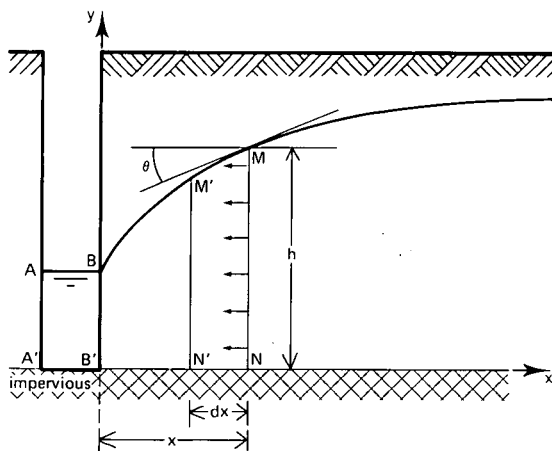

Figure 7.24 Steady flow in an unconfined aquifer as an illustration of Dupuit's assumptions

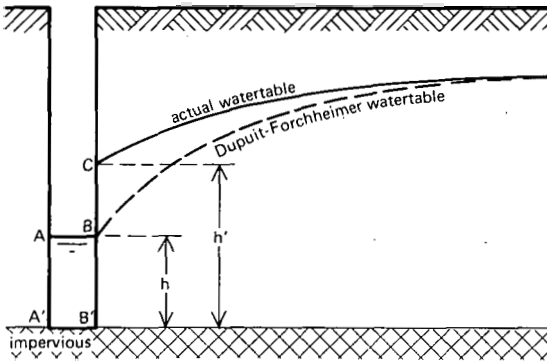

Figure 7.25 The watertable near a seepage surface cannot be explained by Dupuit's assumptions

which can be written as

$$s = \frac{dy}{dx} = \operatorname{tg} \theta \quad (7.62)$$

In part, Dupuit's assumptions are contradictory, and the last assumption is valid only if θ remains small. Calculations that incorporate these assumptions will therefore indicate a lower watertable in the vicinity of pumped wells and when a seepage surface (illustrated as BC in Figure 7.25) can be expected. We can easily see that a seepage surface will occur if the water surface AB approaches A'B'.

Nevertheless, with Dupuit's assumptions, we can solve a variety of groundwater-flow problems with satisfactory accuracy. Forchheimer used the assumptions to develop a general equation for the free water surface. He applied the continuity equation to a vertical column of water, which, in a flow region, is bounded above by the phreatic surface and below by an impervious layer, and whose height is h (see Figure 7.26).

If we assume that the surface of the impervious layer is horizontal, i.e. that it coincides with the plane delineated by the horizontal coordinates x and y , the horizontal components of the flow velocity are

$$v_x = K \frac{\partial h}{\partial x} \quad \text{and} \quad v_y = -K \frac{\partial h}{\partial y} \quad (7.63)$$

If q_x is the flow rate in the x -direction, then the water entering through the left face of the column is the product of the area, $h \times dy$, and the velocity, v_x . Thus

$$q_x = -K \left(h \frac{\partial h}{\partial x} \right) dy \quad (7.64)$$

As water moves from the left-hand to the right-hand face of the column, we see that the flow rate changes by $\partial q_x / \partial x$. When the water leaves the right-hand face of the column, q_x has changed to

$$q_{(x+dx)} \quad \text{i.e. to} \quad q_x + \frac{\partial q_x}{\partial x} dx$$

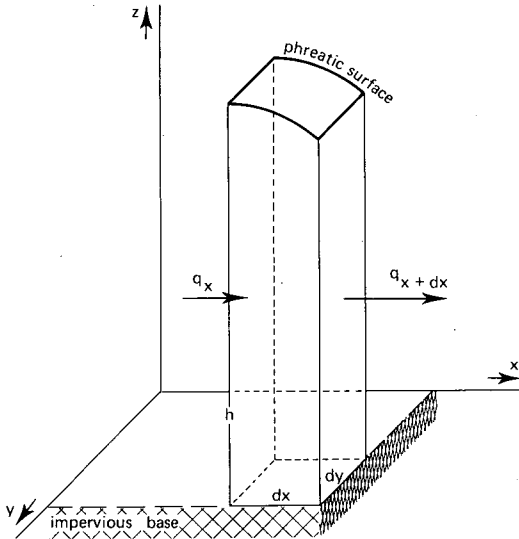

Figure 7.26 Approximate horizontal flow in a fluid space column as an assumption for deriving Forchheimer's linearized continuity equation

The difference between outflow and inflow per unit time in the x-direction is

$$q_{(x+dx)} - q_x = \frac{\partial q_x}{\partial x} dx = -K \frac{\partial}{\partial x} \left(h \frac{\partial h}{\partial x} \right) dx dy \quad (7.65)$$

Similarly, the change in flow in the y-direction is

$$\frac{\partial q_y}{\partial y} dy = -K \frac{\partial}{\partial y} \left(h \frac{\partial h}{\partial y} \right) dx dy \quad (7.66)$$

If we assume steady flow, the continuity equation requires that the sum of the changes adds up to zero. Hence the sum of the right-hand expressions of Equations 7.65 and 7.66 equals

$$-K \left[\frac{\partial}{\partial x} \left(h \frac{\partial h}{\partial x} \right) + \frac{\partial}{\partial y} \left(h \frac{\partial h}{\partial y} \right) \right] dx dy = 0 \quad (7.67)$$

Equation 7.67 can also be written as

$$\frac{\partial}{\partial x} \left(h \frac{\partial h}{\partial x} \right) + \frac{\partial}{\partial y} \left(h \frac{\partial h}{\partial y} \right) = 0 \quad (7.68)$$

or

$$\frac{\partial^2 h^2}{\partial x^2} + \frac{\partial^2 h^2}{\partial y^2} = 0 \quad (7.69)$$

Equations 7.67 to 7.69 are alternative forms of the Forchheimer equation for steady flow.

7.8.2 Steady Flow above an Impervious Horizontal Boundary

Let us regard the xz -plane in Figure 7.27 as the plane of flow in which h_1 and h_2 are the known elevations of two points of the steady watertable. For this flow pattern, Equation 7.68 reduces to

$$\frac{d}{dx} \left(h \frac{dh}{dx} \right) = 0$$

which, after integration, yields the equation of the parabola

$$h^2 = C_1 x + C_2 \quad (7.70)$$

The integration constants, C_1 and C_2 , can be solved by applying the boundary conditions $x = 0, h = h_1$, and $x = L, h = h_2$. Substituting the values of C_1 and C_2 into Equation 7.70, we obtain the expression for the elevation h at any intermediate point

$$h = \sqrt{h_1^2 - (h_1^2 - h_2^2) \frac{x}{L}} \quad (7.71)$$

According to Darcy, the discharge per unit width through any vertical section between Points 1 and 2 in Figure 7.27 is

$$q = -K h \frac{dh}{dx} \quad (7.72)$$

which, after integration and substitution of the boundary conditions, yields

$$q = \frac{K}{2L} (h_1^2 - h_2^2) \quad (7.73)$$

Equation 7.73 is called Dupuit's formula.

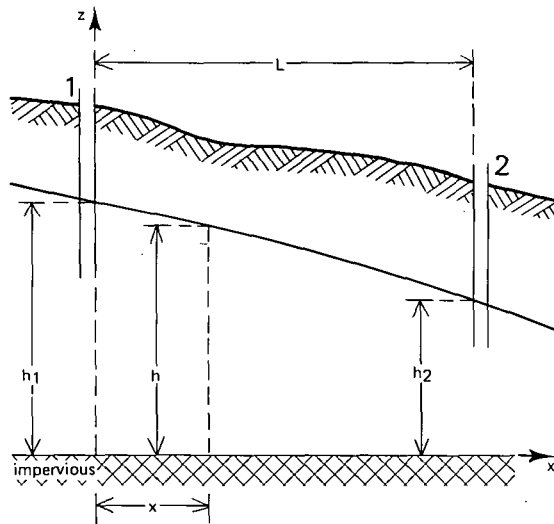

Figure 7.27 Steady flow above an impervious horizontal boundary

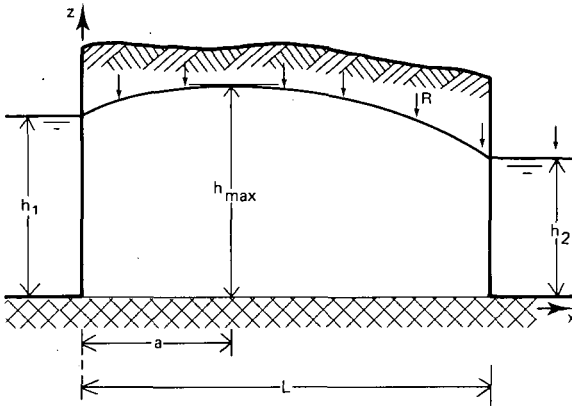

Figure 7.28 Watertable subject to recharge at a rate of R per unit area

7.8.3 Watertable subject to Recharge or Capillary Rise

We assume that the watertable in Figure 7.28 has a uniform rate of flow, R , per unit area ($R > 0$ if there is recharge, and $R < 0$ if there is capillary rise). For two-dimensional flow, the right-hand expression in Equation 7.67 will equal $R dx dy$. Hence

$$-K \left[\frac{\partial}{\partial x} \left(h \frac{\partial h}{\partial x} \right) + \frac{\partial}{\partial y} \left(h \frac{\partial h}{\partial y} \right) \right] dx dy = R dx dy \quad (7.74)$$

For flow in the xz -plane shown in Figure 7.28, this equation reduces to

$$K \frac{d}{dx} \left(h \frac{dh}{dx} \right) + R = 0$$

Upon integration, it becomes

$$Kh^2 + Rx^2 = C_1 x + C_2 \quad (7.76)$$

If there is recharge ($R > 0$), Equation 7.76 is an ellipse; if there is capillary rise from the groundwater profile ($R < 0$), it is a hyperbola.

Limiting ourselves to recharges, we can derive several useful approximate relationships. If we substitute the boundary conditions, $x = 0, h = h_1$, and $x = L, h = h_2$, into Equation 7.76, we obtain the general equation for the watertable

$$h = \sqrt{h_1^2 - \frac{(h_1^2 - h_2^2)x}{L} + \frac{R}{K} (L-x)x} \quad (7.77)$$

If $R = 0$, this equation gives the approximate groundwater profile for flow through a dam or a dike. It then equals Equation 7.71.

When the water levels in the (drainage) canals shown in Figure 7.28 are equal ($h_1 = h_2 = h_0$), the maximum value of h is reached, because of symmetry, at

$a = x = L/2$. After substituting these conditions into Equation 7.77, we obtain (see also Chapter 8, Section 8.2.1))

$$h_{\max} = \sqrt{h_0^2 + \frac{RL^2}{4K}}$$

or

$$L = \sqrt{\frac{4K}{R} (h_{\max}^2 - h_0^2)} \quad (7.78)$$

Then, to determine the flow rate through a vertical section in Figure 7.28, we substitute Equation 7.72 into Equation 7.75, which yields

$$\frac{dq_x}{dx} = R$$

After integrating and substituting the boundary condition ($x = 0, q_x = q_1$), we obtain

$$q_x = Rx + q_1 \quad (7.79)$$

Substituting Equation 7.72 into Equation 7.79 and integrating the result with the boundary conditions of Equation 7.77 gives

$$q_1 = \frac{K}{2L} (h_1^2 - h_2^2) - \frac{RL}{2} \quad (7.80)$$

which, when substituted back into Equation 7.79, finally gives

$$q_x = \frac{K}{2L} (h_1^2 - h_2^2) - R \left(\frac{L}{2} - x \right) \quad (7.81)$$

It should be noted here that, if $R = 0$, this equation will be similar to Equation 7.73.

The distance $x = a$ (see Figure 7.28), for which the elevation of the groundwater profile is at its maximum (h_{\max}), can be found from Equation 7.81 by substituting $q_x = 0$. Hence

$$a = \frac{L}{2} - \frac{K}{2RL} (h_1^2 - h_2^2) \quad (7.82)$$

7.8.4 Steady Flow towards a Well

As a last example, the flow towards a fully penetrating well will be analyzed (Figure 7.29). A homogeneous and isotropic aquifer is assumed, bounded below by a horizontal impervious layer. While being pumped, such a well receives water over the full thickness of the saturated aquifer because the length of the well screen equals the saturated thickness of the aquifer.

The initial watertable is horizontal, but attains a curved shape after pumping is started. Water is then flowing from all directions towards the well (radial flow). It is further assumed that there is no vertical recharge, and that the groundwater flow towards the well is in a steady state, i.e. the hydraulic heads along the perimeter of

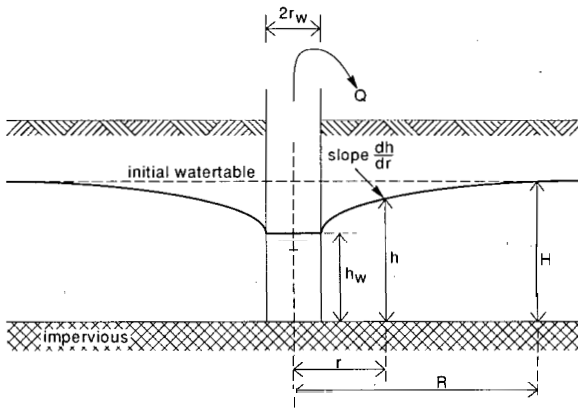

Figure 7.29 Horizontal radial flow towards a pumped well that fully penetrates an unconfined aquifer. No recharge from rainfall.

any circle concentric with the well are constant (radial symmetry). Flow through any cylinder at a distance from the centre of the well can be found by applying the continuity equation and the equation of Darcy. We hereby assume that the hydraulic gradient in this cylinder equals the slope of the watertable at the circle of this cylinder, dh/dr . Substituting this gradient, and the area of flow, $A = 2\pi rh$, into the Darcy equation yields

$$Q = 2 \pi r h K \frac{dh}{dr} \quad (7.83)$$

where Q is the steady radial well flow and K is the hydraulic conductivity of the aquifer. On integration between the limits $h = h_w$ at $r = r_w$ and $h = H$ at $r = r_e$ Equation 7.83 yields

$$H^2 - h_w^2 = \frac{Q}{\pi k} \ln \frac{r_e}{r_w} \quad (7.84)$$

where

- r_w = the well radius (m)
- r_e = the radius of influence of the well (m)

After being rearranged, this yields the Dupuit equation

$$Q = \frac{\pi K (H^2 - h_w^2)}{\ln \frac{r_e}{r_w}} \quad (7.85)$$

We can obtain a specific solution to this equation by substituting a pair of values of h and r measured in two observation wells at different distances from the centre of the pumped well. For $r = r_1$ with $h = h_1$, and for $r = r_2$ with $h = h_2$, Equation 7.85 then reads

$$Q = \pi K \frac{h_2^2 - h_1^2}{\ln \frac{r_2}{r_1}} \quad (7.86)$$

If the head loss is small compared with the saturated thickness of the aquifer, D , we can approximate $h_2 + h_1 = 2D$. Equation 7.86 then becomes

$$Q = 2\pi KD \frac{h_2 - h_1}{\ln \frac{r_2}{r_1}} \quad (7.87)$$

Because of the Dupuit-Forchheimer assumptions listed in Section 7.8.1, this equation cannot accurately describe the drawdown curve near the well. For distances farther from the well, however, the equation can be used without appreciable errors (see also Section 10.4.4).

7.9 The Relaxation Method

The relaxation method is a numerical way of calculating an approximate solution to the Laplace equation (Equation 7.59) for two-dimensional flow. It is based on the replacement of differential coefficients by finite difference expressions.

Let us now assume that we know the groundwater levels, h_1, h_2, h_3, h_4 , at four points (Figure 7.30), and that we want to estimate the level, h_0 .

Studying the watertable in the x -direction, we can assign an arbitrary value to the h_0 -level and connect h_1, h_0 , and h_3 as shown.

The physical meaning of the first differential coefficient of a function is the slope of that function (watertable) at a given point. Hence

$$\left(\frac{\partial h}{\partial x}\right)_{3 \rightarrow 0} \approx \frac{h_0 - h_3}{\Delta x} \quad (7.88)$$

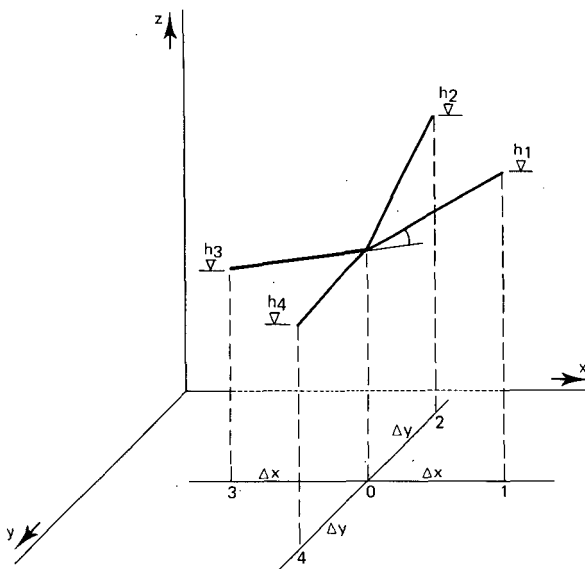

Figure 7.30 Estimating the h_0 -level

and also

$$\left(\frac{\partial h}{\partial x}\right)_{0 \rightarrow 1} \approx \frac{h_1 - h_0}{\Delta x} \quad (7.89)$$

The physical meaning of the second differential coefficient of a function is the rate of change in the slope of that function (describing the watertable) at a given point. Thus, for distance $0.5\Delta x$ around point 0, we can write

$$\left(\frac{\partial^2 h}{\partial x^2}\right)_0 = \frac{\left(\frac{\partial h}{\partial x}\right)_{0 \rightarrow 1} - \left(\frac{\partial h}{\partial x}\right)_{3 \rightarrow 0}}{\Delta x} \quad (7.90)$$

Substituting Equations 7.88 and 7.89 into this equation yields

$$\left(\frac{\partial^2 h}{\partial x^2}\right)_0 = \frac{h_1 + h_3 - 2h_0}{\Delta x^2} \quad (7.91)$$

A similar procedure for levels h_2 , h_0 , and h_4 in the y -direction yields

$$\left(\frac{\partial^2 h}{\partial y^2}\right)_0 = \frac{h_2 + h_4 - 2h_0}{\Delta y^2} \quad (7.92)$$

Substituting Equations 7.91 and 7.92 into the Laplace equation (Equation 7.59) yields

$$\frac{\partial^2 h}{\partial x^2} + \frac{\partial^2 h}{\partial y^2} = \frac{h_1 + h_3 - 2h_0}{\Delta x^2} + \frac{h_2 + h_4 - 2h_0}{\Delta y^2} = 0 \quad (7.93)$$

If a grid is used to study the watertable elevation where the distance $\Delta x = \Delta y$, Equation 7.93 reduces to

$$h_0 = \frac{h_1 + h_2 + h_3 + h_4}{4}$$

To illustrate the use of the relaxation method, let us consider Figure 7.31, where there are twelve known groundwater levels at the boundary of a grid. To draw a family of equipotential lines as accurately as possible (watertable-contour map), we assign initially-estimated levels to the four central grid points.

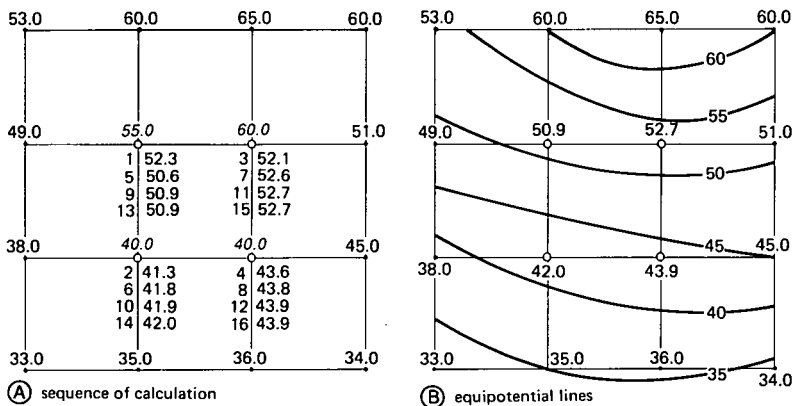

Figure 7.31 Illustration of the relaxation method

Subsequently, we use Equation 7.94 to improve the first estimate.

Hence

$$1 \rightarrow (60.0 + 60.0 + 49.0 + 40.0)/4 = 52.3$$

$$2 \rightarrow (40.0 + 52.3 + 38.0 + 35.0)/4 = 41.3$$

(Note that the level 55.0 is not used.)

$$3 \rightarrow (51.0 + 65.0 + 52.3 + 40.0)/4 = 52.1$$

$$4 \rightarrow (45.0 + 52.1 + 41.3 + 36.0)/4 = 43.6, \text{ and so on.}$$

As soon as the difference between the subsequent estimates becomes sufficiently small, we stop our calculations and use the final estimate to draw the equipotential lines (Figure 7.31B).

Working out these calculations on paper is, of course, laborious, but, fortunately nowadays, we can use a computer.

References

- Bos, M.G. (ed.) 1989. Discharge measurement structures. 3rd rev. ed. ILRI Publication 20, Wageningen, 320 p.
- Darcy, H. 1856. Les fontaines publiques de la Ville de Dijon. Dalmont, Paris. Republished in English in Ground Water, Journal Assoc. of Ground Water scientists and engineers, 2, pp. 260-261.
- Davis, S.N. 1969. Porosity and permeability of natural materials. In: R.J.M. de Wiest (ed.). Flow through porous media. Academic Press, New York, pp. 54-89.
- Forchheimer, P. 1930. Hydraulik. 3rd ed. Teubner, Leipzig-Berlin.
- Harr, M.E. 1962. Groundwater and seepage. McGraw Hill, New York, 315 p.
- Leliavsky, S. 1955. Irrigation and drainage design: General principles of hydraulic design. Chapman and Hall, London, 285 p.
- Leliavsky, S. 1965. Design of dams for percolation and erosion. Chapman and Hall, London, 285 p.
- Muskat, M. 1946. The flow of homogeneous fluids through porous media. McGraw Hill, New York, 763 p.
- Rouse, H. 1964. Engineering hydraulics. Wiley, New York, 1039 p.

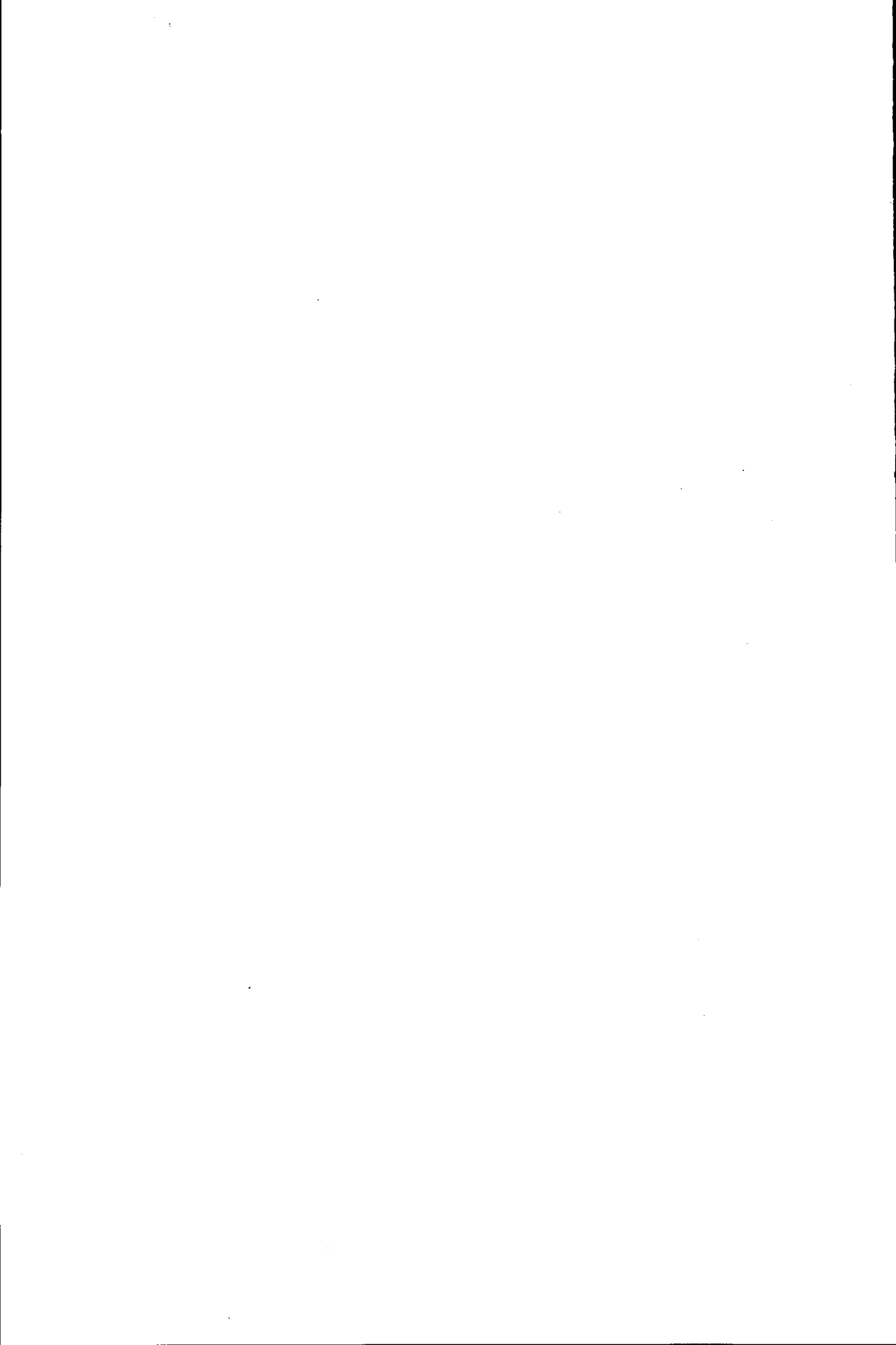

8 Subsurface Flow to Drains¹

H.P. Ritzema²

8.1 Introduction

In subsurface drainage, field drains are used to control the depth of the watertable and the level of salinity in the rootzone by evacuating excess groundwater. In this chapter, we shall use the principles of groundwater flow (Chapter 7) to describe the flow of groundwater towards the field drains. Our discussion will be restricted to parallel drains, which may be either open ditches or pipe drains. Relationships will be derived between the drain properties (diameter, depth, and spacing), the soil characteristics (profile and hydraulic conductivity), the depth of the watertable, and the corresponding discharge. To derive these relationships, we have to make several assumptions. It should be kept in mind that all the solutions are approximations; their accuracy, however, is such that their application in practice is fully justified.

We shall first discuss steady-state drainage equations (Section 8.2). These equations are based on the assumption that the drain discharge equals the recharge to the groundwater, and consequently that the watertable remains in the same position. In irrigated areas or areas with highly variable rainfall, these assumptions are not met and unsteady-state equations are sometimes more appropriate. Unsteady-state equations will be discussed in Section 8.3. In Section 8.4, we compare the steady-state approach with the unsteady state approach, and present a method in which the advantages of the two approaches are combined. Finally, in Section 8.5, we present some special drainage situations. (How the equations are to be applied in the design of subsurface drainage systems will be treated in Chapter 21.)

8.2 Steady-State Equations

In this section, we discuss the flow of groundwater to parallel field drains under steady-state conditions. This is the typical situation in areas with a humid climate and prolonged periods of fairly uniform, medium-intensity rainfall. The steady-state theory is based on the assumption that the rate of recharge to the groundwater is uniform and steady and that it equals the discharge through the drainage system. Thus, the watertable remains at the same height as long as the recharge continues.

Figure 8.1 shows two typical cross-sections of a drainage system under these conditions. Because the groundwater is under recharge from excess rainfall, excess irrigation, or upward seepage, the watertable is curved, its elevation being highest midway between the drains. Because of the symmetry of the system (Chapter 7, Section 7.7.2), we only have to consider one half of the figure.

To describe the flow of groundwater to the drains, we have to make the following assumptions:

¹ based on the work carried out by J. Wesseling

² International Institute for Land Reclamation and Improvement

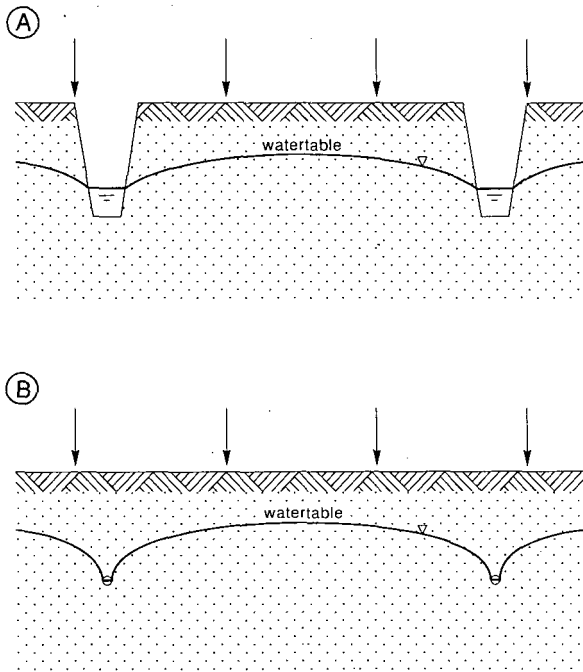

Figure 8.1 Cross-sections of open field drains (A) and pipe drains (B), showing a curved watertable under recharge from rainfall, irrigation, or upward seepage

- Two-dimensional flow. This means that the flow is considered to be identical in any cross-section perpendicular to the drains; this is only true for infinitely long drains;
- Uniform distribution of the recharge;
- Homogeneous and isotropic soils. We thus ignore any spatial variation in the hydraulic conductivity within a soil layer, although we can treat soil profiles consisting of two or more layers.

Most drainage equations are based on the Dupuit-Forchheimer assumptions (Chapter 7, Section 7.8.1). These allow us to reduce the two-dimensional flow to a one-dimensional flow by assuming parallel and horizontal stream lines. Such a flow pattern will occur as long as the impervious subsoil is close to the drain. The Hooghoudt Equation (Section 8.2.1) is based on these conditions. If the impervious layer does not coincide with the bottom of the drain, the flow in the vicinity of the drains will be radial and the Dupuit-Forchheimer assumptions cannot be applied. Hooghoudt solved this problem by introducing an imaginary impervious layer to take into account the extra head loss caused by the radial flow. Other approximate analytical solutions were derived by Kirkham and Dagan. Kirkham (1958) presented a solution based on the potential flow theory, which takes both the flow above and below drain level into account. Toksöz and Kirkham (1961) prepared nomographs that make it easier to apply the Kirkham Equation for design purposes. The Kirkham Equation can also be used to calculate drain spacings for layered soils (Toksöz and Kirkham 1971). For

the calculation of drain spacings in layered soils, Walczak et al. (1988) presented an algorithm based on the Kirkham Equation. Dagan (1964) considered radial flow close to the drain and horizontal flow further away from it. Ernst (Section 8.2.2) derived a solution for a soil profile consisting of more than one soil layer.

Of the above-mentioned equations, Hooghoudt's gives the best results (Lovell and Youngs 1984). Besides, whichever of the equations is used to calculate the drain spacings, the difference in the results will be minor in comparison with the accuracy of the input data (e.g. data on the hydraulic conductivity; see Chapter 12). We shall therefore concentrate on the Hooghoudt Equation and not further discuss the Kirkham and Dagan solutions. If, however, the soil profile consists of two or more layers with different hydraulic conductivities, we shall use the Ernst Equation.

8.2.1 The Hooghoudt Equation

Consider a steady-state flow to vertically-walled open drains reaching an impervious layer (Figure 8.2). According to the Dupuit-Forchheimer theory, Darcy's Equation can be applied to describe the flow of groundwater (q_x) through a vertical plane (y) at a distance (x) from the ditch

$$q_x = K y \frac{dy}{dx} \tag{8.1}$$

where

- q_x = unit flow rate in the x-direction (m^2/d)
- K = hydraulic conductivity of the soil (m/d)
- y = height of the watertable at x (m)
- $\frac{dy}{dx}$ = hydraulic gradient at x (-)

The continuity principle requires that all the water entering the soil in the surface area midway between the drains and the vertical plane (y) at distance (x) must pass

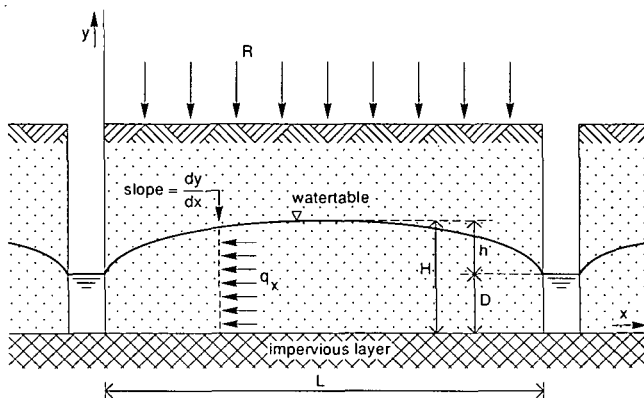

Figure 8.2 Flow to vertically-walled drains reaching the impervious layer

through this plane on its way to the drain. If R is the rate of recharge per unit area, then the flow per unit time through the plane (y) is

$$q_x = R \left(\frac{1}{2} L - x \right) \quad (8.2)$$

where

R = rate of recharge per unit surface area (m/d)

L = drain spacing (m)

Since the flow in the two cases must be equal, we can equate the right side of Equations 8.1 and 8.2

$$K y \frac{dy}{dx} = R \left(\frac{1}{2} L - x \right)$$

which can also be written as

$$K y dy = R \left(\frac{1}{2} L - x \right) dx$$

The limits of integration of this differential equation are

$$\text{for } x = 0 \rightarrow y = D$$

and

$$\text{for } x = \frac{1}{2} L \rightarrow y = H$$

where

D = elevation of the water level in the drain (m)

H = elevation of the watertable midway between the drains (m)

Integrating the differential equation and substituting the limits yields

$$L^2 = \frac{4 k (H^2 - D^2)}{R}$$

or

$$q = R = \frac{4 K (H^2 - D^2)}{L^2} \quad (8.3)$$

where

q = drain discharge (m/d)

This equation, which was derived by Hooghoudt in 1936, is also known as the Donnan Equation (Donnan 1946).

Equation 8.3 can be rewritten as

$$q = \frac{4 K (H + D) (H - D)}{L^2}$$

From Figure 8.2, it follows that $H - D = h$ and thus $H + D = 2D + h$, where h is the height of the watertable above the water level in the drain. Subsequently, Equation 8.3 changes to

$$q = \frac{8 K D h + 4 K h^2}{L^2} \tag{8.4}$$

If the water level in the drain is very low ($D \approx 0$), Equation 8.4 changes to

$$q = \frac{4 K h^2}{L^2} \tag{8.5}$$

This equation describes the flow above drain level.

If the impervious layer is far below drain level ($D \gg h$), the second term in the numerator of Equation 8.4 can be neglected, giving

$$q = \frac{8 K D h}{L^2} \tag{8.6}$$

This equation describes the flow below drain level.

These considerations lead to the conclusion that, if the soil profile consists of two layers with different hydraulic conductivities, and if the drain level is at the interface between the soil layers, Equation 8.4 can be written as

$$q = \frac{8 K_b D h + 4 K_t h^2}{L^2} \tag{8.7}$$

where

K_t = hydraulic conductivity of the layer above drain level (m/d)

K_b = hydraulic conductivity of the layer below drain level (m/d)

This situation is quite common, the soil above drain level often being more permeable

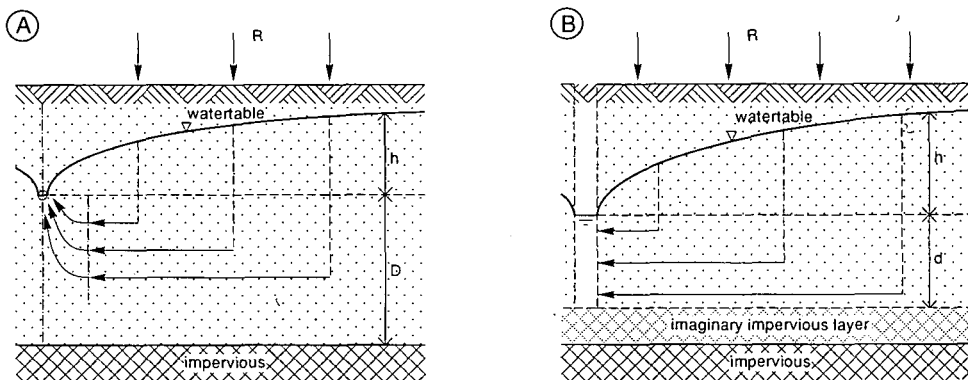

Figure 8.3 The concept of the equivalent depth, d , to transform a combination of horizontal and radial flow (A) into an equivalent horizontal flow (B)

than below drain level because the soil structure above drain level has been improved by:

- The periodic wetting and drying of the soil, resulting in the formation of cracks;
- The presence of roots, micro-organisms, micro-fauna, etc.

(This will be further elaborated in Chapter 12.)

If the pipe or open drains do not reach the impervious layer, the flow lines will converge towards the drain and will thus no longer be horizontal (Figure 8.3A). Consequently, the flow lines are longer and extra head loss is required to have the same volume of water flowing into the drains. This extra head loss results in a higher watertable.

To be able to use the concept of horizontal flow, Hooghoudt (1940) introduced two simplifications (Figure 8.3B):

- He assumed an imaginary impervious layer above the real one, which decreases the thickness of the layer through which the water flows towards the drains;
- He replaced the drains by imaginary ditches with their bottoms on the imaginary impervious layer.

Under these assumptions, we can still use Equation 8.4 to express the flow towards the drains, simply by replacing the actual depth to the impervious layer (D) with a smaller equivalent depth (d). This equivalent depth (d) represents the imaginary thinner soil layer through which the same amount of water will flow per unit time as in the actual situation. This higher flow per unit area introduces an extra head loss, which accounts for the head loss caused by the converging flow lines. Hence Equation 8.4 can be rewritten as

$$q = \frac{8 K d h + 4 K h^2}{L^2} \quad (8.8)$$

The only problem that remains is to find a value for the equivalent depth. On the basis of the method of 'mirror images', Hooghoudt derived a relationship between the equivalent depth (d) and, respectively, the spacing (L), the depth to the impervious layer (D), and the radius of the drain (r_0). This relationship, which is in the form of infinite series, is rather complex. Hooghoudt therefore prepared tables for the most common sizes of drain pipes, from which the equivalent depth (d) can be read directly. Table 8.1 (for $r_0 = 0.1$ m) is one such table.

As can be seen from this table, the value of d increases with D until $D \approx \frac{1}{4}L$. If the impervious layer is even deeper, the equivalent depth remains approximately constant; apparently the flow pattern is then no longer affected by the depth of the impervious layer.

Since the drain spacing L depends on the equivalent depth d , which in turn is a function of L , Equation 8.8 can only be solved by iteration. As this calculation method with the use of tables is rather time-consuming, Van Beers (1979) prepared nomographs from which d can easily be read.

Nowadays, with computers readily available, the Hooghoudt approximation method of calculating the equivalent depth can be replaced by exact solutions. A series solution developed by Van der Molen and Wesseling (1991) is presented here. Like Hooghoudt and Dagan, they analyzed the flow problem by the method of 'mirror

Table 8.1 Values for the equivalent depth d of Hooghoudt for $r_0 = 0.1$ m, D and L in m (Hooghoudt 1940)

L →	5 m	7.5	10	15	20	25	30	35	40	45	50	L →	50	75	80	85	90	100	150	200	250	
D												D										
0.5 m	0.47	0.48	0.49	0.49	0.49	0.50	0.50	0.50	0.50	0.50	0.50	0.5	0.50	0.50	0.50	0.50	0.50	0.50	0.50	0.50	0.50	0.50
0.75	0.60	0.65	0.69	0.71	0.73	0.74	0.75	0.75	0.75	0.76	0.76	1	0.96	0.97	0.97	0.97	0.98	0.98	0.99	0.99	0.99	0.99
1.00	0.67	0.75	0.80	0.86	0.89	0.91	0.93	0.94	0.96	0.96	0.96	2	1.72	1.80	1.82	1.82	1.83	1.85	1.00	1.92	1.94	1.94
1.25	0.70	0.82	0.89	1.00	1.05	1.09	1.12	1.13	1.14	1.14	1.15	3	2.29	2.49	2.52	2.54	2.56	2.60	2.72	2.70	2.83	2.83
1.50	0.70	0.88	0.97	1.11	1.19	1.25	1.28	1.31	1.34	1.35	1.36	4	2.71	3.04	3.08	3.12	3.16	3.24	3.46	3.58	3.66	3.66
1.75	0.70	0.91	1.02	1.20	1.30	1.39	1.45	1.49	1.52	1.55	1.57	5	3.02	3.49	3.55	3.61	3.67	3.78	4.12	4.31	4.43	4.43
2.00	0.70	0.91	1.08	1.28	1.41	1.5	1.57	1.62	1.66	1.70	1.72	6	3.23	3.85	3.93	4.00	4.08	4.23	4.70	4.97	5.15	5.15
2.25	0.70	0.91	1.13	1.34	1.50	1.69	1.69	1.76	1.81	1.84	1.86	7	3.43	4.14	4.23	4.33	4.42	4.62	5.22	5.57	5.81	5.81
2.50	0.70	0.91	1.13	1.38	1.57	1.69	1.79	1.87	1.94	1.99	2.02	8	3.56	4.38	4.49	4.61	4.72	4.95	5.68	6.13	6.43	6.43
2.75	0.70	0.91	1.13	1.42	1.63	1.76	1.88	1.98	2.05	2.12	2.18	9	3.66	4.57	4.70	4.82	4.95	5.23	6.09	6.63	7.00	7.00
3.00	0.70	0.91	1.13	1.45	1.67	1.83	1.97	2.08	2.16	2.23	2.29	10	3.74	4.74	4.89	5.04	5.18	5.47	6.45	7.09	7.53	7.53
3.25	0.70	0.91	1.13	1.48	1.71	1.88	2.04	2.16	2.26	2.35	2.42	12.5	3.74	5.02	5.20	5.38	5.56	5.92	7.20	8.06	8.68	8.68
3.50	0.70	0.91	1.13	1.50	1.75	1.93	2.11	2.24	2.35	2.45	2.54	15	3.74	5.20	5.40	5.60	5.80	6.25	7.77	8.84	9.64	9.64
3.75	0.70	0.91	1.13	1.52	1.78	1.97	2.17	2.31	2.44	2.54	2.64	17.5	3.74	5.30	5.53	5.76	5.99	6.44	8.20	9.47	10.4	10.4
4.00	0.70	0.91	1.13	1.52	1.81	2.02	2.22	2.37	2.51	2.62	2.71	20	3.74	5.30	5.62	5.87	6.12	6.60	8.54	9.97	11.1	11.1
4.50	0.70	0.91	1.13	1.52	1.85	2.08	2.31	2.50	2.63	2.76	2.87	25	3.74	5.30	5.74	5.96	6.20	6.79	8.99	10.7	12.1	12.1
5.00	0.70	0.91	1.13	1.52	1.88	2.15	2.38	2.58	2.75	2.89	3.02	30	3.74	5.30	5.74	5.96	6.20	6.79	9.27	11.3	12.9	12.9
5.50	0.70	0.91	1.13	1.52	1.88	2.20	2.43	2.65	2.84	3.00	3.15	35	3.74	5.30	5.74	5.96	6.20	6.79	9.44	11.6	13.4	13.4
6.00	0.70	0.91	1.13	1.52	1.88	2.20	2.48	2.70	2.92	3.09	3.26	40	3.74	5.30	5.74	5.96	6.20	6.79	9.44	11.8	13.8	13.8
7.00	0.70	0.91	1.13	1.52	1.88	2.20	2.54	2.81	3.03	3.24	3.43	45	3.74	5.30	5.74	5.96	6.20	6.79	9.44	12.0	13.8	13.8
8.00	0.70	0.91	1.13	1.52	1.88	2.20	2.57	2.85	3.13	3.35	3.56	50	3.74	5.30	5.74	5.96	6.20	6.79	9.44	12.1	14.3	14.3
9.00	0.70	0.91	1.13	1.52	1.88	2.20	2.57	2.89	3.18	3.43	3.66	60	3.74	5.30	5.74	5.96	6.20	6.79	9.44	12.1	14.6	14.6
10.00	0.70	0.91	1.13	1.52	1.88	2.20	2.57	2.89	3.23	3.48	3.74	∞	3.88	5.38	5.76	6.00	6.26	6.82	9.55	12.2	14.7	14.7
∞	0.71	0.93	1.14	1.53	1.89	2.24	2.58	2.91	3.24	3.56	3.88											

images', resulting in an exact solution for d

$$d = \frac{\frac{\pi L}{8}}{\ln \frac{L}{\pi r_0} + F(x)} \quad (8.9)$$

where

$$x = \frac{2 \pi D}{L} \quad (8.10)$$

and

$$F(x) = 2 \sum_{n=1}^{\infty} \ln \coth (nx) \quad (8.11)$$

The function $F(x)$, which represents an infinite series of logarithms, can be modified to

$$F(x) = \sum_{n=1}^{\infty} \frac{4 e^{-2nx}}{n (1 - e^{-2nx})} \quad (n = 1, 3, 5, \dots) \quad (8.12)$$

which converges rapidly for $x > 1$. For $x \ll 1$, convergence is slow, but for this case (i.e. $x \leq 0.5$), a comparison with Dagan's formula results in an approximation that is highly accurate

$$F(x) = \frac{\pi^2}{4x} + \ln \frac{x}{2\pi} \quad (8.13)$$

The exact solution presented in Equations 8.9 to 8.13 can easily be used in computer calculations. A flow chart, based on this solution, is presented in Figure 8.4.

Two assumptions on which Hooghoudt based his theory have not yet been mentioned. They are:

- The drains are running half-full;
- The drains have no entrance resistance.

These assumptions imply that the entrance area, u , equals the wet perimeter of a semi-circle (the πr_0 in Equation 8.9), so that

$$r_0 = \frac{u}{\pi} \quad (8.14)$$

where

- r_0 = the radius of the drain (m)
- u = the wet perimeter (m)

For open drains, the equivalent radius (r_0) can be calculated by substituting the wet perimeter of the open drain for u in Equation 8.14. For pipe drains laid in trenches, the wet perimeter is taken as

$$u = b + 2 r_0 \quad (8.15)$$

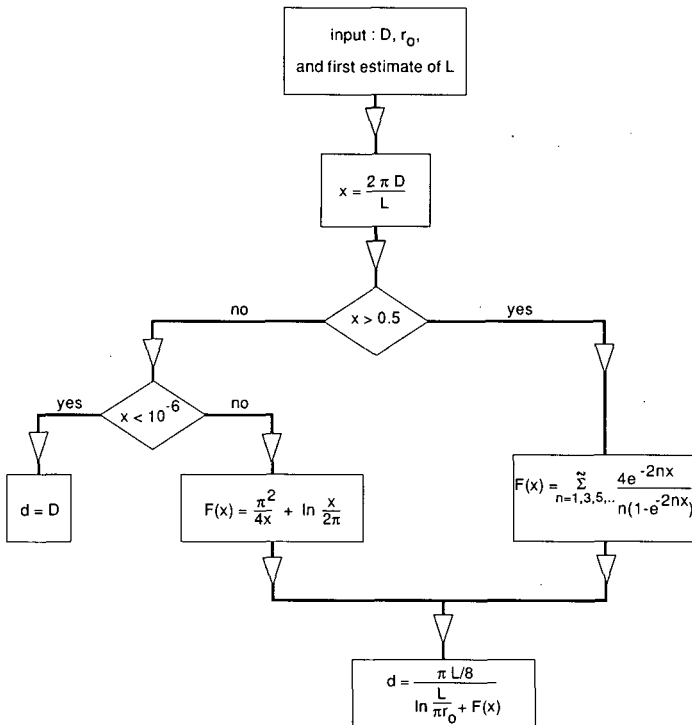

Figure 8.4 Flow chart for the calculation of Hooghoudt's equivalent depth

where

b = the width of the trench (m)

If an envelope material is used around the pipe drain (Figure 8.5), Equation 8.15 changes to

$$u = b + 2(2r_0 + m) \quad (8.16)$$

where

m = the height of the envelope above the drain (m)

The second assumption (no entrance resistance) means that we are assuming an ideal drain. This is correct as long as the hydraulic conductivity of the drain trench is at least 10 times higher than that of the undisturbed soil outside the trench (Smedema and Rycroft 1983). If the hydraulic conductivity is less, an envelope material can be used to decrease the entrance resistance, so that a greater part of the total head will be available for the flow through the soil. If it is not possible to use an envelope material, the entrance resistance should be introduced into the equations by replacing h with $(h - h_e)$, in which h_e is the entrance head loss in metres. The entrance resistance and the use of envelopes will be further discussed in Chapter 21.

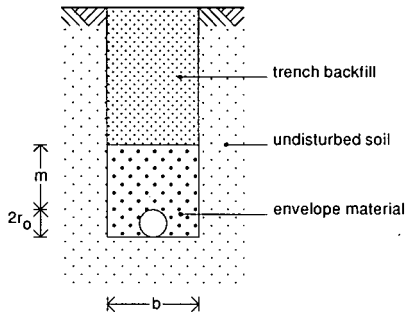

Figure 8.5 Drain pipe with gravel envelope in drain trench

8.2.2 The Ernst Equation

So far, we have only discussed solutions that can be applied for a homogeneous soil profile, or for a two-layered soil profile provided that the interface between the two layers coincides with the drain level. The Ernst Equation is applicable to any type of two-layered soil profile. It has the advantage over the Hooghoudt Equation that the interface between the two layers can be either above or below drain level. It is especially useful when the top layer has a considerably lower hydraulic conductivity than the bottom layer.

To obtain a generally applicable solution for soil profiles consisting of layers with different hydraulic conductivities, Ernst (1956; 1962) divided the flow to the drains into a vertical, a horizontal, and a radial component (Figure 8.6). Consequently, the total available head (h) can be divided into a head loss caused by the vertical flow (h_v), the horizontal flow (h_h), and the radial flow (h_r)

$$h = h_v + h_h + h_r \quad (8.17)$$

Vertical Flow

Vertical flow is assumed to take place in the layer between the watertable and the

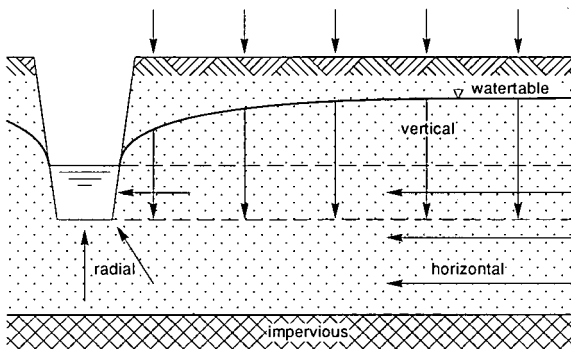

Figure 8.6 Geometry of two-dimensional flow towards drains, according to Ernst

drain level (Figure 8.6). We can obtain the head loss caused by this vertical flow by applying Darcy's Law (Chapter 7, Section 7.4)

$$q = K_v \frac{h_v}{D_v}$$

or

$$h_v = q \frac{D_v}{K_v} \quad (8.18)$$

where

D_v = thickness of the layer in which vertical flow is considered (m)

K_v = vertical hydraulic conductivity (m/d)

As the vertical hydraulic conductivity is difficult to measure under field conditions, it is often replaced by the horizontal hydraulic conductivity, which is rather easy to measure with the auger-hole method (Chapter 12). In principle, this is not correct, especially not in alluvial soils where great differences between horizontal and vertical conductivity may occur. The vertical head loss, however, is generally small compared with the horizontal and radial head losses, so the error introduced by replacing K_v with K_h can be neglected.

Horizontal Flow

The horizontal flow is assumed to take place below drain level (Figure 8.6). Analogous to Equation 8.6, the horizontal head loss h_h can be described by

$$h_h = q \frac{L^2}{8 \Sigma (KD)_h} \quad (8.19)$$

where

$\Sigma(KD)_h$ = transmissivity of the soil layers through which the water flows horizontally (m^2/d)

If the impervious layer is very deep, the value of $\Sigma(KD)_h$ increases to infinity and consequently the horizontal head loss decreases to zero. To prevent this, the maximum thickness of the soil layer below drain level through which flow is considered (ΣD_h) is restricted to $\frac{1}{4}L$.

Radial Flow

The radial flow is also assumed to take place below drain level (Figure 8.6). The head loss caused by the radial flow can be expressed as

$$h_r = q \frac{L}{\pi K_r} \ln \frac{a D_r}{u} \quad (8.20)$$

where

K_r = radial hydraulic conductivity (m/d)

a = geometry factor of the radial resistance (-)

D_r = thickness of the layer in which the radial flow is considered (m)

u = wet perimeter of the drain (m)

This equation has the same restriction for the depth of the impervious layer as the equation for horizontal flow (i.e. $D_r < \frac{1}{4}L$).

The geometry factor (a) depends on the soil profile and the position of the drain. In a homogeneous soil profile, the geometry factor equals one; in a layered soil, the geometry factor depends on whether the drains are in the top or bottom soil layer. If the drains are in the bottom layer, the radial flow is assumed to be restricted to this layer, and again $a = 1$. If the drains are in the top layer, the value of a depends on the ratio of the hydraulic conductivity of the bottom (K_b) and top (K_t) layer. Using the relaxation method, Ernst (1962) distinguished the following situations:

- $\frac{K_b}{K_t} < 0.1$: the bottom layer can be considered impervious and the case is reduced to a homogeneous soil profile and $a = 1$;
- $0.1 < \frac{K_b}{K_t} < 50$: a depends on the ratios $\frac{K_b}{K_t}$ and $\frac{D_b}{D_t}$, as given in Table 8.2;
- $\frac{K_b}{K_t} > 50$: $a = 4$.

The expressions for, respectively, the vertical flow (Equation 8.18), the horizontal flow (Equation 8.19), and the radial flow (Equation 8.20) can now be substituted into Equation 8.17

$$h = q \frac{D_v}{K_v} + q \frac{L^2}{8 \Sigma (KD)_h} + q \frac{L}{\pi K_r} \ln \frac{a D_r}{u}$$

or

$$h = q \left(\frac{D_v}{K_v} + \frac{L^2}{8 \Sigma (KD)_h} + \frac{L}{\pi K_r} \ln \frac{a D_r}{u} \right) \quad (8.21)$$

This equation is generally known as the Ernst Equation. If the design discharge rate

Table 8.2 The geometry factor (a) obtained by the relaxation method (after Van Beers 1979)

$\frac{K_b}{K_t}$	$\frac{D_b}{D_t}$					
	1	2	4	8	16	32
1	2.0	3.0	5.0	9.0	15.0	30.0
2	2.4	3.2	4.6	6.2	8.0	10.0
3	2.6	3.3	4.5	5.5	6.8	8.0
5	2.8	3.5	4.4	4.8	5.6	6.2
10	3.2	3.6	4.2	4.5	4.8	5.0
20	3.6	3.7	4.0	4.2	4.4	4.6
50	3.8	4.0	4.0	4.0	4.2	4.6

(q) and the available total hydraulic head (h) are known, this quadratic equation for the spacing (L) can be solved directly.

8.2.3 Discussion of Steady-State Equations

It should be clear from the previous sections that, when we are selecting the most appropriate steady-state equation, two important factors to be considered are the soil profile and the relative position of the drains in that profile. In this section, we shall discuss some of the more common field situations and select the appropriate equation for each of them. The results are summarized in Figure 8.7. In all cases, the lower boundary is formed by an impervious layer.

Homogeneous Soils

For a homogeneous soil, the position of the drain determines which equation should be used:

SCHEMATIZATION	SOIL PROFILE	POSITION OF DRAIN	THEORY	EQUATION
	homogeneous	on top of impervious layer	Hooghoudt/Donnan	$q = \frac{4K(H-D)^2}{L^2}$
	homogeneous	above impervious layer	Hooghoudt with equivalent depth	$q = \frac{8Kdh + 4Kh^2}{L^2}$
	two layers	at interface of the two soil layers	Hooghoudt	$q = \frac{8K_bdh + 4K_1h^2}{L^2}$
	two layers (K1 < Kb)	in bottom layer	Ernst	$h = q \left(\frac{D_v}{K_1} + \frac{L^2}{8K_bD_b} + \frac{L}{\pi K_b} \ln \frac{D_r}{u} \right)$
	two layers (K1 < Kb)	in top layer	Ernst	$h = q \left(\frac{D_v}{K_1} + \frac{L^2}{8(K_bD_b + K_1D_1)} + \frac{L}{\pi K_1} \ln \frac{aD_r}{u} \right)$

Figure 8.7 Summary of the steady-state equations

- If the drains are placed on top of the impervious layer, we can use Equation 8.3 to calculate the drain spacing;
- If the drains are in the region above the impervious layer, we can use either Hooghoudt and the equivalent depth (Equation 8.8), or Ernst (Equation 8.21). The latter has the restriction that the depth of the impervious layer should not exceed $\frac{1}{4}L$. For deeper impervious layers, the spacings calculated with the Ernst Equation are generally too small. Since the drain spacing is not known beforehand, this condition has to be checked afterwards. For this type of soil profile, the Ernst Equation gives approximately the same result as the Hooghoudt Equation. We therefore recommend the use of the Hooghoudt Equation because then we do not have the restriction in depth.

Two-Layered Soil Profile

For a two-layered soil profile, we can distinguish three situations, depending on the position of the drains:

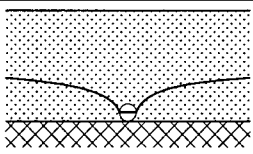
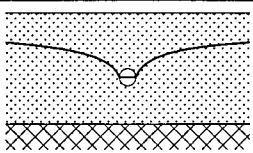
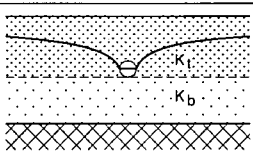
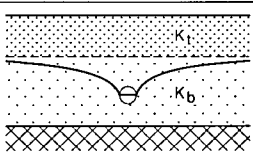
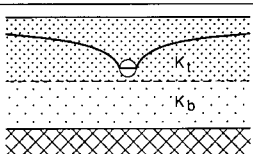
- 1) The drains are at the interface of the two layers;
- 2) The drains are in the bottom soil layer;
- 3) The drains are in the top soil layer.

If the drains are located at the interface of the two layers (Situation 1), we can use the Hooghoudt Equation (Equation 8.7), which differentiates hydraulic conductivity above and below drain level.

If the drains are situated either above or below the interface of the two soil layers (Situation 2 or 3), the hydraulic conductivities cannot be differentiated in the same way and we have to apply Ernst (Equation 8.21). If, however, the bottom layer has a significantly lower hydraulic conductivity than the top layer, we can regard the bottom layer as impervious and simplify the problem to a one-layered profile underlain by an impervious layer. In this case, we can apply Hooghoudt without introducing large errors. Thus Ernst is used mainly for a two-layered soil profile when the top layer has a lower hydraulic conductivity than the bottom layer ($K_t < K_b$).

If the drains are situated in the bottom soil layer (Situation 2 and Figure 8.8A), we can make the following simplifications:

- We can neglect the vertical resistance in the bottom layer compared with the vertical resistance in the top layer, because the hydraulic conductivity in the bottom layer is higher than in the top layer;
- We can neglect the transmissivity of the top layer, because $K_t < K_b$, and in general also $D_t < D_b$. Thus in Equation 8.19, $\Sigma(KD)_h$ can be replaced by $K_b D_b$;
- The radial flow is restricted to the layer below drain level (D_r) and thus $a = 1$.

Hence Equation 8.21 is reduced to

$$h = q \left(\frac{D_v}{K_t} + \frac{L^2}{8 K_b D_b} + \frac{L}{\pi K_b} \ln \frac{D_r}{u} \right) \quad (8.22)$$

If the drains are situated in the top layer (Situation 3 and Figure 8.8B):

- There is no vertical flow in the bottom layer; so $D_v = h$;

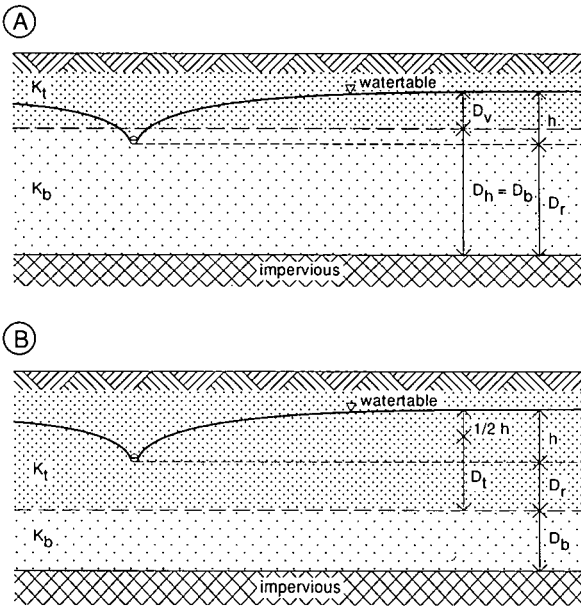

Figure 8.8 Geometry of the Ernst Equation for a two-layered soil with the drain in the bottom layer (A) and in the top layer (B)

- When considering the horizontal flow, however, we cannot neglect the transmissivity of the top layer, and $\Sigma(KD)_h = K_b D_b + K_t D_t$, in which $D_t = D_r + \frac{1}{2}h$;
- The radial flow is restricted to the region in the top soil layer below drain level and the geometry factor depends on the ratio of the hydraulic conductivity of the top and bottom layer, as was discussed in Section 8.2.2.

In this case, Equation 8.21 can be reduced to

$$h = q \left(\frac{D_v}{K_t} + \frac{L^2}{8 (K_b D_b + K_t D_t)} + \frac{L}{\pi K_t} \ln \frac{a D_r}{u} \right) \quad (8.23)$$

8.2.4 Application of Steady-State Equations

To calculate the drain spacing with steady-state equations, we must have information on the soil characteristics, the agricultural design criteria, and the technical criteria. The required soil data include a description of the soil profile, the depth of the impervious layer, and the hydraulic conductivity. (For methods to obtain these data, see Chapters 2, 3, and 12.)

The agricultural design criteria are the required depth of the watertable (h) and the corresponding design discharge (q). They depend on many factors (e.g. the type of crop, the climate). The ratio q/h is sometimes called the drainage criterion or drainage intensity. The higher the q/h ratio, the more safety is built into the system to prevent high watertables. As the purpose of this section is to demonstrate the use

of the steady-state equations, the drainage criteria will not be further elaborated here. (For them, see Chapter 17.)

Finally, we must know the technical criteria such as the drain depth (which depends on the selected construction method and the available machinery) and the drain specifications (r_0 and u). (These technical criteria will be discussed in Chapter 21.)

Example 8.1

In an agricultural area, high watertables occur. A subsurface drainage system is to be installed to control the watertable under the following conditions:

Agricultural drainage criteria:

- Design discharge rate is 1 mm/d;
- The depth of the watertable midway between the drains is to be kept at 1.0 m below the soil surface.

Technical Criteria:

- Drains will be installed at a depth of 2 m;
- PVC drain pipes with a radius of 0.10 m will be used.

A deep augering revealed that there is a layer of low conductivity at 6.8 m, which can be regarded as the base of the flow region (Figure 8.9). Auger-hole measurements were made to calculate the hydraulic conductivity of the soil above the impervious layer. Its average value was found to be 0.14 m/d.

If we assume a homogeneous soil profile, we can use the Hooghoudt Equation (Equation 8.8) to calculate the drain spacing. We have the following data:

$$q = 1 \text{ mm/d} = 0.001 \text{ m/d}$$

$$h = 2.0 - 1.0 = 1.0 \text{ m}$$

$$r_0 = 0.10 \text{ m}$$

$$K = 0.14 \text{ m/d}$$

$$D = 6.8 - 2.0 = 4.8 \text{ m}$$

Substitution of the above values into Equation 8.8 yields

$$L^2 = \frac{8 K d h + 4 K h^2}{q} = \frac{8 \times 0.14 \times d \times 1.0 + 4 \times 0.14 \times 1.0^2}{0.001}$$

$$L^2 = 1120 d + 560$$

As the equivalent depth, d , is a function of L (among other things), we can only solve this quadratic equation for L by trial and error.

First estimate: $L = 75 \text{ m}$. We can read the equivalent depth, d , from Table 8.1

$$d = 3.04 + \frac{8}{10}(3.49 - 3.04) = 3.40 \text{ m}$$

Thus, $L^2 = 1120 \times 3.40 + 560 = 4368 \text{ m}^2$. This is not in agreement with $L^2 = 75^2 = 5625 \text{ m}^2$. Apparently, the spacing of 75 m is too wide.

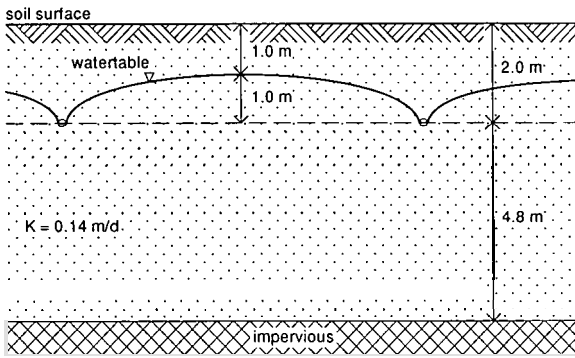

Figure 8.9 The calculation of the drain spacing in a one-layered soil profile (Example 8.1)

Second estimate: $L = 50$ m. We can read d from Table 8.1

$$d = 2.71 + \frac{8}{10}(3.02 - 2.71) = 2.96 \text{ m}$$

Thus, $L^2 = 1120 \times 2.96 + 560 = 3875 \text{ m}^2$. This is not in agreement with $L^2 = 50^2 = 2500 \text{ m}^2$. Thus a spacing of 50 m is too narrow.

Third estimate: $L = 65$ m:

$$d_{65} = d_{50} + \frac{15}{25}(d_{75} - d_{50}) = 2.96 + \frac{15}{25}(3.40 - 2.96) = 3.22$$

Thus $L^2 = 1120 \times 3.22 + 560 = 4171 \text{ m}^2$. This is sufficiently close to $L^2 = 65^2 = 4225 \text{ m}^2$. So we can select a spacing of 65 m.

Note: The series solution presented in Figure 8.4 results in a spacing of 64 m.

Example 8.2

Suppose that the area will be drained by ditches instead of pipe drains. The open drains will have a depth of 2.5 m, a bottom width of 0.5 m, and side slopes of 1:1. The design water depth in the ditches is 0.5 m; so the water level in the drain is 2.00 m below soil surface. What will be the drain spacing?

The wet perimeter, u , will be

$$u = 0.5 + 2 \times \sqrt{(0.5^2 + 0.5^2)} = 1.91 \text{ m}$$

and consequently the equivalent radius (Equation 8.14)

$$r_0 = \frac{u}{\pi} = \frac{1.91}{\pi} = 0.61$$

We have the same data as in Example 8.1, except now $r_0 = 0.61$ m instead of 0.10

m. As in Example 8.1, we shall use Hooghoudt (Equation 8.8) to calculate the spacing, and we also find

$$L^2 = 1120 d + 560$$

The table prepared by Hooghoudt (1940) to calculate the equivalent depth for $r_0 = 0.60$ m is not given in this publication, so we have to apply the solution as presented in Figure 8.4:

First estimate: $L = 72$ m

$$\text{Equation 8.10: } x = \frac{2\pi D}{L} = \frac{2\pi \times 4.8}{72} = 0.42$$

$$\text{Equation 8.13: } F(x) = \frac{\pi^2}{4x} + \ln \frac{x}{2\pi} = \frac{\pi^2}{4 \times 0.42} + \ln \frac{0.42}{2\pi} = 3.17$$

$$\text{Equation 8.9: } d = \frac{\frac{\pi L}{8}}{\ln \frac{L}{\pi r_0} + F(x)} = \frac{\frac{\pi \times 72}{8}}{\ln \frac{72}{\pi \times 0.61} + 3.17} = 4.16$$

Thus, $L^2 = 1120 \times 4.16 + 560 = 5221$, which is sufficiently close to $L^2 = 72^2 = 5184$, so we can select a spacing of 72 m.

Comparing Examples 8.1 and 8.2 clearly shows the influence of the radial flow: for the open drain, the equivalent drain radius is much larger than for the pipe drain, thereby reducing the radial head loss and allowing a wider spacing. This example also shows the benefit of the exact solution. If the flow chart in Figure 8.4 is converted into a simple computer or spreadsheet program, there is no need to use tables to find an approximate solution for d . (Hooghoudt prepared tables for 31 different situations.)

Example 8.3

For the same area as in Example 8.1, a more detailed soil survey revealed that the soil profile is not homogeneous, but consists of two distinct layers: a top layer of 2.0 m with a hydraulic conductivity of 0.06 m/d, and a bottom layer of 4.8 m with a hydraulic conductivity of 0.30 m/d (Figure 8.10).

The agricultural and technical criteria remain the same. Hence, we have the following information:

$$\begin{aligned} q &= 1 \text{ mm/d} = 0.001 \text{ m/d} \\ h &= 2.0 - 1.0 = 1.0 \text{ m} \\ r_0 &= 0.10 \text{ m} \\ K_t &= 0.06 \text{ m/d} \\ K_b &= 0.30 \text{ m/d} \\ D &= 6.8 - 2.0 = 4.8 \text{ m} \end{aligned}$$

Again the drain spacing can be calculated with the Hooghoudt Equation, because

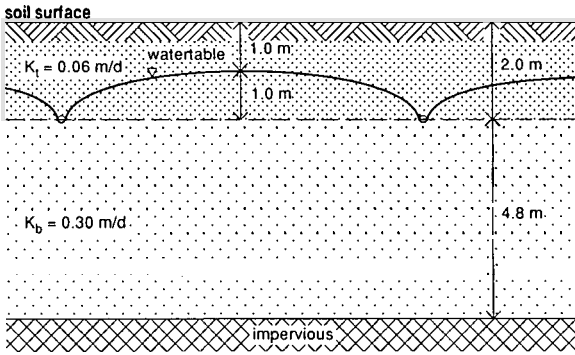

Figure 8.10 The calculation of drain spacing in a two-layered soil profile with the drains at the interface (Example 8.3)

the drain level is at the interface of the two soil layers. Applying Equation 8.7, in which we replace D by d

$$L^2 = \frac{8 K_b d h + 4 K_t h^2}{q} = \frac{8 \times 0.30 \times d \times 1.0 + 4 \times 0.06 \times 1.0^2}{0.001}$$

$$L^2 = 2400 d + 240$$

First estimate: $L = 100$ m, $D = 4.80$ m. From Table 8.1, we read

$$d = 3.24 + \frac{8}{10}(3.78 - 3.24) = 3.67$$

$$L^2 = 2400 \times 3.67 + 240 = 9048 \text{ m}^2$$

Check: $L^2 = 100^2 = 10\,000 \text{ m}^2$, so spacing is too wide.

Second estimate: $L = 90$ m, $D = 4.80$ m. From Table 8.1, we read

$$d = 3.16 + \frac{8}{10}(3.67 - 3.16) = 3.57$$

$$L^2 = 2400 \times 3.57 + 240 = 8808 \text{ m}^2$$

Check: $L^2 = 90^2 = 8100 \text{ m}^2$, so spacing is too narrow.

Third estimate: $L = 95$ m, $D = 4.80$ m

$$d = \frac{d_{100} + d_{90}}{2} = \frac{3.67 + 3.57}{2} = 3.62$$

$$L^2 = 2400 \times 3.62 + 240 = 8928 \text{ m}^2$$

Check: $L^2 = 95^2 = 9025 \text{ m}^2$, so okay.

Hence, the required drain spacing is 95 m.

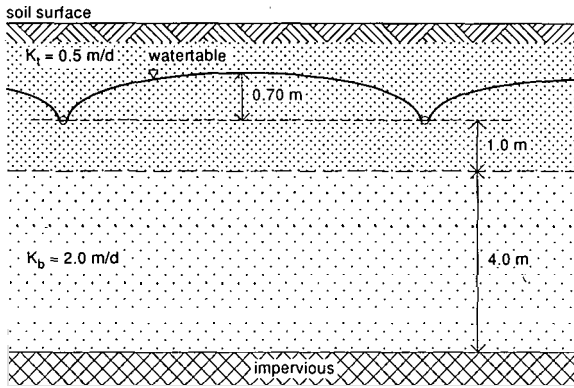

Figure 8.11 The calculation of drain spacing in a two-layered soil profile with the drains in the top layer (Example 8.4)

We can see that the last term in the equation $L^2 = 2400 d + 240$, which represents the flow above the drain, is small. If we neglect the flow above drain level, we obtain

$$L^2 = 2400 d \text{ or } L = \sqrt{2400 \times 3.62} = 93 \text{ m}$$

If we compare Example 8.3 with Example 8.1, we see that the soil data, i.e. the assumptions made for the soil profile and the hydraulic conductivity, have major influence on the calculated drain spacing. Thus a good estimate of this soil data is of utmost importance.

Example 8.4

An area has a soil profile consisting of two distinct layers. Pipe drains with a diameter of 0.1 m will be installed in the top layer, 1.0 m above the interface between the two layers (Figure 8.11). We have the following data:

$$\begin{aligned} q &= 0.007 \text{ m/d} \\ h &= 0.70 \text{ m} \\ K_t &= 0.5 \text{ m/d} \\ K_b &= 2.0 \text{ m/d} \\ D_0 &= 1.0 \text{ m} \\ D_b &= 4.0 \text{ m} \\ r_0 &= 0.05 \text{ m} \end{aligned}$$

It is a two-layered soil profile and the drains are not installed at the interface of the layers, so we have to apply the Ernst Equation. As the drains are situated in the top soil layer, we can use Equation 8.23 to calculate the drain spacing.

We know that:

$$D_v = h = 0.70 \text{ m}$$

$$D_r = D_0 = 1.0 \text{ m}$$

$$D_t = D_r + \frac{1}{2}h = 1.00 + \frac{1}{2} \times 0.70 = 1.35 \text{ m}$$

$$\frac{K_b}{K_t} = \frac{2.0}{0.5} = 4$$

$$\frac{D_b}{D_t} = \frac{4.0}{1.35} = 3$$

Now we can read the geometry factor (a) from Table 8.2, interpolating linearly

$$a = \frac{3.3 + 3.5 + 4.5 + 4.4}{4} = 3.9$$

$$K_b D_b + K_t D_t = 2.0 \times 4.0 + 0.5 \times 1.35 = 8.68 \text{ m}^2/\text{d}$$

$$u = \pi r_0 = \pi \times 0.05 = 0.157 \text{ m}$$

so

$$h = q \left(\frac{D_v}{K_t} + \frac{L^2}{8(K_b D_b + K_t D_t)} + \frac{L}{\pi K_t} \ln \frac{a D_r}{u} \right)$$

$$h = 0.007 \left(\frac{0.70}{0.5} + \frac{L^2}{8 \times 8.68} + \frac{L}{\pi \times 0.5} \ln \frac{3.9 \times 1.0}{0.157} \right)$$

$$h = 0.70 = 0.007 (1.40 + 0.014 L^2 + 2.045 L)$$

thus: $0.014 L^2 + 2.045 L - 98.6 = 0$

or

$$L = \frac{-2.045 + \sqrt{2.045^2 + 4 \times 0.014 \times 98.6}}{2 \times 0.014} = 38 \text{ m}$$

Check

D_b (4.0 m) and D_r (1.0 m) are both smaller than $\frac{1}{4} L$ (10 m), so the use of the Ernst Equation is justified.

Note: the vertical, horizontal, and radial flow head losses are, respectively

$$h_v = 0.007 \frac{0.70}{0.5} = 0.01 \text{ m}$$

$$h_h = 0.007 \frac{38^2}{8 \times 8.68} = 0.15 \text{ m}$$

$$h_r = 0.007 \frac{38}{\pi \times 0.5} \ln \frac{3.9 \times 1.0}{0.157} = 0.54 \text{ m}$$

Thus the radial flow component is by far the most important one and the vertical flow component can easily be neglected.

8.3 Unsteady-State Equations

The steady-state approach only describes a simplified, constant relationship between the watertable and the discharge. In reality, the recharge to the watertable varies with

time, and consequently the flow of groundwater towards the drains is not steady. To describe the fluctuation of the watertable as a function of time, we use the unsteady-state approach. Unsteady-state equations are based on the differential equations for unsteady flow. Both the unsteady-state and the steady-state approach are based on the same (Dupuit-Forchheimer) assumptions. The only difference is the recharge, which in the unsteady-state approach varies with time.

The Glover-Dumm Equation (Section 8.3.1) is used to describe a falling watertable after its sudden rise due to an instantaneous recharge. This is the typical situation in irrigated areas where the watertable often rises sharply during the application of irrigation water and then recedes more slowly.

The De Zeeuw-Hellinga Equation (Section 8.3.2) is used to describe a fluctuating watertable. In this approach, a non-uniform recharge is divided into shorter time periods in which the recharge to the groundwater can be assumed to be constant. This is the typical situation for humid areas with high-intensity rainfall concentrated in discrete storms.

The Kraijenhoff van de Leur-Maasland Equation (Kraijenhoff van de Leur 1958, 1962; Maasland 1959), which is used to describe unsteady flow to drains with a steady recharge instead of an instantaneous recharge, is mainly used for research purposes and is beyond the scope of this book.

8.3.1 The Glover-Dumm Equation

In the case of unsteady (or transient) flow, the flow is not constant, but changes with time as water is stored in, or released from, the soil. The change in storage is reflected either in a rise or a fall of the watertable. Again the Dupuit-Forchheimer approach can be used to derive a differential equation of unsteady flow. Analogous to Chapter 7 (Section 7.8.1), we consider a soil column which is bounded by the watertable at the top and by an impervious layer at the bottom. If there is no recharge to the groundwater the change in storage in the soil profile is given by (Figure 8.12):

$$\Delta W = \mu \Delta h \, dx \, dy \quad (8.24)$$

where

ΔW = change in water storage per unit surface area over the time considered (m)

μ = drainable pore space (-)

Δh = change in the level of the watertable over the time considered (m)

The change in storage considered over an infinitely small period of time, dt , is

$$dW = \mu \frac{\partial h}{\partial t} \, dx \, dy \quad (8.25)$$

The continuity principle now requires that the total difference of outgoing minus incoming flow in x - and y -directions equals the change in storage. Hence the continuity equation can be written as

$$-K \left[\frac{\partial}{\partial x} \left(h \frac{\partial h}{\partial x} \right) + \frac{\partial}{\partial y} \left(h \frac{\partial h}{\partial y} \right) \right] \, dx \, dy = \mu \frac{\partial h}{\partial t} \, dx \, dy \quad (8.26)$$

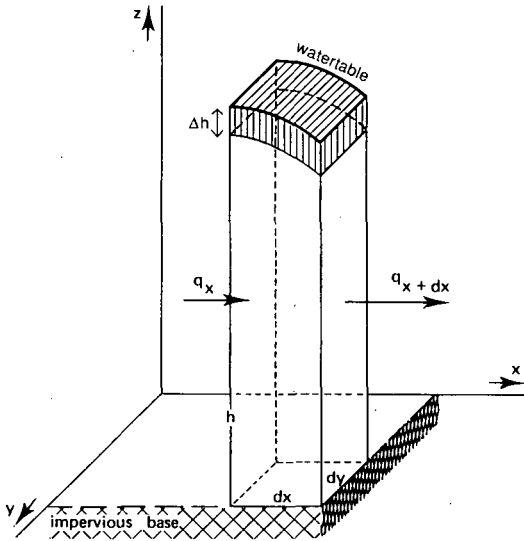

Figure 8.12 Change in storage in a soil column under a falling watertable

We can simplify this equation by considering that h will be large compared with the changes in h ; so we can take h as a constant D , being the average thickness of the water-transmitting layer. Furthermore, as we only consider flow in one direction, Equation 8.26 gives the following differential equation for unsteady flow

$$KD \frac{\partial^2 h}{\partial x^2} = \mu \frac{\partial h}{\partial t} \quad (8.27)$$

Dumm (1954) used this differential equation to describe the fall of the watertable after it had risen instantaneously to a height h_0 above drain level (Figure 8.13). His solution, which is based on a formula developed by Glover, describes the lowering of an initially horizontal watertable as a function of time, place, drain spacing, and soil properties.

$$h(x, t) = \frac{4h_0}{\pi} \sum_{n=1,3,5}^{\infty} \frac{1}{n} e^{-n^2 \alpha t} \sin \frac{n\pi x}{L} \quad (8.28)$$

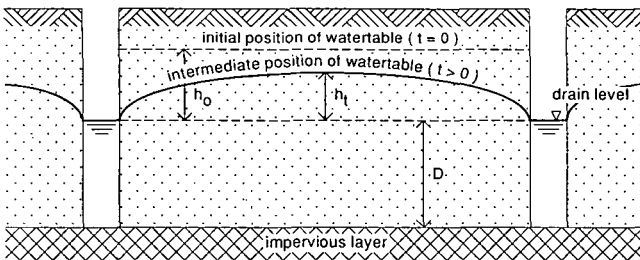

Figure 8.13 Boundary conditions for the Glover-Dumm equation with an initially horizontal watertable

where

$$\alpha = \frac{\pi^2 K d}{\mu L^2} \quad (8.29)$$

where

- $h(x, t)$ = height of the watertable at distance x at time t (m)
- h_0 = initial height of the watertable at $t = 0$ (m)
- α = reaction factor (d^{-1})
- K = hydraulic conductivity (m/d)
- d = equivalent depth of the soil layer below drain level (m)
- μ = drainable pore space (-)
- L = drain spacing (m)
- t = time after instantaneous rise of the watertable (d)

We can find the height of the watertable midway between the drains by substituting $x = \frac{1}{2} L$ into Equation 8.28

$$h_t = h\left(x = \frac{1}{2} L\right) = \frac{4}{\pi} h_0 \sum_{n=1,3,5}^{\infty} \frac{1}{n} e^{-n^2 \alpha t} \quad (8.30)$$

where

- h_t = height of the watertable midway between the drains at $t > 0$ (m)

If $\alpha t > 0.2$, the second and following terms of Equation 8.30 are small and can be neglected. So this equation reduces to

$$h_t = \frac{4}{\pi} h_0 e^{-\alpha t} = 1.27 h_0 e^{-\alpha t} \quad (8.31)$$

If, instead of being horizontal, the initial watertable has the shape of a fourth-degree parabola, Equation 8.31 becomes (Dumm 1960)

$$h_t = 1.16 h_0 e^{-\alpha t} \quad (8.32)$$

By substituting Equation 8.29 into Equation 8.32, we find an expression for the drain spacing

$$L = \pi \left(\frac{K d t}{\mu} \right)^{\frac{1}{2}} \left(\ln 1.16 \frac{h_0}{h_t} \right)^{-\frac{1}{2}} \quad (8.33)$$

which is called the Glover-Dumm Equation.

The drain discharge at any time, t , expressed per unit surface area, can be found from Darcy's Law

$$q_t = - \frac{2 K d}{L} \left[\frac{dh_t}{dx} \right]_{x=0} \quad (8.34)$$

where

- q_t = drain discharge per unit surface area at $t > 0$ (m/d)

Differentiating Equation 8.28 with respect to x , neglecting all terms $n > 1$, substituting $x = 0$, and combining with Equation 8.34 gives

$$q_t = \frac{8Kd}{L^2} h_0 e^{-\alpha t} \quad (8.35)$$

Substituting Equation 8.31 yields

$$q_t = \frac{2\pi Kd}{L^2} h_t \quad (8.36)$$

This is similar to the Hooghoudt Equation describing the flow below drain level (Equation 8.6), except that the factor 8 is now replaced by 2π . Note: For the 4th degree parabola 2π becomes 6.89. It can be seen that the drain discharge, q_t , is directly related to the depth of the watertable, h_t . This is important when data from an experimental field are being analyzed (e.g. to determine the reaction factor α ; see Chapter 12).

The original Glover-Dumm Equation is based on horizontal flow only and does not take into account the radial resistance of flow towards drains that do not reach the impervious layer. In similarity to the steady-state approach, however, by introducing Hooghoudt's concept of the equivalent depth d into the Equations 8.29 and 8.33, it does take into account the extra resistance caused by the converging flow towards the drains.

8.3.2 The De Zeeuw-Hellinga Equation

To simulate the drain discharge over a period with a non-uniform distribution of recharge, the period is divided into time intervals of equal length (e.g. days). De Zeeuw and Hellinga (1958) found that, if the recharge (R) in each time period is assumed to be constant, the change in drain discharge is proportional to the excess recharge ($R - q$), the proportionality constant being the reaction factor α .

$$\frac{dq}{dt} = \alpha (R - q) \quad (8.37)$$

Integration between the limits $t = t : q = q_t$ and $t = t - 1 : q = q_{t-1}$ yields

$$q_t = q_{t-1} e^{-\alpha \Delta t} + R (1 - e^{-\alpha \Delta t}) \quad (8.38)$$

where

$\Delta t = t - (t - 1)$, the time interval over which the recharge is assumed to be constant (d)

We can simulate the depth of the watertable by introducing the simplified Hooghoudt Equation, which neglects the flow above drain level (Equation 8.6)

$$q = \frac{8 k d}{L^2} h$$

By using Equation 8.29, we can replace the quotient $\frac{Kd}{L^2}$ by $\frac{\mu\alpha}{\pi^2}$ and Equation 8.6 changes into

$$q = \frac{8kd}{L^2} h = \frac{8\mu\alpha}{\pi^2} h \approx 0.8\mu\alpha h$$

Substituting the latter into Equation 8.38 yields

$$h_t = h_{t-1} e^{-\alpha\Delta t} + \frac{R}{0.8\mu\alpha} (1 - e^{-\alpha\Delta t}) \quad (8.39)$$

We can use Equations 8.38 and 8.39 to simulate drain discharge and watertable fluctuations on the basis of a critical distribution of rainfall intensities obtained from historical records.

8.3.3 Discussion of Unsteady-State Equations

At first sight, the unsteady-state approach offers major advantages compared with the steady-state approach, but various assumptions restrict the use of the unsteady-state equations. Firstly, both the Glover-Dumm and the De Zeeuw-Hellinga Equation can only be applied in soil with a homogeneous profile. Secondly, the flow in the region above the drains is not taken into account. When the depth of the watertable above drain level (h) is large compared with the depth to the impervious layer (D), an error may be introduced. By far the biggest restriction, however, is the introduction of the drainable pore space into the equations. Beside the fact that this soil property is very hard to measure, it also varies spatially (Chapter 11). So, introducing a constant value for the drainable pore space could result in considerable errors. As a consequence, the unsteady-state equations are hardly ever used directly in the design of subsurface drainage systems, but only in combination with steady-state equations. (The benefits of this combined approach will be discussed in Section 8.4). Nevertheless, unsteady-state equations are useful tools when one is studying the variation in time of such parameters as the elevation of the watertable, and drain discharges as a result of rainfall or irrigation.

8.3.4 Application of Unsteady-State Equations

Like the steady-state equations, the unsteady-state equations require data on soil properties and agricultural and technical design criteria. The main differences are that an additional soil property (i.e. the drainable pore space) is required and that, instead of the q/h ratio, a watertable drawdown ratio h_0/h_t is required.

How the Glover-Dumm Equation is applied in an irrigated area will be explained in Example 8.5.

Example 8.5

In an irrigated area, a drainage system is needed to control the watertable under the following conditions (Figure 8.14):

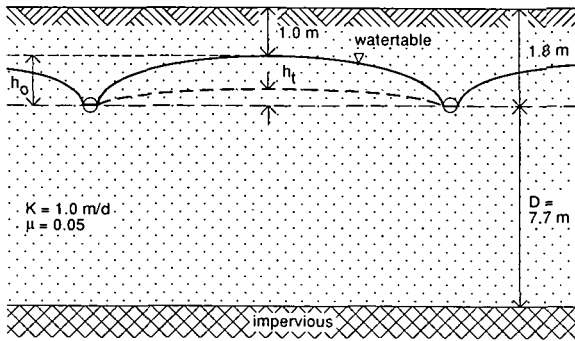

Figure 8.14 The calculation of drain spacing under unsteady- state conditions (Example 8.5)

Agricultural drainage criteria:

- The maximum permissible height of the watertable is 1 m below the soil surface;
- Irrigation water is applied every 10 days, and the field application losses percolating to the watertable are 25 mm for each irrigation.

Technical design criteria:

- Drains are installed at a depth of 1.8 m;
- PVC drainpipes with a radius of 0.10 m are used.

Soil data:

- The depth of the impervious layer is 9.5 m below the soil surface;
- The average hydraulic conductivity of the soil is 1.0 m/d, and the drainable pore space is 0.05.

If we assume that the field application losses can be regarded as an instantaneous recharge, $R_i = 0.025$ m, the rise of the watertable is

$$\Delta h = \frac{R_i}{\mu} = \frac{0.025}{0.05} = 0.5 \text{ m}$$

If we assume that, after irrigation, the watertable has risen to its maximum permissible height, we know

$$h_0 = 1.8 - 1.0 = 0.8 \text{ m}$$

The watertable must be lowered by 0.5 m during the next 10 days. So

$$h_{10} = h_0 - \Delta h = 0.8 - 0.5 = 0.3 \text{ m}$$

Thus we have the following data:

- $K = 1.0 \text{ m/d}$
- $\mu = 0.05$
- $D = 9.5 - 1.8 = 7.7 \text{ m}$
- $r_0 = 0.10 \text{ m}$
- $h_0 = 0.8 \text{ m}$
- $h_{10} = 0.3 \text{ m}$
- $t = 10 \text{ days}$

Substituting the above data into Equation 8.33 gives an expression for the drain spacing L

$$L = \pi \left(\frac{Kdt}{\mu} \right)^{\frac{1}{2}} \left(\ln 1.16 \frac{h_o}{h_t} \right)^{-\frac{1}{2}}$$

$$L = \pi \left(\frac{1.0 \times d \times 10}{0.05} \right)^{\frac{1}{2}} \left(\ln \frac{1.16 \times 0.8}{0.3} \right)^{-\frac{1}{2}}$$

$$L = 41.8 \sqrt{d} \text{ m}$$

As we know D and r_o , we can obtain the equivalent depth d from Table 8.1. We can then find L by trial and error:

– First estimate: $L = 80 \text{ m}$, $D = 7.7 \text{ m}$. From Table 8.1, we read

$$d = 4.23 + \frac{7}{10}(4.49 - 4.23) = 4.41 \text{ m}$$

$L = 41.8 \sqrt{d} = 41.8 \sqrt{4.41} = 88 \text{ m}$. This is more than 80 m , so the spacing is too wide.

– Second estimate: $L = 90 \text{ m}$, $D = 7.7 \text{ m}$. From Table 8.1, we read

$$d = 4.42 + \frac{7}{10}(4.72 - 4.42) = 4.63 \text{ m}$$

$$L = 41.8 \sqrt{4.63} = 90 \text{ m, so okay}$$

Example 8.6

In the area of Example 8.5, the drainage system has been installed with a drain spacing of 90 m . We now want to know how the drainage system reacts to a period with some intensive rainstorms. The recharge to the watertable following the rainfall is given in Table 8.3. If we assume that the watertable at the start of the rainy period is 0.30 m above drain level, we can use the De Zeeuw-Hellinga Equation to calculate the fluctuations of the watertable and the corresponding discharge from the drainage system.

We have the following data:

$$K = 1.0 \text{ m/d}$$

$$\mu = 0.05$$

$$L = 90 \text{ m}$$

$$d = 4.63 \text{ m}$$

$$h_o = 0.30 \text{ m}$$

We can calculate the reaction factor, α , and the discharge at day 0

$$\text{Equation 8.29: } \alpha = \frac{\pi^2 K d}{\mu L^2} = \frac{\pi^2 \times 1.0 \times 4.63}{0.05 \times 90^2} = 0.113 \text{ d}^{-1}$$

$$\text{Equation 8.6: } q_o = \frac{8 K d h_o}{L^2} = \frac{8 \times 1.0 \times 4.63 \times 0.30}{90^2} = 0.001 \text{ m/d}$$

Table 8.3 Watertable depth and drain discharge calculations using the De Zeeuw-Hellinga Equation (Example 8.6)

Day	Recharge (m)	Watertable* (m)	Drain discharge* (m/d)
0	0.000	0.30	0.001
1	0.018	0.69	0.003
2	0.007	0.78	0.004
3	0.029	1.39	0.006
4	0.012	1.52	0.007
5	0.003	1.43	0.006
6	0.000	1.28	0.006
7	0.000	1.14	0.005
8	0.000	1.02	0.005
9	0.000	0.91	0.004
10	0.000	0.81	0.004
11	0.000	0.73	0.003
12	0.000	0.65	0.003
13	0.000	0.58	0.003
14	0.000	0.52	0.002
15	0.000	0.46	0.002
16	0.000	0.41	0.002
17	0.000	0.37	0.002
18	0.000	0.33	0.001
19	0.000	0.29	0.001
20	0.000	0.26	0.001

* Calculated with Equations 8.38 and 8.39, using $\Delta t = 1$ day

For the following days, we can calculate the change in of the watertable and the corresponding drain discharge with Equation 8.38 and 8.39:

Day 1:

$$\begin{aligned}
 h_1 &= h_0 e^{-\alpha \Delta t} + \frac{R_1}{0.8\mu\alpha} (1 - e^{-\alpha \Delta t}) \\
 &= 0.30 \times e^{-0.113} + \frac{0.018}{0.8 \times 0.05 \times 0.113} (1 - e^{-0.113}) \\
 &= 0.69 \text{ m}
 \end{aligned}$$

$$\begin{aligned}
 \text{and } q_1 &= q_0 e^{-\alpha \Delta t} + R_1 (1 - e^{-\alpha \Delta t}) \\
 &= 0.001 \times e^{-0.113} + 0.018 (1 - e^{-0.113}) \\
 &= 0.003 \text{ m/d}
 \end{aligned}$$

Day 2:

$$\begin{aligned}
 h_2 &= h_1 e^{-\alpha \Delta t} + \frac{R_2}{0.8\mu\alpha} (1 - e^{-\alpha \Delta t}) \\
 &= 0.69 \times e^{-0.113} + \frac{0.007}{0.8 \times 0.05 \times 0.113} (1 - e^{-0.113}) \\
 &= 0.78 \text{ m}
 \end{aligned}$$

$$\begin{aligned}
 \text{and } q_2 &= q_1 e^{-\alpha \Delta t} + R_2 (1 - e^{-\alpha \Delta t}) \\
 &= 0.003 e^{-0.113} + 0.007 (1 - e^{-0.113}) \\
 &= 0.004 \text{ m/d}
 \end{aligned}$$

Day 3: etc.

It can be seen from Table 8.3 that, for 7 days (i.e. from Day 3 to Day 10), the watertable is above its maximum permissible height (1 m below soil surface or 0.80 m above drain level). This is not surprising because the total recharge after the rainstorms (69 mm in 5 days) is much more than the field application losses (25 mm in 10 days) on which the design of the drainage system was based. If these high levels of the watertable restrict plant growth, and thus crop production, the design criteria will have to be adjusted accordingly.

8.4 Comparison between Steady-State and Unsteady-State Equations

The question of whether to use the steady-state or the unsteady-state approach to calculate the required drain spacing depends mainly on the availability of data. Table 8.4 summarizes the input requirements for the steady-state and the unsteady-state.

Table 8.4 Input requirements for steady-state and unsteady-state equations

	Steady-state equations	Unsteady-state equations
Soil data:		
- Profile description	Yes	Yes
- Hydraulic conductivity	Yes	Yes
- Drainable pore space	No	Yes
Agricultural criteria:		
- q/h ratio	Yes	No
- h_0/h_t ratio	No	Yes
Technical criteria:		
- Drain depth, pipe size, etc.	Yes	Yes

To apply the equations, we have to simplify the soil profile. We have already mentioned that unsteady-state equations can only be applied if a homogeneous soil profile is assumed; for a layered soil profile, steady-state equations have to be used. In both cases, the hydraulic conductivity, which is considered to be constant within each soil layer, should be known. For unsteady-state equations the drainable pore space is also required. As it is even more complicated to measure the drainable pore space than, say, the hydraulic conductivity, the applicability of unsteady-state equations is limited.

In the unsteady-state approach, the agricultural criterion is based on the rate of watertable drawdown h_0/h_t (Section 8.3.3) instead of a watertable-discharge criterion q/h as in steady-state equations (Section 8.2.4). The agricultural criteria are often based on relationships that only take the (variation in) depth of the watertable into consideration (Chapter 17). Thus it can be concluded that, on the one hand, steady-state equations are preferred because fewer soil data are required, but, on the other hand, the agricultural criteria are often based on a variation in the depth of the watertable. Fortunately, it is possible to combine the two approaches because the corresponding criteria can be converted into one another.

Consider the Hooghoudt Equation and assume flow only below drain level (Equation 8.6)

$$q = \frac{8 K d h}{L^2}$$

In the unsteady-state equations, the design criteria are expressed in the reaction factor α (Equation 8.29)

$$\alpha = \frac{\pi^2 K d}{\mu L^2}$$

Combining these two equations by eliminating L yields

$$\frac{h}{q} = \frac{\pi^2}{8\mu\alpha} \quad (8.40)$$

With the use of Equation 8.40, it is possible to establish the unsteady state criteria (i.e. the required drawdown of the watertable in a certain period of time) in experiments on a pilot scale. These unsteady-state criteria can be converted into steady-state criteria, which can be applied on a project scale. In this way, it is not necessary to measure the drainable pore space on a project scale, which, in practice, is virtually impossible.

Example 8.7

We can also solve Example 8.5 in an indirect way by converting the unsteady-state drainage criterion h_0/h_t into a steady-state criterion q/h . We know the rate of drawdown of the watertable over a period of 10 days, so we can calculate the reaction factor α with Equation 8.32

$$h_t = 1.16 h_0 e^{-\alpha t} \rightarrow \alpha t = -\ln \frac{h_t}{1.16 h_0}$$

$$\alpha t = -\ln \frac{0.3}{1.16 \times 0.8} = 1.13$$

$$\alpha = \frac{1.13}{10} = 0.113$$

By applying Equation 8.40, we can convert this unsteady-state criterion into a steady-state criterion.

$$\frac{h}{q} = \frac{\pi^2}{8\mu\alpha} = \frac{\pi^2}{8 \times 0.05 \times 0.113} = 218 \text{ d}^{-1}$$

Neglecting the flow above drain level, we can now calculate the drain spacing by applying the simplified version of Hooghoudt (Equation 8.6)

$$L^2 = 8 K d \frac{h}{q} = 8 \times 1.0 \times d \times 218 = 1744 \times d \text{ m}^2$$

First estimate: $L = 90 \text{ m}$, $D = 7.7 \text{ m}$, $d = 4.63 \text{ m}$ (Example 8.5). Thus

$$L^2 = 1744 \times 4.63 = 8075 \text{ m}^2$$

$$L = 90 \text{ m, so okay}$$

Note: The reaction factor, α , is a function of the parameters L , K , d , and μ (Equation 8.29). Except for the spacing L , these parameters are hard to establish. This example shows that an alternative way of obtaining α is by monitoring the drawdown of the watertable after a sudden rise (e.g. caused by irrigation or heavy rainfall). In this example, α was calculated only from the watertable level at $t = 0$ and $t = 10$ days. If more data are available, α can be found by an exponential regression (Chapter 6).

8.5 Special Drainage Situations

8.5.1 Drainage of Sloping Lands

Up to now, we have only considered drainage in flat lands. Many agricultural areas, however, are sloping, so the question arises: 'In how far can equations for flat lands be applied to sloping lands?' When a hillside is drained by a series of parallel drains, the situation is as depicted in Figure 8.15. The highest watertable height, h , above drain level is now not midway between the drains but is closer to the downslope drain.

Schmidt and Luthin (1964) solved the hillside seepage problem of steady vertical recharge to parallel ditches penetrating to a sloping impervious layer. The resulting drain spacings for gently sloping areas (slope < 0.1) do not differ much from the spacings for flat lands. This is in agreement with the results of Bouwer (1955), who

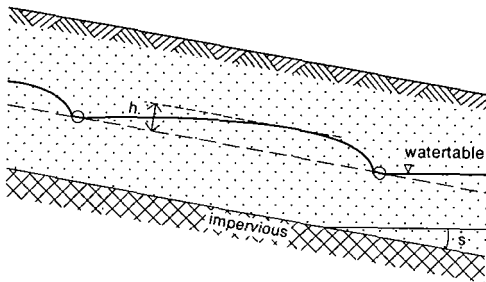

Figure 8.15 Flow to parallel drains in a homogenous soil overlying a sloping impervious layer

conducted a large series of tests in sand-tank models, and numerical simulations done by Fipps and Skaggs (1989). Because the vast majority of agricultural land will not have slopes in excess of 0.1, our conclusion is that we can apply solutions for flat land to sloping land without any alteration as long as the slopes are not steeper than 0.1.

This conclusion implies that we assume no difference in efficiency between drains laid parallel or perpendicular to the slope. Where the hydraulic conductivity of the soil is low, it could be advisable to lay the drains parallel to the contour lines, hence perpendicular to the slope. As the backfilled trenches have, and retain, a higher permeability than the original soil profile, any surface runoff may possibly be intercepted by the trenches. (Further considerations on the layout of subsurface drainage systems in sloping areas are presented in Chapter 21.)

8.5.2 Open Drains with Different Water Levels and of Different Sizes

Open drains in slightly sloping or undulating areas often have different drain levels. This problem has already been discussed in Chapter 7, Section 7.8.2. By applying the Dupuit-Forchheimer theory, we could find the general equation for the watertable (Equation 7.71).

In practice, open drains, besides having different water levels, are often of different sizes. Figure 8.16 schematically depicts this situation for a two-layered soil profile. We assume that the wet perimeter and the water levels in the drains are known and that there is no recharge (e.g. from precipitation); so $R = 0$. For these conditions, Ernst (1956) proposed the following solution, which is based on the fact that groundwater flow is fully equivalent to the flow of electricity, heat, or fluid between two parallel glass plates, provided that the boundary conditions are appropriately chosen.

For the Dupuit-Forchheimer conditions to be valid, Ernst set a preliminary condition that $L > 2(D_1 + D_2)$. For the sake of simplicity, D_1 is considered constant, which, in fact, it is not. As a result, the proposed method is only valid if $\Delta h < \frac{1}{2} D_1$, where Δh is the fall of the watertable. The water flow in the vicinity of

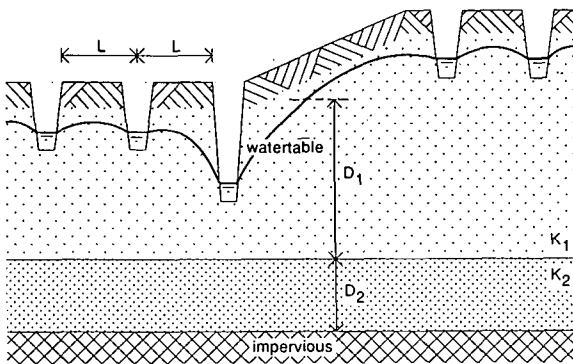

Figure 8.16 Flow to parallel open drains of different sizes and with different water levels in a two-layered soil profile

a drain is schematically depicted in Figure 8.17, in which we see that the flow is partially drained by the shallow drain, while another part of the flow continues towards a deeper drain.

To obtain a solution for the flow in the vicinity of such a drain, we replace the groundwater flow in Figure 8.17 with a resistance network as in Figure 8.18A. In this figure, we see the following variables:

- $h_{0,i}$ = the water level in the drain (m)
- $h_{1,i}$ = the piezometric head of the groundwater (m)
- $q_{1,i-1}$ = the horizontal flow upstream of the drain (m/d)
- $q_{0,i}$ = the radial flow towards the drain (m/d)
- $q_{1,i}$ = the horizontal flow downstream of the drain (m/d)

In analogy to this network, the flow problem in Figure 8.16 is replaced by the resistance network (Figure 8.18B). In this figure, we recognize

- $h_{0,1}, h_{0,2}, \dots$ = the water level in the drain (m)
- $h_{1,1}, h_{1,2}, \dots$ = the piezometric head of the groundwater (m)
- w_1, w_2, \dots = the radial resistances to flow (d)
- $L_1/KD, L_2/KD, \dots$ = the horizontal resistances to flow (d/m)

If $R = 0$ (as was assumed), we have, according to the principle of continuity, for any arbitrary drain i

$$q_{1,i-1} = q_{0,i} - q_{1,i} \quad (8.41)$$

Following Ernst's concept (Section 8.2.2) and assuming flow from left to right as well as upward flow to be positive, we find the radial flow towards a drain to be (compare Equation 8.20)

$$q_{0,i} = \frac{1}{w_i} (h_{1,i} - h_{0,i}) \quad (8.42)$$

where

$$w_i = \frac{L_i}{\pi K_r} \ln \frac{a D_r}{u}$$

where

w_i = radial flow resistance (d)

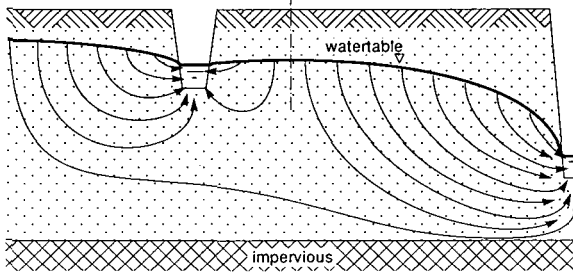

Figure 8.17 Detail of Figure 8.16: flow pattern near a drain

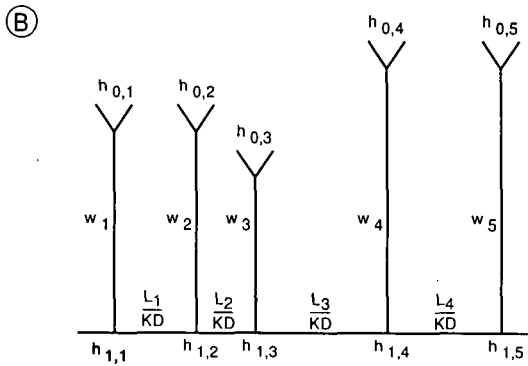
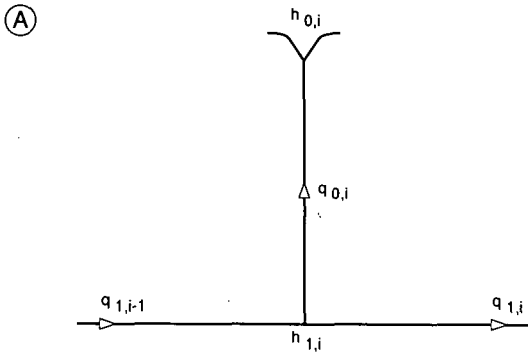

Figure 8.18 Schematic representation of a resistance network (A), simulating the flow problem of Figure 8.16 (B)

and the horizontal flow rate between two drains (compare Equation 8.19)

$$q_{1,i} = \frac{8KD}{L_i^2} (h_{1,i} - h_{1,i+1}) \quad (8.43)$$

Eliminating the flow rates $q_{0,i}$, $q_{1,i}$, and $q_{1,i-1}$ from Equations 8.41 – 8.43 yields

$$\frac{8KD}{L_{i-1}^2} (h_{1,i-1} - h_{1,i}) = \frac{1}{w_i} (h_{1,i} - h_{0,i}) + \frac{8KD}{L_i^2} (h_{1,i} - h_{1,i+1}) \quad (8.44)$$

With n open drains, we obtain n first-degree equations with n unknowns $h_{1,i}$. Further, we have to know the conditions at the boundaries: in the case of Figure 8.18, $h_{1,1}$ or $h_{1,5}$ or a given value of the horizontal flow at the left-hand side of the first drain.

If there is recharge or precipitation, we consider the case of a steady state (i.e. we consider R to be constant with time.) In fact, we assume that, along each 1 m section of the water table, a quantity of water, R , enters the groundwater. Therefore, for the horizontal flow, we have

$$\frac{dq_i}{dx} = R \quad (8.45)$$

Again, Darcy's Law holds

$$q_1 = -KD \frac{dh_1}{dx} \quad (8.46)$$

Eliminating q from the latter two equations yields

$$\frac{d^2h_1}{dx^2} = -\frac{R}{KD} \quad (8.47)$$

Integrating Equation 8.47 yields

$$h_1 = \left(\frac{R}{2KD}\right)x^2 + Ax + B \quad (8.48)$$

Differentiating Equation 8.48 with respect to x and substituting the result into Equation 8.46 gives

$$q_{1,i} = Rx - KDA \quad (8.49)$$

Further, for the radial flow towards the drains, we have

$$q_{0,i} = \frac{h_{1,i}}{w_i} \quad (8.50)$$

Using the latter two equations, we can apply the same procedure as for $R = 0$, hence eliminating the q -values, which again yields n equations with n unknown h_1 -values.

8.5.3 Interceptor Drainage

In general, interceptor drains are used for two different purposes, i.e.:

- to intercept seepage water from neighbouring irrigation canals;
- to intercept foreign water that seeps down a hill.

The first type of interceptor drains are often installed in irrigated areas parallel to, and a short distance away from, conveyance canals. The flow towards such a drain is similar to the flow between drains with different water levels. If we assume that

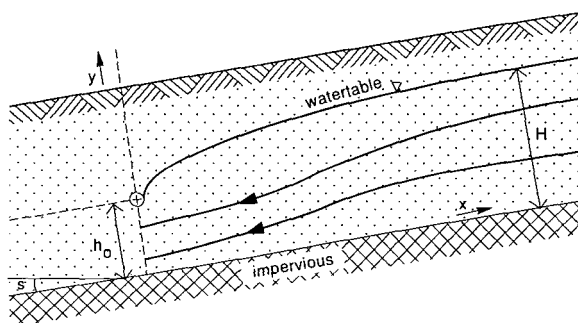

Figure 8.19 Flow towards an interceptor drain through a homogenous soil overlying a uniformly sloping layer

there is no recharge from precipitation, we can use the Dupuit Equation to calculate the flow per unit length (Section 7.8.2).

The second type of interceptor (or hill-side) drainage is shown in Figure 8.19. Donnan (1959) presented a solution for this type of drainage. He assumed a homogeneous uniform soil layer on top of an impervious layer with a slope s . Without an interceptor drain, the slope of the watertable will be parallel to the slope of the impervious layer, so the amount of seepage water flowing downhill can be calculated with Darcy's Equation

$$q = K H s \quad (8.51)$$

where

- q = flow rate per unit width (m^2/d)
- K = hydraulic conductivity of the top layer (m/d)
- H = height of the watertable above the impervious layer before the installation of the interceptor drain (m)
- s = slope of the impervious layer (-)

If an interceptor drain is constructed at the bottom of the hill at a height h_0 above the impervious layer, the slope of the watertable in the vicinity of the drain will no longer be parallel to the impervious layer, but will curve towards the drain. With a coordinate system as in Figure 8.19, we can assume that the slope is approximately $s + dh/dx$, so the amount of seepage flow through a cross-section at a distance x uphill from the drain will be

$$q = K y \left(s + \frac{dy}{dx} \right) \quad (8.52)$$

where

- y = height of the watertable above the impervious layer at distance x (m)
- $\frac{dy}{dx}$ = hydraulic gradient at x (-)

Because of continuity, the flow with or without the interceptor drain must be equal, so

$$K H s = K y \left(s + \frac{dy}{dx} \right) \quad (8.53)$$

Integrating with $y = h_0$ at $x = 0$ gives (Donnan 1959)

$$x = \frac{1}{s} \left[2.3 H \log \frac{H - h_0}{H - y} - (y - h_0) \right] \quad (8.54)$$

where

- x = distance uphill from the interceptor drain (m)

Equation 8.54 can be used to calculate the height of the watertable at any distance x uphill from the interceptor drain. Theoretically, $y = H$ is only reached at $x = \infty$.

Example 8.8

An irrigation scheme (500 × 1000 m) is located in a sloping area (Figure 8.20). The deep percolation losses are 1 mm/d. The soil consists of a permeable layer, 6 m thick and with a hydraulic conductivity of 2.5 m/d, on top of an impervious layer with a slope of $s = 0.04$. To control the watertable in the area downhill from the irrigated area at a level of 2 m below the soil surface, an interceptor drain will be constructed. We have to calculate the required depth and capacity of the interceptor drain, and the uphill elevation of the watertable after the construction of the interceptor drain.

To control the watertable at 2 m below the soil surface, the height of the interceptor drain above the impervious layer has to be

$$h_0 = 6.0 - 2.0 = 4.0 \text{ m}$$

The percolation losses result in a seepage flow, per metre width, of

$$q_s = 500 \times 0.001 = 0.5 \text{ m}^2/\text{d}$$

The elevation of the watertable above the impervious layer before the construction of the interceptor drain can be calculated with Equation 8.51

$$H = \frac{q_s}{Ks} = \frac{0.5}{2.5 \times 0.04} = 5.0 \text{ m}$$

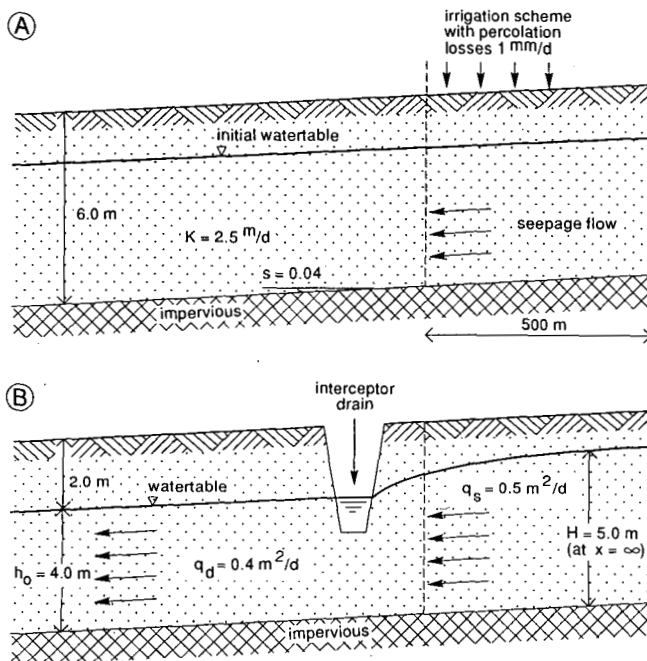

Figure 8.20 The calculation of an interceptor drain in a sloping area: (A) before construction and (B) after construction (Example 8.8)

After the interceptor drain has been constructed, the seepage flow downhill from the drain will be

$$q_d = K h_0 s = 2.5 \times 4.0 \times 0.04 = 0.4 \text{ m}^2/\text{d}$$

Thus the required capacity of the interceptor drain per metre length is

$$q_i = q_s - q_d = 0.5 - 0.4 = 0.1 \text{ m}^2/\text{d}$$

In other words 20% of the percolating water will be intercepted. As the scheme is 1000 m long, the discharge at the outlet of the interceptor drain will be

$$Q_i = 1000 \times q_i = 1000 \times 0.1 = 100 \text{ m}^3/\text{d} = 1.161/\text{s}$$

The elevation of the watertable uphill from the interceptor drain can be described by Equation 8.54

$$x = \frac{1}{s} \left[2.3 H \log \frac{H - h_0}{H - y} - (y - h_0) \right]$$

$$x = \frac{1}{0.04} \left[2.3 \times 5.0 \log \frac{5.0 - 4.0}{5.0 - y} - (y - 4.0) \right]$$

$$x = 287.5 \log \frac{1.0}{5.0 - y} - 25 \times (y - 4.0)$$

Thus:

$$y = 4.0 \text{ m at } x = 0 \text{ m}$$

$$y = 4.2 \text{ m at } x = 23 \text{ m}$$

$$y = 4.4 \text{ m at } x = 54 \text{ m}$$

$$y = 4.6 \text{ m at } x = 99 \text{ m}$$

$$y = 4.8 \text{ m at } x = 181 \text{ m}$$

and

$$y = 4.9 \text{ m at } x = 265 \text{ m}$$

8.5.4 Drainage of Heavy Clay Soils

Heavy clay soils often have such a low hydraulic conductivity that they require very narrow drain spacings. The narrowest spacing applicable in practice is a matter of economics (e.g. crops to be grown, prices of products). The hydraulic conductivity may be so low that no subsurface drainage with economically justifiable spacing is possible. One should then use a surface drainage system of furrows and small ditches, possibly combined with bedding of the soil (Chapter 20).

For moderate hydraulic conductivity, it may happen that the infiltration rate is too low for the water to enter the soil, so that frequent surface ponding will occur. A suggested limit for the installation of a subsurface drainage system is that the infiltration rate of the soil must be such that the rainfall to be expected in two or three subsequent days must easily infiltrate during that time. If not, a subsurface drainage system will not work satisfactorily and one has to resort to a surface drainage system.

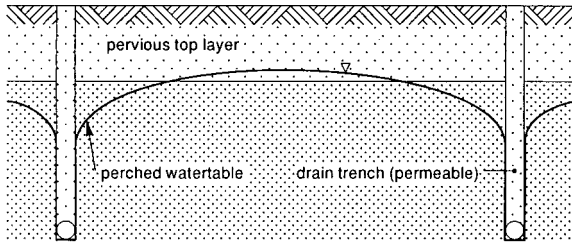

Figure 8.21 Perched watertable built up in heavy clay soil, just below the top layer with a higher hydraulic conductivity

Heavy clay soils of low hydraulic conductivity often have a top layer with a surprisingly high hydraulic conductivity because of the activity of plant roots or the presence of a tilled layer. In such cases, rainfall will build up a perched watertable on the layer just below the top layer (Figure 8.21). Under these conditions, a subsurface drainage system can be effective because of the interflow in the permeable top layer, but it will only work as long as the backfilled trench remains more permeable than the original soil.

Unless one can expect the hydraulic conductivity of the subsoil to increase with time (e.g. because of the soil ripening process; Chapter 13), it makes no sense to install a drainage system at a great depth. In fact, a system reaching just below the top layer should be sufficient. The system can be improved by filling the trench with coarse material or adding material like lime. Further improvement can be sought in mole drainage, perpendicular to the subsurface lines. (More information on this topic will be provided in Chapter 21.)

In none of the cases discussed above is it possible to apply a drainage theory, since the exact flow paths of the water are not known. Besides, these heavy soils often have a seasonal variation in hydraulic conductivity because of swelling and shrinking.

Heavy clay soils of the type found in the Dutch basin clay areas often have relatively high permeable layers in the subsoil (Van Hoorn 1960). If a subsurface drainage system can be placed in such a layer, these soils can often be drained quite well (Figure 8.22). In these circumstances, the Ernst theory discussed earlier can be applied. As a matter of fact, this theory was developed mainly for such applications. Complications can arise due to two circumstances:

- The layer with the higher hydraulic conductivity is too deep for a normal subsurface system to be installed in it. If so, the drainage problem could possibly be solved

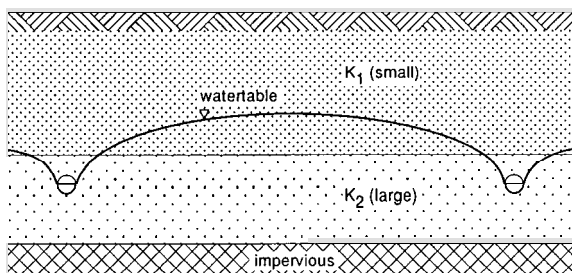

Figure 8.22 Drains in a layer with high hydraulic conductivity under less permeable heavy clay topsoil

by installing tubewells. It is obvious that, for the wells to be effective, the permeable layer must satisfy certain conditions with respect to the transmissivity, KD , and that the piezometric pressure in this layer must be low. (This will be further discussed in Chapter 22.);

- The upper layer has such a low hydraulic conductivity that the groundwater does not percolate to the deeper layer at a reasonable rate. Now we are back to the beginning of this section, and the only solution is to apply surface drainage.

References

- Bouwer, H. 1955. Tile drainage of sloping fields. *Agricultural Engineering* 36, 6 p.
- Dagan, G. 1964. Spacings of drains by an approximate method. *Journal of the Irrigation and Drainage Division ASCE* 90, pp. 41-46.
- De Zeeuw, J.W., and F. Hellinga 1958. Neerslag en afvoer. *Landbouwkundig Tijdschrift*. 70, pp. 405-422 (in Dutch with English summary).
- Donnan, W.W. 1946. Model tests of a tile-spacing formula. *Soil Science Society of America Proceedings* 11, pp. 131-136.
- Donnan, W.W. 1959. Drainage of agricultural land using interceptor lines. *Journal of the Irrigation and Drainage Division ASCE*. pp. 13-23.
- Dumm, L.D. 1954. Drain spacing formula. *Agricultural Engineering* 35, pp. 726-730.
- Dumm, L.D. 1960. Validity and use of the transient flow concept in subsurface drainage. Paper presented at ASAE meeting, Memphis, December, pp. 4-7.
- Ernst, L.F. 1956. Calculation of the steady flow of groundwater in vertical cross-sections. *Netherlands Journal of Agricultural Science* 4, pp. 126-131.
- Ernst, L.F. 1962. Grondwaterstromingen in de verzadigde zone en hun berekening bij aanwezigheid van horizontale evenwijdige open leidingen. *Versl. Landbouwk. Onderz.* 67-15. Pudoc, Wageningen. 189 p. (In Dutch with English summary).
- Fipps, G. and R.W. Skaggs 1989. Influence of slope on subsurface drainage of hillsides. *Water Resources Research* 25 (7), pp. 1717-1726.
- Hooghoudt, S.B. 1940. Algemeene beschouwing van het probleem van de detailontwatering en de infiltratie door middel van parallel loopende drains, greppels, slooten, en kanalen. *Versl. Landbouwk. Onderz.* 46 (14)B. Algemeene Landsdrukkerij, 's-Gravenhage, 193 p.
- Kirkham, D. 1958. Seepage of steady rainfall through soil into drains. *Transactions American Geophysical Union* 39 (5), pp. 892-908.
- Kraijenhoff van de Leur, D.A. 1958. A study of non-steady groundwater flow with special reference to a reservoir-coefficient. I. *De Ingenieur*, 70, pp. B87-94.
- Kraijenhoff van de Leur, D.A. 1962. A study of non-steady groundwater flow. II. *De Ingenieur*, 74, pp. B285-292.
- Lovell, C.J. and E.G. Youngs 1984. A comparison of steady-state land drainage equations. *Agricultural Water Management* 9, 1, pp. 1-21.
- Maasland, M. 1959. Watertable fluctuations induced by intermittent recharge. *Journal of Geophysical Research* 64, pp. 549-559.
- Schmidt, P. and J.N. Luthin 1964. The drainage of sloping lands. *Journal of Geophysical Research* 69, pp. 1525-1529.
- Smedema, L.K. and D.W. Rycroft 1983. *Land drainage : planning and design of agricultural drainage systems*. Batsford, London, 376 p.
- Toksöz, S. and D. Kirkham 1961. Graphical solution and interpretation of new drain-spacing formula. *Journal of Geophysical Research* 66 (2), pp. 509-516.
- Toksöz, S. and D. Kirkham 1971. Steady drainage of layered soils : theory and nomographs. *Journal of the Irrigation and Drainage Division ASCE* 97 (IRI), pp. 1-37.
- Van Beers, W.F.J. 1979. *Some nomographs for the calculation of drain spacings*. 3rd ed. ILRI Bulletin 8, Wageningen, 46 p.
- Van der Molen, W.H., and J. Wesseling 1991. A solution in closed form and a series solution to replace

- the tables for the thickness of the equivalent layer in Hooghoudt's drain spacing formula. *Agricultural Water Management* 19, pp. 1-16.
- Van Hoorn, J.W. 1960. Grondwaterstroming in komgrond en de bepaling van enige hydrologische grootheden in verband met het ontwateringssysteem. *Versl. Landbouwk. Onderz.* 66 (10). Pudoc, Wageningen, 136 p.
- Walczak, R. T, R. R. van der Ploeg, and D. Kirkham 1988. An algorithm for the calculation of drain spacing for layered soils. *Soil Science Society of America Journal* 52, pp. 336-340.

9 Seepage and Groundwater Flow

N.A. de Ridder¹† and G. Zijlstra¹

9.1 Introduction

The underground flow of water can create significant problems for land drainage. These problems can be divided into two categories: those of seepage and those of groundwater flow. Seepage problems concern the percolation of water through dams and into excavations, and the movement of water into and through the soil from bodies of surface water such as canals, streams, or lakes. Groundwater-flow problems concern the natural processes of infiltration and the subsequent flow of water through layers of high and low permeability until the flow discharges into springs, rivers, or other natural drainage channels. A quantitative knowledge of seepage and/or groundwater flow is needed to determine the drainable surplus of a project area (Chapter 16). Seepage from open watercourses can be determined by direct measurements at various points (inflow-outflow technique), or by subjecting the flow system to a hydrodynamic analysis (analytical approach). The latter requires that the relevant hydraulic characteristics of the water-transmitting layers and the boundary conditions be known.

This chapter is mainly concerned with the analytical approach to some of the seepage and groundwater-flow problems frequently encountered in land drainage. For a more thorough treatment of the subject, we refer to textbooks: e.g. Harr (1962), Verruijt (1982), Rushton and Redshaw (1979), Muskat (1946), Bear et al. (1968), Bouwer (1978).

9.2 Seepage from a River into a Semi-Confined Aquifer

A water-bearing layer is called a semi-confined or leaky aquifer when its overlying and underlying layers are aquitards, or when one of them is an aquitard and the other an aquiclude. Aquitards are layers whose permeability is much less than that of the aquifer itself. Aquicludes are layers that are essentially impermeable. These terms were defined in Chapter 2.2.3.

Semi-confined aquifers being common in alluvial plains, we shall consider the seepage along a river that fully penetrates a semi-confined aquifer overlain by an aquitard and underlain by an aquiclude. We assume that the aquifer is homogeneous and isotropic, and that its thickness, D , is constant. As the hydraulic conductivity of the aquifer, K , is much greater than the hydraulic conductivity of the overlying confining layer, K' , we are justified in assuming that vertical velocities in the aquifer are small compared with the horizontal velocities. This implies that the hydraulic head in the aquifer can be considered practically constant over its thickness. Whereas horizontal flow predominates in the aquifer, vertical flow, either upward or downward, occurs in the confining top layer, depending on the relative position of the watertable

¹ International Institute for Land Reclamation and Improvement

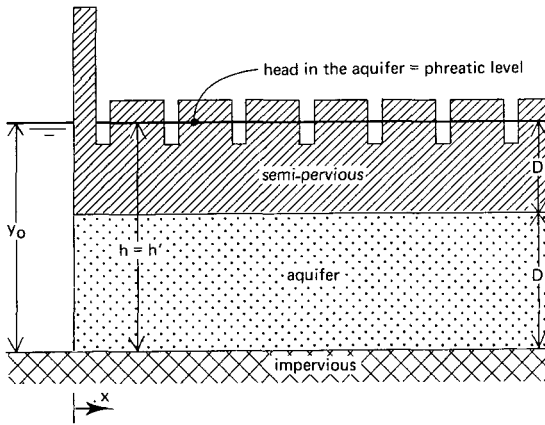

Figure 9.1 Semi-confined aquifer cut by a straight river; equilibrium conditions, groundwater at rest

in the top layer and the piezometric surface in the aquifer.

As a start, let us consider a situation where the groundwater is at rest (Figure 9.1). The watertable in the confining layer and the piezometric surface in the aquifer coincide with the water level in the river, y_0 .

At high river stages the hydraulic head, h , in the aquifer increases and may rise above the phreatic level h' in the confining layer, or even rise above the land surface. The high river stage induces a seepage flow from the river into the aquifer, and from the aquifer into the overlying confining layer (Figure 9.2). At low river stages, the head in the aquifer decreases and may fall below the watertable in the overlying confining layer. The low river stage induces a downward flow through the confining layer into the aquifer, and a horizontal flow from the aquifer towards the river channel (Figure 9.3). The upward or downward flow through the confining layer causes the watertable in that layer to rise or fall. Rainfall and evapotranspiration also affect the elevation of the watertable.

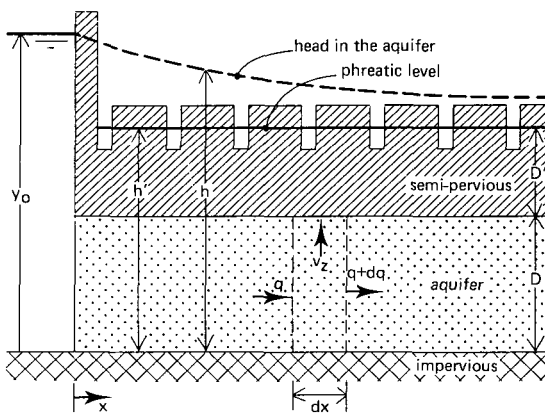

Figure 9.2 Semi-confined aquifer cut by a straight river; seepage flow

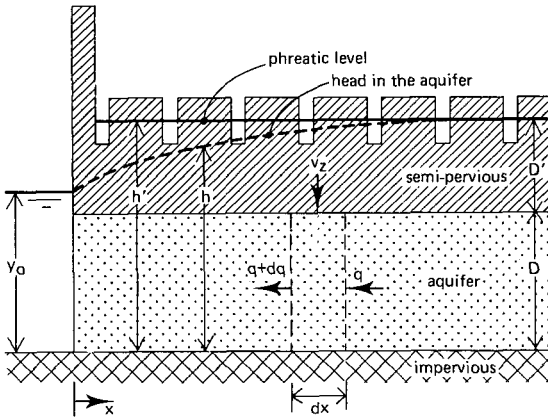

Figure 9.3 Semi-confined aquifer cut by a straight river; drainage flow

A solution to the above problem can be obtained by assuming that the watertable in the confining layer is constant and uniform at a height, h' , above the horizontal surface of the impermeable base, although a constant watertable in the confining layer, independent of changes in the hydraulic head in the aquifer, is possible only when narrowly-spaced ditches and drains are present.

Using Darcy's law, we can express the horizontal flow in the aquifer as

$$q = -KD \frac{dh}{dx}$$

or, differentiating with respect to x ,

$$\frac{dq}{dx} = -KD \frac{d^2h}{dx^2} \quad (9.1)$$

where

$$q = \text{the flow per unit width of the aquifer (m}^2/\text{d)}$$

Small quantities of water leave the aquifer through the confining layer of low permeability. The principle of continuity requires that the change in the horizontal flow in the aquifer brought about by these water losses be taken into account.

If the vertical flow through the confining layer, v_z , is taken positive in the upward direction, then

$$v_z = -\frac{dq}{dx} \quad (9.2)$$

Using Darcy's law, we can write the upward flow through the confining layer as

$$v_z = K' \frac{h - h'}{D'} = \frac{h - h'}{c} \quad (9.3)$$

where

- K' = hydraulic conductivity of the confining layer for vertical flow (m/d)
- D' = saturated thickness of the confining layer (m)
- $c = D'/K'$ = hydraulic resistance of the confining layer (d)
- h' = phreatic level in the overlying confining layer (m)

Combining Equations 9.1, 9.2 and 9.3 gives the general differential equation for steady one-dimensional seepage flow

$$KD \frac{d^2h}{dx^2} - \frac{h - h'}{c} = 0 \quad (9.4)$$

which may alternatively be written as

$$\frac{d^2h}{dx^2} - \frac{h - h'}{L^2} = 0 \quad (9.5)$$

where

$$L = \sqrt{KDC} \text{ is the leakage factor of the aquifer (m)}$$

Equation 9.5 can be solved by integration; the solution as given in handbooks on calculus (e.g. Dwight 1971) is

$$h - h' = C_1 e^{x/L} + C_2 e^{-x/L} \quad (9.6)$$

where C_1 and C_2 are integration constants that must be determined from the boundary conditions

- for $x \rightarrow \infty$, $h = h'$
- for $x = 0$, $h = h_0$
- and $h' = \text{constant}$

Substituting the first condition into Equation 9.6 gives $C_1 = 0$, and substituting the other two conditions gives $C_2 = h_0 - h'$. In this expression, h_0 is the hydraulic head in the aquifer at a distance $x = 0$ from the river, or $h_0 = y_0$.

Substituting these results into Equation 9.6 gives the solution

$$h - h' = (h_0 - h') e^{-x/L} \quad (9.7)$$

which, after being rewritten, gives the relation between the hydraulic head in the aquifer, h , and the distance from the river, x

$$h = h' + (h_0 - h') e^{-x/L} \quad (9.8)$$

The equation for the seepage can be obtained as follows. First the flow rate, v_x , is determined by differentiating Equation 9.8

$$v_x = -K \frac{dh}{dx} = \frac{K(h_0 - h')}{L} e^{-x/L} \quad (9.9)$$

The total seepage per unit width of the aquifer at distance x from the river is obtained

by multiplying the flow rate by the aquifer thickness, D

$$q_x = \frac{KD(h_0 - h')}{L} e^{-x/L} \quad (9.10)$$

The seepage into the aquifer at $x = 0$ is then found by substituting $x = 0$ into Equation 9.10. This gives

$$q_0 = \frac{KD}{L} (h_0 - h') \quad (9.11)$$

From Equations 9.10 and 9.11, it follows that

$$q_x = q_0 e^{-x/L} \quad (9.12)$$

This equation shows that the spatial distribution of the seepage depends only on the leakage factor, L. For some values of x, the corresponding ratios q_x/q_0 and the seepage as a percentage of the seepage entering the aquifer at the river are as follows:

Distance from the river	q_x/q_0	Seepage over distance x as percentage of q_0
$x = 0.5L$	0.61	39
$x = 1.0L$	0.37	63
$x = 2.0L$	0.13	87
$x = 3.0L$	0.05	95

These figures indicate that the seepage in a zone extending from the river over a distance $x = 3L$ equals 95% of the water entering the aquifer (at $x = 0$); only 5% of the water appears beyond this zone. Both Equation 9.7 and Equation 9.12 contain a damping exponential function ($e^{-x/L}$), which means that the rate of damping is governed by the leakage factor, L. At a distance $x = 4L$, the watertable in the confining layer and the piezometric head in the aquifer will practically coincide and, consequently, the upward flow through the confining layer will be virtually zero. Thus, a knowledge of the value of L is of practical importance.

The question now arises: how can we determine the leakage factor? One method is to conduct one or more aquifer tests (Chapter 10). From the data of such tests, the transmissivity, KD, and the hydraulic resistance, c, can be determined, giving a value of $L = \sqrt{KDc}$.

Another method is to use water-level data collected in double piezometer wells placed in rows perpendicular to the river. Equation 9.7 gives the relation between the hydraulic head difference, $h - h'$, and the distance, x

$$h - h' = (h_0 - h') e^{-x/L}$$

Taking the logarithm and rewriting gives

$$L = \frac{x}{2.30 \{ \log (h_0 - h') - \log (h - h') \}} \quad (9.13)$$

Plotting the observed data of $(h - h')$ against the distance x on single logarithmic

paper (with $h - h'$ on the ordinate with logarithmic scale and x on the abscissa with a linear scale) will give a straight line whose slope is $-1/2.30L$. Such plots thus allow the value of the leakage factor to be determined (Figure 9.4).

The figure refers to a study (Colenbrander 1962) in an area along the River Waal, a branch of the River Rhine. The coarse sandy aquifer is covered by a 12 m thick layer of clayey fine sand, clay, and peat. Three double piezometers were placed in a line perpendicular to the river at distances of 120, 430, and 850 m from the dike. The slope of the straight line equals $-0.2/800$.

The leakage factor is found from

$$2.30L = \frac{800}{0.2}$$

or

$$L = \frac{800}{2.30 \times 0.2} = 1740 \text{ m}$$

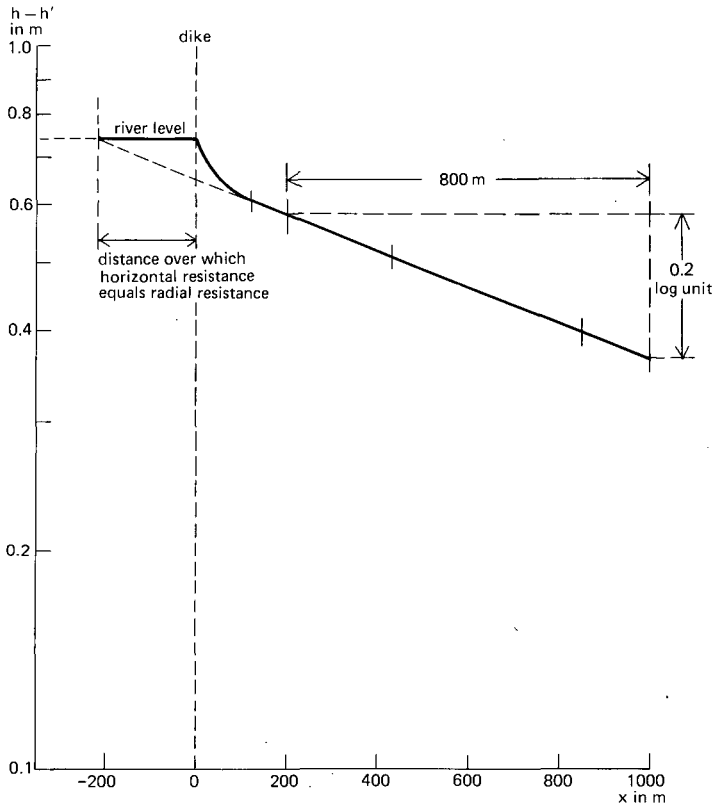

Figure 9.4 Relation between hydraulic head differences and the distance from a river in three double piezometers placed in a semi-confined aquifer

In Figure 9.4 we see that there is a deviation from the straight-line relationship near the river dike. This is because the river channel may be some distance from the dike and may not fully penetrate the aquifer. The assumption of horizontal flow in the aquifer may not hold near the river, but a certain radial flow resistance must still be taken into account. This can be done either by reducing $(h_o - h')$ to an effective value, or by expressing the effect of the radial flow in metres of horizontal flow. In Figure 9.4, the extended straight line intersects the river level at 215 m from the dike; hence the radial resistance due to the river's partial penetration of the aquifer is equal to a horizontal flow resistance over a distance of 215 m.

Example 9.1

For a situation similar to the one shown in Figure 9.2, the following data are available: transmissivity of the aquifer $KD = 2000 \text{ m}^2/\text{d}$, hydraulic resistance of the covering confining layer $c = 1000$ days, the water level in the river $y_o = 10$ m above mean sea level, and the watertable in the confining layer $h' = 8$ m above mean sea level.

Calculate the upward seepage flow in a strip of land extending 1000 m along the river and 500 m inland from the river.

From the above data, we first calculate the leakage factor

$$L = \sqrt{KDc} = \sqrt{2000 \times 1000} = 1414 \text{ m}$$

The upward seepage flow per metre length of the river is found by subtracting the flow through the aquifer at $x = 500$ m (Equation 9.12) from the flow through the aquifer below the river dike (Equation 9.11)

$$q_o - q_x = \frac{KD}{L} (h_o - h') (1 - e^{-x/L})$$

Substituting the relevant values then gives

$$q_o - q_{500} = \frac{2000}{1414} (10 - 8) (1 - e^{-500/1414}) = 0.843 \text{ m}^2/\text{d}$$

For a length of river of 1000 m, the upward seepage is

$$Q = 1000 \times 0.843 = 843 \text{ m}^3/\text{d}$$

or an average seepage rate of

$$\frac{843}{500 \times 1000} = 1.7 \times 10^{-3} \text{ m/d or } 1.7 \text{ mm/d}$$

9.3 Semi-confined Aquifer with Two Different Watertables

Figure 9.5 shows a semi-confined aquifer underlain by an aquiclude and overlain by an aquitard. In the covering confining aquitard, two different watertables occur, h_1' and h_2' ; the transition between them is abrupt. In the right half, there is a vertical downward flow through the confining layer into the aquifer and a horizontal flow through the aquifer towards the left half, where there is a vertical upward flow into

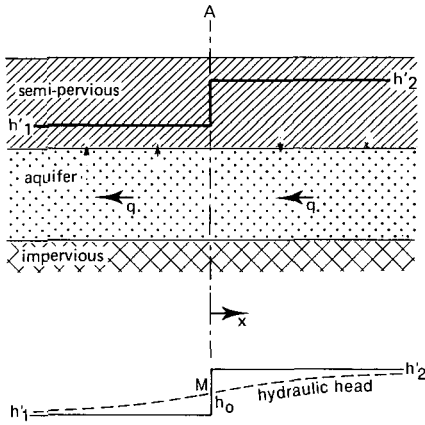

Figure 9.5 Semi-confined aquifer with two different water tables in the overlying aquitard (after Edelman 1972)

the confining layer. The lower part of Figure 9.5 shows the hydraulic head distribution in the aquifer, which is symmetrical about the point M, where

$$h = h_0 = \frac{1}{2}(h'_1 + h'_2) \quad (9.14)$$

This consideration reduces the problem to the previous one. For the right half of the aquifer, we thus obtain (substituting Equation 9.14 into Equation 9.7)

$$h'_2 - h = \frac{h'_2 - h'_1}{2} e^{-x/L} \quad (9.15)$$

and

$$q_x = q_0 e^{-x/L} \quad (9.16)$$

where

$$q_0 = \frac{KD}{L} \frac{h'_2 - h'_1}{2} \quad (9.17)$$

9.4 Seepage through a Dam and under a Dike

9.4.1 Seepage through a Dam

A seepage problem of some practical interest is the flow through a straight dam with vertical faces (Figure 9.6). It is assumed that the dam, with a length L and a width B , rests on an impermeable base. The water levels upstream and downstream of the dam are h_1 and h_2 respectively, with $h_1 > h_2$.

This is a problem of one-dimensional flow (in the x -direction only); its basic differential equation reads (Chapter 7.8.2)

$$\frac{d^2h^2}{dx^2} = 0 \quad (9.18)$$

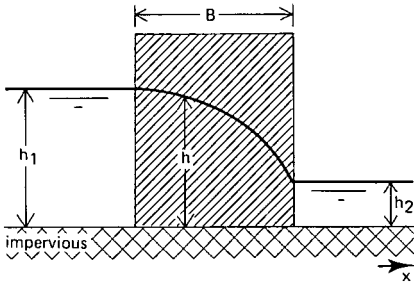

Figure 9.6 Seepage through a straight dam with vertical faces

The general solution to this equation is

$$h^2 = C_1x + C_2 \quad (9.19)$$

where C_1 and C_2 are constants to be determined from the boundary conditions, which are

$$\begin{aligned} \text{for } x = 0, & \quad h = h_1 \\ x = B, & \quad h = h_2 \end{aligned}$$

Substitution into Equation 9.19 gives: $C_2 = h_1^2$ and $C_1 = (h_2^2 - h_1^2)/B$.
Substituting these expressions into Equation 9.19 yields

$$h^2 = h_1^2 - (h_1^2 - h_2^2) \frac{x}{B} \quad (9.20)$$

This equation indicates that the watertable in the dam is a parabola. Using Darcy's law, we can express the seepage through the dam per unit length as

$$q = hv_x = -Kh \frac{dh}{dx} = -\frac{K}{2} \frac{dh^2}{dx}$$

Combined with Equation 9.20, this results in

$$q = \frac{K (h_1^2 - h_2^2)}{2B} \quad (9.21)$$

For a given length L of the dam, the total seepage is

$$Q = \frac{KL (h_1^2 - h_2^2)}{2B} \quad (9.22)$$

This equation is known as the Dupuit formula (as was already derived in Chapter 7.8.2); it gives good results even when the width of the dam B is small and $(h_1 - h_2)$ is large (Verruijt 1982).

9.4.2 Seepage under a Dike

Another seepage problem is the flow from a lake into a reclaimed area under a straight,

impermeable dike that separates the reclaimed area from the lake. The dike rests on an aquitard which, in turn, rests on a permeable aquifer (Figure 9.7).

On the left side of the dike, lake water percolates vertically downward through the aquitard and into the aquifer. The flow through the aquifer is horizontal in the x -direction only (one-dimensional flow). On the right side of the dike, water from the aquifer flows vertically upward through the aquitard into the reclaimed area. Thus, the problem to be solved is: what is the total seepage flow into the reclaimed area?

According to Verruijt (1982), the problem can be solved by dividing the aquifer into three regions:

Region 1: $-\infty < x < -B$

Region 2: $-B < x < +B$

Region 3: $+B < x < +\infty$

To obtain a solution for the flow in these three regions, it is necessary to introduce the values h_2 and h_3 , which represent the hydraulic head in the aquifer at $x = -B$ and $x = +B$ respectively. These heads are still unknown, but can be determined later from continuity conditions along the common boundaries of the three regions.

Region 1

The flow in Region 1 is similar to that in Figure 9.3. This means that, except for the distance x , which must be replaced by $-(x + B)$, Equation 9.8 applies. Hence

$$h = h'_1 - (h'_1 - h_2) e^{\frac{x+B}{L}} \quad (9.23)$$

The groundwater flow per metre length of the dike at $x = -B$ is

$$q = KD \frac{h'_1 - h_2}{L} \quad (9.24)$$

Region 2

In Region 2, the flow rate is constant, so that according to Darcy the groundwater

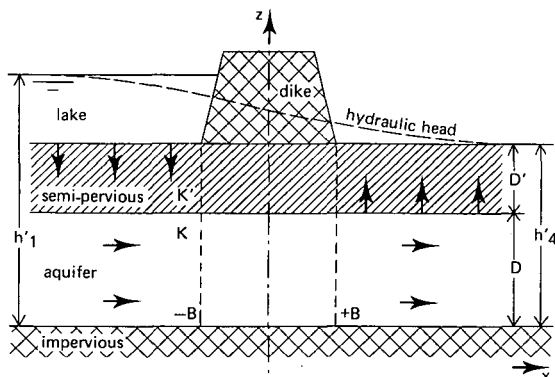

Figure 9.7 Seepage underneath a straight impermeable dike

flow per metre length of the dike in this region is

$$q = KD \frac{h_2 - h_3}{2B} \quad (9.25)$$

Region 3

In Region 3, upward vertical flow occurs from the aquifer through the aquitard. Equation 9.8 can be used if x is replaced by $x - B$, and h' and h_0 by h_4' and h_3 . This gives

$$h = h_4' + (h_3 - h_4') e^{-\frac{x-B}{L}} \quad (9.26)$$

The groundwater flow at $x = B$ is

$$q = KD \frac{h_3 - h_4'}{L} \quad (9.27)$$

The principle of continuity requires that the flows according to Equations 9.24, 9.25, and 9.27 be the same. Thus, the three unknown quantities in these equations (q , h_2 , and h_3) can be solved. The solutions are

$$h_2 = h_1' - \frac{(h_1' - h_4')L}{2B + 2L} \quad (9.28)$$

$$h_3 = h_4' + \frac{(h_1' - h_4')L}{2B + 2L} \quad (9.29)$$

$$q = KD \frac{h_1' - h_4'}{2B + 2L} \quad (9.30)$$

Equation 9.30 gives the seepage into the reclaimed area per metre length of the dike. With the heads h_2 and h_3 known, the hydraulic head in the aquifer at any point can now be calculated with Equations 9.23 and 9.26.

Example 9.2

Calculate the seepage and hydraulic heads at $x = -B$ and $x = +B$ for a situation as shown in Figure 9.7, using the following data: $h_1' = 22$ m, $h_4' = 18$ m, aquifer thickness $D = 15$ m, hydraulic conductivity of the aquifer $K = 15$ m/d, thickness of the confining layer $D' = 3$ m, hydraulic conductivity of the confining layer $K' = 0.005$ m/d, and width of the dike $2B = 30$ m.

The hydraulic resistance of the confining layer $c = D'/K'$, or $3/0.005 = 600$ d. The leakage factor $L = \sqrt{KDc}$, or $\sqrt{15 \times 15 \times 600} = 367$ m. Substituting the appropriate values into Equation 9.30 gives the seepage rate per metre length of the dike

$$q = \frac{15 \times 15 (22 - 18)}{30 + (2 \times 367)} = 1.18 \text{ m}^2/\text{d}$$

The hydraulic heads at $x = -B$ and $x = +B$ are found from Equations 9.28 and 9.29 respectively

$$h_2 = 22 - \frac{(22 - 18) 367}{30 + 734} = 20.08 \text{ m}$$

and

$$h_3 = 18 + \frac{(22 - 18) 367}{30 + 734} = 19.92 \text{ m}$$

9.5 Unsteady Seepage in an Unconfined Aquifer

Some one-dimensional, unsteady flows of practical importance to the drainage engineer are: the interchange of water between a stream or canal and an aquifer in response to a change in water level in the stream or canal, seepage from canals, and drainage flow towards a stream or ditch in response to recharge in the area adjacent to the stream or ditch.

Figure 9.8 shows a semi-infinite unconfined aquifer bounded on the left by a straight, fully-penetrating stream or canal, and bounded below by an impermeable layer.

Under equilibrium conditions, the watertable in the aquifer and the water level in the canal coincide, and there is no flow out of or into the aquifer. A sudden drop in the water level of the canal induces a flow from the aquifer towards the canal. As a result, the watertable in the aquifer starts falling until it reaches the same level as that in the canal. Until this new state of equilibrium has been reached, there is an unsteady, one-dimensional flow from the aquifer into the canal. For the Dupuit assumption to be valid (Chapter 7), we assume that the drop in the watertable is small compared with the saturated thickness of the aquifer. Hence we can assume horizontal flow through the aquifer, and constant aquifer characteristics. This flow problem can be described by the following equations

– Darcy's equation for the flow through the aquifer

$$q = + KD \frac{\partial s}{\partial x} \quad (9.31)$$

which, after differentiation, gives

$$\frac{\partial q}{\partial x} = + KD \frac{\partial^2 s}{\partial x^2} \quad (9.32)$$

– The continuity equation

$$\frac{\partial q}{\partial x} = + \mu \frac{\partial s}{\partial t} \quad (9.33)$$

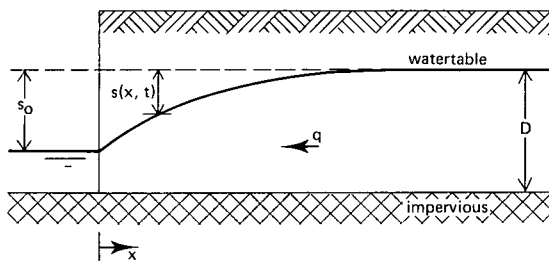

Figure 9.8 Unsteady, one-dimensional flow in a semi-infinite unconfined aquifer

Eliminating $\partial q/\partial x$ from these two equations gives the general differential equation

$$\frac{\partial^2 s}{\partial x^2} = \frac{\mu}{KD} \frac{\partial s}{\partial t} \quad (9.34)$$

where

- s = drawdown in the aquifer (m) positive downwards
- x = distance from the canal (m)
- μ = specific yield of the aquifer (-)
- KD = transmissivity of the aquifer (m^2/d)
- t = time after the change in the water level of the canal (d)

A general solution to this differential equation does not exist and integration is possible only for specific boundary conditions. Edelman (1947, 1972) derived solutions for four different situations:

- A sudden drop in the water level of the canal;
 - The canal is discharging at a constant rate;
 - The water level in the canal is lowered at a constant rate;
 - The canal is discharging at an increasing rate, proportional to time.
- Here we shall consider only the first and the third situations.

9.5.1 After a Sudden Change in Canal Stage

In the case of a sudden drop in the canal stage, the initial and boundary conditions for which the partial differential equation, Equation 9.34, must be solved are

- for $t = 0$ and $x > 0$: $s = 0$
- for $t > 0$ and $x = 0$: $s = s_0$
- for $t > 0$ and $x \rightarrow \infty$: $s = 0$

Edelman (1947) solved this problem by introducing a dimensionless auxiliary variable, u, incorporating x and t as follows

$$u = \frac{1}{2} \sqrt{\frac{\mu}{KD}} \frac{x}{\sqrt{t}} \quad (9.35)$$

The partial differential Equation 9.34 can then be written as the ordinary differential equation

$$\frac{d^2 s}{du^2} + 2u \frac{ds}{du} = 0 \quad (9.36)$$

and for the boundary conditions

- $s = s_0$ $u = 0$
- $s = 0$ $u = \infty$

the solution is

$$s_{x,t} = s_o \left(1 - \frac{2}{\sqrt{\pi}} \int_0^u e^{-u^2} du \right) = s_o E_1(u) \quad (9.37)$$

where $\frac{2}{\sqrt{\pi}} \int_0^u e^{-u^2} du = \text{erf}(u)$ is called the error function.

Tables with values of this function for different values of u are available in mathematical handbooks: e.g. Abramowitz and Stegun (1965), and Jahnke and Emde (1945). Values of the function $E_1(u)$ are given in Table 9.1. A more elaborate table is given by Huisman (1972).

The flow in the aquifer per unit length of canal at any distance x is found by differentiating Equation 9.37 with respect to x , and substituting the result in Darcy's equation according to Equation 9.31. Disregarding the sign for flow direction, we get

$$q_{x,t} = \frac{s_o}{\sqrt{\pi}} \frac{1}{\sqrt{t}} \sqrt{KD\mu} e^{-u^2} \quad (9.38)$$

The discharge from the aquifer into the canal per unit length of canal is found by substituting $x = 0$; thus $u = 0$

$$q_{o,t} = \frac{s_o}{\sqrt{\pi}} \frac{1}{\sqrt{t}} \sqrt{KD\mu} \quad (9.39)$$

so that Equation 9.38 reduces to

$$q_{x,t} = q_{o,t} e^{-u^2} = q_{o,t} E_2(u) \quad (9.40)$$

Values of the function $E_2(u)$ are also given in Table 9.1.

Equation 9.39 gives the discharge from one side of the canal. If the drop in the water level of the canal induces groundwater flow from two sides, the discharge given by Equation 9.39 must be multiplied by two.

Note: The above equations can also be used if the water level in the canal suddenly rises, inducing a flow from the canal into the aquifer, and resulting in a rise in the watertable in the aquifer.

The equations can also be used to calculate either the change in watertable in the aquifer if the hydraulic characteristics are known, or to calculate the hydraulic characteristics if the watertable changes have been measured in a number of observation wells placed in a row perpendicular to the canal.

Example 9.3

Using the following data, calculate the rise in the watertable at 10, 20, 40, 60, 80, and 100 m from the canal 25 days after the water level in the canal has risen suddenly by 1 m: saturated thickness of the aquifer $D = 10$ m, hydraulic conductivity $K = 1$ m/d, and specific yield $\mu = 0.10$.

Table 9.1 Values of the functions $E_1(u)$, $E_2(u)$, $E_3(u)$, and $E_4(u)$

u	$E_1(u)$	$E_2(u)$	$E_3(u)$	$E_4(u)$
0.00	1.0000	1.0000	1.0000	1.0000
0.01	0.9887	0.9999	0.9824	0.9776
0.02	0.9774	0.9996	0.9650	0.9556
0.03	0.9662	0.9991	0.9477	0.9341
0.04	0.9549	0.9984	0.9307	0.9129
0.05	0.9436	0.9975	0.9139	0.8920
0.06	0.9324	0.9964	0.8973	0.8717
0.07	0.9211	0.9951	0.8808	0.8515
0.08	0.9099	0.9936	0.8646	0.8319
0.09	0.8987	0.9919	0.8486	0.8125
0.10	0.8875	0.9900	0.8327	0.7935
0.12	0.8652	0.9857	0.8017	0.7566
0.14	0.8431	0.9806	0.7714	0.7212
0.16	0.8210	0.9747	0.7419	0.6871
0.18	0.7991	0.9681	0.7132	0.6542
0.20	0.7773	0.9608	0.6852	0.6227
0.22	0.7557	0.9528	0.6581	0.5924
0.24	0.7343	0.9440	0.6317	0.5633
0.26	0.7131	0.9346	0.6060	0.5353
0.28	0.6921	0.9246	0.5811	0.5085
0.30	0.6714	0.9139	0.5569	0.4829
0.32	0.6509	0.9027	0.5335	0.4583
0.34	0.6306	0.8908	0.5108	0.4346
0.36	0.6107	0.8784	0.4888	0.4121
0.38	0.5910	0.8655	0.4675	0.3906
0.40	0.5716	0.8521	0.4469	0.3699
0.42	0.5525	0.8383	0.4270	0.3501
0.44	0.5338	0.8240	0.4077	0.3314
0.46	0.5153	0.8093	0.3891	0.3133
0.48	0.4973	0.7942	0.3712	0.2963
0.50	0.4795	0.7788	0.3539	0.2799
0.52	0.4621	0.7631	0.3372	0.2643
0.54	0.4451	0.7471	0.3211	0.2495
0.56	0.4284	0.7308	0.3056	0.2353
0.58	0.4121	0.7143	0.2907	0.2219

Table 9.1 (cont.)

u	$E_1(u)$	$E_2(u)$	$E_3(u)$	$E_4(u)$
0.60	0.3961	0.6977	0.2764	0.2089
0.62	0.3806	0.6809	0.2626	0.1969
0.64	0.3654	0.6639	0.2494	0.1853
0.66	0.3506	0.6469	0.2367	0.1743
0.68	0.3362	0.6298	0.2245	0.1639
0.70	0.3222	0.6126	0.2129	0.1541
0.72	0.3086	0.5955	0.2017	0.1448
0.74	0.2953	0.5783	0.1910	0.1358
0.76	0.2825	0.5612	0.1807	0.1275
0.78	0.2700	0.5442	0.1710	0.1195
0.80	0.2579	0.5273	0.1616	0.1120
0.82	0.2462	0.5105	0.1527	0.1049
0.84	0.2349	0.4938	0.1441	0.0982
0.86	0.2239	0.4773	0.1360	0.0919
0.88	0.2133	0.4610	0.1283	0.0860
0.90	0.2031	0.4449	0.1209	0.0803
0.92	0.1932	0.4290	0.1139	0.0750
0.94	0.1837	0.4133	0.1072	0.0700
0.96	0.1746	0.3979	0.1008	0.0654
0.98	0.1658	0.3827	0.0948	0.0609
1.00	0.1573	0.3679	0.0891	0.0568
1.02	0.1492	0.3533	0.0836	0.0529
1.04	0.1414	0.3391	0.0785	0.0492
1.06	0.1339	0.3251	0.0736	0.0458
1.08	0.1267	0.3115	0.0690	0.0426
1.10	0.1198	0.2982	0.0646	0.0396
1.14	0.1069	0.2726	0.0566	0.0341
1.18	0.0952	0.2485	0.0494	0.0293
1.22	0.0845	0.2257	0.0431	0.0252
1.26	0.0748	0.2044	0.0374	0.0215
1.30	0.0660	0.1845	0.0325	0.0184
1.34	0.0581	0.1660	0.0281	0.0156
1.38	0.0510	0.1489	0.0242	0.0133
1.42	0.0446	0.1331	0.0208	0.0113
1.46	0.0389	0.1186	0.0179	0.0095

Table 9.1 (cont.)

u	$E_1(u)$	$E_2(u)$	$E_3(u)$	$E_4(u)$
1.50	0.0339	0.1054	0.0153	0.0080
1.60	0.0237	0.0773	0.0102	0.0052
1.70	0.0162	0.0556	0.0067	0.0033
1.80	0.0109	0.0392	0.0044	0.0021
1.92	0.0066	0.0251	0.0025	0.0011
2.00	0.0047	0.0183	0.0017	0.0007
2.10	0.0030	0.0122	0.0011	0.0005
2.20	0.0019	0.0079	0.0006	0.0003
2.30	0.0012	0.0050	0.0004	0.0002
2.40	0.0007	0.0032	0.0002	0.0001
2.50	0.0004	0.0019	0.0001	0.0000

The transmissivity of the aquifer $KD = 1 \times 10 = 10 \text{ m}^2/\text{d}$ is assumed to be constant, although, with the rise of the watertable, the saturated thickness D , and hence KD , increases slightly to, say, $10.5 \text{ m}^2/\text{d}$. Substituting into Equation 9.35 gives

$$u = \frac{x}{2} \sqrt{\frac{0.10}{10}} \frac{1}{\sqrt{25}} = 0.01 x$$

For the given distances of x , the value of u is calculated and the corresponding values of $E_1(u)$ are read from Table 9.1. Substitution of these values and $s_0 = 1 \text{ m}$ into Equation 9.37 yields the rise in the watertable after 25 days at the given distances from the canal (Table 9.2).

Example 9.4

Analyzing the change in the watertable caused by a sudden rise or fall of the water level in a canal makes it possible to determine the aquifer characteristics. For this purpose, the change in watertable is measured in a few observation wells placed in a line perpendicular to the canal. Suppose three observation wells are placed at distances of 10, 20, and 40 m from the canal. At $t < 0$, the watertable in the aquifer has the same elevation as the water level in the canal. At $t = 0$, the water level in

Table 9.2 The rise in the watertable after 25 days

Distance x (m)	u (-)	$E_1(u)$ (Table 9.1) (-)	Watertable rise (m)
10	0.1	0.8875	0.89
20	0.2	0.7773	0.78
40	0.4	0.5716	0.57
60	0.6	0.3961	0.40
80	0.8	0.2579	0.26
100	1.0	0.1573	0.16

Table 9.3 Observed rise in the watertable (m) in three wells

Distance of observation well (m)	Time since rise in canal stage (d)				
	t = 0.5	t = 1	t = 2	t = 3	t = 4
10	0.25	0.29	0.32	0.34	0.35
20	0.13	0.19	0.25	0.26	0.27
40	0.02	0.065	0.125	0.165	0.19

the canal suddenly rises by an amount $s_0 = 0.50$ m. The watertable measurements made in the three observation wells are given in Table 9.3.

Calculate the transmissivity of the aquifer, assuming that its specific yield $\mu = 0.10$. Analyze the flow in the vicinity of the canal. Calculate the seepage from the canal at $t = 1$ d and $t = 4$ d.

Equations 9.35 and 9.37 indicate that $\log(s/s_0)$ varies with $\log(x/\sqrt{t})$ in the same manner as $\log E_1(u)$ varies with $\log u$. Solving Equation 9.35 for μ/KD therefore requires matching a logarithmic data plot of s/s_0 ratios against their corresponding values of x/\sqrt{t} to a logarithmic type curve drawn by plotting values of $E_1(u)$ against corresponding values of u . The type curve is drawn with the aid of Table 9.1. To prepare the logarithmic data plot of s/s_0 versus x/\sqrt{t} , we use the data from Table 9.3:

	Time since rise in canal stage (d)				
	t = 0.5	t = 1	t = 2	t = 3	t = 4
For x = 10 m					
x/\sqrt{t}	14.1	10.0	7.1	5.8	5.0
s/s_0	0.50	0.58	0.64	0.68	0.70
For x = 20 m					
x/\sqrt{t}	28.3	20.0	14.1	11.5	10.0
s/s_0	0.26	0.38	0.50	0.52	0.54
For x = 40 m					
x/\sqrt{t}	56.6	40.0	28.3	23.1	20.0
s/s_0	0.04	0.13	0.25	0.33	0.38

We now plot these data on another sheet of double logarithmic paper with the same scale as that used to prepare the type curve of $E_1(u)$. We then superimpose the two sheets and, keeping the coordinate axes parallel, we find a position in which all (or most) of the field-data points fall on a segment of the type curve (Figure 9.9). As match point, we select the point z with logarithmic type curve coordinates $u = 0.1$, $E_1(u) = 1.0$. On the field-data plot, this point has the coordinates $x/\sqrt{t} = 4$ and $s/s_0 = 0.8$.

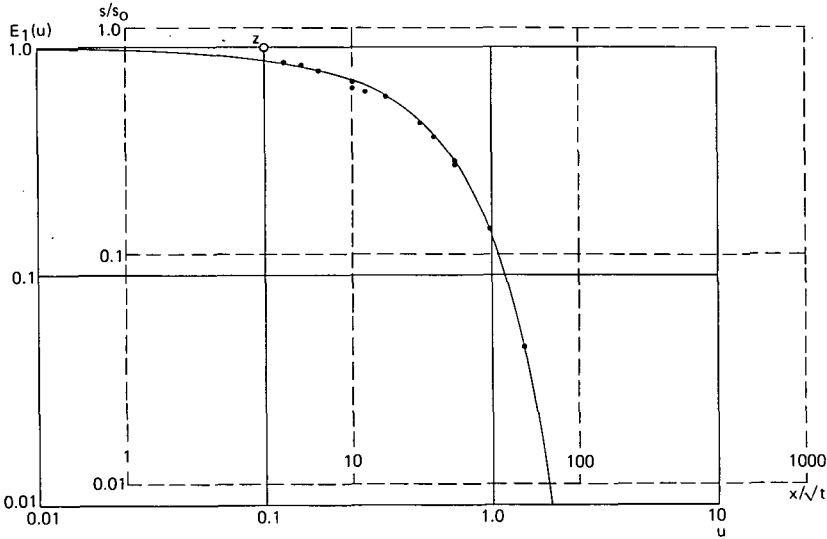

Figure 9.9 Observed data plot s/s_0 versus x/\sqrt{t} (points and dotted lines) superimposed on logarithmic type curve $E_1(u)$ -versus- u (curve and solid lines)

Substituting these values into Equation 9.35 yields

$$\sqrt{\frac{KD}{\mu}} = \frac{x}{2\sqrt{t}} \frac{1}{u} = \frac{4}{2} \times \frac{1}{0.1} = 20$$

For $\mu = 0.10$, it follows that $KD = 400 \times 0.1 = 40 \text{ m}^2/\text{d}$.

According to Equation 9.37, the ratio $s/s_0 = E_1(u)$. If $E_1(u) = 1$, it follows that $s = s_0$. Only at the edge of the canal (at $x = 0$) is $s = s_0$. From the coordinates of the match point z , however, it follows that, for $E_1(u) = 1$, the ratio $s/s_0 = 0.8$. This means that $s = 0.8 s_0$, or $s = 0.8 \times 0.5 = 0.4 \text{ m}$. At the edge of the canal, the watertable is therefore $0.5 - 0.4 = 0.1 \text{ m}$ less than expected. The value of 0.1 m is the head loss due to radial flow in the vicinity of the canal, because the canal does not fully penetrate the aquifer.

The seepage from the canal after 1 and 4 days is found from Equation 9.39. Substituting the appropriate values into this equation gives

for $t = 1 \text{ day}$

$$q_{0,1} = \frac{s_0}{\sqrt{\pi t}} \sqrt{KD\mu} = \frac{0.4}{\sqrt{3.14 \times 1}} \sqrt{40 \times 0.1} = 0.45 \text{ m}^2/\text{d}$$

for $t = 4 \text{ days}$

$$q_{0,4} = \frac{0.4}{\sqrt{3.14 \times 4}} \sqrt{40 \times 0.1} = 0.23 \text{ m}^2/\text{d}$$

Remarks

If a canal penetrates an aquifer only partially, as is usually the case, watertable readings from observation wells placed too close to the canal may give erroneous results. The smaller the distance between the observation well and the canal, the greater the error in the calculated value of μ/KD . As is obvious, an instantaneous rise or fall in the canal level can hardly occur, which makes it difficult to determine a reference or zero time (Ferris et al. 1962). This means that observations made shortly after the change in canal stage may be unreliable. With partially penetrating canals, therefore, more weight should be given to data from wells at relatively great distances from the canal and to large values of time. However, observation wells at great distances react slowly to a relatively small change in canal stage, and it may take several days before noticeable watertable changes occur. This may be another source of error, especially when the aquifer is recharged by rain or is losing water through evapotranspiration. The solution is based on the assumption that water losses or gains do not occur. A field experiment should therefore not last longer than, say, two or three days to avoid errors caused by such water losses or gains.

9.5.2 After a Linear Change in Canal Stage

The condition of an abrupt change in the water level of a canal or stream is rather unrealistic, except perhaps in an irrigation area where some of the canals are alternately dry and filled relatively quickly when irrigation is due. A more realistic situation is a canal stage that is a function of time. In this section, a solution will be given for the situation where the change in water level of a canal is proportional to time; in other words, the water level changes at a linear rate, denoted by α .

Hence

$$s_o = \alpha t \quad (9.41)$$

so that the initial and boundary conditions for which Equation 9.34 must be solved are

$$\begin{aligned} \text{for } t = 0 \text{ and } x > 0 & : s = 0 \\ \text{for } t > 0 \text{ and } x = 0 & : s = s_o = \alpha t \\ \text{for } t > 0 \text{ and } x \rightarrow \infty & : s = 0 \end{aligned}$$

The solution then becomes

$$s_{x,t} = s_{o,t} E_4(u) \quad (9.42)$$

where

$$E_4(u) = - \frac{2u}{\sqrt{\pi}} E_2(u) + (2u^2 + 1) E_1(u)$$

and

$$q_{o,t} = \frac{2s_{o,t}}{\sqrt{\pi}} \frac{1}{\sqrt{t}} \sqrt{KD\mu} \quad (9.43)$$

$$q_{x,t} = q_{o,t} E_3(u) \quad (9.44)$$

Table 9.4 The rise in the watertable at $x = 25$ m shown at 5-day intervals from the beginning of the rise in the canal stage

Time after $t = 0$ (d)	u (-)	E_4 (-)	$s_{0,t}$ (m)	$s_{25,t}$ (m)
1	1.25	0.0224	0.04	0.00
5	0.56	0.2353	0.20	0.05
10	0.40	0.3699	0.40	0.15
15	0.32	0.4583	0.60	0.28
20	0.28	0.5085	0.80	0.41
25	0.25	0.5492	1.00	0.55

where

$$E_3(u) = E_2(u) - u \sqrt{\pi} E_1(u)$$

Values for the functions $E_3(u)$ and $E_4(u)$ are given in Table 9.1, as well as by Huisman (1972). Equation 9.43 gives the discharge for one side of the canal. If the drop in the canal stage induces groundwater flow from two sides, the discharge given by Equation 9.43 must be multiplied by two.

The solution is also valid for a linearly rising canal stage.

Example 9.5

Suppose that in the situation described in Example 9.3 the canal stage had not risen suddenly at $t = 0$, but has risen as a function of time, reaching a rise of 1 m after 25 days. Calculate the rise in the watertable at a point $x = 25$ m from the canal after 1, 5, 10, 15, 20, and 25 days. Also calculate the seepage from one side of the canal per metre length on the 5th day.

For $s_0 = 1$ m and $t = 25$ days, the proportionality factor α in Equation 9.41 is

$$\alpha = \frac{1}{25} = 0.04$$

For the distance $x = 25$ m and the given times t for which the watertable rise is to be calculated, the value of u is computed with Equation 9.35. For each value of u , the corresponding value of $E_4(u)$ is read from Table 9.1. The water level in the canal at time t is found from Equation 9.41, with the proportionality factor $\alpha = 0.04$. Substituting this value and the value of $E_4(u)$ into Equation 9.42 gives the rise in the watertable (Table 9.4).

9.6 Periodic Water-Level Fluctuations

9.6.1 Harmonic Motion

In some instances, the variations in the level of bodies of surface water are periodic. Examples are the twice-daily variation in the level of oceans, seas, and coastal rivers due to the tide.

The rise and fall of the sea level induces corresponding variations in groundwater pressure in underlying or adjacent aquifers. If the sea level varies with a simple harmonic motion, which is usually expressed as a sine or cosine function, a sequence of sinusoidal waves is propagated inland from the submarine outcrop of the aquifer. Water levels in observation wells placed in the aquifer at different distances from the coastline or river bank will therefore show a similar sinusoidal motion. However:

- The amplitude of the sinusoides decreases with the distance from the sea or river; in other words, the waves are damped inland;
- The time lag (phase shift) of a given maximum or minimum water level increases inland.

It is clear that there must be a relationship between the damping and the phase shift on the one hand and the aquifer characteristics on the other. An analysis of the propagation of tidal waves through an aquifer allows these characteristics to be determined. The only data required are water-level records from some observation wells placed at various distances in a line perpendicular to the coast or river. The records must cover at least half a cycle so that phase shift and damping can be determined. Preferably, several full cycles should be recorded and their average values used, because the damping and phase shift may be different for the maximum and the minimum of the curve.

The harmonic motion of the sea level (Figure 9.10) can be described by

$$y_o = \bar{y} + A \sin \omega t$$

where

y_o = water level with respect to a certain reference level (m)

\bar{y} = mean height of the water level with respect to the same reference level (m)

A = amplitude of the tidal wave, i.e. half range of the sea level change (m)

$\omega = 2\pi/T =$ wave frequency (d^{-1})

$T =$ period required for a full cycle (d)

$t =$ time elapsed from a convenient reference point within any cycle (d)

The analysis of tidal waves will be discussed in Chapter 24.

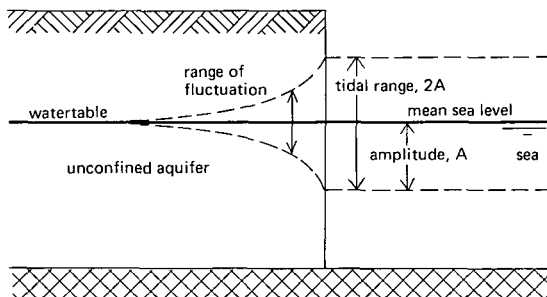

Figure 9.10 Watertable fluctuations induced by ocean tides

Assuming that the storage of water through compression effects in the aquifer is negligible, Steggewentz (1933) derived the following equation for the hydraulic head in an aquifer at a distance x from the coast or tidal river, and at a time t

$$h(x,t) = \bar{h} + A e^{-ax} \sin(\omega t - bx) \quad (9.46)$$

where

$$\begin{aligned} h(x,t) &= \text{hydraulic head in the aquifer at distance } x \text{ and at time } t \text{ (m)} \\ \bar{h} &= \text{mean hydraulic head in the aquifer at distance } x \text{ (m)} \\ bx &= \text{phase shift, expressed in radians (-)} \\ e^{-ax} &= \text{amplitude reduction factor (-)} \end{aligned}$$

Both damping and phase shift depend on the distance x from the open water ($x = 0$ at the boundary of land and water).

Differentiating Equation 9.46 with respect to x and t , and substituting the result into the differential equation describing the groundwater flow, yields the relation between the constants a and b , and the aquifer characteristics, as shown in the following sections.

9.6.2 Tidal Wave Transmission in Unconfined Aquifers

Steggewentz (1933) found for the relation between a , b , and the aquifer characteristics of an unconfined aquifer that

$$a = b = \sqrt{\frac{\mu\omega}{2KD}} \quad (9.47)$$

where

$$\begin{aligned} a &= \text{amplitude damping coefficient (m}^{-1}\text{)} \\ b &= \text{phase shift coefficient (m}^{-1}\text{)} \\ \mu &= \text{specific yield of the aquifer (-)} \\ KD &= \text{transmissivity of the aquifer (m}^2\text{/d)} \\ \omega &= \text{frequency of the tidal wave (d}^{-1}\text{)} \end{aligned}$$

Note that in an unconfined aquifer the damping and the phase shift are the same. If this is not so, the aquifer is semi-confined.

9.6.3 Tidal Wave Transmission in a Semi-Confined Aquifer

When considering the propagation of a tidal wave through confined or semi-confined aquifers, we must take into account the compressibility of the water and the solid medium. In doing so, Jacob (1940, 1950) derived expressions for the propagation of tidal fluctuations through a completely confined aquifer. Bosch (1951) extended Jacob's theory to semi-confined aquifers by including the effect of leakage through the confining layer covering the aquifer. The situation is similar to that shown in Figure 9.1 except that the water level in the river, y_0 , fluctuates periodically with a range

2A. (The half range or amplitude of the tidal wave is thus A). The differential equation that describes this flow problem reads as follows

$$\frac{\partial^2 h}{\partial x^2} - \frac{h - h'}{KDc} - \frac{S}{KD} \frac{\partial h}{\partial t} = 0 \quad (9.48)$$

where

h = the hydraulic head in the aquifer (m)

h' = the watertable elevation in the confining layer (which is assumed to remain constant) (m)

S = the storativity of the aquifer (-)

x = the distance from the river, measured along a line perpendicular to the river (m)

t = time (d)

All other symbols are as defined earlier.

The storativity of a saturated confined aquifer was defined in Chapter 2.3.1. In unconfined aquifers, the storativity, S , is considered equal to the specific yield, μ , because the effects of aquifer compression and water expansion are generally negligible.

A decrease in hydraulic head infers a decrease in hydraulic or water pressure, p_h , and an increase in intergranular pressure, p_i (see Chapter 13.3). If h decreases, the water released from storage is produced by two mechanisms:

- The compression of the aquifer caused by increasing p_i ;
- The expansion of the water caused by decreasing p_h .

The first of these mechanisms is controlled by the compressibility of the aquifer, α , and the second by the compressibility of the water, β . This leads to the concept of specific storage

$$S_s = \rho g (\alpha + \varepsilon \beta) \quad (9.49)$$

where

S_s = specific storage (m^{-1})

α = compressibility of the aquifer (Pa^{-1})

β = compressibility of the water (Pa^{-1})

ρ = density of water (kg/m^3)

g = acceleration due to gravity (m/s^2)

ε = porosity of the aquifer material (-)

The storativity of the aquifer is then defined as

$$S = S_s D \quad (9.50)$$

which, when substituted into Equation 9.49, becomes

$$S = \rho g D (\alpha + \varepsilon \beta) \quad (9.51)$$

Since the compressibility is the inverse of the modulus of elasticity, Equation 9.51 may also be written as

$$S = \rho g D \left(\frac{1}{E_a} + \frac{\varepsilon}{E_w} \right) \quad (9.52)$$

where

E_a = modulus of elasticity of the aquifer material (Pa)

E_w = modulus of elasticity of water (Pa)

The compressibility α of sand is in the range of 10^{-7} to 10^{-9} Pa⁻¹, and the compressibility of water, β , can be taken as 4.4×10^{-10} Pa⁻¹.

The solution of Equation 9.48 is

$$h(x,t) = h' + A e^{-ax} \sin(\omega t - bx) \quad (9.53)$$

Differentiating with respect to x and t and substituting the result into Equation 9.48 yields

$$\begin{aligned} (a^2 - b^2) \sin(\omega t - bx) + 2ab \cos(\omega t - bx) - \frac{1}{KDc} \sin(\omega t - bx) \\ - \frac{\omega S}{KD} \cos(\omega t - bx) = 0 \end{aligned} \quad (9.54)$$

For this equation to be valid for all values of x and t , the constants a and b must satisfy the following conditions

$$a^2 - b^2 = \frac{1}{KDc} \quad (9.55)$$

$$2ab = \frac{\omega S}{KD} \quad (9.56)$$

These relations indicate that if the constants a and b can be determined from field observations, the hydraulic characteristics KDc and S/KD can be calculated.

Example 9.6

The horizontal propagation of tidal fluctuations emanating from the River Waal in The Netherlands has been measured in an adjacent semi-confined aquifer. The 34 m thick aquifer consists of coarse sands with intercalations of fine sand. The aquifer is overlain by a 12 m thick confining layer of clayey fine sands and heavy basin clays, with intercalations of peat. It is underlain by a layer of heavy clay, which is assumed to be impermeable.

Figure 9.11 shows the hydrographs of some of the piezometers that were placed in the aquifer along a line perpendicular to the river.

From these hydrographs, we read the amplitude A and, by comparing the hydrographs of the piezometers with the hydrograph of the river, we can determine the time lag of each piezometer. To express the phase shift in radians, we multiply the time lag t by $2\pi/T$.

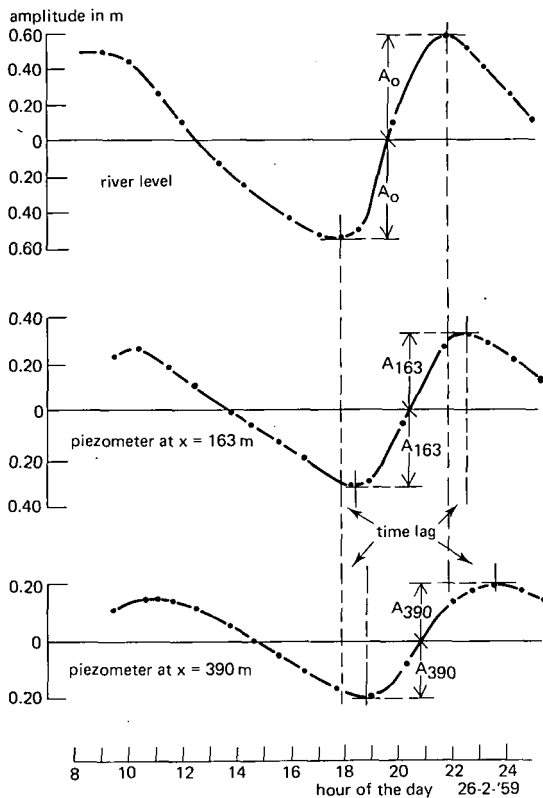

Figure 9.11 Hydrographs of the River Waal and of two piezometers at 163 and 390 m from the river (after Wesseling and Colenbrander 1962)

Note that the time lag after low tide is less than that after high tide. The average time lag and the average amplitude are therefore used in the calculations.

From Equation 9.53, it is clear that the amplitude A_0 at $x = 0$ and the amplitude A_x at any arbitrary value of x are related as follows

$$A_x = A_0 e^{-ax}$$

In other words, the amplitude ratio is

$$\frac{A_x}{A_0} = e^{-ax}$$

or

$$\ln \frac{A_x}{A_0} = -ax \tag{9.59}$$

This expression indicates that, when plotting the natural logarithm of the amplitude ratio as a function of the distance x to the river, we find a straight line whose slope, a , can be determined. Theoretically, this line should pass through the origin, since at $x = 0$, $A_x = A_0$, and $\ln A_x/A_0 = \ln 1 = 0$. In practice, this hardly ever happens

because of the entry resistance at the river. A thin resisting layer may be present at the outcrop, or the river may only partially penetrate the aquifer.

When we plot the phase shift (in radians) against the distance x to the river, we obtain a straight line whose slope b can be determined. Figure 9.12 shows these plots of the amplitude ratios and phase shifts for three piezometers at different distances from the river.

From Figure 9.12, we find that the slope of the amplitude ratio line

$$a = \frac{1}{430} = 2.3 \times 10^{-3}$$

and the slope of the phase shift line

$$b = \frac{0.9}{600} = 1.5 \times 10^{-3}$$

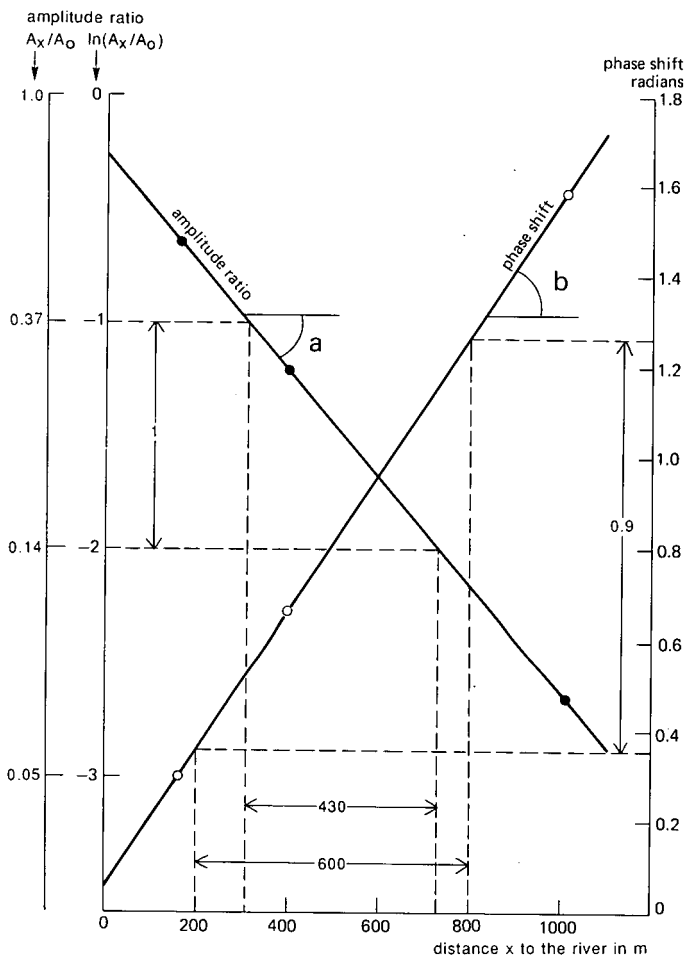

Figure 9.12 Relation between amplitude ratio and phase shift, and the distance of three piezometers placed in a row perpendicular to the River Waal (after Wesseling and Colenbrander 1962)

With a and b known, we can now calculate the leakage factor $L = \sqrt{KDc}$, using Equation 9.55

$$\frac{1}{KDc} = a^2 - b^2 = (2.3 \times 10^{-3})^2 - (1.5 \times 10^{-3})^2 = 3.04 \times 10^{-6}$$

$$KDc = 328\,947 \text{ m}^2$$

$$L = \sqrt{328947} = 574 \text{ m}$$

From Equation 9.56 we find

$$\frac{S}{KD} = \frac{2ab}{\omega} = \frac{2 \times 2.3 \times 10^{-3} \times 1.5 \times 10^{-3}}{2 \times (3.14/0.5)} = 5.5 \times 10^{-7} \text{ d/m}^2$$

Remarks

For accurate determinations of the maximum and minimum water levels in the sea, in a tidal river, and in piezometers, frequent observations must be made at high and low tide. Accurate hydrographs (as shown in Figure 9.11) can be obtained with automatic water-level recorders. If, for some reason, water-level measurements cannot be made in the sea or tidal river, the data from the piezometer nearest to the sea or river can be used as a reference for calculating the amplitude ratios and phase shifts of the piezometers farther inland.

9.7 Seepage from Open Channels

In irrigation areas, the water level in the canals is, in general, higher than the watertable of the adjacent land. Owing to this head difference, seepage occurs from the canals to the adjacent land. Analytical solutions for steady-state seepage from open channels have been developed by a number of investigators. For instance, Vedernikov (1934) gave solutions to the problem of seepage from trapezoidal channels to drainage layers at finite and infinite depths. Dachler (1936) presented a solution for the seepage from a canal embedded in uniform soil with a shallow watertable, consequently causing the watertable to merge with the water level in the canal. Kozeny (1931) treated the seepage from canals with a curvilinear cross section in infinitely deep soil without a watertable.

Bouwer (1965, 1969) studied the seepage from open channels, using electric resistance network analogs. Bouwer's approach covers a wider range of soil conditions, depths and shapes of the channel, and watertable positions than the earlier studies. He also presented graphs that are more readily applicable. We shall therefore review part of his work. For more details, we refer the reader to Bouwer's papers cited above.

9.7.1 Theoretical Models

Seepage from channels is a dynamic process that is complicated by a variety of factors: e.g. non-uniformity of soil, water quality, erosion, sedimentation, soil permeability, fluctuating watertables and water levels in the canals, and periodic filling and drying

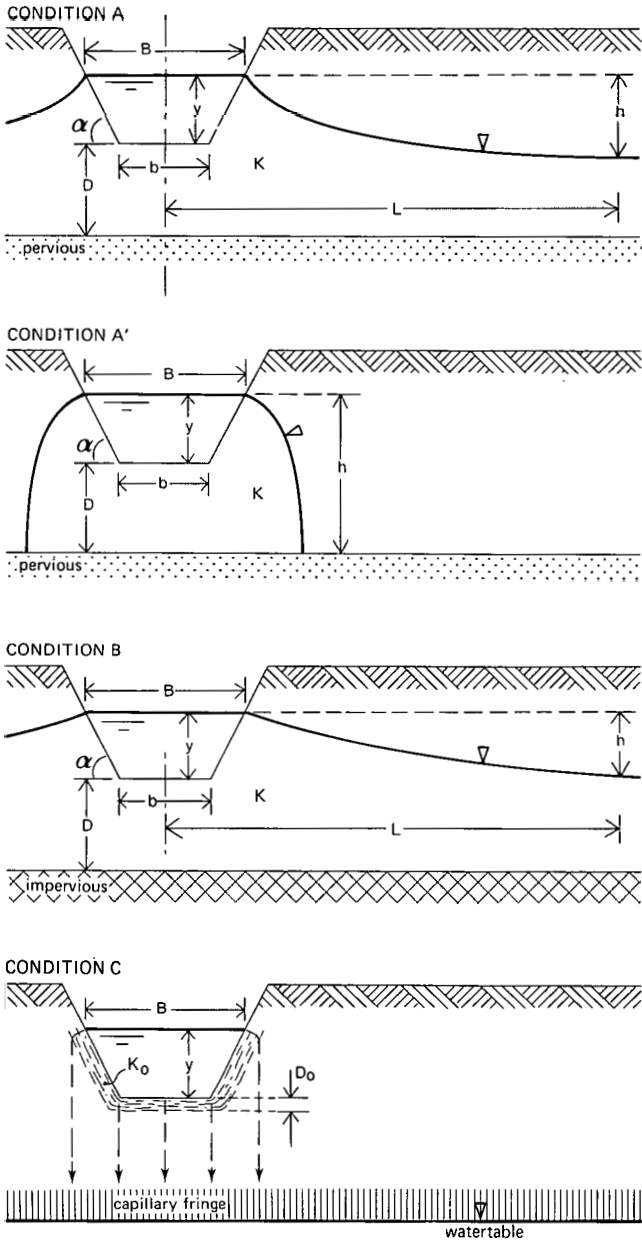

Figure 9.13 Geometry and symbols for Seepage Conditions A, A', B, and C (after Bouwer 1965, 1969)

up of the canals. To obtain solutions to seepage problems, Bouwer recognized that simplifications of the actual field situations must be introduced. Accordingly, he distinguished the following basic seepage models (Figure 9.13).

Condition A: The soil in which the channel is embedded is uniform and is underlain

by a layer that is more permeable than the overlying soil. (That layer is considered infinitely permeable.) If the watertable is at or below the top of the permeable underlying layer, Condition A reduces to the case of seepage to a free-draining layer, where $h = y + D$. This will be referred to as Condition A'.

Condition B: The soil in which the channel is embedded is uniform and is underlain by a layer that is less permeable than the overlying soil. (That layer is considered impermeable.)

Condition C: The soil in which the channel is embedded is much less permeable than the original soil, because sedimentation has formed a thin layer of low permeability at the channel perimeter (clogged soil, compacted soil linings).

9.7.2 Analog Solutions

Bouwer's studies of canal seepage with a resistance network analog included analyses of Conditions A, A', and B. The solutions he found apply to steady-state conditions. In reality, however, canal seepage is seldom steady because of changing water levels in the canal, changing watertables, etc. Thus, the steady-state conditions covered by the analyses represent individual pictures of a system which, in reality, tends to be continuously unsteady.

Mathematically, the above seepage problems are treated with lateral boundaries at infinity. In reality, this is impractical because physical barriers, e.g. other canals or streams, may be present. Finite lateral boundaries should be used instead.

For Condition A: The slope of the watertable decreases as the distance from the canal increases, and reaches zero at infinity. For practical purposes, the slope of the watertable can be considered zero at a finite distance from the canal. Bouwer used an arbitrary distance $L = 10b$, from the centre of the canal. The head at this point is h . The watertable is considered a solid boundary, i.e. it is assumed that the movement of the watertable over the distance $10b$ is sufficiently small for flow components normal to the watertable to be insignificant.

For Condition A, the lower limit of the watertable is at the top of the permeable layer, where $h = y + D$, and Condition A' is reached. Even if the watertable were to be below the top of the permeable layer, the pressure at the top of this layer would still be zero (atmospheric).

For Condition B: As the flow approaches uniform flow, the slope of the watertable at a sufficient distance from the canal becomes essentially constant. Thus the lateral boundary for the flow system can be represented by a vertical equipotential, which Bouwer also took at a distance of $10b$ from the centre of the canal. From test results, he found that this distance was sufficiently long for the establishment of an essentially horizontal watertable for Condition A, and a watertable with essentially constant slope for Condition B. The practical implications are that at $L = 10b$ the direct effect of the seepage on the watertable is insignificant, and that the position of the watertable at that point can be regarded as indicative of the 'original' watertable position controlling the flow system adjacent to the canal.

For practical purposes, the underlying layer can be treated as infinitely permeable (Condition A) if its hydraulic conductivity, K , is ten times greater than that of the overlying layer. The underlying layer can be treated as impermeable (Condition B) if its hydraulic conductivity, K , is ten times less than that of the overlying material. In the analog studies, the values of y , h , and D were varied. The seepage for the condition of an infinitely deep, uniform soil ($D = \infty$) was evaluated by extrapolating D to infinity for the analysis of Condition A.

The analog analyses were performed for trapezoidal canals with a 1:1 side slope ($\alpha = 45^\circ$) and three different water depths (expressed as y/b).

The seepage rates, measured as electric current, were converted to volume rate of seepage, q_s , per unit length of canal. These rates were divided by the water-surface width of the canal, B , to yield the rate of fall, I_s , of the water surface due to seepage, as if the canal were ponded. The term I_s is expressed per unit hydraulic conductivity of the soil, K , in which the canal is embedded to yield the dimensionless parameter, I_s/K . To yield dimensionless terms, all length dimensions are expressed as ratios to the bottom width b of the canal.

Figure 9.14 shows the graphs of I_s/K -versus- h/b for different values of D/b for three different water depths, expressed as y/b .

Example 9.7

Calculate the seepage from a trapezoidal canal embedded in a soil whose hydraulic conductivity $K = 0.5$ m/d. The soil layer is underlain by a highly permeable layer at 8 m below the bottom of the canal. The water depth in the canal is 1 m, the bottom width of the canal is 2 m, and the surface water width is 4 m. The watertable at 20 m

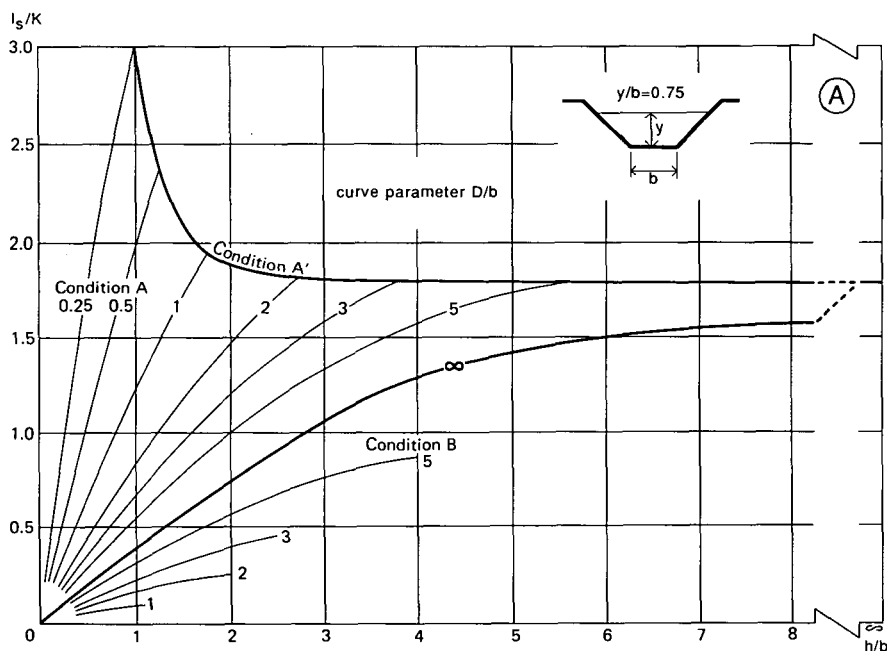

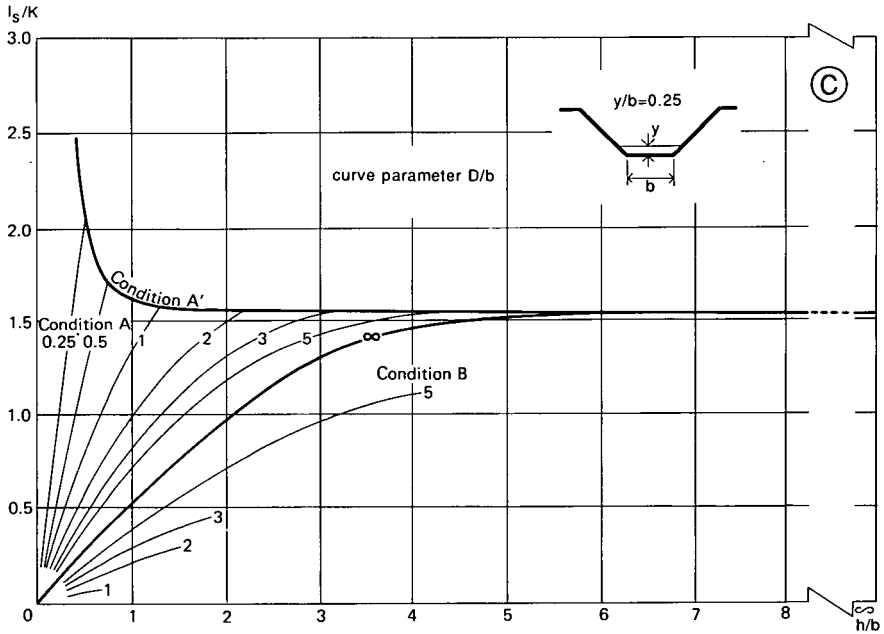
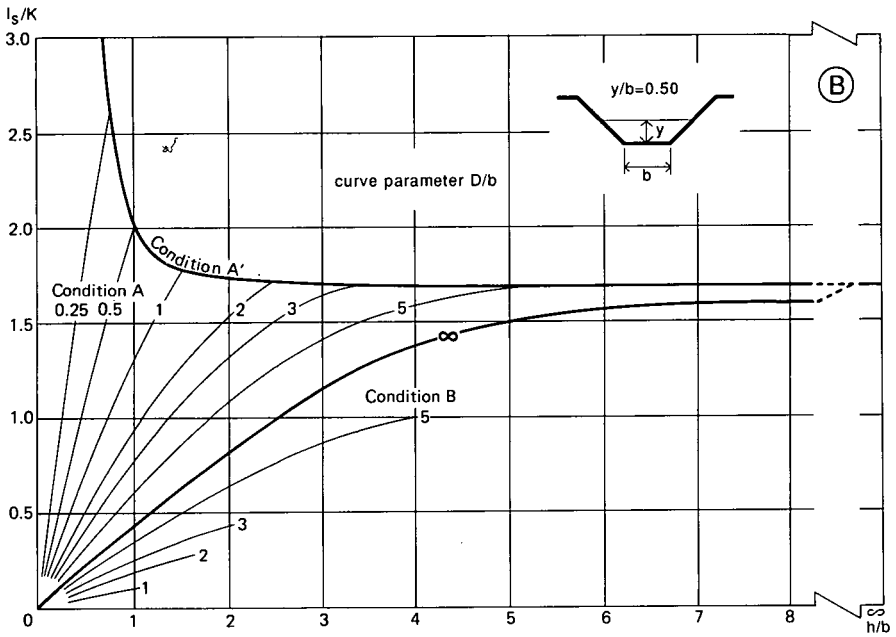

Figure 9.14 Results of seepage analyses with electric analogs for trapezoidal canal with 1:1 side slopes ($\alpha = 45^\circ$) at three different canal stages (after Bouwer 1965, 1969)
 A: $y/b = 0.75$; B: $y/b = 0.50$; C: $y/b = 0.25$

from the canal is 5 m below the water surface in the canal. Thus: $h = 5$ m, $y = 1$ m, $b = 2$ m, $D = 8$ m and $B = 4$ m.
Hence, $h/b = 5/2 = 2.5$, and $D/b = 8/2 = 4$. Since $y/b = 0.5$, we use Figure 9.14B and find that $I_s/K = 1.4$, which, for $K = 0.5$ m/d, and $B = 4$ m, gives a seepage loss per metre length of canal:

$$q_s = 1.4 \times 0.5 \times 4 = 2.8 \text{ m}^2/\text{d}$$

Figure 9.15 shows examples of flow systems (streamlines and equipotential lines) for Conditions A, A', and B, as obtained by electric analog analyses.

The curves for Condition A' in Figure 9.14 are the loci of the end points of the curves for Condition A. At these points, $h = D + y$, and any further lowering of the watertable will not increase the effective value of h . Thus, for Condition A', the h/b -values at the abscissa should be interpreted as $(D + y)/b$.

The curves for Condition A in Figure 9.14 indicate that the effect that a permeable layer at depth has on seepage becomes rather small if that layer is deeper than five times the bottom width of the canal ($D > 5b$). High values of I_s/K are obtained for relatively small values of D , particularly if h approaches $D + y$.

For Condition A', the graphs show that the seepage rate remains almost constant at a wide range of depths of the permeable layer (effective head $h = D + y$). If this depth becomes less than three times the water depth in the canal ($D < 3y$), the seepage increases rapidly.

For Condition B, we can make similar observations on the position of the impermeable layer. The graphs show that, for a given watertable position, the seepage

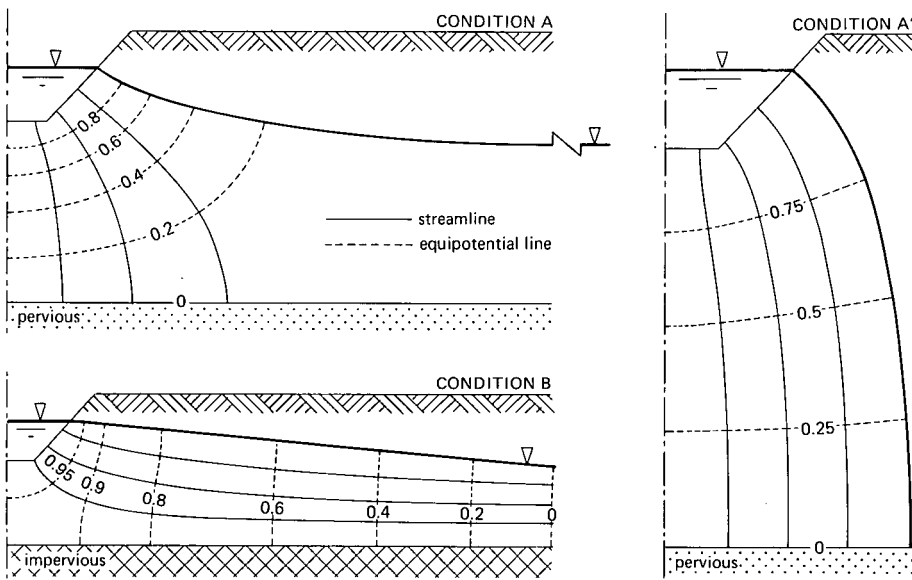

Figure 9.15 Flow systems for seepage under different conditions, obtained by electric analog analysis; equipotentials expressed as fraction of total head (after Bouwer 1965, 1969)

initially increases linearly as the depth of the impermeable layer (D) increases, but that the rate of increase diminishes as D becomes relatively large. For $D > 5b$, I_s/K is already relatively close to the values for $D = \infty$. Obviously, an impermeable layer only has a significant effect on seepage if its depth below the canal bottom is less than five times the bottom width of the canal. As we have seen above, the same applies to a permeable layer. A practical implication of these findings is that exploratory borings to determine the potential seepage from new irrigation canals need not penetrate deeper than approximately $5b$ below the projected elevation of the canal bottom.

The effect of the watertable on seepage shows a similar trend. Consider, for instance, the curve for $D = \infty$. Initially, the seepage (I_s/K) increases almost linearly with h , but for relatively large values of h the increase of the seepage diminishes. If h has reached a value of approximately three times the width of the water surface in the canal ($h = 3B$), the value of I_s/K is already close to that of $h = \infty$. Thus, a general lowering of the watertable, e.g. by pumping from wells, would result in a significant increase in seepage only if the initial depth of the watertable were considerably less than $3B$ below the water surface in the canal.

To apply the graphs of Figure 9.14 to canals of other shapes, we can compute b from the actual values of B and y , as if the canal were trapezoidal with $\alpha = 45^\circ$, or we can replace the cross-section with the best-fitting trapezoidal cross-section with $\alpha = 45^\circ$. For water depths other than those of Figure 9.14, values of I_s/K can be evaluated by interpolation.

9.7.3 Canals with a Resistance Layer at Their Perimeters

Some canals have a relatively thin layer of low permeability along their wetted perimeter (Condition C, Figure 9.13). Such a resistance layer may be natural in origin (e.g. sedimentation of clay and silt particles and/or organic matter, or biological action), or artificial (e.g. earthen linings for seepage control).

If the hydraulic conductivity of the resistance layer (K_o) is sufficiently small to cause the rate of downward flow in the underlying soil to be less than the hydraulic conductivity K of this soil, then the soil beneath the resistance layer will be unsaturated (provided that the watertable is sufficiently deep for the canal bottom to be well above the capillary fringe, and that air has access to the underlying soil). Under these conditions, the flow beneath the resistance layer will be due to gravity alone – and thus at unit hydraulic gradient – and the (negative) soil-water pressure head, h_1 , in the zone between the resistance layer and the top of the capillary fringe will be uniform. The infiltration rate, i , at any point of the canal bottom can therefore be described with Darcy's equation as

$$i = K_o \frac{y + D_o - h_1}{D_o} \quad (9.60)$$

where

i = infiltration rate (m/d)

K_o = hydraulic conductivity of the resistance layer (m/d)

- D_o = thickness of the resistance layer (m)
 y = depth of the water above the resistance layer (m)
 h_1 = soil-water pressure head (m)

This equation can be simplified if we consider that resistance layers are usually thin (clogged surfaces, sediment layers), so that D_o will be small compared with $y - h_1$ and can be neglected in the numerator. If the thickness of the resistance layer is small, it may be difficult to determine the actual value of D_o . The same is true for K_o . Under these circumstances, the hydraulic property of the resistance layer is more conveniently expressed in terms of its hydraulic resistance, C_o , defined as D_o/K_o (dimension: time). Equation 9.60 then reduces to

$$i = \frac{y - h_1}{C_o} \quad (9.61)$$

Applying this equation to the seepage through the bottom and the sides of a trapezoidal canal, and assuming that C_o is uniform and that the flow through the layer on the canal sides is perpendicular to the bank, we obtain the following equation for the seepage q_s

$$\begin{aligned}
 q_s = I_s B &= (i_{\text{bottom}} \times b) + \left(i_{\text{side slope}} \times \frac{2y}{\sin\alpha} \right) \\
 &= \frac{y - h_1}{C_o} b + \frac{\frac{1}{2}y - h_1}{C_o} \times \frac{2y}{\sin\alpha} \\
 &= \frac{1}{C_o} \left[(y - h_1) b + (y - 2h_1) \frac{y}{\sin\alpha} \right]
 \end{aligned} \quad (9.62)$$

References

- Abramowitz, M. and I.A. Stegun 1965. Handbook of mathematical functions: with formulas graphs and mathematical tables. Dover, New York, 1045 p.
 Bear, J., D. Zaslavsky and S. Irmay 1968. Physical principles of water percolation and seepage. Arid Zone Research 29 UNESCO, Paris, 465 p.
 Bosch, H. 1951. Geohydrologisch onderzoek Bergambacht (unpublished research report).
 Bouwer, H. 1965. Theoretical aspects of seepage from open channels. Journal of the Hydraulics Division, 91, pp. 37-59.
 Bouwer, H. 1969. Theory of seepage from open channels. In: V.T. Chow (ed.). Advances in Hydrosience, 5, Academic Press, New York. pp. 121-172.
 Bouwer, H. 1978. Groundwater hydrology. McGraw-Hill, New York, 480 p.
 Colenbrander, H.J. 1962. Een berekening van hydrologische bodemconstanten, uitgaande van een stationaire grondwaterstroming. In: De waterbehoefte van de Tielerwaard-West, Wageningen. 135 p.
 Dachler, R. 1936. Grundwasserströmung. Springer, Wien.
 Dwight, H.B. 1971. Tables of integrals and other mathematical data. 4th ed. MacMillan, New York, 336 p.
 Edelman, J.H. 1947. Over de berekening van grondwaterstromingen. Thesis, Delft University of Technology (Mimeographed).
 Edelman, J.H. 1972. Groundwater hydraulics of extensive aquifers. ILRI Bulletin 13, Wageningen, 216 pp.
 Ferris, J.G., D.B. Knowles, R.H. Brown and R.W. Stallman 1962. Theory of aquifer tests. U.S. Geological Survey Water Supply Paper 1536-E, Washington, pp. 69-174.
 Harr, M.W. 1962. Groundwater and seepage. McGraw-Hill, New York, 315 p.
 Huisman, L. 1972. Groundwater recovery. Macmillan, London, 336 p.

- Jacob, C.E. 1940. On the flow of water in an elastic artesian aquifer. Transactions American Geophysical Union, 2, pp. 574-586.
- Jacob, C.E. 1950. Flow of groundwater. In: H. Rouse (ed.). Engineering hydraulics, Wiley, New York. pp. 321-386.
- Jahnke, E. and F. Emde 1945. Tables of functions with formulae and curves. 4th ed. Dover, New York, 304 p.
- Kozeny, J. 1931. Grundwasserbewegung bei freiem Spiegel, Fluss und Kanalversickerung. Wasserkraft und Wasserwirtschaft, 26, 3 p.
- Muskat, M. 1946. The flow of homogeneous fluids through porous media. McGraw-Hill, New York, 763 p.
- Rushton, K.R. and S.C. Redshaw 1979. Seepage and groundwater flow: numerical analysis by analog and digital methods. Wiley, New York, 339 p.
- Steggewentz, J.H. 1933. De invloed van de getijbeweging van zeeën en getijrivieren op de stijghoogte van het grondwater. Thesis, Delft University of Technology, 138 p.
- Vedernikov, V.V. 1934. Versickerungen aus Kanälen. Wasserkraft und Wasserwirtschaft, 11-13, 82 p.
- Verruijt, A. 1982. Theory of groundwater flow, 2nd ed., MacMillan, London, 144 p.
- Wesseling, J. and H.J. Colenbrander 1962. De bepaling van hydrologische bodemconstanten uit de voortplanting van de getijbeweging. In: De waterbehoefte van de Tielerwaard-West, Wageningen. 135 p.

10 Single-Well and Aquifer Tests

J. Boonstra¹ and N.A. de Ridder¹ †

10.1 Introduction

There are numerous examples of groundwater-flow problems whose solution requires a knowledge of the hydraulic characteristics of waterbearing layers. These characteristics were defined in Chapter 2. In drainage investigations, this knowledge is required for two purposes:

- To assess the net recharge to an aquifer in groundwater-balance studies (Chapter 16);
- To determine the long-term pumping rate and the well spacing for tubewell drainage (Chapter 22).

Performing an aquifer test is one of the most effective ways of determining the hydraulic characteristics. The procedure is simple: for a certain time and at a certain rate, water is pumped from a well in the aquifer, and the effect of this pumping on the watertable is regularly measured, in the pumped well itself and in a number of piezometers or observation wells in the vicinity.

Owing to the high costs of aquifer tests, the number that can be performed in most drainage studies has to be restricted. Nevertheless, one can perform an aquifer test without using observation wells, thereby cutting costs, although one must then accept a certain, sometimes appreciable, error. To distinguish such tests from normal aquifer tests, which are far more reliable, they are called single-well tests. In these tests, measurements are only taken inside the pumped well.

After a single-well or an aquifer test, the data collected during the test are substituted into an appropriate well-flow equation. In this chapter, we shall confine our discussions to the basic well-flow equations. For well-flow equations that cover a wider range of conditions, see Kruseman and De Ridder (1990).

10.2 Preparing for an Aquifer Test

10.2.1 Site Selection

Although, theoretically, any site that is easily accessible for manpower and equipment is suitable for a single-well or an aquifer test, a careful selection of the site will ensure better-quality data and will avoid unnecessary complications when the data are being analyzed. The factors to be kept in mind when selecting an appropriate site are:

- The hydrological conditions should be representative of the area;
- The watertable gradient should be small;
- The aquifer should extend in all directions over a relatively large distance (i.e. no recharge or barrier boundaries should occur in the vicinity of the test site);

¹ International Institute for Land Reclamation and Improvement

- The pumped water should be discharged outside the area affected by the pumping to prevent it from re-entering the aquifer.

If not all these conditions can be satisfied, techniques are available to compensate for any deviations.

10.2.2 Placement of the Pumped Well

At the site selected for the test, the well that is to be pumped is bored into the aquifer. Its diameter is generally between 0.10 and 0.30 m, depending on the type of pump that will be used; the type of pump depends on the desired discharge rate and the allowable maximum pumping lift.

After the well has been drilled, it must be fitted with a screen, the length of which

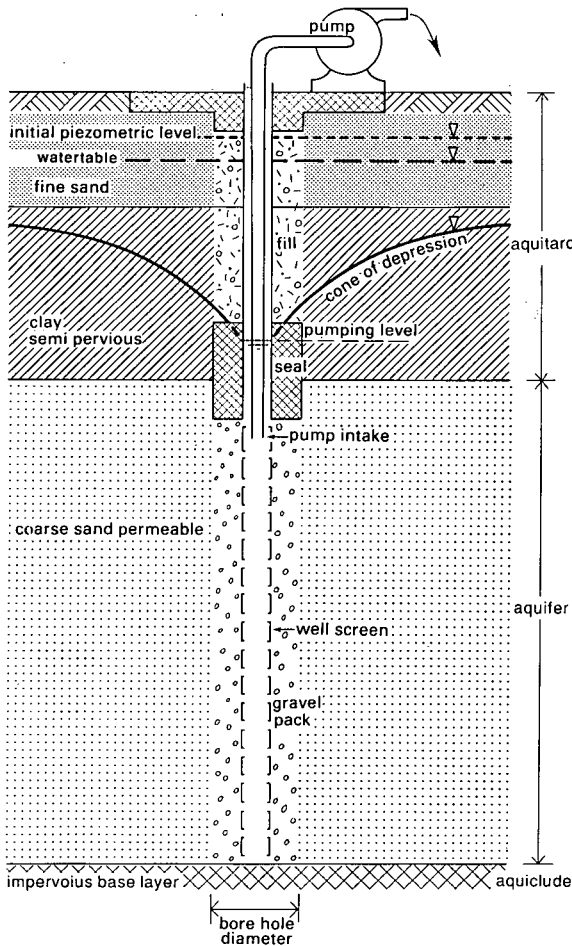

Figure 10.1 Fully-penetrating pumped well in a semi-confined aquifer

depends on the type of aquifer being tested. In unconfined aquifers, the bottom one-third to one-half of the aquifer should be screened to prevent the well screen from falling dry if appreciable drawdowns occur. In semi-confined (leaky) aquifers, the well should be screened over at least 70 to 80 per cent of the aquifer thickness. (If the watertable is expected to fall below the top of the aquifer during the test, that part of the aquifer should not be screened.) When such a well is pumped, the flow to the well will be essentially horizontal, and there will be no need to correct the drawdown data of any nearby observation wells. To prevent downward flow along the well from overlying layers, a seal of bentonite clay or very fine clayey sand may be required above the well screen (Figure 10.1).

Thick aquifers can only be partly screened, say their upper 50 m, because the cost of screening their full thickness would be prohibitive. In such partially-penetrating wells, vertical flow components will influence the drawdown within a radial distance from the well approximately equal to the thickness of the aquifer. As these vertical flow components are accompanied by a head loss, all drawdown data from wells sited within this radius must be corrected before they can be used to calculate the hydraulic characteristics. Figure 10.2 illustrates the flow to a fully-penetrating well (A) and to a partially-penetrating well (B).

In fine sandy or extensively laminated aquifers, the zone immediately surrounding the well screen can be made more permeable by removing the aquifer material and replacing it with an artificially-graded gravel pack (see Figure 10.1). The gravel pack will retain the aquifer material that would otherwise enter the well. Another advantage of a gravel pack is that it allows a somewhat larger slot size to be used in the well screen.

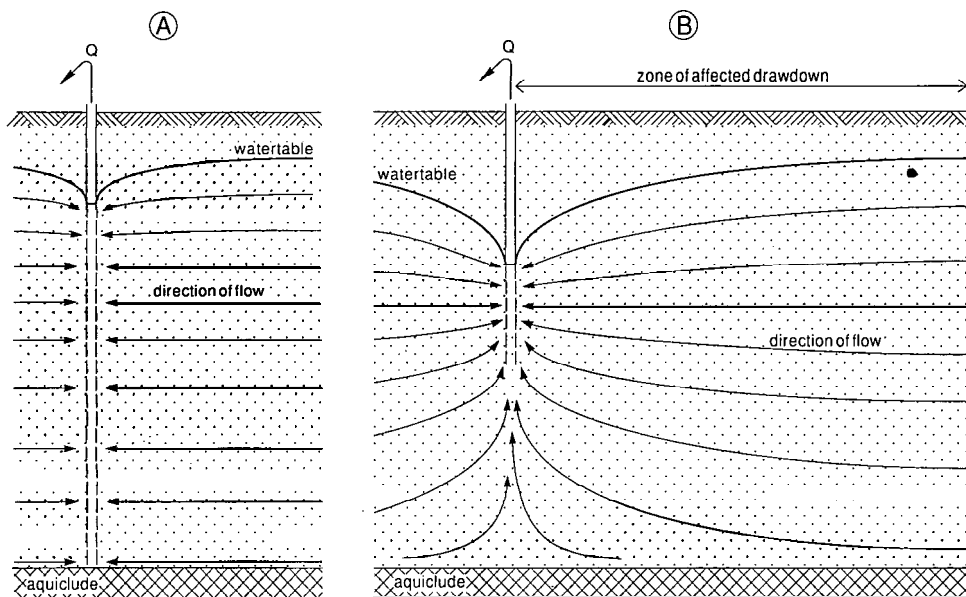

Figure 10.2 Groundwater flow to: A: A fully-penetrating well; B: A partially-penetrating well

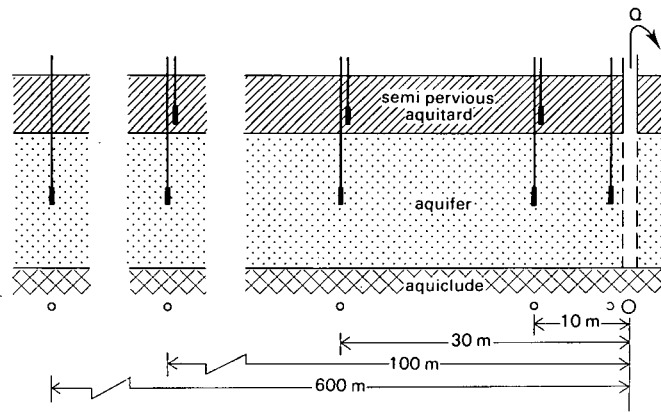

Figure 10.3 Example of the arrangement of observation wells in a semi-confined aquifer that is being tested by a fully-penetrating pumped well

10.2.3 Placement of Observation Wells

The observation wells need only be of small diameter, and each should be fitted with a screen, 1 to 2 m long, placed at about the same depth as the middle of the screen of the pumped well. Such an observation well is also called a piezometer.

Figure 10.3 shows an example of the arrangement of observation wells in a semi-confined aquifer that is being tested with a fully-penetrating well. Deep observation wells are placed in the aquifer and shallow ones are placed in the overlying semi-pervious layer. Other observation wells could be placed in the sandy material below the impervious base layer (aquiclude) to check whether that layer is indeed impervious.

In deciding how far from the pumped well one should place the observation wells, there are two factors to consider:

- The first is the non-homogeneity of aquifers; aquifers are almost always stratified to some degree. Care must be taken not to place an observation well in the least permeable part of the aquifer because the drawdown there will differ appreciably from that in the more permeable parts. This difference decreases as pumping continues, and is less significant at greater distances from the pumped well;
- The second factor is the degree of penetration of the screen of the pumped well. A short screen will have a noticeable effect on the drawdown near the screen because of the vertical flow components, so no observation wells should be placed too close to such a screen.

This effect disappears at distances equal to one to three times the thickness of the aquifer. On the other hand, locating observation wells too far from the pumped well is not convenient either, because pumping must then be continued for a longer time to produce a sufficiently large drawdown at the most distant sites.

In unconfined aquifers, observation wells placed at distances of, say, 3, 10, 30, and

100 m from the pumped well will be appropriate in most cases. In confined and semi-confined aquifers, if thick and stratified, the distances must be greater, say, 100 to 300 m from the pumped well. For tests that last longer than one day, an extra observation well may be needed at a site that is not affected by the pumping. The water-level readings from that well can be used to check whether any natural changes occurred in the watertable during the pumping period. If so, the drawdown data produced by the pumping must be corrected accordingly.

When the pumped well and the observation wells are being drilled, samples of the pierced layers should be taken every one or two metres. A description of these samples will allow the type of aquifer (unconfined, confined, or semi-confined) to be defined. If possible, some of the wells should fully penetrate the aquifer to establish whether the impervious base layer is present throughout. After all the wells have been installed, they should be cleaned or pumped briefly to ensure that they function properly.

10.2.4 Arrangement and Number of Observation Wells

The number of observation wells depends on the amount and accuracy of information that is required and on the funds available for the test. The water-level data from one single observation well will allow the hydraulic characteristics to be calculated, but the data from two or more such wells will allow the test results to be analyzed in different ways. These different analyses provide a check on the accuracy of the results obtained from the test. Besides, since an aquifer is seldom homogeneous, it is always best to have as many observation wells as circumstances permit.

Figure 10.4 shows four different arrangements of observation wells and the pumped well. For drainage studies, arrangements A, B, or C will usually be appropriate.

10.3 Performing an Aquifer Test

An aquifer test relies heavily on three sets of measurements: those of time, head, and discharge.

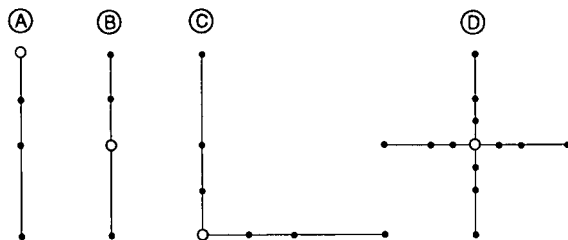

Figure 10.4 Different arrangements of observation wells:
o = pumped well; • = observation well

10.3.1 Time

The time measurements are started at the beginning of the test; they can be recorded either as 'time of day' or as 'time since the test started'. Because water levels are dropping fast during the first hour or two of the test, readings should first be taken at brief intervals. As pumping continues, water levels will drop less and less fast and the intervals between readings can gradually be lengthened. Since, in all the analysis procedures, the time is plotted on a logarithmic scale, it is recommended to have the same number of readings in each log cycle of time. Table 10.1 shows an example of the sequence in time for taking water-level measurements, based on ten readings in each log cycle and resulting in approximately equidistant plotting positions.

For observation wells far from the well and for those in aquitards above or below the aquifer, the brief time intervals in the first minutes of the test need not be adhered to.

10.3.2 Head

Before pumping starts, the water levels in all the wells should be measured from a chosen reference (e.g. the rim of the pipe).

Water-level measurements can be taken in various ways: with the wetted-tape method, mechanical sounder, electric water-level indicator, floating-level indicator or recorder, pressure gauge, or pressure logger. (For information on these devices, see Chapter 2.) Fairly accurate measurements can be made manually, but then the instant of each reading should be recorded with a chronometer. Experience has shown that it is possible to measure the depth to water within 2 mm.

For piezometers close to the well, the wetted-tape method cannot be used because of the rapid water-level changes, and the mechanical sounder is not suitable because of the noise of the pump. Although the pressure-gauge method is less accurate than the other methods (within 0.06 m), it is the most practical method of measuring water levels in a pumped well. It should not be used, however, in observation wells.

Most well-flow equations require drawdown data. Data on depth to the water level should therefore be converted to drawdown data. In other words, the initial depth

Table 10.1 Sequence in time for taking water-level measurements

Time (s)	Time (min)	Time (min)	Time (h)	Time (h)
10	2.5	20	2.5	22
20	3.0	25	3.0	27
30	4.0	30	4.0	33
40	5.0	40	5.0	42
50	6.5	50	7.0	53
60	8.0	65	8.5	67
80	10.0	80	11.0	83
100	13.0	90	13.0	108
120	16.0	120	17.0	133

to the water level prior to pumping must be subtracted from the depth to the water level during the test.

10.3.3 Discharge

The required discharge rate of the pump depends on many factors: the depth, diameter, and screen length of the pumped well; the type of aquifer; the actual hydraulic characteristics of the tested aquifer; and the distances of the observation wells.

The discharge rate is usually determined in the field. Several days before the test is to be conducted, the test well should be pumped for several hours. In most tests, a major portion of the drawdown occurs in the first few hours of pumping, so this preliminary testing will reveal the maximum expected drawdown in the well. Also, for aquifer tests, it will reveal whether the discharge rate is high enough to produce good measurable drawdowns – at least some decimetres – in all the observation wells.

To avoid unnecessary complications when the test is being analyzed, the discharge of the well should be kept constant. It should therefore be measured at least once every hour and, if necessary, adjusted.

There are various ways of measuring the discharge. If the outflow pipe is running full, accurate measurements can be made with a water meter of appropriate capacity. It can also be measured by recording the time required to fill a container of known volume, or, if the pumped water is conveyed through a channel or small ditch, by means of a flume or weir. For information on these devices, see Bos (1989) and Driscoll (1986).

The water delivered by the well should be prevented from returning to the aquifer. This can be done by conveying the water through a large-diameter pipe, say over a distance of 100 or 300 m, depending on the location of the piezometers, and then discharging it into a canal or natural channel. Preferably, the water should be discharged away from the line of piezometers. The pumped water can also be conveyed through a shallow ditch, but precautionary measures should be taken to seal the bottom of the ditch with clay or plastic sheets to prevent leakage.

10.3.4 Duration of the Test

The question of how long the test should run depends on the type of aquifer being tested. With all the effort and expense that is put into an aquifer test, it is not wise to economize on the time of pumping because this constitutes only a small fraction of the total cost. It is therefore advisable to continue the test until the water levels in the observation wells have stabilized (i.e. until the flow has reached a steady or pseudo-steady state).

Steady-state flow is independent of time (i.e. the water level, as observed in piezometers, does not change with time). It can occur, for instance, when there is equilibrium between the discharge of the pumped well and the recharge of the pumped aquifer from an overlying aquitard. Because real steady-state conditions seldom occur, it is said in practice that a steady state is reached when the changes in water level are negligibly small, or when the hydraulic gradient has become constant (pseudo steady-state).

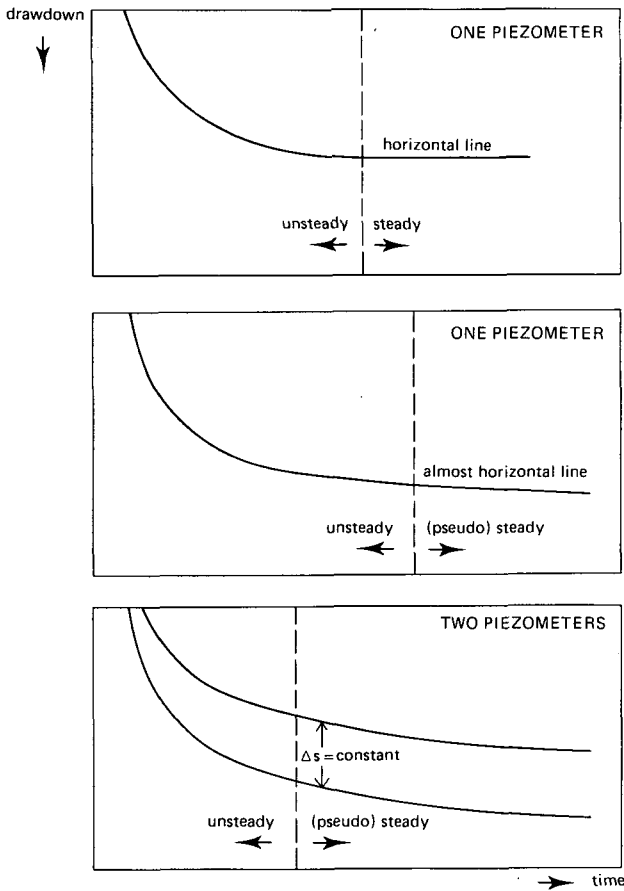

Figure 10.5 Time-drawdown plots showing the changes in drawdown during an aquifer test and their interpretations

To establish whether unsteady or (pseudo) steady-state conditions prevail, the changes in head during the pumping test should be plotted. Figure 10.5 shows the different plots and their interpretations.

Under average conditions, steady-state flow is generally reached in semi-confined aquifers after 15 to 20 hours of pumping. In unconfined aquifers, pseudo steady-state conditions may take several days. Preliminary plotting of data during the test will often show what is happening and may indicate whether or not the test should be continued.

10.4 Methods of Analysis

As already stated, the principle of a single-well or aquifer test is that a well is pumped and the effect of this pumping on the aquifer's hydraulic head is measured, in the well itself and/or in a number of observation wells in the vicinity. The change in water

level induced by the pumping is known as the drawdown. In literature, tests based on the analysis of drawdowns during pumping are commonly referred to as 'pumping tests'.

The hydraulic characteristics can also be found from a recovery test. In such a test, a well that has been discharging for some time is shut down, after which the recovery of the aquifer's hydraulic head is measured, in the well and/or in the observation wells. Figure 10.6A gives the time-drawdown relationships during a pumping test, followed by a recovery test.

Analyses based on time-drawdown and time-recovery relationships can be applied to both single-well tests and aquifer tests. With aquifer tests, it is possible to make these analyses for each well separately and then to compare their results. Aquifer tests that provide drawdown data from two or more observation wells also make it possible to include the distance-drawdown relationship in the analysis (Figure 10.6B).

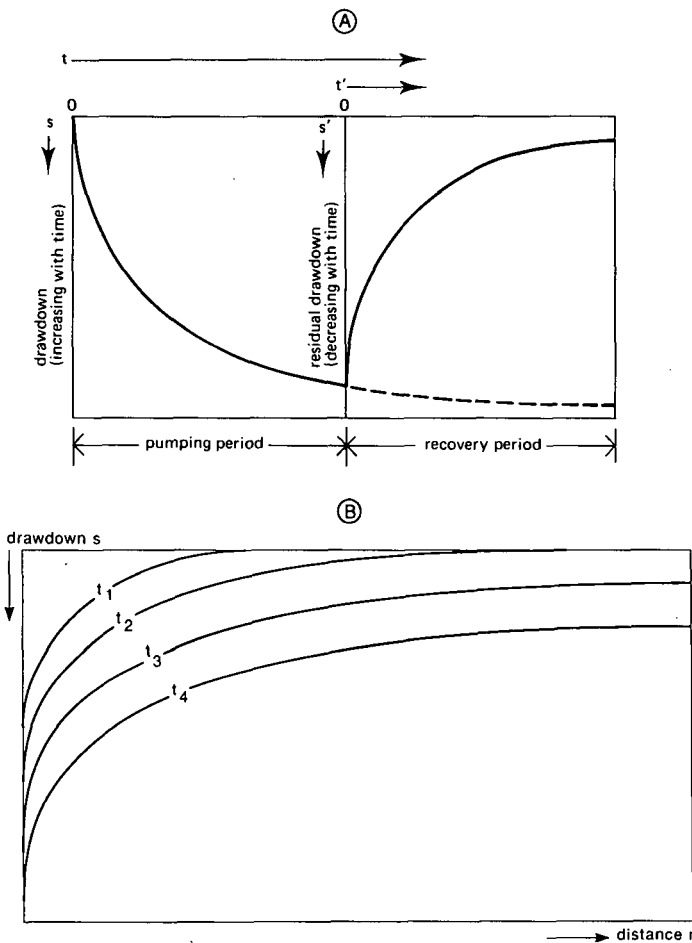

Figure 10.6 A: Time-drawdown relationship during a pumping test, followed by a recovery test;
 B: Distance-drawdown relationship during a pumping test

Altogether, the results of aquifer tests are more accurate than the results of single-well tests, and, moreover, are representative of a larger volume of the aquifer.

The methods presented in this section can be used to analyze single-well and aquifer tests conducted in unconfined and semi-confined aquifers. Although the methods used for unconfined aquifers were initially developed for confined aquifers, the latter will not be discussed, since they are not relevant for subsurface drainage.

All the methods presented were developed under the following common assumptions and conditions:

- The aquifer has a seemingly infinite areal extent;
- The aquifer is homogeneous, isotropic, and of uniform thickness over the area influenced by the test;
- Prior to pumping, the hydraulic head is horizontal (or nearly so) over the area that will be influenced by the test;
- The pumped well penetrates the entire thickness of the aquifer and thus receives water by horizontal flow;
- The aquifer is pumped at a constant-discharge rate;
- The water removed from storage is discharged instantaneously with decline of head (see Section 10.5.1);
- The diameter of the pumped well is small (i.e. the storage inside the well can be neglected).

Additional assumptions and limiting conditions are mentioned where the individual methods are discussed separately.

10.4.1 Time-Drawdown Analysis of Unconfined Aquifers

Theis (1935) was the first to develop an equation for unsteady-state flow which introduced the time factor and the storativity. He noted that when a fully-penetrating well pumps an extensive confined aquifer at a constant rate, the influence of the discharge extends outward with time. The rate of decline of head, multiplied by the storativity and summed over the area of influence, equals the discharge.

Jacob (1950) showed that if the drawdowns in an unconfined aquifer are small compared with the initial saturated thickness of the aquifer, the condition of horizontal flow towards the well is approximately satisfied, so that the Theis equation, which was originally developed for confined aquifers, can be applied to unconfined aquifers as well.

For unconfined aquifers, the Theis equation, which was derived from the analogy between the flow of groundwater and the conduction of heat, is written as

$$s = \frac{Q}{4\pi KH} \int_u^{\infty} \frac{1}{y} \exp(-y) dy = \frac{Q}{4\pi KH} W(u) \quad (10.1)$$

and

$$u = \frac{r^2 \mu}{4KHt} \quad (10.2)$$

where

- s = drawdown measured in a well (m)
- Q = constant well discharge (m^3/d)
- KH = transmissivity of the aquifer (m^2/d)
- r = distance from the pumped well (m)
- μ = specific yield of the aquifer (-)
- t = time since pumping started (d)
- u = help parameter (-)
- $W(u)$ = Theis well function (-)

Values of the Theis well function can be found in Appendix 10.1.

In Figure 10.7, the Theis well function $W(u)$ is plotted versus $1/u$ on semi-log paper. It can be seen in this figure that, for large values of $1/u$, the Theis well function exhibits a straight-line segment. The Jacob method is based on this phenomenon. Cooper and Jacob (1946) showed that, for the straight-line segment, Equation 10.1 can be approximated by

$$s = \frac{2.30Q}{4\pi KH} \log \frac{2.25KHt}{r^2\mu} \tag{10.3}$$

with an error of less than 10, 5, 2, and 1 per cent for $1/u$ values larger than 7, 10, 20, and 30, respectively. For all practical purposes, Equation 10.3 can thus be used for $1/u$ values larger than 10.

If the time of pumping is long enough, a plot of the drawdown s observed at a particular distance r from the pumped well versus the logarithm of time t will show a straight line. If the slope of this straight-line segment is expressed as the drawdown difference ($\Delta s = s_1 - s_2$) per log cycle of time ($\log t_2/t_1 = 1$), rearranging Equation 10.3 gives

$$KH = \frac{2.3Q}{4\pi\Delta s} \tag{10.4}$$

If the straight line is extended until it intercepts the time-axis where $s = 0$, the interception point has the coordinates $s = 0$ and $t = t_0$. Substituting these values

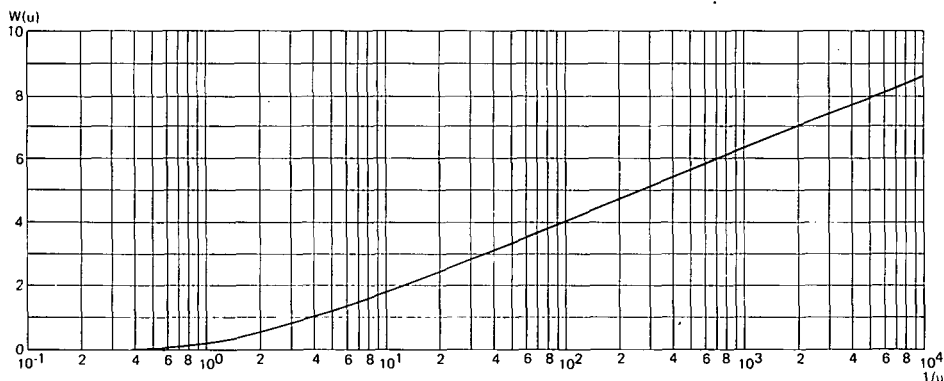

Figure 10.7 Theis well function $W(u)$ versus $1/u$ for fully-penetrating wells in unconfined aquifers

into Equation 10.3 gives $\log [2.25KHt_0/r^2\mu] = 0$ or $[2.25KHt_0/r^2\mu] = 1$ or

$$\mu = \frac{2.25KHt_0}{r^2} \quad (10.5)$$

Jacob's straight-line method is based on the assumptions listed in Section 10.4 and on the limiting condition that the pumping time is sufficiently long for a straight-line segment to be distinguished in a time-drawdown plot on semi-log paper.

Procedure 1

- For one of the observation wells, plot the drawdown values s versus the corresponding time t on semi-log paper (t on logarithmic scale);
- Select a time range and draw a best-fitting straight line through that part of the plotted points;
- Determine the slope of the straight line (i.e. the drawdown difference Δs per log cycle of time);
- Substitute the values of Q and Δs into Equation 10.4 and solve for KH ;
- Extend the straight line until it intercepts the time-axis where $s = 0$, and read the value of t_0 ;
- Substitute the values of KH , t_0 , and r into Equation 10.5 and solve for μ ;
- Substitute the values of KH , μ , and r into Equation 10.2, together with $1/u = 10$, and solve for t . This t value should be less than the time range for which the straight-line segment was selected (see Example 10.1);
- If drawdown values are available for more than one well, apply the above procedure to the other wells also.

Remark 1

When the drawdowns in an unconfined aquifer are large compared with the aquifer's original saturated thickness, the analysis should be based on corrected drawdown data. Jacob (1944) proposed the following correction

$$s_c = s - \frac{s^2}{2H} \quad (10.6)$$

where

- s_c = corrected drawdown (m)
- s = observed drawdown (m)
- H = original saturated thickness of the aquifer (m)

Remark 2

With single-well tests, basically the same procedure can be applied. The r value now represents the effective radius of the single well. This is difficult to determine under field conditions; as a 'best' estimate, the outer radius of the well screen is often used.

A complicating factor is the phenomenon that due to non-linear well losses the water levels inside the well can be considerably lower than those directly outside the well screen.

This implies that drawdown data from the pumped well can, in general, only be used for the analysis when corrected for these non-linear well losses using the results

of so-called step-drawdown tests. For information on this subject, see Kruseman and De Ridder (1990).

With the above procedure, however, we can use the uncorrected drawdown data and still determine accurate transmissivity values, because the slope of the straight-line segment in the time-drawdown plot on semi-log paper is not affected by this phenomenon (the non-linear well loss is constant with time). Specific-yield values, even when based on the corrected data, should be treated with caution, because they are highly sensitive to the value of the effective radius of the pumped well.

Example 10.1

A single-well test was made in an unconfined aquifer. The well was pumped at a constant rate of 3853 m³/d for 10 hours. The outer radius of the well screen was 0.20 m. Table 10.2 shows the observed drawdowns as a function of time.

Calculate KH and μ , using Jacob's straight-line method.

The first step is to determine whether the observed drawdown values are small compared with the aquifer's thickness (see Remark 1). The depth of the pumped borehole was 271 m. Substituting this value and the last observed drawdown value into Equation 10.6 gives a maximum correction value of 0.05 m. It can thus be concluded that uncorrected drawdown values can be used in the analysis.

Figure 10.8 shows the time-drawdown plot on semi-logarithmic paper. The slope of the straight line shows that Δs is 0.50 m. Substituting the appropriate values into Equation 10.4 gives

$$KH = \frac{2.3Q}{4\pi\Delta s} = \frac{2.3 \times 3853}{4 \times 3.14 \times 0.50} = 1410 \text{ m}^2/\text{d}$$

It can be seen from Figure 10.8 that the intersection of the straight line with the ordinate where $s = 0$ cannot be determined directly. When such a situation occurs, the following procedure can be followed:

- Within the range of plotted drawdowns, determine a drawdown value which is a multiple of the Δs -value;
- Determine the corresponding t value using the straight line;
- The t_0 value is then equal to $t \times 10^{-x}$, where x denotes the multiple of the first step.

Table 10.2 Time-drawdown values of a single-well test

Time (min)	Drawdown (m)	Time (min)	Drawdown (m)	Time (min)	Drawdown (m)
15	4.161	50	4.486	240	4.808
20	4.283	56	4.471	300	4.776
25	4.257	60	4.474	360	4.885
30	4.357	80	4.534	420	4.960
36	4.358	105	4.618	480	4.906
40	4.399	120	4.672	540	4.972
46	4.456	180	4.748	600	5.016

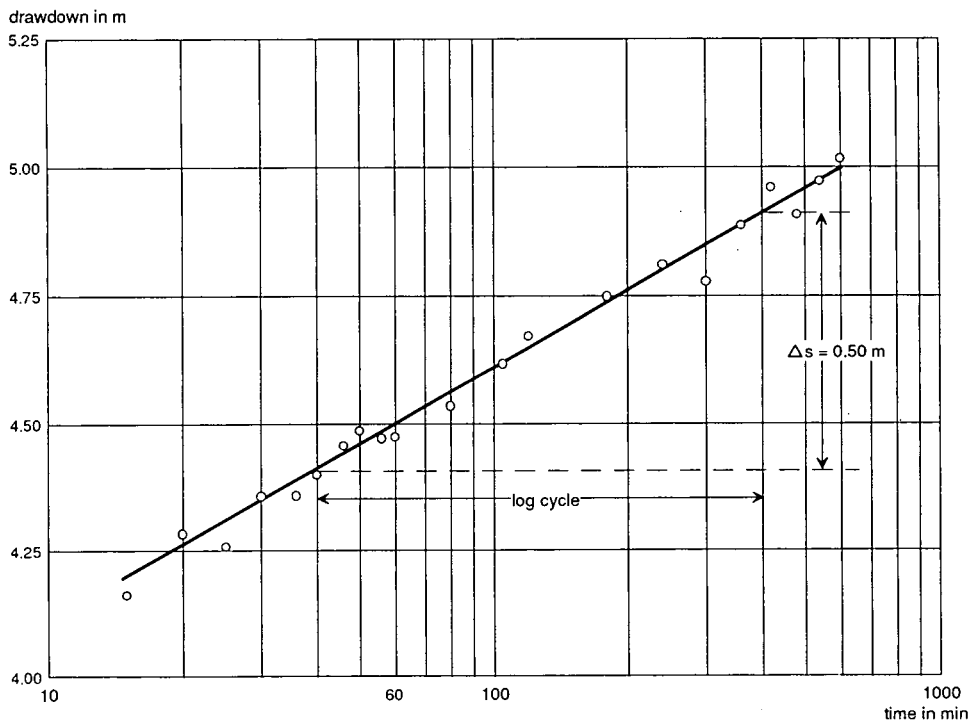

Figure 10.8 Time-drawdown plot of field data of a single-well test in an unconfined aquifer

The Δs value was calculated as 0.5 m. Figure 10.8 shows that for a drawdown of 4.5 m – being 9 times the Δs value – the corresponding time is 60 minutes. The t_0 value is then equal to $60 \times 10^{-9} \text{ min} = 4.2 \times 10^{-11} \text{ d}$. Substituting the appropriate values into Equation 10.5 yields

$$\mu = \frac{2.25KHt_0}{r^2} = \frac{2.25 \times 1410 \times 4.2 \times 10^{-11}}{0.20^2} = 3.3 \times 10^{-6}$$

It is obvious that the above specific-yield value is not correct. Specific-yield values range from 5×10^{-3} to 5×10^{-1} .

At the same site, a step-drawdown test was also made. From the analysis of this test, the non-linear well loss was calculated to be 1.93 m. When the drawdown data of Table 10.2 are corrected with this value (see Remark 2), the intersection point where $s = 0$ then has the time value $t_0 = 4.4 \times 10^{-4} \text{ min} = 3.1 \times 10^{-7} \text{ d}$. Substituting the appropriate values into Equation 10.5 yields

$$\mu = \frac{2.25KHt_0}{r^2} = \frac{2.25 \times 1410 \times 3.1 \times 10^{-7}}{0.20^2} = 0.025$$

This specific-yield value looks better. It seems a reasonable estimate for the specific yield of this aquifer.

Finally, the condition that the $1/u$ value is larger than 10 should be verified. Substituting this condition into Equation 10.2 gives

$$t > \frac{10 r^2 \mu}{4 KH} \rightarrow t > \frac{2.5 \times 0.2^2 \times 0.025}{1410} \rightarrow t > 1.8 \times 10^{-6} \text{ d or } t > 2.6 \times 10^{-3} \text{ min}$$

So, theoretically, all the observed drawdown values with t values larger than 2.6×10^{-3} minutes, can be expected to lie on a straight line. In other words, all the observed drawdown data as plotted in Figure 10.8 can be used to determine the slope of the straight line.

It should be noted that the condition $1/u > 10$ is usually fulfilled in single-well tests because of the small r value.

10.4.2 Time-Drawdown Analysis of Semi-Confined Aquifers

When a semi-confined aquifer is pumped (Figure 10.9), the piezometric level of the aquifer in the well is lowered. This lowering spreads radially outward as pumping continues, creating a difference in hydraulic head between the aquifer and the aquitard. Consequently, the groundwater in the aquitard will start moving vertically downward to join the water in the aquifer. The aquifer is thus recharged by downward percolation from the aquitard. As pumping continues, the percentage of the total discharge derived from this percolation increases. After a certain period of pumping, equilibrium will be established between the discharge rate of the pump and the recharge rate by vertical flow through the aquitard. This steady state will be maintained as long as the watertable in the aquitard is kept constant.

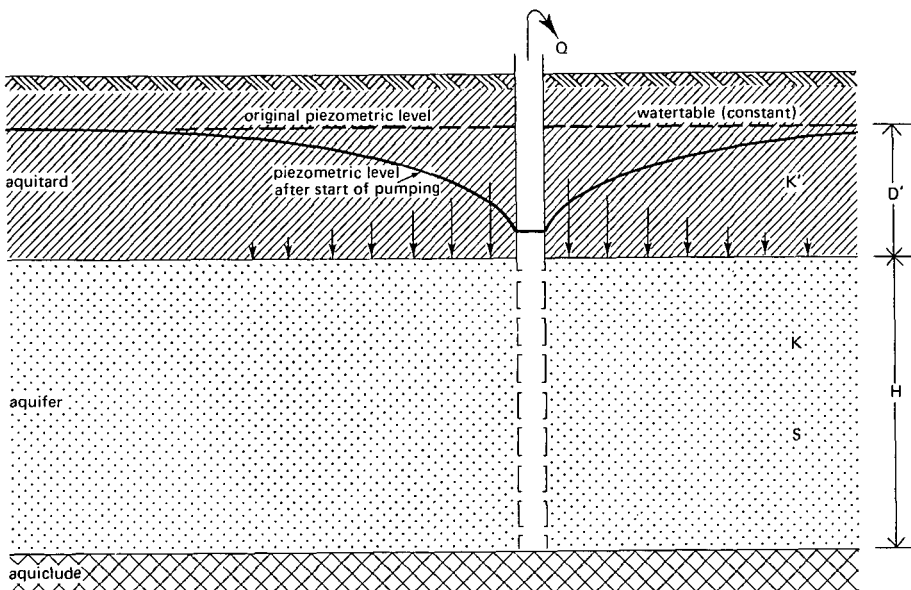

Figure 10.9 Cross-section of a pumped semi-confined aquifer

Attention is drawn to the assumption that the leakage from the aquitard is proportional to the drawdown of the piezometric level of the aquifer. A consequence of this assumption is that the watertable in the aquitard should be constant or, in practice, that the drawdown of the watertable is less than five per cent of the thickness of the saturated part of the aquitard. When pumping tests of long duration are performed, this assumption is generally not satisfied unless the aquitard is replenished by an outside source, say from surface water distributed over the aquitard via a system of narrowly-spaced ditches.

According to Hantush and Jacob (1955), the drawdown due to pumping a semi-confined aquifer can be described by the following equation

$$s = \frac{Q}{4\pi KH} \int_u^\infty \frac{1}{y} \exp\left(-y - \frac{r^2}{4L^2y}\right) dy = \frac{Q}{4\pi KH} W(u, r/L) \quad (10.7)$$

and

$$u = \frac{r^2 S}{4KHt} \quad (10.8)$$

where

$L = \sqrt{KHc}$ = leakage factor (m)

$c = D'/K'$ = hydraulic resistance of the aquitard (d); D' and K' are indicated in Figure 10.9

$W(u, r/L)$ = Hantush well function (Appendix 10.2)

S = storativity of the aquifer (-)

Equation 10.7 has the same form as the Theis equation (Equation 10.1), but there are two parameters in the integral: u and r/L . Equation 10.7 approaches the Theis equation for large values of L , when the exponential term $r^2/4L^2y$ approaches zero.

In Figure 10.10, the Hantush well function $W(u, r/L)$ is plotted versus $1/u$ on semi-log paper for an arbitrary value of r/L . This figure shows that the Hantush well function exhibits an S shape and, for large values of $1/u$, a horizontal straight-line segment indicating steady-state flow. It is on these phenomena that the inflection-point method

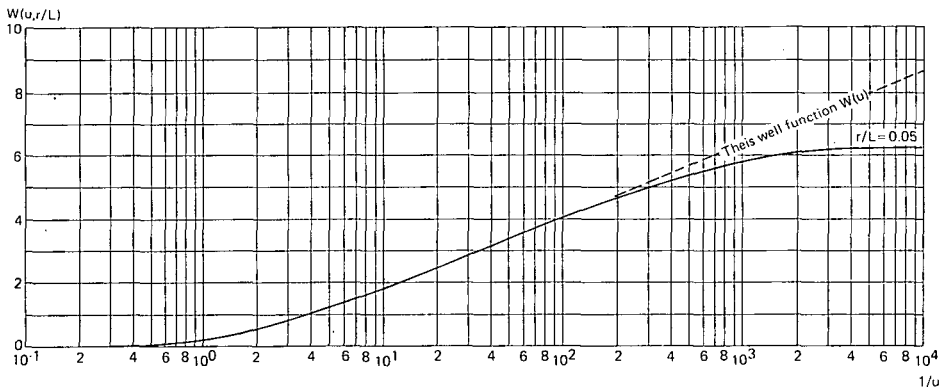

Figure 10.10 Hantush well function $W(u, r/L)$ versus $1/u$ for fully-penetrating wells in semi-confined aquifers

was based. Hantush (1956) showed that for the inflection point the following relationships hold:

a)

$$s_p = 0.5 s_m = \frac{Q}{4\pi KH} K_0\left(\frac{r}{L}\right) \quad (10.9)$$

where $K_0(r/L)$ is the modified Bessel function of the second kind and zero order and s_m is the steady-state drawdown;

b)

$$u_p = \frac{r^2 S}{4KHt_p} = \frac{r}{2L} \quad (10.10)$$

c)

At the inflection point the slope of the curve, Δs_p , is given by

$$\Delta s_p = \frac{2.3Q}{4\pi KH} e^{-r/L} \quad (10.11)$$

d)

At the inflection point, the relation between the drawdown and the slope of the curve is given by

$$2.3 \frac{s_p}{\Delta s_p} = e^{r/L} K_0(r/L) \quad (10.12)$$

In Equations 10.9 to 10.12, the index p means 'at the inflection point'. Further, Δs stands for the slope of a straight line, taking the time interval as a log cycle.

The Hantush inflection-point method is based on the assumptions listed in Section 10.4 and on the following limiting conditions:

- The watertable in the aquitard remains constant so that leakage through the aquitard takes place in proportion to the drawdown of the piezometric level;
- The pumping time is sufficiently long so that the steady-state drawdown can be estimated from extrapolation of a time-drawdown curve plotted on semi-log paper.

Procedure 2

- For one of the wells, plot the drawdown values s versus the corresponding time t on semi-log paper (t on logarithmic scale) and draw a curve that fits best through the plotted points;
- Determine from this plot the value of the steady-state drawdown s_m ;
- Substitute the value of s_m into Equation 10.9 and solve for s_p . The value of s_p on the curve locates the inflection point p ;
- Read the value of t_p at the inflection point from the time-axis;
- Determine the slope Δs_p of the curve at the inflection point. This can be closely approximated by reading the drawdown difference per log cycle of time over the straight portion of the curve on which the inflection point lies (= the tangent to

- the curve at the inflection point);
- Substitute the values of s_p and Δs_p into Equation 10.12 and solve for $e^{r/L} K_0(r/L)$. By interpolation between values of this product, which can be found numerically, the value of r/L is found (see Appendix 10.3);
- Calculate the leakage factor L from the r/L value determined in the previous step, and the r value of the well;
- Substitute Q , Δs_p , and r/L into Equation 10.11 and solve for KH ;
- Substitute r , KH , t_p , and L into Equation 10.10 and solve for S ;
- Calculate the hydraulic resistance c from the relation $c = L^2/KH$;
- If drawdown values are available for more than one well, apply the above procedure to the other wells also.

Remark 3

The accuracy of the calculated hydraulic characteristics depends on the accuracy of the value of the (extrapolated) steady-state drawdown s_m .

The calculations should therefore be checked by substituting the different values into Equations 10.7 and 10.8. Calculations of s should be made for the observed values of t . If the values of t are not too small, the values of s should fall on the observed data curve. If the calculated data deviate from the observed data, the (extrapolated) value of s_m should be adjusted. Sometimes, the observed data curve can be drawn somewhat steeper or flatter through the plotted points, and so Δs_p can be adjusted too. With the new values of s_m and/or Δs_p , the calculation is repeated.

With the computer program SATEM (Boonstra 1989), the above time-consuming work can be avoided. This program follows the same procedure as described above. In addition, it displays the drawdowns calculated with Equations 10.7 and 10.8 on the monitor, together with the data observed in the field. This makes it easy to check whether the correct (extrapolated) steady-state drawdown s_m has been selected.

Remark 4

With single-well tests, basically the same procedure can be applied. The r value again represents the effective radius of the pumped well. Because of non-linear well losses, the water levels inside the well can be considerably lower than those directly outside the well screen. This implies that if we follow the above procedure, we can only determine accurate transmissivity values by using the uncorrected drawdown data, as was also mentioned in Section 10.4.1.

Example 10.2

An aquifer test was made in a semi-confined aquifer. The well was pumped at a constant rate of $545 \text{ m}^3/\text{d}$ for 48 hours. One of the observation wells was located 20 m away from the pumped well. Table 10.3 shows the observed drawdowns as a function of time.

Using the Hantush inflection-point method, calculate KH , S , and c .

Figure 10.11 shows the time-drawdown plot on semi-logarithmic paper. As can be seen from this figure, steady-state conditions occurred at the end of the pumping test ($s_m = 2.44 \text{ m}$). According to Equation 10.9, the s_p value is then 1.22 m. The figure

Table 10.3 Time-drawdown values of an aquifer test

Time (min)	Drawdown (m)	Time (min)	Drawdown (m)	Time (min)	Drawdown (m)
1	0.265	60	1.615	720	2.320
2	0.347	70	1.675	840	2.337
3	0.490	80	1.725	960	2.355
4	0.548	90	1.767	1080	2.377
5	0.635	120	1.895	1200	2.373
6	0.707	150	1.977	1320	2.385
7	0.793	180	2.020	1440	2.400
8	0.839	210	2.075	1620	2.410
9	0.882	240	2.113	1800	2.420
10	0.930	300	2.170	1980	2.440
15	1.079	360	2.210	2160	2.440
20	1.187	420	2.245	2340	2.450
25	1.275	480	2.270	2520	2.450
30	1.345	540	2.281	2700	2.440
40	1.457	600	2.298	2880	2.440
50	1.554	660	2.310		

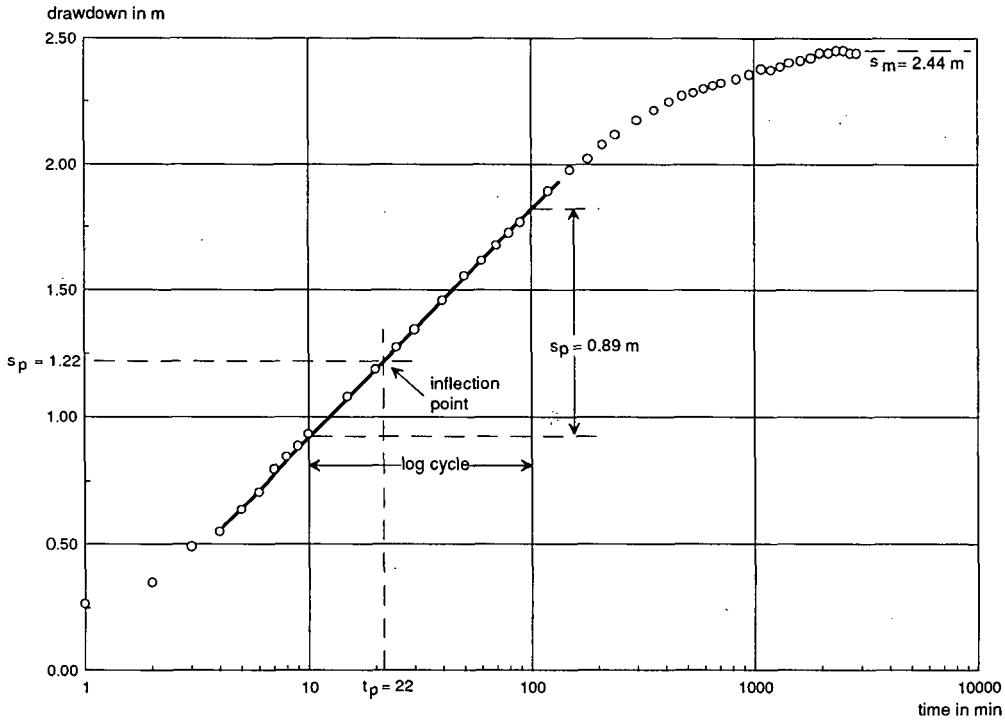

Figure 10.11 Time-drawdown plot of field data of an aquifer test in a semi-confined aquifer

shows that the t value of the inflection point is equal to $22 \text{ min} = 1.5 \times 10^{-2} \text{ d}$.

The slope of the straight line in Figure 10.11 shows that Δs_p is 0.89 m. Substituting the appropriate values into Equation 10.12 yields

$$e^{r/L} K_0 (r/L) = 2.3 \frac{s_p}{\Delta s_p} = 2.3 \frac{1.22}{0.89} = 3.15$$

According to Appendix 10.3, the r/L value is 0.0575. Substituting the r value yields

$$L = \frac{20}{0.0575} = 348 \text{ m}$$

Substituting the appropriate values into Equation 10.11 yields

$$KH = \frac{2.3 Q}{4\pi\Delta s_p} e^{-r/L} = \frac{2.3 \times 545}{4 \times 3.14 \times 0.89} e^{-0.0575} = 106 \text{ m}^2/\text{d}$$

Substituting the appropriate values into Equation 10.10 yields

$$S = \frac{4KHt_p}{r^2} \frac{r}{2L} = \frac{4 \times 106 \times 1.5 \times 10^{-2}}{20^2} \times \frac{20}{2 \times 348} = 4.6 \times 10^{-4}$$

The c value is then

$$c = \frac{L^2}{KH} = \frac{348^2}{106} = 1142 \text{ d}$$

We checked the results of the above analysis by calculating theoretical drawdown values with Equations 10.7 and 10.8, and Appendix 10.2. These values were almost identical to the observed drawdown values, so we can regard the results of the analysis as being correct.

10.4.3 Time-Recovery Analysis

After a well has been pumped for a certain period of time, t_{pump} , and is shut down, the water level in the pumped well and in the piezometers – if any – will stop falling and will start to rise again to its original position (Figure 10.12). This recovery of the water level can be measured as residual drawdown s' (i.e. as the difference between the original water level prior to pumping and the actual water level measured at a certain moment t' since pumping stopped).

This residual drawdown s' at time t' is also equal to the difference between the drawdown that results from pumping the well at a discharge Q for the hypothetical time $t_{\text{pump}} + t'$ and the recovery that results from injecting water at the same point at the same rate Q through a hypothetical injection well for time t'

$$s'(t') = s(t_{\text{pump}} + t') - s(t') \quad (10.13)$$

On the basis of this principle, the recovery values $s(t')$ can be calculated if the hypothetical drawdown values $s(t_{\text{pump}} + t')$ can be estimated. This can be done if the drawdown data during pumping were analyzed with one of the methods given in the previous sections. By back-substituting the hydraulic characteristics that were

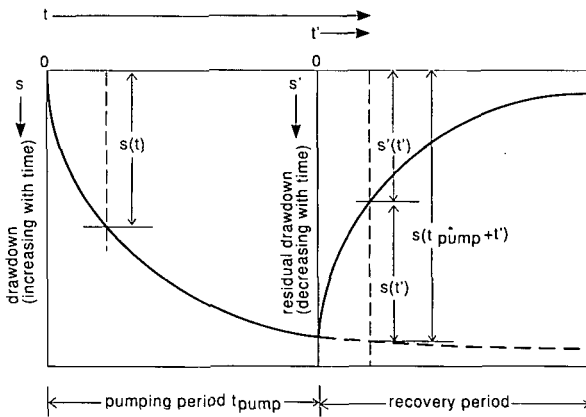

Figure 10.12 Time-drawdown behaviour during pumping tests and recovery tests

obtained into the appropriate equations, we can calculate hypothetical values of $s(t_{\text{pump}} + t')$. When, from these, we subtract the observed residual-drawdown data $s'(t')$, we obtain synthetic recovery values $s(t')$.

An analysis of recovery data is identical to that of drawdown data, so any of the methods discussed in the previous sections can be used. This time-consuming work can be avoided with the computer program SATEM (Boonstra 1989).

Unconfined Aquifers

Instead of using synthetic recovery data, we can also use the residual-drawdown data directly in the analysis.

On the basis of Equation 10.13, Theis developed his recovery method for confined aquifers. For unconfined aquifers, after a constant-rate pumping test, the residual drawdown s' during the recovery period is given by

$$s' = \frac{Q}{4\pi KH} \{W(u) - W(u')\} \quad (10.14)$$

and

$$u = \frac{r^2\mu}{4KHt} \quad \text{or} \quad u' = \frac{r^2\mu'}{4KHt'} \quad (10.15)$$

where

- s' = residual drawdown (m)
- μ' = specific yield during recovery (-)
- $t = t_{\text{pump}} + t' =$ time since pumping started (d)
- t' = time since pumping stopped (d)

In Figure 10.13, the expression $W(u) - W(u')$ is plotted versus u'/u on semi-log paper. This shows that, for small values of u'/u , the expression exhibits a straight-line segment. If we take $u' < 0.1$ - the same value as in Section 10.4.1 - it will result,

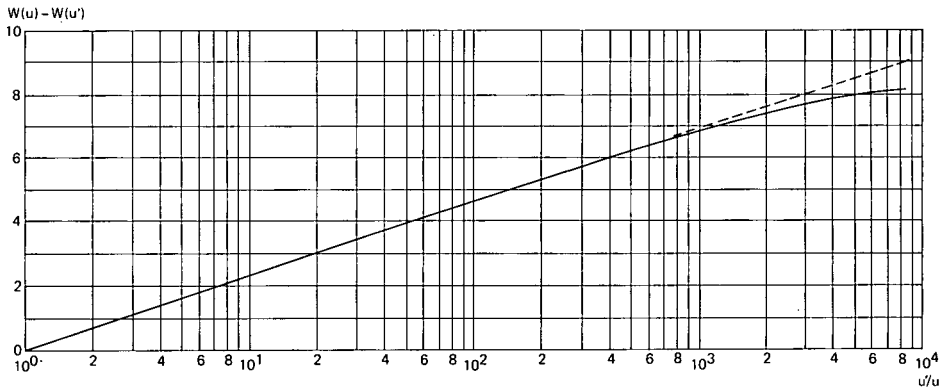

Figure 10.13 Theis recovery well function $W(u) - W(u')$ versus u'/u for fully-penetrating wells in unconfined aquifers

with $t/t' = u'\mu/um'$ and $t = t_{\text{pump}} + t'$ in the following limiting condition

$$\frac{t}{t'} < 1 + \frac{KH t_{\text{pump}}}{2.5 r^2 \mu'} \quad (10.16)$$

When u' is sufficiently small ($u' < 0.1$) – the value of u is then also smaller than 0.1 – Equation 10.14 can be approximated by

$$s' = \frac{2.3Q}{4\pi KH} \log \frac{\mu't}{\mu't'} \quad (10.17)$$

If we use residual-drawdown observations at a particular distance r from the pumped well and plot the residual drawdown s' versus the logarithm of the time ratio t/t' , we obtain a straight line, provided that the time of pumping t_{pump} was long enough. If we express the slope of this straight-line segment as the drawdown difference ($\Delta s' = s'_1 - s'_2$) per log cycle of the time ratio, rearranging Equation 10.17 gives

$$KH = \frac{2.3Q}{4\pi \Delta s'} \quad (10.18)$$

If we extend the straight line until it intercepts the time-axis where $s' = 0$, the interception point has the coordinates $s' = 0$ and $t/t' = (t/t')_0$. Substituting these values into Equation 10.17 gives $\log [\mu't/\mu't'] = 0$ or $[\mu't/\mu't'] = 1$ or

$$\mu' = \frac{\mu}{(t/t')_0} \quad (10.19)$$

The Theis recovery method is based on the assumptions listed in Section 10.4 and on the limiting condition that the pumping time is sufficiently long for a straight-line segment to be distinguished in a time-residual drawdown plot on semi-log paper.

Procedure 3

- For one of the wells, plot the residual-drawdown values s' versus the corresponding time ratio t/t' on semi-log paper (t/t' on logarithmic scale);

- Select a time-ratio range and draw a best-fitting straight line through that part of the plotted points;
- Determine the slope of the straight line (i.e. the drawdown difference $\Delta s'$ per log cycle of time ratio t/t');
- Substitute the values of Q and $\Delta s'$ into Equation 10.18 and solve for KH ;
- Extend the straight line until it intercepts the time-ratio axis where $s' = 0$, and read the value of $(t/t')_0$;
- Substitute this value and that of the specific yield obtained from analyzing the drawdown data into Equation 10.19 and solve for μ' ;
- Substitute the values of t_{pump} , KH , r , and μ' into Equation 10.16 and solve for t/t' . This t/t' value should be greater than the time-ratio range for which the straight-line segment was selected;
- If residual-drawdown values are available for more than one well, apply the above procedure to the other wells also.

Remark 5

When, for a semi-confined aquifer, the residual-drawdown data are plotted versus t/t' on semi-log paper, the plot will usually show an S curve like the one in Figure 10.10. If we analyze these data with the Theis recovery method, using the slope at the inflection point, we overestimate the transmissivity (compare Equations 10.4 and 10.11) and underestimate the specific yield μ' , because the $(t/t')_0$ value is greater than one. The Theis recovery method can only be used for semi-confined aquifers when the r/L value is small. This is usually the case when the residual-drawdown data of the pumped well itself are being analyzed (i.e. in single-well tests).

Example 10.3

This example concerns the same single-well test as in Example 10.1. Table 10.4 shows the observed residual drawdowns as a function of time.

Calculate KH and μ , using the Theis recovery method.

Figure 10.14 shows the plot of residual drawdown versus time on semi-logarithmic

Table 10.4 Time-residual drawdown values of a single-well test

Time t' (min)	Residual drawdown $s'(t')$ (m)	Time t' (min)	Residual drawdown $s'(t')$ (m)	Time t' (min)	Residual drawdown $s'(t')$ (m)
5	0.888	46	0.588	240	0.226
10	0.847	50	0.563	330	0.158
15	0.817	56	0.517	450	0.193
20	0.760	60	0.514	570	0.060
25	0.683	75	0.460	630	0.075
30	0.648	105	0.393	750	0.015
34	0.636	120	0.321	870	0.015
40	0.588	180	0.310	990	0.001

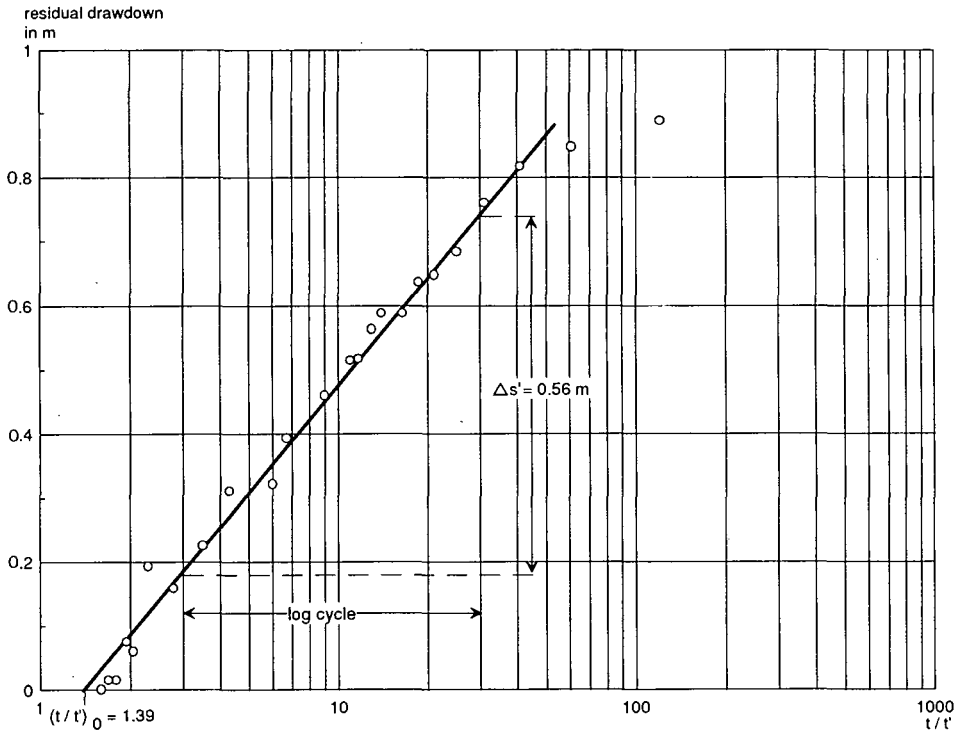

Figure 10.14 Time-residual drawdown plot of field data of a single-well test in an unconfined aquifer

paper. The slope of the straight line in this figure shows that $\Delta s'$ is 0.56 m. Substituting the appropriate values into Eq. 10.18 gives

$$KH = \frac{2.3Q}{4\pi\Delta s'} = \frac{2.3 \times 3853}{4 \times 3.14 \times 0.56} = 1260 \text{ m}^2/\text{d}$$

From Figure 10.14, we can see that the straight line intersects the axis where $s' = 0$, at $(t/t')_0 = 1.39$. Substituting the appropriate values into Equation 10.19 yields

$$\mu' = \frac{\mu}{1.39} = 0.7 \mu$$

The above implies that the specific-yield value during recovery is less than during pumping. This phenomenon is often encountered because of air entrapment when the pores are again filled with water.

The above transmissivity value corresponds well with that found from the time-drawdown analysis (see Example 10.1).

The application of time-drawdown and time-recovery analyses thus enables us to check the calculated transmissivity value. When the two values are close to each other, it implies that the data are consistent (i.e. that the results of the test are reliable).

Remark 6

The residual drawdown data of Table 10.4 seem completely different from the

drawdown data of Table 10.2. This difference can be explained by the non-linear well loss. Using the value of 1.93 m for the calculated non-linear well loss mentioned in Section 10.4.1, Example 10.1, the corrected drawdown at the end of the pumping period is

$$s(t_{\text{pump}}) = 5.016 - 1.93 = 3.09 \text{ m}$$

Assume, for the sake of simplicity, that, if pumping had been continued after 600 minutes, the drawdown at $t = 615$ min could be taken equal to that at $t = 600$ min. Then, according to Equation 10.13, the synthetic recovery value for $t' = 15$ min is

$$s(t') = s(t_{\text{pump}} + t') - s'(t') = 3.09 - 0.817 = 2.27 \text{ m}$$

The corrected drawdown after 15 minutes of pumping (see Table 10.2) is

$$s(t) = 4.161 - 1.93 = 2.23 \text{ m}$$

Theoretically, these two values should have been the same, as was discussed at the beginning of this section.

10.4.4 Distance-Drawdown Analysis of Unconfined Aquifers

When an unconfined aquifer is pumped, the cone of depression will continuously deepen and expand. Even at late pumping times, the water levels in the observation wells will never stabilize to a real steady state, as was illustrated theoretically in Figure 10.7. Although the water levels continue to drop, the cone of depression will eventually deepen uniformly over the area influenced by the pumping. At that stage, the hydraulic gradient has become constant; this phenomenon is called pseudo-steady state.

For this situation, Thiem (1906), using two or more observation wells, developed an equation to determine the transmissivity of an aquifer. This equation is known as the Thiem-Dupuit equation and is written as

$$s_1 - s_2 = \frac{2.3Q}{2\pi KH} \log \frac{r_2}{r_1} \quad (10.20)$$

If the time of pumping is long enough, a plot of the drawdown s observed at a particular time, versus the logarithm of distance r , will show a straight line. If the slope of this straight line is expressed as the drawdown difference ($\Delta s = s_1 - s_2$) per log cycle of distance ($\log r_2/r_1 = 1$), rearranging Equation 10.20 gives

$$KH = \frac{2.3Q}{2\pi\Delta s} \quad (10.21)$$

Thiem's straight-line method is based on the assumptions listed in Section 10.4 and on the limiting condition that the late-time-drawdown graphs of the observation wells run parallel, thus indicating a constant hydraulic gradient.

Procedure 4

- Plot the pseudo-steady state drawdown values s of each observation well versus the corresponding distance r on semi-log paper (r on logarithmic scale);
- Draw the best-fitting straight line through the plotted points;

- Determine the slope of the straight line (i.e. the drawdown difference Δs per log cycle of distance);
- Substitute the values of Q and Δs into Equation 10.21 and solve for KH .

Remark 7

When the drawdowns in an unconfined aquifer are large compared with the aquifer's original saturated thickness, the above analysis should be based on corrected drawdown data. The same correction should be made as was discussed in Section 10.4.1 (see Equation 10.6).

Remark 8

When the water levels in the pumped well are also recorded in addition to those in two or more observation wells, its pseudo-steady state drawdown can be affected by non-linear well losses. When not corrected, its value may deviate from the straight line.

Remark 9

When the pumped well only partially penetrates the aquifer, all pseudo-steady-state drawdowns observed in the wells within a distance approximately equal to the thickness of the aquifer – the pumped well included – will have an extra drawdown due to the effect of partial penetration. Because this effect decreases with increasing distance from the pumped well, the slope of the straight line will be affected and, with that, the transmissivity value of the aquifer.

Example 10.4

An aquifer test was made in a shallow unconfined aquifer; prior to pumping, the aquifer's saturated thickness was only 6.5 m. The well was pumped at a constant rate of 167 m³/d for 520 minutes. The watertable was observed in seven observation wells. Figure 10.15 shows the corrected time-drawdown graphs of these seven wells (see Remark 7). As can be seen from this figure, the curves run parallel in the last hours of the test. Table 10.5 shows the drawdown values in the seven observation wells at the end of the test; these were regarded as representing the pseudo-steady-state drawdowns.

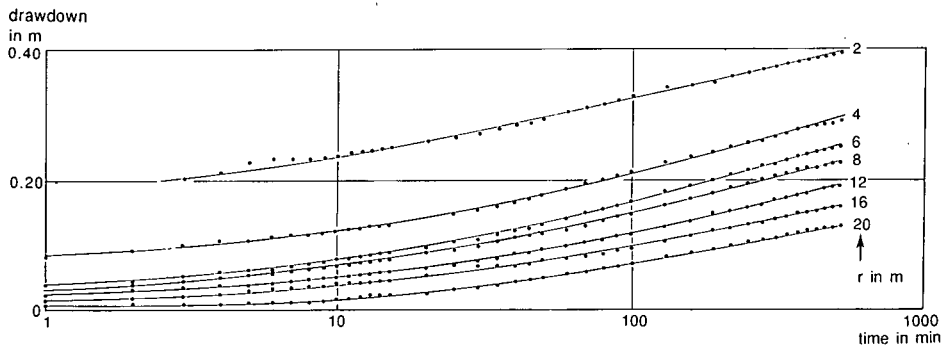

Figure 10.15 Time-drawdown curves of seven observation wells showing field data of an aquifer test in an unconfined aquifer

Table 10.5 Pseudo-steady-state drawdown values

Distance to pumped well (m)	Pseudo-steady-state drawdown	
	Uncorrected (m)	Corrected (m)
2	0.407	0.394
4	0.294	0.287
6	0.252	0.247
8	0.228	0.224
12	0.193	0.190
16	0.161	0.159
20	0.131	0.130

Figure 10.16 shows the distance-drawdown plot on semi-logarithmic paper. As can be seen, all points in the plot lie on a straight line, except that of the observation well at 2 m distance. This phenomenon can be explained by an additional head loss which usually occurs near the well because of the relatively strong curvature of the watertable. The slope of the straight line through the remaining six points shows that Δs is 0.21 m. Substituting the appropriate values into Equation 10.21 yields

$$KH = \frac{2.3Q}{2\pi\Delta s} = \frac{2.3 \times 167}{2 \times 3.14 \times 0.21} = 291 \text{ m}^2/\text{d}$$

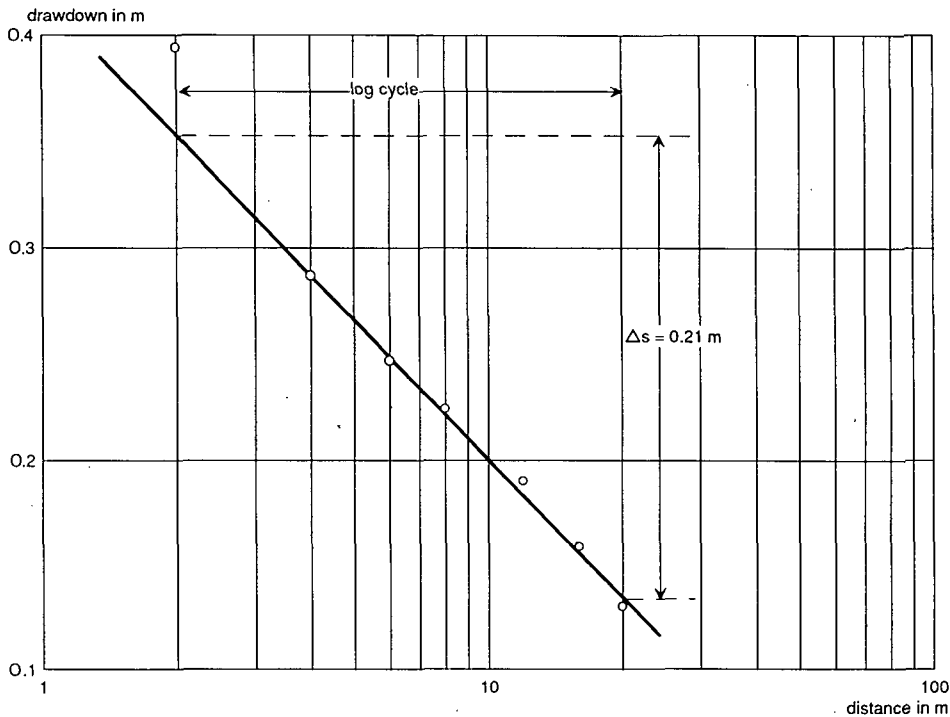

Figure 10.16 Distance-drawdown plot of field data of an aquifer test in an unconfined aquifer

It should be noted that, because of the very shallow aquifer, the observation wells were drilled at relatively short distances from the pumped well.

10.4.5 Distance-Drawdown Analysis of Semi-Confined Aquifers

In semi-confined aquifers, a steady-state situation will develop when the recharge from the overlying aquitard by downward percolation equals the discharge rate of the pump. For this situation, De Glee (1930, 1951) developed the following equation

$$s_m = \frac{Q}{2\pi KH} K_0\left(\frac{r}{L}\right) \quad (10.22)$$

Unaware of the work done many years earlier by De Glee, Hantush and Jacob (1955) also derived Equation 10.22. Hantush (1956, 1964) noted that, if r/L is small, Equation 10.22 can, for all practical purposes, be approximated by

$$s_m = \frac{2.3Q}{2\pi KH} \log\left(1.123 \frac{L}{r}\right) \quad (10.23)$$

with an error of 10, 5, 2, and 1 per cent for r/L values smaller than 0.45, 0.33, 0.22, and 0.16, respectively. In practice, the above approximation is satisfactory up to values of r equal to 0.2 L .

For two observation wells at small distances r_1 and r_2 from the pumped well, Equation 10.23 reads

$$s_{m1} - s_{m2} = \frac{2.3Q}{2\pi KH} \log\left(1.123 \frac{L}{r_1}\right) - \frac{2.3Q}{2\pi KH} \log\left(1.123 \frac{L}{r_2}\right)$$

or

$$s_{m1} - s_{m2} = \frac{2.3Q}{2\pi KH} \log \frac{r_2}{r_1}$$

which is the Thiem-Dupuit equation presented in Section 10.4.4.

It is important to note that the flow system in a pumped semi-confined aquifer consists of a vertical component in the overlying aquitard and a horizontal component in the aquifer. In reality, the flow lines in the aquifer are not horizontal but curved (i.e. there are both vertical and horizontal flow components in the aquifer). The above equations can therefore only be used when the vertical-flow component in the aquifer is so small compared to the horizontal-flow component that it can be neglected. In practice, this condition is fulfilled when $L > 3H$.

A plot of the steady-state drawdown s_m versus the logarithm of the distance r will thus also show a straight line. If the slope of this straight line is expressed as the drawdown difference ($\Delta s_m = s_{m1} - s_{m2}$) per log cycle of distance ($\log r_2/r_1 = 1$), the transmissivity value of the aquifer can be calculated as follows

$$KH = \frac{2.3Q}{2\pi \Delta s_m}$$

If the straight line is extended until it intercepts the distance-axis where $s_m = 0$, the interception point has the coordinates $s_m = 0$ and $r = r_0$. Substituting these values into Equation 10.23 gives

$$\log \left[1.123 \frac{L}{r_0} \right] = 0 \quad \text{or} \quad \left[1.123 \frac{L}{r_0} \right] = 1 \quad \text{or} \quad L = \frac{r_0}{1.123} \quad (10.25)$$

The Hantush-Jacob method is based on the assumptions listed in Section 10.4 and on the following limiting conditions:

- The flow to the pumped well is in steady state;
- $L > 3H$;
- $r/L < 0.2$.

Procedure 5

- Plot the steady-state drawdown values s_m of each observation well versus the corresponding distance r on semi-log paper (r on logarithmic scale);
- Draw the best-fitting straight line through the plotted points;
- Determine the slope of the straight line (i.e. the drawdown difference Δs_m per log cycle of distance);
- Substitute the values of Q and Δs_m into Equation 10.24 and solve for KH ;
- Extend the straight line until it intercepts the distance axis where $s_m = 0$, and read the value of r_0 ;
- Substitute this value into Equation 10.25 and solve for L ;
- Calculate c , using $L = \sqrt{KHc}$.

Remark 10

When the water level in the pumped well is recorded in addition to those in two or more observation wells, its steady-state drawdown can be affected by non-linear well losses. If not corrected, its plotting position may deviate from the straight line.

Remark 11

When the pumped well only partially penetrates the aquifer, all steady-state drawdowns observed in the wells within a distance approximately equal to the thickness of the aquifer – the pumped well included – will have an extra drawdown due to the effect of partial penetration. Because this effect decreases with increasing distance from the pumped well, the slope of the straight line will be affected and, with that, the transmissivity value of the aquifer and the hydraulic resistance of the aquitard.

Example 10.5

An aquifer test was made in a semi-confined aquifer with a thickness of some 10 m. This test (Dalem) is described in detail by Kruseman and De Ridder (1990). The well was pumped at a constant rate of 761 m³/d for 480 minutes. Table 10.6 shows the extrapolated steady-state drawdowns in the six observation wells.

Using the Hantush-Jacob method, calculate KH and c .

Figure 10.17 shows the distance-drawdown plot on semi-logarithmic paper. The slope

Table 10.6 Extrapolated steady-state drawdowns

Distance from pumped well (m)	Steady-state drawdown (m)
10	0.282
30	0.235
60	0.170
90	0.147
120	0.132
400	0.059

of the straight line shows that Δs_m is 0.14 m. Substituting the appropriate values into Equation 10.24 yields

$$KH = \frac{2.3Q}{2\pi\Delta s_m} = \frac{2. \times 761}{2 \times 3.14 \times 0.14} = 1990 \text{ m}^2/\text{d}$$

The intersection point where $s_m = 0$ has the distance value $r = 1000$ m. Substituting this value into Equation 10.25 gives

$$L = \frac{r_0}{1.123} = \frac{1000}{1.123} = 890 \text{ m}$$

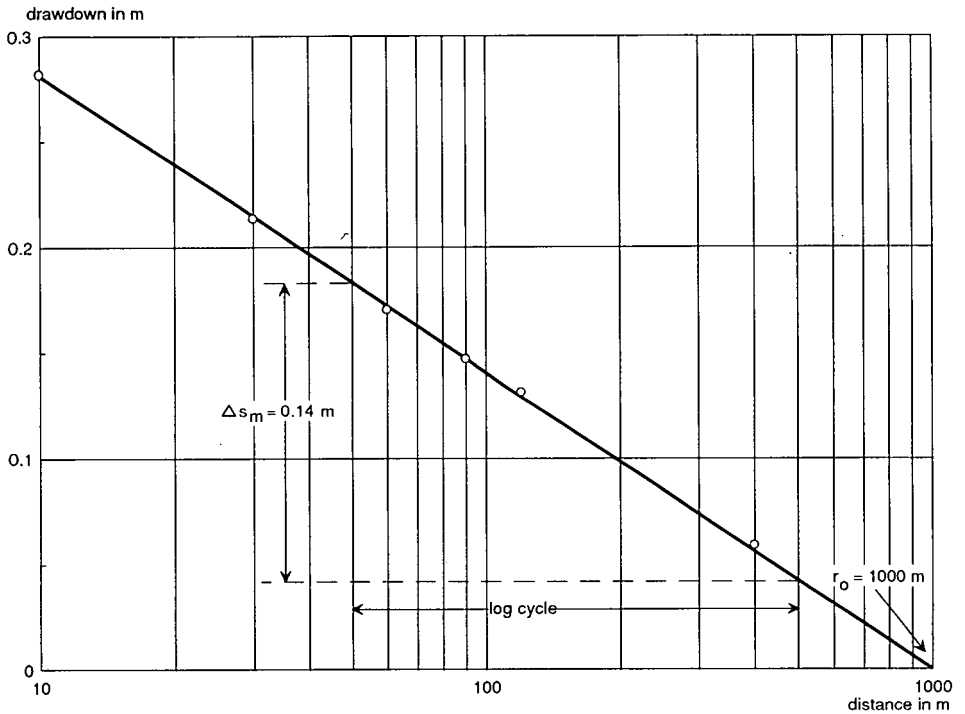

Figure 10.17 Distance-drawdown plot of field data of an aquifer test in a semi-confined aquifer

The c value can now be calculated as follows

$$c = \frac{L^2}{KH} = \frac{890^2}{1990} = 398 \text{ d}$$

Finally, the limiting conditions should be checked. Substituting the above L value into the condition $L > 3H$ gives $H < 296 \text{ m}$, so this condition is fulfilled.

Substituting the appropriate values into the condition $r/L < 0.2$ gives

$$r < 0.2L \rightarrow r < 0.2 \times 890 \rightarrow r < 178 \text{ m}$$

According to this condition, the drawdown value of the observation well at a distance of 400 m should be eliminated from the analysis. Figure 10.17, however, shows that this point, too, lies on the straight line, so in this case this condition is not a limiting factor.

10.5 Concluding Remarks

The diagnostic plots of time-drawdown data presented in the previous sections are theoretical curves. The time-drawdown curves based on field data will often deviate from these theoretical shapes. These deviations can stem from the fact that one or more of the general assumptions and conditions listed in Section 10.4 are not met in the field, or that the method selected is not the correct one for the test site.

It should be realised that all the methods we have discussed are based on highly simplified representations of the natural aquifer. No real aquifers conform fully to these assumed geological or hydrological conditions. In itself, it is quite surprising that these methods so often produce such good results!

Some of the common departures from the theoretical curves will now be discussed.

10.5.1 Delayed-Yield Effect in Unconfined Aquifers

The general assumption that water removed from storage is discharged instantaneously with decline of head is not always met. Drawdown data in an unconfined aquifer often show a 'delayed-yield' effect. The delayed yield is caused by a time lag between the early elastic response of the aquifer and the subsequent downward movement of the watertable. When the time-drawdown curve is plotted on semi-log paper, it shows a typical shape: a relatively steep early-time segment, a flat intermediate segment, and a relatively steep segment again at later times (Figure 10.18).

During the early stage of a test – a stage that may last for only a few minutes – the discharge of the pumped well is derived uniquely from the elastic storage within the aquifer. Hence, the reaction of the unconfined aquifer immediately after the start of pumping is similar to the reaction of a confined aquifer as described by the flow equation of Theis.

Only after some time will the watertable start to fall and the effect of the delayed yield will become apparent. The influence of the delayed yield is comparable to that

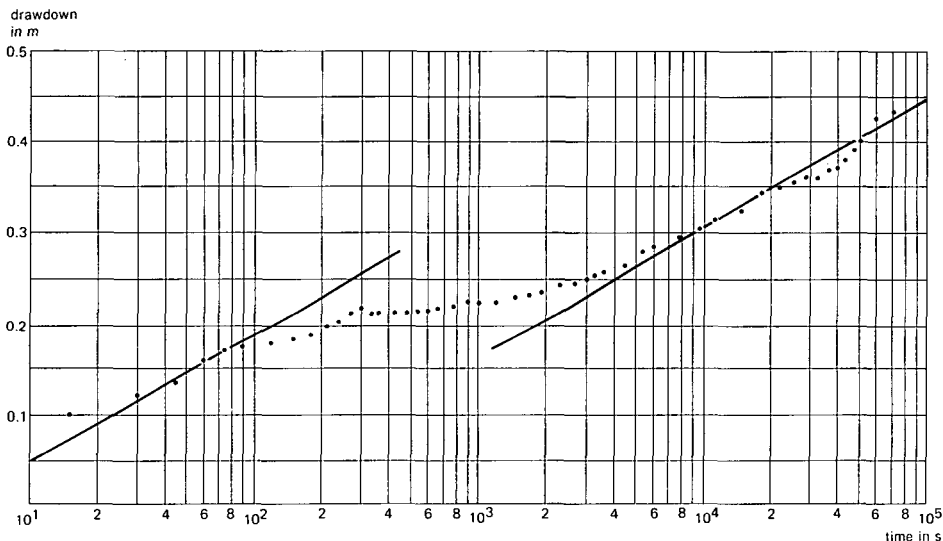

Figure 10.18 Time-drawdown plot of an unconfined aquifer showing delayed-yield effect

of leakage: the drawdown slows down with time and no longer conforms to the Theis curve. After a few minutes to a few hours of pumping, the time-drawdown curve approaches a horizontal position.

The late-time segment of the time-drawdown curve may start from several minutes to several days after the start of pumping. The declining watertable can now keep pace with the increase in the average drawdown. The flow in the aquifer is essentially horizontal again and, as in the early pumping time, the time-drawdown curve approaches the Theis curve.

The above phenomenon means that when a time-drawdown plot shows an S shape as depicted in Figure 10.18, both straight-line segments, which theoretically should run parallel, can be used to determine the transmissivity of the aquifer according to Jacob's straight-line method (Section 10.4.1). With the same method, but using only the straight line through the late-time drawdown data, the specific-yield value can also be found.

It should be noted that, for observation wells relatively close to the pumped well, usually only the right-hand side of the curve of Figure 10.18 will be present in a time-drawdown plot of field data. This phenomenon is thus also encountered with single-well test data.

10.5.2 Partially-Penetrating Effect in Unconfined Aquifers

Some aquifers are so thick that it is not justified to install a fully-penetrating well. Instead, the aquifer has to be pumped by a partially-penetrating well. Because partial penetration induces vertical-flow components in the vicinity of the pumped well, the assumption that the well receives water from horizontal flow is not valid. Hence, the

standard methods of analysis cannot be used unless allowance is made for partial penetration.

Partial penetration causes the flow velocity in the immediate vicinity of the well to be higher than it would be otherwise, leading to an extra loss of head. This effect is strongest at the well face, and decreases with increasing distance from the well. It is negligible if measured at a distance that is one to two times greater than the saturated thickness of the aquifer, depending on the degree of penetration.

Hantush (1962) presented a solution for partially-penetrating wells in confined aquifers. Because of the large aquifer thickness, the induced drawdowns are usually relatively small, so Hantush's solution can also be applied to unconfined aquifers. Figure 10.19 shows the typical time-drawdown shape of a confined or unconfined aquifer pumped by a partially-penetrating well. The curve shows a curved-line segment, an inflection point, a second curved-line segment, and finally a straight-line segment under a slope. This last segment can be used to determine the transmissivity of the aquifer according to Jacob's straight-line method (Section 10.4.1). An estimate of the specific-yield value, however, is not possible. This can be done with the log-log procedure (see Kruseman and De Ridder 1990) or with the computer program SATEM (Boonstra 1989). If SATEM is used, the saturated thickness of the aquifer can be determined in a trial-and-error fashion.

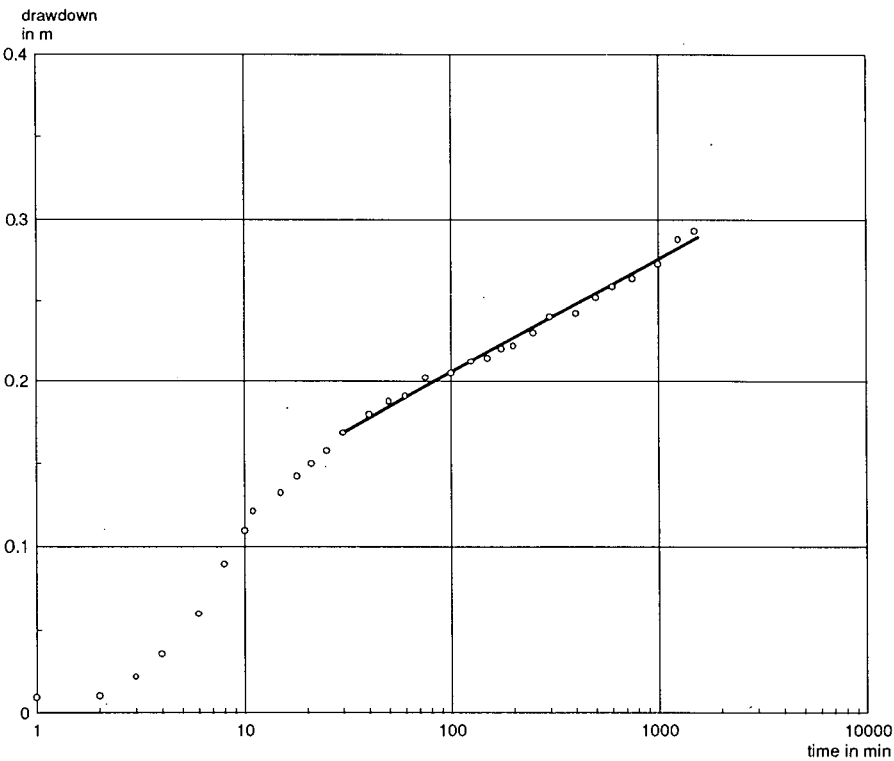

Figure 10.19 Time-drawdown plot of an unconfined aquifer when the pumped well only partially penetrates the aquifer

It should be noted that, for observation wells relatively close to the pumped well, usually only the second curved-line segment and the straight-line segment of the curve in Figure 10.19 will be present in a time-drawdown plot of field data. This phenomenon is thus also encountered with single-well-test data.

10.5.3 Deviations in Late-Time Drawdown Data

Steepening of Late-Time Slope

All real aquifers are limited by geological or hydrological boundaries. If, however, at the end of the pumping period, no such boundaries have been met within the cone of depression, it is said that the aquifer has a seemingly infinite areal extent. When the cone of depression intersects an impervious boundary (e.g. a fault or an impermeable valley wall), it can expand no farther in that direction. The cone must expand and deepen more rapidly at the fault or valley wall to maintain the yield of the well.

All the methods we have presented also assume that the tested aquifer is homogeneous within the area influenced by the pumping. This condition is never fully met, but it depends on the variations in hydraulic conductivity whether these variations will cause deviations from the theoretical time-drawdown curves. When, in one of the directions, the sediments become finer and the hydraulic conductivity decreases, the slope of the time-drawdown curve will become steeper when the cone of depression spreads into that area. The typical shape resulting from this phenomenon is identical to that of an impervious boundary. Well interference will also result in a similar phenomenon.

Flattening of Late-Time Slope

An opposite phenomenon is encountered when the cone of depression intersects an open water body. If the open water body is hydraulically connected with the aquifer, the aquifer is recharged at an increasing rate as the cone of depression spreads with time. This results in a flattening of the slope of the time-drawdown curve at later times (Figure 10.20). As a phenomenon, it resembles the recharge that occurs in a

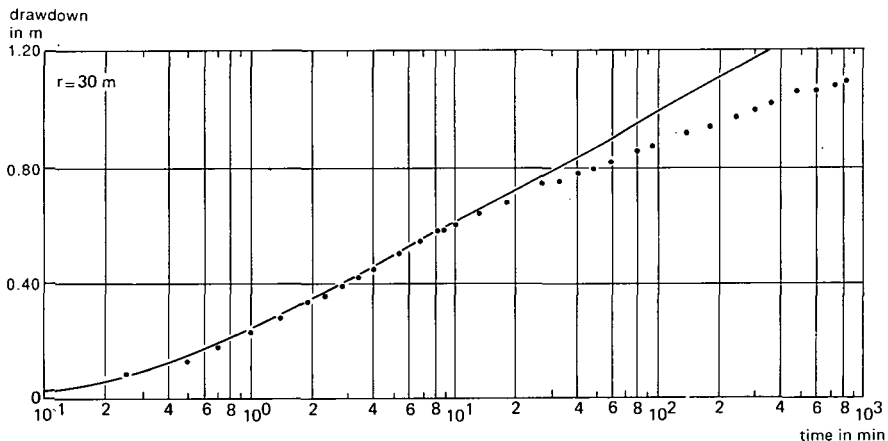

Figure 10.20 Time-drawdown plot of an unconfined aquifer showing deviations in the late-time-drawdown data

semi-confined aquifer. The same phenomenon occurs when, in one of the directions, the hydraulic conductivity or the aquifer thickness increases.

The above cases will result in time-drawdown plots in which the last part of the late-time drawdown data will deviate from a straight line under a slope. This part of the plot should be disregarded when the slope of the straight-line segment is being determined.

10.5.4 Conclusions

It will be clear that there are various reasons why time-drawdown data depart from the theoretical curves. It will also be clear that different phenomena can cause identical anomalies. So, if one is to make a correct analysis, one must have a proper knowledge of the geology of the test site. Because, unfortunately, this knowledge is often fragmentary, determining hydraulic characteristics is more an art than a science. This is one of the main reasons why it is strongly recommended to continue to monitor the watertable behaviour during the recovery period. This allows a second estimate of the aquifer's transmissivity to be made, which can then be compared with the one found during the pumping period. Even with single well tests, this second estimate is possible.

Finally, a few remarks on the difference between aquifer tests and single-well tests. The results of aquifer tests are more reliable and more accurate than those of single-well tests. Another advantage is that aquifer tests allow estimates to be made of both the aquifer's transmissivity and its specific yield or storativity, which is not possible with single-well tests. Further, if an aquifer test uses more than one observation well, separate estimates of the hydraulic characteristics can be made for each well, allowing the various values to be compared. Moreover, one can make yet another estimate of the hydraulic characteristics by using not only the time-drawdown relationship, but also the distance-drawdown relationships.

References

- Boonstra, J. 1989. SATEM : Selected aquifer test evaluation methods : a microcomputer program. ILRI Publication 48, Wageningen, 80 p.
- Bos, M.G. (ed.) 1989. Discharge measurement structures. 3rd rev. ed. ILRI Publication 20, Wageningen, 401 p.
- Cooper, H.H. and C.E. Jacob 1946. A generalized graphical method for evaluating formation constants and summarizing well field history. *Am. Geophys. Union Trans.*, 27, pp. 526-534.
- De Glee, G.J. 1930. Over grondwaterstromingen bij wateronttrekking door middel van putten. Waltman, Delft, 175 p.
- De Glee, G.J. 1951. Berekeningsmethoden voor de winning van grondwater. In: *Winning van grondwater: derde vacatiecursus in drinkwatervoorziening*. Delft University of Technology. pp. 38-80.
- Driscoll, F.G. 1986. *Groundwater and wells*. 2nd ed. Johnson Division, St. Paul, 1089 p.
- Hantush, M.S. 1956. Analysis of data from pumping tests in leaky aquifers. *Am. Geophys. Union Trans.*, 37, pp. 702-714.
- Hantush, M.S. 1962. Aquifer tests on partially-penetrating wells. *Am. Soc. Civ. Eng. Trans.*, 127, Part I, pp. 284-308.

- Hantush, M.S. 1964. Hydraulics of wells. In: V.T. Chow (ed.). Adv. Hydrosience 1, Academic Press, New York. pp. 281-432.
- Hantush, M.S. and C.E. Jacob 1955. Non-steady radial flow in an infinite leaky aquifer. Am. Geophys. Union Trans., 36, pp. 95-100.
- Jacob, C.E. 1944. Notes on determining permeability by pumping tests under watertable conditions. U.S. Geol. Surv. Open File Rept.
- Jacob, C.E. 1950. Flow of groundwater. In: H. Rouse (ed.). Engineering Hydraulics. Wiley, New York. pp. 321-386.
- Kruseman, G.P. and N.A. de Ridder 1990. Analysis and evaluation of pumping test data. ILRI Publication 47, Wageningen, 377 p.
- Theis, C.V. 1935. The relation between the lowering of the piezometric surface and the rate and duration of discharge of a well using groundwater storage. Am. Geophys. Union Trans., 16, pp. 519-524.
- Thiem, G. 1906. Hydrologische Methoden. Gebhardt, Leipzig, 56 p.

Appendix 10.1 Values of the Theis well function $W(u)$ as a function of $1/u$

$1/u$	$\times 10^{-1}$	$\times 10^0$	$\times 10^1$	$\times 10^2$	$\times 10^3$	$\times 10^4$	$\times 10^5$	$\times 10^6$	$\times 10^7$	$\times 10^8$	$\times 10^9$
1.0	4.16(-6)	2.19(-1)	1.82	4.04	6.33	8.63	1.09(1)	1.32(1)	1.55(1)	1.78(1)	2.01(1)
1.2	2.60(-5)	2.93(-1)	1.99	4.22	6.51	8.82	1.11(1)	1.34(1)	1.57(1)	1.80(1)	2.03(1)
1.5	1.68(-4)	3.98(-1)	2.20	4.44	6.74	9.04	1.13(1)	1.36(1)	1.59(1)	1.82(1)	2.06(1)
2.0	1.15(-3)	5.60(-1)	2.47	4.73	7.02	9.33	1.16(1)	1.39(1)	1.62(1)	1.85(1)	2.08(1)
2.5	3.78(-3)	7.02(-1)	2.68	4.95	7.25	9.55	1.19(1)	1.42(1)	1.65(1)	1.88(1)	2.11(1)
3.0	8.57(-3)	8.29(-1)	2.86	5.13	7.43	9.73	1.20(1)	1.43(1)	1.66(1)	1.89(1)	2.12(1)
3.5	1.57(-2)	9.42(-1)	3.01	5.28	7.58	9.89	1.22(1)	1.45(1)	1.68(1)	1.91(1)	2.14(1)
4.0	2.49(-2)	1.04	3.14	5.42	7.72	1.00(1)	1.23(1)	1.46(1)	1.69(1)	1.92(1)	2.15(1)
4.5	3.61(-2)	1.14	3.25	5.53	7.83	1.01(1)	1.24(1)	1.47(1)	1.70(1)	1.93(1)	2.17(1)
5.0	4.89(-2)	1.22	3.35	5.64	7.94	1.02(1)	1.25(1)	1.48(1)	1.72(1)	1.95(1)	2.18(1)
6.0	7.83(-2)	1.37	3.53	5.82	8.12	1.04(1)	1.27(1)	1.50(1)	1.73(1)	1.96(1)	2.19(1)
7.0	1.11(-1)	1.51	3.69	5.98	8.28	1.06(1)	1.29(1)	1.52(1)	1.75(1)	1.98(1)	2.21(1)
8.0	1.46(-1)	1.62	3.82	6.11	8.41	1.07(1)	1.30(1)	1.53(1)	1.76(1)	1.99(1)	2.22(1)
9.0	1.83(-1)	1.73	3.93	6.23	8.53	1.08(1)	1.31(1)	1.54(1)	1.77(1)	2.00(1)	2.23(1)

Note: 1.15(-3) means 1.15×10^{-3} or 0.00115

Example: $1/u = 5 \times 10^5$

$W(u) = 12.5$

Appendix 10.2 Values of the Hantush well function $W(u, r/L)$ as function of $1/u$ and r/L

$1/u$	$r/L = .005$	$r/L = .01$	$r/L = .02$	$r/L = .03$	$r/L = .04$	$r/L = .05$	$r/L = .06$	$r/L = .07$	$r/L = .08$	$r/L = .09$	$r/L = .1$
1.0											2.19(-1)
1.5											3.97(-1)
2.5							7.02(-1)	7.01(-1)	7.01(-1)	3.98(-1)	7.00(-1)
4.0							1.04	1.04	1.04	1.04	1.04
6.5							1.44	1.44	1.44	1.43	1.43
1.0(1)							1.82	1.81	1.81	1.81	1.80
1.5(1)			2.20	2.19	2.19	2.19	2.19	2.18	2.18	2.17	2.17
2.5(1)			2.68	2.68	2.67	2.67	2.66	2.66	2.65	2.64	2.63
4.0(1)		3.14	3.13	3.13	3.12	3.11	3.10	3.09	3.08	3.07	3.05
6.5(1)		3.61	3.61	3.60	3.59	3.58	3.56	3.54	3.52	3.49	3.47
1.0(2)		4.04	4.03	4.02	4.00	3.98	3.95	3.93	3.89	3.86	3.82
1.5(2)	4.44	4.44	4.43	4.41	4.38	4.35	4.31	4.27	4.22	4.17	4.11
2.5(2)	4.95	4.94	4.92	4.89	4.85	4.80	4.74	4.67	4.59	4.51	4.42
4.0(2)	5.41	5.41	5.38	5.33	5.27	5.19	5.09	4.99	4.88	4.76	4.64
6.5(2)	5.90	5.89	5.84	5.76	5.66	5.54	5.40	5.25	5.09	4.93	4.77
1.0(3)	6.33	6.31	6.23	6.12	5.97	5.80	5.61	5.41	5.21	5.01	4.83
1.5(3)	6.73	6.70	6.59	6.43	6.22	5.98	5.74	5.50	5.27	5.05	4.85
2.5(3)	7.23	7.19	7.01	6.76	6.45	6.14	5.83	5.55	5.29	5.06	
4.0(3)	7.69	7.62	7.35	6.99	6.59	6.20	5.86	5.56			
6.5(3)	8.16	8.05	7.65	7.14	6.65	6.22	5.87				
1.0(4)	8.57	8.40	7.84	7.21	6.67	6.23					
1.5(4)	8.95	8.70	7.96	7.24							
2.5(4)	9.40	9.01	8.03	7.25							
4.0(4)	9.78	9.22	8.05								
6.5(4)	1.01(1)	9.36	8.06								
1.0(5)	1.04(1)	9.42									
1.5(5)	1.06(1)	9.44									
2.5(5)	1.07(1)										
4.0(5)	1.08(1)										
∞	1.08(1)	9.44	8.06	7.25	6.67	6.23	5.87	5.56	5.29	5.06	4.85

$$W(u, r/L) = 2 K_0(r/L)$$

Appendix 10.2 (cont.)

1/u	r/L = .2	r/L = .3	r/L = .4	r/L = .6	r/L = .8	r/L = 1	r/L = 2	r/L = 3	r/L = 4	r/L = 5	r/L = 6
1.0(-1)	4.15(-6)	4.15(-6)	4.14(-6)	4.12(-6)	4.10(-6)	4.06(-6)	3.79(-6)	3.36(-6)	2.84(-6)	2.29(-6)	1.80(-6)
1.5(-1)	1.68(-4)	1.68(-4)	1.67(-4)	1.66(-4)	1.65(-4)	1.63(-4)	1.47(-4)	1.25(-4)	9.86(-5)	7.30(-5)	5.03(-5)
2.5(-1)	3.77(-3)	3.76(-3)	3.75(-3)	3.71(-3)	3.65(-3)	3.58(-3)	3.06(-3)	2.35(-3)	1.63(-3)	1.02(-3)	5.79(-4)
4.0(-1)	2.48(-2)	2.47(-2)	2.46(-2)	2.42(-2)	2.37(-2)	2.30(-2)	1.82(-2)	1.23(-2)	7.22(-3)	3.66(-3)	1.69(-3)
6.5(-1)	9.40(-2)	9.35(-2)	9.27(-2)	9.05(-2)	8.75(-2)	8.39(-2)	5.90(-2)	3.35(-2)	1.57(-2)	6.42(-3)	2.38(-3)
1.0	2.18(-1)	2.16(-1)	2.14(-1)	2.06(-1)	1.97(-1)	1.85(-1)	1.14(-1)	5.34(-2)	2.07(-2)	7.27(-3)	2.48(-3)
1.5	3.95(-1)	3.90(-1)	3.84(-1)	3.66(-1)	3.44(-1)	3.17(-1)	1.66(-1)	6.48(-2)	2.21(-2)	7.38(-3)	2.49(-3)
2.5	6.93(-1)	6.81(-1)	6.65(-1)	6.21(-1)	5.65(-1)	5.02(-1)	2.10(-1)	6.91(-2)	2.23(-2)		
4.0	1.02	9.99(-1)	9.65(-1)	8.77(-1)	7.70(-1)	6.57(-1)	2.25(-1)	6.95(-2)			
6.5	1.40	1.35	1.29	1.13	9.46(-1)	7.68(-1)	2.28(-1)				
1.0(1)	1.75	1.67	1.56	1.31	1.05	8.19(-1)					
1.5(1)	2.08	1.95	1.79	1.44	1.10	8.37(-1)					
2.5(1)	2.48	2.27	2.02	1.52	1.13	8.42(-1)					
4.0(1)	2.81	2.49	2.14	1.55							
6.5(1)	3.10	2.64	2.21	1.55							
1.0(2)	3.29	2.71	2.23	1.56							
1.5(2)	3.41	2.74									
2.5(2)	3.48										
4.0(2)	3.50										
6.5(2)	3.51										
∞	3.51	2.74	2.23	1.56	1.13	8.42(-1)	2.28(-1)	6.95(-2)	2.23(-2)	7.38(-3)	2.49(-3)

$$W(u, r/L) = 2 K_0(r/L)$$

Note: 6.5(2) means 6.5×10^2 or 650

Example: $1/u = 1.5(3) = 1.5 \times 10^3 = 1500$ and $r/L = 0.1$

$$W(u, r/L) = 4.85$$

Appendix 10.3 Values of $K_0(r/L)$ and $e^{r/L} K_0(r/L)$ as function of r/L

r/L	$K_0(r/L)$	$e^{r/L} K_0(r/L)$	r/L	$K_0(r/L)$	$e^{r/L} K_0(r/L)$	r/L	$K_0(r/L)$	$e^{r/L} K_0(r/L)$	r/L	$K_0(r/L)$	$e^{r/L} K_0(r/L)$
1.0(-2)	4.72	4.77	3.8(-2)	3.39	3.52	6.6(-2)	2.84	3.03	9.4(-2)	2.49	2.73
1.1(-2)	4.63	4.68	3.9(-2)	3.36	3.50	6.7(-2)	2.82	3.02	9.5(-2)	2.48	2.72
1.2(-2)	4.54	4.59	4.0(-2)	3.34	3.47	6.8(-2)	2.81	3.01	9.6(-2)	2.47	2.72
1.3(-2)	4.46	4.52	4.1(-2)	3.31	3.45	6.9(-2)	2.79	2.99	9.7(-2)	2.46	2.71
1.4(-2)	4.38	4.45	4.2(-2)	3.29	3.43	7.0(-2)	2.78	2.98	9.8(-2)	2.45	2.70
1.5(-2)	4.32	4.38	4.3(-2)	3.26	3.41	7.1(-2)	2.77	2.97	9.9(-2)	2.44	2.69
1.6(-2)	4.25	4.32	4.4(-2)	3.24	3.39	7.2(-2)	2.75	2.96	1.0(-1)	2.43	2.68
1.7(-2)	4.19	4.26	4.5(-2)	3.22	3.37	7.3(-2)	2.74	2.95	1.1(-1)	2.33	2.60
1.8(-2)	4.13	4.21	4.6(-2)	3.20	3.35	7.4(-2)	2.72	2.93	1.2(-1)	2.25	2.53
1.9(-2)	4.08	4.16	4.7(-2)	3.18	3.33	7.5(-2)	2.71	2.92	1.3(-1)	2.17	2.47
2.0(-2)	4.03	4.11	4.8(-2)	3.15	3.31	7.6(-2)	2.70	2.91	1.4(-1)	2.10	2.41
2.1(-2)	3.98	4.06	4.9(-2)	3.13	3.29	7.7(-2)	2.69	2.90	1.5(-1)	2.03	2.36
2.2(-2)	3.93	4.02	5.0(-2)	3.11	3.27	7.8(-2)	2.67	2.89	1.6(-1)	1.97	2.31
2.3(-2)	3.89	3.98	5.1(-2)	3.09	3.26	7.9(-2)	2.66	2.88	1.7(-1)	1.91	2.26
2.4(-2)	3.85	3.94	5.2(-2)	3.08	3.24	8.0(-2)	2.65	2.87	1.8(-1)	1.85	2.22
2.5(-2)	3.81	3.90	5.3(-2)	3.06	3.22	8.1(-2)	2.64	2.86	1.9(-1)	1.80	2.18
2.6(-2)	3.77	3.87	5.4(-2)	3.04	3.21	8.2(-2)	2.62	2.85	2.0(-1)	1.75	2.14
2.7(-2)	3.73	3.83	5.5(-2)	3.02	3.19	8.3(-2)	2.61	2.84	2.1(-1)	1.71	2.10
2.8(-2)	3.69	3.80	5.6(-2)	3.00	3.17	8.4(-2)	2.60	2.83	2.2(-1)	1.66	2.07
2.9(-2)	3.66	3.76	5.7(-2)	2.98	3.16	8.5(-2)	2.59	2.82	2.3(-1)	1.62	2.04
3.0(-2)	3.62	3.73	5.8(-2)	2.97	3.14	8.6(-2)	2.58	2.81	2.4(-1)	1.58	2.01
3.1(-2)	3.59	3.70	5.9(-2)	2.95	3.13	8.7(-2)	2.56	2.80	2.5(-1)	1.54	1.98
3.2(-2)	3.56	3.67	6.0(-2)	2.93	3.11	8.8(-2)	2.55	2.79	2.6(-1)	1.50	1.95
3.3(-2)	3.53	3.65	6.1(-2)	2.92	3.10	8.9(-2)	2.54	2.78	2.7(-1)	1.47	1.93
3.4(-2)	3.50	3.62	6.2(-2)	2.90	3.09	9.0(-2)	2.53	2.77	2.8(-1)	1.44	1.90
3.5(-2)	3.47	3.59	6.3(-2)	2.88	3.07	9.1(-2)	2.52	2.76	2.9(-1)	1.40	1.88
3.6(-2)	3.44	3.57	6.4(-2)	2.87	3.06	9.2(-2)	2.51	2.75	3.0(-1)	1.37	1.85
3.7(-2)	3.41	3.54	6.5(-2)	2.85	3.04	9.3(-2)	2.50	2.74	3.1(-1)	1.34	1.83

r/L	$K_0(r/L)$	$e^{r/L} K_0(r/L)$	r/L	$K_0(r/L)$	$e^{r/L} K_0(r/L)$	r/L	$K_0(r/L)$	$e^{r/L} K_0(r/L)$	r/L	$K_0(r/L)$	$e^{r/L} K_0(r/L)$
3.2(-1)	1.31	1.81	6.0(-1)	7.78(-1)	1.42	8.8(-1)	5.01(-1)	1.21	2.6	5.54(-2)	7.46(-1)
3.3(-1)	1.29	1.79	6.1(-1)	7.65(-1)	1.41	8.9(-1)	4.94(-1)	1.20	2.7	4.93(-2)	7.33(-1)
3.4(-1)	1.26	1.77	6.2(-1)	7.52(-1)	1.40	9.0(-1)	4.87(-1)	1.20	2.8	4.38(-2)	7.21(-1)
3.5(-1)	1.23	1.75	6.3(-1)	7.40(-1)	1.39	9.1(-1)	4.80(-1)	1.19	2.9	3.90(-2)	7.09(-1)
3.6(-1)	1.21	1.73	6.4(-1)	7.28(-1)	1.38	9.2(-1)	4.73(-1)	1.19	3.0	3.47(-2)	6.98(-1)
3.7(-1)	1.18	1.71	6.5(-1)	7.16(-1)	1.37	9.3(-1)	4.66(-1)	1.18	3.1	3.10(-2)	6.87(-1)
3.8(-1)	1.16	1.70	6.6(-1)	7.04(-1)	1.36	9.4(-1)	4.59(-1)	1.18	3.2	2.76(-2)	6.77(-1)
3.9(-1)	1.14	1.68	6.7(-1)	6.93(-1)	1.35	9.5(-1)	4.52(-1)	1.17	3.3	2.46(-2)	6.67(-1)
4.0(-1)	1.11	1.66	6.8(-1)	6.82(-1)	1.35	9.6(-1)	4.46(-1)	1.16	3.4	2.20(-2)	6.58(-1)
4.1(-1)	1.09	1.65	6.9(-1)	6.71(-1)	1.34	9.7(-1)	4.40(-1)	1.16	3.5	1.96(-2)	6.49(-1)
4.2(-1)	1.07	1.63	7.0(-1)	6.61(-1)	1.33	9.8(-1)	4.33(-1)	1.15	3.6	1.75(-2)	6.40(-1)
4.3(-1)	1.05	1.62	7.1(-1)	6.50(-1)	1.32	9.9(-1)	4.27(-1)	1.15	3.7	1.56(-2)	6.32(-1)
4.4(-1)	1.03	1.60	7.2(-1)	6.40(-1)	1.31	1.0	4.21(-1)	1.14	3.8	1.40(-2)	6.24(-1)
4.5(-1)	1.01	1.59	7.3(-1)	6.30(-1)	1.31	1.1	3.66(-1)	1.10	3.9	1.25(-2)	6.17(-1)
4.6(-1)	9.94(-1)	1.57	7.4(-1)	6.20(-1)	1.30	1.2	3.19(-1)	1.06	4.0	1.12(-2)	6.09(-1)
4.7(-1)	9.76(-1)	1.56	7.5(-1)	6.11(-1)	1.29	1.3	2.78(-1)	1.02	4.1	9.98(-3)	6.02(-1)
4.8(-1)	9.58(-1)	1.55	7.6(-1)	6.01(-1)	1.29	1.4	2.44(-1)	9.88(-1)	4.2	8.93(-3)	5.95(-1)
4.9(-1)	9.41(-1)	1.54	7.7(-1)	5.92(-1)	1.28	1.5	2.14(-1)	9.58(-1)	4.3	7.99(-3)	5.89(-1)
5.0(-1)	9.24(-1)	1.52	7.8(-1)	5.83(-1)	1.27	1.6	1.88(-1)	9.31(-1)	4.4	7.15(-3)	5.82(-1)
5.1(-1)	9.08(-1)	1.51	7.9(-1)	5.74(-1)	1.26	1.7	1.65(-1)	9.06(-1)	4.5	6.40(-3)	5.76(-1)
5.2(-1)	8.92(-1)	1.50	8.0(-1)	5.65(-1)	1.26	1.8	1.46(-1)	8.83(-1)	4.6	5.73(-3)	5.70(-1)
5.3(-1)	8.77(-1)	1.49	8.1(-1)	5.57(-1)	1.25	1.9	1.29(-1)	8.61(-1)	4.7	5.13(-3)	5.64(-1)
5.4(-1)	8.61(-1)	1.48	8.2(-1)	5.48(-1)	1.25	2.0	1.14(-1)	8.42(-1)	4.8	4.60(-3)	5.59(-1)
5.5(-1)	8.47(-1)	1.47	8.3(-1)	5.40(-1)	1.24	2.1	1.01(-1)	8.25(-1)	4.9	4.12(-3)	5.53(-1)
5.6(-1)	8.32(-1)	1.46	8.4(-1)	5.32(-1)	1.23	2.2	8.93(-2)	8.06(-1)	5.0	3.69(-3)	5.48(-1)
5.7(-1)	8.18(-1)	1.45	8.5(-1)	5.24(-1)	1.23	2.3	7.91(-2)	7.89(-1)			
5.8(-1)	8.04(-1)	1.44	8.6(-1)	5.16(-1)	1.22	2.4	7.02(-2)	7.74(-1)			
5.9(-1)	7.91(-1)	1.43	8.7(-1)	5.09(-1)	1.21	2.5	6.23(-2)	7.60(-1)			

Note: 3.7(-2) means 3.7×10^{-2} or 0.037

Example: $r/L = 5.0(-1) = 5 \times 10^{-1} = 0.5$ $K_0(0.5) = 0.924$ $e^{0.5}K_0(0.5) = 1.52$

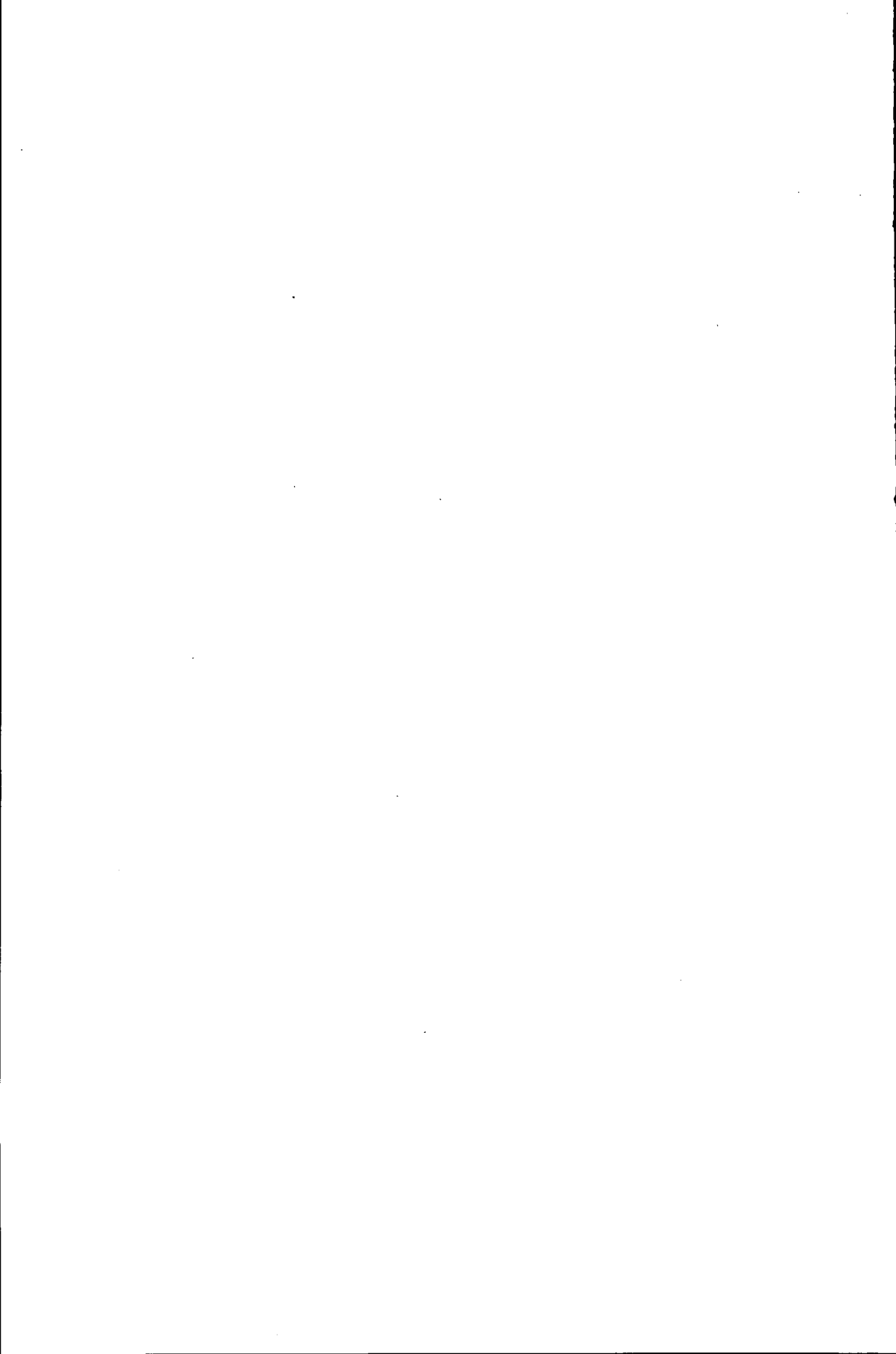

11 Water in the Unsaturated Zone

P. Kabat¹ and J. Beekma²

11.1 Introduction

In the soil below the watertable, all the pores are generally filled with water and this region is called the saturated zone. When, in a waterlogged soil, the watertable is lowered by drainage, the upper part of the soil will become unsaturated, which means that its pores contain both water and air. Water in the unsaturated zone generally originates from infiltrated precipitation and from the capillary rise of groundwater.

The process of water movement in the unsaturated part of the soil profile plays a central role in studies of irrigation, drainage, evaporation from the soil, water uptake by roots, and the transport of salts and fertilizers. The unsaturated zone is of fundamental importance for plant growth. Soil-water conditions in the upper part of the soil profile have a distinct influence on the accessibility, trafficability, and workability of fields.

A knowledge of the physical processes in the unsaturated zone is essential for a proper estimate of drainage criteria and for evaluating the sustainability of drainage systems. This chapter introduces some basic soil physics concerning the movement of water in unsaturated soil, and gives some examples of their use in drainage studies. Several methods of measuring soil-water status and soil hydraulic parameters are dealt with in Sections 11.2 and 11.3.

Basic relations and parameters governing water flow in the unsaturated zone are explained in Sections 11.4 and 11.5. This is followed by a discussion of the extraction of water through plant roots (Section 11.6). Section 11.7 treats the preferential flow of water through unsaturated soil.

The steady-state approach is illustrated with the help of a computer program; the unsteady-state flow is highlighted with a numerical simulation model (Section 11.8). The model combines unsaturated-zone dynamics with the characteristics of a drainage system. This enables us to evaluate the effects of a drainage system on soil-water conditions for crop production and on solute transport through the soil.

11.2 Measuring Soil-Water Content

The main constituents of soil are solid particles, water, and air. They can be expressed as a fraction or as a percentage. Basic formulas for soil water content on a volume basis and on a mass basis were given in Chapter 3 (Equations 3.1 to 3.9). In practice, one often expresses soil-water content over a depth of soil directly in mm of water. Thus, $\theta = 0.10$ means that 10 mm of water is stored in a 100 mm soil column ($0.10 \times 100 = 10$). Soil-water content can be measured either with destructive methods or with non-destructive methods. An advantage of non-destructive measurements is

¹ The Winand Staring Centre for Integrated Land, Soil and Water Research

² International Institute for Land Reclamation and Improvement

that repetitive measurements can be taken at the same location. This advantage becomes most pronounced when we combine it with automatic data recording.

The gravimetric method, which leads to a soil-water content on the basis of weight or volume, is the most widely used destructive technique.

Non-destructive techniques that have proved to be applicable under field conditions are:

- Neutron scattering;
- Gamma-ray attenuation;
- Capacitance method;
- Time-domain reflectometry.

Gravimetric Method

A soil sample is weighed, then dried in an oven at 105°C, and weighed again. The difference in weight is a measure of the initial water content.

Samples can be taken on a mass or on a volume basis. In the first case, we take a disturbed quantity of soil, put it in a plastic bag, and transport it to the laboratory, where it is weighed, dried, and re-weighed after drying. We calculate the mass fraction of water with

$$w = \frac{m_w}{m_s} \quad (11.1)$$

where

- w = fraction of water on mass base (kg.kg⁻¹)
- m_w = mass of water in the soil sample (kg)
- m_s = mass of solids in the soil sample (oven dry soil) (kg)

To get the soil-water content on a volume basis, we need samples of known volume. We normally use stainless steel cylinders (usually 100 cm³), which are pushed horizontally or vertically into profile horizons. We subsequently retrieve and trim the filled cylinder, and put end caps on. Soil horizons are exposed in a soil pit. If no pit can be dug, we can use a special type of auger in which the same type of cylinder is fixed. The volume fraction of water can be calculated as

$$\theta = \frac{V_w}{V} = \frac{m_w}{\rho_w V} \quad (11.2)$$

where

- θ = volumetric soil-water content (m³.m⁻³)
- V = volume of cylinder (m³)
- ρ_w = density of water (kg/m³); often taken as 1000 kg/m³
- V_w = volume of water (m³)

Simultaneously, the dry bulk density is obtained through (Equation 3.5)

$$\rho_b = \frac{m_s}{V} \quad (11.3)$$

where

- ρ_b = the dry bulk density (kg/m³)

We can convert the soil-water content on mass base (w) to a volumetric soil-water content (θ)

$$\theta = \frac{\rho_b}{\rho_w} w \quad (11.4)$$

The gravimetric method is still the most widely used technique to determine the soil-water content and is often taken as a standard for the calibration of other methods. A disadvantage is that it is laborious, because samples in duplicate or in triplicate are required to compensate for errors and variability. Moreover, volumetric samples need to be taken carefully. The samples cannot usually be weighed in the field, and special care must be taken to prevent them from drying out before they are weighed in the laboratory.

Neutron-Scattering

The neutron-scattering method is based on fast-moving neutrons emitted by a radioactive source, usually ^{241}Am , which collide with nuclei in the soil and lose energy. A detector counts part of the slowed-down reflected (thermal) neutrons. Because hydrogen slows down neutrons much more than other soil constituents, and since hydrogen is mainly present in water, the neutron count is strongly related to the water content. We use an empirical linear relationship between the ratio of the count to a standard count of the instrument, which is called the count ratio, and the soil-water content. The standard count is taken under standard conditions, preferably in a pure water body. The empirical relationship reads

$$\theta = a + bR \quad (11.5)$$

where

- R = the count ratio (-)
- a and b = soil specific constants (-)

Because, apart from hydrogen, the count ratio is also influenced by the bulk density of the soil and by various chemical components, a soil specific calibration is required. Constant a in Equation 11.5 increases with bulk density; constant b is influenced by soil chemical composition (Gardner 1986). The calibration can be done by regression of the soil-water content of samples taken around the measurement site, on the count ratio. Calibration can also be done in a drum in the laboratory, but this is more cumbersome, since one needs to create soil conditions comparable to those in the field.

For field measurements, portable equipment has been developed. The most frequently used equipment consists of a probe unit and a scaler (Figure 11.1). The probe, containing a neutron source, is lowered into a tube, called an access tube, in the soil down to the required depth. A proportion of the reflected slow neutrons is absorbed in a boron-trifluoride gas-filled tube (counter). Ionization of the gas results in discharge pulses, which are amplified and measured with the scaler. The action radius of the instrument is spherical and its size varies with soil wetness; the drier the soil, the larger the action radius (between approximately 15 cm in wet soil to 50 cm in dry soil).

For a comparison of measurements from different locations, the size, shape, and material of the access tubes must be identical. Aluminium is a frequently used material

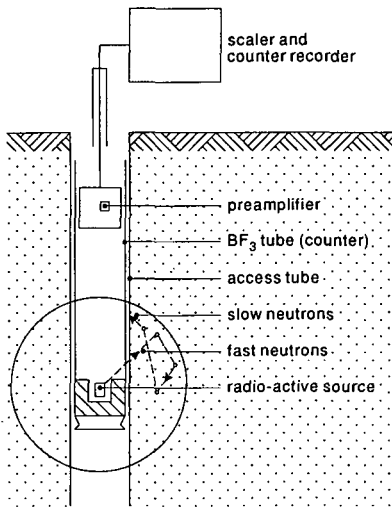

Figure 11.1 Neutron probe to measure soil-water content

because it offers practically no resistance to slow neutrons; polyvinyl chloride (PVC), polythene, brass, and stainless steel show a lower neutron transmission. For more details, see Gardner (1986).

The neutron-scattering technique has been widely used under field conditions. Advantages of the method are:

- Soil-water content can be measured rapidly and repeatedly in the same place;
- Average soil-water content of the sphere of influence can be measured with depth;
- Temporal soil-water content changes can easily be followed;
- Relation between count ratio and soil-water content is linear.

Disadvantages are:

- Counts have a high variability; measurements are not completely repeatable;
- Poor depth resolution;
- Measurements are interfered with by many soil constituents;
- The use of a radioactive source can pose health risks if no appropriate care is taken and create disposal problems after use;
- Measurements near the soil surface are impossible.

Gamma-Ray Attenuation

With the gamma ray method, we can measure the soil's wet bulk density (see Chapter 3). If the dry bulk density does not change over the period considered, changes in wet bulk density are only due to changes in soil-water content. If a beam of gamma rays emitted by a Cesium¹³⁷ source is transmitted through the soil, they are attenuated (reduced in intensity), the degree of attenuation increasing with wet bulk density (Bertuzzi et al. 1987).

The field method (Figure 11.2) requires two access tubes, one for the source and one for the detector. These access tubes must be injected precisely parallel and vertical, because the gamma method is highly susceptible to deviations in distance. Sometimes two gamma-ray sources with different energies are used. With such a dual-source

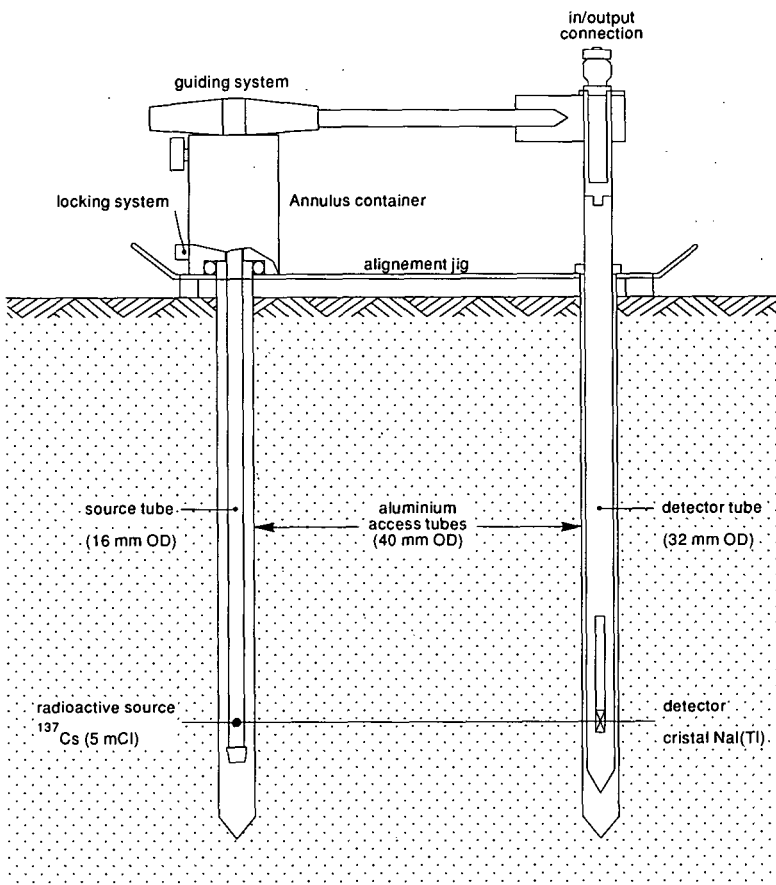

Figure 11.2 The gamma-ray probe (after Bertuzzi et al. 1987)

method (Gurr and Jakobsen 1978), dry bulk density and water content are obtained separately. The method is especially suitable for swelling soils. The calibration procedure depends on the type of instrument. For details, see Gurr and Jakobsen (1978) and Gardner (1986).

The method is less widely applied than the neutron-scattering method, and is mostly used to follow soil-water content in soil columns in the laboratory. The advantage of the method is that the data on soil-water content can be obtained with good depth resolution.

Disadvantages are:

- Field instrumentation is costly and difficult to use;
- Extreme care must be taken to ensure that the radioactive source is not a health hazard.

Capacitance Method

The capacitance method is based on measuring the capacitance of a capacitor, with the soil-water-air mixture as the dielectric medium. The method has been described

by, among others, Dean et al. (1987). Its application and accuracy under field conditions was investigated by Halbertsma et al. (1987).

A probe with conductive plates or rods surrounded with soil constitutes the capacitor. The relative permittivity (dielectric constant) of water is large compared with that of the soil matrix and air. A change in the water content of the soil will cause a change in the relative permittivity, and consequently in the capacitance of the capacitor (probe) surrounded with soil. The capacitor is usually part of a resonance circuit of an oscillator. Changes in the soil-water content, and thus changes in the capacitor capacitance, will change the resonance frequency of the oscillator. In this way, the water content is indicated by a frequency shift. Since the relative permittivity of the soil matrix depends on its composition and its bulk density, calibration is needed for each separate soil.

The field instrument consists of a read-out unit and either a mobile probe to be able to measure in different access tubes or fixed probes (Hilhorst 1984) installed at different depths within the soil profile (Figure 11.3).

The capacitance method has been used with good results in several studies. Generally, the accuracy of determining the soil-water content was reported to be in the range of ± 0.02 ($\text{m}^3 \cdot \text{m}^{-3}$) (Halbertsma et al. 1987). This accuracy is limited by the calibration, rather than by the instrument or by the measurement technique itself. The capacitive instrument can be combined with an automatic data recording system. Such a system can collect soil-water data more or less continuously.

The advantages of the method are comparable to those of the neutron-scattering method. Additional advantages are:

- Good depth resolution;
- Very fast response;

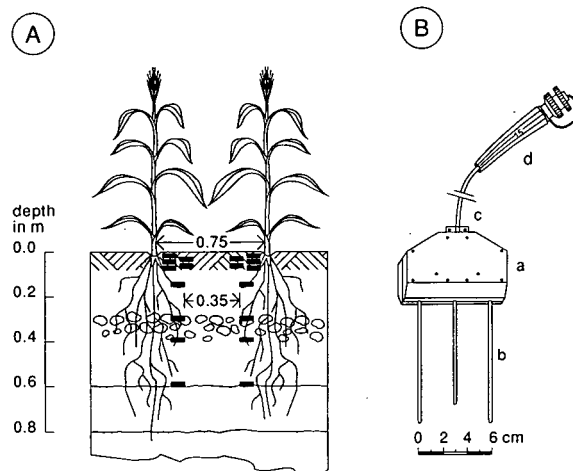

Figure 11.3 An example of the installation of the capacitance probes in a soil profile and a schematic illustration of the capacitance probe (after Halbertsma et al. 1987)

- A. The probes are placed in two columns in between two rows of a crop at different depths ranging between 2 and 60 cm.
- B. The capacitance probe consists of (a) a holder, (b) three electrodes, (c) a cable, and (d) a connector.

- Little diversion of measured frequency for repeated measurements;
- Different portable versions are available for field use;
- The instrument is inherently safe;
- It can be combined with an automated data-recording system;
- Surface soil-water content can be measured.

Disadvantages are:

- Relationship between frequency shift and soil-water content is non-linear;
- The method is sensitive to electrical conductivity of the soil;
- The installation of access tube or probe has to be done with care; small cavities around the tube have a great influence on the measured frequency.

Time-Domain Reflectometry

A method that also uses the dielectrical properties of the soil is time-domain reflectometry (TDR). The propagation time of a pulse travelling along a wave guide is measured. This time depends on the dielectrical properties of the soil surrounding the wave guide, and hence on the water content of the soil. The TDR method can be used for many soils without calibration, because the relationship between the apparent dielectric constant and volumetric water content is only weakly dependent on soil type, soil density, soil temperature, and salt content (Topp and Davis 1985). Topp et al. (1980) reported a measured volumetric water content with an accuracy of ± 0.02 ($\text{m}^3 \cdot \text{m}^{-3}$).

Time-domain reflectometry has become popular in recent years, mainly because the method does not need elaborate calibration procedures. Several portable, battery-powered TDR units are available at this moment. Electrodes to be used as the actual measuring device are available in different configurations. The full potential of this method is only realized when it is combined with an automatic data acquisition system (e.g. Heimovaraa and Bouten 1990).

The advantages of TDR are comparable to those of the capacitance method. Additional advantages are:

- Highly accurate soil-water content measurements at desired depths;
- Availability of electrodes with required ranges of influence;
- No calibration required for different soil types.

Disadvantages are:

- Expensive electrodes and data-recording systems, resulting in high costs if an extensive spatial coverage is desired;
- Electrodes difficult to install in stony and heavily compacted soils.

11.3 Basic Concepts of Soil-Water Dynamics

To describe the condition of water in soil, mechanical and thermo-dynamic (or energy) concepts are used. In the mechanical concept, only the mechanical forces moving water through the soil are considered. It is based on the idea that, at a specific point, water in unsaturated soil is under a pressure deficit as compared with free water.

In the energy concept, other driving forces are considered in addition to mechanical forces. These forces are caused by thermal, electrical, or solute-concentration gradients.

11.3.1 Mechanical Concept

The mechanical concept can be illustrated by regarding the soil as a mixture of solids and pores in which the pores form capillary tubes. If such a small capillary tube is inserted in water, the water will rise into the tube under the influence of capillary forces (Figure 11.4).

The total upward force lifting the water column, $F\uparrow$, is obtained by multiplying the vertical component of surface tension by the circumference of the capillary

$$F\uparrow = \sigma \cos \alpha \times 2\pi r \quad (11.6)$$

where

$F\uparrow$ = upward force (N)

σ = surface tension of water against air ($\sigma = 0.073 \text{ kg}\cdot\text{s}^{-2}$ at 20°C)

α = contact angle of water with the tube (rad); ($\cos \alpha \approx 1$)

r = equivalent radius of tube (m)

By its weight in the gravitational field, the water column of length h and mass $\pi r^2 h \rho$ exerts a downward force $F\downarrow$ that opposes capillary rise

$$F\downarrow = \pi r^2 h \rho \times g \quad (11.7)$$

where

$F\downarrow$ = downward force (N)

ρ = density of water ($\rho = 1000 \text{ kg}/\text{m}^3$)

g = acceleration due to gravity ($g = 9.81 \text{ m}/\text{s}^2$)

h = height of capillary rise (m)

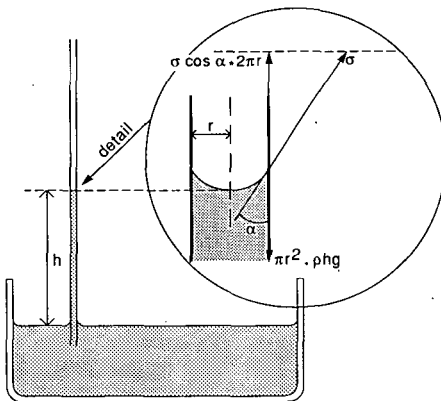

Figure 11.4 Capillary rise of water

At equilibrium, the upward force $F\uparrow$ equals the downward force $F\downarrow$ and water movement stops. In that case

$$\sigma \cos \alpha \times 2\pi r = \pi r^2 h \rho \times g$$

or

$$h = \frac{2\sigma \cos \alpha}{\rho g r} \quad (11.8)$$

Substituting the values of the various constants leads to the expression for the height of capillary rise

$$h = \frac{0.15}{r} \quad (11.9)$$

Thus the smaller the tube, the higher the height of capillary rise.

11.3.2 Energy Concept

Real soils do not consist of capillaries with a characteristic diameter. Water movement in soil, apart from differences in tension, is also caused by thermal, electrical, or solute-concentration gradients. The forces governing soil-water flow can accordingly be described by the energy concept. According to this principle, water moves from points with higher energy status to points with lower energy status. The energy status of water is simply called 'water potential'. The relationship between the mechanical-force concept and the energy-water-potential concept is best illustrated for a situation in which the distance between two points approximates zero. The forces acting on a mass of water in any particular direction are then defined as

$$\frac{F_s}{m} = - \frac{\partial \psi}{\partial s} \quad (11.10)$$

where

F_s = total of forces (N)

m = mass of water (kg)

s = distance between points (m)

ψ = water potential on mass base (J/kg)

The negative sign shows that the force works in the direction of decreasing water potential.

The water potential is an expression for the mechanical work required to transfer a unit quantity of water from a standard reference, where the potential is taken as zero, to the situation where the potential has the defined value.

Potentials are usually defined relative to water with a composition identical to the soil solution, at atmospheric pressure, a temperature of 293 K (20°C), and datum elevation zero.

Total water potential, ψ_t , is the sum of several components (Feddes et al. 1988)

$$\psi_t = \psi_m + \psi_{ex} + \psi_{en} + \psi_s + \psi_g + \dots \quad (11.11)$$

where

ψ_t = total water potential

ψ_m = matrix potential, arising from local interactions between the soil matrix and water

ψ_{ex} = excess gas potential, arising from the external gas pressure

ψ_{en} = envelope or overburden potential, arising from swelling of the soil

ψ_s = osmotic potential, arising from the presence of solutes in the soil water

ψ_g = gravitational potential, arising from the gravitational force

In soil physics, water potential can be expressed as energy on a mass basis (ψ^m), on a volume basis (ψ^v), or on a weight basis (ψ^w). As an example, let us take the gravitational potential, ψ_g , with the watertable as reference level. The definition of potential says that the mechanical work required to raise a mass of water ($m = \rho V$) from the watertable to a height z is equal to mgz or ρVgz . Thus the gravitational potential on mass basis (ψ_g^m), on volume basis (ψ_g^v), or on weight basis (ψ_g^w) will be

$$\psi_g^m = \frac{\rho Vgz}{\rho V} = gz \quad (\text{J/kg}) \quad (11.12)$$

$$\psi_g^v = \frac{\rho Vgz}{V} = \rho gz \quad (\text{Pa}) \quad (11.13)$$

$$\psi_g^w = \frac{\rho Vgz}{\rho Vg} = z \quad (\text{M}) \quad (11.14)$$

We can do the same for other potentials. The general relationship of potentials based on mass (ψ^m), on volume (ψ^v), and on weight (ψ^w) is

$$\psi^m : \psi^v : \psi^w = g : \rho g : 1 \quad (11.15)$$

This means that the values of ψ^m are a factor 9.8 higher than corresponding values of ψ^w ; values of ψ^v are a factor 9800 higher (for ρ water = 10^3 kg/m³), for which reason we often use kPa as a unit of ψ^v instead of Pa.

In hydrology, one prefers to use the potential on a weight basis, and potentials are referred to as 'heads'. In the following, we shall restrict ourselves to water potentials based on weight. In analogy to Equation 11.11, we can write

$$h_t = h_m + h_{ex} + h_{en} + h_s + h_g + \dots \quad (11.16)$$

with the potentials now called 'heads' and the subscripts having the same meaning as in Equation 11.11:

- The matric head (h_m) in unsaturated soil is negative, because work is needed to withdraw water against the soil-matric forces. At the groundwater level, atmospheric pressure exists and therefore $h_m = 0$;
- Changes in total water head in the soil may also be caused by changes in the pressure of the air adjacent to it. In natural soils, however, such changes are fairly exceptional, so we can assume that $h_{ex} = 0$;
- A clay soil that takes up water and swells will exert an additional pressure, h_{en} , on the total water head. In soils with a rigid matrix (non-swelling soils), $h_{en} = 0$;

- In soil-water studies, we can very often neglect the influence of the osmotic head, h_s . This is justified as far as we measure the head values relative to groundwater with the same or nearly the same chemical composition as the soil water; thus $h_s \approx 0$. Where considerable differences in solute concentration in the soil profile exist, it is obviously necessary to take h_s into account;
- The gravitational head, h_g , is determined at each point by the elevation of that point relative to a certain reference level. Equation 11.14 shows that $h_g = z$, with z positive above the reference level and negative below it.

The sum of the components h_m , h_{ex} , and h_{en} is usually referred to as soil water pressure head, h , which can be measured with a tensiometer

$$h = h_m + h_{ex} + h_{en} \quad (11.17)$$

If we assume that h_{ex} and h_{en} are zero, as mentioned earlier, we can write

$$h_t = h_m + h_s + h_g \quad (11.18)$$

Taking $h_s = 0$, $h_g = z$ and denoting h_t as H , we can also write

$$H = h_m + z \quad (11.19)$$

where

H = hydraulic head (m)

z = elevation head or gravitational head (m)

According to Equation 11.10, differences in head determine the direction and the magnitude of soil-water flow. When the soil water is in equilibrium, $-\partial H/\partial z = 0$, and there is no flow. Such a situation is shown in Figure 11.5, where the watertable

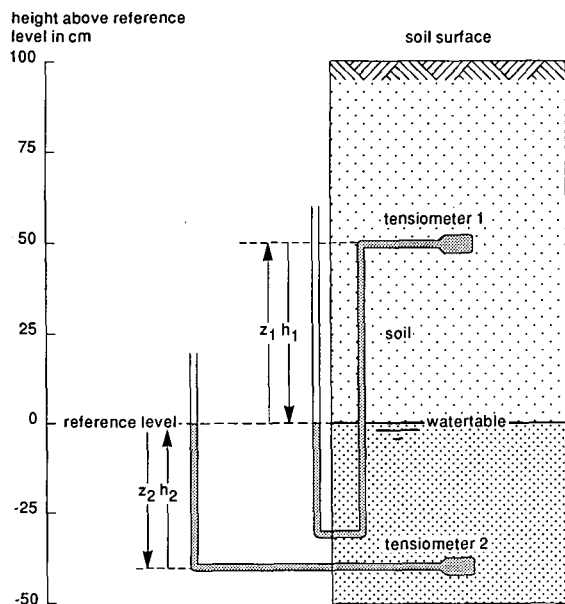

Figure 11.5 Equilibrium (no-flow) conditions in a soil profile with a watertable depth of 1.0 m

is at 1.00 m depth, and the reference level is taken at this depth. The pressure head in the soil is measured with tensiometers. (For details on the functioning of tensiometers, see Section 11.3.3.). Tensiometer 1 is installed at 50 cm depth, and Tensiometer 2 at 140 cm depth.

The pressure head at the watertable is, by definition, $h = p/\rho g = 0$, because the water there is in equilibrium with atmospheric pressure. Above the watertable, $h < 0$; below it $h > 0$ ('hydrostatic pressure').

For Tensiometer 1, the pressure head is represented by the height of the open end of the water column, $h_1 = -50$ cm, and gravitational head by the height above reference level, $z_1 = 50$ cm. Thus

$$H_1 = h_1 + z_1 = -50 + 50 = 0 \text{ cm}$$

In the same way, for Tensiometer 2, we find

$$h_2 = 40 \text{ cm and } z_2 = -40 \text{ cm, thus } H_2 = +40 - 40 = 0$$

Hence, everywhere in the soil column, $H = 0$ cm and equilibrium exists and no water flow takes place. The distribution of the pressure head and the gravitational head in a profile under equilibrium conditions is shown in Figure 11.6.

11.3.3 Measuring Soil-Water Pressure Head

Techniques to measure soil-water pressure head, h , or the matric head, h_m , are usually restricted to a particular range of the head. We can use the following techniques:

- 1) Tensiometry for relatively wet conditions ($-800 \text{ cm} < h < 0 \text{ cm}$);

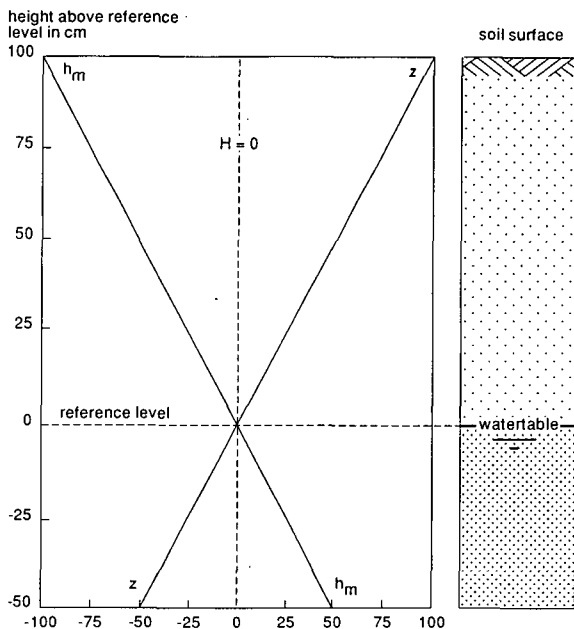

Figure 11.6 Distribution of the soil-water pressure heads with depths under equilibrium conditions

- 2) Electrical resistance blocks for the range of $-10\ 000\text{ cm} < h < -20\text{ cm}$;
- 3) Soil psychrometry for dry conditions ($h < -2000\text{ cm}$);
- 4) Thermal conductivity techniques ($-3000\text{ cm} < h < -100\text{ cm}$);
- 5) Techniques based on dielectrical properties ($-15000\text{ cm} < h < -10\text{ cm}$).

For practical field use, Techniques 3), 4), and 5) are not yet fully operational. The soil-psychrometry method (Bruckler and Gaudu 1984) is difficult to perform since we need to achieve a thermal equilibrium between the sensor and the surrounding soil. Thermal-conductivity-based techniques (Phene et al. 1987) and the dielectrical method (Hilhorst 1986) are promising, but are not yet operational. In field practice, tensiometry and, to a lesser extent, electrical resistance blocks are mainly used.

Tensiometry

A tensiometer consists of a ceramic porous cup positioned in the soil. This cup is attached to a water-filled tube, which is connected to a measuring device. As long as there is a pressure-head gradient between the water in the cup and the water in the soil, water will flow through the cup wall. Under equilibrium conditions, the pressure head of the soil water is obtained from the water pressure inside the tensiometer. As the porous cup of the tensiometer allows air to enter the system for $h < -800\text{ cm}$, direct measurements of the pressure head in the field are only possible from 0 to -800 cm .

The principle of tensiometry can be seen in Figure 11.5. The soil profile is in hydrological equilibrium here, which means that at any place in the profile the pressure head (h) is equal to the reversal of the gravitational head (see also Figure 11.6), i.e. $h = -z$.

At measurement position 1 (tensiometer – cup 1), a suction ($-h_1$) draws the water in the tensiometer to the position where this suction is fully counteracted by the gravitational head, z_1 . Hence, $h_1 + z_1 = 0$ and the measured pressure head has a negative value equal to $-z_1$. The pressure head is always negative in the unsaturated zone, which makes water tensiometers as in Figure 11.5 impractical. When the conditions are not in equilibrium and if, say, h were lower than $-z$, a pit would have to be dug to read pressure head h .

Commonly used tensiometers are illustrated in Figure 11.7. They are:

- Vacuum gauge (Type A);
- Mercury-water-filled tubes (Types B and C). For Type B, we see that $h = d_w - (\rho_m/\rho_w)d_m$. With the densities of mercury, $\rho_m = 13\ 600\text{ kg/m}^3$, and water, $\rho_w = 1000\text{ kg/m}^3$, it follows that $h = d_w - 13.6\ d_m$. For Type C, we see that $h = d_w - (\rho_m/\rho_w)d_m$ and $d_w = d_o + d_m$, so that $h = d_o + d_m(1 - \rho_m/\rho_w) \approx d_o - 12.6\ d_m$;
- Electronic transducers (Type D); they convert changes in pressure into small electrical forces, which are first amplified and then measured with a voltmeter.

We often use absolute values of the pressure head, $|h|$, which, in daily practice, are called 'tensions' or 'suctions' of the soil. A tension and a suction thus always have a positive value.

The setting-up time, or response time, of a tensiometer, defined as the time needed to reach equilibrium after a change in hydraulic head, is determined by the hydraulic

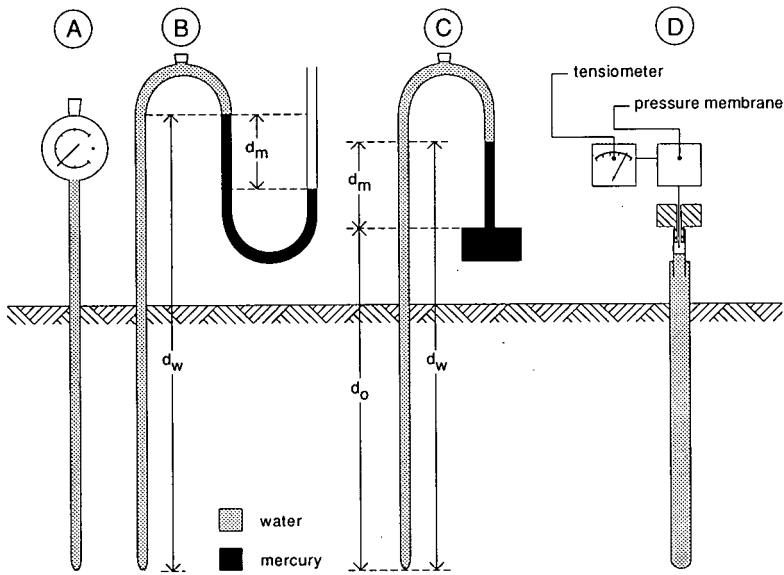

Figure 11.7 Tensiometers

conductivity of the soil, the properties of the porous cup, and, in particular, by the water capacity of the tensiometer system. The water capacity is related to the amount of water that must be moved in order to create a head difference of 1 cm. The setting-up time of tensiometers with a mercury manometer or Bourdon manometer ranges from about 15 minutes in permeable wet soil to several hours in less permeable, drier soils. Rapid variations in pressure head cannot be followed by a tensiometer. Shorter setting-up times can be obtained with manometers of small capacity. This requirement can be met with the use of electrical pressure transducers.

Good contact between the soil and the porous cup of a tensiometer is essential for the functioning of a tensiometer. The best way to place a tensiometer in the soil is to bore a hole with the same diameter as the porous cup to the desired depth and then to push the cup into the bottom of the hole. Usually, tensiometers are installed permanently at different depths. They can be connected by a distribution system of tubes and stopcocks to one single transducer. The tensiometers can then be measured one by one. Tensiometers have also been successfully combined with an automatic data-acquisition system (e.g. Van den Elsen and Bakker 1992).

Electrical Resistance Blocks

The principle of measuring soil-water suction with an electrical resistance block placed in the soil is based on the change in electrical resistance of the block due to a change in water content of the block. The blocks consist of two parallel electrodes, embedded in gypsum, nylon, fibreglass, or a combination of gypsum with nylon or fibreglass. The electrical resistance is dependent on the water content of the unit, the pressure head of which is in equilibrium with the pressure head of the surrounding soil. It can be measured by means of a Wheatstone bridge and should be calibrated against the pressure head measured in an alternative way.

Electrolytes in the soil solution will give reduced resistance readings. With gypsum blocks, however, this lowering of the resistance is counteracted by the saturated solution of the calcium sulphate in the blocks. Application is therefore possible in slightly saline soils.

Contact between resistance unit and soil is essential, which restricts its use to non-shrinking soils. In some sandy soils, where the pressure head changes very little with considerable change in soil-water content, measurements are inaccurate.

11.3.4 Soil-Water Retention

The previous sections showed that the pressure head of water in the unsaturated soil arises from local interactions between soil and water. When the pressure head of the soil water changes, the water content of the soil will also change. The graph representing the relationship between pressure head and water content is generally called the 'soil-water retention curve' or the 'soil-moisture characteristic'.

As was explained in Chapter 3, applying different pressure heads, step by step, and measuring the moisture content allows us to find a curve of pressure head, h , versus soil-water content, θ . The pressure heads vary from 0 cm (for saturation) to 10^7 cm (for oven-dry conditions). In analogy with pH, pF is the logarithm of the tension or suction in cm of water. Thus

$$pF = \log |h| \tag{11.20}$$

Figure 11.8 shows typical water retention curves of four standard soil types.

Saturation

The intersection point of the curves with the horizontal axis (tension: 1 cm water,

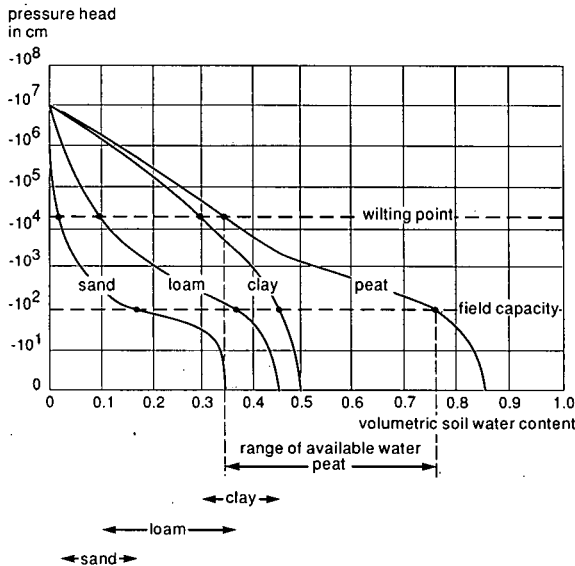

Figure 11.8 Soil-water retention curves for four different soil types, and their ranges of plant-available water

pF = 0) gives the water content of the soils under nearly saturated conditions, which means that this point almost indicates the fraction of total pore space or porosity, ϵ (Chapter 3).

Field Capacity

The term 'field capacity' corresponds to the conditions in a soil after two or three days of free drainage, following a period of thorough wetting by rainfall or irrigation. The downward flow becomes negligible under these conditions. For practical purposes, field capacity is often approximated by the soil-water content at a particular soil-water tension (e.g. at 100, 200, or 330 cm).

In literature, soil-water tensions at field capacity range from about 50 to 500 cm (pF = 0.7 – 2.7). In the following, we shall take $h = -100$ cm (pF 2.0) as the field-capacity point. It is regarded as the upper limit of the amount of water available for plants.

The air content at field capacity, called 'aeration porosity', is important for the diffusion of oxygen to the crop roots. Generally, if the aeration porosity amounts to 10 or 15 vol.% or more, aeration is satisfactory for plant growth.

Wilting Point

The 'wilting point' or 'permanent wilting point' is defined as the soil water condition at which the leaves undergo a permanent reduction in their water content (wilting) because of a deficient supply of soil water, a condition from which the leaves do not recover in an approximately saturated atmosphere overnight. The permanent wilting point is not a constant, because it is influenced by the plant characteristics and meteorological conditions.

The variation in soil-water pressure head at wilting point reported in literature ranges from -5000 to $-30\,000$ cm (Cassel and Nielsen 1986). In the following, we shall take $h = -15\,000$ (pF 4.2) as the permanent wilting point. For many soils, except for the more fine-textured ones, a change in soil-water content becomes negligible over the range -8000 cm to $-30\,000$ cm (Cassel and Nielsen 1986).

Oven-Dry Point

When soil is dried in an oven at 105°C for at least 12 hours, one assumes that no water is left in the soil. This point corresponds roughly with pF 7.

Available Water

The amount of water held by a soil between field capacity (pF 2.0) and wilting point (pF 4.2) is defined as the amount of water available for plants. Below the wilting point, water is too strongly bound to the soil particles. Above field capacity, water either drains from the soil without being intercepted by roots, or too wet conditions cause aeration problems in the rootzone, which restricts water uptake. The ease of water extraction by roots is not the same over the whole range of available water. At increasing desiccation of the soil, the water uptake decreases progressively. For optimum plant production, it is better not to allow the soil to dry out to the wilting point. The admissible pressure head at which soil water begins to limit plant growth varies between -400 and -1000 cm (pF 2.6 to pF 3). For most soils, the drought limit is reached when a fraction of 0.40 to 0.60 of the total amount of water available in

Table 11.1 The average amount of available water in the rootzone

Soil type	Total available
Coarse sand	2
Medium coarse sand	8
Medium fine sand	13
Fine sand	15
Loamy medium coarse sand	19
Loamy fine sand	12
Sandy loam	20
Loess loam	23
Fine sandy loam	34
Silt loam	37
Loam	32
Sandy clay loam	16
Silty clay loam	19
Clay loam	16
Light clay	14
Silty clay	21
Basin clay	20
Peat	50

the rootzone is used. This fraction is often referred to as 'readily available soil water'.

From Figure 11.8, it is obvious that the absolute amount of water available in the rootzone depends strongly on the soil type. Table 11.1 presents the average amounts of available water for a number of soils as derived from data in literature.

Hysteresis

We usually determine soil-water retention curves by removing water from an initially wet soil sample (desorption). If we add water to an initially dry sample (adsorption), the water content in the soil sample will be different at corresponding tensions. This phenomenon is referred to as 'hysteresis'. Due to the hysteresis effect, the water-content-tension relationship of a soil depends on its wetting or drying history. Under field conditions, this relationship is not constant. The effect of hysteresis on the soil-water retention curve is shown in Figure 11.9A.

The hysteresis effect may be attributed to:

- The pores having a larger diameter than their openings. This can be explained by Equation 11.9, which not only holds for capillary rise, but also for the soil-water tension, h , as related to the pore diameter. During wetting, the large pore will only take up water when the tension is in equilibrium with, or lower than, the tension related to its large diameter. During drying, the pore opening diameter determines the tension needed to withdraw the water from the pore. This tension should be higher than the tension calculated with Equation 11.9. The effect of this is illustrated in Figure 11.9B;
- Variations in packing due to a re-arrangement of soil particles by wetting or drying;

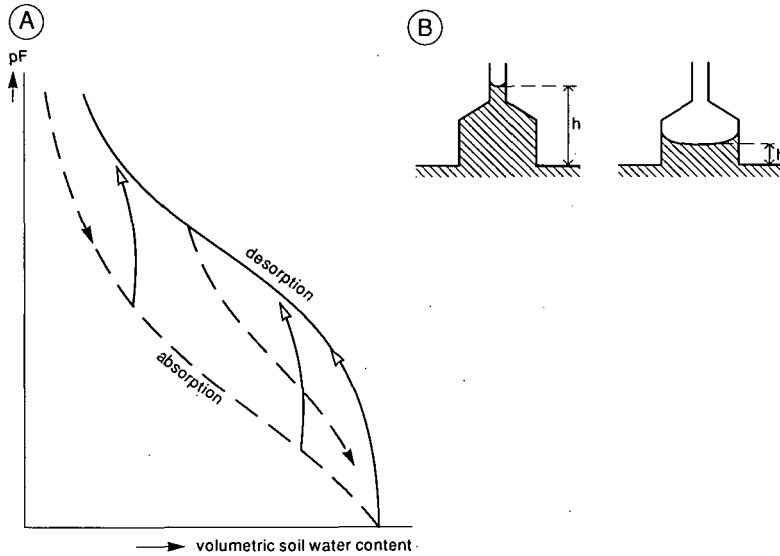

Figure 11.9 Hysteresis

A. In a family of pF-curves for a certain soil

B. Pore geometry as the phenomenon causing hysteresis

- Incomplete water uptake by soils that have undergone irreversible shrinking or drying (some clay and peat soils);
- Entrapped air.

Methods for Determining Soil-Water Retention

Soil hydraulic conductivity (Section 11.5) and soil-water retention are the most important characteristics in soil-water dynamics. Theoretically, if one were able to reproduce exactly the measurements on the same soil sample, and if natural soils were not spatially heterogeneous, each soil type would be characterized by one unique set of functions for soil-water retention and soil hydraulic conductivity.

Various methods have been developed to determine these characteristics, either in the laboratory or in situ. The methods can be divided into direct and indirect approaches (Kabat and Hack-ten Broeke 1989). The indirect approaches to estimate, both soil-water retention and hydraulic conductivity will be presented in Section 11.5.2. Below, only the basic principles of the direct measurements of soil-water retention will be discussed.

In-Situ Determinations

Section 11.2 presented a number of operational methods to measure the volumetric soil-water content, and Section 11.3.3 described techniques to measure the soil-water pressure head. If we combine both measurements for the same place and time (i.e. with equipment installed in the same soil profile), we obtain an in-situ relationship between measured pressure head and volumetric soil-water content.

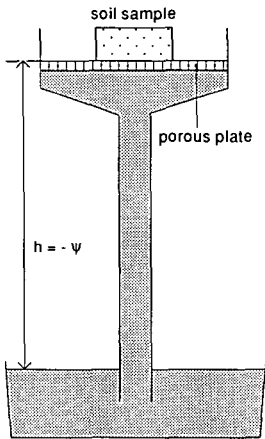

Figure 11.10 Measurement of the soil-water characteristic in the range of $150 < h < 0$ cm

Laboratory Methods

To determine the water retention of an undisturbed soil sample, the soil water content is measured for equilibrium conditions under a succession of known tensions $|h|$.

Porous-Medium Method

A soil sample cannot be exposed directly to suction because air will then enter and prevent the removal of water from the sample. A water-saturated porous material is therefore used as an intermediary. The porous medium should meet the following requirements:

- It must be possible to apply the required suction without reaching the air-bubbling pressure (air-entry value), the pressure at which bubbles of air start to leak through the medium;
- The water permeability of the medium has to be as high as possible, which is contradictory to the first requirement. This demands a homogeneous pore-size distribution, matching the applied pressure.

Tension Range 0 – 150 cm

Undisturbed volumetric soil samples are placed upon a porous medium that is water-saturated (Figure 11.10). A water column of a certain length is then used to exert the desired suction or tension on the soil sample, via the porous medium. As the pore-size distribution of the soil influences its water-retaining properties, undisturbed soil samples have to be used. This method is called the 'hanging water-column method'.

Tension Range 150 – 500 cm

A slightly different procedure is used in this range, instead of a hanging water column, suction is created by a vacuum line connected to ceramic plates. The same volumetric samples are placed on these plates and water is drained from the samples until equilibrium with the plates is reached. This method is called the 'suction plate method'.

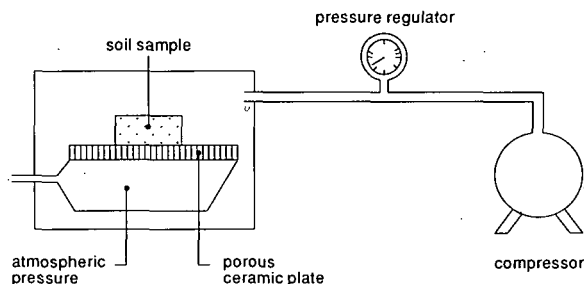

Figure 11.11 Measurement of the soil-water characteristic in the range of $15000 < h < -500$ cm

Tension Range 500 – 15 000 cm

In the range of 500 to 15 000 cm, instead of applying suctions, pressures are exerted on the soil sample, which is placed on a porous medium in a chamber (Figure 11.11). For pressures up to 3000 cm, undisturbed samples are normally used; for higher pressures, disturbed soil samples can be used. As porous medium, a ceramic plate or a cellophane membrane is used. Under the membrane, a shallow water layer under atmospheric pressure (zero gauge pressure) is present.

According to Equation 11.17, when h_{en} is assumed to be zero,

$$h = h_m + h_{ex}$$

Around the sample, the external imposed gas pressure is, say, 12 bar (i.e. equivalent to a head $h_{ex} = 12\,000$ cm). Water is discharged from the sample through the membrane into the water layer until equilibrium is reached. Then the pressure inside the soil sample is atmospheric, $h = 0$. Hence, it follows that,

$$0 = h_m + 12\,000$$

or

$$h_m = -12\,000 \text{ cm}$$

With this method, $h_m - \theta$ relationships can be determined over a large range of tensions. The method is referred to as the 'pressure pan method' for the lower range, when ceramic plates are used, and as the 'pressure membrane method' for higher pressures (Klute and Dinauer 1986).

In the very dry range, for $h < -30\,000$ cm ($pF > 4.5$), the 'vapour pressure method' can be applied. For details, see Campbell and Gee (1986).

11.3.5 Drainable Porosity

The 'storage coefficient', μ , also called 'drainable pore space', is important for unsteady drainage equations and for the calculation of groundwater recharge.

The storage coefficient is a constant that represents the average change in the water content of the soil profile when the watertable level changes with a discrete step. Its value depends on soil properties and the depth of the watertable. To derive a practical mean value of a storage coefficient for an area, it should be calculated for the major

soil series and for several depths of the watertable. If the water retention of the soil is known and if the pressure-head profile is known for two different watertable levels, the storage coefficient μ can be calculated from the following equation

$$\mu = \frac{\int_0^{z_2} \theta_2(z) dz - \int_0^{z_1} \theta_1(z) dz}{z_2 - z_1} \quad (11.21)$$

where

- z_1 = watertable depth for Situation 1 (m)
- z_2 = watertable depth for Situation 2 (m)
- $\theta_1(z)$ = soil-water content as a function of soil depth for Watertable 1 (-)
- $\theta_2(z)$ = soil-water content as a function of soil depth for Watertable 2 (-)

Usually, the drainable pore space is calculated for equilibrium conditions between soil-water content and watertable depth. The computer program CAPSEV (Section 11.4.2) offers the possibility of calculating the storage coefficient for different conditions with a shallow watertable. This could be useful information for the drainage of areas prone to high capillary rise.

In general, μ increases with increasing watertable depths. The capillary reach in which equilibrium conditions exist is only active where the soil surface is nearby and when soil water is occasionally removed by evaporation. For a depth greater than a certain critical value (which depends on the soil type), the drainable porosity can be approximated by the difference in θ between field capacity and saturation.

The concept of drainable porosity is shown in Figure 11.12A. In this figure, the soil-water content of a silty clay soil is shown by the line A-B for a watertable depth of 0.50 m, and by the line C-D for a watertable of 1.20 m. The drainable porosity in this case is represented by the enclosed area ABCD (representing the change in soil-water content), divided by the change in watertable depth AD or

$$\mu = \frac{ABCD}{AD} \quad (11.22)$$

Example 11.1

Assume that the soil-water profile of Figure 11.12 is in equilibrium (i.e. $H = 0$). Then, according to Equation 11.19, $h = -z$, with $z = 0$ at the watertable and positive upward. The pressure-head profile in this case is simply $-z$. Pressure-head profiles for the two watertable depths are illustrated in Figure 11.12B. The soil-water content can now be determined graphically for each depth from the soil-water retention curve in Figure 11.12C. The calculations are presented in Table 11.2.

We divide the soil profile in discrete depth intervals of 0.10 m, and calculate the average difference in θ between the first and the second watertable for each interval. This average is multiplied by the interval depth, which yields the water content per interval, totalling 28.05 mm. We divide the total by 700 mm (i.e. the change in watertable depth), and find a drainable porosity $\mu = 0.04$.

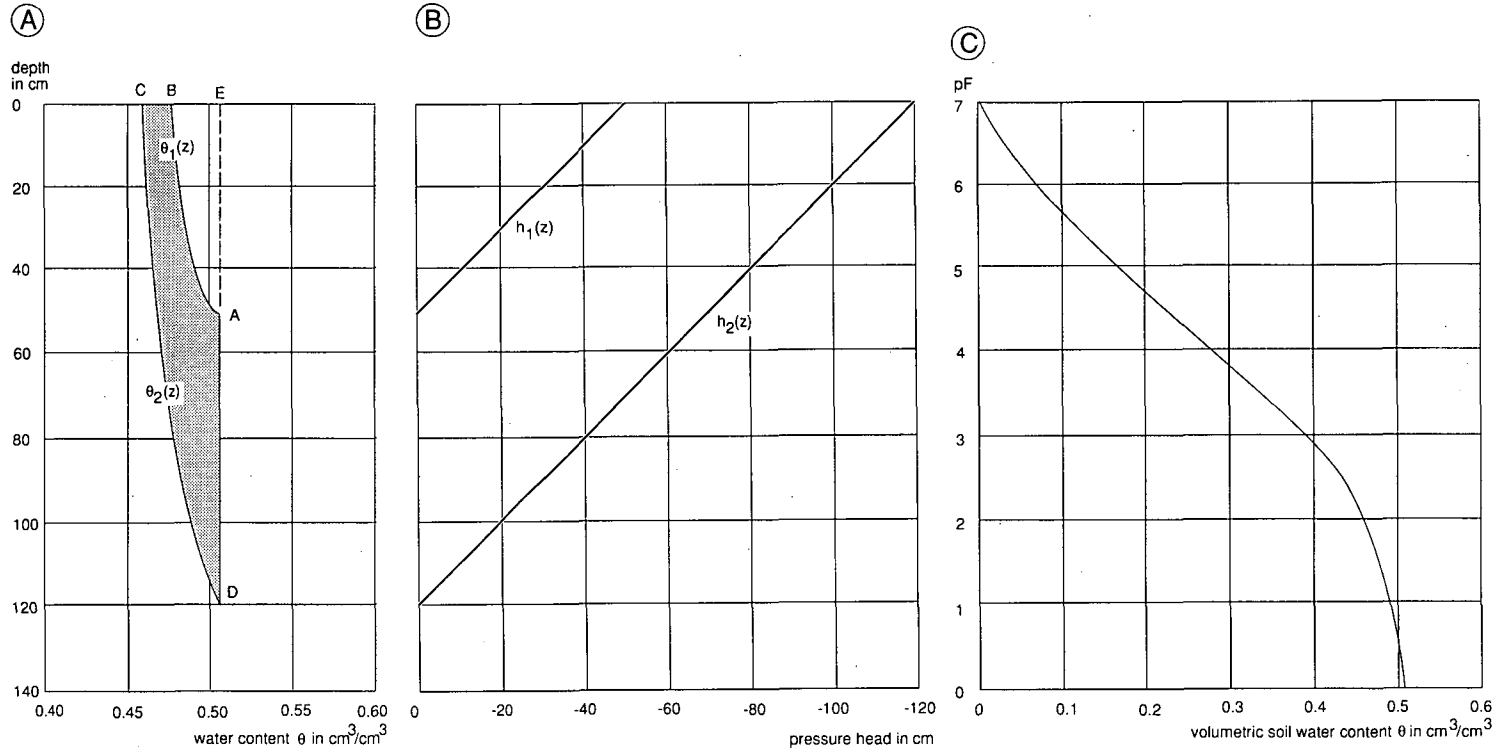

Figure 11.12 A. Soil-water-content profiles for equilibrium conditions with the watertable at 0.50 m, $\theta_1(z)$, and at 1.20 m, $\theta_2(z)$. The area enclosed by $\theta_1(z)$, $\theta_2(z)$, the soil surface, and AD represents the drainable porosity
 B. Equilibrium pressure-head profiles for watertables at 0.50 and 1.20 m
 C. Soil-water retention for a silty clay

Table 11.2 Calculation of the drainable porosity in a silty clay for a drop in watertable depth from 0.50 m to 1.20 m

Depth below soil surface, z (cm)	Height above watertable 1 $h_1 = -z$ (cm)	$pF =$ $\log(h_1)$	$\theta_1(z)$ (-)	Height above watertable 2 $h_2 = -z$ (cm)	$pF =$ $\log(h_2)$	$\theta_2(z)$ (-)	$\Delta\theta =$ $\theta_1 - \theta_2$ (-)	Average $\Delta\theta$ (-)	Average $\Delta\theta$ x100 (mm)
0	50	1.70	<u>0.476</u>	120	2.08	<u>0.459</u>	0.017		
10	40	1.60	0.479	110	2.04	0.461	0.018	0.0175	1.75
20	30	1.48	0.483	100	2.00	0.463	0.020	0.0190	1.90
30	20	1.30	0.847	90	1.95	0.466	0.021	0.0205	2.05
40	10	1.00	0.492	80	1.90	0.468	0.024	0.0225	2.25
50	0	$-\infty$	<u>0.507</u>	70	1.85	0.470	0.307	0.0305	3.05
60			0.507	60	1.78	0.473	0.034	0.0355	3.55
70			0.507	50	1.70	0.476	0.031	0.0325	3.25
80			0.507	40	1.60	0.479	0.028	0.0295	2.95
90			0.507	30	1.48	0.483	0.024	0.0260	2.60
100			0.507	20	1.30	0.487	0.020	0.0220	2.20
110			0.507	10	1.00	0.492	0.015	0.0175	1.75
120			0.507	0	$-\infty$	<u>0.507</u>	<u>0.000</u>	<u>0.0075</u>	<u>0.75</u>
						Total	0.289	0.2805	28.05

$$\mu = \frac{28.05}{700} = 0.04$$

11.4 Unsaturated Flow of Water

The flow of soil water is caused by differences in hydraulic head, as was explained in Chapter 7, where water flow in saturated soil (i.e. groundwater flow) was discussed. The following sections deal with the basic relationships that govern soil-water flow in the unsaturated zone, the most important properties that influence soil-water dynamics, and some methods of measuring those properties.

11.4.1 Basic Relationships

Kinetics of Flow: Darcy's Law

For the one-dimensional flow of water in both saturated and unsaturated soil, Darcy's Law applies, which can be written as

$$q = -K\nabla H \quad (11.23)$$

where

q = discharge per unit area or flux density (m/d)

K = hydraulic conductivity (m/d)

H = hydraulic head (m)

∇ = differential operator ($\nabla = \partial/\partial x + \partial/\partial y + \partial/\partial z$) (see also Chapter 7)

It was only in 1927 that Israelsen noticed that the equation for flow in unsaturated media presented by Buckingham in 1907 is equivalent to Darcy's Law, the only difference being that the hydraulic conductivity is dependent on the soil-water content, which we denote as $K(\theta)$. With the hydraulic head defined as in Equation 11.19, Darcy's Law for unsaturated soils may be written as

$$q_x = -K(\theta) \frac{\partial H}{\partial x} = -K(\theta) \frac{\partial h}{\partial x} \quad (11.24)$$

$$q_y = -K(\theta) \frac{\partial H}{\partial y} = -K(\theta) \frac{\partial h}{\partial y} \quad (11.25)$$

$$q_z = -K(\theta) \frac{\partial H}{\partial z} = -K(\theta) \frac{\partial h}{\partial z} \quad (11.26)$$

where q_x , q_y , and q_z are the components of soil-water flux in the x -, y - and z -directions.

Conservation of Mass: Continuity Equation

In Chapter 7 (Section 7.3.3), a general form of the continuity equation was derived for water flow independent of time, considering the mass balance of an elementary volume that could not gain or lose water. In unsaturated soil, however, a similar elementary volume can gain water at the expense of air. If we state that this happens at a rate $\partial\theta/\partial t$, we can write Equation 7.9 in the following form

$$\frac{\partial\theta}{\partial t} = -\frac{\partial q_x}{\partial x} - \frac{\partial q_y}{\partial y} - \frac{\partial q_z}{\partial z} = -\nabla \cdot \mathbf{q} \quad (11.27)$$

General Unsaturated-Flow Equation

The general equation of water flow in isotropic media (i.e. media for which the hydraulic conductivity is the same in every direction) is obtained by substituting Darcy's Law (Equations 11.24, 11.25, and 11.26) into the continuity equation (Equation 11.27), which yields

$$\frac{\partial\theta}{\partial t} = \frac{\partial}{\partial x} \left(K(\theta) \frac{\partial H}{\partial x} \right) + \frac{\partial}{\partial y} \left(K(\theta) \frac{\partial H}{\partial y} \right) + \frac{\partial}{\partial z} \left(K(\theta) \frac{\partial H}{\partial z} \right) \quad (11.28)$$

or

$$\frac{\partial\theta}{\partial t} = \nabla \cdot \mathbf{K}(\theta) \nabla H \quad (11.29)$$

For saturated flow, the water content does not change with time (ignoring the compressibility of water and soil), so that $\partial\theta/\partial t = 0$, and hence

$$\nabla \cdot \mathbf{K} \nabla H = 0 \quad (11.30)$$

If \mathbf{K} is constant in space, the Laplace Equation for steady-state saturated flow in a homogeneous, isotropic porous medium follows from Equation 11.30

$$\nabla^2 H = 0 \quad (11.31)$$

where

$$\nabla^2 = \text{Laplace Operator (see also Chapter 7, Section 7.6.5)}$$

Substituting $H = z + h$ into Equation 11.28 yields

$$\frac{\partial \theta}{\partial t} = \frac{\partial}{\partial x} \left(K(\theta) \frac{\partial h}{\partial x} \right) + \frac{\partial}{\partial y} \left(K(\theta) \frac{\partial h}{\partial y} \right) + \frac{\partial}{\partial z} \left(K(\theta) \frac{\partial h}{\partial z} \right) + \frac{\partial K(\theta)}{\partial z} \quad (11.32)$$

Since θ is related to h via the soil-water retention curve, we can also express $K(\theta)$ as $K(h)$ (see following section). Through the introduction of the specific water capacity, $C(h)$, Equation 11.32 may be converted into an equation with one dependent variable

$$\frac{\partial \theta}{\partial t} = \frac{d\theta}{dh} \frac{\partial h}{\partial t} = C(h) \frac{\partial h}{\partial t} \quad (11.33)$$

where

$C(h)$ = specific water capacity, equalling $d\theta/dh$ (i.e. the slope of soil-water retention curve) (m^{-1})

Replacing $K(\theta)$ by $K(h)$ and substituting Equation 11.33 into Equation 11.32 yields

$$C(h) \frac{\partial h}{\partial t} = \frac{\partial}{\partial x} \left(K(h) \frac{\partial h}{\partial x} \right) + \frac{\partial}{\partial y} \left(K(h) \frac{\partial h}{\partial y} \right) + \frac{\partial}{\partial z} \left(K(h) \frac{\partial h}{\partial z} \right) + \frac{\partial K(h)}{\partial z} \quad (11.34)$$

Equation 11.34 is known as Richards' Equation. With p/pg substituted for h , this equation applies to saturated as well as to unsaturated flow (hysteresis excluded). To solve Equation 11.34, we need to specify the hydraulic-conductivity relationship, $K(h)$, and the soil-water characteristic, $\theta(h)$. When we consider flow in a horizontal direction only (x), Equation 11.34 reduces to an equation for unsteady horizontal flow

$$\frac{\partial \theta}{\partial t} = \frac{\partial}{\partial x} \left[K(h) \frac{\partial h}{\partial x} \right] \quad (11.35)$$

Similarly, the equation for unsteady vertical flow is

$$\frac{\partial \theta}{\partial t} = \frac{\partial}{\partial z} \left[K(h) \left(\frac{\partial h}{\partial z} + 1 \right) \right] \quad (11.36)$$

For steady-state flow, $\frac{\partial \theta}{\partial t} = 0$ and h is only a function of z . Hence Equation 11.36 reduces to

$$\frac{d}{dz} \left[K(h) \left(\frac{dh}{dz} + 1 \right) \right] = 0 \quad (11.37)$$

(Section 11.4.2 will deal with steady-state flow in more detail.)

For transient (i.e. unsteady) flow, we find the commonly used one-dimensional equation by substituting Equation 11.33 into Equation 11.36, which yields

$$\frac{\partial h}{\partial t} = \frac{1}{C(h)} \frac{\partial}{\partial z} \left[K(h) \left(\frac{\partial h}{\partial z} + 1 \right) \right] \quad (11.38)$$

Equation 11.38 provides the basis for predicting transient soil-water movement in layered soils, each layer of which may have different physical properties.

11.4.2 Steady-State Flow

The most simple flow case is that of steady-state vertical flow (Equation 11.37). Integration of this equation yields

$$K(h) \left(\frac{dh}{dz} + 1 \right) = c \quad (11.39)$$

where c is the integration constant, with $q_z = -c$. Rewriting yields

$$q = -K(h) \left(\frac{dh}{dz} + 1 \right) \quad (11.40)$$

where

- q = vertical flux density (m/d)
- $K(h)$ = hydraulic conductivity as a function of h (m/d)
- h = pressure head (m)
- z = gravitational potential, positive in upward direction (m)

Rearranging Equation 11.40 yields

$$\frac{dz}{dh} = \frac{-1}{1 + \frac{q}{K(h)}} \quad (11.41)$$

To calculate the pressure-head distribution (i.e. the relationship between z and h for a certain $K(h)$ -relationship and a specified flux q), Equation 11.41 should be integrated

$$\int_0^{z_r} dz = - \int_0^{h_r} \frac{dh}{1 + \frac{q}{K(h)}} \quad (11.42)$$

where

- h_r = the pressure head (m); the upper boundary condition
- z_r = the height of capillary rise for flux q (m)

To calculate at what height above the watertable pressure head h_r occurs, integration should be performed from $h = 0$, at the groundwater level, to h_r . When the soil profile concerned is heterogeneous, integration is performed for each layer separately

$$\int_0^{z_n} dz = - \int_0^{h_1} \frac{dh}{1 + \frac{q}{K_1(h)}} - \int_{h_1}^{h_2} \frac{dh}{1 + \frac{q}{K_2(h)}} - \dots - \int_{h_{N-1}}^{h_n} \frac{dh}{1 + \frac{q}{K_N(h)}} \quad (11.43)$$

where

- N = the number of layers in the soil profile
- h_1, h_2, \dots, h_N = the pressure heads at the top of Layer 1, 2, ..., N

Solving Equation 11.43 yields the height of capillary rise, z , for given flux densities.

The h -values at the boundaries between the layers are unknown initially, and must be determined during the integration procedure. Thus, starting from $h = 0$ and $z = 0$ at the watertable, we steadily decrease h until z reaches z_r , the known position

of the i -th boundary. Since pressure head is continuous across the boundary (as opposed to water content), the value h_i may be used as the lower limit of the next integration term. In this way, the integration proceeds until either the last value of h (h_N) is reached or until z reaches the soil surface.

Equations 11.42 and 11.43 may be solved analytically for some simple $K(h)$ -relationships. For more complicated $K(h)$ -relationships, it would be very laborious, if not impossible, to find an analytical solution. Therefore, integration as described by Equations 11.42 and 11.43 is usually performed numerically, as, for example, in the computer program CAPSEV (Wesseling 1991).

For a marine clay soil in The Netherlands, the results of calculations with CAPSEV are shown in Figures 11.13A and 11.13B. Figure 11.13A shows the height of capillary rise and the pressure-head profile for different vertical-flux densities. Figure 11.13B shows the pressure-head profile during infiltration for several values of the vertical-flux density. The height of capillary rise was calculated for a watertable at a depth of 2 m. The soil profile consisted of five layers with differing soil-physical parameters.

Example 11.2

For drainage purposes, it can be useful to know the maximum flux for a given watertable pressure head and a certain watertable depth. Suppose that we have a crop

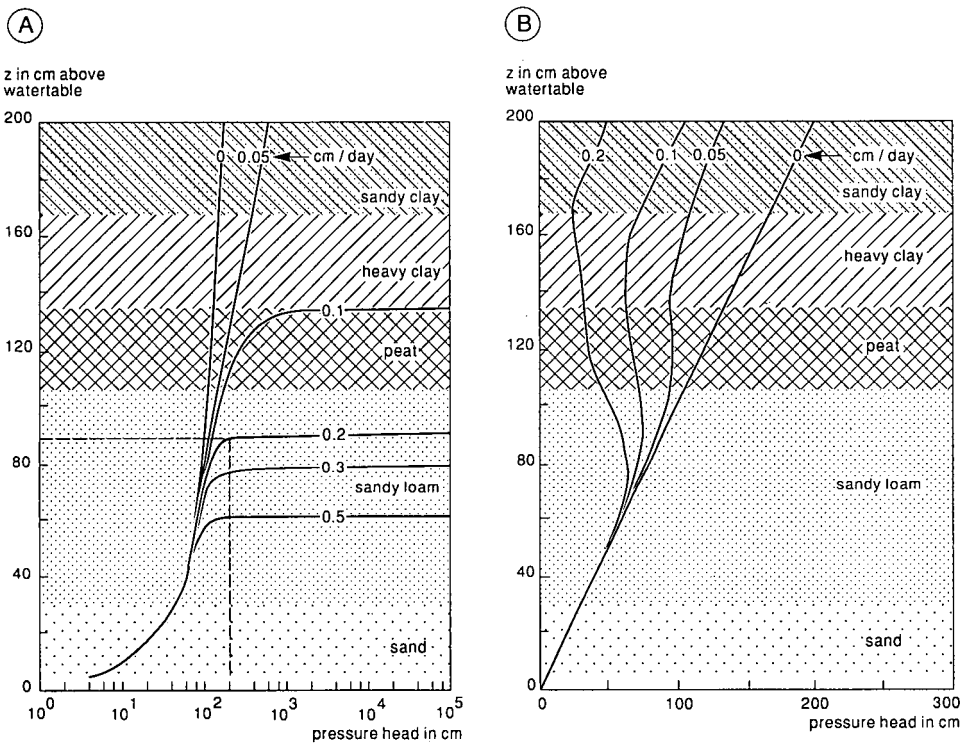

Figure 11.13 Calculations with computer program CAPSEV for a 5-layered soil profile (Wesseling 1991)

- A. Height of capillary rise
- B. Pressure-head profiles in case of infiltration

which, on the average, is transpiring at a rate of 2 mm/d. This water is withdrawn from the rootzone, say from the top 0.20 m of the soil profile. We assume that the crop would suffer from drought if the pressure head in the centre of the rootzone were to fall below -200 cm. We further assume that the groundwater level can be fully controlled by drainage. To prevent drought stress for the crop under any condition, the controlled groundwater depth should be such that, under steady-state conditions with a pressure head of -200 cm at 0.10 m depth (i.e. the average depth of the rootzone), the water delivery from the groundwater by capillary rise would equal water uptake by the roots, equalling 2 mm/d.

We can find the required groundwater depth from Figure 11.13A. We start on the horizontal axis at a pressure head of -200 cm, draw an imaginary upward line until it crosses the 2 mm/d flux-density curve, then go horizontally to the vertical axis and find a depth of 0.86 m. This means that the desired watertable depth is $0.86 + 0.10 = 0.96$ m below the soil surface.

11.4.3 Unsteady-State Flow

To obtain a solution for the unsteady-state equation (Equation 11.38), appropriate initial and boundary conditions need to be specified. As initial condition (at $t = 0$), the pressure head or the soil-water content must be specified as a function of depth

$$h(z,t=0) = h_0 \quad (11.44)$$

The boundary conditions at the soil surface ($z = 0$) and at the bottom of the soil profile ($z = -z_N$) can be of three types (see also section 11.8.2):

- Dirichlet condition: specification of the pressure head;
- Neumann condition: specification of the derivative of the pressure head, in combination with the hydraulic conductivity K , which means a specification of the flux through the boundaries;
- Cauchy condition: the bottom flux is dependent on other conditions (e.g. an external drainage system).

This list is not exhaustive, while also, depending on the type of problem to be solved, boundary conditions can be defined by combinations of the above options. Equation 11.38 is a non-linear partial differential equation because the parameters $K(h)$ and $C(h)$ depend on the actual solution of $h(z,t)$. The non-linearity causes problems in its solution. Analytical solutions are known for special cases only (Lomen and Warrick 1978). Most practical field problems can only be solved by numerical methods (Feddes et al. 1988). (Numerical methods used in the modelling of soil-water dynamics will be discussed in Section 11.8.)

11.5 Unsaturated Hydraulic Conductivity

The single most important parameter affecting water movement in the unsaturated zone is the unsaturated hydraulic conductivity, K , which appears in the unsaturated flow equation (Equation 11.38). In the case of saturated flow in soil, the total pore

space is filled with water and is thus available for flow. During unsaturated flow, however, part of the pores are filled with air and do not participate in the flow. The unsaturated hydraulic conductivity, $K(\theta)$ or $K(h)$, is therefore lower than the saturated conductivity. Thus, with decreasing soil-water content, the area available for flow decreases and, consequently, the unsaturated hydraulic conductivity decreases. The K in unsaturated soils depends on the soil-water content, θ , and, because $\theta = f(h)$, on the pressure head, h . Figure 11.14 shows examples of $K(\theta)$ -relationships for four layers of a sandy soil with a humic topsoil, together with the soil-water retention characteristics (De Jong and Kabat 1990).

Over the years, many laboratory and field methods have been developed to measure K as a function of h or θ . These methods can be divided into direct and indirect methods (Van Genuchten et al. 1989). Direct methods are, almost without exception, difficult to implement, especially under field conditions. Despite a number of improvements, direct-measurement technology has only marginally advanced over the last decades.

Nevertheless, indirect methods, which predict the hydraulic properties from more easily measured data (e.g. soil-water retention and particle-size distribution), have received comparatively little attention. This is unfortunate because these indirect methods, which we call 'predictive estimating methods', can provide reasonable estimates of hydraulic soil properties with considerably less effort and expense. Hydraulic conductivities determined with estimating methods may well be accurate enough for a variety of applications (Wösten and Van Genuchten 1988). Other important indirect methods are inverse methods of parameter estimates with analytical models that describe water retention and hydraulic conductivity (Kabat and Hack-ten Broeke 1989).

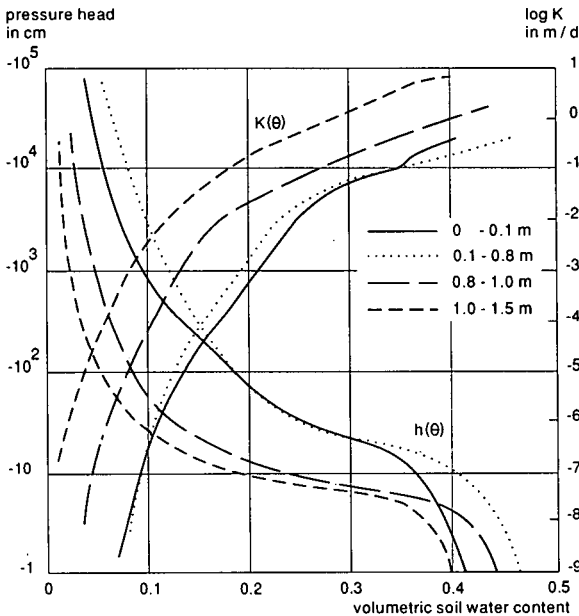

Figure 11.14 Soil-water retention, $h(\theta)$, and hydraulic conductivity, $K(\theta)$, curves for four layers of a sandy soil (after De Jong and Kabat 1990)

11.5.1 Direct Methods

Comprehensive overviews of direct methods of measuring the unsaturated hydraulic conductivity, K , and the soil-water diffusivity (D), $D = K(\theta)/(d\theta/dh)$, are given by Klute and Dirksen (1986) for laboratory methods, and by Green et al. (1986) for field methods.

In the steady-state methods, the flux, q , and hydraulic gradient, dH/dz , are measured in a system of time-invariant one-dimensional flow, and the Darcy Equation (Equation 11.40) is used to calculate K . The value of K obtained is then related to a measured h or θ . The procedure can be applied to a series of steady-state flow situations.

Transient laboratory methods include the method developed by Bruce and Klute (1956), in which the diffusivity is estimated from horizontal water content distributions, and the sorptivity method of Dirksen (1975).

The most common field methods include the 'instantaneous profile method', a good example of which is described by Hillel et al. (1972). In this method, an isolated, free-draining field is saturated and subsequently drained by gravity, while the field is covered to prevent evaporation. The hydraulic conductivity is calculated by applying Darcy's Law to frequent measurements of pressure head and water content during the drying phase. Various simplifications of this instantaneous profile concept, based on unit-gradient ($dH/dz = 1$, $H = h + z$, so $h = \text{constant}$, see Equation 11.37) approaches, have been developed (e.g. Libardi et al. 1980). This unit gradient does not require pressure-head measurements. These methods provide the hydraulic soil properties between saturation and field capacity, since gravity drainage becomes negligible at water contents below field capacity.

Clothier and White (1981) developed a method to determine $K(\theta)$, $\theta(h)$, and $D(\theta)$ from sorptivity measurements. 'Sorptivity' is the initial infiltration rate during the infiltration process. It can be measured quickly and is therefore a practical method of determining the hydraulic soil properties.

The 'crust method' of Bouma et al. (1971) is a field variant of steady state laboratory approaches. A soil column is isolated from the surrounding soil, covered with a crust, and a constant head is maintained on the crust. Because the hydraulic conductivity of the crust is relatively small compared with that of the soil, the pressure head in the soil will be lower than zero. Because a constant head is maintained above the crust, a steady-state flow will develop in the crust and a steady-state flux, lower than the saturated flux of the soil, will enter the soil and create a steady-state unsaturated flow. Hydraulic conductivities for different pressure heads can be determined with crusts of different material and thickness. The method allows us to determine hydraulic conductivities in the h -range of 0 to -100 cm.

All the above methods of measuring $K(\theta)$, $K(h)$, or $D(\theta)$ are typically based on Darcy's Law, or on various numerical approximations or simplifications of Equation 11.38. This enables us to express K or D in terms of directly observable parameters. These direct methods are relatively simple in concept, but they also have a number of limitations which restrict their practical use. Most methods are time-consuming because restrictive initial and boundary conditions need to be imposed (e.g. free drainage of an initially saturated soil profile). This is especially problematic under field conditions where, because of the natural variability in properties and the

uncontrolled conditions, accurate implementation of boundary conditions may be difficult.

Even more difficult are the methods requiring repeated steady-state flow or other equilibrium conditions. Many of the simplified methods require the governing flow equations to be linearized or otherwise approximated to allow their direct inversion, which may introduce errors. A final shortcoming of the direct methods is that they usually lack information about uncertainty in estimated soil hydraulic conductivity, because it is impractical to repeat the measurements a number of times.

A laboratory method which is more or less a transition between direct and indirect methods is the 'evaporation method' (Boels et al. 1978). In this method, an initially wet soil sample is subjected to free evaporation. The sample, 80 mm high and 100 mm in diameter, is equipped with four tensiometers. The sample is weighed at brief time intervals and, at the same time, the pressure head is recorded. From these weight and pressure-head data, the average soil-water retention at each time interval can be determined. An iterative procedure is now used to derive the soil-water retention, and the instantaneous profile method to derive the hydraulic conductivity for each depth interval of 20 mm around a tensiometer. In this way, the method yields soil-water retention and hydraulic conductivity for $h = -100$ to -800 cm for sandy soils and for $h = -20$ to -800 cm for clay soils.

The advantages of the evaporation method are that it simultaneously yields both soil-water retention and hydraulic conductivity over a relatively wide h -range. The experimental conditions, in terms of boundary conditions, are close to natural conditions, because water is removed by evaporation. Disadvantages are that the procedure takes a considerable time (approximately 1 month per series of samples), and that the soil-water retention and hydraulic conductivity are based on an iterative procedure.

11.5.2 Indirect Estimating Techniques

Many of the disadvantages of the direct techniques do not apply to the indirect techniques. The indirect methods can basically be divided into two categories: 'predictive estimates' and 'parameter estimates'. The advantage of both methods is that neither depends on the created ideal experimental conditions.

The usefulness of predictive estimates depends on the reliability of the correlation or transfer function, and on the availability and accuracy of the easily measured soil data. The estimate functions are often called 'pedo-transfer functions' because they transfer measured soil data from one soil to another, using pedological characteristics.

The parameter-estimate approach for soil hydraulic properties is based on inverse modelling of soil water flow. This approach is very flexible in boundary and initial conditions. The inverse approach was developed parallel with advances in computer and software engineering (Feddes et al. 1993a).

Prediction of the $K(h)$ Function from Soil Texture and Additional Soil Properties

The methods discussed in this section are referred to as 'pedo-transfer functions'. Pedo-transfer functions are usually based on statistical correlations between hydraulic soil properties, particle-size distribution, and other soil data, such as bulk density, clay

mineralogy, cation exchange capacity, and organic carbon content. Other pedo-transfer functions relate parameters of the Van Genuchten model (see the following section) in a multiple regression analysis to, for example, bulk density, texture, and organic-matter content (e.g. Wösten and Van Genuchten 1988).

The development of pedo-transfer functions offers promising prospects for estimating soil hydraulic properties over large areas without extensive measuring programs. Such pedo-transfer functions are only applicable to areas with roughly the same parent material and with comparable soil-forming processes. Developing and testing these methods is as yet far from complete. Vereecken et al. (1992), for example, concluded that errors in estimated soil-water flow were more affected by inaccuracies in the pedo-transfer functions than by errors in the easily measured soil characteristics.

Another approach to identifying hydraulic soil properties on a regional scale is by identifying 'functional soil physical horizons'. This approach was followed by Wösten (1987), who used measured values of soil-water retention and hydraulic conductivity of representative Dutch soils, and classified these in groups according to texture and position in the soil profile. These groups were called functional soil physical horizons. Another example is the Catalogue of Hydraulic Properties of the Soil by Mualem (1976a).

Predicting the K(h) Function from Soil-Water Retention Data

The most simple form of parameter estimating concerns the prediction of K(h) from soil-water retention data. Water retention is more easily measured than hydraulic conductivity, and the estimating methods are usually based on statistical pore-size distribution models (Mualem 1976b). The most frequently applied predictive conductivity models are those of Mualem and Burdine (Van Genuchten et al. 1989). Van Genuchten (1980) combined Mualem's model with an empirical S-shaped curve for the soil-water retention function to derive a closed-form analytical expression for the unsaturated hydraulic conductivity curve.

The empirical Van Genuchten Equation for the soil-water retention curve reads

$$\theta = \theta_r + \frac{\theta_s - \theta_r}{(1 + |\alpha h|^n)^m} \quad (11.45)$$

where

θ_r = residual soil-water content (i.e. the soil water that is not bound by capillary forces, when the pressure head becomes indefinitely small) (-)

θ_s = saturated soil-water content (-)

α = shape parameter, approximately equal to the reciprocal of the air-entry value (m^{-1})

n = dimensionless shape parameter (-)

$m = 1 - 1/n$

After combining Equation 11.45 with the Mualem model, we find the Van Genuchten-Mualem analytical function, which describes the unsaturated hydraulic conductivity as a function of soil-water pressure head

$$K(h) = K_s \frac{[1 - |\alpha h|^{n-1} (1 + |\alpha h|^n)^{-m}]^2}{[1 + |\alpha h|^n]^{m\lambda}} \quad (11.46)$$

where

- K_s = saturated hydraulic conductivity (m/d)
- λ = a shape parameter depending on dK/dh

The shape parameters in Equations 11.45 and 11.46 can be fitted to measured water-retention data. The Van Genuchten model in its most free form contains six unknowns: θ_r , θ_s , α , n , λ , and K_s . Although, with specially developed computer programs, the mathematical fitting procedure enables us to find these unknowns for measured data, its use as a predictive model in this form is difficult. The fitting procedure is improved when some measurable parameters are known approximately, so that they can be optimized in a narrow range around these measured values.

To predict $K(h)$ from the water-retention curve, we need to measure K_s . However, if a few $K(h)$ -values are known in combination with soil-water-retention values, K_s can be found with an iteration procedure and need not be measured. Computer software has been developed (Van Genuchten et al. 1991) to fit the analytical functions of the model to some measured $\theta(h)$ and $K(h)$ -data. The same program allows the $K(h)$ -function to be predicted from observed water-retention data.

Yates et al. (1992) recently evaluated parameter estimates with different data sets and for various combinations of known and unknown parameters. They concluded that predicting the unsaturated hydraulic conductivity from soil-water retention data and measured K_s -values yielded poor results. Using a simultaneous fitting of $K(h)$ and $\theta(h)$ data, while treating λ as an unknown parameter, improved results significantly. Apparently, water-retention data combined with a measured K_s are not always sufficient to describe the $K(h)$ -function with Equation 11.46.

The Van Genuchten model in its original form is inadequate for very detailed simulation studies, because it is only valid for monotonic wetting or drying. By adding only one parameter, Kool and Parker (1987) extended the model so as to include hysteresis in $\theta(h)$ and $K(h)$ functions.

Inverse Problem combined with Parameter Optimization Techniques

In this approach, the direct flow problem can be formulated for any set of initial and boundary conditions and solved with an analytical or numerical method. Input data are measured soil-water contents, measured pressure-head profiles, or measured discharge under known boundary conditions, or any combination thereof, always as a function of time. Certain constitutive functions for the hydraulic properties are assumed, and unknown parameter values in those functions are estimated with the use of an optimization procedure. This optimization minimizes the objective function (e.g. the sum of the squared differences between observed and calculated values of either water content or pressure head) until a desired accuracy is reached.

The inverse method can be applied to both laboratory experiments and field experiments. A disadvantage of the laboratory procedure is that we cannot explore the full potential of this method, because of the necessarily limited size of the soil sample. Moreover, the collection of soil samples always introduces some disturbance that may affect flow properties. Thus, applying the method in-situ seems to offer the best prospects. The capabilities of this technique have been shown by Feddes et al. (1993a and b) and Kool et al. (1987).

11.6 Water Extraction by Plant Roots

Under steady-state conditions, water flow through the soil-root-stem-leaf pathway can be described by an analogue of Ohm's Law with the following widely accepted expression

$$T = \frac{h_m - h_r}{R_s} = \frac{h_r - h_l}{R_p} \quad (11.47)$$

where

- T = transpiration rate (mm/d)
 h_m, h_r, h_l = matric heads in the soil, at the root surface, and in the leaves, respectively (mm)
 R_s, R_p = liquid flow resistances in soil and plant, respectively (d)

If we consider the diffusion of water towards a single root, we can see that R_s is dependent on root geometry, rooting length, and the hydraulic conductivity of the soil. This so-called microscopic approach is often used when evaluating the influence of complex soil-root geometries on water and nutrient uptake under steady-state laboratory conditions. In the field, the components of this microscopic approach are difficult to quantify for a number of reasons. Steady-state conditions hardly exist in the field. The living root system is dynamic, roots grow and die, soil-root geometry is time-dependent, and water permeability varies with position along the root and with time. Root water uptake is most effective in young root material, but the length of young roots is not directly related to the total root length. The experimental evaluation of root properties is difficult, and often impossible.

Although detailed studies can be relevant for a better understanding of plant physiological processes, they are not yet usable in describing soil-water flow. Thus, instead of considering water flow to single roots, we follow a macroscopic approach. In this approach, a sink term, S , is introduced, which represents water extraction by a homogeneous and isotropic element of the root system, and added to the continuity equation (Equation 11.27) for vertical flow (Feddes et al. 1988)

$$\frac{\partial \theta}{\partial t} = -\frac{\partial q}{\partial z} - S \quad (11.48)$$

Consequently, the one-dimensional equation for transient soil-water movement (Equation 11.38) can be rewritten as

$$\frac{\partial h}{\partial t} = \frac{1}{C(h)} \frac{\partial}{\partial z} \left[K(h) \left(\frac{\partial h}{\partial z} + 1 \right) \right] - \frac{S(h)}{C(h)} \quad (11.49)$$

where

$$S = \text{sink term (d}^{-1}\text{)}$$

The sink term, S , is quantitatively important since the water uptake can easily be more than half of the total change in water storage in the rootzone over a growing season.

Feddes et al. (1988), in the interest of practicality, assumed a homogeneous root distribution over the soil profile and defined S_{\max} according to

$$S_{\max} = \frac{T_p}{|Z_r|} \quad (11.50)$$

where

S_{\max} = the maximum possible water extraction by roots (d^{-1})

T_p = the potential transpiration rate (mm/d)

$|Z_r|$ = the depth of the rootzone (mm)

Prasad (1988) introduced an equation to take care of the fact that, in a moist soil, the roots principally extract water from the upper soil layers, leaving the deeper layers relatively untouched. He assumed that root water uptake at the bottom of the rootzone equals zero and derived the following equation

$$S_{\max}(Z) = \frac{2T_p}{|Z_r|} \left(1 - \frac{|z|}{|z_r|} \right) \quad (11.51)$$

Both root water-uptake functions are shown in Figure 11.15.

So far, we have considered root water uptake under optimum soil-water conditions (i.e. S_{\max}). Under non-optimum conditions, when the rootzone is either too dry or too wet, S_{\max} is dependent on (h) and can be described as (Feddes et al. 1988).

$$S(h) = \alpha(h)S_{\max} \quad (11.52)$$

where

$\alpha(h)$ = dimensionless, plant-specific prescribed function of the pressure head

The shape of this function is shown in Figure 11.16. Water uptake below $|h_1|$ (oxygen deficiency) and above $|h_4|$ (wilting point) is set equal to zero. Between $|h_2|$ and $|h_3|$ (reduction point), water uptake is at its maximum. Between $|h_1|$ and $|h_2|$, a linear relation is assumed, and between $|h_3|$ and $|h_4|$, a linear or hyperbolic relation between α and h is assumed. The value of $|h_3|$ depends on the evaporative demand of the atmosphere and thus varies with T_p .

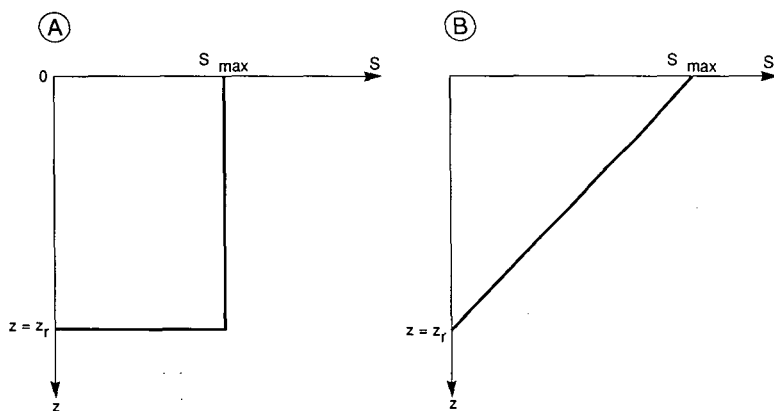

Figure 11.15 Different water-uptake functions under optimum soil-water conditions, S_{\max} , as a function of depth, z , over the depth of the rootzone, z_r , as proposed by A: Feddes et al. (1988) and B: Prasad (1988)

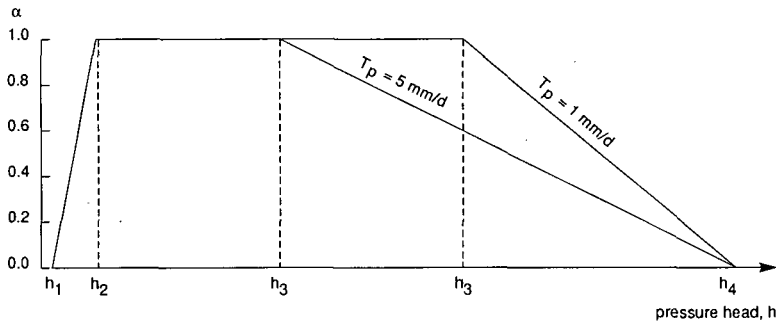

Figure 11.16 Dimensionless sink-term variable, α , as a function of the absolute value of the pressure head, h (after Feddes et al. 1988)

11.7 Preferential Flow

In the previous sections, we described unsaturated-zone dynamics for isotropic and homogeneous soils. The fact that most soils are neither was already recognized in the 19th century. In natural soils, the transport of water is often heterogeneous, with part of the infiltrating water travelling faster than the average wetting front. This has important theoretical and practical consequences. Theoretical calculations of the field water balance, the derived crop water use, and the estimated crop yield are incorrect if preferential flow occurs but is not incorporated. Practically, preferential flow has a strong impact on solute transport and on the pollution of groundwater and subsoil (e.g. Bouma 1992). Preferential flow varies considerably from soil to soil, in both quantity and intensity. In some soils, preferential flow occurs through large pores in an unsaturated soil matrix, a process known as 'by-pass flow' or 'short-circuiting' (Hoogmoed and Bouma 1980). In other soils, flow rates vary more gradually, making it difficult to distinguish matrix and preferential pathways.

Preferential flow of water through unsaturated soil can have different causes, one of them being the occurrence of non-capillary-sized macropores (Beven and Germann 1982). This type of macroporosity can be caused by shrinking and cracking of the soil, by plant roots, by soil fauna, or by tillage operations. Wetting-front instability, as caused by air entrapment ahead of the wetting front or by water repellency of the soil (Hendrickx et al. 1988) can also be viewed as an expression of preferential flow. Whatever the cause, the result is that the basic partial differential equations (Equations 11.38 and 11.49) describing water flow in the soil need to be adapted.

Hoogmoed and Bouma (1980) developed a method of calculating infiltration, including preferential flow, into clay soils with shrinkage cracks. The method combines vertical and horizontal infiltration. It is physically based, but was only applied to soil cores of 200 mm height and was not tested in the field. Bronswijk (1991) introduced a method in which preferential flow through shrinkage cracks is calculated as a function of both the area of cracks at the soil surface, and the maximum infiltration rate of the soil matrix between the cracks.

The division of soil water over the soil matrix and the macropores, and the fate of water flowing downward through the macropores, is handled differently in the

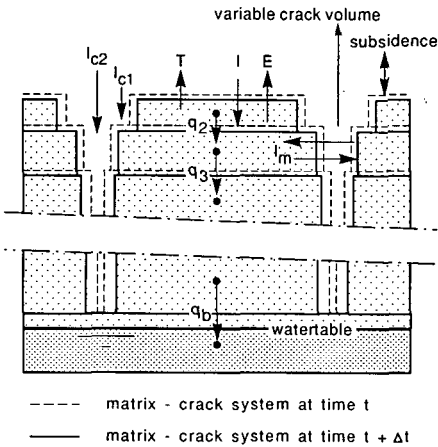

Figure 11.17 Concept for unsaturated water transport in cracking soils. I is the infiltration rate into the soil matrix, I_c is infiltration into cracks, I_m is the horizontal flux through the walls of the macropores, q is the Darcy Flux between two nodal points, and q_b is the bottom flux of the system (after Feddes et al. 1988)

various methods mentioned above. The common principle, however, is essentially the two-domain concept. The interaction between water in the two domains is also important. In some approaches, the total preferential flow is accumulated at the bottom of the macropores and is then added to the unsaturated flow at that depth (Bronswijk 1991).

A more general approach was suggested by Feddes et al. (1988), who linked preferential flow and matrix flow by extending the basic differential equation (Equation 11.49)

$$\frac{\partial h}{\partial t} = \frac{1}{C(h)} \frac{\partial}{\partial z} \left[K(h) \left(\frac{\partial h}{\partial z} + 1 \right) \right] - \frac{S(h)}{C(h)} + \frac{B(h)}{C(h)} \quad (11.53)$$

where

B = source of soil water due to horizontal infiltration into the macropores, or a sink due to evaporation through the walls of the macropores

The resulting model is schematically illustrated in Figure 11.17. The quantification of the B -term in Equation 11.53, however, is difficult and requires a number of simplifications (Bronswijk 1991).

11.8 Simulation of Soil-Water Dynamics in Relation to Drainage

The design of drainage systems is usually based on criteria that are derived from steady-state or unsteady-state equations (Chapter 17). The underlying theories are mainly based on saturated flow to drains (Chapter 8), and do not consider the effects of drainage in the unsaturated zone, which is where the crops are rooted. The performance of drainage systems designed with those equations is subsequently tested

in field trials or pilot areas (Chapter 12). Because of budget and time constraints, pilot areas may not represent the complete range of environmental conditions in a project area, and may not give an insight into the long-term sustainability of the drainage project.

Computer modelling can therefore be an important source of additional information, because many project conditions can be simulated quickly and cheaply for various time intervals. The principles and processes presented in Sections 11.3 to 11.7 can be used to predict soil-water dynamics and crop response. The interactions between all components involved are described by mathematical relationships, which can be combined in simulation models. One such simulation model is SWACROP (Kabat et al. 1992), which allows the user to evaluate the effect of different drainage strategies (i.e. criteria and designs) on water conditions in the unsaturated rootzone, and hence on crop production. After some introductory explanations (Sections 11.8.1 to 11.8.3), we shall illustrate the modelling approach with a number of examples from water-management and drainage practice (Section 11.8.4).

11.8.1 Simulation Models

'Simulation' is the use of models as tools to imitate the real behaviour of existing or hypothesized systems. Most important and interesting is the simulation of dynamic systems. Simulation models are usually realized in the form of computer programs and are therefore also referred to as 'computer models'.

A drainage simulation model for the unsaturated zone and crop production should, for example, be able to describe the effects of a specific drainage design on soil-water dynamics and related crop yields. Soil-water flow is also the governing factor in solute transport, and is thus responsible for changes in soil chemical status (e.g. plant nutrients and soil salinity; Chapter 15). Appropriate simulation models can predict the effects of different drainage designs on water and salt balances, which, in turn, relate to crop production.

The most complex simulation models are mathematical models that employ numerical techniques to solve differential equations (Section 11.8.2). Even if these models are mathematically and numerically correct, they need to be verified and calibrated against field data, and the required accuracy of input data needs to be assessed (Section 11.8.3).

11.8.2 Mathematical Models and Numerical Methods

Mathematical Models

In the previous sections, soil-water dynamics were cast in the form of mathematical expressions that describe the hydrological relationships within the system. The set of relevant partial differential equations, together with auxiliary conditions, define the mathematical model. The auxiliary conditions must describe the system's geometry, the system parameters, the boundary conditions and, in the case of transient flow, also the initial conditions.

If the governing equations and auxiliary conditions are simple, an exact analytical

solution may be found. Otherwise, a numerical approximation is needed. Numerical simulation models are by far the most common ones.

Numerical Methods

At present, numerical approximations are possible for complex, compressible, non-homogeneous, and anisotropic flow regions having various boundary configurations.

Numerical methods are based on subdividing the flow region into finite segments bounded and represented by a series of nodal points at which a solution is sought. This point solution depends on the solutions of the surrounding segments, and also on an appropriate set of auxiliary conditions.

In recent years, a number of numerical methods have been introduced. The most appropriate methods for soil-water movement are 'finite-difference methods' and 'finite-element methods'.

To illustrate the use of finite-difference methods, we shall consider the case of one-dimensional unsaturated flow without sinks/sources (Equation 11.36). Let the flow depth be divided into equal intervals, ΔZ , and the time be similarly divided into time steps, Δt . The resulting two-dimensional grid is shown in Figure 11.18.

Equation 11.36 can now be expressed in finite difference form as

$$\frac{\theta_i^{j+1} - \theta_i^j}{\Delta t} = \frac{1}{\Delta Z} \left[K_{i+1/2}^j \left(\frac{h_{m_{i+1}}^j - h_{m_i}^j}{\Delta Z} + 1 \right) - K_{i-1/2}^j \left(\frac{h_{m_i}^j - h_{m_{i-1}}^j}{\Delta Z} + 1 \right) \right] \quad (11.54)$$

where

i = index along the space coordinate

j = index along the time abscissa

Equation 11.54 represents the so-called forward difference scheme with an explicit linearization of the $K(\theta)$ -function.

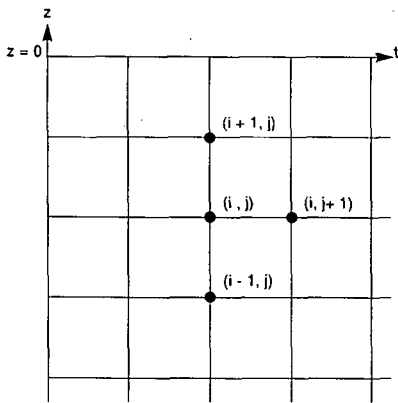

Figure 11.18 Bi-linear grid superimposed on the z - t plane with the flow and time domain divided into equal intervals. The grid represents a forward finite difference scheme

Backward-difference schemes also exist. The resulting set of algebraic equations can be solved with special techniques such as linearization. The advantage of the finite-difference method is its simplicity and its efficiency in treating time derivatives. On the other hand, the method is rather incapable of dealing with complex geometries of flow regions, and has a few other drawbacks as well.

With finite-element methods, the flow area is divided into a number of rigid elements. In modelling soil-water flow problems, triangular elements can be efficiently used to represent difficult geometries and to be more precise in regions where rapid changes are expected (e.g. near the soil surface or wetting fronts). Figure 11.19 shows an example of such a triangular nodal network. The corners of the triangular elements are designated as nodal points. In these nodes, state variables like matric head are specified. Via a number of techniques, one first gets a set of quasi-linear first-order differential equations, which are then discretized and integrated in discrete time steps. The resulting set of non-linear equations is then solved, until iterations have converged to a prescribed degree of accuracy.

Finite-element methods are capable of solving complex flow geometries, with non-linear and time-dependent boundary conditions, while possessing great flexibility in following rapid soil-water movement. In many cases, the rate of convergence of the finite-element methods exceeds that of the finite-difference methods. A drawback of the finite-element method is the rather time-consuming and laborious preparation of the solution mesh. With an automatic mesh generation model, however, this problem can be considerably reduced. Another problem is that checking the finite-element solution by simple calculations is not always possible.

Initial Conditions

Initial conditions must be defined when transient soil-water flow is being modelled. Usually, values of matric head or soil-water content at each nodal point within the soil profile are required. When these data are not available, however, water contents at field capacity or those in equilibrium with the watertable might be regarded as the initial ones.

Upper Boundary Conditions

While the potential evaporation rate from a soil depends only on atmospheric

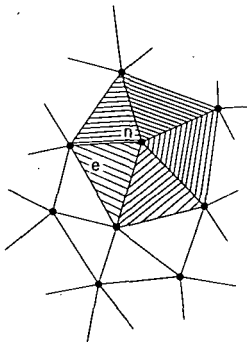

Figure 11.19 Network of triangular finite elements. The corners of the element *e* are designated as nodal points *n*, in which state variables are located

conditions, the actual flux through the soil surface is limited by the ability of the soil matrix to transport water. Similarly, if the potential rate of infiltration exceeds the infiltration capacity of the soil, part of the water is stored on the soil surface or runs off, because the actual flux through the top layer is limited by moisture conditions in the soil. Consequently, the exact upper boundary conditions at the soil surface cannot be estimated *a priori*, and solutions must be found by maximizing the absolute flux, as explained by Feddes et al. (1988).

Lower Boundary Conditions

The lower boundary of the unsaturated zone is usually taken at the phreatic surface, except if the watertable is very deep, when an arbitrary lower boundary is set.

Generally, one of the following lower boundary conditions are used:

- Dirichlet condition: The main advantage of specifying a matric head zero as the bottom boundary is that it is easy to record changes in the phreatic surface of a watertable. A drawback is that, with shallow watertables (< 2 m below soil surface), the simulated effects of changes in phreatic surface are extremely sensitive to variations in the soil's hydraulic conductivity;
- Neumann condition: A flux as lower boundary condition is usually applied in cases where one can identify a no-flow boundary (e.g. an impermeable layer) or where free drainage occurs. With free drainage, the flux is always directed downward and the gradient $dH/dz = 1$, so the Darcian Flux is equal to the hydraulic conductivity at the lower boundary;
- Cauchy condition: This type of boundary condition is used when unsaturated flow models are combined with models for regional groundwater flow or when the effects of surface-water management are to be simulated under conditions of surface or subsurface drainage (see Figure 11.20). Writing the lower boundary flux, q_b , as a function of the phreatic surface, which in this case is the dependent variable, one can incorporate relationships between the flux to/from the drainage system and the height of the phreatic surface. This flux-head relationship can be obtained from drainage formulae such as those of Hooghoudt or Ernst (see Chapter 8) or from regional groundwater flow models (e.g. Van Bakel 1986).

With the lower boundary conditions, the connection with the saturated zone can be established. In this way, the effects of activities that influence the regional groundwater system upon, say, crop transpiration can be simulated. The coupling between the two systems is possible by regarding the phreatic surface as an internal moving boundary with one-way or two-way relationships.

The most general form of the Cauchy condition can be written as

$$q_b = q_d + q_a \quad (11.55)$$

where

q_b = the flux through the lower boundary (m/d)

q_d = the flux from/to the drainage system (m/d)

q_a = the flux to/from deep aquifers (m/d) (Figure 11.20)

When the Cauchy condition is linked with a one-dimensional vertical-flow model,

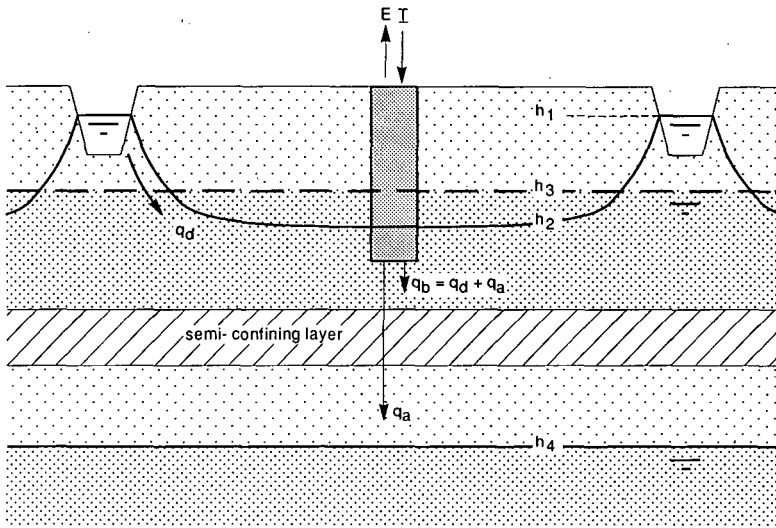

Figure 11.20 The flow situation (Cauchy lower boundary condition) for outflow from ditches and downward seepage to the deep aquifers: h_1 is the open water level; h_2 is the phreatic surface level; h_3 is the level of the phreatic surface averaged over the area; and h_4 is the piezometric level of the deep aquifer

one can regard such a solution as quasi-two-dimensional, since both vertical and horizontal flow are calculated.

11.8.3 Model Data Input

Required Input Data

The simulation of water dynamics in the unsaturated zone requires input data on the model parameters, the geometry of the system, the boundary conditions, and, when transient flow is being simulated, initial conditions. The geometry parameters define the dimensions of the problem domain, while the physical parameters describe the physical properties of the system under consideration. Unsaturated-zone flow depends on the soil-water characteristic, $\theta(h)$, and the hydraulic conductivity, $K(\theta)$. If root water uptake is also modelled, parameters defining the relationship between water uptake by the roots and soil-water tension should be given, together with crop specifications. If a functional flux-head relationship is used as lower boundary condition, the parameters describing the interaction between surface water and groundwater and – if necessary – the vertical resistance of poorly permeable layers have to be supplied.

Before the models can be used to simulate the effects of different drainage strategies on the unsaturated zone, the models need to be calibrated. This can be done by comparing the results of model simulations with measured data from special calibration fields, and by adapting appropriate parameter values within the plausible range until simulation results and field measurements correspond to the desired degree. The calibrated model subsequently needs to be validated on another data set which

was not used for the calibration. Only when calibration and validation are satisfactory can the model be applied to simulate the effects of drainage strategies for use in design procedures. A good calibration requires a profound analysis of the model parameters and of their influence on model results. (For details on model calibration, see specialized publications on this subject: e.g. Kabat et al. 1994).

Spatial Variability

One of the issues that complicate model calibration is spatial variability of soil hydraulic parameters and related terms of the water balance.

Most models of the unsaturated zone are one-dimensional. The hydrological and drainage problems that have to be modelled, however, concern areas, and have a spatial component, be it a local or a regional one. If the area were to be homogeneous in all its components, a point simulation could be representative of an entire region. The soil, however, is never homogeneous, but is subject to spatial variability. The variability of a parameter will not only influence the measuring program, but is also important for evaluating possible model accuracies.

The basic assumption of spatial variability in the unsaturated zone is that the porous medium is a macroscopic continuum with properties that are continuous functions of the space coordinates. The description of spatial variability by statistical techniques is referred to as 'geostatistical methods' (e.g. Jury et al. 1987).

Geostatistics can be used to determine the most efficient sampling schemes to obtain practical mean values of spatially dependent properties (e.g. soil hydraulic properties) within a specific soil or land unit. It can also be used to describe the variability of those properties and for the regionalization of point simulations. A proper application of the geostatistical approach may reveal field characteristics that are not apparent from conventional statistical analysis, but are not without significance for the properties being considered.

A frequently used technique to account for spatial variability is 'scaling'. Scaling can also be used to regionalize one-dimensional simulation models. In principle, scaling is a technique of expressing the statistical variability in, for instance, the hydraulic conductivity in functional relationships. By this simplification, the pattern of spatial variability is described by a set of scale factors, defined as the ratio between the characteristic phenomenon at the particular location and the corresponding phenomenon of a reference soil (Hopmans 1987).

Accuracy of Hydraulic Soil Parameters

The reliability of the results of simulation depends on the reliability of the model and on the accuracy of the parameters used in the model. The reliability and accuracy of the model are assessed by calibration and validation.

The required accuracy of input data should be relevant to the type of application and the type of problem to be solved (Wösten et al. 1987). It is also a function of the scale of the problem and of the sensitivity of the process to the parameters used. For site-specific studies, a higher accuracy is required than for regional studies. For processes directly dependent on the hydraulic soil properties (e.g. capillary rise, recharge to the groundwater, and solute transport), the required accuracy is higher than for processes that are related to the soil hydraulic properties in a more integrated way (e.g. seasonal crop transpiration or crop production).

Kabat and Hack-ten Broeke (1989) used the SWACROP simulation model to investigate the sensitivity of different land qualities to hydraulic soil parameters, using data collected for a maize crop over 1985 and 1986. Simulated pressure heads at 5 cm depth – a measure for the land qualities of workability and trafficability – were computed for three different $K(\theta)$ relationships (Figure 11.21). From the data for both years, they concluded that the three unsaturated conductivities led to considerable differences in trafficability, especially during wet periods ($h > -100$ cm). It appears that $K(\theta)$ needs to be known quite accurately for this direct land quality.

In contrast, the cumulative actual dry-matter-production curves, representing an integrated land-quality, showed no (1985) or only minor (1986) differences as a result of the different $K(\theta)$'s (Figure 11.21). This proves that the sensitivity to hydraulic soil parameters can decrease when more integrated land qualities are considered.

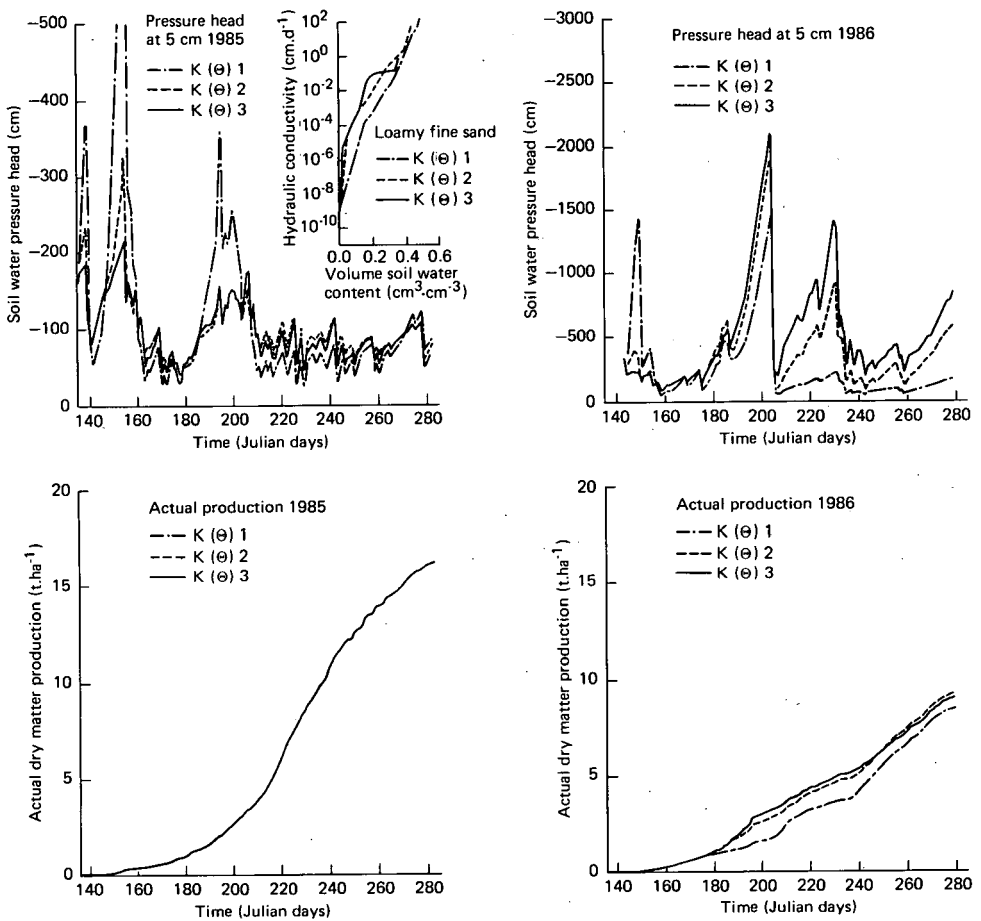

Figure 11.21 Sensitivity of the SWACROP model to the soil hydraulic parameter $K(\theta)$ in terms of pressure heads at 5 cm depth and actual dry-matter production (after Kabat and Hack-ten Broeke 1989)

11.8.4 Examples of Simulations for Drainage

Three examples of the application of the SWACROP simulation model in drainage problems will be given. Two of the examples concern water management under the moderate humid conditions of The Netherlands. The third concerns drainage and irrigation in the sub-tropical semi-arid conditions of Pakistan.

SWACROP (Kabat et al. 1992) describes transient water flow in a heterogeneous soil-root system, which can be under the influence of groundwater. It contains a crop-growth simulation routine, which describes the potential and actual crop production as a function of crop transpiration and of a few other environmental variables. Soil-water movement is simulated in response to pressure-head gradients according to Equation 11.49. Upper and lower boundary conditions can be set to reproduce a variety of common hydrological field situations. The model allows us to simulate subsurface and surface drainage systems, and irrigation.

Example 11.3 Drainage of Arable Land in The Netherlands

An integrated simulation approach, based on the agrohydrological model SWACROP, was developed by Feddes and Van Wijk (1990). In the integrated approach, land capability is quantified in terms of crop productivity under different conditions of climate, soil, drainage or irrigation, and farm management. The model can consider the following aspects, all of which can be affected by the operation of a drainage system via the soil-water conditions in the unsaturated zone:

- Number of days in spring when the soil-water content in the upper soil layer is low enough to permit soil cultivation and sowing or planting (farm-management aspect);
- Germination and crop emergence related to soil-water content and soil temperature;
- Water uptake, and growth and production of the crop between emergence and harvest;
- Number of workable days in autumn, when soil-moisture conditions allow harvesting operations (farm-management aspect).

The model calculated the effects of 15 combinations of drain depth and spacing on the yield of potatoes and spring cereals grown over 30 years on eight major soil types in The Netherlands. Three different definitions of seasonal yield were introduced: Y_{\max} , the production under optimum water supply and earliest possible emergence; Y_{pot} , which includes retardation due to excessive wetness (insufficient drainage); and Y_{act} , representing for the actual water supply to account for the drainage effect on the yield:

$$\frac{Y_{\text{act}}}{Y_{\max}} = \frac{Y_{\text{pot}}}{Y_{\max}} \times \frac{Y_{\text{act}}}{Y_{\text{pot}}} \quad (11.56)$$

The spring term, Y_{pot}/Y_{\max} , accounts for a reduction in crop yield as a result of retarded planting and emergence. The growing season term, $Y_{\text{act}}/Y_{\text{pot}}$, quantifies the effects of too dry conditions (i.e. when the system is 'over-drained' and there are water shortages in the rootzone), or too wet conditions (when the system is 'under-drained') on the crop yield. The overall drainage effect, Y_{act}/Y_{\max} , is the product of these two ratios.

We shall use the analysis of Feddes and Van Wijk (1990) and look at the yield of potatoes. For each of the eight major soil types in this study, the water-retention

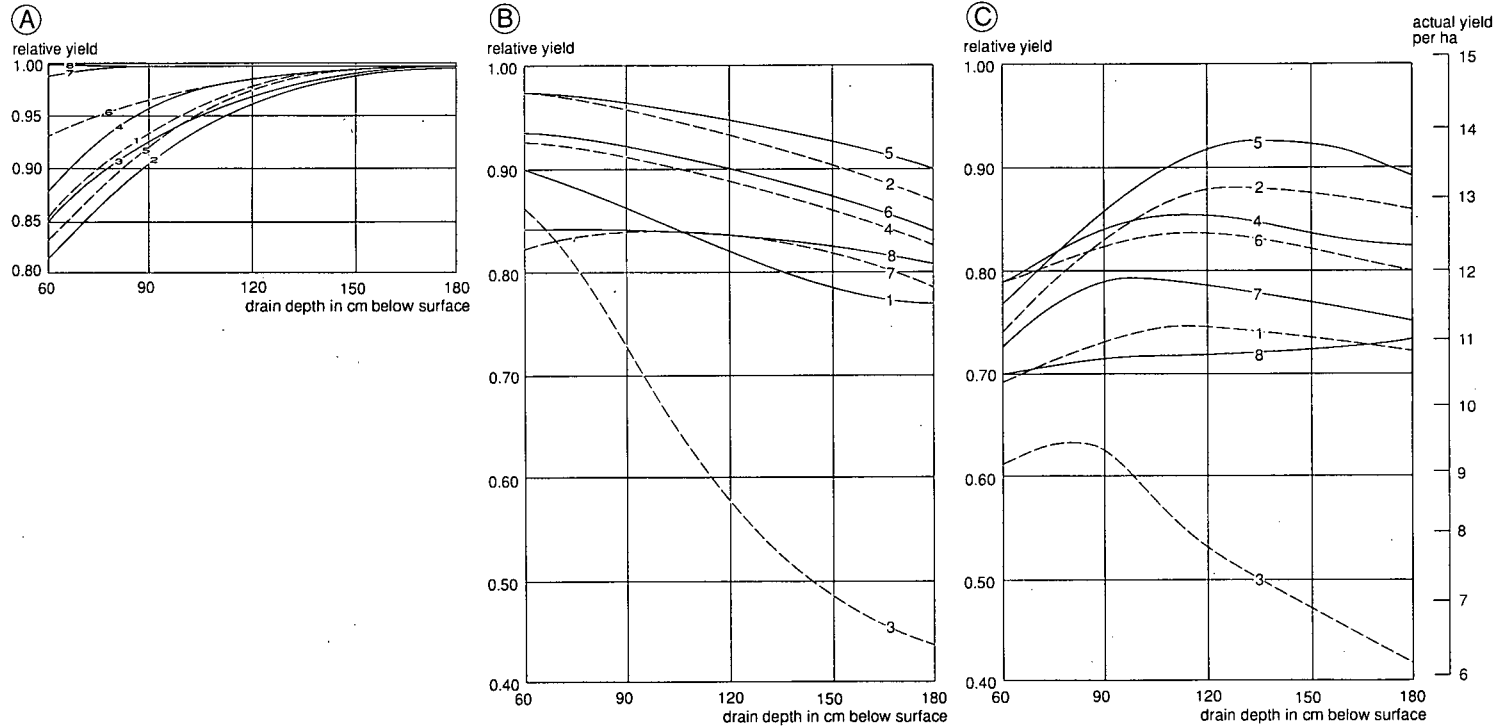

Figure 11.22 Drainage effects on potato yield based on a 30-year simulation for eight major soil types (Numbers 1-8) in relation to drain depth (after Feddes and Van Wijk 1990)

- A. Decrease in relative yield due to too wet soil conditions and delayed workability and emergence in spring;
- B. Decrease in relative yield due to moisture shortage during the growing season;
- C. Reduction in total relative yield, the combined effect of too wet soil conditions in spring and water shortage during the growing season

and hydraulic-conductivity characteristics were determined in the laboratory. The soils were: (1) a humus sand, (2) loamy sand, (3) peaty sand, (4) silty loam, (5) sandy loam, (6) loam, (7) silty clay loam, and (8) silty clay.

Figure 11.22A shows the effect of drain depth on the spring-reduced relative yield $Y_{\text{pot}}/Y_{\text{max}}$, averaged over the 30 simulated years. The most severe yield deficits occur at drain depths of 0.6 and 0.9 m in the sandy and loamy soils (Soils 1 to 5). The reductions are less pronounced for the loam soil (6), and almost absent for the clay soils (7-8). To avoid any risk of sub-optimum yields due to late planting on all soils, this simulation would lead to a recommended drain depth of 1.5 – 1.8 m.

Figure 11.22B shows the effect of drainage during the growing season on relative yield, $Y_{\text{act}}/Y_{\text{pot}}$. Yields are now decreasing with greater drain depths. This points to a general 'over-draining' for depths greater than 0.9 m. The greatest damage due to over-draining occurs on the peaty sand (3). Apart from the humus sand (1), which also seems somewhat susceptible to drought, the other soils show only a slight response to drain depth during the growing season.

Figure 11.22C shows the combined effect of drainage on the yield of the potatoes. We can draw the following conclusions:

- The optimum drainage depth depends strongly on the soil type. It varies from about 0.9 m for peaty sand (3) to about 1.3 – 1.4 m for sandy loam (5);
- The effect of soil wetness is most pronounced for the loamy sand (2) and sandy loam (5). Increasing the drain depth from 0.6 m to between 0.9 m and 1.2 m leads to a relative yield increase of the order of 10% for these soils. They have the highest unsaturated hydraulic conductivity under wet conditions and are characterized by an abrupt decrease in conductivity below a certain soil-water content upon drying. During wet conditions, they are thus subject to the largest capillary supply from the watertable (see Section 11.4.2);
- Heavier soils (6, 7, and 8) have a lower hydraulic conductivity and hence their response to increasing drainage depth is less pronounced;
- Except for the peaty sand (3), the effect of a too dry soil on overall drainage benefits is very small for drainage depths between 1.2 and 1.8 m.

The results of this study were used as the basis for a nationwide system to evaluate the effects of soil and drainage upon crop yields.

Example 11.4 Water Supply Plan in an Area with Surface Drainage

The economic feasibility of expanding the water supply for agriculture in a region in the north-eastern part of The Netherlands was investigated with the use of a special version of SWACROP (Werkgroep TUS-10-PLAN 1988; Van Bakel 1986). The region is intensively drained through a multiple-level canal system (Figure 11.23).

Figure 11.23 schematically shows that the water level in the main canals can be regulated via inlet and outlet structures. Water levels in the tertiary canals can be regulated in the same way. These tertiary canals drain the fields during the wet season. During the dry season, the inlet water infiltrates into the soil and creates better soil-water conditions in the rootzone (i.e. in the unsaturated zone) (see also Figure 11.20).

The region was divided into about 200 different combinations of soil type, hydrological properties, and land use. Each of these sets was modelled with the special version of SWACROP, which was extended with a module for manipulating the water

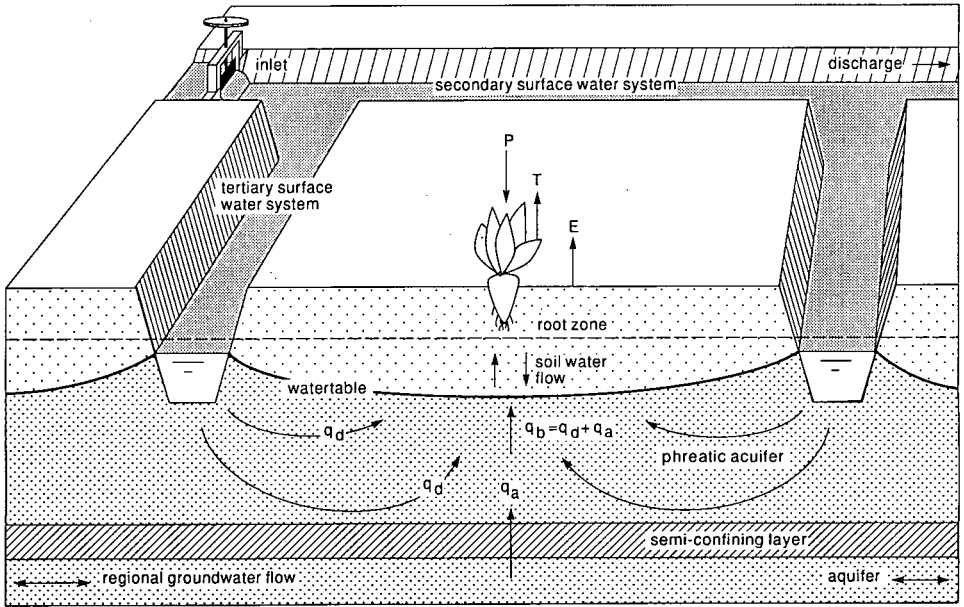

Figure 11.23 The modelled hydrological system in the water-supply plan in an area with intensive drainage (after Van Bakel 1986) (T). The lower boundary condition of the system was modelled as a Cauchy condition, the sum of the fluxes from the tertiary drainage system, q_d , and from the deep aquifer, q_a

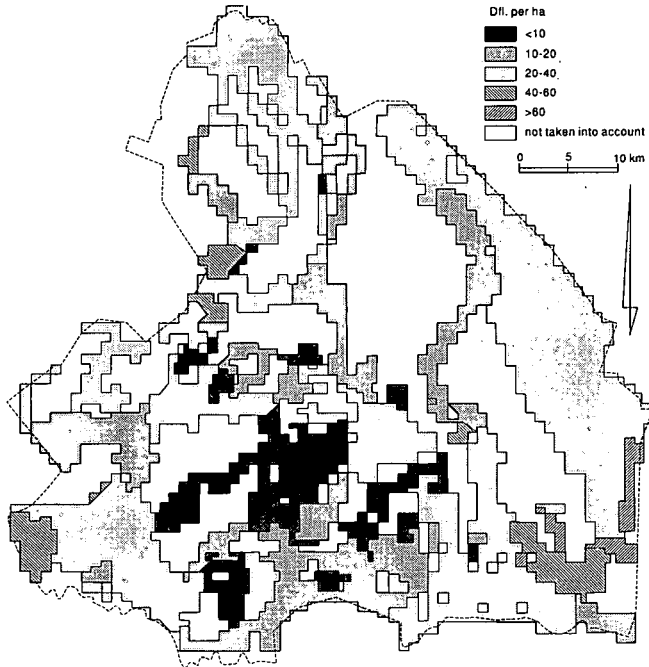

Figure 11.24 Simulated agricultural benefits of external water supply in the area with intensive drainage (after Werkgroep TUS-10-PLAN 1988); in Dutch guilders per hectare (1 DG = 0.5 US\$)

level in (drainage) canals. The effects upon actual transpiration of the water supply through drainage canals (sub-irrigation), combined with supplementary sprinkler irrigation, were calculated for each set, using meteorological data for the years 1954-1983.

Since actual transpiration is related to soil-water conditions by a water-uptake function (as was explained in Section 11.6), the simulation of unsaturated-zone dynamics played a major role in this study. The simulation results (i.e. crop yield and other agricultural benefits) were expressed in monetary terms. On this basis, areas that would benefit from a water supply through the existing system of drainage canals could be located. Different degrees of such benefits could even be distinguished (Figure 11.24).

Example 11.5 Drainage to Combat Waterlogging and Salinity in Pakistan

Boers et al. (1993) used simulation model SWATRE (which is the soil-water component of SWACROP) to calculate the best drainage design for an irrigated area in the Indus Plains of Pakistan. The area is characterized by a subtropical semi-arid climate, with hot summers and cool winters, and monsoon rainfall, with high inter-annual variability. Major problems in the area are a high watertable that frequently hampers crop production, and secondary soil salinity.

The authors calibrated the model on a representative field in the area. The upper boundary conditions were potential crop evaporation, and rainfall and irrigation data. The lower boundary conditions were the watertable depth and the existing drainage design. The discharge to drains was calculated according to the Hooghoudt Equation (Chapter 8). The calibration was done by using different sets of independently measured hydraulic soil properties and by varying the correction factor for bare soil evaporation. The model was considered calibrated when weekly measured soil-water tensions at 0.15 m intervals over a depth of 0-2.0 m corresponded almost completely with the simulated ones for two consecutive years.

The calibrated model was subsequently used to calculate actual transpiration and (de)salinization for different drain depths and widths. The calculations were performed for a low-rainfall year, a moderate-rainfall year, and a high-rainfall year, selected from the climatic records of a nearby meteorological station. The objective of the model calculations was to maximize actual crop transpiration (as a measure of yield) and to minimize the accumulation of salts in the rootzone.

The results indicated that the prevention of waterlogging during a wet monsoon was the most critical condition. Control of soil salinity appeared to be less critical.

Although these results are preliminary, the example shows that the simulation of water flow in unsaturated soils is capable of evaluating the influence of drainage design on vital conditions for crop production in areas prone to a combination of salinization and waterlogging.

References

- Bertuzzi, P., L. Bruckler, Y. Gabilly and J.C. Gaudu 1987. Calibration, field testing, and error analysis of a gamma-ray probe for in situ measurement of dry bulk density. *Soil Sci.*, 144, 6, pp. 425-436.
- Beven, K. and P. Germann 1982. Macropores and water flow in soils. *Water Resour. Res.*, 5, pp. 1311-1325.
- Boels, D., J.B.H.M. van Gils, G.J. Veerman and K.E. Wit 1978. Theory and system of automatic determination of soil moisture characteristics and unsaturated hydraulic conductivities. *Soil Sci.*, 126, pp. 191-199.
- Boers, Th. M., J. Beekma, Z.I. Raza and T.J. Kelleners 1993. Use of SWATRE in an irrigated field of the Indus Plains, Pakistan. Transactions of the 2nd ICID workshop on crop water models: water balance, crop water use and production. The Hague, September 1993. Winand Staring Centre.
- Bouma, J. 1992. Influence of soil macroporosity on environmental quality. *Advances in Agronomy* 46. Academic Press, pp. 1-37.
- Bouma, J., D.I. Hillel, F.D. Hole and C.R. Amerman 1971. Field measurement of hydraulic conductivity by infiltration through artificial crusts. *Soil Sci. Soc. Am. Proc.*, 35, pp. 362-364.
- Bronswijk, J.J.B. 1991. Magnitude, modeling and significance of swelling and shrinkage processes in clay soils. Thesis, Agricultural University Wageningen, 145 p.
- Bruce, R.R. and A. Klute 1956. The measurements of soil moisture diffusivity. *Soil Sci. Soc. Am. Proc.* 20, pp. 458-462.
- Bruckler, L. and J.C. Gaudu 1984. Use of the micropsychrometers for soil water potential measurements in the laboratory or in the field. *Agronomy*, 4, 2, pp. 171-182.
- Campbell, G.S. and G.W. Gee 1986. Water potential: miscellaneous methods. In: A. Klute and R.C. Dinauer (eds.), *Methods of soil analysis*. 2nd ed. Part 1. *Agronomy 9-1*. American Society of Agronomy, Madison, pp. 493-544.
- Cassel, D.K. and D.R. Nielsen 1986. Field capacity and available water capacity. In: A. Klute and R.C. Dinauer (eds.), *Methods of soil analysis*. 2nd ed. Part 1. *Agronomy 9-1*. American Society of Agronomy, Madison, pp. 493-544.
- Clothier, B.E. and I. White 1981. Measurement of sorptivity and soil water diffusivity in the field. *Soil Sci. Soc. Am. J.*, 45, pp. 241-245.
- De Jong, R. and P. Kabat 1990. Modelling water balance and grass production. *Soil Sci. Soc. Am. J.*, 54, pp. 1725-1732.
- Dean, T.J., J.P. Bell and A.J.B. Baty 1987. Soil moisture measurements by an improved capacitance technique. Part I. Sensor design and performance. *J. of Hydrol.*, 93, pp. 67-78.
- Dirksen, C. 1975. Determination of soil water diffusivity by sorptivity measurements. *Soil Sci. Soc. Am. Proc.*, 39, pp. 22-27.
- Feddes, R.A., P. Kabat, P.J.T. van Bakel, J.J.B. Bronswijk and J.M. Halbertsma 1988. Modelling soil water dynamics in the unsaturated zone state of the art. *J. of Hydrol.*, 100, pp. 69-111.
- Feddes, R.A. and A.L.M. van Wijk 1990. Dynamic land capability model: a case history. *Philosophical Transaction Royal Society London*, B 329, pp. 411-419.
- Feddes, R.A., M. Menenti, P. Kabat and W.G.M. Bastiaansen 1993a. Is large scale inverse modelling of unsaturated flow with areal average evaporation and surface soil moisture from remote sensing feasible? *J. of Hydrol.*, 143, pp. 125-152.
- Feddes, R.A., G.H. Rooij, J.C. van Dam, P. Kabat, P. Droogers and J.N.M. Stricker 1993b. Estimation of regional effective hydraulic parameters by inverse modelling. In: D. Ruso and G. Dagan (eds.), *Water flow and solute transport in soils: modelling and applications*. Springer Verlag, Berlin, pp. 211-231.
- Gardner, H. 1986. Water content. In: A. Klute and R.C. Dinauer (eds.), *Methods of soil analysis*. Part 1. *Agronomy 9-1*. American Society of Agronomy, Madison, pp. 493-544.
- Green, R.E., L.R. Ahuja and S.K. Chong 1986. Hydraulic conductivity, diffusivity and sorptivity of unsaturated soils: field methods. In: A. Klute and R.C. Dinauer (eds.), *Methods of soil analysis*. 2nd ed. Part 1. *Agronomy 9-1*. American Society of Agronomy, Madison, pp. 771-798.
- Gurr, C.G. and B. Jakobsen 1978. Gamma probe for measurement of field bulk density and water content. In: W.W. Emerson, R.O. Bond and A.R. Dexter (eds), *Modification of soil structure*. Wiley, Chichester, pp. 127-133.
- Halbertsma, J.M., C. Przybyla and A. Jacobs 1987. Application and accuracy of a dielectric soil water content meter. *Proc. Int. Conf. Measurement of Soil and Plant Water Status*, Logan, Vol. 1, pp. 11-15.
- Heimovaara, T.J. and W. Bouten 1990. A computer-controlled 36-channel time domain reflectometry system for monitoring soil water contents. *Water Res. Res.*, 26, pp. 2311-2316.

- Hendrickx, J.M.H., L.W. Dekker, M.H. Bannink and H.C. Van Ommen 1988. Significance of soil survey for agrohydrological studies. *Agric. Water Manage.*, 14, 1/4, pp. 195-208.
- Hilhorst, M.A. 1984. A sensor for determination of the complex permittivity of materials as a measure for moisture content. In: P. Bergveld (ed.), *Sensors and actuators*. Twente University of Technology, Enschede, pp. 79-84.
- Hilhorst, M.A. 1986. Device for measuring moisture tension of a substrate. European patent pending no. 86202367.
- Hillel, D., V.D. Krentos and Y. Stylianou 1972. Procedure and test of an internal drainage method for measuring soil hydraulic characteristics in situ. *Soil Sci.*, 114, pp. 395-400.
- Hoogmoed, W.B. and J. Bouma 1980. A simulation model for predicting infiltration into cracked clay soil. *Soil Sci. Soc. Am. J.*, 44, pp. 458-461.
- Hopmans, J.W. 1987. A comparison of various methods to scale soil hydraulic properties. *J. of Hydrol.*, 93, 3/4, pp. 241-256.
- Jury, W.D., D. Russo, G. Sposito and H. Elabo 1987. The spatial variability of water and solute transport properties in unsaturated soil. I. Analysis of property variation and spatial structure with statistical models. *Hilgardia* 55, 4, pp. 1-32.
- Kabat, P. and M.J.D. Hack-ten Broeke 1989. Input data for agrohydrological simulation models : some parameter estimation techniques. In: H.A.J. van Lanen and A.K. Bregt (eds.), *Application of computerized EC soil map and climate data*. Commission of the European Communities, Report EUR 12039 EN, pp. 45-62.
- Kabat, P., B.J. van den Broek and R.A. Feddes 1992. SWACROP : A water management and crop production simulation model. *ICID bulletin*, 41, 2, pp. 61-84.
- Kabat, P., B. Marshall and B.J. van den Broek 1994. Comparisons of the parameterization and calibration scheme's related to the performance of the models. In: Kabat et al. (ed.): *Modelling of water dynamics, evaporation and plant growth with special reference to potato crop*. Wageningen Press, 450 p.
- Klute, A. and R.C. Dinauer (eds.) 1986. *Methods of soil analysis. Part I*. 2nd ed. Agronomy 9-1, American Society Agronomy, Madison, 1182 p.
- Klute, A. and C. Dirksen 1986. Hydraulic conductivity and diffusivity : laboratory methods. In: A. Klute and R.C. Dinauer (eds.), *Methods of soil analysis, Part 1*. 2nd ed. Agronomy 9-1. American Society Agronomy, Madison, pp. 687-734.
- Kool, J.B. and J.C. Parker 1987. Development and evaluation of closed-form expressions for hysteretic soil hydraulic properties. *Water Resour. Res.*, 23, 1, pp. 105-114.
- Kool, J.B., J.C. Parker and M.Th. van Genuchten 1987. Parameter estimation for unsaturated flow model: a review. *J. Hydrol.* 91, pp. 255-293.
- Libardi, P.L., K. Reichardt, D.R. Nielsen and J.W. Biggar 1980. Simple field methods for estimating soil hydraulic conductivity. *Soil Sci. Soc. Am. J.*, 44, pp. 3-7.
- Lomen, D.O. and A.W. Warrick 1978. Time-dependent solutions to the one-dimensional linearized moisture flow equation with water extraction. *J. Hydrol.*, 39, 1-2, pp. 59-67.
- Mualem, Y. 1976a. A catalogue of the hydraulic properties of soils. Project 442. Institute of Technology, Haifa.
- Mualem, Y. 1976b. A new model for predicting the hydraulic conductivity of unsaturated porous media. *Water Resour. Res.*, 12, pp. 513-522.
- Phene, C.J., Ch.P. Alle and J. Pierro 1987. Measurement of soil matric potential and real time irrigation scheduling. In: W.R. Gardner (ed.), *Proceedings International Conference on measurements of soil and plant water status*, Utah State University, Logan, pp. 258-265.
- Prasad, R. 1988. A linear root water uptake model. *J. Hydrol.*, 99, pp. 297-306.
- Topp, G.C., Davis, J.L. and A.P. Annan 1980. Electromagnetic determination of soil water content : measurements in coaxial transmission lines. *Water Resour. Res.*, 16, pp. 574-582.
- Topp, G.C. and Davis, J.L. 1985. Measurement of soil water using time-domain reflectometry (TDR) : field evaluation. *Soil Sci. Soc. Am. J.*, 49, pp. 19-24.
- Van Bakel, P.J.T. 1986. A systematic approach to improve the planning, design and operation of regional surface water management systems: a case study. Institute Land and Water Management Research, Report 13, Wageningen, 118 p.
- Van den Elsen, H.G.M. and J.W. Bakker 1992. A universal device to measure the pressure head for laboratory use or long-term stand-alone field use. *Soil Sci.*, 154, 6, pp. 458-464.
- Van Genuchten, M. Th. 1980. A closed-form equation for predicting the hydraulic conductivity of unsaturated soils. *Soil Sci. Am. J.*, 44, pp. 892-898.

- Van Genuchten, M.Th., F. Kaveh, W.B. Russel and S.R. Yates 1989. Direct and indirect methods for estimating the hydraulic properties of unsaturated soils. In: J. Bouma and A.K. Bregt (eds.), Land qualities in space and time. PUDOC, Wageningen, pp. 61-73.
- Van Genuchten, M.Th., F.J. Leij and S.R. Yates 1991. The RETC code for quantifying the hydraulic functions of unsaturated soils. U.S. Environmental Protection Agency, ADA, EPA/600/2-91/065, 85 p.
- Vereecken, H., J. Diels, J. Orshoven, J. Bouma 1992. Functional evaluation of pedotransfer functions for the estimation of soil hydraulic properties. Soil Sci. Soc. Am. J., 56, 5, pp. 1371-1378.
- Wesseling, J.G. 1991. CAPSEV : steady state moisture flow theory, program description and user manual. Winand Staring Centre, Report 37, Wageningen, 51 p.
- Werkgroep TUS-10-PLAN 1988. Water voor Drenthe. Rapport van de werkgroep TUS-10-PLAN, Provinciaal Bestuur van Drenthe, Assen, 101 p.
- Wösten, J.H.M. 1987. Beschrijving van de waterretentie- en doorlatenheids-karakteristieken uit de Staringreeks met analytische functies. Rapport Stichting voor Bodemkartering, 2019, Wageningen, 54 p.
- Wösten, J.H.M., M.H. Bannink and J. Bouma 1987. Land evaluation at different scales : you pay for what you get. Soil Surv. Land Eval., 7, pp. 13-14.
- Wösten, J.H.M. and M.Th. van Genuchten 1988. Using texture and other soil properties to predict the unsaturated soil hydraulic functions. Soil Sci. Soc. Am. J., 52, pp. 1762-1770.
- Yates, S.R., M.Th. Van Genuchten, A.W. Warrick and F.J. Leij 1992. Analysis of measured, predicted and estimated hydraulic conductivity using the RETC computer program. Soil Sci. Soc. Am. J., 56, pp. 347-354.

12 Determining the Saturated Hydraulic Conductivity

R.J. Oosterbaan¹ and H.J. Nijland²

12.1 Introduction

The design and functioning of subsurface drainage systems depends to a great extent on the soil's saturated hydraulic conductivity (K). All drain spacing equations make use of this parameter. To design or evaluate a drainage project, we therefore have to determine the K-value as accurately as possible.

The K-value is subject to variation in space and time (Section 12.3), which means that we must adequately assess a representative value. This is time-consuming and costly, so a balance has to be struck between budget limitations and desired accuracy. As yet, no optimum surveying technique exists. Much depends on the skill of the person conducting the survey.

To find a representative K-value, the surveyor must have a knowledge of the theoretical relationships between the envisaged drainage system and the drainage conditions in the survey area. This will be discussed in Section 12.4.

Various methods have been developed to determine the K-value of soils. The methods are categorized and briefly described in Section 12.5, which also summarizes the merits and limitations of each method.

Which method to select for the survey of K depends on the practical applicability, and the choice is limited. Two widely used small-scale in-situ methods are presented in Section 12.6.

Because of the variability of the soil's K-value, it is better to determine it from large-scale experiments (e.g. from the functioning of existing drainage systems or from drainage experimental fields), rather than from small-scale experiments. Section 12.7 presents examples under some of the more common flow conditions in large-scale experiments.

12.2 Definitions

The soil's hydraulic conductivity was defined in Chapter 7 as the constant of proportionality in Darcy's Law

$$v = -K \frac{dh}{dx} \quad (12.1)$$

where

v = apparent velocity of the groundwater (m/d)

K = hydraulic conductivity (m/d)

h = hydraulic head (m)

x = distance in the direction of groundwater flow (m)

¹ International Institute for Land Reclamation and Improvement

² Rijkswaterstaat, Directorate Flevoland

In Darcy's Equation, dh/dx represents the hydraulic gradient (s), which is the difference of h over a small difference of x . Hence, the hydraulic conductivity can be expressed as

$$K = \frac{v}{s} \quad (12.2)$$

and can thus be regarded as the apparent velocity (m/d) of the groundwater when the hydraulic gradient equals unity ($s = 1$).

In practice, the value of the hydraulic gradient is generally less than 0.1, so that v is usually less than $0.1K$. Since the value of K is also usually less than 10 m/d, it follows that v is almost always less than 1 m/d.

The K -value of a saturated soil represents its average hydraulic conductivity, which depends mainly on the size, shape, and distribution of the pores. It also depends on the soil temperature and the viscosity and density of the water. These aspects were discussed in Chapter 7.

In some soils (e.g. structureless sandy sediments), the hydraulic conductivity is the same in all directions. Usually, however, the value of K varies with the direction of flow. The vertical permeability of the soil or of a soil layer is often different from its horizontal permeability because of vertical differences in texture, structure, and porosity due to a layered deposition or horizon development and biological activity. A soil in which the hydraulic conductivity is direction-dependent is anisotropic (Chapter 3).

Anisotropy plays an important role in land drainage, because the flow of groundwater to the drains can, along its flow path, change from vertical to horizontal (Chapter 8). The hydraulic conductivity in horizontal direction is indicated by K_h , in vertical direction by K_v , and in an intermediate direction, especially in the case of radial flow to a drain, by K_r . The value of K_r for radial flow is often computed from the geometric, or logarithmic, mean of K_h and K_v (Boumans 1976)

$$K_r = \sqrt{K_h K_v} \quad (12.3)$$

or

$$\log K_r = \frac{\log K_h + \log K_v}{2} \quad (12.4)$$

Examples of K_h and K_v values determined in core samples are shown in Figure 12.1.

12.3 Variability of Hydraulic Conductivity

12.3.1 Introduction

The K -value of a soil profile can be highly variable from place to place, and will also vary at different depths (spatial variability). Not only can different soil layers have different hydraulic conductivities (Section 12.3.3), but, even within a soil layer, the hydraulic conductivity can vary (Section 12.3.2).

In alluvial soils (e.g. in river deltas and valleys), impermeable layers do not usually occur at shallow depth (i.e. within 1 or 2 m). In subsurface drainage systems in alluvial



Figure 12.1 Core samples from laminated tidal flat deposits with different K-values (m/d) in horizontal (K_h) and vertical (K_v) direction (Wit 1967). From left to right:

K_h (m/d)	5.0	5.5	8.1	5.0
K_v (m/d)	2.5	0.9	8.2	1.4

soils, therefore, not only the K-values at drain depth are important, but also the K-values of the deeper soil layers. This will be further discussed in Section 12.4.

Soils with layers of low hydraulic conductivity or with impermeable layers at shallow depth are mostly associated with heavy, montmorillonitic or smectitic clay (Vertisols), with illuviated clay in the sandy or silty layer at 0.5 to 0.8 m depth (Planosols), or with an impermeable bedrock at shallow depth (Chapter 3).

Vertisols are characterized by a gradually decreasing K-value with depth because the topsoil is made more permeable by physical and biological processes, whereas the subsoil is not. Moreover, these soils are subject to swelling and shrinking upon wetting and drying, so that their K-value is also variable with the season, being smaller during the humid periods when drainage is required. Seasonal variability studies are therefore important (Section 12.3.4). If subsurface drains are to be installed, the K-values must be measured during the humid period. If subsurface drainage of these soils is to be cost-effective, the drains must be installed at shallow depth (< 1 m).

Planosols can occur in tropical climates with high seasonal rainfalls. Under such conditions, a high drainage capacity is required and, if the impermeable layer is shallower than approximately 0.8 m, the cost-effectiveness of subsurface drainage becomes doubtful.

Soil salinity, sodicity, and acidity also have a bearing on the hydraulic conductivity (Section 12.3.5).

The variations in hydraulic conductivity and their relationship with the geomorphology of an area is discussed in Section 12.3.6.

12.3.2 Variability Within Soil Layers

Measured K-values of a soil often show a log-normal distribution with a wide variation (Dieleman and Trafford 1976). Figure 12.2 shows a plot of the logarithm of K-values

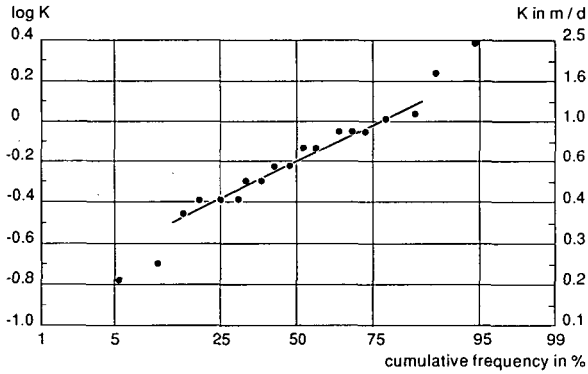

Figure 12.2 The cumulative log-normal frequency distribution of K-values measured according to the auger-hole method in an area of 100 ha in a coastal valley of Peru

against the cumulative frequency on normal probability paper. The data were collected with the auger-hole method in an area of about 100 ha in a coastal valley of Peru, which has sandy loam soils and a watertable at a depth of about 2 m. The figure shows that, except for the two highest and lowest observations, the data obey the log-normal distribution.

A representative value of K may be found from the geometric mean

$$K^* = \sqrt[n]{K_1 \times K_2 \times \dots \times K_n} \quad (12.5)$$

where

n = total number of observations

Taking the log value of K^* , we find from Equation 12.5 that

$$\log K^* = \frac{\log K_1 + \log K_2 + \dots + \log K_n}{n} \quad (12.6)$$

From this equation, we can see that $\log K^*$ is the arithmetic mean of the $\log K$ -values. This corresponds to the mean value of the log-normal distribution (Chapter 6).

The K-values in Figure 12.2 range from 0.1 to 2.5 m/d and have a standard deviation of 0.6 m/d. The arithmetic mean is 0.8 m/d, and the modal and median values, as well as the geometric mean, are 0.6 m/d. This illustrates the characteristic that, in a log-normal distribution, the geometric mean, the mode, and the median are the same and that these values correspond to the mode and median of the original distribution of the K-values (i.e. without taking their logarithms). The representative K-value of a soil layer can therefore be found simply as the modal or the median value of the frequency distribution of the observed K-values without log-transformation.

Bouwer and Jackson (1974) conducted electric model tests with randomly distributed electric resistances to represent randomly varied K-values, and found that the geometric mean gave the most representative value. Bentley et al. (1989), however, using the finite element method to determine the effect of the variation in K-values on the drawdown of the watertable between drains, concluded that the best estimate would be the average of the arithmetic mean and the geometric mean.

The standard deviation of the observed K-values depends on the method of determination. This will be discussed in Section 12.6.

12.3.3 Variability Between Soil Layers

When a soil shows a distinct layering, it is often found that the K-values of the layers differ. Generally, the more clayey layers have a lower K-value than the more sandy layers, but this is not always true (Section 12.6.2).

The representative value of K in layered soils depends on the direction of flow of the groundwater. When the water flows parallel to the soil layers, the representative value is based on a summation of the hydraulic transmissivities of the layers, but, when the water flows perpendicular to the layers, one uses a summation of the hydraulic resistances of the layers. This was explained in Chapter 7, and the results are summarized below.

The total transmissivity of soil layers for flow in the direction of the layers is calculated as

$$K^*D_t = \sum_{i=1}^n K_i D_i \quad (12.7)$$

where

K^* = weighted average K-value of the soil layers (m/d)

D_t = total thickness of the soil layers (m)

i = number of the soil layer

n = total number of soil layers

The value $K_i D_i$ represents the hydraulic transmissivity for flow (m^2/d) of the i -th soil layer.

It can be seen from Equation 12.7 that the hydraulic transmissivities of soil layers are additive when the flow occurs in the direction of the layers. It is also seen that, with such flow, the representative value K^* of soil layers can be calculated as a weighted mean of the K-values, with the thickness D used as the weighting factor.

Using the same symbols as Equation 12.7, we can calculate the total resistance of soil layers to vertical flow as

$$\frac{D_t}{K^*} = \sum_{i=1}^n \frac{D_i}{K_i} \quad (12.8)$$

where the value D/K represents the hydraulic resistance (c) to vertical flow (Chapter 2).

It can be seen from Equation 12.8 that, when the flow occurs perpendicular to the layers, the hydraulic resistances of soil layers are additive. Comparing Equations 12.7 and 12.8, we can readily verify that the K^* -value for horizontal flow in soil layers is determined mainly by the layers with the highest K-values, whereas the K^* -value for vertical flow in horizontal layers is mainly determined by the layers with the lowest K-values, provided that the soil layers are not too thin.

12.3.4 Seasonal Variability and Time Trend

The K-values of the topsoil are often subject to changes with time, which can be seasonal variations or time trends. This is due to the drying of the topsoil during a dry season or after the introduction of drainage. The K values of the subsoil are less time-variable, because they are less subject to drying and wetting, and biological processes are also less pronounced.

The seasonal variability occurs mainly in clay soils with swelling and shrinking properties. Those soils often contain large fractions of montmorillonitic or smectitic clay minerals. Their swelling or shrinking then follows the periodicity of the wet and dry seasons.

The time trend may be observed in soils with a high clay or organic fraction. This is due to long-term changes in soil structure and porosity, which depend to a great extent on the prevailing soil-water conditions and are closely related to subsidence (Chapter 13). When drained, these soils are on the average drier than before, which affects their biological conditions or leads to the decay of organic material. Clay soils often show an increased K-value when drained (e.g. Van Hoorn 1958; Kuntze 1964; El-Mowelhi and Van Schilfgarde 1982) because of increased biological activity, leading to an improved soil structure. The increase can be dramatic when the soils are reclaimed unripened marine sediments. In the Yssel Lake polders of The Netherlands, the K-value of the soil was found to increase from almost zero at the time the new polders were just falling dry, to more than 10 m/d several years after the installation of subsurface drains. Soils with organic material, on the other hand, may show a decreased K-value because of the loss of the organic material that is responsible for their structural stability.

12.3.5 Soil Salinity, Sodicity, and Acidity

Soil salinity usually has a positive influence on the hydraulic conductivity, especially in clay soils. Upon reclamation, saline soils may become less permeable. (The process of soil salinization and reclamation techniques will be treated in Chapter 15.)

Sodic soils experience a dispersion of soil particles and a deterioration in the structure, resulting in poor K-values. Sodic soils are formed when sodium-carbonates are present in the soil or are introduced with the irrigation water (Ayers and Westcott 1985). The deteriorating effect of sodium is most pronounced in the top layers of non-saline clay soils with expandable clay minerals such as montmorillonites and smectites (Richards 1954). Careless agricultural practices on such top layers, or overgrazing on them, worsens the situation (Abrol et al. 1988). (Sodification and the reclamation of sodic soils will be further discussed in Chapter 15.)

Acid soils are usually associated with high K-values. The top layers of Latosols, for example, formed by excessive leaching, as happens in the high-rainfall tropical zones, have lost many of their clay and silt particles and their base ions, so that an acid, infertile, sandy soil with a low base saturation, but a high K-value, remains. Older acid sulphate soils, which developed upon the reclamation of coastal mangrove plains, are also reported to have a good structural stability and high K-values (Scheltema and Boons 1973).

12.3.6 Geomorphology

In flood plains, the coarser soil particles (sand and silt) are deposited as levees near the river banks, whereas the finer particles (silt and clay) are deposited in the back swamps further away from the river. The levee soils usually have a fairly high K-value (from 2 to 5 m/d), whereas the basin soils have low K-values (from 0.1 to 0.5 m/d). River beds often change their course, however, so that the pattern of levee and basin soils in alluvial plains is often quite intricate. In addition, in many basin soils, one finds organic material at various depths, which may considerably increase their otherwise low K-value. The relationship between K-value and geomorphological characteristics is therefore not always clear.

12.4 Drainage Conditions and Hydraulic Conductivity

12.4.1 Introduction

To determine a representative value of K, the surveyor must have a theoretical knowledge of the relationships between the kind of drainage system envisaged and the drainage conditions prevailing in the survey area. For example, the surveyor must have some idea of the relationship between the effectiveness of drainage and such features as:

- The drain depth and the K-value at this depth;
- The depth of groundwater flow and the type of aquifer;
- The variation in the hydraulic conductivity with depth;
- The anisotropy of the soil.

Aquifers are classified according to their relative permeability and the position of the watertable (Chapter 2). The properties of unconfined and semi-confined aquifers will be discussed in the following sections.

12.4.2 Unconfined Aquifers

Unconfined aquifers are associated with the presence of a free watertable, so the groundwater can flow in any direction: horizontal, vertical, and/or intermediate between them. Although the K-values may vary with depth, the variation is not so large and systematic that specific layers need or can be differentiated.

For drainage purposes, unconfined aquifers can be divided into shallow aquifers, aquifers of intermediate depth, and deep aquifers. Shallow unconfined aquifers have a shallow impermeable layer (say at 0.5 to 2 m below the soil surface). Intermediate unconfined aquifers have impermeable layers at depths of, say, from 2 to 10 m below the soil surface. Deep unconfined aquifers have their impermeable layer at depths ranging from 10 to 100 m or more.

Shallow Unconfined Aquifers

The flow of groundwater to subsurface drains above a shallow impermeable layer is mainly horizontal and occurs mostly above drain level (Figure 12.3). In shallow

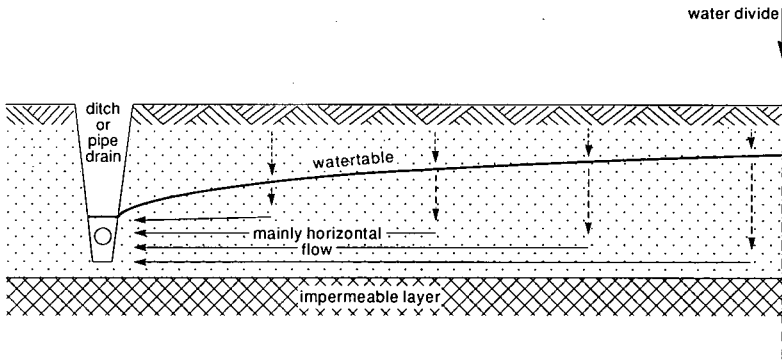

Figure 12.3 Flow of groundwater to subsurface drains in shallow unconfined aquifers

unconfined aquifers, it usually suffices to measure the horizontal hydraulic conductivity of the soil above drain level (i.e. K_a). The recharge of water to a shallow aquifer occurs only as the percolation of rain or irrigation water; there is no upward seepage of groundwater nor any natural drainage. Since the transmissivity of a shallow aquifer is small, the horizontal flow in the absence of subsurface drains is usually negligible.

Unconfined Aquifers of Intermediate Depth

The flow of groundwater to subsurface drains in unconfined aquifers of intermediate depth is partly horizontal and partly radial (Figure 12.4). For such aquifers, it is important to know the horizontal hydraulic conductivity above and below drain level (i.e. K_a and K_b), as well as the hydraulic conductivity (K_r) in a radial direction to the drains, below drain level (Chapter 8). Although there is also vertical flow, the corresponding hydraulic resistance is mostly small and need not be taken into account.

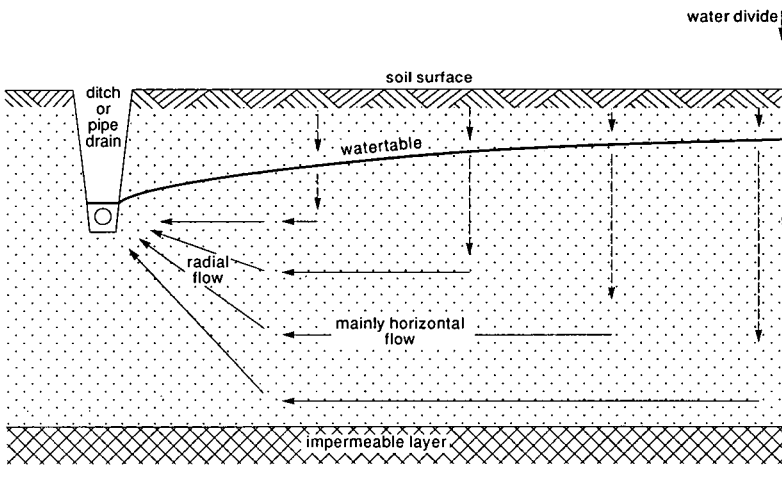

Figure 12.4 Flow of groundwater to subsurface drains in unconfined aquifers of intermediate depth

In similarity to the shallow unconfined aquifer, the recharge of water to an unconfined aquifer of intermediate depth consists mainly of the downward percolation of rain or irrigation water. Here, too, little upward seepage or natural drainage of groundwater occurs, and the horizontal flow in the absence of subsurface drains is negligibly small compared to the vertical flow.

Deep Unconfined Aquifers

The groundwater flow to subsurface drains in deep unconfined aquifers is mainly radial towards the drains, and the hydraulic resistance takes place mainly below drain level. To determine the hydraulic conductivity for radial flow, we therefore have to know the horizontal (K_h) and the vertical hydraulic conductivity (K_v) of the soil below drain depth (See Equations 12.3 and 12.4).

The recharge consists of deep percolation from rain or irrigation, but at the same time there may be upward seepage of groundwater or natural drainage (Figure 12.5).

The seepage or natural drainage depends on the transmissivity of the aquifer and the geohydrological conditions (Chapter 9). For example, in sloping lands, there are often higher-lying regions where the natural drainage dominates and lower-lying regions where the seepage prevails, provided that the transmissivity of the aquifer is high enough to permit the horizontal transport of a considerable amount of groundwater over long distances (Figure 12.6).

When there is no upward seepage or natural drainage in deep unconfined aquifers, the depth to which the percolation water descends, before ascending again to subsurface drains, is limited, because otherwise the resistance to vertical flow becomes too large. When the soil is homogeneous and permeable to a great depth, the main part of drainage flow extends to depths of $0.15L$ to $0.25L$ (where L is the drain spacing) beneath the drain level. In most soils, however, the flow below drain level is limited by poorly permeable layers and/or by the anisotropy of the substrata, which is common in most alluvial soils (Smedema and Rycroft 1983). Hence, it is not necessary to determine the K -values at a depth greater than 10% of the drain spacing. This will be further discussed in Section 12.4.5.

When upward seepage of groundwater occurs, the depth to which the percolation water penetrates before ascending to the drains is further reduced (Figure 12.5B), but at the same time the seepage water comes from great depths. The percolation and seepage water join to continue as radial flow to the drains. The maximum depth for which K -values need to be known therefore corresponds to the same 10% of the drain spacing as mentioned above.

When, on the other hand, natural drainage to the underground occurs, not all of the percolating water will reach the drains. The zone of influence of the drains no longer equals half the drain spacing, but is less than that (Figure 12.5C). The maximum depth over which one needs to know the K -values is therefore less than 10% of the drain spacing. If the natural drainage is great enough, no artificial drainage is required at all, and no survey of K -values needs to be made.

An important characteristic of deep unconfined aquifers is that, when the watertable is lowered by a subsurface drainage system, this does not appreciably increase the seepage or reduce the natural drainage, unless a subsurface drainage system is installed in isolated small areas (Chapter 16). This is in contrast to the characteristics of semi-confined aquifers as will be discussed below.

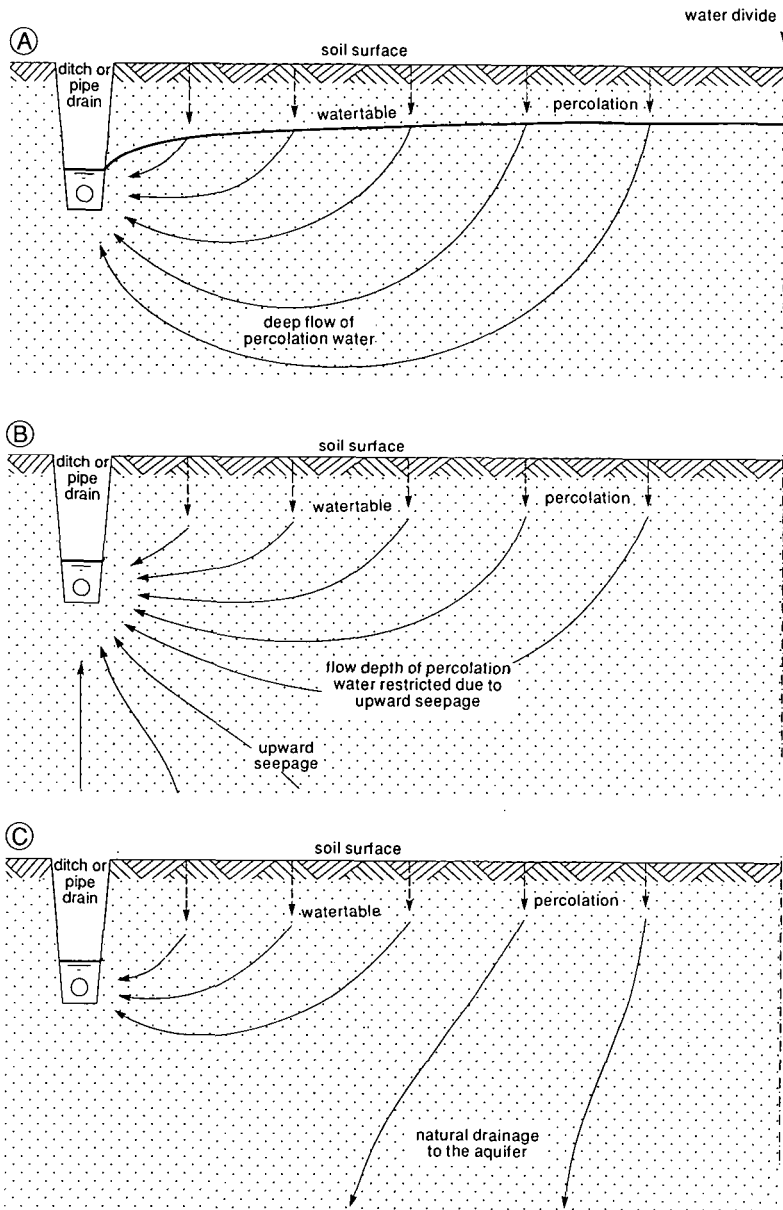

Figure 12.5 Flow of groundwater to subsurface drains in deep unconfined aquifers; A: No seepage and natural drainage; B: Seepage; C: Natural drainage

12.4.3 Semi-Confined Aquifers

Semi-confined aquifers are characterized by the presence of a pronounced layer with relatively low K -values (i.e. the aquitard) overlying the aquifer. Without drains, the

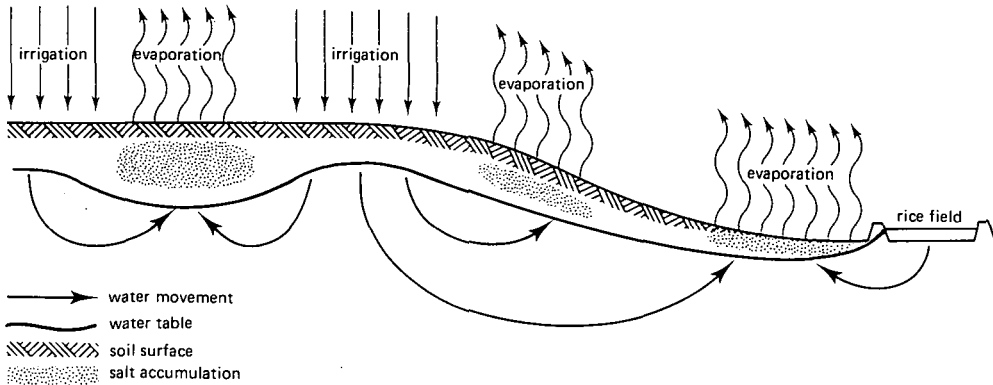

Figure 12.6 A deep unconfined aquifer with groundwater flow from a percolation zone towards a seepage zone

water flow in the aquitard is mainly vertical.

Semi-confined aquifers are common in river deltas and coastal plains, where slowly permeable clay soils overlie highly permeable sandy or even gravelly soils. Because of its relatively low K -value, the aquitard limits seepage from the aquifer, but at the same time it can maintain a large difference between the watertable in the aquitard and the piezometric level in the aquifer. Hence, if the aquitard is made more permeable by a drainage system and the watertable is lowered, the flow of water from aquifer into aquitard may increase considerably. This occurs especially when the aquitard is not very deep (say 2 to 3 m), and mainly in those parts of the drainage system situated at the upstream end of the aquifer.

As a consequence of the increased seepage at the upstream end, the discharge of the aquifer at the downstream end is often reduced, compared with the situation before drainage (Figure 12.7).

In other words, the upstream drains have intercepted part of the aquifer discharge; they have lowered the watertable in the aquifer downstream, and have reduced the seepage downstream. If we know the transmissivity of the aquifer and the hydraulic resistance of the aquitard, we can calculate the amount of intercepted groundwater. (Methods to determine these hydraulic characteristics were presented in Chapter 10.)

The aquitard may reach the soil surface, or remain below it (Figure 12.8). If the aquitard is below the soil surface, the semi-confined aquifer is more complex because there is an unconfined aquifer above it. (The unconfined aquifer in Figure 12.8 is sometimes called a 'leaky aquifer'.) In this case, subsurface drainage should rather be seen as drainage of an unconfined aquifer, whereby the horizontal conductivity of the aquitard is taken as $K_h = 0$, but the vertical conductivity as $K_v > 0$. As a consequence, the drainage conditions discussed in Section 12.4.2 remain applicable, except that a lowering of the watertable by subsurface drainage may possibly increase the upward seepage of groundwater (Figure 12.8A).

A semi-confined aquifer need not always have overpressure and seepage. In the southern part of the Nile Delta, for example, the piezometric level in the semi-confined aquifer is below the watertable in the aquitard (Figure 12.8B), which indicates the presence of natural drainage instead of upward seepage (Amer and De Ridder 1989).

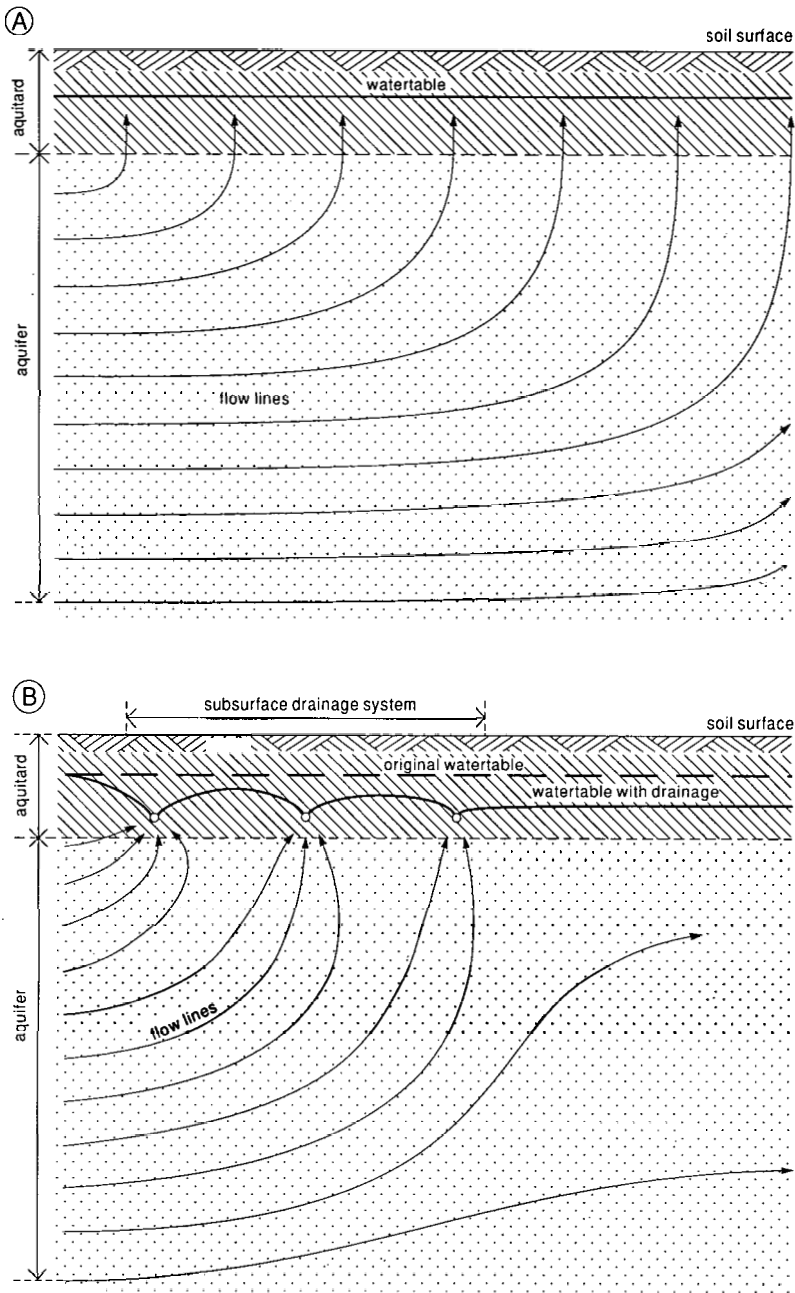

Figure 12.7 A semi-confined aquifer with groundwater flow; A: Before drainage, and B: After drainage, showing an interception effect

In such cases, the zone of influence of subsurface drains is less than half the drain spacing and the flow of percolation water to the drains, if occurring at all, reaches less deep. Consequently, the K-value need not be surveyed at great depth, unless the

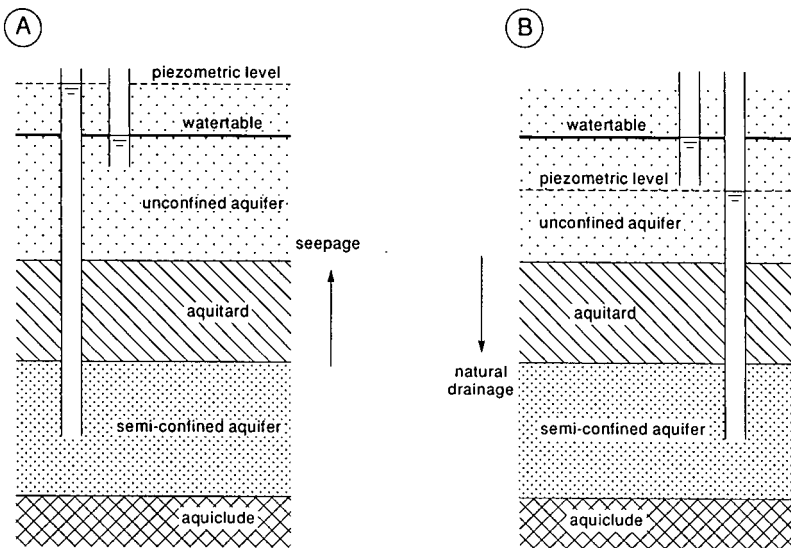

Figure 12.8 A semi-confined aquifer overlain by an unconfined aquifer; A: Seepage; B: Natural drainage

drainage project is associated with the introduction of irrigation, which will involve the supply of considerable amounts of water and which will change the hydrological conditions.

12.4.4 Land Slope

If the drained land has a certain slope, the zone of influence in upslope direction of the drains is greater than half the drain spacing, whereas in downstream direction it is less (Figure 12.9). In deep unconfined aquifers, this results in a deeper flow of the groundwater to the drains at their upstream side compared with the situation of

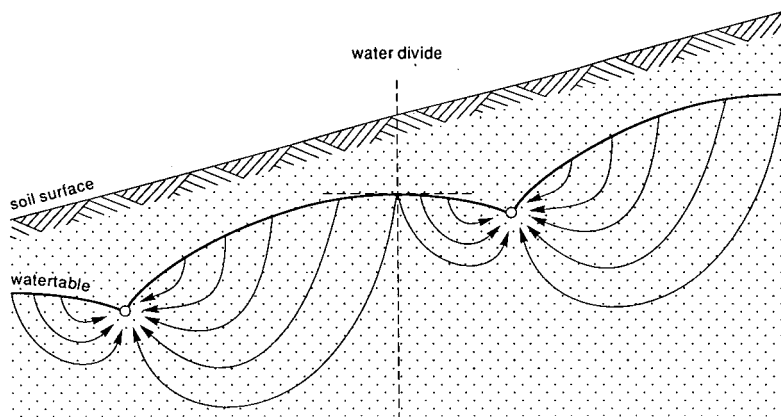

Figure 12.9 Subsurface drainage of a deep unconfined aquifer in sloping land

zero slope, whereas at the downstream side the reverse is true (Oosterbaan and Ritzema 1992). In sloping lands, therefore, we have to know the value of K to a greater depth than in flat land.

12.4.5 Effective Soil Depth

In a system of subsurface drains, the effective soil depth over which the K -value should be known depends on the depth of the impermeable layer and the sequence of the layers with higher and lower K -values, as was illustrated in the previous sections. In the following sections, examples are given to clarify the concept of the effective soil depth a little further.

Example 12.1 The Effective Soil Depth of a Homogeneous Deep Unconfined Aquifer

Figure 12.10 presents the pattern of equipotential lines and streamlines in a deep homogeneous soil to a field drain, for two different cases. As was discussed in Chapter 7, each square in a flow-net diagram represents the same amount of flow. By counting the number of squares above and below a certain depth, we can estimate the percentage of flow occurring at a certain moment above and below that depth. The result of the counting is given in Table 12.1.

Table 12.1 shows that 75% of the total flow at a certain time occurs above a depth $z = 0.05L$, where L is the drain spacing. In shallower soils, this fraction will even be more. So, for spacings of $L = 10$ m, by far the greater part of the total flow is found above a depth of 0.5 m below drain level and, for spacings of $L = 100$ m,

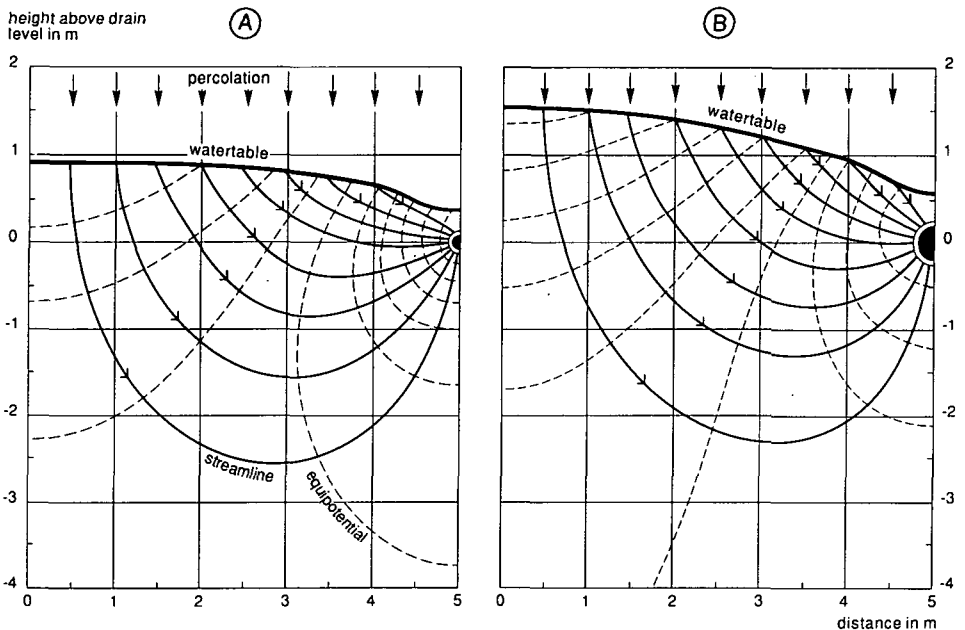

Figure 12.10 Equipotentials and streamlines of groundwater flow to drains in deep homogeneous soils
A: small diameter drain, large K ; B: large diameter drain, small K (Childs 1943)

Table 12.1 Count of squares in Figure 12.10

Depth (z) below drain level in % of spacing (L)	Number of squares above z in % of total number of squares	
	Figure 12.10A	Figure 12.10B
5	74	76
10	88	87
15	94	93
25	98	97

this depth is still only 5 m. From this analysis, we can deduce that the hydraulic conductivity of the soil layers just above and below drain level is of paramount importance. This explains why, in deep homogeneous soils, K-values determined with

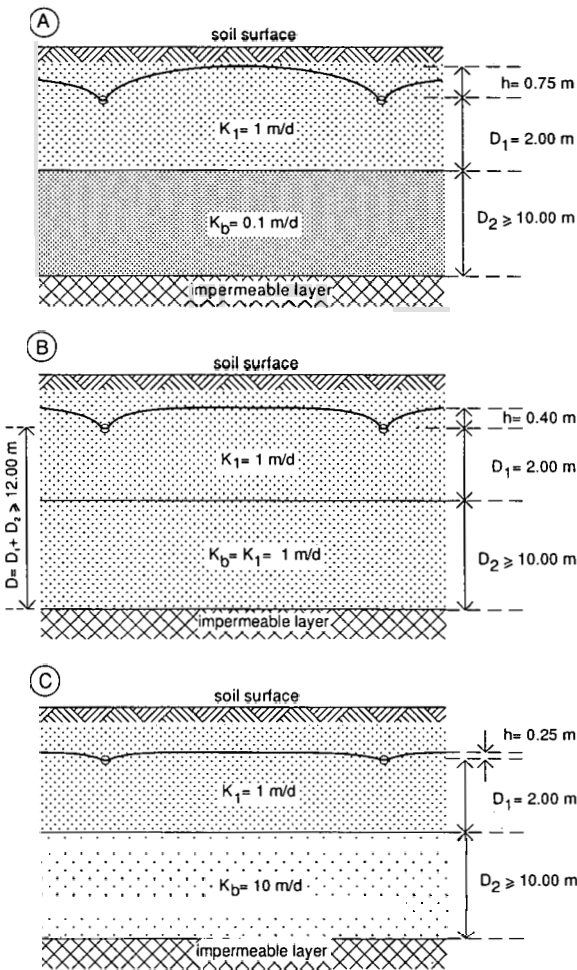

Figure 12.11 Drainage cases with different soil profiles (Example 12.2)

Table 12.2 Calculations of h for three soil profiles with data from Example 12.2

Situation	Hydraulic conductivity K_b (m/d)	Drainage equation (Chapter 8)	Hydraulic head h (m)
A	0.1	Hooghoudt, with the lower soil layer as the impermeable base; equivalent depth $d = 1.72$ m	0.75
B	1	Hooghoudt, with $K = K_t = K_b$, $D > 12$ m and $d = 3.74$ m	0.40
C	10	Ernst, with $D_h = 10$ m, $D_r = 2$ m, $u = 0.1\pi$ m and $a = 4.2$	0.28

experimental drains are quite representative for different drain depths and spacings.

In layered soils, the effective depth is different from that described in Example 12.1 for homogeneous soils. This will be illustrated in Example 12.2.

Example 12.2 Influence of the Hydraulic Conductivity of the Lower Soil Layer on the Hydraulic Head between the Drains

Consider three soil profiles with an upper soil layer of equal thickness ($D_1 = 2$ m) and a deep lower soil layer ($D_2 \geq 10$ m). The hydraulic conductivity of the upper layer is fixed ($K_1 = 1$ m/d), whereas the hydraulic conductivity of the deeper layer varies (Figure 12.11). We can calculate the hydraulic head between the drains using the appropriate drainage equation (Chapter 8), with drain spacing $L = 50$ m, drain radius $r_o = 0.10$ m, and drain discharge $q = 0.005$ m/d. The results are given in Table 12.2.

It can be seen from Table 12.2 that, the K -value of the deeper soil layer exerts a considerable influence on the hydraulic head. If, instead of taking a constant drain spacing, we had taken the hydraulic head as constant, we would similarly find a considerable influence on the spacing.

These two examples show that, if one has a knowledge of the functioning of the drainage system in relation to the aquifer conditions, this can contribute greatly to the formulation of an effective program for determining a representative K -value.

12.5 Review of the Methods of Determination

12.5.1 Introduction

Determining the K -value of soils can be done with correlation methods or with hydraulic methods. Hydraulic methods can be either laboratory methods or in-situ (or field) methods.

Correlation methods are based on predetermined relationships between an easily determined soil property (e.g. texture) and the K -value. The advantage of the

correlation methods is that an estimate of the K-value is often simpler and quicker than its direct determination. A drawback is that the relationship used can be inaccurate and therefore be subject to random errors. (The correlation methods will be further discussed in Section 12.5.2.)

The hydraulic methods are based on imposing certain flow conditions in the soil and applying an appropriate formula based on the Law of Darcy and the boundary conditions of the flow. The K-value is calculated from the formula using the values of hydraulic head and discharge observed under the imposed conditions.

The hydraulic laboratory methods are applied to core samples of the soil. Although these methods are more laborious than the correlation methods, they are still relatively fast and cheap, and they eliminate the uncertainties involved in relating certain soil properties to the K-value. With respect to variability and representativeness, however, they have similar drawbacks as the correlation methods. (The hydraulic laboratory methods will be further discussed in Section 12.5.3.)

In contrast to the hydraulic laboratory methods, which determine the K-value inside a core with fixed edges, the in-situ methods usually determine the K-value around a hole made in the soil, so that the outer boundary of the soil body investigated is often not exactly known.

The hydraulic in-situ methods can be divided into small-scale and large-scale methods. The small-scale methods are designed for rapid testing at many locations. They impose simple flow conditions, to avoid complexity, so that the measurements can be made relatively quickly and cheaply. The in-situ methods normally represent the K-value of larger soil bodies than the laboratory methods, so that the variability in the results is less, but can often still be considerable. A drawback of the small-scale in-situ methods is that the imposed flow conditions are often not representative of the flow conditions corresponding to the drainage systems to be designed or evaluated. (The small-scale methods will be further discussed in Section 12.5.4.)

The large-scale in-situ methods are designed to obtain a representative K-value of a large soil body, whereby the problem of variation is eliminated as much as possible. These methods are more expensive and time consuming than the methods mentioned previously, but they are more reliable. (The large-scale methods will be further discussed in Section 12.5.5.)

Figure 12.12 summarizes the various methods used in determining the hydraulic conductivity.

12.5.2 Correlation Methods

The correlation methods for determining K-values in drainage surveys are frequently based on relationships between the K-value and one or more of the following soil properties: texture, pore-size distribution, grain-size distribution, or soil mapping unit. Details of soil properties were given in Chapter 3.

Soil Texture

Soil texture refers to the percentage of sand, silt, and clay particles in the soil. Texture or textural class is often used for the correlation of K values with other hydraulic properties of the soil (e.g. water-holding capacity and drainable pore space) (Wösten, 1990).

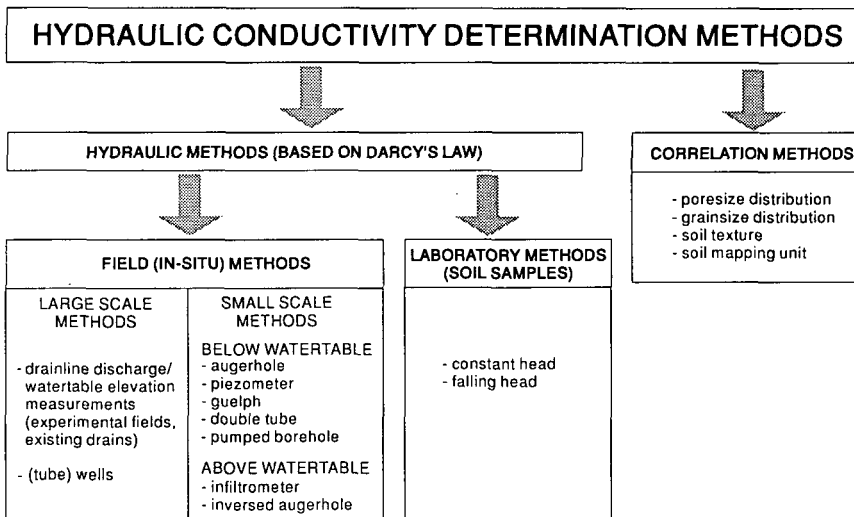

Figure 12.12 Overview of methods used to determine the hydraulic conductivity

Aronovici (1947) presented a correlation between the content of silt and clay of subsoil materials in the Imperial Valley in California, U.S.A., and the results of hydraulic laboratory tests. Smedema and Rycroft (1983) give generalized tables with ranges of K-values for certain soil textures (Table 12.3). Such tables (See also Chapter 7, Table 7.2), however, should be handled with care. Smedema and Rycroft warn that: 'Soils with identical texture may have quite different K-values due to differences in structure' and 'Some heavy clay soils have well-developed structures and much higher K-values than those indicated in the table'.

Pore-Size Distribution of the Soil

The pore-size distribution, the regularity of the pores, and their continuity have a great influence on the soil's K-values. Nevertheless, the study and characterization of the porosity aiming at an assessment of the K-values is not sufficiently advanced to be practical on a large scale.

An example of the complexity of such a study using micromorphometric data is given by Bouma et al. (1979) for clay soils. Another example is given by Marshall

Table 12.3 Range of K-values by soil texture (Smedema and Rycroft 1983)

Texture	K (m/d)	
Gravelly coarse sand	10	- 50
Medium sand	1	- 5
Sandy loam, fine sand	1	- 3
Loam, clay loam, clay (well structured)	0.5	- 2
Very fine sandy loam	0.2	- 0.5
Clay loam, clay (poorly structured)	0.002	- 0.2
Dense clay (no cracks, pores)	< 0.002	

(1957), who determined the pore-size distribution using the relationship between soil-water content and matric head (Chapter 3). Applying Poiseuille's Law to a number of fractions of the pF-curve, he was able to calculate the K-value. Marshall's method is mainly applicable to granular (sandy) soils having no systematic continuous pores.

Grain-Size Distribution of the Soil

In sandy soils, which have no systematic continuous pores, the soil permeability is related to the grain-size distribution. Determining the K value from the grain-size distribution uses the specific surface ratio (U) of the various grain-size classes. This U-ratio is defined as the total surface area of the soil particles per unit mass of soil, divided by the total surface area of a unit soil mass consisting of spherical particles of 1 cm diameter. The U-ratio, the porosity, and a shape factor for the particles and the voids allow us to calculate the hydraulic conductivity.

This method is seldom used in land drainage practice because the homogeneous, isotropic, purely-granular soils to which it applies are rare. An example of its use for deep aquifers is given in De Ridder and Wit (1965).

Soil Mapping Unit

In the U.S.A., soil mapping is often done on the basis of soil series, in which various soil properties are combined, and these series are often correlated to a certain range of K-values. For example, Camp (1977) measured K-values of a soil series called Commerce silt loam and he reported that the K-values obtained with the auger-hole method were in the range of 0.41 to 1.65 m/d, which agreed with the published K-values for this soil. Anderson and Cassel (1986) performed a survey of K-values of the Portsmouth sandy loam, using core samples. They found a very large variation of more than 100%, which indicates that the correlation with soil series is difficult.

12.5.3 Hydraulic Laboratory Methods

Sampling Techniques

Laboratory measurements of the K-value are conducted on undisturbed soil samples contained in metal cylinders or cast in gypsum. The sampling techniques using steel cylinders were described, among others, by Wit (1967), and the techniques using gypsum casting by Bouma et al. (1981).

With the smaller steel cylinders (e.g. the Kopecky rings of 100 cm³), samples can be taken in horizontal and vertical directions to measure K_h - and K_v -values. The samples can also be taken at different depths. Owing to the smallness of the samples, one must obtain a large number of them before a representative K-value is obtained. For example, Camp (1977) used aluminium cylinders of 76 mm in diameter and 76 mm long on a site of 3.8 ha, and obtained K-values ranging from < 0.001 m/d to 0.12 m/d in the same type of soil. He concluded that an extremely large number of core samples would be required to provide reliable results. Also, the average K-values found were more than ten times lower than those obtained with the auger-hole method. Anderson and Cassel (1986) reported that the coefficient of variability of K-values determined from core samples in a Portsmouth sandy loam varied between 130 to 3300%.

Wit (1967) used relatively large cylinders: 300 mm long and 60 mm in diameter. These cylinders need a special core apparatus, and the samples can only be taken in the vertical direction, although, in the laboratory, both the vertical and the horizontal hydraulic conductivity can be determined from these samples. Examples of the results were shown in Figure 12.1. If used on a large scale, the method is very laborious.

Bouma et al. (1981) used carefully excavated soil cubes around which gypsum had been cast so that the cubes could be transported to the laboratory. This method was developed especially for clay soil whose K-value depends mainly on the soil structure. The cube method leaves the soil structure intact, whereas other methods may destroy the structure and yield too low K-values. A disadvantage of the cube method is its laboriousness. The method is therefore more suited for specific research than for routine measurements on a large scale.

Flow Induction

After core samples have been brought to the laboratory, they are saturated with water and subjected to a hydraulic overpressure. The pressure can be kept constant (constant-head method), but it is also possible to let the pressure drop as a result of the flow of water through the sample (falling head method). One thus obtains methods of analysis either in a steady state or in an unsteady state (Wit 1967).

Further, one can create a one-dimensional flow through the sample, but the samples can also be used for two-dimensional radial flow or three-dimensional flow. It is therefore necessary to use the appropriate flow equation to calculate the K-value from the observed hydraulic discharges and pressures.

If the flow is three-dimensional, analytical equations may not be available and one must then resort to analogue models. For example, Bouma et al. (1981) used electrolyte models to account for the geometry of the flow.

12.5.4 Small-Scale In-Situ Methods

Bouwer and Jackson (1974) have described numerous small-scale in-situ methods for the determination of K-values. The methods fall into two groups: those that are used to determine K above the watertable and those that are used below the watertable.

Above the watertable, the soil is not saturated. To measure the saturated hydraulic conductivity, one must therefore apply sufficient water to obtain near-saturated conditions. These methods are called 'infiltration methods' and use the relationship between the measured infiltration rate and hydraulic head to calculate the K-value. The equation describing the relationship has to be selected according to the boundary conditions induced.

Below the watertable, the soil is saturated by definition. It then suffices to remove water from the soil, creating a sink, and to observe the flow rate of the water into the sink together with the hydraulic head induced. These methods are called 'extraction methods'. The K-value can then be calculated with an equation selected to fit the boundary conditions.

The small-scale in-situ methods are not applicable to great depths. Hence, their results are not representative for deep aquifers, unless it can be verified that the K-

values measured at shallow depth are also indicative of those at greater depths and that the vertical K-values are not much different from the horizontal values. In general, the results of small-scale methods are more valuable in shallow aquifers than in deep aquifers.

Extraction Methods

The most frequently applied extraction method is the 'auger-hole method'. It uses the principles of unsteady-state flow. (Details of this method will be given in Section 12.6.1.)

An extraction method based on steady-state flow has been presented by Zangar (1953) and is called the 'pumped-borehole method'.

The 'piezometer method' is based on the same principle as the auger-hole method, except that a tube is inserted into the hole, leaving a cavity of limited height at the bottom.

In sandy soils, the water-extraction methods may suffer from the problem of instability, whereby the hole caves in and the methods are not applicable. If filters are used to stabilize the hole, there is still the risk that sand will penetrate into the hole from below the filter, or that sand particles will block the filter, which makes the method invalid.

In clayey soils, on the other hand, where the K-value depends on the soil structure, it may happen that the augering of the hole results in the loss of structure around the wall. Even repeated measurements, whereby the hole is flushed several times, may not restore the structure, so that unrepresentatively low K-values are obtained (Bouma et al. 1979).

As the depth of the hole made for water extraction is large compared to its radius, the flow of groundwater to the hole is mainly horizontal and one therefore measures a horizontal K-value. The water-extraction methods measure this value for a larger soil volume (0.1 to 0.3 m³) than the laboratory methods that use soil cores. Nevertheless, the resulting variation in K-value from place to place can still be quite high. Using the auger-hole method, Davenport (Bentley et al. 1989) found K-values ranging from 0.12 to 49 m/d in a 7 ha field with sandy loam soil. Tabrizi and Skaggs (Bentley et al. 1989) found auger-hole K-values in the range of 0.54 to 11 m/d in a 5 ha field with sandy loam soil.

Infiltration Methods

The 'infiltration methods' can be divided into steady-state and unsteady state methods.

Steady-state methods are based on the continuous application of water so that the water level (below which the infiltration occurs) is maintained constant. One then awaits the time when the infiltration rate is also constant, which occurs when a large enough part of the soil around and below the place of measurement is saturated. An example of a steady-state infiltration method is the method of Zangar or 'shallow well pump-in method' (e.g. Bouwer and Jackson 1974). A recent development is the 'Guelph method', which is similar to the Zangar method, but uses a specially developed apparatus and is based on both saturated and unsaturated flow theory (Reynolds and Elrick 1985).

Unsteady-state methods are based on observing the rate of drawdown of the water level below which the infiltration occurs, after the application of water has been

stopped. This measurement can start only after sufficient water has been applied to ensure the saturation of a large enough part of the soil around and below the place of measurement. Most infiltration methods use the unsteady-state principle, because it avoids the difficulty of ensuring steady-state conditions.

When the infiltration occurs through a cylinder driven into the soil, one speaks of 'permeameter methods'. Bouwer and Jackson (1974) presented a number of unsteady-state permeameter methods. They also discuss the 'double-tube method', where a small permeameter is placed inside a large permeameter.

The unsteady-state method whereby an uncased hole is used is called the 'inversed auger-hole method'. This method is similar to the Zangar and Guelph methods, except that the last two use the steady-state situation. (Details of the inversed auger-hole method will be given in Section 12.6.2.)

In sandy soils, the infiltration methods suffer from the problem that the soil surface through which the water infiltrates may become clogged, so that too low K -values are obtained. In clayey soils, on the other hand, the infiltrating water may follow cracks, holes, and fissures in the soil, so that too high K -values are obtained.

In general, the infiltration methods measure the K -value in the vicinity of the infiltration surface. It is not easy to obtain K -values at greater depths in the soil.

Depending on the dimensions of the infiltrating surface, the infiltration methods give either horizontal K -values (K_h), vertical K -values (K_v), or K -values in an intermediate direction.

Although the soil volume over which one measures the K -value is larger than that of the soil cores used in the laboratory, it is still possible to find a large variation of K -values from place to place.

A disadvantage of infiltration methods is that water has to be transported to the measuring site. The methods are therefore more often used for specific research purposes than for routine measurements on a large scale.

12.5.5 Large-Scale In-Situ Methods

The large-scale in-situ methods can be divided into methods that use pumping from wells and pumping or gravity flow from (horizontal) drains. The methods using wells were presented in Chapter 10. In this chapter, we shall only consider horizontal drains.

Determining K -values from the functioning of drains can be done in experimental fields, pilot areas, or on existing drains. The method uses observations on drain discharges and corresponding elevations of the watertable in the soil at some distance from the drains. From these data, the K -values can be calculated with a drainage formula appropriate for the conditions under which the drains are functioning. Since random deviations of the observations from the theoretical relationship frequently occur, a statistical confidence analysis accompanies the calculation procedure.

The advantage of the large-scale determinations is that the flow paths of the groundwater and the natural irregularities of the K -values along these paths are automatically taken into account in the overall K -value found with the method. It is then not necessary to determine the variations in the K -values from place to place, in horizontal and vertical direction, and the overall K -value found can be used directly as input into the drainage formulas.

A second advantage is that the variation in K-values found is considerably less than those found with small-scale methods. For example, El-Mowelhi and Van Schilfhaarde (1982) found the K-values determined from different 100 mm drains in a clay soil to vary from 0.086 to 0.12 m/d. This range compares very favourably with the much wider ranges given in Sections 12.5.3 and 12.5.4.

Influence of Drainage Conditions

The choice of the correct drainage formula for the calculation of K-values from observations on the functioning of the drains depends on:

- The drainage conditions and the aquifer type. For example, the choice depends on the depth of an impermeable layer, whether the K-value increases or decreases with depth, and whether the aquifer is semi-confined and seepage or natural drainage occurs;
- Whether one is dealing with parallel drains with overlapping zones of influence or with single drains;
- Whether one analyses the drain functioning in steady or unsteady state;
- Whether the groundwater flow is two-dimensional (which occurs when the recharge is evenly distributed over the area) or three-dimensional (which often occurs in irrigated areas where the fields are not irrigated at the same time, so that the recharge is not evenly distributed over the area);
- Whether the drains are offering entrance resistance to the flow of groundwater into the drains or not;
- Whether the drains are placed in flat or in sloping land, and whether they are laid at equal or different depths below the soil surface.

In this chapter, not all the above situations will be discussed in detail, but a selection is presented in Section 12.7. Some other situations are described by Oosterbaan (1990a, 1990b).

The analysis of the functioning of existing drains in unsteady-state conditions offers the additional possibility of determining the drainable porosity (e.g. El-Mowelhi and Van Schilfhaarde 1982). This possibility is not further elaborated in this chapter.

Anyone needing to analyze K-values under drainage conditions that deviate from those selected in this chapter and are not discussed elsewhere in literature, will probably have to develop a new method of analysis which takes into account the specific drainage conditions.

12.6 Examples of Small-Scale In-Situ Methods

12.6.1 The Auger-Hole Method

Principle

The principle of the auger-hole method is as follows. A hole is bored into the soil with an auger to a certain depth below the watertable. When the water in the hole reaches equilibrium with the groundwater, part of it is removed. The groundwater then begins to seep into the hole and the rate at which it rises is measured. The hydraulic conductivity of the soil is computed with a formula or graph describing the mutual

relationship between the rate of rise, the groundwater conditions, and the geometry of the hole.

This method measures the average hydraulic conductivity of a soil column about 30 cm in radius and extending from the watertable to about 20 cm below the bottom of the hole, or to a relatively impermeable layer if it occurs within 20 cm of the bottom.

The method can also be used to measure the K-values of two separate layers. This is done by repeating the measurements in the same hole after it has been deepened. Reference is made to Van Beers (1970).

Theory

As reported by Van Beers (1970) and Bouwer and Jackson (1974), Ernst developed the following equation for the K-value of the soil in dependence of the average rate of rise of the water level in the hole (Figure 12.13)

$$K = C \frac{H_0 - H_t}{t} \quad (12.9)$$

where

K = hydraulic conductivity of the saturated soil (m/d)

C = a factor as defined in Equation 12.10 or 12.11

t = time elapsed since the first measurement of the level of the rising water in the hole (s)

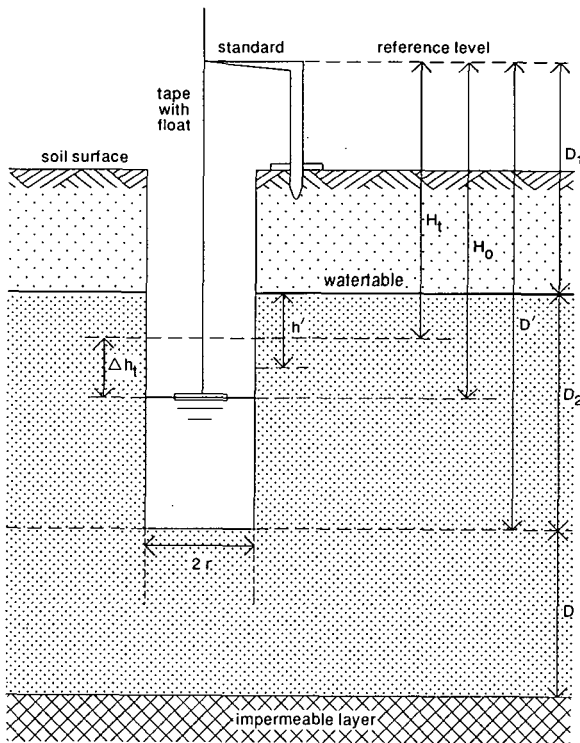

Figure 12.13 Measurements for the auger-hole method

H_t = depth of the water level in the hole below reference level at time t (cm)
 $H_0 = H_t$ when $t = 0$

The C-factor depends on the depth of an impermeable layer below the bottom of the hole (D) and the average depth of the water level in the hole below the watertable (h') as follows:

When $D > \frac{1}{2} D_2$, then

$$C = \frac{4000 \frac{r}{h'}}{\left(20 + \frac{D_2}{r}\right) \left(2 - \frac{h'}{D_2}\right)} \quad (12.10)$$

When $D = 0$, then

$$C = \frac{3600 \frac{r}{h'}}{\left(10 + \frac{D_2}{r}\right) \left(2 - \frac{h'}{D_2}\right)} \quad (12.11)$$

where

- D = depth of the impermeable layer below the bottom of the hole (cm)
- D_2 = depth of the bottom of the hole below the watertable (cm), with the condition: $20 < D_2 < 200$
- r = radius of the hole (cm): $3 < r < 7$
- h' = average depth of the water level in the hole below the watertable (cm), with the condition: $h' > D_2/5$

When $0 < D < \frac{1}{2} D_2$, one must interpolate between the results of the above two equations.

The value of h' can be calculated from

$$h' = 0.5 (H_0 + H_n) - D_1 \quad (12.12)$$

where

- D_1 = depth of the watertable below reference level (cm)
- H_n = depth of the water level in the hole at the end of the measurements (cm)

Ernst also prepared graphs for the solution of the C-factor in Equation 12.9 (Van Beers 1970), which are more accurate than Equations 12.10 and 12.11. Within the ranges of r and H mentioned above, however, the equations give less than 20% error. In view of the usually large variability in K-values (of the order of 100 to 1000%, or more), the given equations are accurate enough.

Other methods of determining K-values with the auger-hole method were reviewed by Bouwer and Jackson (1974). These methods give practically the same results as the Ernst method.

Equipment and Procedure

The equipment used in The Netherlands is illustrated in Figure 12.14. It consists of a tube, 60 cm long, the bottom end of which is fitted with a clack valve so that it can be used as a bailer. Extension pieces can be screwed to the top end of the tube. A float, a light-weight steel tape, and a standard are also part of the equipment. The standard is pressed into the soil down to a certain mark, so that the water-level readings can be taken at a fixed height above the ground surface.

The hole must be made with a minimum disturbance to the soil. The open blade auger used in The Netherlands is very suitable for wet clay soils, whereas the closed pothole auger commonly used in the U.S.A. is excellent in dry soils.

The optimum depth of the holes depends on the nature, thickness, and sequence of soil layers, on the depth of the watertable, and on the depth at which one wishes to determine the hydraulic conductivity. When augering the hole in slowly permeable soils, one often observes that the water is entering the hole only when the depth of the hole is well below the watertable. As the hole is deepened further, the water enters faster, because the rate of inflow of the water is governed by the difference between the watertable and the water level in the hole, and by the depth of the hole below reference level (D_2). Sometimes, this phenomenon is incorrectly attributed to artesian pressure, but artesian pressure only exerts an influence if one pierces a completely or almost impermeable layer.

When the water in the hole is in equilibrium with the groundwater, the level is recorded. Water is then bailed out to lower the level in the hole by 20 to 40 cm.

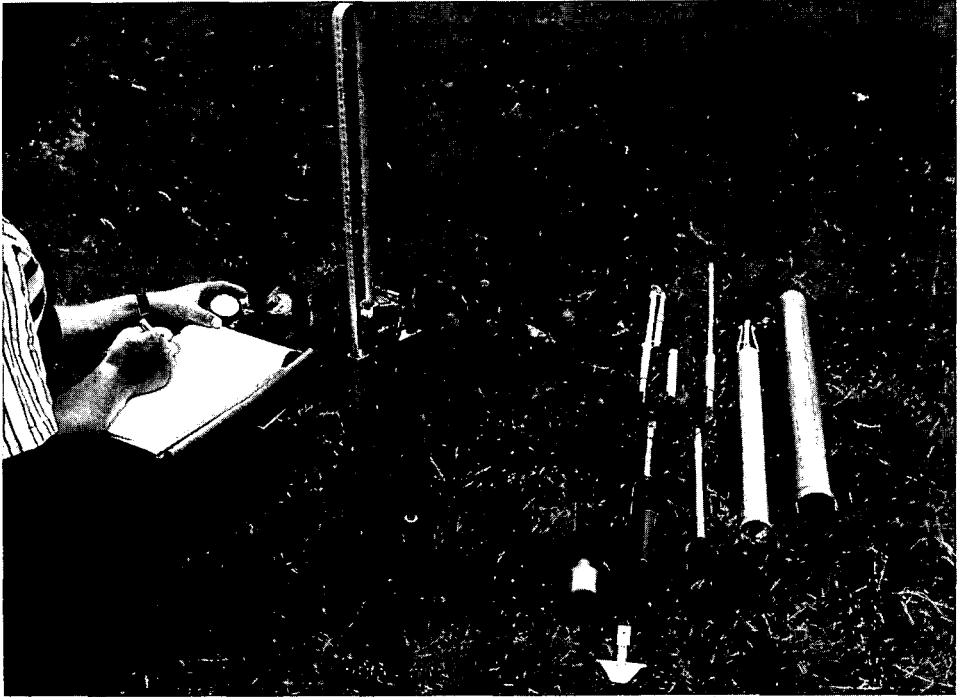

Figure 12.14 Equipment used for the auger-hole method (courtesy Eijkelkamp b.v.)

Measuring the rate of rise in the water level must begin immediately after bailing. Either the time for fixed intervals of rise, or the rise for fixed intervals of time can be recorded. The first technique requires the use of chronometers, while the second, which is customary in The Netherlands, needs only a watch with a good second hand. Normally, some five readings are taken, as these will give a reliable average value for the rate of rise and also provide a check against irregularities. The time interval at which water-level readings are taken is usually from 5 to 30 seconds, depending on the hydraulic conductivity of the soil, and should correspond to a rise of about 1 cm in the water level. A good rule of thumb is that the rate of rise in mm/s in an 8 cm diameter hole with a depth of 70 cm below the watertable approximately equals the K-value of the soil in m/d.

Care should be taken to complete the measurements before 25% of the volume of water removed from the hole has been replaced by inflowing groundwater. After that, a considerable funnel-shaped watertable develops around the top of the hole. This increases resistance to the flow around and into the hole. This effect is not accounted for in the formulas or flow charts developed for the auger-hole method and consequently it should be checked that $H_0 - H_1 < 0.25 (H_0 - D_1)$.

After the readings have been taken, the reliability of the measurements should be checked. The difference in water level between two readings (ΔH) is therefore computed to see whether the consecutive readings are reasonably consistent and whether the value of ΔH gradually decreases.

It often happens that ΔH is relatively large for the first reading, because of water dripping along the walls of the hole directly after bailing. Further inconsistencies in ΔH values may be caused by the float sticking to the wall or by the wind blowing the tape against the wall. Consistency can be improved by tapping the tape regularly. An example of recorded data and the ensuing calculations is presented in Table 12.4.

The auger-hole method measures the K-value mainly around the hole. It gives no information about vertical K-values nor about K-values in deeper soil layers. The method is therefore more useful in shallow than in deep aquifers.

12.6.2 Inversed Auger-Hole Method

Principles and Theory of the Infiltration Process

If one uses a steel cylinder (also called 'infiltrometer') to infiltrate water continuously into unsaturated soil, one will find after a certain time that the soil around and below the area becomes almost saturated and that the wetting front is a rather sharp boundary between wet and dry soil (Figure 12.15).

We shall consider a point just above the wetting front at a distance z below the soil surface in the area where the water infiltrates. The matric head of the soil at this point has a (small) value h_m . The head at the soil surface equals $z + h$ (h = height of water level in the cylinder). The head difference between the point at depth z and a point at the soil surface equals $z + h + |h_m|$, and the average hydraulic gradient between the two points is

$$s = \frac{z + h + |h_m|}{z} \quad (12.13)$$

Table 12.4 Example of measurements and calculations with the auger-hole method

No:	Date:
Location:	Details:
Depth of auger-hole D'	: 240 cm below reference
Depth of watertable D_1	: 114 cm below reference
$D_2 = D' - D_1$: 126 cm
Auger-hole radius r	: 4 cm
Depth impermeable layer	: $D > 1/4 D_2$

t (s)	H (cm)	ΔH^* (cm)
0	145.2	-
10	144.0	1.2
20	142.8	1.2
30	141.7	1.1
40	140.6	1.1
50	139.6	1.0

Try $t = 50$ s; $\Delta H_{50} = H_0 - H_{50} = 145.2 - 139.6 = 5.6$ cm

Check $H_0 - H_{50} < 0.25 (H_0 - D_1)$; $145.2 - 139.6 < 0.25 (145.2 - 114)$;
 $5.6 < 7.8$ O.K.**)

Equation 12.12: $h' = 0.5 (145.2 + 139.6) - 114 = 28.4$ cm

Ratio's for Equation 12.10: $D_2/r = 31.5$; $h'/D_2 = 0.225$; $r/h' = 0.141$

Equation 12.10: $C = \frac{4000 \times 0.141}{(20 + 31.5)(2 - 0.255)} = 6.2$

Equation 12.9: $K = 6.2 \times 5.6 / 50 = 0.7$ m/d

*) per reading; $\Delta H = H_{t-1} - H_t$

**) if not O.K., try $t = 40$ s or less, so that ΔH_t decreases

If z is large enough, s approximates unity. Hence, from Darcy's Law (Equation 12.2), we know that the mean flow velocity in the wetted soil below approaches the hydraulic conductivity ($v = K$), assuming the wetted soil is practically saturated.

The inversed auger-hole method (in French literature known as the 'Porchet method') is based on these principles. If one bores a hole into the soil and fills this hole with water until the soil below and around the hole is practically saturated, the infiltration rate v will become more or less constant. The total infiltration Q will then be equal to $v \times A$ (where A is the surface area of infiltration). With $v = K$, we get: $Q = K \times A$.

For the inversed auger-hole method, infiltration occurs both through the bottom and the side walls of the hole (Figure 12.16). Hence we have $A = \pi r^2 + 2\pi r h$ (where r is the radius of the hole and h is the height of the water column in the hole). So we can write $Q = 2\pi K r (h + \frac{1}{2} r)$.

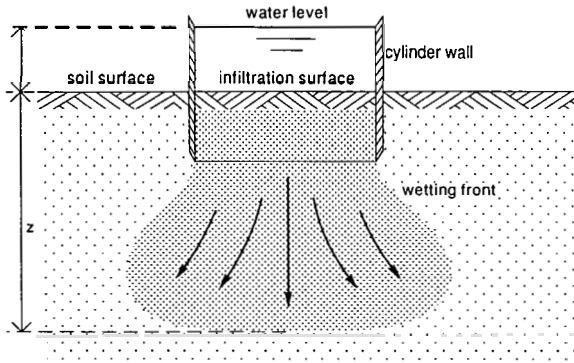

Figure 12.15 Infiltration process beneath a cylinder infiltrometer

Further, we can find Q from the rate at which the water level in the hole is lowered: $Q = -\pi r^2 dh/dt$. Eliminating Q in both expressions gives $2K(h + \frac{1}{2} r) = -r dh/dt$. Upon integration and rearrangement, we obtain

$$K = 1.15 r \frac{\log(h_0 + \frac{1}{2} r) - \log(h_t + \frac{1}{2} r)}{t - t_0} \quad (12.14)$$

where (Figure 12.17)

t = time since the start of measuring (s)

h_t = the height of the water column in the hole at time t (cm)

$h_0 = h_t$ at time $t = 0$

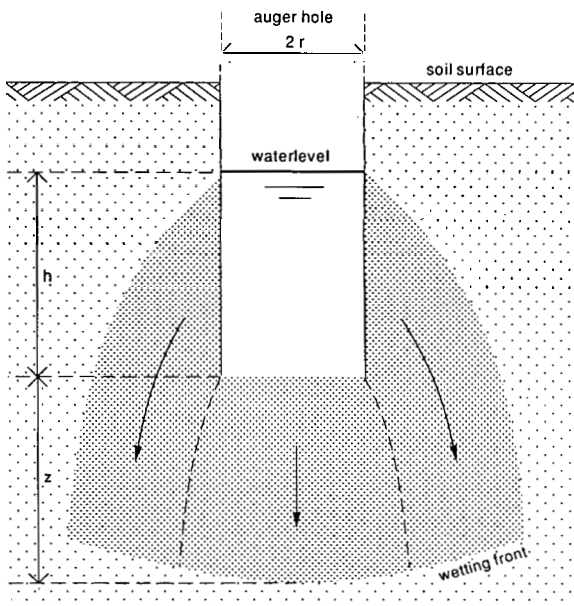

Figure 12.16 Infiltration from a water-filled auger-hole into the soil (inversed auger-hole method)

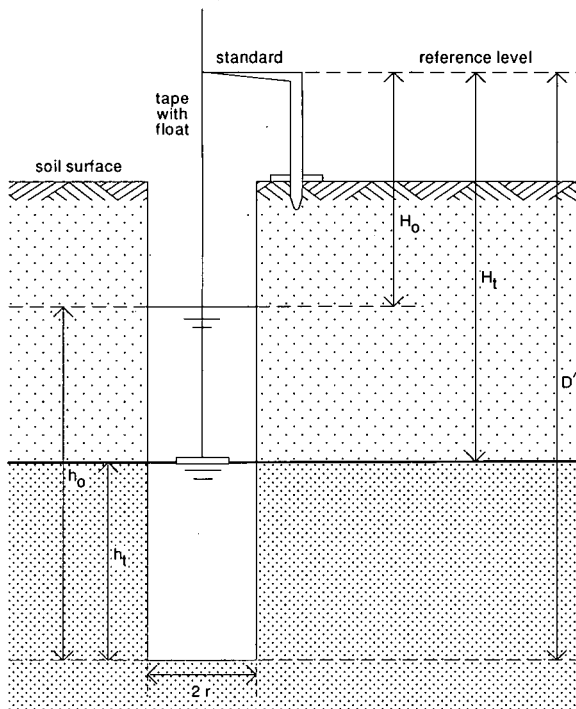

Figure 12.17 Measurements for the inversed auger-hole method

The values of h_t are obtained from

$$h_t = D' - H_t \quad (12.15)$$

where

D' = the depth of the hole below reference level (cm)

H_t = the depth of the water level in the hole below reference level (cm)

When H and t are measured at appropriate intervals (as was explained in the previous section), K can be calculated.

On semilog paper, plotting $h_t + \frac{1}{2}r$ on the log axis and t on the linear axis produces a straight line with a slope

$$\tan \alpha = \frac{\log(h_0 + \frac{1}{2}r) - \log(h_t + \frac{1}{2}r)}{t - t_0} \quad (12.16)$$

The calculation of K with Equation 12.14 can therefore also be done with the value of $\tan \alpha$. Hence, $K = 1.15 r \tan \alpha$.

Procedure

After a hole is augered in the soil to the required depth, the hole is filled with water, which is left to drain away freely. The hole is refilled with water several times until the soil around the hole is saturated over a considerable distance and the infiltration (rate) has attained a more or less constant value. After the last refilling of the hole,

Table 12.5 Example of measurements with inversed auger-hole method ($r = 4 \text{ cm}$, $D' = 90 \text{ cm}$)

t (s)	H_t (cm)	$h_t = D' - H_t$ (cm)	$h_t + \frac{1}{2}r$ (cm)
0	71	19	21
140	72	18	20
300	73	17	19
500	74	16	18
650	75	15	17
900	76	14	16

the rate of drop of the water level in the hole is measured (e.g. with the float and tape system as was explained for the auger-hole method). The data ($h + \frac{1}{2}r$ and t) are then plotted on semi-log paper, as was explained earlier. The graph should yield a straight line. If the line is curved, continue to wet the soil until the graph shows the straight line. Now, with any two pairs of values of $h + \frac{1}{2}r$ and t , the K value can be calculated according to Equation 12.14. An example of measurements is given in Table 12.5.

The data of Table 12.5 are plotted in Figure 12.18, which shows that a linear relation exists between $\log(h_t + \frac{1}{2}r)$ and t . The K -value can now be calculated from Equation 12.14 as follows

$$\begin{array}{lll}
 t_0 = 140 & h_0 + \frac{1}{2}r = 20 & \log(h_0 + \frac{1}{2}r) = 1.30 \\
 t = 650 & h_t + \frac{1}{2}r = 17 & \log(h_t + \frac{1}{2}r) = 1.23
 \end{array}$$

$$K = 1.15 \times 4 \frac{1.30 - 1.23}{650 - 140} = 0.00063 \text{ cm/s or } 0.55 \text{ m/d}$$

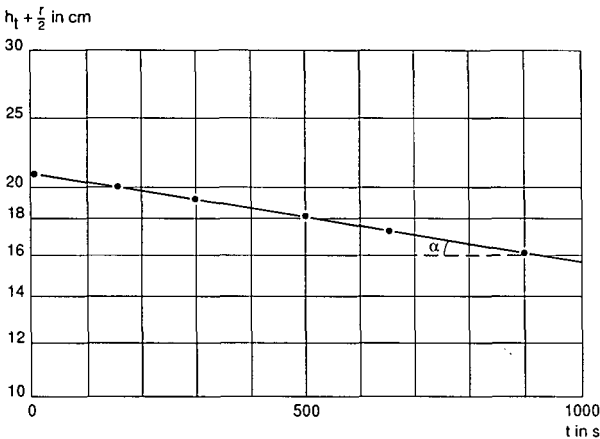

Figure 12.18 Fall of the water level, recorded with the inversed auger-hole method, plotted against time

12.7 Examples of Methods Using Parallel Drains

12.7.1 Introduction

When one is analyzing the relationships between hydraulic head (elevation of the watertable) and the discharge of pipe drainage systems to assess the soil's hydraulic conductivity, one needs a drainage equation in agreement with the conditions during which the measurements were made. Usually, the measurements are made during a dry period following a period of recharge by rain or irrigation (i.e. during tail recession). Hence, the watertable is falling after it had risen as a result of the recharge. Under such unsteady-state conditions, Equation 8.36 (Chapter 8) is applicable for ideal drains (i.e. drains without entrance resistance)

$$q = \frac{2\pi K_b d h}{L^2}$$

which can be extended to include the flow above the drain level (Oosterbaan et al. 1989)

$$q = \frac{2\pi K_b d h + \pi K_a h^2}{L^2} \quad (12.17)$$

where

q = drain discharge (m/d)

K_b = hydraulic conductivity of the soil below drain level (m/d)

K_a = hydraulic conductivity of the soil above drain level (m/d)

d = Hooghoudt's equivalent depth (m)

h = elevation of the watertable midway between the drains relative to drain level (m)

L = drain spacing (m)

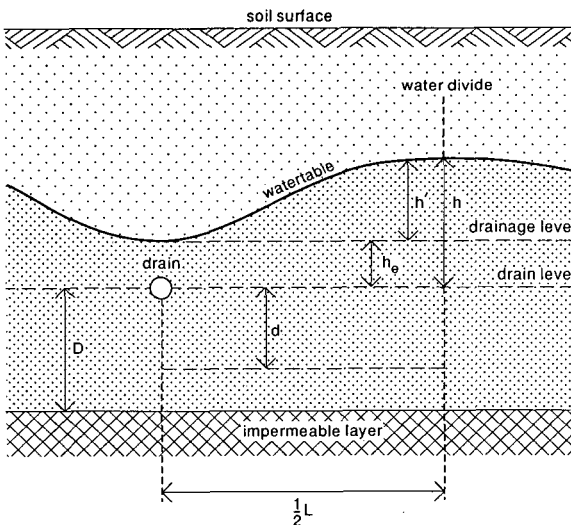

Figure 12.19 Drains with entrance resistance (symbols as defined for Equations 12.17 – 12.19)

Since entrance resistance is not always negligible, Oosterbaan et al. (1989) showed that Equation 12.17 can be adjusted to take the entrance head into account (Figure 12.19)

$$q = \frac{2\pi K_b (h - h_e) + \pi K_a (h - h_e) (h + h_e)}{L^2} \quad (12.18)$$

or

$$q = \frac{2\pi K_b d h' + \pi K_a h' h^*}{L^2} \quad (12.19)$$

where, in addition to the previously defined symbols

h_e = entrance head (i.e. the elevation of the watertable above the drains relative to drain level) (m)

$h' = h - h_e$; available hydraulic head (i.e. the elevation of the watertable midway between the drains relative to drainage level) (m)

$h^* = h + h_e$ (m)

The equivalent depth d , which is a function of the depth to the impermeable layer D , the drain spacing L , and the drain radius r_o , can be determined according to the flow chart in Figure 8.4 (Chapter 8), and the wet perimeter, u , can be chosen according to Section 8.2.2. In theory, the d -value must be calculated with an adjusted radius $r' = r_o + h_e$ instead of r_o , and the factor 8 must be replaced by 2π , but neglecting this does not usually lead to any appreciable error in the K -values.

The procedures discussed in the following sections are based on Equations 12.18 and 12.19. Statistical methods (Chapter 6, Section 6.5.4) are used to account for random variations.

12.7.2 Procedures of Analysis

To determine the K -value in an area with existing drains, one observes the depth of the watertable midway between the drains, and near the drains, and converts the measurements to hydraulic-head and entrance-head values, respectively. Observations should be made in one or more cross-sections over the drains, at different times during periods of tail recession. The drain discharge is measured at the same time. The measured discharge in m^3/d should be expressed per unit surface area of the zone of influence of the drain (i.e. the drain length multiplied by the drain spacing), obtaining q in m/d .

Equation 12.19 may also be written as

$$\frac{q}{h'} = a h^* + b \quad (12.20)$$

with

$$a = \frac{\pi K_a}{L^2} \quad \text{and} \quad b = \frac{2\pi K_b d}{L^2}$$

Plotting the values of q/h' on the vertical axis against the values of h^* on the horizontal

axis in a graph may result in one of the different lines depicted in Figure 12.20. According to the type of line, one follows different procedures, as will be explained below.

Procedure 1

Procedure 1 is used if q/h' plotted against h^* yields a horizontal line (Type I in Figure 12.20). The value of a (Equation 12.20) is close to zero, so the flow above drain level can be neglected. Consequently, the hydraulic resistance is mainly due to flow below drain level. For each set of (q, h, h_e) data, and the equivalent depth, d , from Chapter 8, we calculate the hydraulic conductivity, K_b , using Equation 12.20 with $a = 0$

$$K_b = \frac{L^2 q}{2\pi d h'} = \frac{L^2}{2\pi d} b \quad (12.21)$$

We then determine the mean value of K_b , its standard deviation, and the standard error of the mean. We find the upper and lower confidence limits of K_b , using Student's t -distribution, as was explained in Chapter 6, Section 6.5.2. Procedure 1 will be used in Example 12.3 (Section 12.7.3).

Procedure 2

Procedure 2 is used if q/h' plotted against h^* yields a straight line of Type II (Figure 12.20). The slope of the line, a , (Equation 12.20) represents the value of the hydraulic conductivity above drain level. The line passes through the origin; the zero intercept points towards a negligible flow below drain level. These drains are resting on an impermeable layer. With each set of (q, h, h_e) data, we calculate the K_a -value, using Equation 12.20 with $b = 0$

$$K_a = \frac{L^2 q}{\pi h^* h'} = \frac{L^2}{\pi} a \quad (12.22)$$

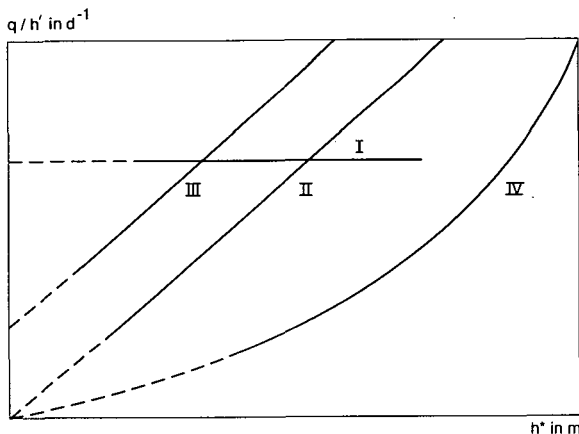

plot of q/h' versus h^* , ($h = h - h_e$, $h^* = h + h_e$)

Figure 12.20 Different patterns in plotted field data on drain discharge and hydraulic head; I) No horizontal flow above drain level; II) No horizontal flow below drain level; III) Horizontal flow occurs above and below drain level; IV) Similar to pattern II, but with a high entrance head and/or decreasing K_a value with depth

We then determine the mean and standard error of K_a , and the standard error of the mean. With Student's t-distribution, we find confidence limits of K_a and of \bar{K}_a (Section 6.5.2). Procedure 2 will be used in Example 12.4 (Section 12.7.4).

Procedure 3

Procedure 3 is used if q/h' plotted against h^* yields a straight line that does not pass through the origin (Type III in Figure 12.20). In this case, there is flow above and below the drain level, and neither K_a nor K_b can be neglected. We then perform a linear two-way regression analysis with the equations

$$\frac{q}{h'} = a h^* + b \quad (12.23)$$

and

$$h^* = a' \frac{q}{h'} + b' \quad (12.24)$$

Writing Equation 12.24 in the same form as Equation 12.23 gives

$$\frac{q}{h'} = \frac{h^*}{a'} - \frac{b'}{a'} \quad (12.25)$$

We thus find two different regression coefficients, a and $1/a'$, which we can combine into an intermediate regression coefficient, a^* , by taking their geometric mean. Also, we find an intermediate value b^* (Chapter 6, Section 6.5.4). Using Equation 12.20, we can find the K_a and K_b values from the intermediate values a^* and b^* instead of a and b . Following Chapter 6, the confidence limits of K_a and K_b are found from the confidence limits of a^* and b^* . The width of the confidence intervals will be somewhat underestimated, because the variables q/h' and h^* are not fully independent since both h' and h^* contain parameters h and h_e .

Often, a simpler procedure for finding the confidence limits can be used, because the values a (from Equation 12.23) and $1/a'$ (from Equation 12.25) give a reasonable approximation of the confidence limits of a^* . Similarly, we find the approximate confidence limits of b^* as b and b'/a' . Example 12.5 will use Procedure 3, including these approximations of the confidence intervals.

Procedure 4

Procedure 4 is used if q/h' plotted against h^* yields an upward-bending curve which passes through the origin (Type IV in Figure 12.20). In this case, there is no flow below drain level and K_b can be neglected. The K_a -value is not constant, but decreases with depth. We write $K_a = \lambda h^*$, so that substitution into Equation 12.19 with $K_b = 0$ yields

$$\frac{q}{h'} = \frac{\pi \lambda h^{*2}}{L^2} \quad (12.26)$$

Now, a plot of q/h' versus h^{*2} may yield a straight line going through the origin (Figure 12.21). Next, for each set of (q, h, h_e) data, we calculate the λ -value. We then determine its mean, $\bar{\lambda}$, and standard deviations of λ and $\bar{\lambda}$. With Student's t-distribution, we can find the confidence limits of λ and $\bar{\lambda}$. An example of this procedure was given by Oosterbaan et al. (1989).

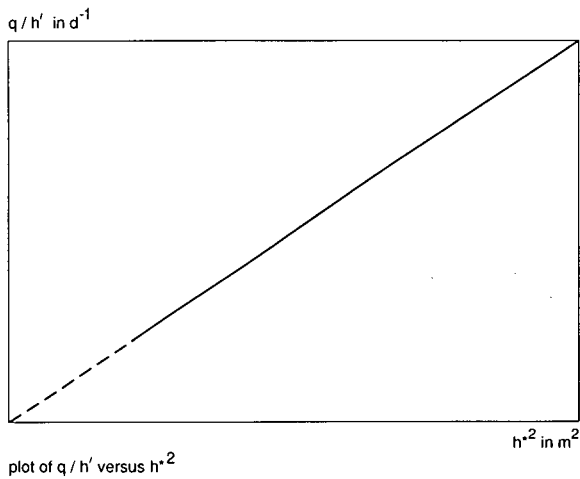

Figure 12.21 Plot of field data used in Procedure 4

Table 12.6 Field observations on drain discharge and hydraulic head (Example 12.3)

No.	q (m/d)	h (m)	h_e (m)	h' (m)	K_b (m/d)
1	0.0030	0.31	0.01	0.30	0.34
2	0.0040	0.40	0.05	0.35	0.39
3	0.0030	0.50	0.10	0.40	0.25
4	0.0045	0.50	0.05	0.45	0.34
5	0.0060	0.70	0.20	0.50	0.40
6	0.0050	0.60	0.10	0.50	0.34
7	0.0040	0.55	0.05	0.50	0.27
8	0.0050	0.63	0.08	0.55	0.31
9	0.0045	0.72	0.12	0.60	0.25
10	0.0070	0.70	0.10	0.60	0.39
11	0.0060	0.80	0.20	0.60	0.34
12	0.0045	0.75	0.15	0.60	0.25
13	0.0040	0.85	0.25	0.60	0.22
14	0.0050	0.70	0.05	0.65	0.26
15	0.0045	0.75	0.10	0.65	0.23
16	0.0050	0.85	0.15	0.70	0.24
17	0.0060	0.95	0.20	0.75	0.27
18	0.0050	0.90	0.15	0.75	0.22

12.7.3 Drains with Entrance Resistance, Deep Soil

Example 12.3

Table 12.6 shows the data collected on drain discharge, hydraulic head midway between the drains, and entrance head (q , h , and h_e) in an experimental field with drain spacing $L = 20$ m and a drain radius $r_o = 0.1$ m. The impermeable layer is at great depth.

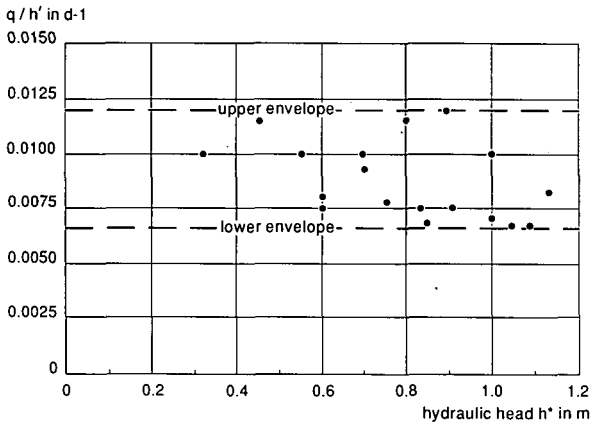

Figure 12.22 Plot of field data indicating a negligible flow resistance above drain level (Example 12.3)

A plot of q/h' versus h^* values (Figure 12.22) shows that the envelope lines tend to be horizontal, indicating that resistance to flow above drain level can be neglected. Hence, Procedure 1 and Equation 12.21 are applicable. According to Table 8.1 (Chapter 8), Hooghoudt's equivalent depth $d = 1.89$ m. The K_b -values thus found are shown in Table 12.6.

The K_b -values in Table 12.6 have a mean value $\bar{K}_b = 0.30$ m/d. The standard error of the mean is 0.014 m/d. Using Student's probability distribution (Section 6.5.2) for a 90% confidence interval and 17 degrees of freedom ($t_f = 1.75$), we can state with 90% confidence that

$$0.28 < \bar{K}_b < 0.32 \text{ m/d}$$

12.7.4 Drains with Entrance Resistance, Shallow Soil

Example 12.4

Table 12.7 shows the data collected in experimental fields in the delta of the Tagus River in Portugal, in which corrugated and perforated PVC pipe drains with a radius $r_o = 0.10$ m were installed at a depth of 1.1 m below the soil surface and at a spacing $L = 20$ m. The soils in this delta are fine textured (heavy clay soil).

Figure 12.23A shows the drainage intensity, q/h' , plotted against the h^* -values of Table 12.7. The relation between q/h' and h^* shows an upward-bending curve through the origin of the graph. This suggests that the soil below drain level is impermeable and that the soil above drain level has a K -value that decreases with depth. If we ignore the two highest points in Figure 12.23A, however, we can make the assumption that the relationship between q/h' and h^* gives a straight line through the origin of the graph or, in other words, that the soil above drain level has a constant K -value, whereas the flow below the drains is neglected. This assumption is illustrated by the straight line in Figure 12.23A.

Hence, Procedure 2 is used and the hydraulic conductivity K_a is calculated according to Equation 12.22. Table 12.7 shows the results. The mean \bar{K}_a equals 0.20 m/d. The

Table 12.7 Field observations on drain discharge and hydraulic head (Example 12.4)

No.	Date	q (m/d)	h (m)	h_c (m)	h' (m)	h^* (m)	q/h' (d ⁻¹)	K_a (m/d)
1	29/12	0.00137	0.88	0.18	0.70	1.06	0.00196	0.235
2	30/12	0.00106	0.85	0.13	0.72	0.98	0.00147	0.191
3	31/12	0.00064	0.73	0.08	0.65	0.81	0.00098	0.155
4	02/01	0.00030	0.61	0.03	0.58	0.64	0.00052	0.103
5	03/01	0.00026	0.58	0.02	0.56	0.60	0.00046	0.099
6	07/01	0.00129	0.82	0.16	0.66	0.98	0.00195	0.254
7	08/01	0.00124	0.84	0.18	0.66	1.02	0.00188	0.235
8	09/01	0.00126	0.82	0.12	0.70	0.94	0.00180	0.244
9	10/01	0.00084	0.77	0.10	0.67	0.87	0.00125	0.183
10	13/01	0.00035	0.50	0.01	0.49	0.51	0.00071	0.178
11	21/02	0.00303	0.98	0.54	0.44	1.52	0.00689	0.577
12	22/02	0.00263	0.96	0.45	0.51	1.41	0.00516	0.466
13	25/02	0.00129	0.91	0.20	0.71	1.11	0.00182	0.208
14	26/02	0.00086	0.88	0.18	0.70	1.06	0.00123	0.148
15	28/02	0.00043	0.73	0.01	0.72	0.74	0.00060	0.103
16	03/03	0.00027	0.53	0.00	0.53	0.53	0.00051	0.122
17	05/03	0.00040	0.69	0.02	0.67	0.71	0.00060	0.107
18	06/03	0.00031	0.61	0.01	0.60	0.62	0.00052	0.106
19	07/03	0.00026	0.60	0.00	0.60	0.60	0.00043	0.092

standard deviation of K_a equals 0.13 m/d and the standard error of \bar{K}_a equals 0.032 m/d. We can calculate the confidence interval of the mean \bar{K}_a using Student's *t*-distribution (Section 6.5.2). With 90% confidence and 16 degrees of freedom (Observations 11 and 12 are omitted), we find it to range from 0.14 to 0.26 m/d.

Discussion

As stated earlier, the procedure for the calculation can be improved by accepting that the value of K_a decreases with depth, as occurs frequently in heavy clay soils. This is also suggested in Table 12.7, by the decrease in the K_a -values with decreasing *q*- and *h*-values. Oosterbaan et al. (1989) calculated that the K_a -value is 0.77 m/d at the soil surface, 0.22 m/d at 0.55 m depth, and almost zero at drain level. From this analysis, it follows that the drains are situated in a slowly permeable soil layer, which explains the presence of the entrance resistance. It is likely that the entrance head would have been less if the drains had been placed less deeply. In soils like those found in the experimental plot, the optimum drain depth is probably about 0.8 m.

Figure 12.23B, which shows a plot of *q* against h_c , indicates that the entrance head increases proportionally with the discharge. This corresponds to the previous conclusion that the K_a -value is small at drain depth.

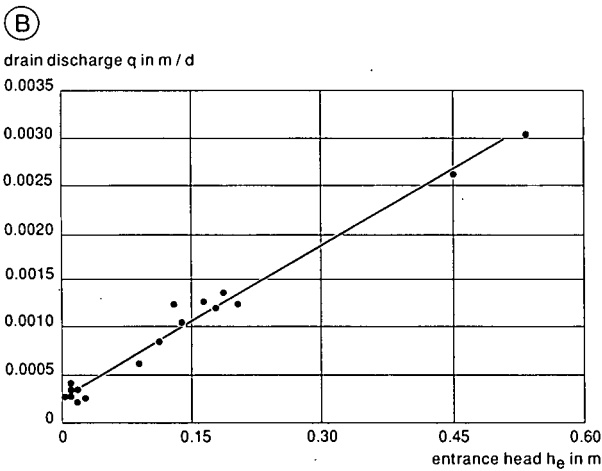
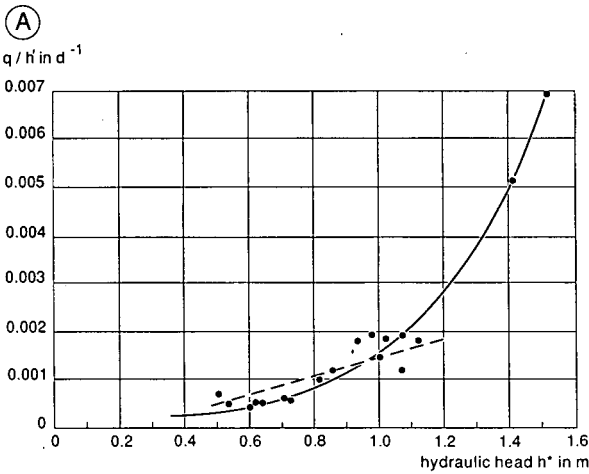

Figure 12.23 Plots of field data from the Leziria Grande (Example 12.4)
 A: The hydraulic conductivity above the drains decreases with depth
 B: Plot of drain discharge against entrance head

12.7.5 Ideal Drains, Medium Soil Depth

Example 12.5

Table 12.8 shows data on h and q in an experimental field with drain spacing $L = 20$ m and drain radius $r_o = 0.1$ m. The entrance resistance was assumed to be negligibly small, so the h_e -values were not measured. Hence, the drains are supposed to function as ideal drains and $h_e = 0$. Note that $h' = h^* = h$.

A plot of q/h versus h -values (Figure 12.24) suggests that the relationship between these two parameters is an upward-sloping straight line that does not pass through the origin, indicating that the flow to the drains occurs above and below the drain

Table 12.8 Data on drain discharge and available hydraulic head used in Example 12.5

No.	q (m/d)	h (m)	q/h (d ⁻¹)
1	0.00125	0.16	0.00781
2	0.00099	0.17	0.00582
3	0.00137	0.18	0.00761
4	0.00132	0.20	0.00660
5	0.00274	0.28	0.00979
6	0.00342	0.32	0.01069
7	0.00316	0.34	0.00929
8	0.00483	0.35	0.01380
9	0.00414	0.38	0.01089
10	0.00342	0.38	0.00900
11	0.00570	0.41	0.01390
12	0.00482	0.43	0.01121

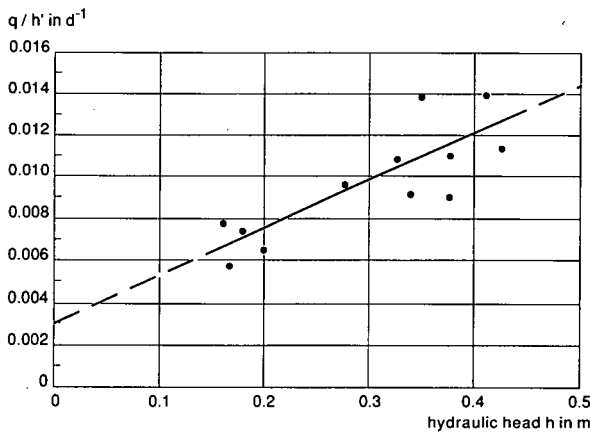

Figure 12.24 Plot of field data indicating flow above and below the drain level (Example 12.5)

level. Procedure 3 can therefore be applied, and a regression analysis is made.

Applying the principles explained in Section 12.7.3 and using Equations 12.23 to 12.25, we find

a) Regression of q/h upon h

$$\frac{q}{h} = 0.021 h + 0.0035$$

b) Regression of h upon q/h

$$h = 30.9 \frac{q}{h} - 0.0058$$

or

$$\frac{q}{h} = 0.032 h - 0.000019$$

The calculation of the K -values proceeds as follows. Using Equation 12.20, $a = 0.021$ yields $K_a = 2.6$ m/d, and $1/a' = 0.032$ yields $K_a = 4.1$ m/d. Using these values as the approximate confidence limits, we find that $2.6 < K_a < 4.1$ m/d. Similarly, $b = 0.0035$ yields $K_b d = 0.22$ m²/d, and $b'/a' = -0.000019$ yields $K_b d = -0.0012$ m²/d.

A comparison of the K_a - and $K_b d$ -values shows that the K_a -value is the dominating one, and that the $K_b d$ -value is statistically insignificant. Note that if we assume that the flow below drain level can be neglected, we can use Procedure 2 to analyze the data of Example 12.5 as well. This would give $\bar{K}_a = 4.3$ m/d, with a standard error of the mean of 0.26 m/d.

References

- Abrol, I.P., J.S.P. Yadav, and F.I. Massoud 1988. Salt-affected soils and their management. FAO Soils Bulletin 39, Rome, 131 p.
- Amer, M.H. and N.A. de Ridder 1989. Land drainage in Egypt. DRI, Cairo. 377 p.
- Anderson, S.H., and D.K. Cassel 1986. Statistical and autoregressive analysis of soil physical properties of Portsmouth sandy loam. Soil Science Society of American Journal 50, pp. 1096-1104.
- Aronovici, V.S. 1947. The mechanical analysis as an index of subsoil permeability. Soil Science Society of American Proc. 11, pp. 137-141.
- Ayers, R.S., and D.W. Westcott 1985. Water quality for agriculture. Rev. ed. Irrigation and Drainage Paper 29, FAO, Rome, 174 p.
- Bentley, W.J., R.W. Skaggs, and J.E. Parsons 1989. The effect of variation in hydraulic conductivity on watertable drawdown. Technical Bulletin, North Carolina Agricultural Research Service, North Carolina State University, 288, Raleigh, 23 p.
- Bouma, J., A. Jongerius, and D. Schoonderbeek 1979. Calculation of saturated hydraulic conductivity of some pedal clay soils using micromorphometric data. Soil Science Society of American Journal 43, pp. 261-264.
- Bouma, J., J.W. van Hoorn, and G.H. Stoffelsen 1981. Measuring the hydraulic conductivity of soil adjacent to tile drains in a heavy clay soil in The Netherlands. Journal of Hydrology 50, pp. 371-381.
- Boumans, J.H. 1976. Drainage calculations in stratified soils using the anisotropic soil model to simulate hydraulic conductivity conditions. In: J. Wesseling (ed.), Proceedings of the international drainage workshop. ILRI Publication 25, Wageningen, pp. 108-123.
- Bouwer, H., and R.D. Jackson 1974. Determining soil properties. In: J. van Schilfgarde (ed.), Drainage for Agriculture. Agronomy 17. American Society of Agronomy, Madison, pp. 611-672.
- Camp, C.R. 1977. Determination of hydraulic conductivity for a Louisiana alluvial soil. Third National Drainage Symposium Proceedings. American Society Agricultural Engineers, Michigan, pp. 1-77.
- Childs, E.C. 1943. The watertable, equipotentials and streamlines in drained land. Soil Science 56, pp. 317-330.
- De Ridder, N.A. and K.E. Wit 1965. A comparative study on the hydraulic conductivity of unconsolidated sediments. Journal of Hydrology 3, pp. 180-206.
- Dieleman, P.J., and B.D. Trafford 1976. Drainage testing. Irrigation and Drainage Paper 28, FAO, Rome, 172 p.
- El-Mowelhi, N.M., and J. van Schilfgarde 1982. Computation of soil hydrological constants from field drainage experiments in some soils in Egypt. Transaction of the American Society Agricultural Engineers, pp. 77-79.
- Kuntze, H. 1964. Einfluss der Dränung auf die Struktur des Marsch Bodens. Zeitschrift für Kulturtechnik und Flurbereinigung 5 (3), pp. 129-134.
- Marshall, T.J. 1957. Permeability and the size distribution of pores. Nature 180, pp. 664-665.

- Oosterbaan, R.J., A. Pissarra, and J.G. van Alphen 1989. Hydraulic head and discharge relations of pipe drainage systems with entrance resistance. Proceedings 15th European Regional Conference on Agricultural Water Management. Vol. III. ICID, Dubrovnik, pp. 86-98.
- Oosterbaan, R.J. 1990a. Single pipe drains with entrance resistance above a semi-confined aquifer. In: Symposium on Land Drainage for Salinity Control, Vol. 3. Cairo, pp. 36-46.
- Oosterbaan, R.J. 1990b. Parallel pipe drains with entrance resistance above a semi-confined aquifer with upward seepage. In: Symposium on Land Drainage for Salinity Control, Vol. 3. Cairo, pp. 26-35.
- Oosterbaan, R.J. and H.P. Ritzema 1992. Hooghoudt's drainage equation, adjusted for entrance resistance and sloping land. In: W.F. Vlotman (ed.), Proceedings 5th International Drainage Workshop, Vol. II. ICID/WAPDA, Lahore, pp. 2.18-2.28.
- Reynolds, W.D., and D.E. Elrick 1985. In-situ measurement of field saturated hydraulic conductivity, sorptivity, and the α -parameter, using the Guelph permeameter. Soil Science, 140, 4, pp. 292-302.
- Richards, L.A. (ed.) 1954. Diagnosis and improvement of saline and alkaline soils. Agriculture Handbook 60. USDA, Washington, 160 p.
- Scheltema, W. and H.Ch.P.M. Boons 1973. Al-clay, a solution to mechanical stability problems in a heavy clay soil? In: H. Dost (ed.), Acid sulphate soils : proceedings of the international symposium on acid sulphate soils. Vol. II. ILRI Publication 18, Wageningen, pp. 319-342.
- Smedema, L.K., and D.W. Rycroft 1983. Land drainage : planning and design of Agricultural Drainage Systems. Batsford, London, 376 p.
- Van Beers, W.F.J. 1970. The auger-hole method : a field measurement of the hydraulic conductivity of soil below the watertable. Rev. ed. ILRI Bulletin 1, Wageningen, 32 p.
- Van Hoorn, J.W. 1958. Results of a groundwater level experimental field with arable crops on a clay soil. Netherlands Journal Agricultural Science, 6, pp. 1-10.
- Wit, K.E. 1967. Apparatus for measuring hydraulic conductivity of undisturbed soil samples. Technical Bulletin 52. Institute for Land and Water Management Research, Wageningen, 12 p.
- Wösten, J.H.M. 1990. Use of soil survey data to improve simulation of water movement in soils. Thesis, Agricultural University, Wageningen, 103 p.
- Zangar, C.N. 1953. Theory and problems of water percolation. U.S. Bureau of Reclamation. Engineering Monograph No. 8, Denver, 76 p.

13 Land Subsidence

R.J. de Glopper¹ and H.P. Ritzema²

13.1 Introduction

Subsidence is the downward movement of the ground surface. The term 'subsidence' includes one or more of the following processes:

- Compression/Compaction: Compression is the change in soil volume produced by the application of a static external load. Compaction is produced artificially by momentary load application such as rolling, tamping, or vibration (USDI 1974);
- Consolidation: The gradual, slow compression of a cohesive soil due to weight acting on it, which occurs as water, or water and air, are driven out of the voids in the soil (Scott 1981);
- Shrinkage: The change in soil volume produced by capillary stress during drying of the soil (USDI 1974);
- Oxidation: The process by which organic carbon is converted to carbon dioxide and lost to the atmosphere (Young 1980).

A prediction of possible subsidence and its magnitude is of great importance in a land reclamation or drainage project (Section 13.2). The effect of compression of clay and sandy subsoils, and their possible consolidation, can be calculated with standard equations of soil mechanics (Section 13.3). These equations, however, are not appropriate for predicting the topsoil shrinkage of newly reclaimed clay or peat soils. Instead, Section 13.4, after explaining the process of physical ripening, presents two methods by which this shrinkage can be predicted: an empirical method and a numerical simulation method. Section 13.5 treats the subsidence of organic soils. Finally, Section 13.6 concludes this chapter with the calculation of the total subsidence and a discussion of the applicability of the various methods.

13.2 Subsidence in relation to Drainage

Of the four processes recognized in the previous section, those that involve soil mechanics are compression/compaction and consolidation; they occur both naturally and by man's manipulation (Allen 1984). Consolidation only occurs in clays or other soils of low permeability. Consolidation is not the same as compaction, which is a mechanical, immediate process, which only occurs in soils with at least some sand. The amount of subsidence brought about by these processes is a function of the pore space in the original material, the effectiveness of the compacting mechanism, and the thickness of the deposit undergoing compaction.

Shrinkage is a process involving soil physics. Irreversible shrinkage can occur as the result of the physical ripening of a newly reclaimed soil. The subsidence that results

¹ Retired from the Department of Public Works and Water Management, Flevoland Directorate, Lelystad

² International Institute for Land Reclamation and Improvement

from shrinkage is mainly a function of the moisture content of the soil and the abstraction of soil water by evapotranspiration.

Oxidation is a biochemical process that occurs in organic soils. It is caused by microorganisms utilizing organic compounds as sources of both energy and carbon. The process depends on the air and water conditions in the soil.

The subsidence of agricultural land can be caused by many processes, the most important of which are:

- 1) Compression – and consolidation if the material is clay or peat – as a result of a lowering of the watertable to improve the drainage conditions in waterlogged areas;
- 2) Compression – and consolidation if the material is clay or peat – of deep layers as a result of the extraction of gas, oil, or water (for irrigation or other purposes). The mechanisms involved are the same as in 1), but the effect can be much more severe if the watertable is lowered to extreme depths. In California, groundwater withdrawal has led to land subsidence of as much as 9 m (Poland 1984);
- 3) Compression – and consolidation if the material is clay or peat – of the subsoil by an overburden that has been placed on the soil (e.g. a canal embankment);
- 4) Irreversible shrinkage as a result of the physical ripening of soft sediments after an improvement in the drainage conditions;
- 5) Loss of soil particles as a result of the oxidation of organic matter;
- 6) Loss of soil particles as a result of the leaching of mineral components. This loss is generally so small that it can be neglected;
- 7) Hydrocompaction as a result of the moistening of very loose and dry fine-textured sediments in arid regions. Hydrocompaction is mainly associated with irrigation projects underlain by loess and mudflow deposits and is beyond the scope of this chapter. A review of subsidence caused by hydrocompaction is presented by Lofgren (1969);
- 8) Tectonic movements, the subsurface solution of rock salt, gypsum, or carbonate rocks, and activities like mining can all cause subsidence (Allen 1984), but these topics are also beyond the scope of this chapter.

In the planning of agricultural land drainage projects, subsidence can have effects on land use, on drainage, and on buildings, structures, and embankments, as will be discussed below.

Land Use

Subsidence can be a major factor in assessing the potential for land reclamation. The reclamation of peat soils will always result in the oxidation of these layers; the rate at which this occurs will determine the feasibility of the project. The effect of oxidation can be seen in the western part of The Netherlands, where, since their reclamation in the Middle Ages, peat areas have gradually subsided from 0.5 m above mean sea level to 1 to 2 m below. So, over a period of 8 to 10 centuries, the surface has subsided about 2 m, in spite of a continuously shallow drainage. Some 85% of this subsidence can be ascribed to the oxidation of organic matter, which will continue at a rate of 2 mm/year (Schothorst 1982). Drainage has a direct effect on this rate of subsidence; for example, a 0.50 m deeper drainage, needed for a shift from pasture to grain crops, will increase the subsidence rate to 6 mm/year.

Subsidence also alters the soil conditions. Recently drained clay soils are soft and impassable. The process of physical ripening will result in a better workability and a higher load-bearing capacity, and will thus increase the number of workable days. On the other hand, shrinkage may reduce the water-holding capacity; soils may then become susceptible to drought and may require irrigation in the future.

Drainage

Subsidence will affect the future elevation of the reclaimed area. Consequently, it will affect the water levels in the drainage system, the possibility of drainage by gravity, and the lift and capacity of pumping stations. It will increase or decrease (or even reverse) the longitudinal slopes in the main drain system, the elevation of sills and sluices, and the crest heights of weirs and revetments. Unlike compaction, which is an immediate process, consolidation will continue for considerable time, so provisions have to be made in the design to guarantee the future use. Moreover, subsidence often varies over short distances, depending on variations in the thickness and softness of the subsiding layer. This may disarrange the drainage and irrigation systems.

The importance of a correct prediction of subsidence is demonstrated in the IJsselmeerpolders in The Netherlands. There, in the first century after reclamation, subsidence will vary between 0.50 and 1.50 m (De Glopper 1989). Compared with other areas (e.g. California, Mexico City), where subsidence of as much as 5 to 9 m has been observed, these values are relatively small, but the consequences are nevertheless far-reaching.

Buildings, Structures, and Embankments

In areas with low bearing capacities, buildings and structures have to be built on pile foundations. Subsidence will change the relative elevation of piled buildings and structures with respect to the surrounding area. The areas surrounding these buildings and structures will have to be raised from time to time by the addition of earth or other fill material; this, in its turn, will cause additional subsidence. Special measures have to be taken in connecting utilities (power lines, water mains, etc.).

On soils with soft clay or peat layers, the design height of embankments has to be corrected to take the future subsidence into account; otherwise, the safety requirements may not be met.

The factors that influence the rate and degree of subsidence are the following (Segeren and Smits 1980):

- Clay content: The water content in sediments is linearly related to their clay content; hence clayey sediments lose more water than sandy sediments. As a consequence, clay soils will subside more;
- Depth of the layer in the profile: The loss of water in the different soil layers decreases with depth. The number of roots and their water uptake similarly decrease with depth. Beside this, deeper layers are closer to the watertable and will thus be kept moist by capillary rise. So the subsidence caused by the shrinkage of the different soil layers at a given clay content decreases with depth;
- The thickness of compressible layers: The greater the thickness of the compressible layers, the greater will be the subsidence;
- Organic matter content: The water content depends to some extent on the organic

matter content. Mineral soils containing high contents of organic matter show greater degrees of subsidence. The oxidation of the organic matter not only results in the loss of the organic matter, but also in the loss of the water associated with it;

- Type of crop: As different crops are characterized by different evapotranspiration rates, their influence on subsidence also differs. The difference may be due to the depth of the rooting system; compare, for instance, alfalfa with its deep rooting system and grass with its shallow rooting system. The length of the growing period is another important factor: spring-sown cereals harvested in midsummer have a lower total evapotranspiration than perennial crops like grass or alfalfa;
- Density of the soil: Sediments with different pore volumes (and different water contents) show different water losses and hence different degrees of subsidence. Sea- and lake-bottom soils have a lower density than sea-shore deposits exposed at each low tide. During the formation of such sea-shore deposits, shrinkage already occurs and thus also subsidence;
- Field drainage conditions: Under poor drainage conditions, which often prevail in the first years after reclamation, the shrinkage may be limited because the watertable is still high and consequently the capillary stresses are low. Thus, under these conditions, the rate of subsidence will be less than in well-drained soils;
- Climatic conditions: The drier the climate, the more water will be lost, and hence the greater will be the subsidence;
- Time: Subsidence, both that caused by consolidation and that by shrinkage, is a function of time. As shrinkage is caused by the physical ripening of the soil, the rate of subsidence will decrease with time.

The influence of the above-mentioned factors on each of the processes involved in subsidence will be discussed in the following sections.

13.3 Compression and Consolidation

In the theory of both compression and consolidation, which are the soil mechanical components of subsidence, the crucial factor is the intergranular pressure or effective stress in the soil (Section 13.3.1). The factor time is not considered in the compression of sandy soils; each change in pressure, brought about by an increased load or a lowering of the watertable, results in an instantaneous subsidence. For clay or peat soils, however, the process is much more complicated, and the factor time becomes important. The subsidence in such soils can be calculated with Terzaghi's consolidation theory (Section 13.3.2). The problems one faces in using the consolidation equations are discussed in Section 13.3.3.

13.3.1 Intergranular Pressure

Soil consists of three components: solids or granules, air, and water (Chapter 11). In this section, we consider a fully saturated soil profile; thus all pores are completely filled with water.

The intergranular pressure or effective stress is defined as the pressure transmitted through the contact points of the individual solids (Bouwer 1978). If we increase the intergranular pressure (e.g. by placing a load on top of the soil or by lowering the watertable), the individual solids move relative to each other to produce a lower void ratio; hence the material is compressed.

The void ratio is defined as the volume occupied by the voids (pores), divided by the volume of the solids.

The intergranular pressure at a given depth can be calculated as the difference between the total ground pressure and the hydraulic pressure at that depth (Terzaghi and Peck 1967)

$$p_i = p_t - p_h \quad (13.1)$$

in which

p_i = intergranular pressure or effective stress (kPa)

p_t = total ground pressure (kPa)

p_h = hydraulic or water pressure (kPa)

This equation becomes clear if we consider the vertical forces acting on an imaginary horizontal plane. The downward force on the plane is equal to the weight of the soil and the groundwater above it. But, because of hydraulic pressure, there is also an upward force against the bottom of the plane. The difference between the downward and the upward forces is the net load on the plane, which acts on the individual solids at their contact points. The total pressure at a given depth is calculated as the weight per unit area of all solids and groundwater above that point.

How the different soil pressures are calculated is demonstrated in Example 13.1.

Example 13.1

The watertable in a soft clay layer (6 m thick) on top of a non-subsiding dense sand layer reaches the ground surface (Figure 13.1). The porosity of the clay layer (ϵ), which is defined as the ratio between the volume of voids V_v and the total volume V (Chapter 3.4.2), is 0.75. The density of the solids (ρ_s) is 2660 kg/m³. What will happen to the intergranular pressure if the watertable is lowered 1 m and if we assume that the soil in the top 1.0 m will continue to be saturated?

The mass of the solids in 1 m³ of the clay layer is

$$m_s = (1 - \epsilon) \rho_s = (1 - 0.75) \times 2660 = 665 \text{ kg}$$

and the mass of the water ($\rho_w = 1000 \text{ kg/m}^3$) filling the pores between the solids is

$$m_w = \epsilon \times \rho_w = 0.75 \times 1000 = 750 \text{ kg}$$

Thus the wet bulk density of the clay layer is

$$\rho_{wb} = 665 + 750 = 1415 \text{ kg/m}^3$$

At 4.0 m below the ground surface, the total pressure equals

$$p_t = \rho_{wb} g h = 1415 \times 10 \times 4.0 = 56\,600 \text{ Pa} = 56.6 \text{ kPa}$$

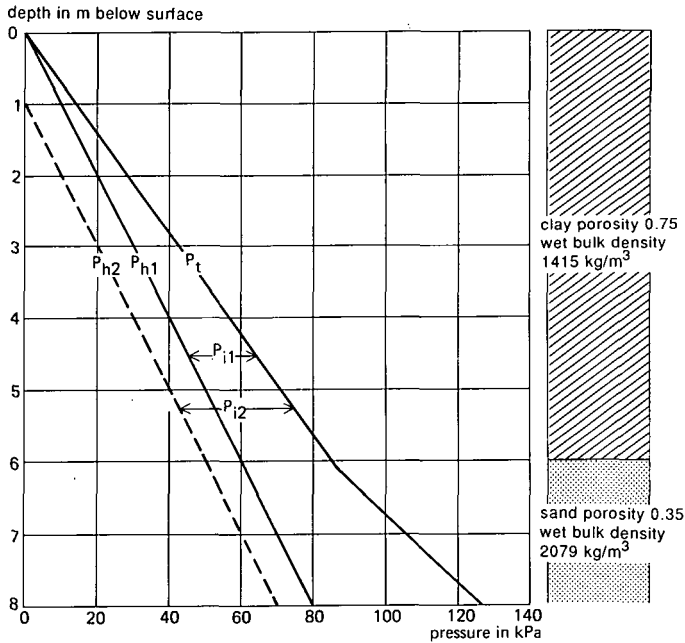

Figure 13.1 The relationship between the total pressure (p_t), the hydraulic pressure before (p_{h1}) and after (p_{h2}) the watertable is lowered, and the matching intergranular pressures (p_{i1} and p_{i2}) in a soft clay overlying a dense sand (Example 13.1)

in which

$$g = \text{acceleration due to gravity } (\approx 10 \text{ m/s}^2)$$

$$h = \text{hydraulic head (m)}$$

The water or hydraulic pressure at this level is

$$p_h = \rho_w g h = 1000 \times 10 \times 4.0 = 40.0 \text{ kPa}$$

Hence the intergranular pressure is (Equation 13.1)

$$p_i = p_t - p_h = 56.6 - 40.0 = 16.6 \text{ kPa}$$

Lowering the watertable by 1.0 m reduces the hydraulic pressure by 10.0 kPa. This lower value of p_h is indicated by the dotted line in Figure 13.1. Because we have assumed that the soil in the top 1.0 m remains saturated, the total pressure will not change and thus the intergranular pressure will increase. At the depth of 4.0 m, for example, the total ground pressure is still 56.6 kPa, but the hydraulic pressure has decreased to

$$P_h = 1000 \times (4 - 1) \times 10.0 = 30.0 \text{ kPa}$$

and thus the intergranular pressure becomes

$$P_i = 56.6 - 30.0 = 26.6 \text{ kPa}$$

An increase in the intergranular pressure results in a decrease in the void ratio, and

hence a compression of the soil layer, and consequently a subsidence of the ground surface, as discussed below.

13.3.2 Terzaghi's Consolidation Theory

If the watertable is lowered or a load (e.g. an embankment) is placed on the soil surface, the intergranular pressure in the soil profile will increase. The subsidence resulting from this increase in soil pressure can be described by the classical theory of soil mechanics developed by Terzaghi in 1925 (Terzaghi and Peck 1967). This theory is based on the following assumptions:

- The soil is homogeneous and completely saturated with water;
- The solids and the water are incompressible;
- The hydraulic conductivity is constant during the consolidation process.

Terzaghi found a relation between the increase in intergranular pressure and the void ratio

$$e_u = e_i - C_c \ln \frac{p_i + \Delta p_i}{p_i} \quad (13.2)$$

in which

e_u = ultimate void ratio (= ratio between the ultimate volume of pores and the volume of solids; -)

e_i = initial void ratio (= ratio between the initial volume of pores and the volume of solids; -)

C_c = compression index (-)

p_i = average intergranular pressure in the considered soil layer before the loading and/or the lowering of the watertable (kPa)

Δp_i = increase in the average intergranular pressure after loading and/or lowering the watertable (kPa)

The increase in pressure can be caused by an external load on the surface or by a lowering of the watertable. As the solids are incompressible and no solids are lost, the subsidence can be solely attributed to a decrease in the volume of voids (Figure 13.2).

$$S = \frac{e_i - e_u}{e_i + 1} \times D \quad (13.3)$$

in which

S = subsidence (m)

D = thickness of the original soil layer (m)

We can express the subsidence as a function of the intergranular pressure by substituting Equation 13.2 into Equation 13.3

$$S = \frac{1}{c} \ln \left(\frac{p_i + \Delta p_i}{p_i} \right) \times D \quad (13.4)$$

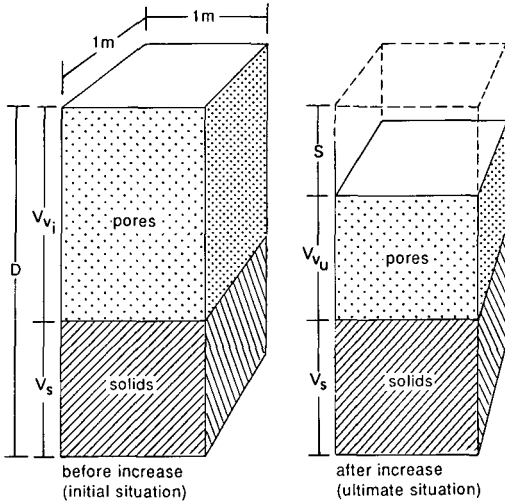

initial void ratio:

$$e_i = \frac{V_{v_i}}{V_s} \left(= \frac{\text{initial volume of voids}}{\text{volume of solids}} \right) \longrightarrow V_{v_i} = e_i V_s$$

ultimate void ratio:

$$e_u = \frac{V_{v_u}}{V_s} \left(= \frac{\text{ultimate volume of voids}}{\text{volume of solids}} \right) \longrightarrow V_{v_u} = e_u V_s$$

$$\frac{S}{D} = \frac{V_{v_i} - V_{v_u}}{V_{v_i} + V_s} = \frac{e_i V_s - e_u V_s}{e_i V_s + V_s} = \frac{e_i - e_u}{e_i + 1}$$

Figure 13.2 Subsidence as the difference between the initial and ultimate volume of voids before and after the increase in intergranular pressure

in which

$$c = \text{compression constant} \left(= \frac{C_c}{e_i + 1} \right)$$

The value of the compression constant c depends on the soil type. An indication of magnitudes is given in Table 13.1.

The exact value for a specific soil is difficult to establish, as will be discussed in Section 13.3.3. If the compression constant is known, the subsidence can be calculated, as will be demonstrated in Example 13.2.

Table 13.1 Indication of values of the compression constant c (after Euroconsult 1989)

Soil type	Range	
Sand, densely packed	100	- 200
Sand, loosely packed	20	- 100
Clay loam	20	- 30
Clay	10	- 25
Peat	2	- 10

Example 13.2

Considering the same soil profile as in Example 13.1, we shall calculate the subsidence of the ground surface caused by the compression of the clay layer. The compression constant has been determined in a laboratory and equals 12. The calculation is based on the averages of the hydraulic and intergranular pressure before and after the watertable is lowered. Before the watertable is lowered, the pressures at 6.0 m depth are

$$\text{Total pressure: } p_t = \rho_{wb} g h = 1415 \times 10 \times 6.0 = 84.9 \text{ kPa}$$

$$\text{Hydraulic pressure: } p_h = \rho_w g h = 1000 \times 10 \times 6.0 = 60.0 \text{ kPa}$$

Thus the intergranular pressure at this depth is (Equation 13.1)

$$p_i = p_t - p_h = 84.9 - 60.0 = 24.9 \text{ kPa}$$

After the watertable is lowered, the total pressure remains the same (because we have assumed that the soil profile remains saturated up to the surface). However, the hydraulic pressure decreases and, consequently, the intergranular pressure increases. At 6.0 m depth, these pressures become respectively

$$p_h = 1000 \times 10 \times 5.0 = 50.0 \text{ kPa}$$

$$p_i = p_t - p_h = 84.9 - 50.0 = 34.9 \text{ kPa}$$

To calculate the compression of the clay layer, we first have to calculate the average pressures in this layer, both before and after the watertable is lowered. Before the watertable is lowered the average intergranular pressure is $42.45 - 30.0 = 12.45$ KPa and after the watertable is lowered this has become $42.45 - 25.0 = 17.45$ KPa. The increase in the average intergranular pressure is

$$\Delta p_i = 17.45 - 12.45 = 5.0 \text{ kPa}$$

We can now calculate the total compression with Equation 13.4

$$S = \frac{1}{c} \ln \left(\frac{p_i + \Delta p_i}{p_i} \right) \times D = \frac{1}{12} \ln \left(\frac{12.45 + 5.0}{12.45} \right) \times 6.0 = 0.17 \text{ m}$$

The problem is more complicated if we do not assume that the soil above the watertable remains saturated. In that case, the unsaturated top layer will have a different wet bulk density and we have to divide the clay profile into two layers: one layer above the watertable and one below it. We can now calculate the compression of each layer in the same way as we did in Example 13.2.

The above equations do not take the factor time into consideration. In them, it is assumed that an increase in intergranular pressure results in an instantaneous subsidence. As stated earlier, this assumption is valid for sandy soils, but, for clay or peat soils, subsidence will continue for a long time. Keverlingh Buisman (1940) showed that, for these soils, the subsidence proceeds proportionally with the logarithm of time. Koppejan (1948) combined the relations found by Terzaghi and Keverlingh Buisman into one equation, which reads

$$S(t) = \left[\left(\frac{1}{c_p} + \frac{1}{c_s} \log t \right) \ln \left(\frac{p_i + \Delta p_i}{p_i} \right) \right] \times D \quad (13.5)$$

in which

- $S(t)$ = subsidence as a function of time (m)
- c_p = consolidation constant (direct effect; -)
- c_s = consolidation constant (secular effect; -)
- t = time since loading or lowering the watertable (days)

The consolidation constants stand for, respectively, the direct and the secular effect of the subsidence. The direct effect is that part of the subsidence that occurs the first day after the load increase. The secular effect stands for that part of the subsidence that occurs as the excess water is drained out of the soil profile. This is a very slow process, especially in clay soils, because of their low hydraulic conductivity. The secular effect will cause the subsidence to continue indefinitely.

Equation 13.5 is based on the assumption that c_p and c_s are independent of the size of the load, but c_p depends on the selected time period (one day).

13.3.3 Application of the Consolidation Equations

In applying the consolidation theory, we face a number of problems. Difficulties arise in determining not only the consolidation constants but also the total and the hydraulic pressures.

Determining the Consolidation Constants

Small undisturbed soil samples are used to determine the consolidation constants. The samples are contained in a ring (height 20 mm, diameter 64 mm) and placed in a consolidometer. In this apparatus, the top and bottom of the sample are confined by porous plates to allow the excess water to drain from the sample after it is loaded and consequently compressed. The load applied is increased step by step, and the subsidence is measured after each step (Figure 13.3). From the relation between the subsidence, the applied load, and the time, we can derive the consolidation constants. A similar test is described in *The Earth Manual* (USDI 1974).

The small samples (64 cm³) used to determine the consolidation constants are not very representative because soil is a highly heterogeneous medium, especially if such samples are supposed to be representative of vast areas. Collecting the samples with soil-drilling equipment and testing them in the laboratory are both costly affairs. There is therefore a tendency to restrict the number of samples taken, which reduces their reliability even further.

An alternative way of calculating the consolidation constants has proved successful in The Netherlands. With this method, consolidation constants are estimated from the initial porosity, because clear correlations were established (Figure 13.4). The advantages of this method are:

- The same data can be used as are needed to calculate the wet bulk density (required for calculating the total pressure);
- The sampling is less complicated because disturbed samples can be used. In soft soil layers, a simple hand-auger set can take samples to a depth of 10 m;
- The volume of the samples is much larger, about 1500 to 2000 cm³, which is some 25 to 30 times larger than those used in a consolidometer. They are thus more

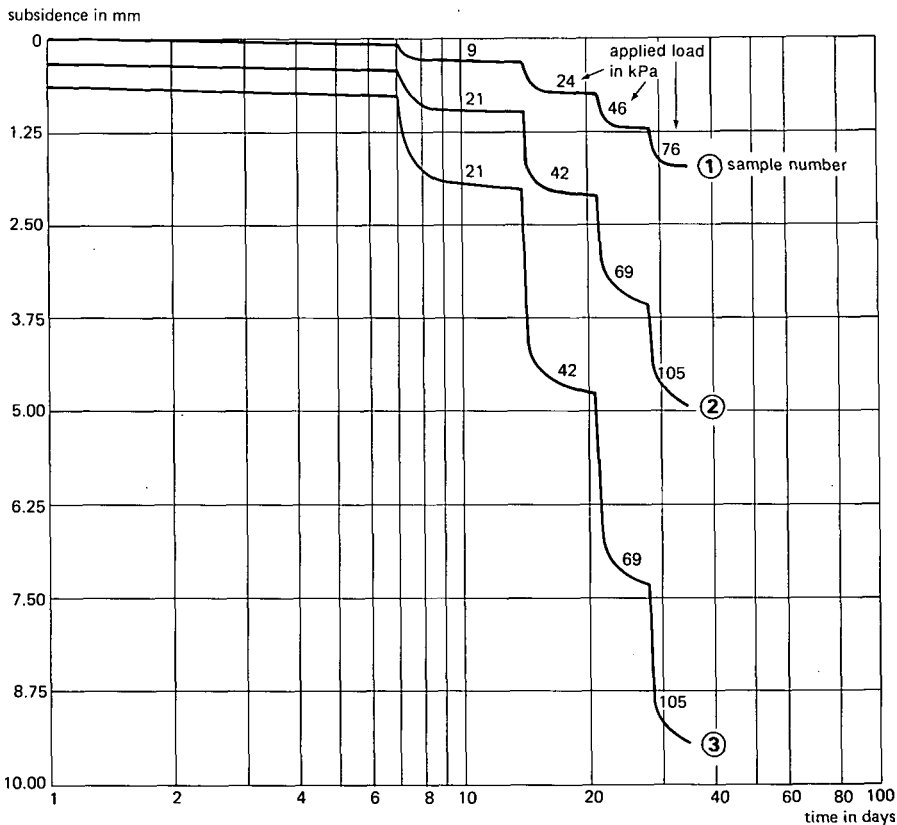

Figure 13.3 Results of consolidometer tests for a loamy (Sample 1), a clay (Sample 2) and a peat (Sample 3) soil

representative. As a rule of thumb, it is recommended to take at least five borings, 2 to 4 m apart, and to combine these for each soil-layer into one sample;

- The cost of collecting and analyzing the samples is remarkably lower; it is estimated to be only 10 to 25% of the cost of the conventional method (De Gloopper 1977).

Determining the Total and the Hydraulic Pressure

To determine the total pressure, we have to know the wet bulk density (Section 13.3.1), and to obtain the wet bulk density, we have to collect soil samples from the subsiding soil layers. These samples can be difficult to collect because the area may not be easily accessible, and collecting samples from deeper layers may require heavy soil-sampling equipment. However, as explained earlier, obtaining the wet bulk density is a lot easier than obtaining representative values of the consolidation constants. (The calculation of the wet bulk density is treated in Chapter 11.)

Determining the hydraulic pressure can also be problematical: often, the distribution of the hydraulic pressure is not hydrostatic because of differences in the hydraulic conductivity of the successive soil layers (Figure 13.5). Although most newly reclaimed soils have a high porosity, their hydraulic conductivity is often extremely

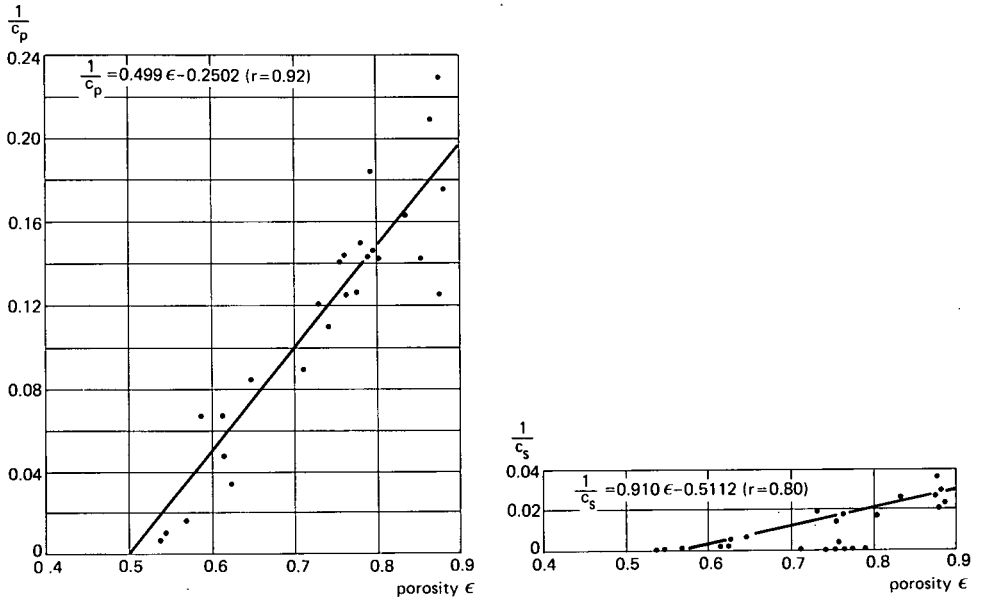

Figure 13.4 The relationship between the consolidation constants (c_p and c_s) and the porosity (ϵ) of some soils in the IJsselmeerpolders (De Glopper 1977)

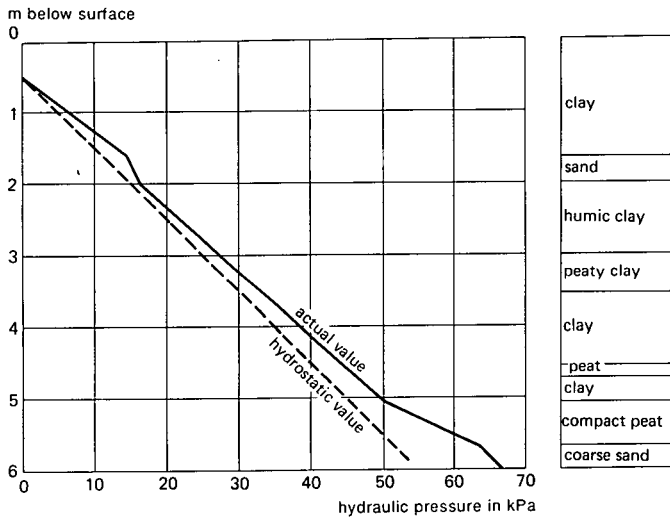

Figure 13.5 An example of a non-hydrostatic relationship between the hydraulic pressure and the depth below surface in a profile consisting of soft layers with varying hydraulic conductivities, overlying a permeable sandy subsoil under overpressure (De Glopper 1973)

low (in the range of 0.1 to 10 mm/d) because of the small diameter of the pores (a few microns). To obtain the distribution of the hydraulic pressure in the soil profile, one has to install piezometers at various depths and record their readings over a long period (Chapter 2).

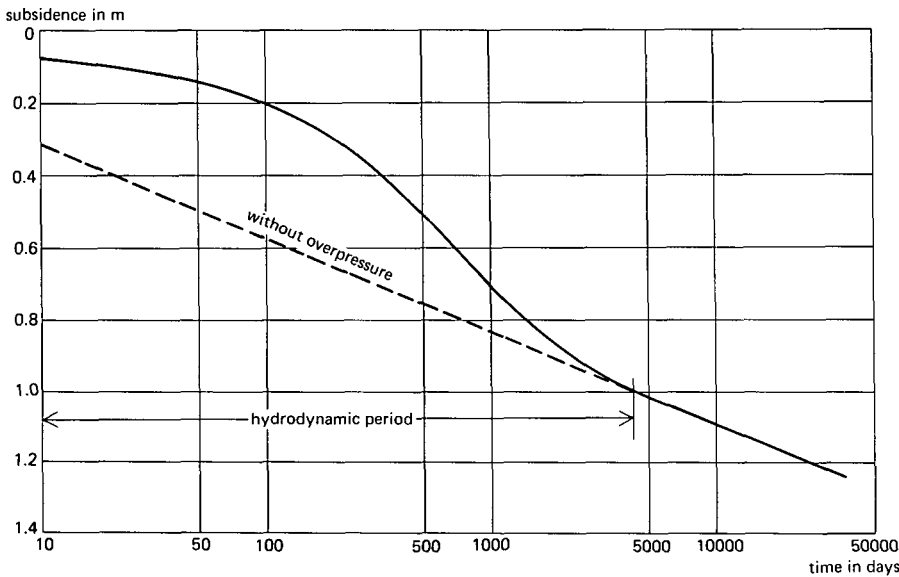

Figure 13.6 The subsidence is retarded for a period of 10 years because of the overpressure of the water in the soil (sand load 1.3 m; thickness of the soft layers 5.6 m) (Courtesy of J.E.G. Bouman)

A decrease in the hydraulic pressure involves the release of excess water. The low hydraulic conductivity retards this release, resulting in hydraulic overpressure (Figure 13.6). The period during which this overpressure exists is called the hydrodynamic period; it may cover some weeks to several years, in extreme cases even 10 to 20 years. Fortunately, for a prediction of the subsidence in reclamation projects, the length of this period is of less importance because the period for which a prediction is needed (50 to 100 years) generally exceeds the hydrodynamic period. In civil engineering, the hydrodynamic period is much more important (e.g. in stability calculations for earth structures).

To calculate the subsidence, the equations derived by Terzaghi, Keverlingh Buisman and Koppejan can be combined into a simple computer model, see for example Viergever (1991). However, the assumptions on which the consolidation theory is based clearly restrict the use of the equations; they are only valid if the subsiding soil layers remain saturated. Whilst this is generally true with groundwater extraction from aquifers, for example, it is not so in land reclamation projects, where much of the subsidence occurs because of the physical ripening of the topsoil through a lowering of the watertable. The consolidation theory does not take this process into account and another approach has to be followed. This will be discussed in the next section.

13.4 Shrinkage of Newly Reclaimed Soils

Shrinkage was defined in Section 13.1 as the change in soil volume produced by capillary stress during drying of the soil. Basically, the shrinkage of the topsoil is

governed by the same soil-mechanical processes as is compression and, in principle, the same equations can be used. However, the consolidation theory is based on the assumption that the soil profile remains saturated and in newly reclaimed soil this is not true, especially not in the topsoil. The soil starts to dry under the influence of the weather and the vegetation. This process is called soil ripening; it changes the soil-moisture suction, which, in its turn, influences the ultimate intergranular pressure. The soil-moisture suction varies considerably throughout the year because of the variation in weather conditions and the stage of crop development; it is therefore difficult to select a representative value for the intergranular pressure. Besides this, the contracting effect of a given soil-moisture suction decreases with increasing density of the soil (Rijniersce 1983). As the soil becomes compacted in the course of time, the value of the intergranular pressure should also be adjusted accordingly. So it is obvious that, because no definite representative value of the ultimate intergranular pressure can be selected, the use of the consolidation equations is restricted.

Two other methods of predicting subsidence due to the shrinkage of the topsoil will be discussed below:

- An empirical method based on the comparison of the changes in specific volume before reclamation and at a given point in time after reclamation (Section 13.4.2);
- A numerical method, which was developed to simulate the ripening process of the soils in the IJsselmeerpolders (Section 13.4.3).

But first the soil-ripening process will be explained.

13.4.1 The Soil-Ripening Process

The reclamation of marine, alluvial, and fluvial soils basically means improving their drainage conditions. Improving the natural drainage conditions, but even more so by introducing a drainage system, will start a process known as soil ripening. The soil-ripening process includes all physical, chemical, and biological processes by which a freshly-deposited mud is transformed into a dryland soil (Smits et al. 1962).

The soil-ripening process is also called *initial soil formation* or *initial pedogenesis* and should not be confused with soil-forming processes. Soil-forming processes, such as weathering and subsequent leaching (e.g. the formation of texture B-horizons, laterites, etc.), proceed very slowly; it may take centuries before the first results become visible. The soil-ripening process, on the other hand, results from a sudden change in the environmental conditions (i.e. drainage) and proceeds rapidly. Remarkable changes in important soil characteristics like the water content, density, etc., can be noticed from one year to another, particularly during the first years after reclamation.

The process of soil ripening can be divided into three categories (Pons and Zonneveld 1965):

- Physical ripening, which mainly comprises physical symptoms that are directly related to the irreversible dehydration of the soil. It involves changes in the soil's water content, volume, consistency, and structure;
- Chemical ripening, which comprises all chemical and physico-chemical changes such as changes in the quality and quantity of absorbed cations of the adsorption complex, the reduction and oxidation of iron sulfides, changes in the organic matter content, etc.;

– Biological ripening, which comprises aspects of the ripening process that are influenced by organisms: for example, the number of bacteria species, vegetation, oxidation of organic matter, etc.

All three categories proceed simultaneously and influence one another, so it is difficult to separate them. In this section, we shall concentrate on those aspects of physical ripening that result in shrinkage. (The oxidation of peat soil, which is a combination of physical, chemical, and biological ripening, will be discussed in Section 13.5.)

After reclamation, the soil starts to dry, either by evaporation from the surface or, more importantly, by transpiration through the plants. In dry periods, the soil-moisture suction increases, particularly in the topsoil. The loose soil particles cannot withstand the contracting capillary stresses, so they begin to contract, resulting in shrinkage. For the greater part, the loss of water and the subsequent shrinkage is irreversible. The process is also influenced by the climate and the cropping pattern; in wet periods, the soil moisture content increases again and the shrinkage comes to a temporary standstill (Figure 13.7).

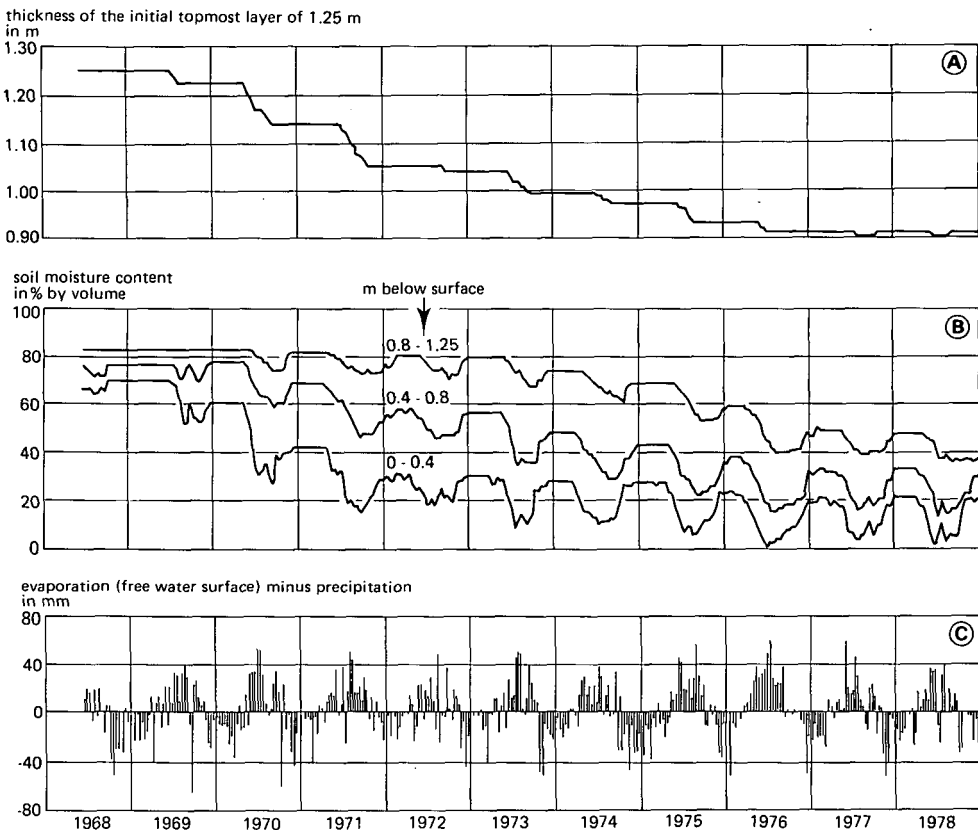

Figure 13.7 A: Shrinkage of the topsoil as a result of B: the decrease in water content resulting from C: variations in evaporation surpluses (From data of Rijniersce 1983; calculated with the model FYRYMO by G.A.M. Menting)

The contraction of the soil particles, caused by the increase in capillary stress during dry periods, results in an all-round shrinkage of the soil. The vertical component of this shrinkage causes subsidence of the ground surface and the horizontal component the formation of cracks. Cracks develop from the ground surface in a hexagonal pattern (Figure 13.8); they are widest at the ground surface and become narrower deeper in the profile. In the course of time, the cracks develop deeper in the profile until a new equilibrium is reached with the changed hydrological conditions after reclamation.

The formation of cracks results in two important changes in the soil profile:

- The internal drainage capacity increases significantly. The hydraulic conductivity, which is very low in the unripe soil (0.1 to 10 mm/d), can reach values of 100 000 mm/d in cracked soils. In fact, hydraulic conductivity is not the correct term because the conductivity of the soil columns in between the cracks remains low. Measuring such high conductivities is difficult and the results are most times unreliable. Only large-scale field methods (Chapter 12) will give reliable estimates. Without the formation of cracks, the hydraulic conductivity in heavy clay soils remains low and the installation of a subsurface drainage system would be insufficient to control the watertable;
- A direct result of lowering the watertable is that air enters the soil profile, thus changing the soil from a reduced to an oxidized state (aeration). The cracks play an important role in this aeration. Aeration can be observed by a change in colour of the soil from bluish-black to grey with brown mottles (oxidation of iron sulfides).



Figure 13.8 Crack formation in a recently reclaimed soft soil (De Glopper 1989)

It is, in fact, this aeration that makes the cultivation of arable crops possible, because crops cannot grow in a reduced soil (with the exception of wetland rice).

In the field, one can assess five levels of physical ripening by squeezing the soil in the hand (Pons and Zonneveld 1965, and Dent 1986):

- Ripe material is firm, not particularly sticky, and cannot be squeezed through the fingers;
- Nearly ripe material is fairly firm; it tends to stick to the hands, and can be kneaded but not squeezed through the fingers. If it is not churned up, it will support the weight of stock and ordinary wheeled vehicles;
- Half-ripe mud is fairly soft, sticky, and can be squeezed through the fingers. A man will sink ankle-to-knee-deep unless supported by vegetation;
- Practically unripe mud is very soft, sticks fast to everything, and can be squeezed through the fingers by very gentle pressure. A man will sink in to his thighs unless supported by vegetation;
- Totally unripe mud is fluid; it flows between the fingers without being squeezed.

To measure the degree of physical ripening, Pons and Zonneveld (1965) introduced the water factor (n), which is defined as the mass of water (kg) held by one kg of the clay fraction. Table 13.2 presents the relation between the degree of ripening, the water factor, and the water content. A more extensive review of n -values for many types of soils all over the world is presented by Pons and Zonneveld (1965).

A relation was established between the water content, the water factor, and the mineral (clay) and organic matter content (De Glopper 1989)

$$w = c + n(f_c + b f_o) \quad (13.6)$$

in which

- w = water content (ratio between the mass of soil water and the mass of dry solids; see Chapter 3.4.2 (-))
- c = constant, its value being about 0.20; c ranges from 0.18 to 0.22; if insufficient data are available, 0.20 is a good estimate (-)
- n = water factor, indicating the mass of water (kg) held by 1 kg of clay (-)
- f_c = clay content expressed as a fraction of the total dry mass (-)
- b = ratio between the mass of water held by 1 kg of organic matter and the mass of water held by 1 kg of clay (-)
- f_o = organic matter content expressed as a fraction of the total dry mass (-)

Table 13.2 Classification of soils according to physical ripening (after Pons and Zonneveld 1965)*

Classification	Water factor	Water content
Ripe	< 0.7	< 0.50
Nearly ripe	0.7 - 1.0	0.50 - 0.60
Half ripe	1.0 - 1.4	0.60 - 0.70
Practically ripe	1.4 - 2.0	0.70 - 0.80
Unripe	> 2.0	> 0.80

* Valid for average clay content (20 to 50 % clay) and mixed clay mineralogy

The value of b in Equation 13.6 ranges from 3 in soils where the organic matter consists of humus (highly decomposed organic matter) to 5 to 6 in soils containing only slightly decomposed organic matter. If sufficient data are available, the values of n and b can be calculated with linear regression from Equation 13.6. In soils where the ratio f_o/f_c does not vary much between the soil samples, b cannot be found with Equation 13.6. In these soils, the organic matter mostly contains a high percentage of decomposed organic matter and a b -value of 3 can be used.

The water content is an important parameter in estimating the subsidence due to shrinkage.

13.4.2 An Empirical Method to Estimate Shrinkage

Subsidence by shrinkage means that the pore volume decreases with time. The method presented in this section is based on a comparison of the density of the soil before reclamation and at a given point in time after reclamation. The method was first applied by Hissink (1935) and was further developed by Zuur (Smits et al. 1962) and De Gloppe (1973). It can be used to predict the subsidence due to shrinkage of the topsoil, to a depth of approximately 1.5 m, depending on the depth of the subsurface drainage system. For the deeper soil layers, the changes in density are too small to measure.

The density of the soil can be characterized by the specific volume, which is defined as the volume of a unit mass of dry soil in an undisturbed condition. It is the reciprocal value of the dry bulk density. Provided that no soil particles are lost, either by oxidation or by leaching, the thickness of the soil layer after shrinkage (D_t) can be calculated from the initial thickness of the layer (D_i) and the specific volumes before and after shrinkage (Figure 13.9)

$$D_t = \frac{v_i}{v_t} \times D_i \quad (13.7)$$

in which

- D_t = thickness at a given point in time after reclamation (m)
- v_i = initial specific volume (m^3/kg)
- v_t = specific volume at time t (m^3/kg)
- D_i = initial thickness (m)

For saturated soils, the specific volume can be calculated from the water content because all pores are filled with water, according to the equation

$$v = \frac{V_t}{m_s} = \frac{V_s + V_w}{m_s} = \frac{V_s}{m_s} + \frac{V_w}{m_s} = \frac{1}{\rho_s} + \frac{w}{\rho_w} \quad (13.8)$$

in which

- v = specific volume (m^3/kg)
- V_t = total volume of the soil (m^3)
- m_s = mass of dry solids (kg)
- V_s = volume of solids (m^3)
- V_w = volume of water (m^3)

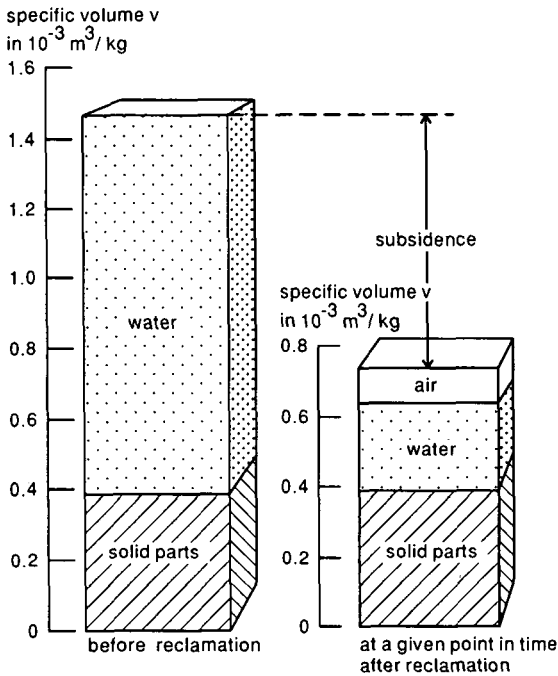

Figure 13.9 Subsidence is proportional to the decrease in the specific volume (v)

ρ_s = density of solids (kg/m^3)

w = water content (-)

ρ_w = density of water ($\rho_w = m_w/V_w$; kg/m^3)

In aerated soils, the specific volume cannot be calculated from the water content, because parts of the pores are filled with air. In this case, bulk-density samples have to be collected from the aerated soil layers. If the pores in the deeper soil layers are completely filled with water, the specific volume can again be derived from the water content with Equation 13.8.

The main problem in applying this method is that one must know the specific volumes before reclamation and some time afterwards. One can obtain the initial specific volume either by sampling or by using empirical relations between the specific volume and the clay and organic matter contents. The specific volume after reclamation can only be estimated.

Alternatively, the situation after reclamation can be estimated from data collected in an area that has identical soil and hydrological conditions and was reclaimed in former times.

The method can also be used to predict the final subsidence by extrapolation of the data that were collected in the first 15 to 20 years after reclamation. It is not recommended to extrapolate data collected over a shorter period, because seasonal variations in the weather conditions can have a major effect.

A number of factors determine the value of the specific volume, both in the initial state and after reclamation. These will be discussed below.

The Clay and Organic Matter Contents

For most of the water-saturated soils that were reclaimed in The Netherlands, a close relationship was found between the water content and the clay and organic matter contents (Figure 13.10). So, in saturated soils, this relationship (Equation 13.6) can be used to calculate the specific volume.

The Type of Clay Mineral

A soil with a high content of montmorillonite will shrink severely when dry, but when it becomes wet again, it will swell to its initial volume. On the other hand, a kaolinite soil will hardly shrink, but does not swell either. Most clays are of the illite type and their behaviour is somewhere in between the two above-mentioned soil types.

The Drainage Conditions Before and After Reclamation

Before reclamation, major differences in specific volume can occur because the drainage conditions can vary widely over short distances (e.g. due to differences in elevation). After reclamation, these differences have often been reduced and drainage conditions can then be considered uniform.

The Depth of the Layer in the Soil Profile

The change in specific volume is less in deeper soil layers because the rate of decrease of the water content lessens with depth.

The Type of Land Use

The type of land use dictates the required drainage conditions and thus has a major effect on the final subsidence. If the area is intended for rice production, a relatively

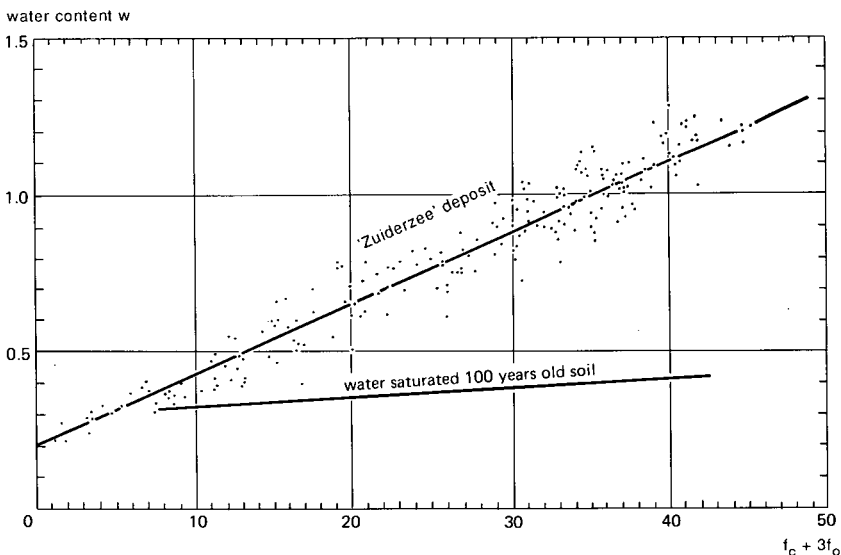

Figure 13.10 The relationship between the water content (w) and the clay (f_c) and organic matter (f_o) contents for 'Zuiderzee' soil and a soil reclaimed about 100 years ago (after Rijniersce 1983)

high watertable has to be maintained and the rate of soil ripening will be less than in areas used for crops that need a deep watertable.

The Climatological Conditions

It is obvious that the climate has a major influence on the soil moisture and thus on the subsidence caused by shrinkage. In a dry climate, the subsidence will proceed more rapidly than in a humid climate. Nevertheless, there is a certain limit, because the rate of decrease in the water content will slow down and in the end practically stops.

The Time That Has Elapsed Since Reclamation

In Section 13.3.2, it was shown that consolidation is proportional to the logarithm of time. The same applies if the subsidence is caused by a combination of shrinkage (of the topsoil) and consolidation (of the subsoil). An example is presented in Figure 13.11. The extrapolation of the logarithmic relation between total subsidence and time has to be applied with care. Especially during the first years after reclamation, the subsidence is very sensitive to variations in the weather.

It should be remembered that the method that uses the changes in the specific volumes is an empirical comparison method. As mentioned earlier, data have to be collected from an area with the same soil and hydrological conditions as the area to be reclaimed. In practice, these conditions are rarely completely identical and a certain degree of inaccuracy has to be accepted.

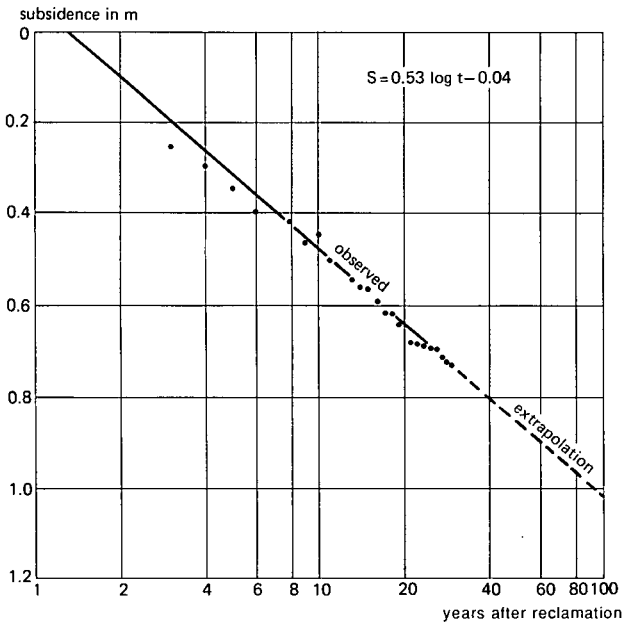

Figure 13.11 The relationship between subsidence and the logarithm of time (average of four permanent measuring sites in the IJsselmeerpolders; De Glopper 1989)

Example 13.3

In this example, we shall calculate the shrinkage of a homogeneous topsoil (i.e. the initial specific volume is constant over the upper 2.5 m). The clay and organic matter contents in this layer are 0.30 and 0.033 respectively; the water factor n is 2.2, and the value of b is 3.0.

To estimate the shrinkage of this layer in a future reclamation project, we compare its present (= initial) specific volume with the specific volume in a comparable 100-year-old polder. The polder also has a clay content of 0.30 and was reclaimed from subaqueous sediments. The values of the specific volume in the polder, as determined from bulk density sampling, are given in Table 13.3.

First, using Equation 13.6, we calculate the water content

$$w = 0.20 + n(f_c + b f_o) = 0.20 + 2.2(0.30 + 3 \times 0.033) = 1.08$$

The mass density of solids is approximately 2660 kg/m^3 , a value that is representative throughout the world. The mass density of water is 1000 kg/m^3 . Substituting these values into Equation 13.8 gives the initial specific volume

$$v_i = \frac{1}{\rho_s} + \frac{w}{\rho_w} = \frac{1}{2660} + \frac{1.08}{1000} = 1.46 \times 10^{-3} \text{ m}^3/\text{kg}$$

We assume that the initial specific volume in the polder was constant over the upper 2.5 m of the profile. Now we can calculate the shrinkage of our homogeneous topsoil, assuming that its ultimate specific volumes will be similar to the values in the 100-year-old polder. We perform the calculation backwards, from the ultimate state to the initial state, using Equation 13.7

$$D_i = \frac{v_i}{v_t} \times D_t$$

The calculations are given in Table 13.4 and the results are plotted in Figure 13.12. Thus the final shrinkage of the upper 2.5 m top soil will be:

$$S = \Sigma D_i - \Sigma D_t = 2.53 - 1.50 = 1.03 \text{ m}$$

To calculate the total subsidence, we must add the consolidation of the subsoil, which can be calculated using the equations presented in Section 13.3

Table 13.3 Measured specific volumes in a 100-year-old polder

Depth (m)	Specific volume ($\times 10^{-3} \text{ m}^3/\text{kg}$)	Depth (m)	Specific volume ($\times 10^{-3} \text{ m}^3/\text{kg}$)
0.0 - 0.2	0.73	0.8 - 0.9	0.89
0.2 - 0.3	0.76	0.9 - 1.0	0.90
0.3 - 0.4	0.82	1.0 - 1.1	0.91
0.4 - 0.5	0.85	1.1 - 1.2	0.93
0.5 - 0.6	0.86	1.2 - 1.3	0.95
0.6 - 0.7	0.87	1.3 - 1.4	0.97
0.7 - 0.8	0.88	1.4 - 1.5	1.02

Table 13.4 Calculation of the shrinkage in a homogeneous soil profile

Ultimate depth (m)	D_t (m)	D_i (m)	Initial depth (m)
0.0 - 0.2	0.20	$0.20 \times 1.46/0.73 = 0.40$	0.00 - 0.40
0.2 - 0.3	0.10	$0.10 \times 1.46/0.76 = 0.19$	0.40 - 0.59
0.3 - 0.4	0.10	$0.10 \times 1.46/0.82 = 0.18$	0.59 - 0.77
0.4 - 0.5	0.10	$0.10 \times 1.46/0.85 = 0.17$	0.77 - 0.94
0.5 - 0.6	0.10	$0.10 \times 1.46/0.86 = 0.17$	0.94 - 1.11
0.6 - 0.7	0.10	$0.10 \times 1.46/0.87 = 0.17$	1.11 - 1.27
0.7 - 0.8	0.10	$0.10 \times 1.46/0.88 = 0.17$	1.27 - 1.44
0.8 - 0.9	0.10	$0.10 \times 1.46/0.89 = 0.17$	1.44 - 1.60
0.9 - 1.0	0.10	$0.10 \times 1.46/0.90 = 0.16$	1.60 - 1.76
1.0 - 1.1	0.10	$0.10 \times 1.46/0.91 = 0.16$	1.76 - 1.92
1.1 - 1.2	0.10	$0.10 \times 1.46/0.93 = 0.16$	1.92 - 2.08
1.2 - 1.3	0.10	$0.10 \times 1.46/0.95 = 0.15$	2.08 - 2.23
1.3 - 1.4	0.10	$0.10 \times 1.46/0.97 = 0.15$	2.23 - 2.38
1.4 - 1.5	0.10	$0.10 \times 1.46/1.02 = 0.14$	2.38 - 2.53

In Figure 13.12, the shrinkage of each layer is also expressed as a percentage of the thickness of the layer. As can be seen, shrinkage reduces with depth, from 50% at the ground surface to 30% at a depth of 1.5 m.

In this example, the increase in the ultimate specific volume with depth is very gradual, so, without introducing any significant errors, we can reduce the number of soil layers in the calculations. For instance, if we had considered only three layers of 0.50 m each, the calculated shrinkage would have been 1.01 m.

The clay content has a major effect on the final shrinkage. This is illustrated in Figure 13.13, which gives the relationship between the initial and final thickness of sediments with different clay contents as found in the IJsselmeerpolders (De Glopper 1973).

Example 13.4

For a heterogeneous soil profile, the calculation is more complicated because both the initial and the ultimate specific volumes vary with depth. This example concerns a Dutch salt marsh with a clay content of 0.25.

The specific volumes of the area to be reclaimed are shown on the left-hand side of Figure 13.14. Those of a comparable area, reclaimed 100 years ago, are shown on the right-hand side. The calculations are presented in Table 13.5. They were made for soil layers with a thickness of 0.10 m. In this example, the amount that shrinkage will contribute to the subsidence is $1.10 - 0.85 = 0.25$ m.

The essential part of this type of calculation is that it has to be done back or forth, because the calculation has to be closed at the interface between soil layers with different specific volumes, in both the initial and the ultimate stages. In practice, the specific volume gradually increases with depth and a certain degree of schematization will be required.

If, at a certain depth, the specific volume becomes constant (in this case at 0.60

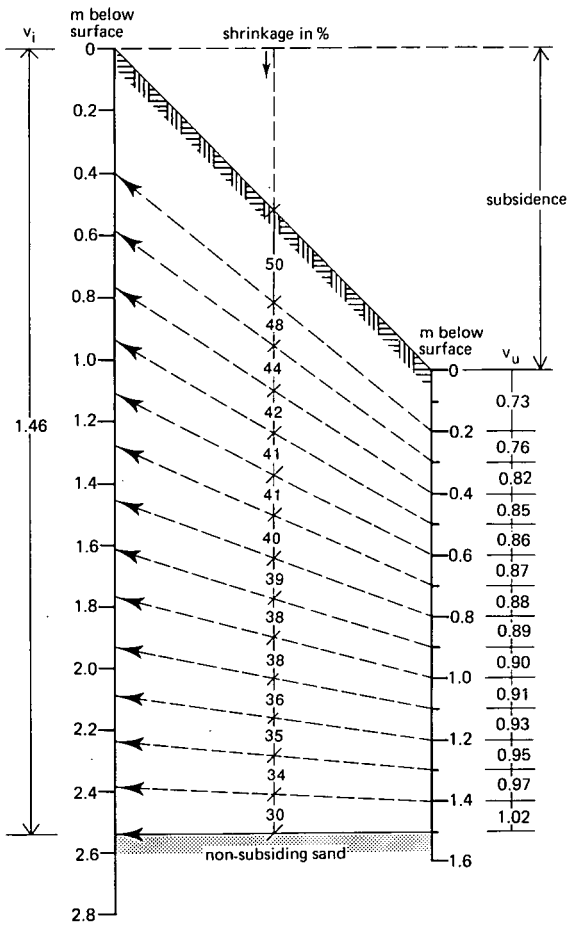

Figure 13.12 Shrinkage in a homogeneous soil profile (Example 13.3)

m below the surface in the initial stage), the calculation procedure of Example 13.3 can be used.

It will not always be possible to apply the empirical method: the soils may be non-uniform or there may be no area with comparable soil and hydrological conditions. In such circumstances, the following numerical method might offer a solution.

13.4.3 A Numerical Method to Calculate Shrinkage

To increase the insight into the ripening process in the IJsselmeerpolders, Rijniersce (1983) developed a numerical conceptual model: FYRYMO. The model, which is based on the classical consolidation theory, simulates the shrinkage component of the subsidence, due solely to the ripening of the top 0.5 to 1.5 m of the soil. The oxidation is not accounted for, nor is the compression/consolidation of the deeper

thickness in m
100 years after reclamation

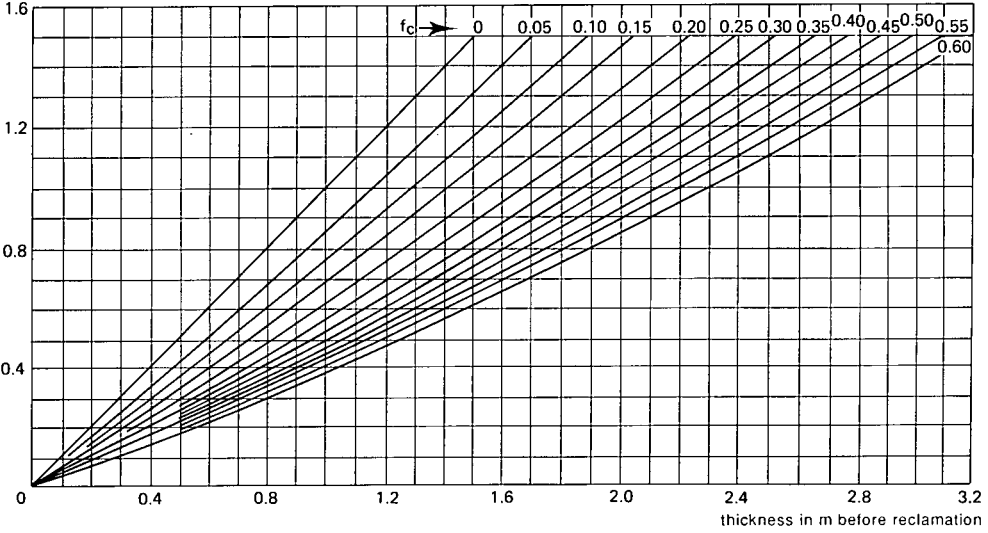

Figure 13.13 Relationship between the initial and final thickness of sediments with different clay contents f_c in the IJsselmeerpolders (De Gloopper 1973)

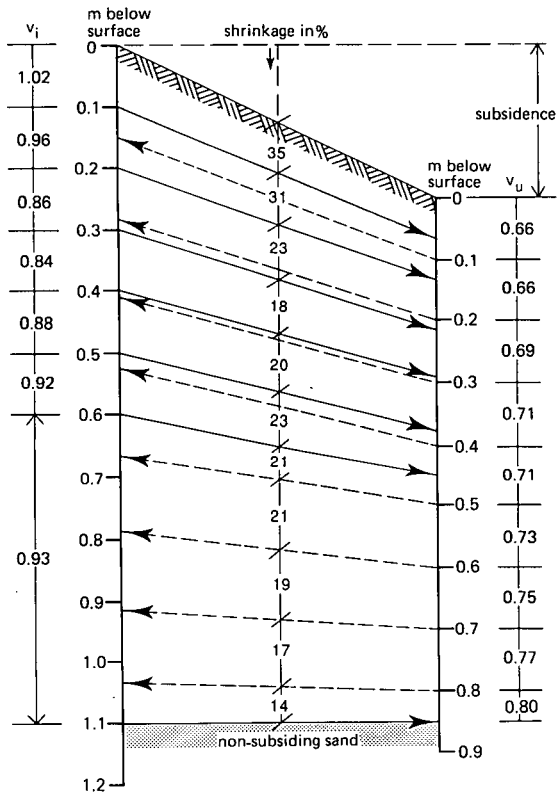

Figure 13.14 Shrinkage in a heterogeneous soil profile (Example 13.4)

Table 13.5 Calculation of the subsidence due to shrinkage in a heterogeneous soil profile

Initial depth (m)	v_i ($\times 10^{-3} \text{ m}^3/\text{kg}$)	D_i (m)	Calculation	V_t ($\times 10^{-3} \text{ m}^3/\text{kg}$)	D_t (m)	Ultimate depth (m)
0.00-0.10	<u>1.02</u> *	0.10	$0.10 \times 0.66 / 1.02$ —>	0.66	0.06	0.00-0.06
0.10-0.16	0.96	0.06	$0.04 \times 0.96 / 0.66$ <—	0.66	0.04	0.06-0.10
0.16-0.20	<u>0.96</u>	0.04	$0.04 \times 0.66 / 0.96$ —>	0.66	0.03	0.10-0.13
0.20-0.29	0.86	0.09	$0.07 \times 0.86 / 0.66$ <—	<u>0.66</u>	0.07	0.13-0.20
0.29-0.30	<u>0.86</u>	0.01	$0.01 \times 0.69 / 0.86$ —>	0.69	0.01	0.20-0.21
0.30-0.41**	0.84	0.11	$0.09 \times 0.84 / 0.69$ <—	0.69	0.09	0.21-0.30
0.30-0.40	<u>0.84</u>	0.10	$0.10 \times 0.69 / 0.84$ —>	0.69	0.08	0.21-0.29
0.40-0.41	0.88	0.01	$0.01 \times 0.88 / 0.69$ <—	<u>0.69</u>	0.01	0.29-0.30
0.41-0.50	<u>0.88</u>	0.09	$0.09 \times 0.71 / 0.88$ —>	0.71	0.07	0.30-0.37
0.50-0.54	0.92	0.04	$0.03 \times 0.92 / 0.71$ <—	0.71	0.03	0.37-0.40
0.54-0.60	<u>0.92</u>	0.06	$0.06 \times 0.71 / 0.92$ —>	0.71	0.05	0.40-0.45
0.60-0.67	0.93	0.07	$0.05 \times 0.93 / 0.71$ <—	<u>0.71</u>	0.05	0.45-0.50
0.67-0.80	0.93	0.13	$0.10 \times 0.93 / 0.73$ —>	<u>0.73</u>	0.10	0.50-0.60
0.80-0.92	0.93	0.12	$0.10 \times 0.93 / 0.75$ <—	<u>0.75</u>	0.10	0.60-0.70
0.92-1.04	0.93	0.12	$0.10 \times 0.93 / 0.77$ —>	<u>0.77</u>	0.10	0.70-0.80
1.04-1.10	0.93	0.06	$0.05 \times 0.80 / 0.93$ <—	0.80	0.05	0.80-0.85

* Underlined = change in specific volume, boundary between two soil layers

** Step in calculation is too large, two different values for the specific volume in this soil layer

layers, which has to be calculated separately (e.g. with Equation 13.5).

In the model, the soil profile is divided into layers: thin layers (5 to 20 mm) in the topsoil and thicker layers (up to 50 mm) in the subsoil. Each layer is defined by its clay and organic matter contents and its bulk density. The model is based on water balances, calculated for time steps of 10 days. The changes in water content, in the intergranular pressure, in the resulting bulk density, in the volume and depth of the cracks, and finally the shrinkage are calculated by iteration.

To calculate the change in intergranular pressure, we must know the relation between the soil moisture suction and the water content (pF-curve). In a ripening soil, this relation changes in the course of time. We therefore need pF-curves at various stages in the ripening process. Approximation methods were developed to estimate the evapo-transpiration rate and the unsaturated hydraulic conductivity. A new equation, based

on the classical relation between the logarithm of the intergranular pressure and the pore space (Section 13.3.2), was developed to calculate the rate of shrinkage.

The model was calibrated for the IJsselmeerpolders, but it also proved useful in predicting the rate of subsidence for some tropical lowlands in Indonesia (de Glopper et al. 1986). To obtain reliable predictions, however, long-term records of at least some of the above-mentioned parameters are required. Thus, the application of the numerical method has some of the same restrictions as the empirical method.

13.5 Subsidence of Organic Soils

13.5.1 The Oxidation Process in Organic Soils

The subsidence of organic soils is the result of a combination of oxidation and irreversible shrinkage. Oxidation was defined in Section 13.1 as the process by which organic carbon is converted to carbon dioxide and is lost to the atmosphere. Shrinkage was defined in Section 13.4.1 as the decrease in porosity due to the loss of soil water as a result of physical ripening.

Organic soils (or Histosols) are classified by their organic matter content. They are subdivided into peat soils, muck soils, organic soils, and mineral soils (Chapter 3.4.1).

Unreclaimed peat soils are generally saturated with water. Their porosity is high, often ranging between 0.8 and 0.9 and sometimes even higher. Peat layers can be up to 10 m thick, depending on the rate of supply of organic matter, its decomposition, and the period over which the peat formation took place.

After the peat soil has been reclaimed, a complex process of subsidence starts. In the first place, the supply of organic matter comes to a standstill. At the same time, the decomposition increases significantly. Because the watertable is lowered and air can enter the soil, the oxidation of the organic matter increases. This oxidation, however, is restricted to the layer above the watertable. Besides this oxidation, the layer above the watertable shrinks, just as in mineral soils, as a consequence of increased capillary stress during periods with an evaporation surplus. Because of the high porosity, relatively slight increases of the capillary stress result in major shrinkage. Furthermore, the soil layers below the watertable are compressed because of the increase in intergranular pressure. Finally, the subsidence of the ground surface is often aggravated by the burning of the topsoil. This burning is a world-wide practice to free nutrients or, in case of shallow peat layers, to eliminate this layer, which is considered of poor agricultural value.

The subsidence of organic soils depends on many factors such as the type of peat, its degree of decomposition, the climatic conditions, the type of land use, and the depth of the watertable. The rate of subsidence varies from 0.01 to 0.02 m/yr in cold and temperate climates to 0.04 to 0.10 m/yr in subtropical and tropical climates. It is obvious that these rates of subsidence can diminish a peat layer in a relatively short time. Consequently, if the top (peat) layer is shallow and the subsoil has poor agricultural potential, the reclamation of such peat soils should be considered with great caution. Examples of poor subsoils are the dense sand in the Fenlands in England, the bedrock in the Everglades in Florida, and the acid sulphate soils in the coastal swamps in Indonesia.

Even if the loss of the top soil through oxidation is not a major problem, the reclamation of peat soils can still be problematical. Because of their high water content, their subsidence is generally considerable and this may lead to drainage problems in the future. Sometimes the ground surface becomes too low to drain off excess water by gravity and pumping will be necessary.

13.5.2 Empirical Methods for Organic Soils

To predict the rate of subsidence of organic soils, the soil-mechanical approach (Section 13.3) can only be used for the saturated (deeper) soil layers. It cannot be used to calculate the oxidation and irreversible shrinkage of the topsoil. The same applies for the FYRYMO model (Section 13.4.3), because one of the conditions for its application is that no soil particles are lost. It is possible to use the 'comparison' method (Section 13.4.2), although the results are often unreliable because the relationship between the density or water content and the organic matter content is weak. Therefore, empirical relations are most commonly used to predict the subsidence of organic soils are. Unfortunately, apart from northwestern Europe and the United States, systematic data on the oxidation and subsidence of peat soils are scarce.

We shall discuss three empirical equations. The first two can be used to calculate the total subsidence of peat layers; they include subsidence due to shrinkage and oxidation of the top layer and consolidation of the layer below the watertable. The third equation is restricted to the subsidence due to consolidation of the layer below the watertable.

For the subsidence of peat soils in the northwestern part of Germany, Segeberg (1960) developed an equation, which includes both the shrinkage of the topsoil and the compression of the subsoil

$$S = \frac{5 + (1-\varepsilon)^{-1}}{100} \times D_d \times D_i^{0.707} \quad (13.9)$$

in which

- S = subsidence (m)
- ε = initial porosity (-)
- D_d = final depth of drains below ground surface (m)
- D_i = initial thickness of the peat layer (m)

In this equation, $(1-\varepsilon)$ is the volume fraction occupied by the solid soil particles; it is a measure of the density. If no porosity data are available, $(1-\varepsilon)$ can be estimated from Table 13.6. Equation 13.9 can be used for peat layers to an initial depth of 3.0 m; for deeper layers, the consolidation theory gives better results.

Equation 13.9 includes the shrinkage of the peat soil above the watertable, the loss of soil particles through oxidation, and the consolidation of the peat layers below the watertable. It does not, however, include one main factor: the soil temperature.

The influence of the soil temperature was examined by Stephens and Stewart (1977);

Table 13.6 Estimates of the volume fraction occupied by solids for peat soils (De Glopper 1989)

Consistency of the peat layer	Volume fraction of solids
Nearly floating	< 0.03
Soft	0.03 - 0.05
Moderately soft	0.05 - 0.08
Rather firm	0.08 - 0.12
Firm	> 0.12

they found that the rate of oxidation doubled for every 10°C increase in soil temperature. Stephens et al. (1984) presented an equation based on field experiments and laboratory research in low moor peat soils in the Florida Everglades. This equation gives a relation between the annual subsidence and the mean annual depth of the watertable and the mean annual soil temperature at a depth of 0.10 m

$$S = \frac{16.9 \times D_w - 1.04}{1000} \times 2^{\frac{T - 5.0}{10}} \quad (13.10)$$

in which

S = annual subsidence (m)

D_w = depth of the watertable below ground surface (m)

T = mean annual soil temperature at 0.10 m below ground surface (°C)

The exponent (T - 5.0) / 10 indicates that the oxidation rate drops at decreasing mean annual soil temperatures, and becomes negligible at 5°C.

Just as in Equation 13.9, the factor time is not considered. Time, however, has an impact on the subsidence by oxidation because the watertable becomes shallower from year to year as a result of this subsidence. If, for instance, the watertable is at an initial depth of 0.50 m and the mean annual soil temperature is 20°C, the annual subsidence can be calculated with Equation 13.10, and is 0.02 m. So, after 25 years, the peat layer above the watertable should have virtually disappeared. In reality, taking into account the annual decrease of the depth of the watertable, the subsidence will be less.

According to Equation 13.10, the subsidence depends only on the soil temperature and the depth of the watertable. Of these two parameters, the soil temperature cannot be influenced, but the depth of the watertable can. By maintaining a high watertable, one can reduce the rate of subsidence. This is illustrated in Figure 13.15, which gives the relationship between the watertable depth and the subsidence for various soil temperatures. This figure clearly shows the effect of the depth of the watertable on the subsidence. It is recommended that the watertable be kept as shallow as the type of crop and the tillage and harvesting operations permit. One should be well aware, however, that even with the shallowest possible watertable, the subsidence due to the oxidation of organic matter is an everlasting, continuous process. Consequently, the drainage level will have to be lowered from time to time (Figure 13.16).

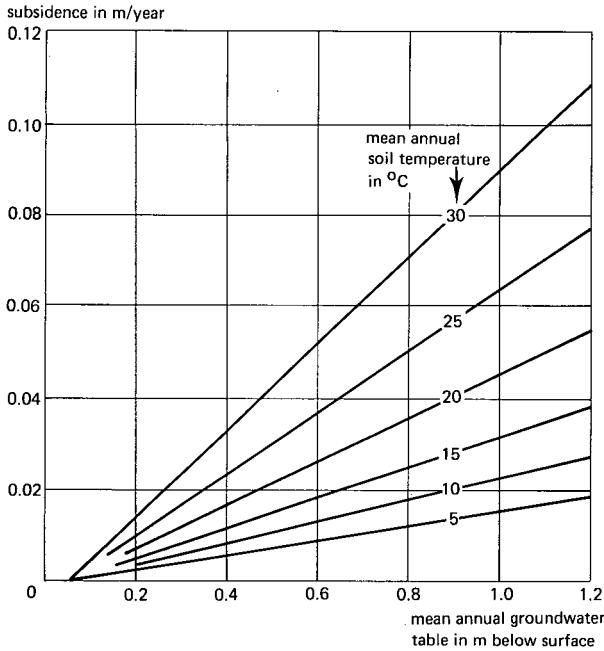

Figure 13.15 The relationship between the annual subsidence rate in the layer above the watertable and the mean annual watertable for different soil temperatures ($^{\circ}\text{C}$ at 0.10 m below surface)

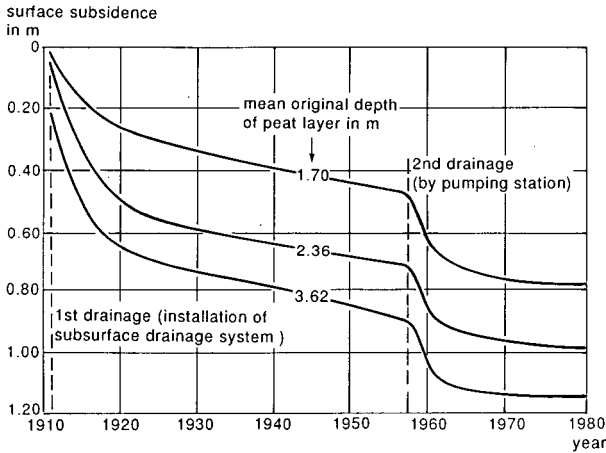

Figure 13.16 Increase in rate of subsidence due to improved drainage. Example from an experimental field in northwestern Germany (after Eggelsman 1982)

On the basis of the consolidation theory (Equation 13.5), Fokkens (1970) developed an equation to calculate the compression of peat layers below the watertable

$$S = \varepsilon \times w \left(25.3 f_o + w \ln \frac{p_i + \Delta p_i}{p_i} \right)^{-1} \ln \frac{p_i + \Delta p_i}{p_i} \times D_i \quad (13.11)$$

in which

- S = subsidence (m)
- D_i = initial thickness of peat layer (m)
- ε = initial porosity (-)
- w = initial water content (-)
- f_o = organic matter content expressed as a fraction of the total dry mass (-)
- p_i = intergranular pressure before the watertable is lowered (kPa)
- Δp_i = increase in the intergranular pressure after the watertable is lowered (kPa)

Like the porosity, the water content is determined on much larger soil samples than the consolidation constant. Thus, the use of Equation 13.11 is more likely to give accurate results than Equation 13.5. Moreover, as discussed in Section 13.3.3, the collection of samples is less complicated and more data can be collected within a given budget. Both these equations, however, retain the same disadvantage, i.e. they describe the subsidence, which is in reality a dynamic process, as the difference between two stationary situations.

The irreversible shrinkage of the layer above the watertable due to the increased capillary stress in periods with an evaporation surplus cannot be calculated with Equation 13.11. When the watertable is shallow, the contribution of shrinkage to the total subsidence will be minor, but with deeper watertables it cannot be neglected.

It was already mentioned in Section 13.2 that 85% of the subsidence of peat soils in the western part of The Netherlands was caused by the oxidation of organic matter and only 15% by shrinkage of the topsoil (Schothorst 1982).

Example 13.5

A peat soil is 5.0 m thick and is saturated with water. The water content (w) is 8.3 and the organic-matter content (f_o) is 0.70; thus the mineral content is (f_m) 0.30. The mass density of the mineral clay particles (ρ_s) is approximately 2660 kg/m³ and the mass density of the organic matter (ρ_o) approximately equals the mass density of water: \approx 1000 kg/m³ (De Glopper 1989). After reclamation, the ultimate drain depth will be 0.6 below the surface.

To calculate the total subsidence, we can use Equation 13.9, but we first have to calculate the porosity. The water content is 8.3, so we know that the mass of water held by 1 kg solid soil particles is

$$m_w = m_s \times w = 1 \times 8.3 = 8.3 \text{ kg}$$

The volume of this water is

$$V_w = \frac{m_w}{\rho_w} = \frac{8.3}{1000} = 8.3 \times 10^{-3} \text{ m}^3$$

The volume occupied by 1 kg of soil particles is

$$V_s = \frac{f_o}{\rho_o} + \frac{f_m}{\rho_s} = \frac{0.70}{1000} + \frac{0.30}{2660} = 0.813 \times 10^{-3} \text{ m}^3$$

The porosity of the saturated soil is per definition

$$\varepsilon = \frac{V_w}{V_t} = \frac{V_w}{V_s + V_w} = \frac{8.3 \times 10^{-3}}{0.813 \times 10^{-3} + 8.3 \times 10^{-3}} = 0.91$$

According to Equation 13.9, the subsidence of the top 1 m of the soil profile is

$$S = \frac{5 + (1 - 0.91)^{-1}}{100} \times 0.6 \times 5.0^{0.707} = 0.30 \text{ m}$$

The compression of the remaining part of the peat layer can be calculated either with Equation 13.5 or with Equation 13.11. If the first equation is used, the consolidation constants have to be measured in undisturbed soil samples with a consolidometer (Section 13.3.3). If Equation 13.11 is used, the increase in intergranular pressure can be calculated in the way shown in Examples 13.1 and 13.2.

13.6 Subsidence in relation to Drainage Design and Implementation

To predict the subsidence of a ground surface at a given point in time after reclamation, the following steps, depending on the soil profile, need to be taken:

- For clayey soils, the subsidence due to shrinkage of the topsoil should be calculated (Section 13.4);
- For peaty soils, the subsidence due to shrinkage and/or oxidation of the topsoil should be calculated (Section 13.5);
- If there are soft soil layers in the subsoil, the subsidence of these layers as a result of compression/consolidation should be calculated (Section 13.3);
- Finally, the total subsidence of the ground surface can be calculated by adding the different components.

A grid survey will be required to obtain the initial elevation of the area and to take the required soil samples. The number of sampling sites depends on the flatness of the area and the expected variation in subsidence. The subsidence clearly depends on the type and thickness of the soft layers.

In a flat area like the IJsselmeerpolders in The Netherlands, which has a very gradual variation in both the thickness and the softness of the subsiding layers, a square grid in the range of 1 km × 1 km to 1.5 km × 1.5 km was adequate (De Glopper 1989).

On the other hand, in a salt-marsh area with creeks, levees (relatively firm), and backswamps (relatively soft), the variation can be much greater over relatively short distances. The survey lines should then be chosen in such a way that, in each geomorphological unit, sufficient samples are obtained. Generally, a square grid system cannot be applied, and the density of sampling may vary from 4 to 100 per km², depending on the variation in soil conditions. In planning a survey of this type, it will be clear that one will need detailed soil and contour maps of the area.

An example of a subsidence calculation is presented in Figure 13.17. It shows the present elevation and the predicted total subsidence of the Markerwaard, an area in

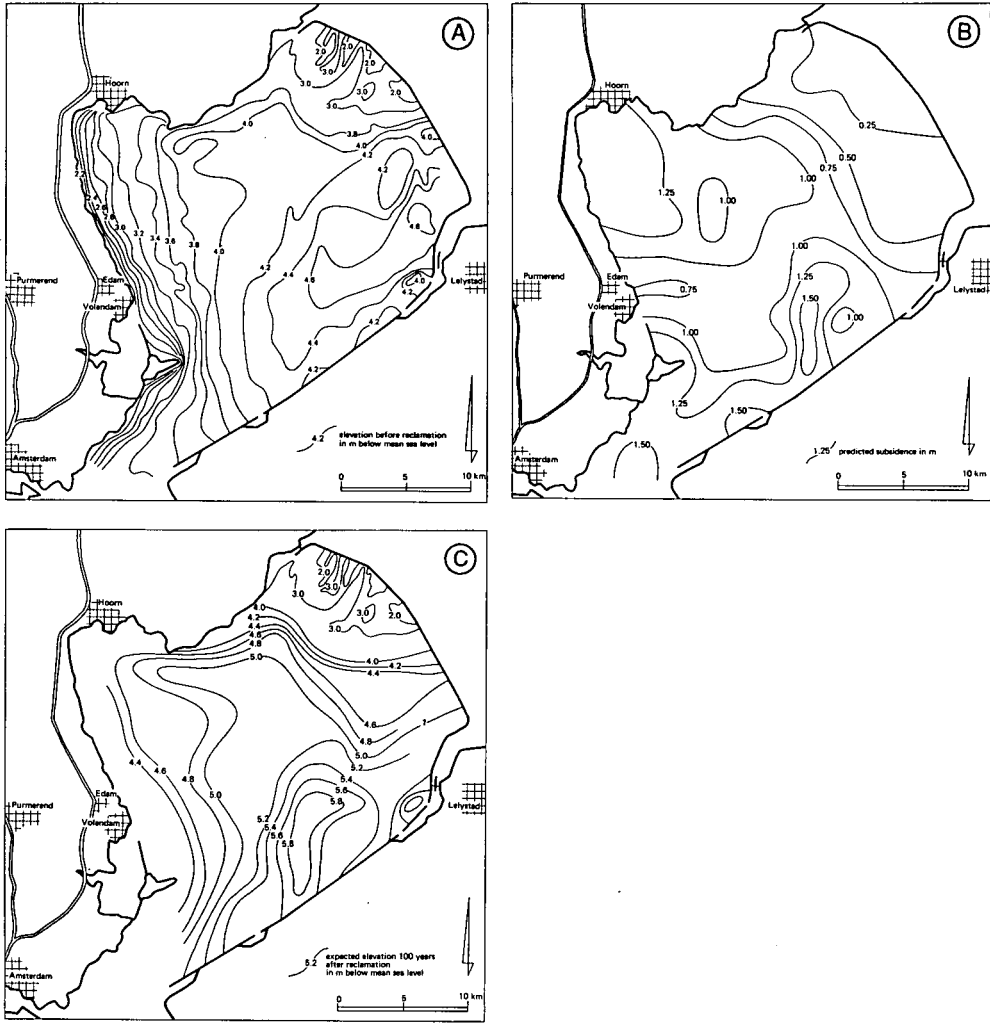

Figure 13.17 Elevation of the soil surface of the Markerwaard area A: Before reclamation; B: The predicted subsidence; C: The expected elevation 100 years after reclamation (Ente 1976; Van der Scheer 1975)

the IJsselmeer in The Netherlands, which has been under consideration for reclamation. The predicted subsidence levels are of the utmost importance in planning such a reclamation project: they are needed, among many other things, to calculate the future drainage base (extra depth should be included to take into account the subsidence of the layer above drain level), pump lift, etc.

It should be remembered, however, that the results obtained by the methods discussed in this chapter should be used with caution. Most methods were developed, or at least refined, for specific regions, so their application in other areas without proper calibration might introduce large errors. A check with local data is always necessary.

References

- Allen, A.S. 1984. Types of land subsidence. In: J.F. Poland (ed.), *Guidebook to Studies of Land Subsidence due to Groundwater Withdrawal*. UNESCO Studies and Reports in Hydrology, 40. Paris, France. pp. 133-142.
- Bouwer, H. 1978. *Groundwater hydrology*. McGraw-Hill, New York, 480 p.
- De Glopper, R.J. 1973. Subsidence after drainage of the deposits in the former Zuider Zee and in the brackish and marine forelands in the Netherlands. *Van Zee tot Land*, 50, Staatsuitgeverij, 's-Gravenhage, 205 p.
- De Glopper, R.J. 1977. The application of consolidation constants, derived from pore space in subsidence calculations. *Proc. 2nd Symp. Land Subsidence (Anaheim)*. IASH Publ., 121, pp. 567-576.
- De Glopper, R.J. 1989. Land subsidence and soil ripening. *Flevobericht* 306. Rijkswaterstaat, Directie Flevoland, Lelystad, 49 p.
- De Glopper, R.J., G.A.M. Menting, Suprpto, M. Dradjad, and S. Legowo 1986. Subsidence in tropical lowlands in Indonesia. *Sym. Lowland Development in Indonesia*. ILRI Research Papers, Wageningen, pp. 147-167.
- Dent, D.D. 1986. Acid sulphate soils: a baseline for research and development. ILRI Publication 39, Wageningen, 204 p.
- Eggelsmann, R. 1982. Water management of Northwestern German peatlands. In: H. de Bakker and M.W. van den Berg (eds.), *Proceedings of the Symposium on Peat Lands below Sea Level*. ILRI Publication 30, Wageningen, pp. 122-129.
- Ente, P.J. 1976. Markerwaard; atlas bodemgesteldheid en bodemgeschiktheid. Rijksdienst voor de IJsselmeerpolders, Lelystad, 40 p.
- Euroconsult (eds.) 1989. *Agricultural compendium for rural development in the tropics and subtropics*. 3rd ed. Elsevier, Amsterdam, 740 p.
- Fokkens, B. 1970. Berekening van de samendrukking van veenlagen uit het gehalte aan organische stof en water. *De Ingenieur* 82, B23-B28.
- Hissink, D.J. 1935. De bodemkundige gesteldheid van de achtereenvolgens ingedijkte Dollarpolders. *Versl. Landbk. Onderz.* 41.3, 's-Gravenhage, 126 p.
- Keverlingh Buisman, A.S. 1940. *Grondmechanica*. Waltman, Delft.
- Koppejan, A.W. 1948. A formula combining the Terzaghi load-compression relationship and the Buisman secular time effect. In: *Proc. 2nd Intern. Conf. on Soil Mech. and Found. Eng.*, Rotterdam.
- Lofgren, B.E. 1969. Land subsidence due to the application of water. In: D.J. Varnes and G. Kiersch (eds.), *Reviews in Engineering Geology*, Vol. II. Geo. Soc. of America. pp. 271-303.
- Poland, J.F. (ed.) 1984. *Guidebook to studies of land subsidence due to groundwater withdrawal*. UNESCO Studies and Reports in Hydrology 40, Paris, 305 p.
- Pons, L.J. and I.S. Zonneveld 1965. Soil ripening and soil classification; initial soil formation in alluvial deposits with a classification of the resulting soils. ILRI Publication 13, Wageningen, 128 p.
- Rijniersce, K. 1983. A simulation model of physical soil ripening. Rijksdienst voor de IJsselmeerpolders, *Flevobericht* 203, Lelystad, 216 p.
- Scott, J.S. 1981. *The Penguin dictionary of civil engineering*. 3rd ed. Penguin Books, Harmondsworth. 308 p.
- Schothorst, C.J. 1982. Drainage and behaviour of peat soils. In: H. de Bakker and M.W. van den Berg (eds.), *Proc. of the Symposium on Peat Lands Below Sea Level*. ILRI Publication 30, Wageningen. pp. 130-163.
- Segeberg, H. 1960. Moorsackungen durch Grundwasserabsenkungen und deren Vorausberechnung mit Hilfe empirischer Formeln. *Zeitschrift für Kulturtechnik* 1, pp. 144-161.
- Segeren, W.A. and H. Smits 1980. Drainage of newly reclaimed marine clayey sediments, peat soils, and acid sulphate soils. In: *Drainage Principles and Applications, Volume IV, Design and Management of Drainage Systems*. ILRI Publication 16, Wageningen. pp. 261-295.
- Smits, H., A.J. Zuur, D.A. van Schreven and W.A. Bosma 1962. Physical, chemical, and microbiological ripening of soils in the IJsselmeerpolders. *Van Zee tot Land* 32. Tjeenk Willink, Zwolle, 110 p.
- Stephens, J.C., J.H. Allen Jr. and E. Chen 1984. Organic soil subsidence. *Geo. Soc. Am., Rev. in Eng. Geol.*, Vol. VI, pp. 107-122.
- Stephens, J.C. and E.H. Stewart 1977. Effect of climate on organic soil subsidence. *Proc. 2nd Symp. Land Subsidence (Anaheim)*. IASH Publication 121, pp. 647-655.
- Terzaghi, K. and R.B. Peck 1967. *Soil mechanics in engineering practice*. 2nd ed. Wiley, New York, 729 p.

- USDI 1974. Earth manual: a guide to the use of soils as foundations and as construction materials for hydraulic structures, 2nd ed., U.S. Dept. of the Interior, Bureau of Reclamation. 810 p.
- Van der Scheer, A. 1975. Over de te verwachten inklinking van de gronden in het Markerwaardgebied na drooglegging). Rijksdienst voor de IJsselmeerpolders, Flevobericht 101 Lelystad, 27 p.
- Viergever, M.A. 1991. Pore water pressures and subsidence in long term observations. In: A.I. Johnson (ed.), Land Subsidence. IAHS Publ. 200. pp. 575-584.
- Young, A. 1980. Tropical soils and soil survey. Cambridge Geographical Studies 9. Cambridge University Press, Cambridge, 468 p.

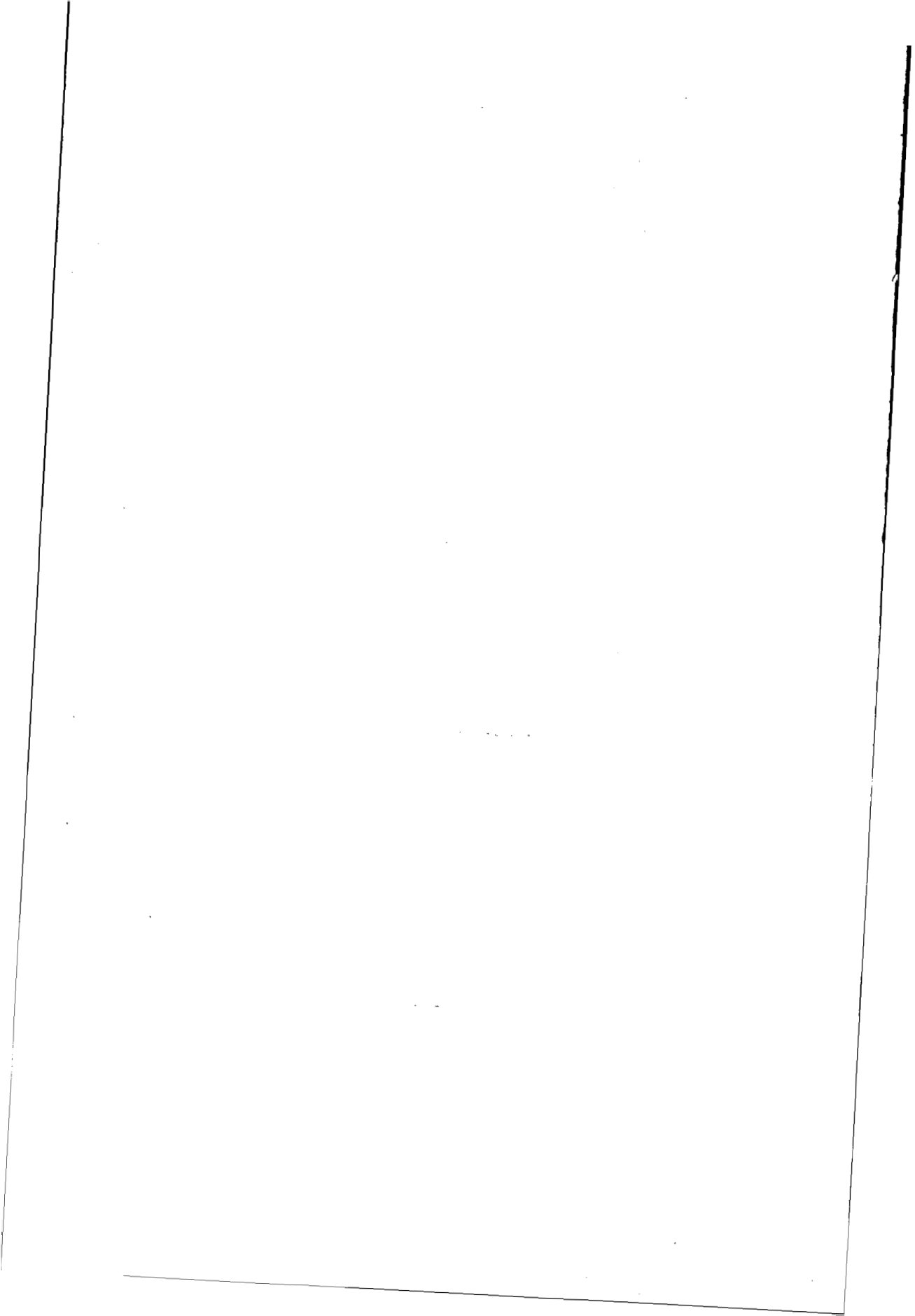

14 Influences of Irrigation on Drainage

M.G. Bos¹ and W. Wolters¹

14.1 Introduction

Irrigated agriculture is by far the greatest user of water on earth. Estimates of global annual water use amount to 3000 – 3500 10^9 m³, with 2500 10^9 m³ being used for irrigation, 500 10^9 m³ for industry, and 200 10^9 m³ for other purposes, including domestic water supplies (Schulze and Van Staveren 1980). The limits to the availability of land, and especially of water, necessitate the careful use of these resources, particularly the efficient use of water in irrigation.

Irrigation, a human intervention, has a twofold effect on the natural environment:

- It changes the land surface of the area and its vegetation;
- It affects the area's regime of soil moisture, solutes, and groundwater: water and solutes that would not be present naturally are brought to the area by the irrigation canals.

Two important risks involved in irrigation are those of waterlogging and salinization. Waterlogging occurs when more water is entering the area than is being discharged from it; the watertable will then rise, and can eventually approach the soil surface, thereby rendering the rootzone unsuitable for crop growth. Salinization occurs when more salts are entering the area than are leaving it.

This chapter will discuss the influences that irrigation has on drainage in general, giving attention to both waterlogging and salinity. We shall begin by exploring the origin of excess water (Section 14.2). Following that, we discuss salinity on both a regional and a local scale (Section 14.3). Because irrigation efficiencies are related to the water balance of irrigation systems, they are one of the means used to demonstrate the relationship between irrigation and drainage. After a discussion of efficiencies in general, we shall present several examples that show this relationship (Section 14.4). Finally, we discuss the use of a drainage system for irrigation (Section 14.5).

14.2 Where Water Leaves an Irrigation System

Introduction

Irrigation today is practised on some 260 million hectares in the world. About half of this area is in arid or semi-arid regions. There, the irrigation water supplied usually exceeds 10 000 m³/ha or 1000 mm a year, significantly more than the annual precipitation. As a consequence, irrigation in such regions has a great impact on the environment.

As the major user of water, irrigation affects the water balance of an irrigation

¹ International Institute for Land Reclamation and Improvement

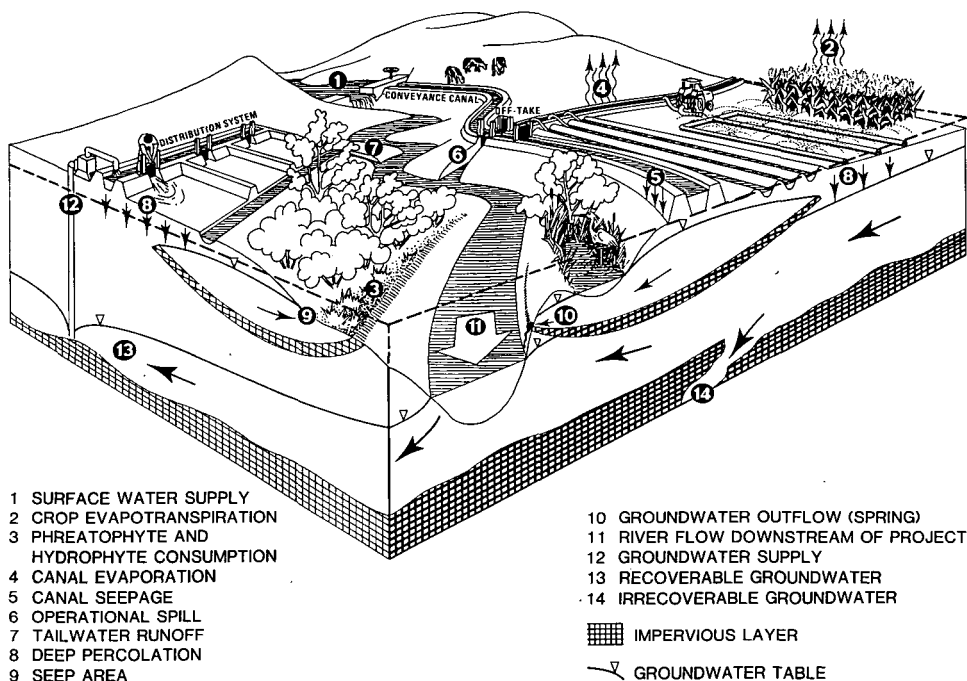

Figure 14.1 A river basin and an irrigated area

scheme. This is illustrated in Figure 14.1, which is based on the report of the Interagency Task Force on Irrigation Efficiencies (Boone 1979). In the following explanation of this figure, the numbers cited in the text refer to the numbers in the figure.

To apply a given quantity of irrigation water to a crop, water has to be diverted from a supply source (1). The quantity diverted has to be greater than the quantity required by the crop because the diverted water will leave the irrigated area not only as evapotranspiration by the irrigated crop (2), but also as consumption by non-irrigated vegetation (3), as evaporation (4), as seepage (5) from the conveyance and distribution systems, and as operational spills (6), tailwater runoff (7), and deep percolation (8).

Phreatophyte and hydrophyte consumption (3) is evapotranspiration by non-irrigated vegetation growing adjacent to irrigation canals and drains, or in areas with shallow watertables. The existence of such vegetation often provides or enhances wildlife habitats.

Water Leaving the Conveyance and Distribution Systems

The amount of seepage (5) from the conveyance and distribution systems depends on the type and condition of these systems; lined canals and pipe lines will have less seepage than unlined canals. Most of the water lost through seepage returns to the river, either directly through drains in the seep area (9) or indirectly via groundwater outflow (10). Upon reaching the river, this water is once again available for instream

use (fisheries, recreation, shipping) and for downstream diversion (11). The quality of such return-flow water, however, has usually deteriorated, which may cause problems to downstream water users.

Operational spills (6) result from a reduction in the demand for water after it has been withdrawn from the supply source. Such spills also result if the flow diverted from the river is significantly more than the water required by the farmers. These spills usually return to the river within a few days. Because spills seldom become polluted, they can provide good-quality water for instream or downstream uses. The main disadvantage of spills is that they require the irrigation system to be overdimensioned; but this, in turn, makes it easier for the system management to meet the water demands of the farmers.

Percolation

A small percentage of the water applied to the crops should move downward below the rootzone. This deep percolation (8) is needed to remove salts that would otherwise accumulate in the rootzone. Poor irrigation management or the non-uniform application of water inherent in many irrigation systems often causes excessive quantities of deep percolation.

Irrigation water that percolates deeply and recharges an aquifer adds to the water supply available to the users of groundwater (12). Some farms and small irrigation systems depend entirely on supplies of 'recoverable' groundwater (13). Aquifers are sometimes used to store excess surface water or to meet the water requirements in dry seasons or dry years.

'Irrecoverable' groundwater (14) is groundwater that cannot be pumped economically or that needs to flow out of the area to prevent the groundwater from becoming saline.

Surface Runoff

Applying irrigation water on graded fields often results in tailwater runoff (7) at the lower ends of the fields. The quantity depends on the field-application method, the field design, soil conditions, and operational practices. Some tailwater runoff may be unavoidable when fields are graded to achieve adequate uniformity and efficiency of water application. Tailwater can destroy the lower parts of a field, or it can be consumed by phreatophytes, or reach stream channels as return flow. It may be collected on-farm and pumped back into the distribution system for re-use, or it may be intercepted by other users as a supplemental or even a primary water source.

Return Flows

Return flows to rivers resulting from operational spills (6), tailwater runoff (7), drainage flows (9), or groundwater discharge (10) may provide all or part of a downstream user's water supply. In arid and semi-arid regions, such return flows often support fish and wildlife, which would otherwise not exist.

The entire process of diversion, conveyance, field application, and return flow may take from a few hours, with tailwater runoff, to several years when water returns via the groundwater system. These return flows, especially those from a groundwater system, may supplement the dry-season low flows downstream of the irrigated area.

In Figure 14.2, the quantity of water diverted from the river for irrigation is

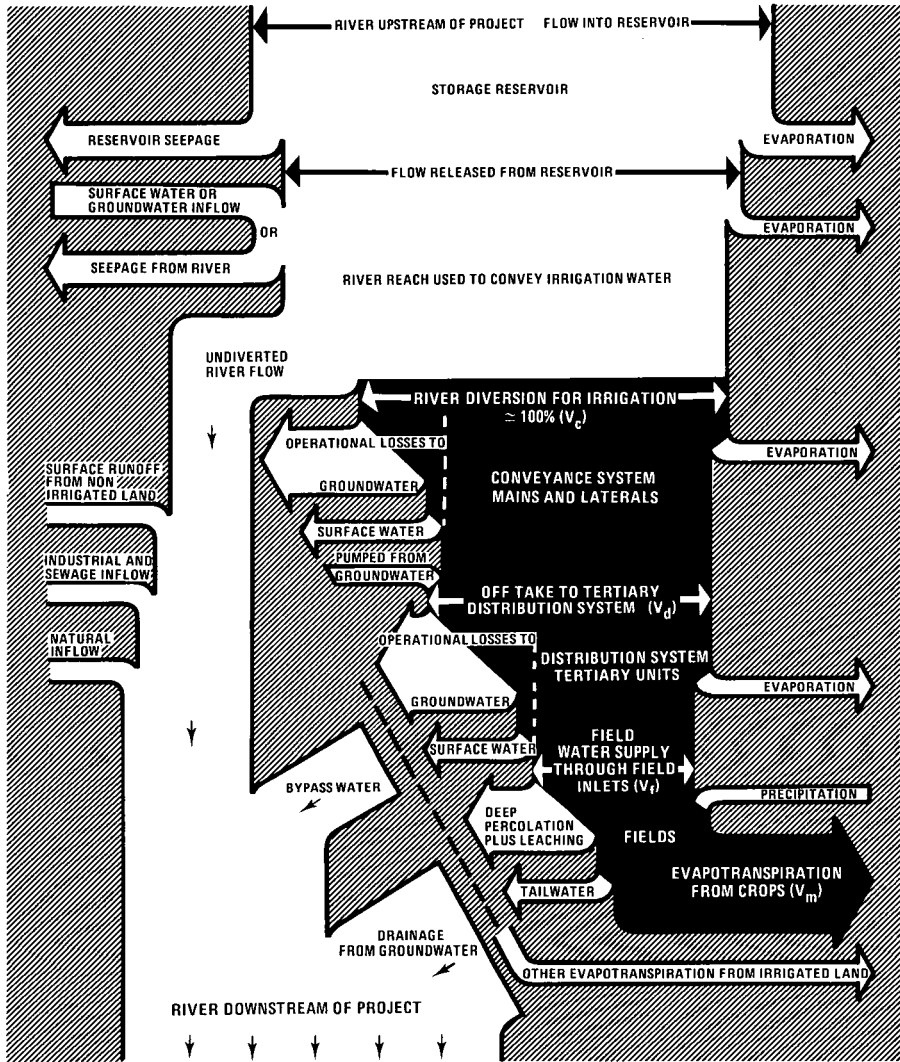

Figure 14.2 The relative magnitude of quantities of water flowing through an 'average' irrigation system (Bos 1979)

expressed as 100%. The width of the arrows in the figure illustrates the relative magnitude of water quantities in an 'average' irrigation system in arid or semi-arid regions.

Example of Changed Hydrology

One of the most natural types of irrigation was practised for millennia in the Nile Valley of Egypt, and was, in present-day terminology, highly sustainable. Agriculture was only possible through the residual soil moisture after controlled flooding, the so-called flood irrigation. Historically, the land was inundated during the six-week

period of river flood, around September to November, when the natural discharge of the Nile is at its maximum. The depth of the flooding varied from 1 to 3 m. The surplus water was drained back to the Nile. Crops were planted in the wet soil, ripened under the winter sun, and were harvested in spring.

The need for a better use of the land, especially after the introduction of cotton as a cash crop, led to a gradual change from flood irrigation to perennial irrigation. This started in the nineteenth century, and continued until 1967, the year that marked the completion of the Aswan High Dam.

The influence of the High Dam on the natural hydrology of the area is illustrated in Figure 14.3A, which depicts the seasonal fluctuations of the piezometric head in the aquifer under the clay-cap of the Nile Delta for the years 1958, 1968, and 1978 (Farid 1980). In 1958, before the Dam, the piezometric head was subject to considerable annual variation, and there was still a relationship with the natural regime of the Nile. In 1978, well after the completion of the Aswan High Dam, the head is constant, and is relatively high. This phenomenon is also shown in Figure 14.3B, where the piezometric head in the aquifer is at ground level, whereas the watertable is almost 1 m below ground level. This means that there is no natural

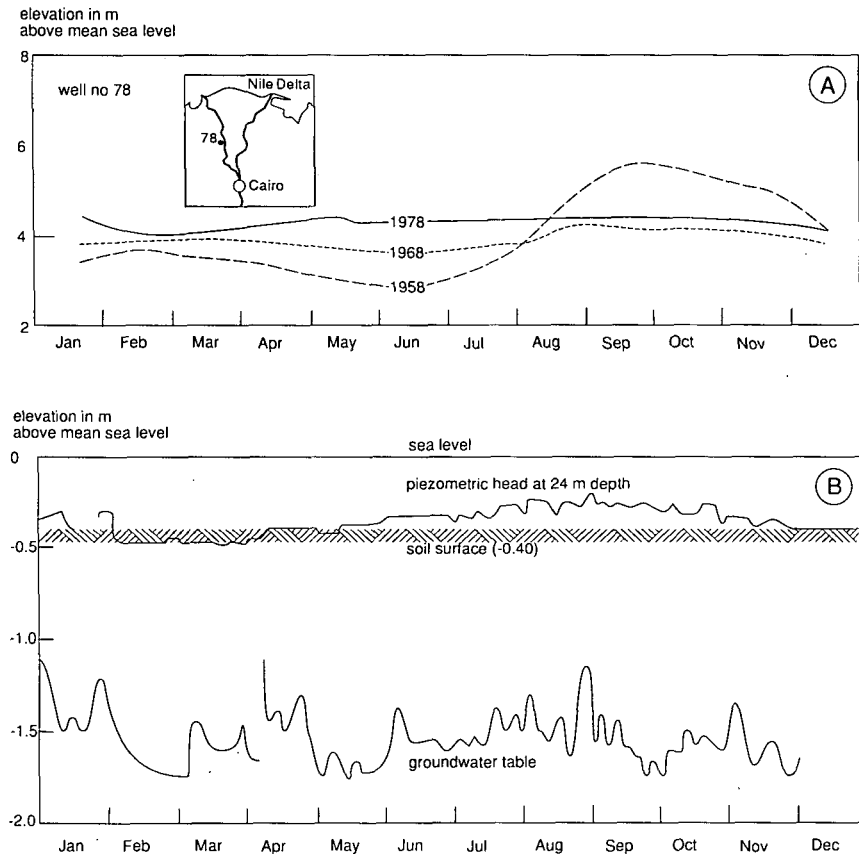

Figure 14.3 Fluctuations of the piezometric head in the Nile Delta aquifer

drainage, but continuous seepage inflow. Before 1958, the piezometric head varied throughout the year, thereby creating the possibility of natural drainage.

Example of Groundwater Recharge

Generally, the groundwater under an irrigation system in arid conditions is recharged by various sources:

- Water flowing in rivers;
- Water flowing in the canals of the irrigation system;
- Water applied to the fields;
- Groundwater flow from higher to lower elevations.

The effect of such recharge is shown in Figure 14.4 for the Pakistani Punjab. There, the introduction of irrigation was followed by a distinct rise of the groundwater. Calculations point out that about one-third of the rise of the groundwater must be attributed to percolation from irrigated fields; the remaining two-thirds is due to seepage from link canals, main canals, and field canals (Ahmad and Chaudhry 1988).

For Egyptian desert reclamation, Attia (1989) reports that about 30% of the groundwater recharge originates from the distribution system, and 70% from the field application of water. In the Grand Valley, U.S.A., the deep percolation from the fields is only 20% of the total water loss from the fields and the canal system together.

The volume (or depth) of water with which the groundwater is recharged in an irrigated area is variable. When there is hardly any rainfall and there is a water shortage in the irrigation system, it can be as little as, say, 50 mm annually. Under conditions of heavy rainfall (monsoon) and soils with a high permeability, it can be as much as 400 mm per rainy season. If half of the recharge is disposed of as (natural) drainage and the soil has a drainable porosity of 5%, this can mean a rise of 4 m in the groundwater level between the start and the end of the rainy season.

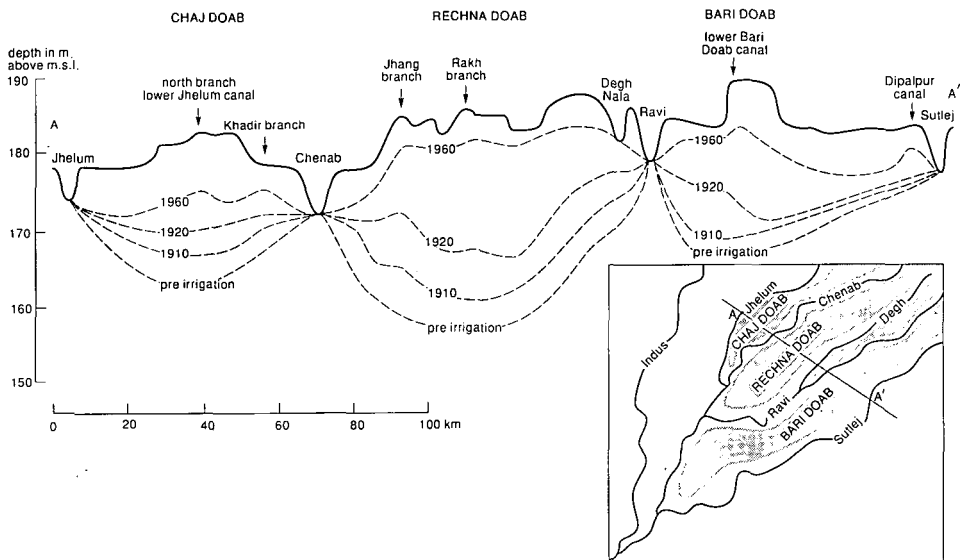

Figure 14.4 Groundwater profiles in north-eastern Pakistan (Bhatti 1987)

14.3 Salinity

In every drop of water, there are salts and, in irrigation water, even when of undisputed quality, there are considerable quantities of salts. In the vicinity of Cairo, for example, Nile water has an electrical conductivity of 0.6 dS/m, which equals about 360 mg/l. If 1 ha of land (10 000 m²) receives 600 mm of such water per growing season, the amount of salts supplied is about 2000 kg. These salts must be evacuated via percolation, the downward flux of the soil water. This flux can be due to irrigation, or rainfall, or both. The related drainage water has to be discharged either by the natural drainage system or by a man-made one.

Salinity on a Regional Scale

An area's salt balance is affected not only by the introduction of irrigation, but also by changes in land use, which can affect the area's natural salinity. Since it is often impossible to consider irrigation systems separately from other human interventions in an area, we shall give some attention here to 'natural' salinity under conditions where rain-fed agriculture is possible.

In dry continental conditions, the natural vegetation is usually grassland with trees (savanna) or grassland without trees (prairie, steppe). The water balance of such an area is disturbed when the land use is changed. When grassland is turned into farm land, when trees are cut, or when there is overgrazing, the actual evapotranspiration will decrease, thereby creating 'excess' water. When this excess water is evacuated from the area by natural drainage, salinity problems will not develop. When there is no natural drainage, or not enough, however, the excess water will collect at locations with a low surface elevation and will evaporate there, leaving the salts behind. This effect is sometimes referred to as 'saline seep' (AADEO 1979).

Saline seeps are characterised by high watertables, the accumulation of salts, and salt-tolerant vegetation. Saline seeps will occur under natural conditions, but, at many locations, their extent has increased rapidly through man's interference with nature. Saline seeps can be controlled by growing useful salt-tolerant crops in salt-affected areas or by subsurface drainage of specific seep areas. Nevertheless, it is much better to prevent the formation and percolation of excess moisture in the area. Subsurface flow into saline seeps can be prevented by continuous cropping, by planting deep-rooting perennials (forages), and by eliminating seepage from irrigation canals. Deep-rooting perennial crops use more water than cereals do, for instance, and they use water for a longer period. This applies even more so for trees. Some areas have been 'drained' by afforestation.

Generally, ecosystems are very sensitive to changes in the water balance. Consider an area with an annual rainfall of 500 mm, and an actual evapotranspiration of 480 mm. The long-term average excess of water is 20 mm a year. A simple water-and-salt-balance calculation shows that if this quantity of excess water is not discharged by (natural) drainage, and if the evaporation from wet and salty spots is 1000 mm a year, approximately 2% of the area will salinize (Van der Molen 1984).

The effect that changes in land use have on salinity should not be underestimated. In many countries in the world (e.g. Northern America and Australia), they have led to salinity problems. Also, the present salinity problems of the Indo-Gangetic Plain

in India might be related to changes in land use. Around 1950, 22% of India's geographical area was covered with dense forest, but recent satellite surveys have shown that nowadays only half of this area is still forest (Mathur and Garg 1991). Large tracts of *usar* (Hindi for barren) lands typically occur in low-lying basins between productive land. Similar to the 'saline seeps' of Alberta in Canada, there has always been *usar* land in India, but its extent is steadily increasing.

Introducing irrigation has a far greater effect on the natural environment than changes in land use. One of the most common consequences is that a drainage system is needed for sustainable, irrigated, agricultural production.

Salinity on a Local Scale

The control of salinity on a local scale can normally be achieved by draining off the percolation water and keeping the watertable at a sufficient depth. If natural drainage and seepage can be neglected, the required design drain discharge for salinity control will be in the range of 1–2 mm/d (see Chapter 15). The percolation will not be equally distributed over a field; its pattern will vary from year to year and from season to season, depending on the irrigation method and the amount of water applied. Nevertheless, for surface irrigation and sprinkling, and for a large range of soils provided with sufficient drainage, we can estimate the long-term minimum percolation losses to be around one quarter of the diverted irrigation water. The percolation losses will be higher for coarse soils and lower for fine soils.

Groundwater may support crop growth by capillary rise through the unsaturated zone. If this continues long enough, the watertable will fall, and this supply will diminish to zero. If the groundwater is replenished, however, (e.g. by seepage), the capillary rise will continue and the profile will salinize because of the upward flux of water and salts. To avoid this problem, watertables should be kept at a certain minimum depth. The required depth mainly depends on the soil type (see Chapter 15).

One should not expect salinity problems to disappear merely by installing a drainage system. High salinities will remain if the soils are not leached, and the key to leaching is the availability of water.

Mobilization of Salts in the Subsoil

Up to now, we have dealt with salinity as if it were supplied from the surface only. In many areas, however, which historically had low groundwater levels, irrigation is now causing these levels to rise. There, 'fossil' salts that have accumulated in deep soil layers are being mobilized and transported upward with the groundwater in the direction of the rootzone.

The salinity of such groundwater will create problems for farmers who install tubewells to supplement the often-low canal supply of irrigation water. In this respect, deep tubewells are more damaging than shallow tubewells. Shallow tubewells also have the advantage that, with the smaller groups of users that they supply, the responsibilities for maintenance and operation are better shared than with deep tubewells, which have a larger yield.

'Fossil' salts are mobilized not only by deep tubewells. Any drainage system will cause the flow of water through deeper layers. The salt balance of a drainage pilot area in Egypt could only be 'closed' when a much higher than expected salt content

of the groundwater was assumed (Abdel-Dayem and Ritzema 1990). The topsoil of the pilot area had been leached in about two years after the implementation of the drainage system, but the subsoil was still desalinizing after several years.

Other solutes may also be mobilized by drainage. In the San Joaquin River Valley in California, U.S.A., selenium was discovered to be the cause of deaths and deformities in aquatic wildlife in the Kesterson Reservoir (Summers and Anderson 1989). Much of the drainage water in parts of the San Joaquin Valley is high in concentrations of dissolved solids, and contains selenium, molybdenum, boron, and other elements. The origin of selenium as a toxic element in the San Joaquin Valley is natural, which means that treating the source is impossible. With subsurface drainage, because the flow through the subsoil will extend to a depth of about one-fourth of the drain spacing, a ban on more subsurface drainage could prevent the mobilization of the selenium.

14.4 Water Balances and Irrigation Efficiencies

14.4.1 Irrigation Efficiencies

The process of supplying irrigation water is usually split into three parts (Bos and Nugteren 1990):

- Conveyance (i.e. the transport of water between the source and the tertiary unit offtake);
- Distribution (i.e. the transport of water between the tertiary offtake and the field inlet);
- Field application (i.e. the application of water downstream of the field inlet).

Figure 14.5 presents a diagram of the flow of water in irrigation as a water balance for an irrigated area. In this figure, the scheme is divided into the three separate parts of the water-supply process. Irrigation efficiencies are basically ratios of volumes: for example, the ratio of 'evapotranspiration minus effective precipitation (V_m)' over 'flow diverted or pumped from the river or reservoir (V_c)' is the project or overall irrigation efficiency. If more data on a system are available, other efficiencies can be calculated. The irrigation efficiencies used here are those of ICID (1978; Bos 1980):

$$\text{Conveyance efficiency} \quad e_c = \frac{V_d + V_2}{V_c + V_1}$$

$$\text{Distribution efficiency} \quad e_d = \frac{V_f + V_3}{V_d}$$

$$\text{Field-application efficiency} \quad e_a = \frac{V_m}{V_f}$$

$$\text{Overall or project efficiency} \quad e_p = \frac{V_m + V_2 + V_3}{V_c + V_1}$$

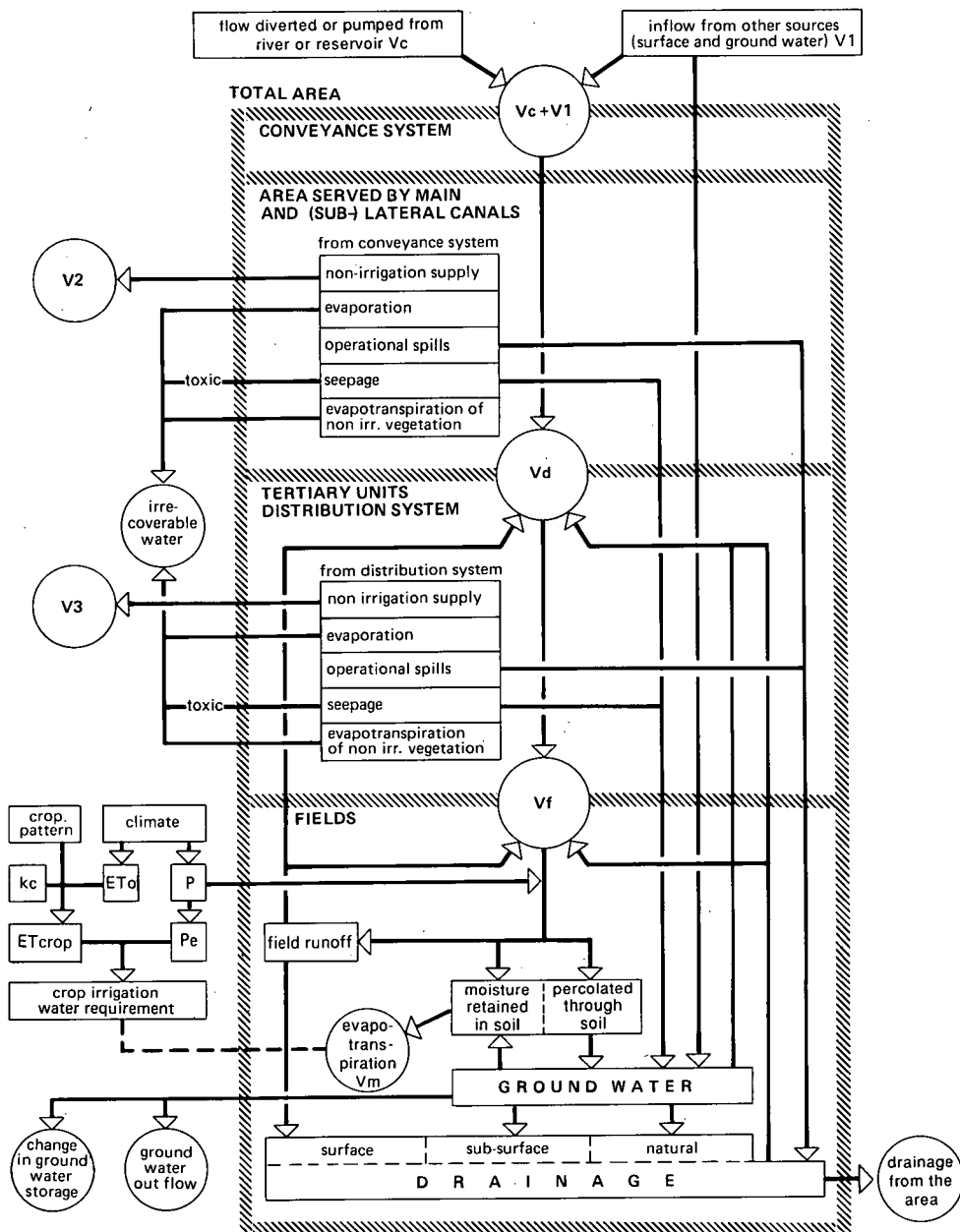

Figure 14.5 A diagram of the flow of water in an irrigation process (Wolters 1992)

where

V_c = volume diverted or pumped from the river (m^3)

V_d = volume delivered to the distribution system (m^3)

V_f = volume of water furnished to the fields (m^3)

V_m = volume of water needed, and made available, for evapotranspiration by the crop to avoid undesirable water stress in the plants throughout the growing cycle (m^3)

V_1 = inflow from other sources (m^3)

V_2 = non-irrigation deliveries from the conveyance system (m^3)

V_3 = non-irrigation deliveries from the distribution system (m^3)

Since the purpose of irrigation is generally to grow crops, the part of the water that turns into 'evapotranspiration' is the most important in the water balance. Figure 14.2 showed that, of the volume of water at the start of the process, only a portion will become evapotranspiration. In the evaluation of the water balance of irrigation schemes, the 'crop irrigation water requirement' plays an important role. Under what is generally described as well-watered conditions, crops will reach their potential evapotranspiration. Under conditions of water shortage, however, the actual evapotranspiration will be lower than the potential (see Chapter 5). The deviation of the actual evapotranspiration from the potential depends on the degree of water shortage, which, in turn, depends on the total volume of water supplied to the area, and the division of that water over the area.

Rainfall can lead to excess water in irrigation schemes. The occurrence of rain with time is random and can be variable over a large area. If the travel time of water in the system is long, water already released for irrigation becomes excess water if rain suddenly starts. Rain can fall just before or after an irrigation, and then either the rain will not be effective or most of the irrigation water will percolate. If the rain intensity is high, the water cannot infiltrate and will become surface runoff.

Water not turned into evapotranspiration can be divided into a 'recoverable' volume of water (e.g. seepage from the conveyance and distribution systems, operational spills, surface runoff from fields, percolation) and an 'irrecoverable' volume of water (e.g. evaporation from fallow land, evaporation from the conveyance and distribution systems, evapotranspiration by non-irrigated crops). Whether water is recoverable depends, among other things, on its quality: its salinity may have become too high, or it may have picked up toxic substances.

Whenever there is a water shortage, drainage water tends to be re-used for agriculture. Drainage water that has left the area can be re-used somewhere else. If re-used inside the area, it will affect the performance of the system: evapotranspiration will increase without more water being diverted to the system.

There is a difference between re-used drainage water supplied to the distribution system, or to the conveyance system (Wolters and Bos 1990). Usually, the total volume of re-use can be divided into two parts: official and unofficial. The official part is the volume of water re-used with facilities installed by the system management (by gravity or pumping); the unofficial part is the generally unknown volume of water re-used by the farmers.

Re-use usually leads to a poorer water quality downstream of the irrigation system because drainage water from an irrigation scheme can be quite saline; as well, it usually transports chemicals in the form of pesticides, herbicides, and fertilizer. This is a world-wide problem, and one that is becoming increasingly serious (see Chapter 25).

Whether or Not to Increase Irrigation Efficiencies

The limits to the availability of water and land for irrigated agriculture necessitate the careful use of these resources. This is the reason why many irrigation system managers strive to increase the efficiency of their irrigation water use. An increased efficiency can have many positive effects, but negative effects as well. The positive effects are (Wolters 1992):

- A larger area can be irrigated with the same volume of water, and the effect of a water shortage will be less severe;
- The competition between water users can be reduced;
- Water can be kept in storage for the current (or another) season;
- Groundwater levels will be lower, which can lead to lower investment costs for the control of waterlogging and salinity;
- There will be less flooding;
- Better use will be made of fertilizers and pesticides, and there will be less contamination of groundwater, and less leaching of minerals;
- Health hazards can be reduced;
- Energy can be saved;
- There will be fewer irrecoverable losses;
- Instream flows, after withdrawals, can be larger, thereby benefitting aquatic life, recreation, and water quality.

The negative effects of increasing the efficiency of irrigation water use are:

- Soil salinity may increase because of reduced leaching;
- Wetlands and other wildlife habitats may cease to exist;
- Groundwater levels will fall and aquifers will receive less recharge;
- Water retention in upstream river-basin areas will be reduced;
- There will be a need for a more expensive infrastructure, and for a more accurate operation and monitoring.

These lists show that when one is considering increasing efficiencies, many effects have to be considered. The relationship between irrigation efficiencies and drainage will be illustrated in the next two sections.

14.4.2 Conveyance and Distribution Efficiency

Water losses in the conveyance and distribution systems of an 'average' irrigation scheme can be considerable (see Figure 14.2). They occur mainly through seepage and incorrect management practices. The importance of these factors is illustrated in Figure 14.6, which compares the conveyance efficiencies (e_c) of two similarly-managed systems in Australia: the Goulbourn and the Campaspe systems. When the Goulbourn system first operated, its conveyance efficiency, e_c , was about 0.50, while that of the leaking Campaspe system was as low as $e_c = 0.39$. In the Goulbourn system, after proper structures had been installed to measure and regulate flows and the related improvement in its operational practices, its e_c -value rose to about 0.80. Later, the leaking Campaspe was lined and fitted with structures similar to those in the Goulbourn system, and its operational practices, too, were improved. As a result,

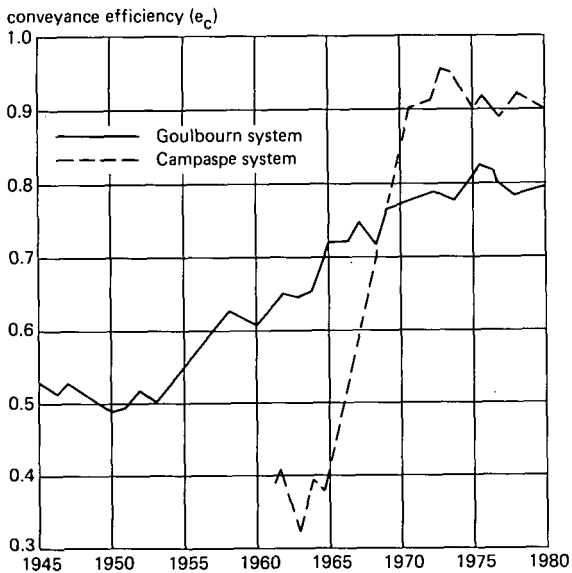

Figure 14.6 Conveyance efficiencies as a function of time in two irrigation systems in Australia (Tregear 1981)

its e_c -value rose to about 0.90, some 10% higher than that of the unlined Goulbourn system (Tregear 1981).

The importance of increasing the conveyance efficiency of an irrigation system has also been proven in the Beni Amino Scheme in the Moroccan Tadla region. There, waterlogging completely disappeared after the canals had been lined. The existing natural drainage capacity was capable of discharging the prevalent excess water (Tadla 1964).

Rate of Change of Groundwater Depth

The efficiency with which irrigation water is used influences the rate of change in groundwater depth. Hence, a change in the water management of an irrigation system could alter the need for a drainage system. We shall illustrate this by comparing some performance indicators of the Rio Tunuyan Scheme (Bos et al. 1991). The e_p (here the overall irrigation efficiency of canal water use) is the ratio of the crop water use over the volume of water diverted into the canal system. Figure 14.7 shows the monthly average value of this efficiency. This figure also shows monthly average values of rainfall and of the groundwater depth below the soil surface. Contrasting the average monthly rainfall data with the depth to groundwater shows that the watertable drops during most of the high rainfall months. This is probably because the rainfall is low in comparison with the evapotranspiration.

Figure 14.8 shows the monthly ratio of crop irrigation water use over the diverted volume of canal water, versus average monthly changes in groundwater level. There is a trend that, in months with an e_p -value below 60%, the groundwater level rises, and in months when this ratio exceeds 60%, the groundwater level falls. The e_p can thus be used as a management indicator to control the groundwater depth below the soil surface.

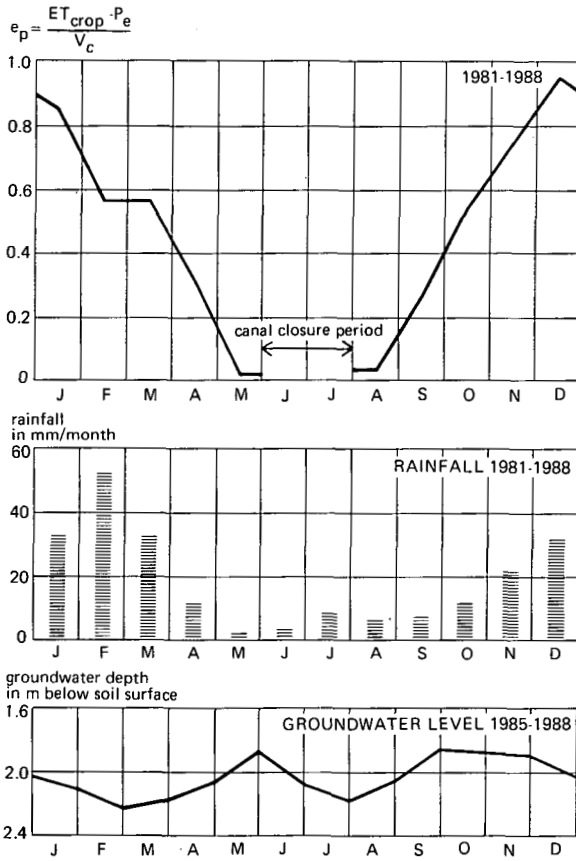

Figure 14.7 Ratio of crop water use over the water diverted into the canal system

The Rio Tunuyan Valley is a typical example of an irrigated area where a high groundwater level has to be prevented to limit the capillary rise of water. An increase in capillary rise would result in a net flow of water, with salts, towards the soil surface, which would reduce crop production. Figure 14.7 shows that the watertable rises about 0.2 m/month immediately before and after the canal closure period, which are months with a very low overall efficiency of irrigation water use. A change in water management aimed at increasing the overall irrigation efficiency to about 40% during this period would contribute to solving the waterlogging and salinity problems in this valley.

14.4.3 Field Application Efficiency

The components of a water and salt balance at field level are illustrated in Figure 14.9. Frequently, water that originates from irrigation recharges the groundwater at a rate that exceeds the natural discharge. As a result, the watertable rises at a rate that depends greatly on the volume of water applied to the field. The excessively-

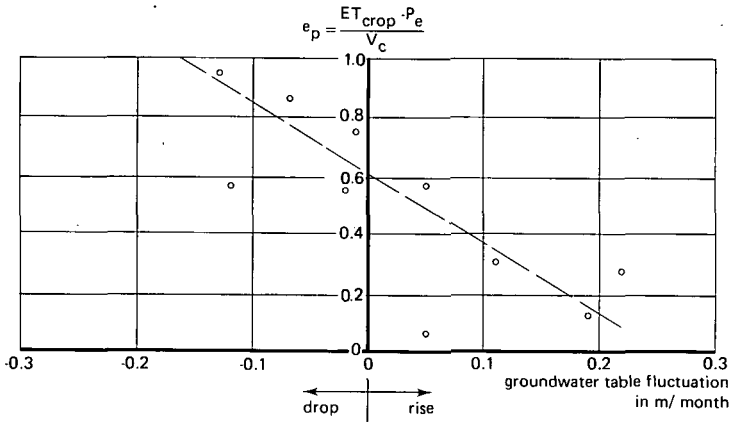

Figure 14.8 Relation of the overall irrigation efficiency of canal water use and the groundwater fluctuation, monthly averages

applied water will percolate to the groundwater and thus leach the rootzone to a salt level that is acceptable for crop growth. Often, however, the farmer will apply additional water to his fields because he thinks they need more leaching. As a result, the watertable below the irrigated and leached fields will continue to rise. The ensuing problems of waterlogging and salinity are often more severe than the original problems that triggered off the initial leaching.

In literature (Chapter 15; Bos and Nugteren 1990; FAO 1980; Wolters 1992), tables and graphs can be found with values for field application efficiency per field application method, soil type, etc. Seasonal average e_a -values of 60% are common

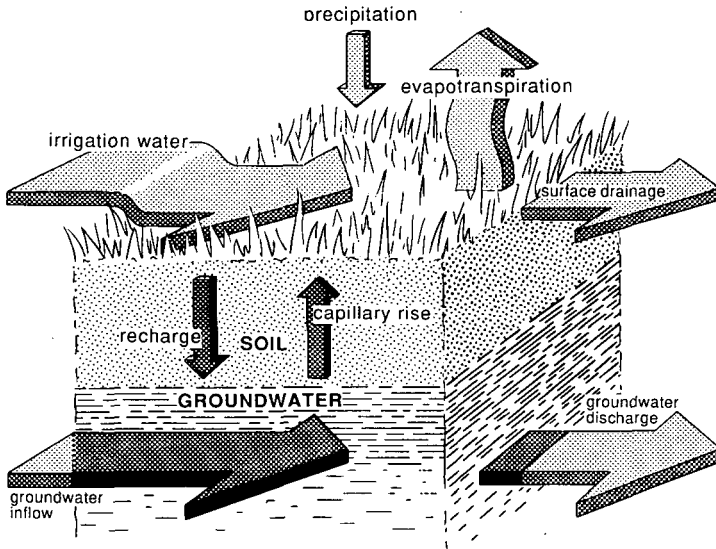

Figure 14.9 Principle of a water and salt balance in an irrigated area

for non-rice schemes with field application methods such as furrow and border, and on medium to heavy soils. For sprinkler-irrigated schemes, a typical e_a -value would be 70%. Nevertheless, it is possible to find seasonal averages that deviate considerably from these values. The highest seasonal e_a -values of 80% and over, for a wide range of soil types and field application methods, are always associated with water shortages in the peak season (Wolters 1991).

Very often, field application efficiency values presented in the tables in literature are averages over a year or a season, although the need for water and the availability of water vary considerably within a growing season. Because of these variations, field application efficiency values also vary. Seasonal average values are good indications of the overall water balance, but do not have a direct relationship with what actually happens in the fields. The volumes involved are also different within the season. A relatively low efficiency at the start of the growing season is much less of a problem, from a water conservation point of view, than a relatively low efficiency in the peak season, when the volumes of water are much greater. Field application efficiencies (and other efficiencies as well) should be considered per month instead of per season. A very high monthly value of e_a implies that hardly any water, and consequently hardly any salts, are evacuated from the fields. Such an efficiency is only acceptable when rainfall, or some other source of water, will evacuate the excess salts in another period of the year.

Generally, the long-term minimum percolation losses with surface irrigation and sprinkling can be estimated around 20 – 25% for a wide range of soils provided with sufficient drainage. The percolation losses will be higher for very coarse soils (e.g. sand), and lower for very fine soils (e.g. silty clay and clay).

In an Egyptian desert reclamation strip, consisting of medium-grained fluvial sands and predominantly irrigated with level basins at a frequency of about five times a month, an overall efficiency of about 30% was found (Attia 1989). The main problem in such areas is the low water retention of the soils. The only way to counteract this would be to choose an application system that can apply water at very brief intervals, and in a small quantity per application.

Increasing field application efficiencies, by reducing the irrigation supply and improving the uniformity of field application, is generally expected to be beneficial. One effect could be that the occurrence of harmful or toxic elements in drainage water (as in the San Joaquin Valley) is counteracted, because of the reduced drainage water outflow. But, a question that arises is: 'How much improvement can be made in irrigation efficiencies when lands are already supplied with less water than required?' Supposing that the salt balance of the rootzone has always been in equilibrium, reducing the water supply could lead to salinization. Periodic leaching to maintain a favourable rootzone salt balance is then no solution, because it would nullify the positive effect of reduced percolation through the reduced irrigation supply.

Another expectedly-beneficial effect of increasing irrigation efficiency is the availability of more water. But, if the 'extra' water were then to be used to expand the cultivated land in an area like the San Joaquin Valley, the effect might even be counter-productive, because sources of toxic solubles that are at present immobile might be mobilized and enter the environment.

14.5 Combined Irrigation and Drainage Systems

It is possible to use a drainage system for irrigation as well. This is known as 'infiltration irrigation', 'sub-irrigation', or 'inverse drainage'. The method is applied in The Netherlands for the cultivation of flower bulbs. In the open ditches between the bulb fields, the water level is carefully maintained by the supply or withdrawal of water. This method was developed in an area close to the North Sea dunes. The soils have been levelled to exactly 0.55 m above polder water level, which is very accurately kept constant. The soils in this area are deep and highly permeable. In the most advanced version of sub-irrigation, the water flows through a fairly dense network of parallel sub-surface pipe drains that have been laid horizontally for this purpose.

Successful sub-irrigation is only possible under the following conditions:

- A flat soil surface;
- Small water losses to the underground and adjacent areas;
- Permeable soils (also when always saturated or at field capacity).

Sub-irrigation is known to be used in a steady and a non-steady manner: steady for a situation where the water level in the ditches is maintained at a fixed level (e.g. for the flower bulbs on sandy soils in The Netherlands), and non-steady when the water level in the ditches is increased to field level for short periods (e.g. in coastal plains in the humid tropics).

The relationship between irrigation and drainage is illustrated in Figure 14.10, which shows the schematic watertable elevation with steady-state infiltration, for which an 'inverse drainage' formula can be derived (Hooghoudt 1940)

$$q = \frac{8K_b d(n - h) + 4K_t(n^2 - h^2)}{L^2}$$

where

- q = water supply rate by infiltration (m/d)
- K_t = saturated hydraulic conductivity above drain level (m/d)
- K_b = saturated hydraulic conductivity below drain level (m/d)
- d = equivalent depth (m)

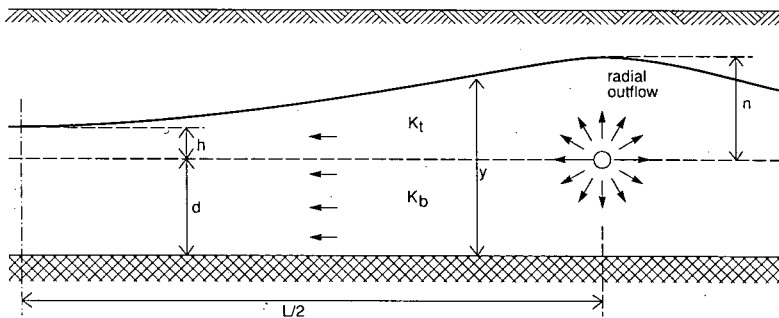

Figure 14.10 Schematic watertable for 'inverse' drainage

n = infiltration head (m)

h = elevation of water above drain level, midway between the drains (m)

L = drain spacing (m)

One of the assumptions for the infiltration-spacing equation is the absence of entrance resistance near the drain. This appears to be correct for infiltration via drain pipes, but not for infiltration via open ditches. With open ditches, the entrance resistance, combined with radial resistance, appears to be the determining factor. The total resistance to flow can then be assumed to be concentrated near the infiltration surface of the open ditches, and the flow resistance in the aquifer can be neglected.

References

- AADEO 1979. Dryland saline seep control. Alberta Agriculture's District Extension Office, Edmonton, 7 p.
- Abdel-Dayem, Safwat and H.P. Ritzema 1990. Verification of drainage design criteria in the Nile Delta, Egypt. *Irrigation and Drainage Systems*, 4, 2, pp. 117-131.
- Ahmad N. and G.R. Chaudhry 1988. *Irrigated agriculture of Pakistan*. Nazir, Lahore, 800 p.
- Attia, F.A.R. 1989. Drainage problems in the Nile Valley resulting from desert reclamation. *Irrigation and Drainage Systems*, 3, 2, pp. 153-167.
- Bhatti, A.K. 1987. A review of planning strategies of salinity control and reclamation projects in Pakistan. In: J. Vos (ed.), *Proceedings, symposium 25th International Course on Land Drainage*. ILRI Publication 42, Wageningen, pp. 216-226.
- Boone, S.G. (ed.) 1979. *Irrigation water use and management : an interagency task force report*. U.S. Government Printing Office, Washington, 133 p.
- Bos, M.G. 1979. Der Einfluss der Grösse der Bewässerungseinheiten auf die verschiedene Bewässerungswirkungsgrade. *Zeitschrift für Bewässerung-wirtschaft*, 1, 14, pp. 139-155.
- Bos, M.G. 1980. Irrigation efficiencies at crop production level. *ICID Bulletin* 29, 2, pp. 18-26.
- Bos, M.G. and J. Nugteren 1990. *On irrigation efficiencies*. 4th ed. ILRI Publication 19, Wageningen, 117 p.
- Bos, M.G., W. Wolters, A. Drovandi and J.A. Morabito 1991. The Viejo Retamo secondary canal: performance evaluation case study, Mendoza, Argentina. *Irrigation and Drainage Systems* 5, 1, pp. 77-88.
- FAO 1980. *Drainage design factors*. Irrigation and Drainage Paper 38, Rome, 52 p.
- Farid, M.S. 1980. Nile Delta Groundwater Flow, MSc. Thesis, Cairo University, Faculty of Engineering, Cairo.
- Hooghoudt, S.B. 1940. Algemeene beschouwing van het probleem van de detailontwatering en de infiltratie door middel van parallel loopende drains, greppels, slooten en kanalen. *Verslagen van landbouwkundige onderzoekingen* 46(14)B. Algemeene Landsdrukkerij, 's-Gravenhage, 193 p.
- ICID 1978. Standards for the calculation of irrigation efficiencies. *ICID Bulletin* 27, 1, pp. 91-101.
- Mathur, R.S. and R.K. Garg 1991. Reclaiming usar lands. Workshop on sodic lands reclamation in Uttar Pradesh : management and prospects. UP Land Development Corporation, Lucknow.
- Schulze, F.E. and J.M. van Staveren 1980. Land and water development in the third world. In: *Land Reclamation and Water Management*. ILRI Publication 27, Wageningen, 191 p.
- Summers, J.B. and S.S. Anderson (eds.) 1989. *Toxic substances in agricultural water supply and drainage*. U.S. Committee on Irrigation and Drainage, Denver, 424 p.
- Tadla 1964. Etude de mise en valeur du Royaume du Maroc. Périmètre du Tadla 507. Grontmij Consulting Engineers, De Bilt.
- Tregear, R. 1981. Water distribution efficiency in Victoria. Minor Thesis, Monash University, Australia, 79 p.
- Van der Molen, W.H. 1984. Salinity under natural conditions and under rainfed agriculture. Unpublished. Wageningen Agricultural University, Department of Water Resources, Wageningen, 22 p.
- Wolters, W. and M.G. Bos 1990. Interrelationship between irrigation efficiency and the re-use of drainage water. In: *Symposium on land drainage for salinity control in arid and semi-arid regions*. Drainage Research Institute, Cairo, pp. 237-245.

Wolters, W. 1991. Water shortage and irrigation efficiencies. ILRI Annual Report 1990. ILRI, Wageningen, pp. 27-33.

Wolters, W. 1992. Influences on the efficiency of irrigation water use. ILRI Publication 51, Wageningen, 150 p.

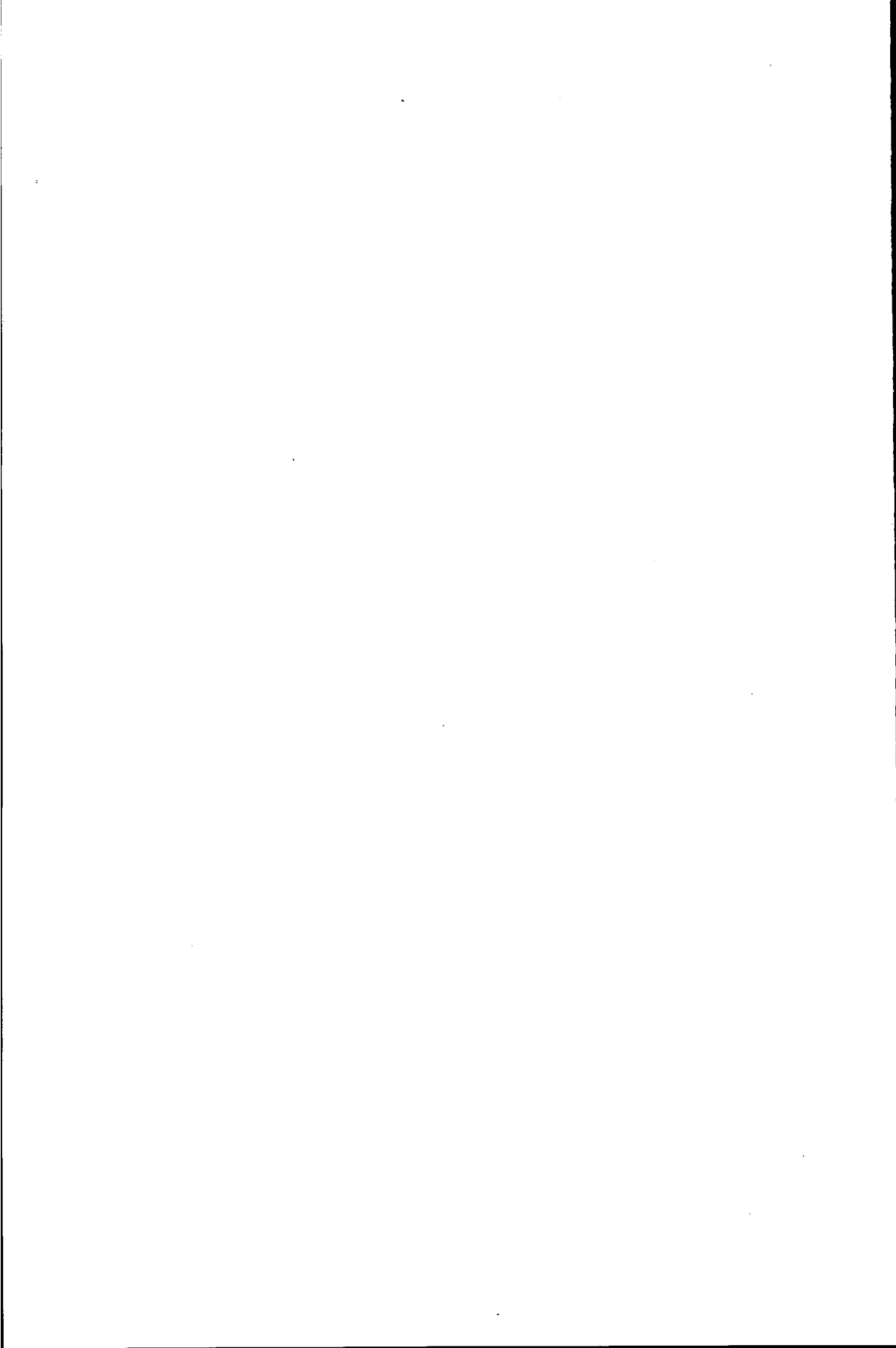

15 Salinity Control

J.W. van Hoorn¹ and J.G. van Alphen²

15.1 Salinity in relation to Irrigation and Drainage

The application of irrigation water means an input of salts. Irrigation water, even if of excellent quality, is a major source of soluble salts. If soil salinization is to be avoided, these salts have to be leached out of the rootzone by water percolating to the subsoil. This percolation water will cause the watertable to rise and has to be drained off because a second source of salinization in irrigated areas is capillary rise from a watertable. As groundwater is often somewhat saline, even a small amount of capillary rise can add greatly to the salinity of the rootzone. Drainage, either natural or artificial, is a necessary complement to irrigation. Whereas the aim of drainage in a humid area is to control soil water for better aeration, higher temperatures, and easier workability, its primary aim in irrigated land is to control soil salinity.

Section 2 of this chapter discusses soil salinity and sodicity. In view of the extensive literature on saline and sodic soils, only some general aspects of these soils and their classification will be treated. Section 3 deals with the salt balance of the rootzone and the leaching requirement. Because important assumptions are made about capillary rise and the leaching process, these subjects are treated in detail in Sections 4 and 5. Section 6 discusses the long-term salinity level and compares leaching fractions and percolation losses in the light of drain discharge criteria. As the sodicity of irrigation water can affect a soil's structure and permeability – key factors in the leaching process – the sodium hazard of irrigation water is discussed in Section 7. Finally, Section 8 presents some considerations on the reclamation of salt-affected soils, particularly of the leaching process.

15.2 Soil Salinity and Sodicity

15.2.1 Electrical Conductivity and Soil Water Extracts

Because of the strong relationship between the electrical conductivity, EC, of a soil extract and the soil's salt concentration, the salt content of a soil is commonly expressed by the EC. Measured at a reference temperature of 25 °C, the EC is nowadays expressed in decisiemens per m (dS/m). The older unit for electrical conductivity which is still frequently used is mmho/cm (1 mmho/cm = 1 dS/m). The salt concentration of a solution is expressed in 'old' units g/l, mg/l (= ppm), meq/l or new SI units kg/m³ and mol/m³. Similarly, the ion concentration is expressed in 'old' units meq/l or new (not used here) mol/m³. A milliequivalent is the mass of an ion or compound that combines with or replaces 1 mg of hydrogen, and equals the atomic or molar mass of the ion divided by its valency.

¹ Retired from Department of Water Resources, University of Agriculture, Wageningen

² International Agricultural Centre, Wageningen

Figure 15.1 shows the relation between the EC, expressed in dS/m, and the salt concentration, expressed in meq/l. For different ions and salts, Table 15.1A presents the relation between mg and meq, and Table 15.1B the average relation between meq/l, dS/m, mg/l, mg/meq, and the ratio meq/l to dS/m. The decrease in the ratio mg/meq is due to the relative increase in Cl^- ions over SO_4^{2-} and HCO_3^- ions with increasing salt concentration. The increase in the ratio meq/l to dS/m is due to the decreasing ion activity with increasing salt concentration. On the average, dividing the salt concentration in meq/l by a value between 10 and 12 yields the EC in dS/m.

To appraise soil salinity, we can measure the EC or the salt concentration in several soil water extracts. The most reliable appraisal is obtained by measuring the salt concentration in soil water at field capacity. This method yields the real salt concentration in soil water under field conditions and is directly related to plant growth. In a laboratory, it is difficult to obtain a sufficient amount of soil water from samples at field capacity.

Most commonly used for the appraisal of soil salinity is the saturation extract. We prepare a saturated paste by adding water to dry soil. We then obtain the saturation extract by applying suction to the saturated soil paste. For most soils – sand and loamy sand excepted – this paste contains about two times the amount of water at field capacity. One should therefore realize that the saturated paste is an oversaturated paste compared with saturation under undisturbed field conditions, and that the

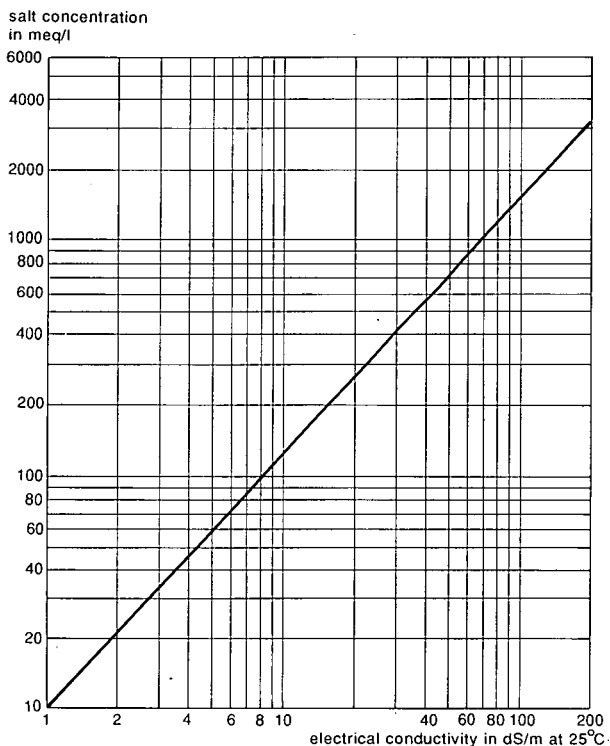

Figure 15.1 Relation between electrical conductivity and salt concentration (after Richards 1954)

Table 15.1A Relation between milligram and milliequivalent

Ion	mg/meq	Salt	mg/meq
Na ⁺	23	NaCl	58.5
K ⁺	39	CaCl ₂	55.5
Ca ²⁺	20	MgCl ₂	47.5
Mg ²⁺	12	Na ₂ SO ₄	71
Cl ⁻	35.5	CaSO ₄	68
SO ₄ ²⁻	48	MgSO ₄	60
HCO ₃ ⁻	61	NaHCO ₃	84
CO ₃ ²⁻	30	Ca(HCO ₃) ₂	81
		Mg(HCO ₃) ₂	73

Table 15.1B Average relation between meq/l, dS/m, mg/l, mg/meq, and the ratio meq/l to dS/m

meq/l	dS/m	mg/l	mg/meq	<u>meq/l</u> dS/m
10	1	640	64	10
120	10	7000	58.3	12

saturation extract is a diluted solution compared with soil water at field capacity.

If samples are taken from the same soil in order to study changes in soil salinity, one should prepare the saturated paste by always adding the same amount of water to the air-dry soil. Otherwise, differences in EC_e may be due to differences in the paste's water content instead of those in salt content.

As the preparation of the saturation extract is laborious, soil water extracts 1:1 (100 g water per 100 g dry soil), 2:1, or a higher dilution are prepared for routine purposes. In general, enough water can be obtained by simply filtering the soil solution without using a suction apparatus.

In the case of highly soluble salts (e.g. chloride salts), the EC is almost inversely proportional to the water content and the following expressions can be used for conversion

$$EC_{fc} = 2EC_e \text{ and } EC_{1:1} = 2EC_{2:1}$$

where

fc = suffix denoting field capacity

e = suffix denoting saturation extract

If slightly soluble salts such as lime (CaCO₃) and gypsum (CaSO₄) are present in the soil, one must be careful with the conversion of the EC or of the salt concentration obtained in a diluted extract. If solid lime or gypsum are the only salts present, each soil water extract, independent of the water-soil ratio, will contain the same concentration of these salts and will show the same EC.

15.2.2 Exchangeable Sodium

The solid phase in the soil has a negative surface charge. The magnitude of the negative charge depends on the amount of clay and organic matter present in the soil, and on the type of clay mineral. The electroneutrality is then provided by certain cations, mainly Ca^{2+} , Mg^{2+} , Na^+ , K^+ , and H^+ ions. These cations are adsorbed and are mutually replaceable or exchangeable. For instance, when a soil is percolated with a solution containing calcium (Ca^{2+}) salts, the amount of adsorbed Ca ions will increase at the expense of an equivalent amount of other cations. Similarly, the amount of adsorbed Na ions will increase when a solution containing sodium (Na^+) salts is added. In many soils, the greater part of the adsorbed ions consists of calcium. In salt-affected soils, however, exchangeable sodium can be present in large amounts.

The composition of the adsorbed cations is related to the concentrations of the various cations present in the soil solution. In a simple system with only Na^+ , Ca^{2+} and Mg^{2+} cations present, this relation is given by the Gapon Equation

$$\frac{\gamma_{\text{Na}}}{\gamma_{\text{Ca}} + \gamma_{\text{Mg}}} = K_G \frac{\text{Na}}{\sqrt{\frac{\text{Ca} + \text{Mg}}{2}}} \quad (15.1)$$

where

- γ_{Na} , γ_{Ca} , and γ_{Mg} = the amount of adsorbed sodium, calcium, and magnesium (meq/100 g)
- Na, Ca, Mg = the concentration of sodium, calcium, and magnesium in the soil solution (meq/l)
- K_G = the exchange coefficient, being a constant for a certain clay mineral and combination of cations present in the soil-water system (meq/l)^{-0.5}

The last term of Equation 15.1, $\text{Na}/\sqrt{(\text{Ca} + \text{Mg})/2}$, is the Sodium Adsorption Ratio, SAR. The amount of adsorbed sodium is usually expressed as a percentage of the cation exchange capacity, and is called the Exchangeable Sodium Percentage, ESP. In salt-affected soils, the sum of $\gamma_{\text{Na}} + \gamma_{\text{Ca}} + \gamma_{\text{Mg}}$ usually equals the cation exchange capacity, CEC.

Hence Equation 15.1 can be written as

$$\frac{\frac{\gamma_{\text{Na}}}{\text{CEC}}}{\frac{\gamma_{\text{Ca}} + \gamma_{\text{Mg}}}{\text{CEC}}} = \frac{\text{ESP}}{100 - \text{ESP}} = K_G \cdot \text{SAR}$$

or

$$\text{ESP} = \frac{100 K_G \cdot \text{SAR}}{1 + K_G \cdot \text{SAR}} \quad (15.2)$$

For a range of soils in the west of the United States, the relation between the ESP of the soil and the SAR of the saturation extract is given as (Richards 1954)

$$\text{ESP} = \frac{100 (-0.0126 + 0.01475 \text{ SAR})}{1 + (-0.0126 + 0.01475 \text{ SAR})} \quad (15.3)$$

Because the determination of the ESP requires the analysis of the amount of sodium adsorbed on the soil complex and of the CEC, and because these analyses are rather time-consuming, the ESP is often calculated from the SAR. In the saturation extract, the concentrations of sodium, calcium, and magnesium can easily be determined and the SAR can then be calculated or read from the nomogram in Figure 15.2. For SAR values between 2 and 30, SAR and ESP are approximately equal under equilibrium conditions.

15.2.3 Effect of Sodium on Soil Physical Behaviour

As was mentioned in Section 15.2.2, the negative charge of the solid phase is counterbalanced by an equivalent amount of cations present in the adjacent liquid

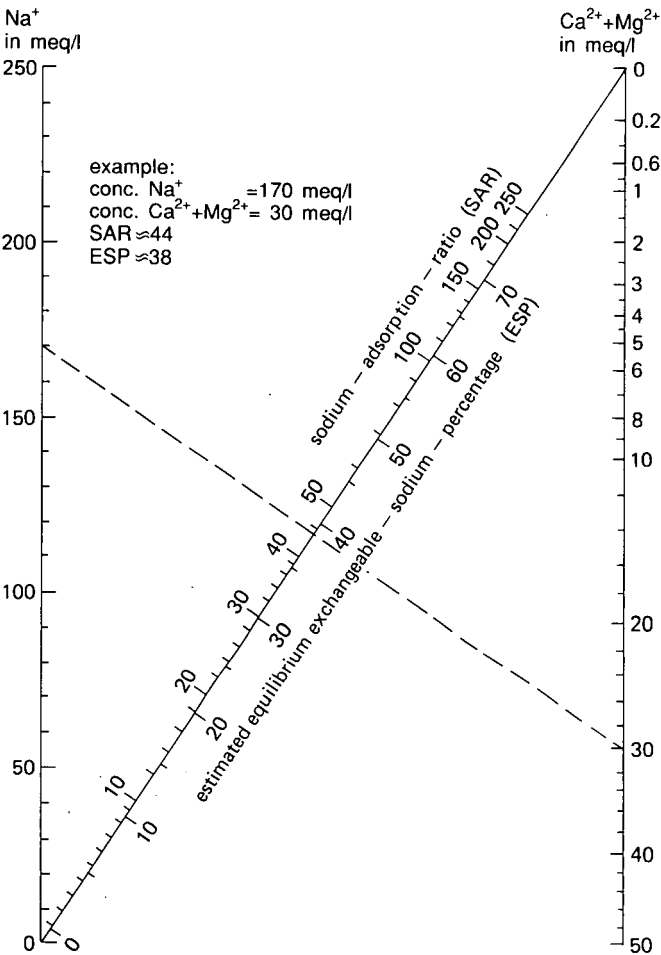

Figure 15.2 Nomogram for determining the SAR of the saturation extract and for estimating the corresponding ESP of the soil (after Richards 1954)

phase. The spatial distribution of negative and positive charges is in principle analogous to that of a plate condenser called 'electric double layer'. Unlike the plate condenser, the cations (or counterions) moving freely in the liquid phase are subject to two opposing tendencies:

- They are attracted towards the surface of the solid phase by the electric field;
- They tend to distribute themselves evenly throughout the liquid phase by diffusion.

The resulting distribution is that of a diffuse accumulation zone of cations known as the Diffuse Double Layer or DDL (Figure 15.3). In the DDL, cations are 'attracted' by the surface of the solid phase; at the same time, anions are being 'excluded'. At some distance from the surface of the solid phase, the concentrations of cations and anions are equivalent (the equilibrium solution).

Important factors determining the extent of the DDL are the valency of the counterion and the concentration of the equilibrium solution. Divalent cations (Ca^{2+}) are attracted by the surface of the solid phase more than monovalent cations (Na^+) are. Thus, by increasing the Ca/Na ratio of the soil-water system, the tendency is for a decrease in extent of the DDL, while decreasing this ratio will increase the extent of the DDL. Similarly, upon an increase in the salt concentration of the equilibrium solution (salinization), the DDL will decrease in thickness; upon dilution (leaching), the DDL expands.

The extent of the DDL has a pronounced effect on the soil physical behaviour. At some point within the DDL, the negative charge on the surface of the solid phase is not yet fully neutralized by counterions. Hence, one can state that if two clay particles approach within a distance of twice the extent of the DDL, they tend to separate. Clay particles, however, also attract mutually. At a pH of below 7, the edges of clay particles have a positive electrical charge. If the extent of the double layer is small, the positively charged edges may approach the negatively charged surface of a neighbouring clay particle, close enough to form weakly bonded floccules, similar to a 'card house' arrangement (Figure 15.4). The stability of these floccules is favoured by the presence of organic matter, lime, and gypsum.

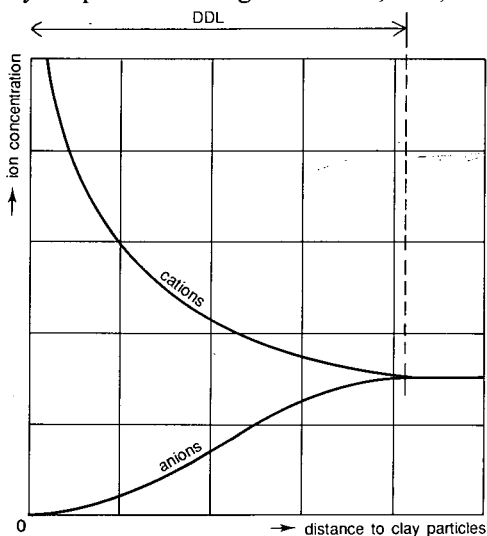

Figure 15.3 Distribution of cations and anions in diffuse double layer

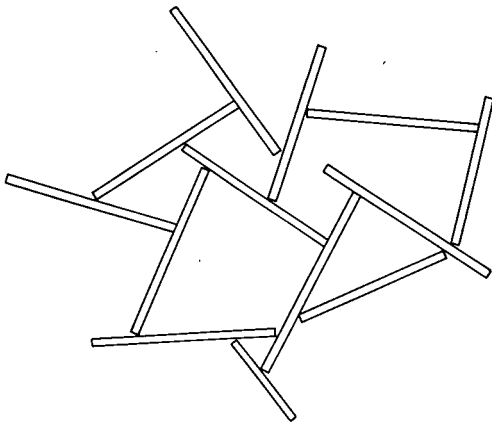

Figure 15.4 Card-house arrangement of clay particles

Provided the soil is sufficiently moist, say at field capacity, the DDL develops to its potential extent. Upon drying, the amount of soil water may fall below the one 'stored' in the DDL, particularly in the case of thick DDL's as found in sodic soils. Then the DDL is truncated. Upon rewetting, the DDL swells. For soils high in exchangeable calcium, this swelling is far less than for soils high in exchangeable sodium. The swelling causes the closure of the inter-aggregate pores, thus reducing the hydraulic conductivity. Moreover, the pressure arising from the swelling forces the individual clay particles away from each other. The soil disperses and soil aggregates fall apart. The fine soil particles loosened in this way clog the soil pores and further reduce the permeability for water and air. Rain or irrigation water will remain ponded on the soil surface for some time; upon drying, the dispersed and suspended clay particles will form a thin curled-up crust.

Salt-affected soils may show a good soil structure, even when they contain an appreciable amount of exchangeable sodium. Upon leaching, the salt content decreases and, at a high ESP, the DDL expands strongly and soil structure breaks down. Corrective measures to replace sodium by calcium then become necessary.

The adverse effect of exchangeable sodium on soil physical properties is well known. Not precisely known is at what exchangeable percentage sodium becomes detrimental to soil structure. An ESP of 10-15 is often presented as the critical level. In a sandy soil, an ESP of 25 may not show any effect on soil structure. In contrast, in clay soils, an ESP of 5 is already considered high, particularly in soils containing 2:1 clay minerals (e.g. smectite/montmorillonite).

After parts of The Netherlands were inundated with sea water in 1945 and 1953, experience showed that the critical amount of exchangeable sodium in clay soils could be put at 1.0-1.5 meq/100 g of soil, corresponding to an ESP of 4-8.

A high level of exchangeable sodium, combined with a low salinity, is a condition for a breakdown of soil structure, but what ultimately causes the soil structure to deteriorate is the mechanical impact on soils high in exchangeable sodium. This mechanical impact can be brought about by rain water or irrigation water, which causes the surface soil to slake and puddle. Upon drying, a hard crust is formed,

hampering seed emergence and crop growth. Soil-tillage practices like ploughing and harrowing may cause the formation of a compacted top layer with poor water-transmitting properties.

Subsoils showing a high ESP usually suffer less from a deterioration of soil structure. With increasing depth, the drying and wetting, and hence the shrinking and swelling, become less pronounced and the soil material remains beyond the reach of mechanical impacts.

15.2.4 Classification of Salt-Affected Soils

Salt-affected soils can be defined as soils that show:

- A concentration of soluble salts high enough to interfere with crop growth;
- Exchangeable sodium in a percentage high enough to affect the stability of the soil structure.

Various systems exist for the classification of salt-affected soils. Those of the US Salinity Laboratory, the U.S.S.R., FAO/Unesco, and Soil Taxonomy are presented below.

US Salinity Laboratory

The classification of salt-affected soils as presented by the US Salinity Laboratory (Richards 1954) is widely used. Developed principally for the purpose of reclaiming salt-affected soils, it is a simple system based on two criteria: the salinity of the soil, expressed as EC_e , and the exchangeable sodium percentage. Because of its simplicity, it cannot cope with all variations occurring in nature, and should not therefore be applied indiscriminately.

The system classifies salt-affected soils as follows:

- Saline soils, which have an $EC_e > 4$ dS/m at 25°C and an ESP < 15. The pH, in general, is below 8.5. The dominant anions are Cl^- and SO_4^{2-} . HCO_3^- is present in small quantities; NO_3^- is rarely found. Na^+ , as a rule, comprises less than 50% of the soluble cations. Calcium carbonate and gypsum may be present;
- Saline sodic soils, which have an $EC_e > 4$ dS/m at 25°C and an ESP > 15. The pH is seldom higher than 8.5. Often, saline sodic soils have a pH-value near to neutral. The Na^+ ions in the solution are present as neutral salts such as NaCl and Na_2SO_4 . If the pH-value is above 8.5, the ions HCO_3^- and CO_3^{2-} are present in the soil solution. Such saline sodic soils tend to be more problematic to reclaim;
- Non-saline sodic soils, which have an $EC_e < 4$ dS/m at 25°C and an ESP > 15. The pH is usually higher than 8.5; a pH of about 10 is no exception. Sodium is the main cation in the soil solution. The soil often contains $CaCO_3$, which, because of its low solubility, does not form a useful storage reservoir of calcium for reclamation purposes unless soil pH is lowered. The soil structure of non-saline sodic soils can often be regarded as poor. The topsoil of some non-saline sodic soils is devoid of calcium carbonate and shows a pH < 7. Accordingly, a higher quantity of exchangeable hydrogen is found adsorbed on the soil complex.

U.S.S.R. Nomenclature and Classification of Salt-Affected Soils

The U.S.S.R. classification system combines the principles of pedogenesis, the geochemistry of salts, and plant physiology. It distinguishes the following soils (after Kovda in FAO-Unesco 1973):

- Solonchak: These are saline soils containing a large quantity of easily soluble salts, usually more than 2%, in the top soil (the upper 0.3 m). The natural vegetation consists of specific succulent halophytes; sometimes the land is barren. Generally, agricultural crops do not yield. Various solonchaks have been differentiated according to the type of salts: puffy solonchak, which contain sodium sulphate; wet mineral solonchak (sabakh soils), which contain hygroscopic magnesium and calcium chloride; soda solonchak; chloride solonchak; and so on.

A subdivision is made according to the depth of occurrence of the watertable: there are active solonchaks with a watertable at shallow depth and residual solonchaks with a watertable at great depth;

- Solonchak-like soils: These are saline soils with a soluble salt content of between 0.5 and 1.5% (corresponding to an EC_e from 10-45 dS/m) in the rootzone to a depth of 1.0-1.5 m. Yields of agricultural crops are usually low.

A subdivision is made according to the dominant type of salts present and to the depth of the watertable. For instance, saline meadow soils have a watertable at shallow depth; residual solonchak-like soils have a watertable at great depth;

- Solonetz: These soils contain an appreciable amount of exchangeable sodium. As a result of the role of exchangeable sodium in soil formation, solonetz have a textural B horizon (i.e. a soil horizon marked by an illuviation of clay particles and showing a characteristic columnar soil structure).

A further subdivision is made according to the depth to the watertable, the profile development, and the presence of salts.

FAO-Unesco System

In the legend of the FAO-Unesco soil map of the world (FAO-Unesco 1974, FAO 1988), salt-affected soils are already distinguished at the highest level of soil classification: solonchaks and solonetz.

- Solonchaks are soils which, in addition to other characteristics, have a high salinity. A high salinity refers to soils which, at some time during the year, have an EC_e of 15 dS/m at 25°C or more at some depth within the profile: less than 1.25 m in coarse-textured soils to less than 0.75 m in fine-textured soils. A soil is also considered to be a solonchak if the EC_e is over 4 dS/m within a depth of 0.25 m and the pH (1:1) is over 8.5;
- Solonetz are soils with a natric B horizon. This is an argillic (clay illuviation) B horizon which has a columnar or prismatic structure and an exchangeable sodium percentage of more than 15%.

Soil Taxonomy

In Soil Taxonomy – the soil classification system developed by the US Soil Conservation Service (USDA 1975) – the specific features of salty land are only introduced in the 3rd category of classification (i.e. at the level of great groups). Salt-affected soils are found in the orders of Entisols, Inceptisols, Alfisols, Mollisols, and Aridisols. In Soil Taxonomy, the diagnostic features of salt-affected soils are:

- The presence of a natric horizon, which is a special kind of argillic horizon, with, in some subhorizon, a columnar soil structure or more than a 15% saturation with exchangeable sodium;
- The presence of a salic horizon, which is a horizon of 0.15 m or more thick and which contains a secondary enrichment of salts more soluble than gypsum. It contains at least 2% salt (i.e. the EC_e is usually more than 60 dS/m), and the product of its thickness in centimetres and salt percentage by weight is 60 or more.

15.2.5 Crop Growth affected by Salinity and Sodicity

The effect of salinity on crop growth can be ascribed to:

- An osmotic effect: As the salinity of a solution increases, its osmotic potential increases too and reduces the availability of water for the crop. This osmotic effect may explain why vegetable crops, which are known to prefer readily available soil water not exceeding a potential of 10^5 Pa ($= 1$ bar or $pF \approx 3.0$), are so sensitive to salinity;
- A specific ion effect: This causes an imbalanced ion uptake, deficiencies in certain elements, and yield depression. Some ions are toxic, causing characteristic injury symptoms associated with the accumulation of a specific ion in the plant. Leaf-burn of many fruit trees due to an excessive uptake of sodium and chloride are well known.

A crop's salt tolerance can be appraised by:

- The relative yield of the crop on a saline soil as compared with its yield on a normal, non-saline soil under comparable growing conditions. Because it provides a good basis of comparison between crops, this agronomic criterion is normally used to list the salt tolerance of crops;
- The absolute yield of a crop on a saline soil. Although the previous criterion allows a comparison of the salt tolerance of crops, in the final analysis the absolute yields of crops and their economic value are decisive for the choice of a crop rotation under saline conditions.

Literature contains many data on plant tolerance to salinity. In general, these tolerances agree fairly well, notwithstanding differences in climate, variety, and cultural practices. Climate has an effect on salt tolerance. Crops grown during a cooler period of the year are more tolerant than when growing during periods of higher temperature and lower humidity.

In literature from the U.S.S.R., plant tolerance is usually expressed in terms of salt content on a dry-weight basis. Also taken into account are the different types of salt present in the soil. More in vogue is to express plant salt tolerance in terms of the electrical conductivity of the saturation extract.

The relation between yield and salinity may be approached by a straight line for the important range of yield decrease from about 0.95 to 0.25. Figure 15.5 shows the relation between the relative yield and EC_e in dS/m for a large number of crops determined under field conditions in Tunisia. Here, the EC_e represents the average of spring and autumn samples taken from the rootzone between 0 and 0.80 m (Unesco

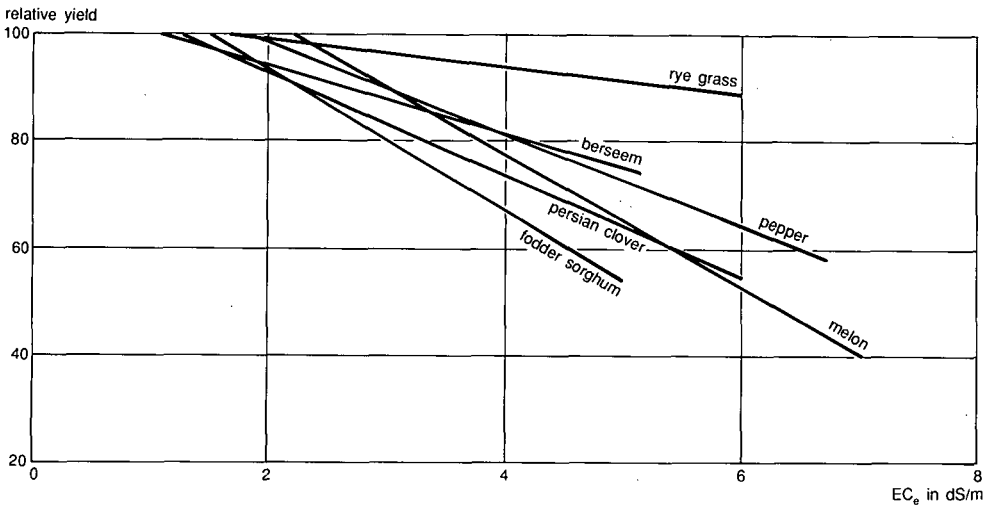
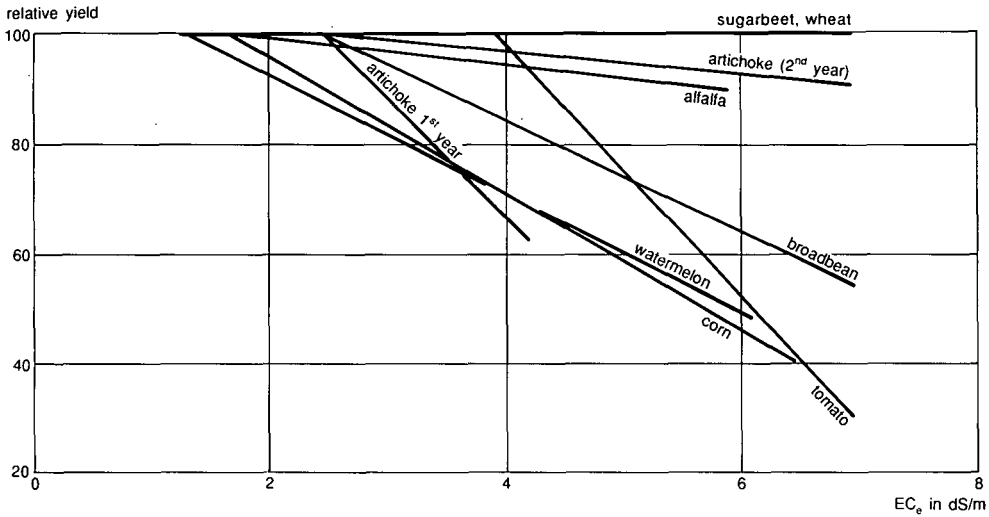

Figure 15.5 Relation between yield and soil salinity in soil layer 0-0.80 m (Unesco 1970)

1970). For many crops, the yield starts declining from an EC_e -value of 2 dS/m onwards, and already shows a depression of 20 to 25 per cent at an EC_e -value of 4 dS/m.

Table 15.2 presents the EC_e -values used for salinity classification. The values in this table and those in Figure 15.5 refer to medium and fine textured soils, for which EC_e equals about $0.5EC_c$ because of the relationship between the water contents at field capacity and in the saturated paste. Since, in the case of sand and loamy sand, EC_e equals about $0.25EC_c$, the limits of Table 15.2 at which crops are affected must be divided by two; otherwise the salinity of these soils will be underestimated.

Exchangeable sodium affects plant growth in two ways: it causes nutritional problems and poor soil structure. The soil solution of sodic soils often contains more

Table 15.2 Soil salinity classification

EC _e (dS/m)	Classification	Crop yields
0-2	Non-saline	Not affected
2-4	Slightly saline	Sensitive crops affected
4-8	Saline	Many crops affected
8-16	Strongly saline	Only tolerant crops possible
> 16	Extremely saline	A few very tolerant crops possible

sodium than calcium. The nutritional problems encountered on sodic soils are therefore related to an unbalanced uptake of cations. Plants grown on sodic soils usually have a higher sodium content and a lower calcium content than those grown on non-sodic soils. Some crops are extremely sensitive to sodium (*viz.* citrus and nut trees). In soils with an ESP of 5-10, these tree crops may accumulate toxic amounts of sodium. At that level of exchangeable sodium, a soil is not considered sodic (see Section 15.2.4). Most crops, however, are more tolerant to exchangeable sodium.

At an ESP-value of about 10, the second effect (*viz.* that of poor soil structure) may become apparent. With a breakdown of soil structure, plant growth is affected by poor aeration in the rootzone, together with reduced water movement and waterlogging in the rootzone or on the soil surface. The root growth is restricted. Upon the alternating effect of being moistened by irrigation water or rain and then drying, these soils form a dense and hard surface crust, which hinders the emergence of seeds and retards the development of young seedlings.

An exact ESP-value above which the soil structure is likely to deteriorate cannot be given. Too many factors determine soil structure or influence its stability. Thus, from a reclamation point of view, the critical ESP-level ranges from 5 in fine-textured soils that contain swelling clay minerals (e.g. smectite/montmorillonite) to 25 in coarse-textured soils.

15.3 Salt Balance of the Rootzone

15.3.1 Salt Equilibrium and Leaching Requirement

If we regard the rootzone as one layer with a homogeneous distribution of water and salt and consider a rather long period (e.g. one year), so that the water content is the same at the beginning and at the end of that period, we can write the water balance of an irrigated soil (Figure 15.6) as

$$I + P + G = E + R \quad (15.4)$$

where

- I = Irrigation (mm)
- P = precipitation (mm)
- G = capillary rise (mm)

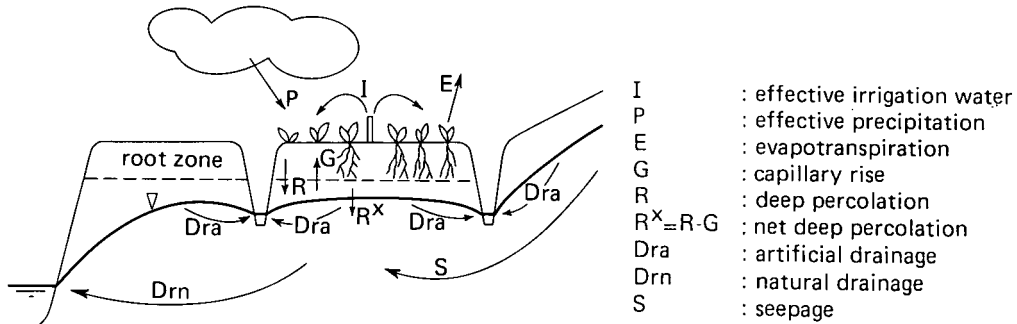

Figure 15.6 Components of the water balance of an irrigated soil

E = evapotranspiration (mm)
 R = percolation (mm)

The time period over which the balance components are taken is immaterial, as long as it is the same for each of the components. It is convenient to express all components in mm or $1/m^2$. I and P are defined here as effective quantities because they relate to quantities that actually infiltrate into the soil. For irrigation water, this is the supply to the field less surface runoff.

To obtain a salt balance, we make the following assumptions:

- All salts are highly soluble and do not precipitate;
- The amount of salts supplied by rainfall is negligible;
- The amounts of salts supplied by fertilizers and exported by crops are negligible.

In the case of salt equilibrium (i.e. without a long-term change in salt content), the salt balance of the rootzone then reads

$$IC_i + GC_g = RC_r \quad (15.5)$$

where

C = salt concentration (meq/l)
 i = suffix denoting irrigation water
 g = suffix denoting groundwater
 r = suffix denoting deep percolation water

By combining Equations 15.4 and 15.5, we get

$$R = \frac{(E - P)C_i + G(C_g - C_i)}{C_r - C_i} \quad (15.6)$$

Introducing $R^x = R - G$ for the net deep percolation, we obtain

$$R^x = (E - P) \frac{C_i}{C_r - C_i} + \frac{C_g - C_r}{C_r - C_i} \quad (15.7)$$

and

$$I = E - P + R^x \quad (15.8)$$

Equation 15.7 can be regarded as a basic equation in which no assumption has been made about the salt concentration of upward capillary flow.

If the groundwater in the area is fed by seepage from elsewhere, as is shown in the examples of Figure 15.7, the salt concentration of the capillary flow, C_g , will not be equal to the salt concentration of the percolation water, C_r . In such circumstances, we can use Equation 15.7 to calculate the amount of net deep percolation water, R^x , and afterwards use Equation 15.8 to obtain the amount of irrigation water, I . If there is no seepage, the percolation water will in the long run create a belt of water below the rootzone, the concentration of which corresponds to the average concentration of the percolation water. The salt concentration of the upward capillary flow will then be equal to the salt concentration of the percolation water: $C_g = C_r$. A certain amount of time must pass, however, before long-term equilibrium is established. Especially in newly reclaimed areas, the salt concentration below the rootzone, often increased by the salts washed down during leaching operations, may remain high for some time.

If all the irrigation water is mixing thoroughly with the soil water in the rootzone, the salt concentration of the soil water at field capacity will equal the salt concentration of the water percolating from the rootzone: $C_{fc} = C_r$.

We can simplify Equation 15.7 by making the following assumptions:

– No seepage, long-term equilibrium between the rootzone and the subsoil:

$$C_g = C_r;$$

– All irrigation water mixes with the soil water in the rootzone at field capacity:

$$C_{fc} = C_r.$$

Under these conditions, Equation 15.7 changes to

$$R^x = (E - P) \frac{C_i}{C_{fc} - C_i} \quad (15.9)$$

Combining Equations 15.8 and 15.9 yields

$$I = (E - P) \frac{C_{fc}}{C_{fc} - C_i} \quad (15.10)$$

With Equation 15.9, we can calculate the amount of leaching water needed to maintain salt equilibrium, and, with Equation 15.10, the total amount of irrigation water needed to cover both the consumptive use of the crop and the leaching of the soil. In these equations, $(E - P)$ represents the influence of climate on the amount of irrigation water needed, C_i the influence of water quality, and C_{fc} the agronomic criterion which takes into account the influence of salinity on crop yield.

Combining Equations 15.9 and 15.10 yields the leaching fraction, LF

$$LF = \frac{R^x}{I} = \frac{C_i}{C_{fc}} \quad (15.11)$$

If C_{fc} is chosen according to the salt tolerance of the crops to be grown, the amount of net deep percolation water calculated with Equation 15.9 and the fraction of irrigation water calculated with Equation 15.11 both express the leaching requirement. In literature (Richards 1954), the leaching requirement is defined as the fraction of the irrigation water that must be leached through the rootzone to control soil salinity

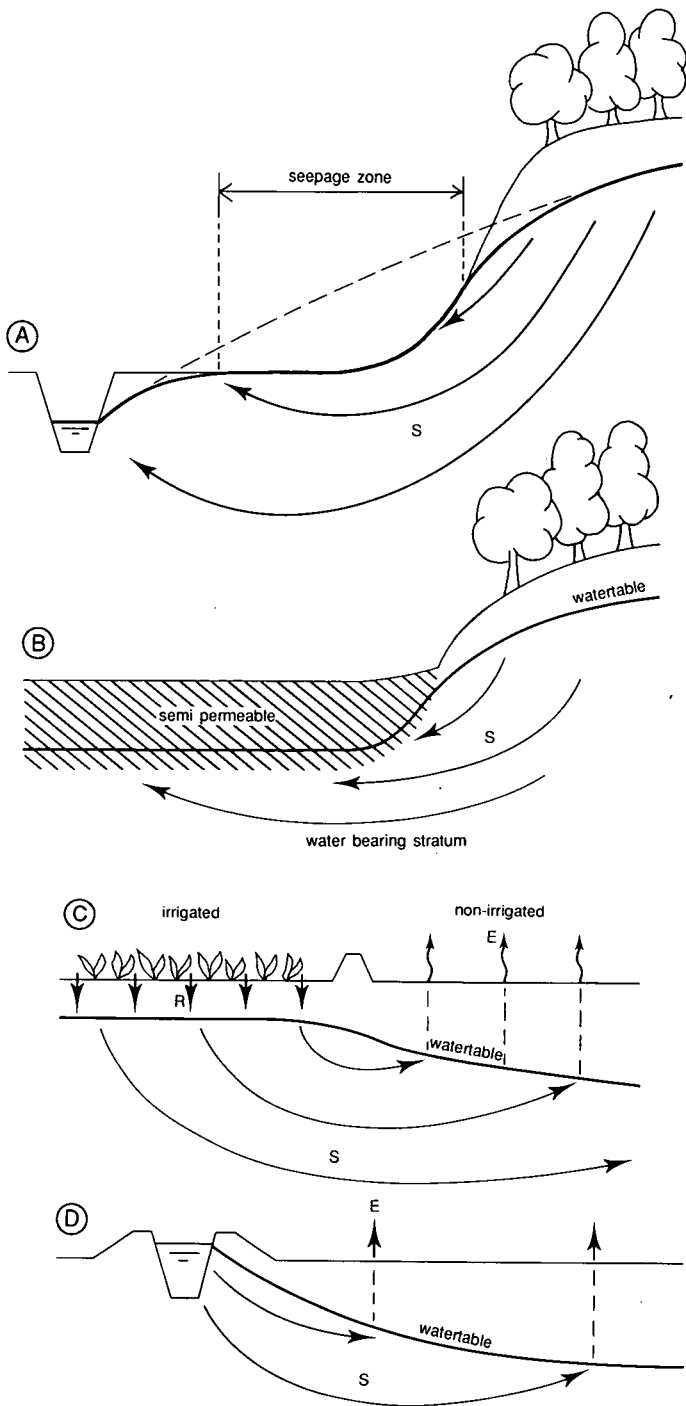

Figure 15.7 Examples of seepage flow: A) Seepage at the foot of a hill; B) Seepage into a valley; C) Seepage from an irrigated field towards fallow land; and D) Seepage from an irrigation canal

at any specified level. We must always express the leaching requirement as a fraction in order to check whether the fraction is not too high compared with the fraction for consumptive use and in view of the permeability of the soil. If the leaching requirement is too high, we must choose a higher value of C_{fc} ; in practice, that means a shift towards more salt-tolerant crops.

If the leaching fraction equals 0.25, the net percolation equals 1/4 of the amount of irrigation water, and the soil water becomes four times as concentrated as the irrigation water. We can express this relation by introducing the concentration factor, n , which equals the inversed value of the leaching fraction

$$n = \frac{1}{LF} = \frac{C_{fc}}{C_i} \quad (15.12)$$

15.3.2 Salt Storage

In the preceding section, we assumed that there was no difference between the amount of salts stored in the rootzone at the beginning and at the end of the period under consideration. Though this may be true for long periods – say one year – the amounts will change within such a period because of seasonal variations in climate, crops, water applications, and water quality. Such short-term changes in salt content – say over a month or a season – can be calculated with the salt storage equation, which will be derived in this section.

If the quantity of salts in the rootzone, Z' , at the beginning of the period (Z'_1) differs from that at the end (Z'_2), we can write

$$\Delta Z' = Z'_2 - Z'_1 \quad (15.13)$$

where

$$\begin{aligned} \Delta Z' &= \text{change in salt quantity in the rootzone (meq/m}^2\text{)} \\ Z'_2 &= \text{salt quantity in the rootzone at the end of the period (meq/m}^2\text{)} \\ Z'_1 &= \text{salt quantity in the rootzone at the begin of the period (meq/m}^2\text{)} \end{aligned}$$

We can regard the amount of salt in the rootzone (Z') as being dissolved in the soil water. Because the downward movements of water and salt generally take place at water contents near field capacity, we can logically consider Z' to be dissolved in an amount of water W_{fc} , which is the amount of soil water at field capacity in the rootzone expressed in mm or l/m². W_{fc} can be determined from

$$W_{fc} = \theta_{fc} D \quad (15.14)$$

where

$$\begin{aligned} W &= \text{water content of the rootzone (mm)} \\ \theta &= \text{volumetric soil water content (-)} \\ D &= \text{depth of the rootzone (mm)} \end{aligned}$$

At field capacity, the salt concentration (C_{fc}) of the soil water in the rootzone is

$$C_{fc} = \frac{Z'}{W_{fc}} \quad (15.15)$$

If we consider a period in which Z' changes from Z'_1 to Z'_2 , the average salt concentration (\bar{C}_{fc}) of the soil water at field capacity during that period is

$$\bar{C}_{fc} = \frac{Z'_1 + Z'_2}{2W_{fc}} = \frac{Z'_1}{W_{fc}} + \frac{\Delta Z'}{2W_{fc}} \quad (15.16)$$

Assuming $C_g = C_r = C_{fc}$, we can write for the change in salt content of the rootzone

$$\Delta Z' = IC_i - R^x \bar{C}_{fc} \quad (15.17)$$

Substituting the expression of Equation 15.16 for \bar{C}_{fc} into Equation 15.17 yields

$$\Delta Z' = \frac{IC_i - \frac{R^x Z'_1}{W_{fc}}}{1 + \frac{R^x}{2W_{fc}}} \quad (15.18)$$

Equation 15.18 is the salt storage equation. If we know the initial salt content of the rootzone, Z'_1 , (e.g. from soil sampling), we can calculate $\Delta Z'$ directly. Equation 15.18 can then be used to predict the desalinization of saline soils under the influence of irrigation water. If, however, we are interested in finding the seasonal deviations from the long-term equilibrium soil salt content, Z' will not be known, and the only condition is that the sum of the quantities $\Delta Z'$ should be zero over a long period. The procedure will be illustrated with an example (Example 15.1) in Section 15.3.4.

15.3.3 The Salt Equilibrium and Storage Equations expressed in terms of Electrical Conductivity

Hitherto, we have expressed the salinity of the water as the salt concentration (C) in meq/l. C may stand either for the total salt concentration or for the concentration of a specific ion (e.g. chloride, sodium, boron). As already outlined in Section 15.2.1, the electrical conductivity is roughly proportional to the salt concentration and can be obtained in dS/m by dividing the salt concentration in meq/l by a value of about 12. Since, for most soils – sand and loamy sand excepted – the water content of the saturated paste is about twice that of field capacity, EC_c equals $0.5EC_{fc}$ if highly soluble salts only and no solid lime or gypsum are present in the soil. Hence we can write

$$EC_c = 0.5EC_{fc} = \frac{C_{fc}}{24} = \frac{Z'}{24W_{fc}} \quad (15.19)$$

where EC is expressed in dS/m, C in meq/l, Z' in meq/m², and W in mm. If the calculations are done with EC instead of C -values, the symbols Z and ΔZ are used instead of Z' and $\Delta Z'$.

$$Z = \frac{Z'}{12} \text{ and } \Delta Z = \frac{\Delta Z'}{12} \quad (15.20)$$

in which Z' and $\Delta Z'$ are expressed in meq/m² and Z and ΔZ as the product of dS/m and mm. For the sake of convenience, we shall henceforth write EC_{mm} instead of

the physically correct notation (dS/m)mm. Equations 15.9, 15.10, 15.11, and 15.18, when expressed in terms of electrical conductivity, change into

$$R^x = (E - P) \frac{EC_i}{2EC_e - EC_i} \quad (15.21)$$

$$I = (E - P) \frac{2EC_e}{2EC_e - EC_i} \quad (15.22)$$

$$LF = \frac{R^x}{I} = \frac{EC_i}{2EC_e} \quad (15.23)$$

$$\Delta Z = \frac{IEC_i - \frac{R^x Z_i}{W_{fc}}}{1 + \frac{R^x}{2W_{fc}}} \quad (15.24)$$

If we express the amounts of irrigation water etc., in mm, we obtain Z and ΔZ in ECmm. Inversely, we find the electrical conductivity of the soil water at field capacity and that of the saturation extract from

$$EC_{fc} = \frac{Z}{W_{fc}} \text{ and } EC_e = \frac{Z}{2W_{fc}} \quad (15.25)$$

in which Z is expressed in ECmm and W_{fc} in mm.

15.3.4 Example of Calculation

Table 15.3 presents an example of the application of the salt equilibrium and storage equations to permanently irrigated soils. This table contains three parts:

- I Basic information;
- II Maximum percolation in summer;
- III Maximum percolation in autumn.

Example 15.1

Part I: Basic Information

The basic information supplied and the assumptions to be made in advance are given in Part I of the table, Lines 1 to 7. These concern:

- The soil: the amount of water in the rootzone at field capacity, the relation between EC_e and EC_{fc} ;
- The agronomic conditions: the agronomic criterion (in this case an average EC_e value of 6 dS/m and a maximum value of 8 dS/m) and the land use;
- The climate: evapotranspiration and precipitation;
- The quality of the irrigation water.

A considerable variation is apparent in the salinity of the irrigation water (Line 7), but its quality is generally poor, especially in summer and autumn. As the amount of irrigation water varies in general with the deficit (E - P), the weighted mean \bar{EC}_i

Table 15.3 Salt and water balance for a permanently cropped soil, all salts remaining in solution (Example 15.1)

Part I		Basic Information													
1	General data: $W_{fc} = 300$ mm; $EC_e = 0.5 EC_{fc}$; $\overline{EC}_e = 6$ dS/m; $EC_{max} = 8$ dS/m; no capillary rise														
2	Period		Year	Oct.	Nov.	Dec.	Jan.	Febr.	March	April	May	June	July	Aug.	Sept.
3	Land use		•	Irrigated fodder crops											
4	E	mm	1300	90	60	60	60	75	90	105	120	150	170	170	150
5	P	mm	400	50	60	70	70	50	40	30	30	0	0	0	0
6	E-P	mm	900	40	0	-10	-10	25	50	75	90	150	170	170	150
7	EC_i	mm	3.0	3	2	2	1	2	2	2	2	3	3	4	3
Part II		Distribution of irrigation water with maximum percolation in summer													
8	I	mm	1200	60	0	0	0	0	90	90	120	180	240	240	180
9	ΔW	mm	0	0	0	0	0	-25	+25	0	0	0	0	0	0
10	R^x	mm	300	20	0	10	10	0	15	15	30	30	70	70	30
11a	Z_1	ECmm		<u>5000</u>	4852	4852	4693	4539	4539	4493	4449	4254	4364	4097	4101
12a	ΔZ	ECmm	-775	-148	0	-159	-154	0	-46	-44	-195	+110	-267	+4	+124
13a	Z_2	ECmm		4852	4852	4693	4539	4539	4493	4449	4254	4364	4097	4101	<u>4225</u>
11b	Z_1	ECmm		<u>3000</u>	2981	2981	2884	2789	2789	2829	2867	2822	3068	3072	3290
12b	ΔZ	ECmm	+491	-19	0	-97	-95	0	+40	+38	-45	+246	+4	+218	+201
13b	Z_2	ECmm		2981	2981	2884	2789	2789	2829	2867	2822	3068	3072	3290	<u>3491</u>
11c	Z_1	ECmm		<u>3780</u>	3710	3710	3588	3470	3470	3476	3482	3379	3571	3470	3604
12c	ΔZ	ECmm	-5	-70	0	-122	-118	0	+6	+6	-103	+192	-101	+134	+171
13c	Z_2	ECmm		3710	3710	3588	3470	3470	3476	3482	3379	3571	3470	3604	<u>3775</u>
14	EC_e	dS/m	5.9	6.3	6.2	6.2	6.0	5.8	5.8	5.8	5.8	5.6	6.0	5.8	6.0

Table 15.3 (cont.)

Part III		Distribution of irrigation water with maximum percolation in autumn													
15	I	mm	1200	90	50	0	0	0	90	90	120	180	200	200	180
16	ΔW	mm	0	0	0	0	0	-25	+25	0	0	0	0	0	0
17	R^x	mm	300	50	50	10	10	0	15	15	30	30	30	30	30
18a	Z_1	ECmm		<u>5000</u>	4480	3883	3756	3633	3633	3631	3629	3512	3629	3912	4301
19a	ΔZ	ECmm	-594	-520	-597	-127	-123	0	-2	-2	-117	+180	+220	+289	+105
20a	Z_2	ECmm		4480	3883	3756	3633	3633	3631	3629	3512	3692	3912	4301	<u>4406</u>
18b	Z_1	ECmm		<u>3000</u>	2778	2451	2371	2293	2293	2356	2416	2414	2699	3013	3486
19b	ΔZ	ECmm	+668	-212	-337	-80	-78	0	+63	+60	-2	+285	+314	+475	+182
20b	Z_2	ECmm		2788	2451	2371	2293	2293	2356	2416	2414	2699	3013	3486	<u>3668</u>
18c	Z_1	ECmm		<u>4065</u>	3689	3214	3109	3007	3007	3036	3063	3000	3229	3493	3923
19c	ΔZ	ECmm	-1	-376	-475	-105	-102	0	+29	+27	-63	+229	+264	+430	+141
20c	Z_2	ECmm		3689	3214	3109	3007	3007	3036	3063	3000	3229	3493	3923	4064
21	EC_e	dS/m	5.5	6.8	6.1	5.4	5.2	5.0	5.0	5.1	5.1	5.0	5.4	5.8	6.5

will be taken as the annual average electrical conductivity of the irrigation water

$$\overline{EC}_i = \frac{\sum EC_i(E - P)}{\sum(E - P)} = 3.0 \text{ dS/m}$$

The first step consists of using the salt equilibrium equation to calculate the total amounts of irrigation water and percolation water. Using Equations 15.22 and 15.21, we find $I = 1200 \text{ mm}$ and $R^s = 300 \text{ mm}$ (Lines 8 and 10). The leaching fraction equals 25% of the amount of irrigation water and less than 20% of the total amount of irrigation water and rainfall. Because these values are not excessive from a practical point of view, we need not change the agronomic criterion to obtain a lower leaching requirement.

The second step consists of using the salt storage equation to calculate the changes in salinity during the year. In this way, we find out whether leaching can be postponed from a period of peak consumptive use until a period of low consumptive use. Parts II and III show two possibilities of distributing the irrigation water over the year, both following the trend of the deficit $(E - P)$ but differing in the amount of surplus water.

Part II Maximum Percolation in Summer

The net deep percolation is maximum in summer when the irrigation applications themselves are highest. No irrigation water is applied during late autumn and winter. The monthly changes in water content of the rootzone (ΔW) are zero (Line 9), except for the month of February, when evapotranspiration exceeds the rainfall by 25 mm – a deficit that is restored in March. The monthly net percolation (Line 10) is calculated as $R^s = I - (E - P) - \Delta W$. To calculate the monthly change ΔZ , we have to estimate the salt content Z_1 of the rootzone. We do this by applying the following reasoning. The average value of the electrical conductivity of the saturated extract (\overline{EC}_e) should not exceed 6 dS/m (agronomic condition); hence $\overline{EC}_e = 12 \text{ dS/m}$ (Equation 15.25) and consequently the average value $= \bar{Z} = \overline{EC}_e W_{fc} = 12 \times 300 = 3600 \text{ ECmm}$. As we have chosen the month of October, at the beginning of the rainy season, to start the calculation (in principle it could start in any arbitrary month), we can take the initial value Z_1 higher than \bar{Z} : 5000 ECmm (Line 11a). With this value, we find the change in salt storage (ΔZ) over October to be 148 (Line 12a). The salt storage at the end of October (Z_2 , Line 13a) is therefore $5000 - 148 = 4852$. We then regard this value as the initial storage (Z_1) in November (Line 11a). Continuing the calculations in this way, we find that next year at the end of September, Z_2 is 4225 ($\Sigma\Delta Z = -775$). This value does not agree with the starting value Z_1 of 5000 for October, which has apparently been chosen too high. Starting again, with a Z_1 value of 3000 (Line 11b), we obtain $Z_2 = 3491$ (Line 13b) in September and $\Sigma\Delta Z = +491$. Obviously, the value of 3000 is too low. Linear interpolation (Figure 15.8) between the two pairs of values (5000, -775) and (3000, +491) yields (3780, 0). Checking the value $Z_1 = 3780$ (October, Line 11c) by repeating the salt storage calculations yields $Z_2 = 3775$ (September, Line 13c), which is sufficiently close to the starting value and satisfies the condition that the sum of the quantities ΔZ should be zero over a long period (Section 15.3.2).

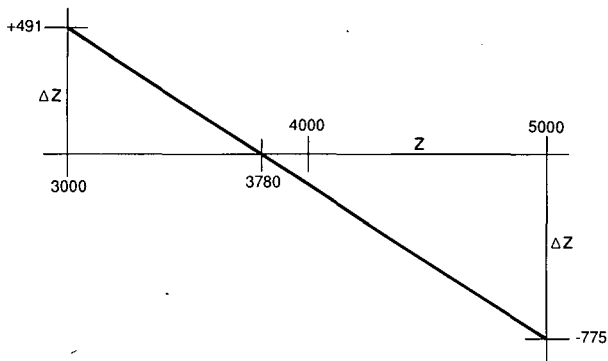

Figure 15.8 Linear interpolation to find the best estimate of the initial salt content of the rootzone, Z_1

The electrical conductivity of the saturation extract, EC_e , calculated according to Equation 15.25, varies between 6.3 and 5.6 dS/m, values which are lower than the maximum permissible value of 8 dS/m. The average \overline{EC}_e is 5.9 dS/m, slightly lower than the permissible value of 6.

Part III: Maximum Percolation in Autumn

The net deep percolation is maximum in autumn so as to decrease the peak demand in summer, on both the irrigation and the drainage system. The variation in the EC_e -value, between 6.8 and 5.0 dS/m, is greater than in the previous case, but the EC_e never exceeds the maximum permissible value of 8. The average \overline{EC}_e is 5.5 dS/m, lower than in Part II, because the salt input from the irrigation water is slightly lower (90 ECmm, which means a difference of 0.15 dS/m in EC_e) and most of the leaching occurs in autumn, decreasing the EC_e -value well below 6 dS/m. This example shows how we can use the salt equilibrium equation to calculate the leaching requirement (i.e. the minimum amount of leaching water needed to maintain long-term salt equilibrium). It also shows how the salt storage equation can be used to calculate the monthly variation in EC_e . In this way, we can also check whether we can reduce the irrigation applications during the period of peak demand to a level equal to the consumptive use without creating a temporarily harmful salinity level. When irrigation water is scarce in summer, water must be saved.

Figure 15.9 illustrates the principle of long-term salt equilibrium differing according to the salt tolerance of the crops, and short-term salt fluctuation.

Figure 15.10 shows an example of long-term salt development towards equilibrium from autumn 1965 onwards, as well as of short-term salt fluctuation. This irrigation test, which was conducted at the Cherfech experimental station in Tunisia, comprised three rates of water application, kept respectively at 75% (I_1), 100% (I_2), and 125% (I_3) of the consumptive use, which ranged around 7 mm/d in summer. This means that the water application I_1 stands for water saving and I_3 for frequent leaching. During the first two months after the crop had been sown, when consumptive use was low, the water applications were the same and corresponded to the amount of water needed to cover the field. As this amount then exceeded the consumptive use, leaching occurred with each application at the start of the growing season and also

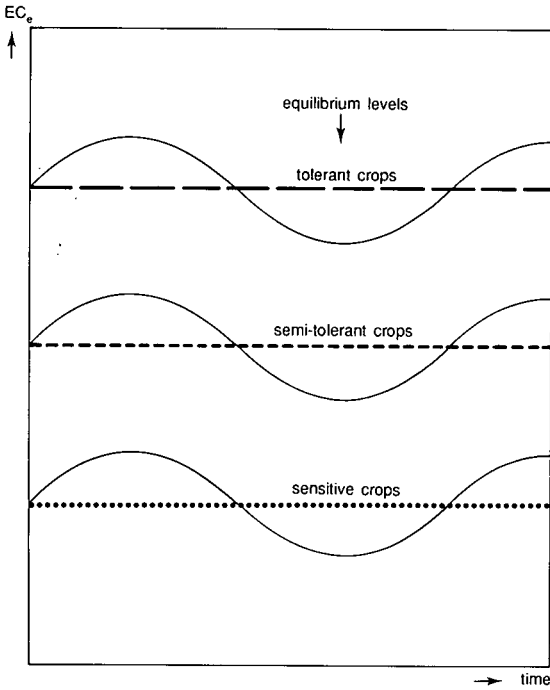

Figure 15.9 Long-term salt equilibrium at different levels and short-term salt fluctuation

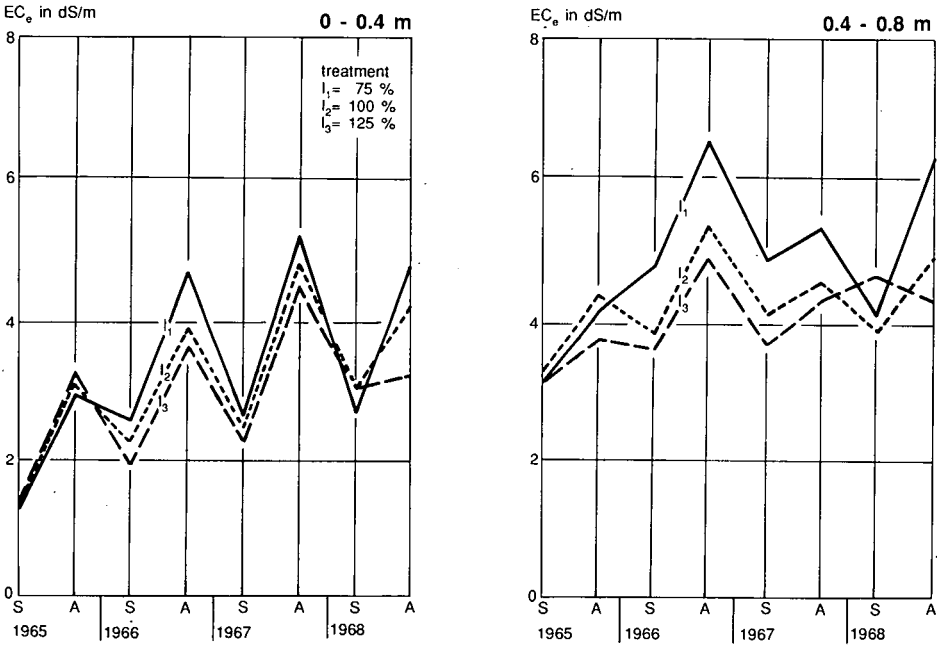

Figure 15.10 Irrigation test showing long-term development towards equilibrium and seasonal salt fluctuation for three rates of water application (S = spring; A = autumn)

during winter owing to a combination of rainfall and irrigation. The aim of the test was to remain as close as possible to practice and to investigate whether frequent leaching in the period of peak demand was necessary or whether water saving in that period could be permitted. Although the rates of water application had an effect on soil salinity, the differences were small, not justifying frequent leaching in summer. The seasonal variation, due to leaching in winter, was more important than the differences due to the applications. Frequent leaching in periods of peak consumptive use means that not only are greater amounts of water being applied but also that greater amounts of salts are brought into the soil. So this surplus amount of salt counterbalances to a certain extent the advantage of more leaching.

Field irrigation losses, which provide leaching, are seldom evenly distributed over the field. In part of the field, the losses may be in excess of the leaching requirement, whereas in other parts the reverse may be true. If, however, the losses are considerably higher than the leaching requirement, no extra volume of irrigation water need be added for leaching.

15.3.5 Effect of Slightly Soluble Salts on the Salt Balance

In the preceding sections, we assumed that all salts are highly soluble and that they remain in solution. We shall now consider the situation in which some of the salts are slightly soluble and that they precipitate.

Salts that precipitate at concentrations too high for crop growth are considered highly soluble: all chlorides, the sulphates of sodium and magnesium, and sodium bicarbonate. Their solubility at a temperature of 20°C exceeds 100 meq/l. Gypsum and calcium carbonate, of which the saturation concentrations never reach levels intolerable for crop growth, are defined as slightly soluble salts.

In complex solutions, which generally occur in soils, the solubility of most salts changes. In mixtures of salts with dissimilar ions, the solubility of the component with the lower solubility increases. Table 15.4A shows that the solubility of calcium carbonate (lime) increases with the concentration of dissimilar ions and with the carbon dioxide pressure of the soil air. For average soil conditions, the solubility of calcium carbonate can be set roughly between 5 and 10 meq/l, which contributes approximately 0.8 dS/m to the EC of the soil water.

Table 15.4B shows that the solubility of gypsum depends on the presence of the other salts. As a rule, the presence in a solution of salts with a common ion causes the solubility of these salts to drop (e.g. the solubility of gypsum in the presence of

Table 15.4A Solubility of lime (CaCO_3) in meq/l, depending on carbon dioxide pressure and total concentration of dissimilar ions

Total concentration of dissimilar ions	P-CO ₂ (Pa)				
	50	100	500	1000	5000
10 meq/l	1.5	1.9	3.3	4.1	7.0
100 meq/l	2.0	2.6	4.4	5.5	9.2

Table 15.4B Solubility of gypsum ($\text{CaSO}_4 \cdot 2\text{H}_2\text{O}$) in meq/l in pure water and in different solutions

Pure water	170 meq/l NaCl	1700 meq/l NaCl	140 meq/l Na_2SO_4	180 meq/l CaCl_2
30	49	98	22	17

Na_2SO_4 or CaCl_2). The solubility of gypsum increases in the presence of dissimilar ions (e.g. in a solution of NaCl). Under average conditions, the solubility gypsum can be put at 30 meq/l. If gypsum is present in the soil, calcium carbonate is also generally present. Their concentration equals approximately 40 meq/l, which corresponds to an EC of 3.3 dS/m.

If one or both slightly soluble salts are present in the solid state, their contribution will be constant and will be equal to their saturation concentration: for calcium carbonate alone, corresponding with an EC of about 0.8 dS/m, and for calcium carbonate and gypsum together, corresponding with an EC of approximately 3.3 dS/m. Therefore the simplest way to make adjustments in the salt equilibrium and storage equations is to consider the highly and slightly soluble salts separately. If calcium carbonate is present in the soil, Equation 15.19 changes into

$$EC_e = EC_{e(\text{CaCO}_3)} + EC_{e(\text{highly soluble salts})} = 0.8 + 0.5EC_{fc(\text{h.s.s.})} \quad (15.26)$$

Similarly, if both calcium carbonate and gypsum are present in the soil, Equation 15.19 changes into

$$EC_e = EC_{e(\text{CaCO}_3 + \text{CaSO}_4 \cdot 2\text{H}_2\text{O})} + EC_{e(\text{h.s.s.})} = 3.3 + 0.5EC_{fc(\text{h.s.s.})} \quad (15.27)$$

It should be noted that, because the solubility of the slightly soluble salts is rather variable, Equations 15.26 and 15.27 are approximations for practical use. Equations 15.21, 15.22, 15.23, and 15.24 can be applied in the normal way for the highly soluble salts, after which the corrections for the slightly soluble salts can be introduced. How this is done will be explained with Example 15.2.

Example 15.2

Table 15.5 presents the monthly salt and water balance of a soil irrigated with water in which gypsum predominates. The high values of Ca and SO_4 (Line 2) indicate that the water is nearly saturated with gypsum, which will precipitate as soon as the irrigation water changes into more concentrated soil water.

Remaining in solution are all chlorides (3 meq/l) and all bicarbonates and sulphates not bound to Ca, estimated at 8 meq/l (i.e. $\text{HCO}_3 + \text{SO}_4 - \text{Ca}$). The total concentration of highly soluble salts in the irrigation water is therefore 11 meq/l, with a corresponding $EC_{i(\text{h.s.s.})}$ of $11/12 = 0.9$ dS/m. We now use this value to calculate the total amounts of irrigation and percolation water with Equations 15.22 and 15.21. Then, for the irrigation water, we choose a distribution that follows the trend of the deficit ($E - P$). We now calculate ΔW and R^x for each month in the same way as in Example 15.1 (Table 15.3). We use Equation 15.24 to calculate the monthly salt storage for the highly soluble salts (Line 10). Next, Equation 15.25 determines the EC_e of the highly soluble salts at the beginning of each month (Line 12). We add the

Table 15.5 Irrigation with water in which gypsum predominates (Example 15.2)

1	General data: $W_{fc} = 300$ m; $\overline{EC}_e = 0.5$ dS/m; EC_{fc} (h.s.s.)* = 2.7 dS/m; \overline{EC}_i (h.s.s.) = 0.9 dS/m; $EC_i = 3.5$ dS/m														
2	Ions in irr. water	Na	Mg	Ca	Total cations	HCO ₃	Cl	SO ₄	Total anions						
	mg/l	72	96	608	--	182	101	1660	--						
	meq/l	3	8	30	41	3	3	35	41						
3	Period	Year	Oct.	Nov.	Dec.	Jan.	Febr.	March	April	May	June	July	Aug.	Sept.	
4	Land use	Irrigated fodder crops													
5	E-P	mm	900	40	0	-10	-10	25	50	75	90	150	170	170	150
6	I	mm	1080	60	0	0	0	0	90	90	120	160	200	200	160
7	ΔW	mm	0	0	0	0	0	-25	+25	0	0	0	0	0	0
8	R [*]	mm	180	20	0	10	10	0	15	15	30	10	30	30	10
9	Z ₁ (h.s.s.)	ECmm		1740	1680	1680	1625	1572	1572	1574	1576	1529	1620	1637	1652
10	ΔZ (h.s.s.)	ECmm	0	-60	0	-55	-53	0	+2	+2	-47	+91	+17	+15	+88
11	Z ₂ (h.s.s.)	ECmm		1680	1680	1625	1572	1572	1574	1576	1529	1620	1637	1652	1740
12	EC _e (h.s.s.)	dS/m	2.7	2.9	2.8	2.8	2.7	2.6	2.6	2.6	2.6	2.5	2.7	2.7	2.7
13	EC _e (gypsum)	dS/m	3.3	3.3	3.3	3.3	3.3	3.3	3.3	3.3	3.3	3.3	3.3	3.3	3.3
14	EC _e (total)	dS/m	6.0	6.2	6.1	6.1	6.0	5.9	5.9	5.9	5.9	5.8	6.0	6.0	6.0

* h.s.s. = highly soluble salts

conductivity of a saturated solution of calcium carbonate and gypsum (3.3 dS/m) to the EC_e(h.s.s.) to obtain the total EC_e (Line 14).

If we had calculated the amount of irrigation water without making a distinction between highly and slightly soluble salts, we would have found from Equation 15.22, for EC_e = 6 dS/m and EC_i = 3.4 dS/m, a value for I of 1255 mm instead of 1080 mm and for R^{*} 355 mm instead of 180 mm, which is twice the real leaching requirement. In the first case, the leaching fraction equals 0.28; in the second case 0.17.

It can be seen from the balance sheet (Table 15.5) that calcium precipitates in the soil in the following way. The calcium supply to the rootzone equals the product of irrigation supply, I, and its calcium concentration (1080 l/m² × 30 meq/l = 32400 meq/m²). The removal of calcium is at most equal to the product of leaching water and its saturated concentration of calcium carbonate and gypsum (180 l/m² and 40 meq/l = 7200 meq/m²). The difference between calcium supply and removal (25200 meq/m²) represents the precipitation of calcium in the soil. As this will occur mainly in the form of gypsum (equivalent mass of CaSO₄·2H₂O = 86 mg/meq), it is estimated that 25200 × 86/10⁶ = 2.2 kg of gypsum is precipitated per m² of soil, or 22 ton/ha. This precipitate is harmless to plant and soil. Soils irrigated with water containing gypsum will become enriched in gypsum and calcium carbonate and, after centuries of use, may even largely consist of such precipitates.

15.4 Salinization due to Capillary Rise

15.4.1 Capillary Rise

In irrigated areas, during intervals in irrigation or during fallow periods when there is no downward flow of percolation water, water can move upward by capillary forces.

The water will be taken up by the roots or evaporate at the surface and salt will accumulate in the rootzone or in the top layer.

The capillary upward flux varies with soil type, depth of watertable, and soil water gradient. Figure 15.11 presents the relation between capillary flow velocity and depth of watertable for three soil types. The figure was derived from data published by Rijtema (1969), who assumed a stable watertable and a gradual increase of the suction from zero at the groundwater level to a value of 16×10^5 Pa or 16 bar ($pF = 4.2$) at the soil surface, a value corresponding with a soil water content at wilting point. If the watertable remains at a constant level as a result of seepage inflow, the capillary rise will be considerable (e.g. 180 mm for a period of 6 months, which is 1 mm/d if the watertable remains at a depth of 1 m for a clay loam, at 1.95 m for a loam, and at 2.85 m for a silt loam). These values show that a higher silt content leads to more capillary rise.

If the groundwater is not fed by seepage, the capillary flow will cause the watertable to fall. The lower watertable will cause the capillary flow to decrease because of a decrease in the capillary conductivity. The end result will be that the watertable will have fallen to a depth where the capillary flow velocity approaches a zero value. Figure 15.12 gives an example of the moisture depletion of the soil by capillary flow in the case of a falling watertable, showing that only a small part of the water is provided by the soil profile below the initial watertable.

For the three soils presented in Figure 15.11, the fall of the watertable and the

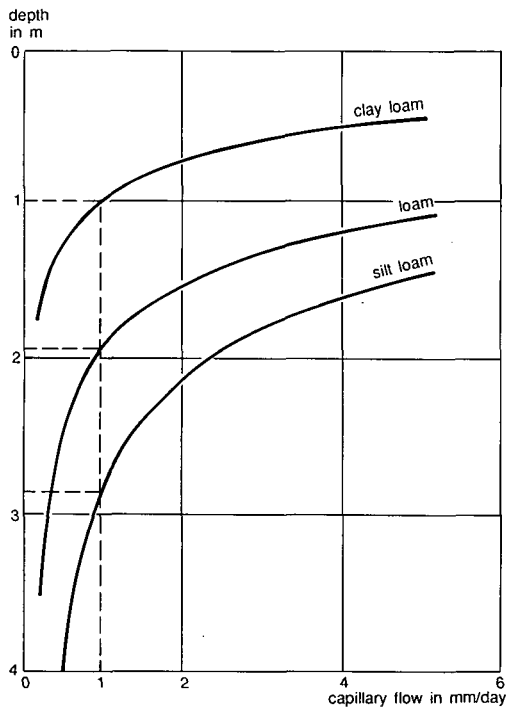

Figure 15.11 Relation between capillary flow velocity and depth of watertable for a suction of 16×10^5 Pa at the surface (after Van Hoorn 1979)

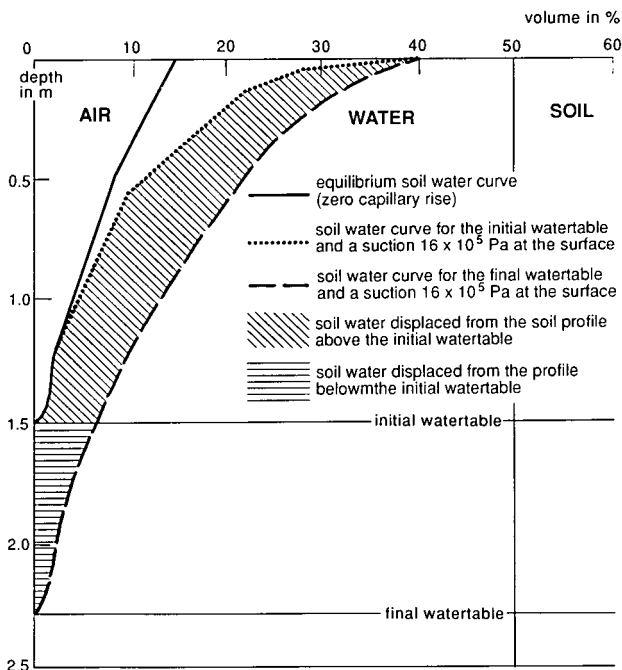

Figure 15.12 Soil water displaced by capillary rise in the case of a falling watertable (after van Hoorn 1979)

capillary rise during a six-month fallow period were calculated, again under the assumption of a gradual increase in the suction to a value of 16×10^5 Pa ($pF = 4.2$) at the surface. The results are presented in Table 15.6. These, too, show a clear difference between the soil types, the silt loam yielding the highest values. The deeper the watertable, the smaller the amount of capillary rise; moreover, the smaller the percentage of water originating from the soil profile below the initial watertable and the smaller the fall of the watertable during the fallow period.

In reality, capillary flow velocity, fall of the watertable, and amount of capillary rise will be less than the values presented in Figure 15.11 and Table 15.6. The assumption of a gradual increase in the suction towards the surface does not hold true because of the development of a surface mulch with a low water content that causes a rupture in the capillary conductivity.

Whether a surface mulch will develop depends on the local conditions of soil type, climate, and crop:

- A winter crop depleting the moisture content of the rootzone favours the development of a mulch layer to a considerable depth;
- Tillage of the surface layer has a similar effect;
- High evaporation exceeding the maximum capillary flow velocity is favourable for the development of a surface mulch, whereas an evaporation rate matching the maximum capillary flow velocity tends to cause a gradual increase in the suction towards the surface and is unfavourable for the development of a surface mulch;

Table 15.6 Fall of the watertable and amount of water displaced by capillary rise during a six-month fallow period

Initial watertable depth (m)	Soil type	Fall of watertable (m)	Average capillary velocity (mm/d)	Total capillary rise (mm)	Capillary rise from below initial watertable (mm)
1.00	Clay loam	0.90	0.3	50	25
	Loam	1.30	1.3	230	75
	Silt loam	1.90	2.0	350	140
1.50	Clay loam	0.50	0.2	35	10
	Loam	0.85	1.0	170	30
	Silt loam	1.45	1.7	300	70
2.00	Clay loam	0.25	0.1	20	5
	Loam	0.55	0.7	120	10
	Silt loam	1.05	1.3	230	30

– Summer rainfall, just wetting the soil and increasing its capillary conductivity, but not providing percolation for leaching, also has an unfavourable effect.

The fall of the watertable and the amount of capillary rise will vary for the same soil type, depending on local conditions. If capillary rise is not fed by seepage, the fall of the watertable will decrease to almost zero because capillary conductivity decreases with increasing depth of the watertable and, moreover, a surface mulch generally increases with time. The water level during the fallow period, at which capillary rise is reduced to almost zero can be defined as the critical depth.

15.4.2 Fallow Period without Seepage

In the case of a falling watertable without seepage, capillary rise originating from the soil profile below the initial watertable at the start of the fallow period will generally be small and can be reduced by lowering the initial watertable and by creating a mulch layer. Although the desiccation of the rootzone may be considerable, even amounting to 200 mm or more, the capillary rise from below the rootzone will usually be restricted to 20-50 mm, even in very dry climates. The best way to obtain data on desiccation and capillary rise is by sampling the soil at the beginning and end of the fallow period. The capillary rise during the fallow period can be regarded as negative percolation.

Under long-term equilibrium conditions and in the absence of seepage from elsewhere, the salt concentration of the soil water below the rootzone corresponds to that of the percolation water ($C_g = C_r$). So

$$EC_g = EC_r = \frac{IEC_i}{R^x} \quad (15.28)$$

in which \overline{EC}_i stands for the average value during the irrigation period. The salt accumulation during the fallow period can be calculated as

$$\Delta Z = GEC_g = G \frac{\overline{IEC}_i}{R^x} \quad (15.29)$$

Table 15.7 illustrates the conditions in a soil that is cropped and irrigated during winter and remains fallow from April to October. The desiccation of the fallow soil is assumed to be 100 mm, the capillary rise 40 mm. This, together with a rainfall of 110 mm during this period, leads to an evapotranspiration of 250 mm. The total amount of irrigation water required can be calculated with Equation 15.22 and is found to be 365 mm. As $E - P$ is 255 mm for the year, the net percolation is $365 - 255 = 110$ mm.

It is reasonable to make a distinction between a desiccation of the rootzone (ΔW_r) and a desiccation of the subsoil (ΔW_s). The latter is assumed to be found between the lower boundary of the rootzone and the watertable. When water is applied, it is assumed that the soil water reservoir in the rootzone, which shows a deficit of 100 mm at the end of the fallow period, will be replenished first. Only when the rootzone is at field capacity will the deeper layer be wetted.

In October, the difference between the amount of irrigation water entering the rootzone and the evapotranspiration, $I - (E - P)$, will replenish the soil water reservoir in the rootzone ($\Delta W_r = +65$ mm, Line 9). In November, the amount of $I - (E - P) = 60$ mm will partly replenish the soil water reservoir in the rootzone ($\Delta W_r = +35$ mm, Line 9) and partly the soil water reservoir in the subsoil ($\Delta W_s = +25$ mm, Line 11). So percolation starts in November, although no drainage will occur as long as the subsoil has not been replenished. In January, with water percolating through the rootzone and the subsoil, drainage will begin ($Dr = R^x - \Delta W_s = 45$ mm, Line 12).

The monthly variation in EC_c is calculated in the same way as in Table 15.3. Salt accumulation occurs during the fallow period and in October, whereas leaching occurs essentially in January and February.

If there is no seepage and we assume that C_g equals C_r , Equations 15.9 and 15.10 do not directly show an effect of capillary flow on the leaching requirement and on the total amount of irrigation water. However, in the case of capillary rise during either the growth or the fallow period, evapotranspiration increases and so, too, do the leaching requirement and the amount of irrigation water.

15.4.3 Seepage or a Highly Saline Subsoil

To illustrate the case of saline seepage from another area, we take the general data from Table 15.7

$$(E - P) = 255 \text{ mm}, \overline{EC}_i = 2.4 \text{ dS/m}, EC_{fc} = 8 \text{ dS/m}$$

If we assume a capillary flow, G , of 40 mm and $EC_g = 20$ dS/m, Equation 15.7 yields

$$R^x = 110 + 86 = 196 \text{ mm}$$

$$R = 196 + 40 = 236 \text{ mm and } I = 255 + 196 = 451 \text{ mm}$$

Table 15.7 Salt and water balance for a seasonally irrigated soil with capillary rise during the fallow period

1	General data: $W_{fc} = 300$ mm; $EC_e = 0.5 EC_{fc}$; $\overline{EC}_e = 4$ dS/m; $G = -R^x = 40$ mm during fallow										
2	Period	Year	Oct.	Nov.	Dec.	Jan.	Febr.	March	Apr. - Sept.		
3	Land use	Irrigated cereals							Fallow		
4	E	mm	655	60	60	60	60	75	90	250	
5	P	mm	400	40	50	60	50	50	40	110	
6	E-P	mm	255	20	10	0	10	25	50	140	
7	EC_i	dS/m	2.4	3	3	2	2	2	2		
8	I	mm	365	85	70	0	70	70	70	0	
9	ΔW_r	mm	0	+65	+35	0	0	0	0	-100	
10	R^x	mm	110	0	25	0	60	45	20	-40	
11	ΔW_s	mm	0	0	+25	0	+15	0	0	-40	
12	Dr	mm	110	0	0	0	45	45	20	0	
13a	Z_1	ECmm		2000	2255	2276	2276	1990	1842	1858	
14a	ΔZ	ECmm	+176	+255	+21	0	-286	-148	+16	+318	
15a	Z_2	ECmm		2255	2276	2276	1990	1842	1858	2176	
13b	Z_1	ECmm		3000	3255	3196	3196	2742	2490	2465	
14b	ΔZ	ECmm	-217	+255	-59	0	-454	-252	-25	+318	
15b	Z_2	ECmm		3255	3196	3196	2742	2490	2465	2783	
13c	Z_1	ECmm		2465	2720	2704	2704	2339	2142	2139	
14c	ΔZ	ECmm	-8	+255	-16	0	-365	-197	-3	+318	
15c	Z_2	ECmm		2720	2704	2704	2339	2142	2139	2457	
16	EC_e^*	dS/m	4.0	4.1	4.5	4.5	4.5	3.9	3.6	3.5	

* EC_e at start of period or month considered

Comparing this result with that obtained in Table 15.7 ($R^x = 110$ mm and $I = 365$ mm), we see that the amount of irrigation water must be increased by 86 mm to counterbalance the capillary flow caused by highly saline seepage water. If capillary rise due to saline seepage amounts to 80 mm and evapotranspiration minus rainfall increases to 295 mm, R^x increases to 298 mm and I to 593 mm. So saline seepage leads to a considerable increase in the leaching requirement.

If there is no seepage but a highly saline subsoil for which we cannot assume that C_g equals C_r , the increase in the salinity of the rootzone during a fallow period can be estimated in the following way. The amount of salt in a soil profile can be calculated with Equation 15.30

$$S = C \times w \times D \times \frac{\rho_b}{\rho_w} \quad (15.30)$$

where

- S = amount of salt (kg/ha)
- C = salt concentration (g/l or kg/m³). To express this in terms of electrical conductivity, C can be replaced by approximately 0.7 EC dS/m
- w = water content in mass percentage
- D = depth of rootzone (cm)
- ρ_b = bulk density of soil (kg/m³)
- ρ_w = density of water = 1000 (kg/m³)

The increase of EC_e can be calculated by slightly modifying Equation 15.30

$$\Delta EC_e = \frac{\Delta S}{0.7 \times w_e \times \rho_b / \rho_w \times D} \quad (15.31)$$

Table 15.8 gives the increase in salt content of the rootzone due to capillary flow. The following values have been assumed: $w_e = 50$, $\rho_b = 1500$ kg/m³, and $D = 50$ cm. Moreover, the capillary flow amounts to 400 m³/ha (= 40 mm). The increase in salt content is then obtained by multiplying the capillary flow by the salt content of the soil water.

Table 15.8 Increase in salt content due to capillary flow

Salinity of subsoil				ΔS from 40 mm capillary rise	ΔEC_e in upper 50 cm
Saturated paste	Soil water				
EC_e (dS/m)	EC (dS/m)	C g/l		(kg/ha)	(dS/m)
25	50	35		14000	5.3
20	40	28		11200	4.3
15	30	21		8400	3.2
10	20	14		5600	2.1
5	10	7		2800	1.1

Even a small amount of highly saline capillary flow is already harmful after one fallow period. If the salt concentration of the capillary flow is low, soil salinity will also increase when the process continues from year to year and the salts are not washed out during the winter period.

15.4.4 Depth of Watertable

The criteria for watertable depth depend, for the irrigation season, on aeration requirements of the crops and, for the fallow season, on the prevention of capillary salinization. For the irrigation season, the following values can be used (FAO 1980):

- For field crops and vegetables, a depth between 1.0 m and 1.2 m;
- For fruit trees, a depth between 1.2 and 1.6 m.

The shallower depths refer to coarse-textured soils, the greater depths to fine-textured soils. The values correspond with the average watertable depth as used in the steady-state equations for drain spacing (Chapter 8). If unsteady-state drain spacing equations are used, the watertable depth should correspond with the minimum depth not to be exceeded:

- For field crops and vegetables, about 0.9 m;
- For fruit trees, between 1.0 m and 1.4 m.

Drainage criteria are discussed in Chapter 17.

During the irrigation season, there is no risk of capillary salinization owing to the prevailing percolation, even if seepage occurs (Figure 15.13). During the fallow season, however, capillary rise can add greatly to the salinization of the rootzone (Figure 15.14).

If there is no seepage, as was pointed out in Section 15.4.1, capillary rise will cause the watertable to fall during the fallow period to a depth at which capillary flow is reduced to almost zero. With long-term equilibrium between rootzone and subsoil, the salt concentration of the upward flow equals that of the percolation water. This leads to a reduction in the net percolation (Section 15.3.1), which means a reduction in the leaching fraction. The real leaching fraction of low and medium salinity water is generally higher than the fraction needed to cover the leaching requirement. In that case, capillary rise is not likely to lead to salinization.

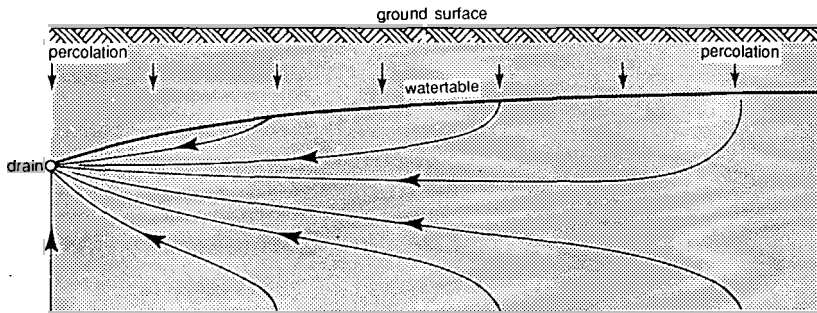

Figure 15.13 Flow lines in the case of irrigation and seepage

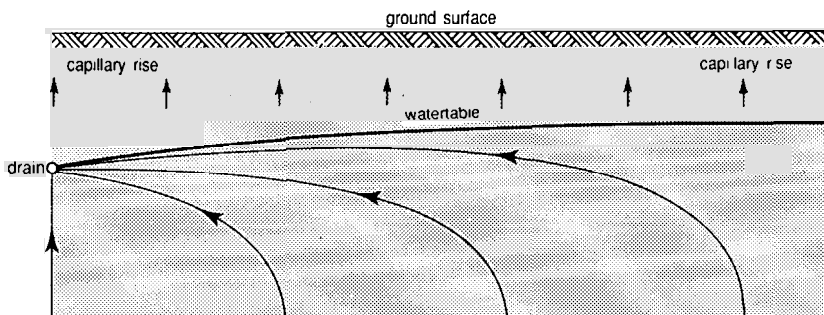

Figure 15.14 Flow lines in the case of evaporation and seepage

If, in contrast, there is seepage or saline subsoil water, capillary rise in the fallow period will contribute greatly to the salinization of the rootzone, as was pointed out in Section 15.4.3.

To reduce the salinization hazard during the fallow season, the watertable should be kept at a depth below about 1.40 m for sandy and clayey soils and below about 1.70 m for silty soils.

Sandy soils have a high capillary velocity, but a limited height of capillary rise. Clay soils have a low capillary velocity, but theoretically a considerable height of capillary rise. In practice, however, this height is quite limited because of the cracks that appear when the soils dry out and cut the capillary system. In contrast, silty soils with a large silt fraction (2-50 μm), which do not form cracks when dry, are the most dangerous ones for salinization because they combine an average capillary velocity with a considerable height of capillary rise.

Keeping the watertable below a depth of 1.40 m for sandy and clayey soils and below 1.70 m for silty soils is not an absolute guarantee against salinization. If capillary rise in the fallow season is not offset by percolation, all soils will become salinized in the long run, even with watertables at depths of 3 to 4 m, as is found in examples of the 'source-sink' system in the Punjab (Figure 15.15). The 'source' (irrigated land) has a shallow watertable, and salinity increasing with depth, a clear indication of prevailing downward percolation. The 'sink' (neighbouring non-irrigated land) has a deep watertable, often between 3 and 4 m, with soil salinity increasing towards the surface, indicating prevailing upward flow.

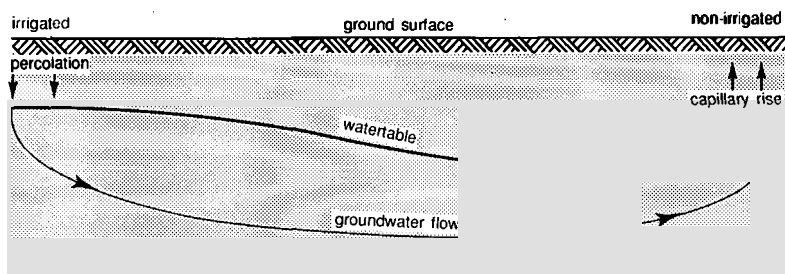

Figure 15.15 Watertable in irrigated and non-irrigated land

In the long run, capillary flow should always be counterbalanced by percolation. As long as the downward movement of water prevails over upward flow, there is no risk of increasing salinity. The salinity level of the soil depends upon the net percolation and the salt concentrations of irrigation water and capillary water from the subsoil.

15.5 Leaching Process in the Rootzone

15.5.1 The Rootzone regarded as a Four-Layered Profile

In Section 15.3.1, the rootzone was regarded as a one-layered profile of homogeneous salinity. In reality, the rootzone is a column in which the water uptake by the crop decreases with depth. The amount of water percolating through the soil profile thus also decreases with depth whereas its salinity increases. As a result, the salinity of the soil increases with depth.

Figure 15.16 shows an example of the calculation of a salinity profile expected to develop after the long-term use of irrigation water ($EC_i = 1 \text{ dS/m}$) at five leaching fractions. The calculation assumes the following water-uptake pattern:

- 40% from the upper one-quarter of the rootzone;
- 30% from the second quarter;
- 20% from the third quarter;
- 10% from the lowest quarter.

The amount of irrigation water applied to the first layer and the amount of water percolating from the fourth layer can be calculated for the successive values of the leaching fraction, LF, by the following equations, which are derived by combining Equations 15.8 and 15.11.

$$I = (E - P) \frac{1}{1 - LF} \quad (15.32)$$

$$R^x = (E - P) \frac{LF}{1 - LF} \quad (15.33)$$

Table 15.9 shows the calculations. The percolation from each layer equals the irrigation water of that layer minus the water uptake. Percolation water from the first

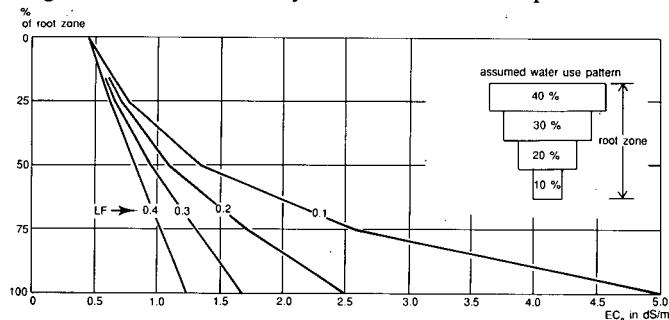

Figure 15.16 Salinity profile expected to develop after the long-term use of irrigation water of $EC = 1.0 \text{ dS/m}$ at various leaching fractions, LF (after FAO 1985)

Table 15.9 Calculation of the soil salinity in a four-layered profile ($EC_i = 1 \text{ dS/m}$, $LF = 0.2 \rightarrow 1 = 1.25(E-P)$, $R^x = 0.25(E-P)$)

Layer	Water uptake	I	R^x	EC_i	$EC_{fc} = 2EC_e$	EC_e
1	0.4(E-P)	1.25(E-P)	0.85(E-P)	1.0	1.47	0.74
2	0.3(E-P)	0.85(E-P)	0.55(E-P)	1.47	2.27	1.14
3	0.2(E-P)	0.55(E-P)	0.35(E-P)	2.27	3.57	1.79
4	0.1(E-P)	0.35(E-P)	0.25(E-P)	3.57	5.00	2.50
Average					2.66	1.33

layer serves as irrigation water for the second layer, and so on. The salt equilibrium equation, Equation 15.23, is applied to each of the four layers. For the first layer, EC_i represents the salinity of the irrigation water; for the second layer, the salinity of the water percolating from the first layer, and so on: $(EC_i)_n = (EC_{fc})_{n-1} = (2EC_e)_{n-1}$. The average soil salinity equals the sum of EC_i (soil water salinity at the surface) and the four values of EC_{fc} (soil water salinity at the bottom of each layer) divided by 5.

For the water-uptake pattern described above, Figure 15.17 presents the relation between the salinity of the irrigation water, expressed as EC_i , and the average salinity of the soil profile, expressed as EC_e . It should be understood that the salinity of the water percolating from the bottom of the soil profile is almost twice the average EC_{fc} -value (e.g. in Table 15.9, 5.0 instead of 2.66). The lower the leaching fraction, the

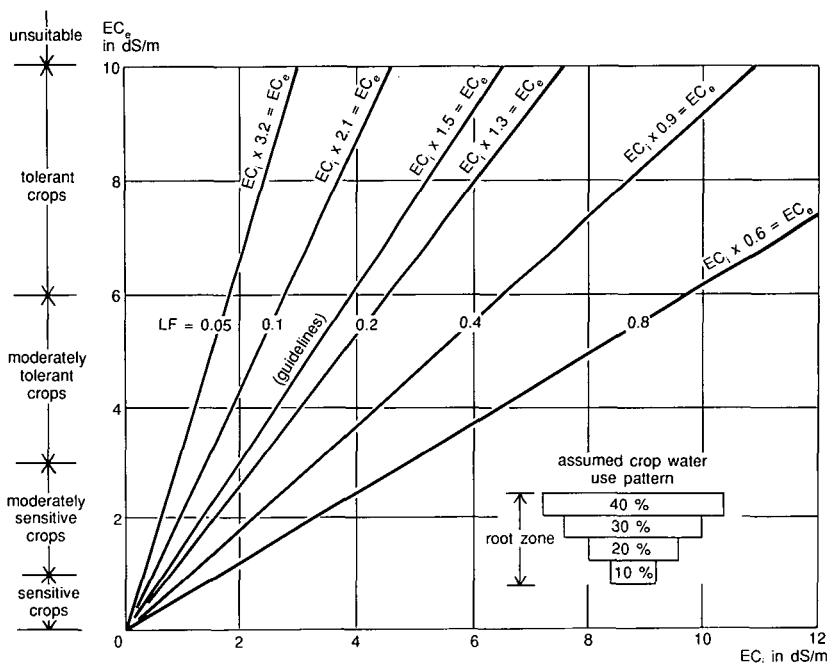

Figure 15.17 Effect of water salinity, EC_i , upon rootzone soil salinity, EC_e , at various leaching fractions, LF (after FAO 1985)

larger the difference between the average salinity and the salinity at the bottom of the root zone.

For the same water-uptake pattern, Figure 15.18 shows the difference between the leaching fraction for a one-layered rootzone and that for a four-layered rootzone, corresponding with the same ratio $EC_e:EC_i$. By using the concept of a one-layered rootzone, we clearly overestimate the leaching requirement.

An example taken from practice is presented in Figure 15.19. It concerns an irrigation test conducted at the Cherfech Experimental Station in Tunisia. The test consisted of four applications of irrigation water of about 2.3 g/l ($EC_i = 3.5$ dS/m). The applications I_1 , I_2 , and I_3 are respectively equal to 1.5, 2, and 2.5 times I_0 . In summer, the applications I_0 , I_1 , I_2 , and I_3 correspond to a daily supply of 4, 6, 8, and 10 mm/d, ranging around the consumptive use of 7 mm/d. As can be seen in the figure, there is a marked increase in salinity with depth, and a clear difference in soil salinity due to increasing amounts of leaching water (from I_0 to I_3).

15.5.2 The Leaching Efficiency Coefficient

In a porous medium, salt is displaced by mass flow and molecular diffusion. The most simple case of salt displacement is by piston flow. This displaces one solution with another, with a sharp boundary between the two solutions and, when the volume of the effluent equals the volume of water initially present in the pore volume, an abrupt change in the concentration of the effluent from C_o to C_i (Figure 15.20). Even in a homogeneous medium with a uniform pore size distribution, however, such an abrupt change is not likely to occur because the molecular diffusion at the boundary between the two solutions will prevent it. The lower the flow velocity, the more diffusion will occur and the less steep will be the slope of the breakthrough curve.

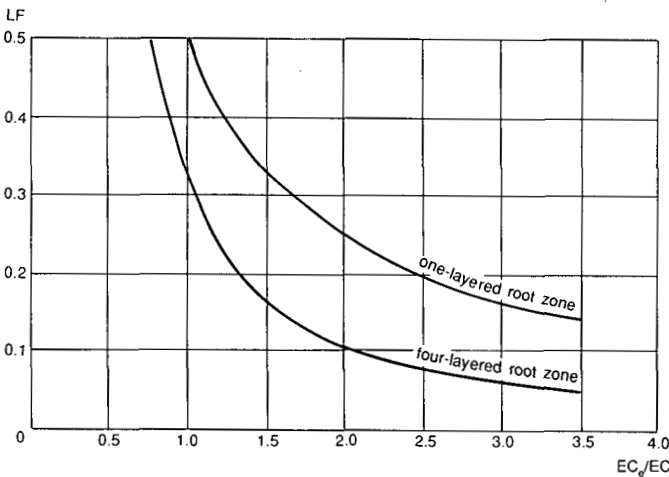

Figure 15.18 EC_e/EC_i versus the leaching fraction, LF, for a one-layered rootzone and a four-layered rootzone

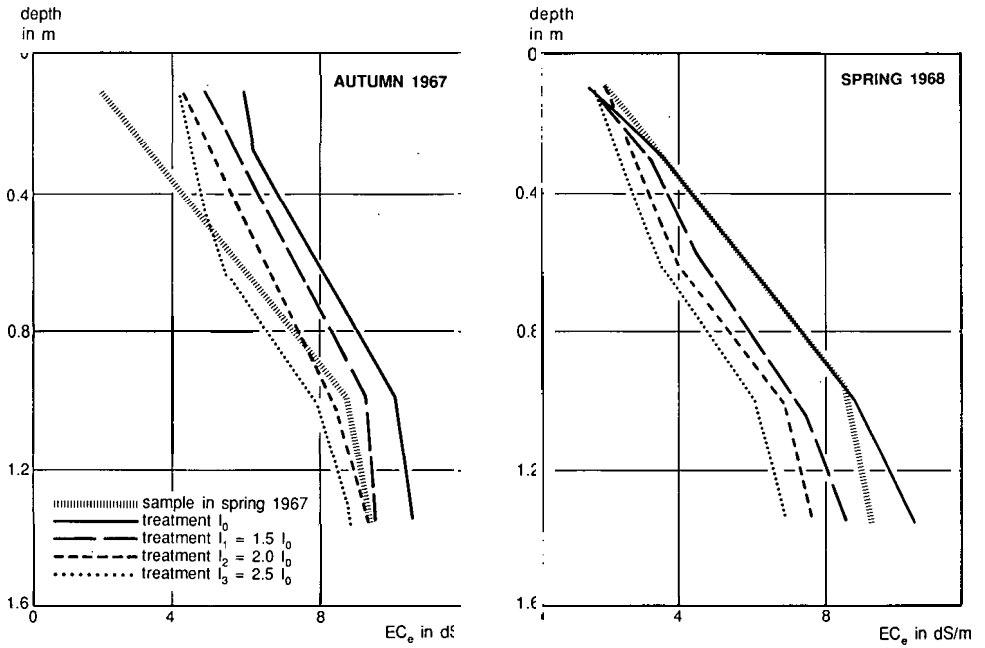
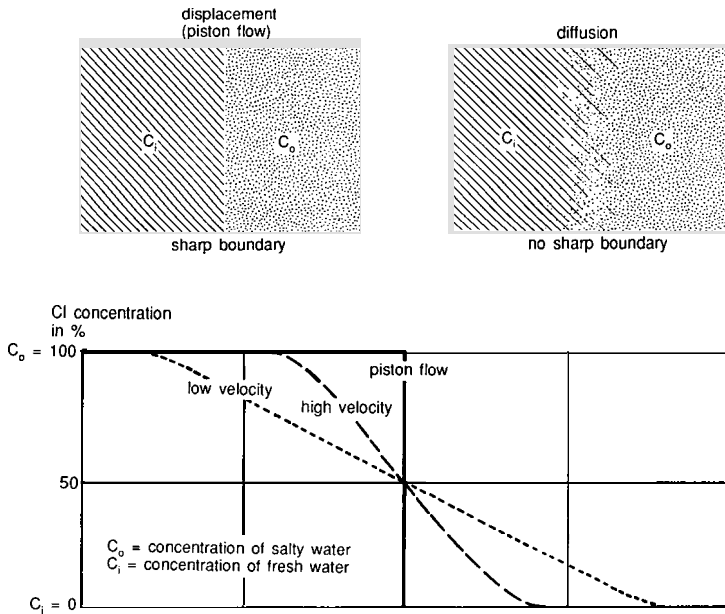

Figure 15.19 Irrigation test showing increase in salinity with depth and difference in soil salinity due to increasing amounts of leaching water



In a heterogeneous porous medium like soil, water moves through a complicated network of tortuous pores of different sizes. Because the flow velocity is higher in large pores than in small ones and is, moreover, higher in the centre of a pore than along its wall, the flow velocity is not equally distributed. Two solutions moving through such a medium will therefore mix. The mixing caused by the uneven distribution of the flow velocity is called dispersion. As diffusion also occurs in the cavities formed by the pores, the solutions are mixed by a combination of dispersion and diffusion, which is called miscible displacement (Biggar and Nielsen 1960). Other processes that affect salt displacement are ion exchange and precipitation or dissolution of salts.

In a soil profile, the incoming water may either completely mix with the soil solution or only partially – some of the water passing through large channels or pores without making contact with the soil solution.

Figure 15.21 shows the chloride concentration of soil water at increasing depth, versus the amount of drainage water, when a soil profile consisting of 1 m sandy loam on coarse sand is leached. It appears that the chloride concentration of the drainage water, being the same as that of the soil water at a depth of 1.075 m in the underlying sand layer, soon reduces to values less than those at depths of 0.675 and 0.925 m. After about 300 mm of drainage water, part of the percolation water apparently moves directly from the upper layers through large, already desalinated pores in the lower layers, towards the sand layer without mixing with the soil water in the lower layers.

The degree to which the incoming water mixes with the soil solution can be expressed by a leaching efficiency coefficient, which can be defined in two ways:

- With respect to the percolation water at the bottom of the rootzone: the leaching efficiency coefficient, f_r , is then defined as the fraction of water percolating from

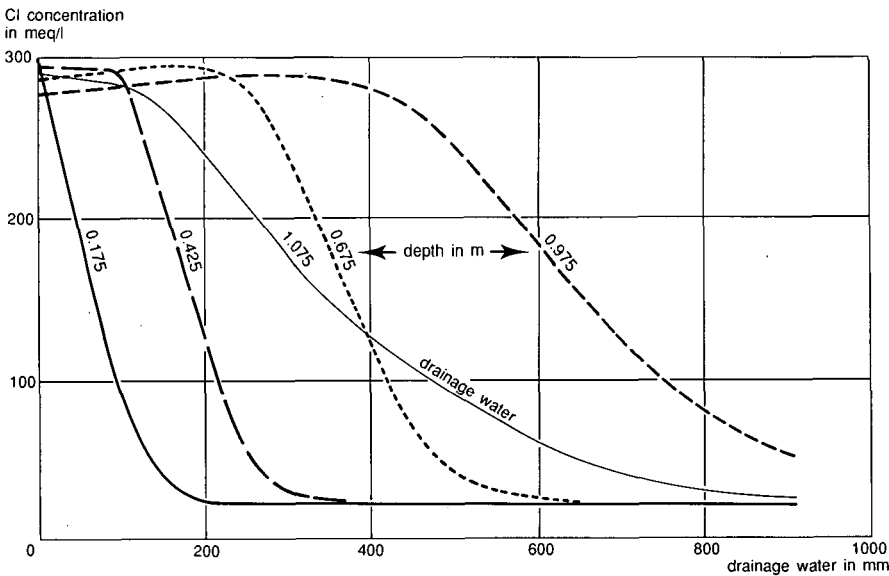

Figure 15.21 Chloride concentration of drainage water and of soil water at increasing depth versus amount of drainage water during leaching of a sandy loam profile (after Van Hoorn 1981)

the soil solution. This concept of leaching efficiency was originally introduced by Boumans for reclamation experiments in Iraq (Dieleman 1963);

- With respect to the irrigation water: the leaching efficiency coefficient, f_l , is then defined as the fraction of irrigation water mixing with the soil solution.

The concept of the leaching efficiency coefficient is presented in Figure 15.22.

If we consider a cycle at the start and the end of which the soil water content is the same (equilibrium condition), we can write for the amount of percolation water at the bottom of the rootzone

$$R^x = f_l R^x + (1 - f_l) R^x \quad (15.34)$$

and

$$R^x = (f_l I - E + P) + (1 - f_l) I \quad (15.35)$$

Since $(1 - f_l) R^x = (1 - f_l) I$, we obtain the following relation between f_l and f_i

$$f_l R^x = f_i I - E + P \quad (15.36)$$

Example 15.3

$P = 0$, $E = 600$ mm, $I = 1000$ mm, $f_i = 0.8$.

So $R^x = 400$ mm and $f_l = (0.8 \times 1000 - 600)/400 = 0.5$; 200 mm of water percolates from the soil solution and 200 mm passes through the bypass.

The coefficient, f_l , is not an independent variable, but depends upon the leaching efficiency coefficient, f_i , and upon the amounts of water (irrigation, rainfall, evapotranspiration). Figure 15.23 presents the relation between f_l , f_i , $(E - P)/I$, and R^x/I , showing a decrease in f_l if f_i and the fraction of percolation water R^x/I decrease. In contrast, the coefficient, f_i , the fraction of irrigation water mixing with the soil solution, can be considered an independent variable, determined by soil texture, structure, and irrigation method.

Fine-textured soils show a lower value for f_l because of the presence of cracks in these soils. The amount of water applied and the irrigation method also considerably influence the value of f_l . In general, the larger the water applications, the smaller the leaching efficiency coefficient. The highest efficiency is obtained with low intensity sprinkling or with rainfall.

Field experiments in Tunisia showed a variation of f_l from 0.60 to 0.95 on the same soil profile, the differences being due to the different ways in which water was applied (Unesco 1970). For medium- and fine-textured soils and moderate water applications, which caused drainage of about 20% of the amount of precipitation and irrigation,

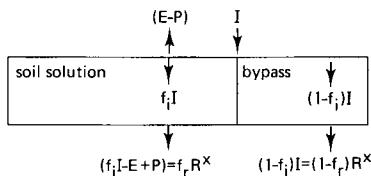

Figure 15.22 The concept of the leaching efficiency coefficient

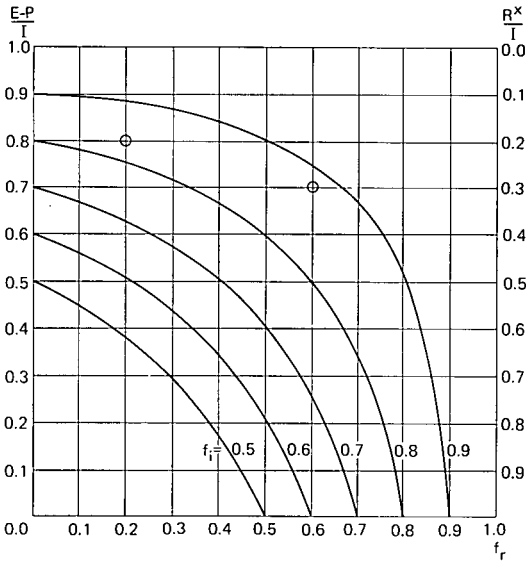

Figure 15.23 Relation between the fraction of water percolating from the rootzone, f_r , and the fraction of irrigation water mixing with the soil solution, f_i

a value of 0.85 was obtained for f_i , whereas on a sandy soil values between 0.95 and 1.0 were obtained.

Field experiments in Iraq showed the leaching efficiency coefficient, f_r , as ranging from 0.2 for clay to 0.6 for silty loam (Dieleman 1963). The large range may be ascribed partly to a difference in the value of f_i and partly to the smaller fraction of water that percolates from clay soils; for instance, combining in Figure 15.23 an R^x/I -value of 0.2 with an f_r -value of 0.2 or an R^x/I -value of 0.3 with an f_r -value of 0.6 yields in both cases an f_i -value of about 0.85.

15.5.3 The Leaching Efficiency Coefficient in a Four-Layered Profile

The four-layered concept, in assuming a decreasing water uptake with depth, certainly far better describes the water and salt movement and the salinity profile to be expected than the one-layered concept. Nevertheless, when we change from the simple concept of a one-layered profile to the more complicated concept of a four-layered profile so as to approach reality better, we must also take into account the reality that a part of the water is passing through large channels and pores and is not efficient in leaching salts.

If part of the water only is efficient for leaching, the leaching fraction is not equal to the ratio between the amounts of percolation and irrigation water, R^x/I , but equals the ratio between the amount of water percolating from the soil solution, $f_i I - E + P$, and the amount of irrigation water mixing with the soil solution, $f_i I$. Thus

$$LF_b = (f_i I - E + P) / f_i I \quad (15.37)$$

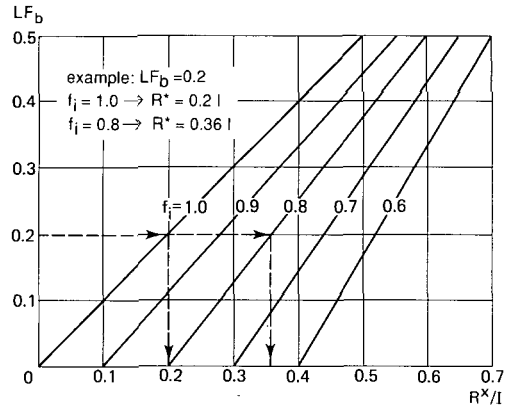
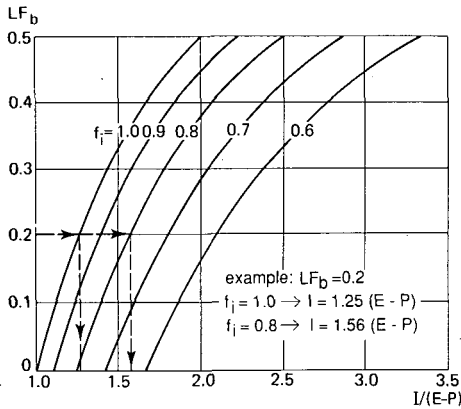

Figure 15.24 Relation between LF_b , f_i , $I/(E-P)$, and R^x/I

where the subscript b stands for bypass
and

$$I = (E - P) \frac{1}{f_i(1 - LF_b)} \quad (15.38)$$

Substituting Equation 15.38 into Equation 15.35 gives

$$R^x = (E - P) \frac{1 - f_i(1 - LF_b)}{f_i(1 - LF_b)} = I - (E - P) = I\{1 - f_i(1 - LF_b)\} \quad (15.39)$$

Now the values of I and R^x are calculated with Equations 15.38 and 15.39 or obtained from Figure 15.24.

Table 15.10 draws a comparison between a one-layered rootzone with an f_i -value of 1 and a four-layered rootzone with different f_i -values. The ratio EC_e/EC_i varies from 1.5 to 2.5. This means that the salt concentration of the soil water ranges from three to five times that of the irrigation water, which may be considered a normal range under good irrigation and drainage conditions. Table 15.10 was obtained by taking, for the three EC_e/EC_i ratios, the corresponding LF -values from Figure 15.17 and by calculating the values I and R^x with Equations 15.38 and 15.39 respectively.

Table 15.10 Comparison between a one-layered rootzone with an f_i -value of 1 and a four-layered rootzone with various f_i -values. R^x and I are expressed in % of the values calculated for the one-layered concept

EC_e/EC_i	Leaching requirement R^x			Irrigation water I		
	1.5	2.0	2.5	1.5	2.0	2.5
$f_i = 1.00$	40	35	35	80	84	87
0.95	53	53	58	84	88	92
0.90	67	72	83	89	93	97
0.85	83	94	112	94	99	102
0.80	100	119	144	100	105	109

It appears that, for an f_i -value of 0.85, the differences in the amount of irrigation water are less than 10%, whereas the differences in the leaching requirement are somewhat greater, but do not exceed 20%; for an f_i -value of 0.95, the difference in I will be between 8 and 16% and the differences in R^x will rise to about 50%.

When a high leaching efficiency coefficient can be expected (e.g. under drip, sprinkler, or careful surface irrigation on coarse-textured soils), the use of the one-layered concept will overestimate the amount of irrigation water and especially the leaching requirement. In that case, it may be better to use the four-layered concept. For an average f_i -value between 0.8 and 0.9, the differences between the two concepts are small. The overestimate of the leaching requirement by assuming a rootzone with a homogeneous water and salt distribution is offset by the fact that, in reality, irrigation water is not fully efficient in leaching. For practical purposes, we can just as well estimate the leaching requirement by using the simple concept of a one-layered rootzone with complete mixing of irrigation and soil water. In reality, the salinity of the upper part of the rootzone will tend to be somewhat lower than the average value and that of the lower part will be somewhat higher.

15.6 Long-Term Salinity Level and Percolation

By using the one-layered concept with complete mixing, no saline seepage, and no precipitation of salts, we can estimate the long-term salinity level of the rootzone as found with Equation 15.23

$$EC_c = \frac{EC_i}{2LF} = \frac{n EC_i}{2} \quad (15.40)$$

in which n stands for the concentration factor of the irrigation water, which equals the inversed value of the leaching fraction, LF , or net percolation. We then adapt the choice of the crops to this estimated level. Instead of first choosing the crops and then calculating the leaching requirement for the salinity level corresponding with those crops, it is more practical to estimate first the salinity level from the quality of the irrigation water and the long-term percolation losses, which means the real leaching fraction, and then to choose the crop. Figure 15.17, in which the crop classes are indicated along the axis of the soil salinity, follows this approach.

To estimate the long-term salinity level of the rootzone in areas where leaching is provided by a combination of irrigation water and rainfall, we should use a weighted average of the salt concentration of these combined waters. Neglecting the salt concentration of rainfall, we can use the following expression

$$EC_{i+p} = \frac{I}{I+P} \times EC_i \quad (15.41)$$

and, to estimate the long-term salinity level of the rootzone,

$$EC_c = \frac{n}{2} \times \frac{I}{I+P} \times EC_i = \frac{1}{2LF} \times \frac{I}{I+P} \times EC_i \quad (15.42)$$

Table 15.11 presents the water balance of a tile-drained field of the Experimental

Table 15.11 Percolation losses (R) from irrigation (I) and precipitation (P), measured as drain discharge on a tile-drained field in Tunisia

		Summer					Winter				
		1964	1965	1966	1967	1968	64-65	65-66	66-67	67-68	68-69
I	(mm)	452	645	530	860	1373	110	100	467	182	445
P	(mm)	112	19	69	4	53	441	445	323	324	221
R	(mm)	121	141	138	217	304	139	56	200	141	131
R/(I+P)	(%)	21	21	23	25	21	25	10	25	28	20

Station at Cherfech in Northern Tunisia. The net percolation losses, carried off as drainage water, equalled 0.22 of the total amount of irrigation water and precipitation. During summer, the losses were mainly due to an excess of irrigation water and, during winter, to a combination of irrigation water and rainfall.

The average amount of irrigation water equalled about 1000 mm and the precipitation 400 mm, leading to a factor of 0.7 for $I/(I + P)$. The long-term salinity level in the rootzone could then be estimated at $EC_e = 1.5EC_i$. Since the weighted average of EC_i equalled 3.3 dS/m for the field over the period of 5 years, the estimated EC_e -value ranged around 5 dS/m, corresponding quite well with soil analysis data of the rootzone.

Figure 15.25 shows the long-term effect of the salinity of irrigation water on soil salinity as determined in a water-quality test at the same experimental station, where four different water qualities were applied: A 0.3, B 2.1, C 3.5, and D 5.2 dS/m. In the upper 0.40 m, a clear seasonal fluctuation can be seen, which is attributable to less irrigation water and more rainfall during winter. Differences between successive years are also apparent because of changes in leaching conditions (crop, irrigation regime, and irrigation method).

Table 15.12 summarizes the average values of EC_i , EC_e , and EC_{i+p} as well as the ratios EC_e/EC_i and EC_e/EC_{i+p} for the rootzone between 0 and 0.80 m. For the EC_i -values of 2.1 and 3.5 dS/m, the ratio EC_e/EC_i is about 1.5 and the ratio EC_e/EC_{i+p} between 2.2 and 2.5. This means a concentration factor for the soil water between 4.4 and 5 and a leaching fraction between 0.20 and 0.23. The lower ratios for an EC_i -value of 5.2 dS/m can be ascribed to the precipitation of $CaCO_3$ and $CaSO_4$. The large discrepancy for an EC_i -value of 0.3 dS/m can be ascribed to the presence of $CaCO_3$ and $CaSO_4$ in the soil. In evaluating the leaching process, it is often better to express soil salinity in terms of chloride concentration instead of electrical conductivity, because the chloride ion is not involved in precipitation or adsorption reactions in the soil.

Table 15.13 presents another example of the effect of irrigation-water salinity on soil salinity. The lower limits of soil salinity are the same for approximately the same salinity of the irrigation water. The lower EC_e of 2.5 at Ksar Gheriss can be ascribed to the coarse texture of the soil (i.e. loamy sand), which gives too optimistic an index of salinity when expressed as EC_e . With sand and loamy sand, w_{fc} equals three to four times w_{fc} , so that EC_{fc} equals three to four times EC_e instead of two times EC_e . The higher EC_e -value of 5 at Tozeur can be ascribed to the gypsum content of the soil.

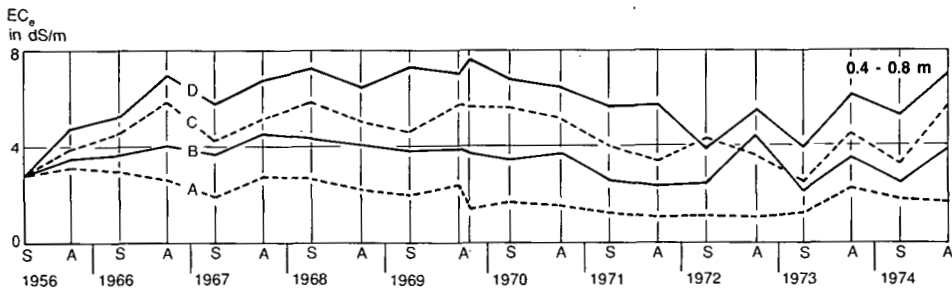
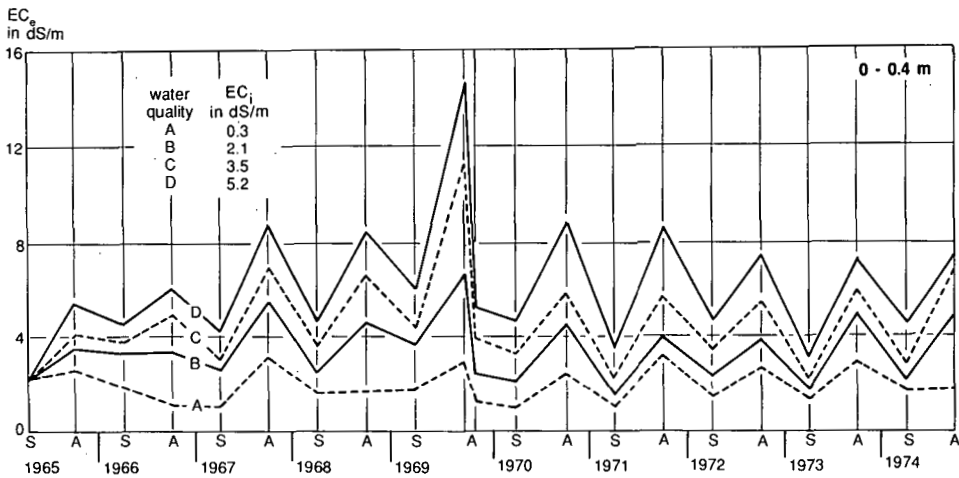

Figure 15.25 Water-quality test showing different long-term soil salinity levels

The upper limits of soil salinity vary widely because of differences in irrigation regime and method during summer.

With increasing salt concentrations in the irrigation water, the examples presented in Figure 15.25 and Table 15.13 clearly show increasing levels of soil salinity, which can be estimated from the salt concentration of the irrigation water, precipitation, and long-term percolation losses. The choice of crops should be adapted to these levels.

The relation $EC_e = 1.5EC_i$, indicated in Figure 15.17, is used in FAO's Irrigation

Table 15.12 Long-term salinity levels in water-quality test

Quality		A	B	C	D
EC_i	(dS/m)	0.3	2.1	3.5	5.2
EC_e	(dS/m)	1.8	3.6	5.0	6.2
EC_e/EC_i	(-)	6.0	1.7	1.4	1.2
EC_{i+p}	(dS/m)	0.2	1.4	2.3	3.5
EC_e/EC_{i+p}	(-)	9.0	2.5	2.2	1.8

Table 15.13 Upper and lower limits of soil salinity attained under different conditions in Tunisia

Station	Soil texture	Rainfall, mm/year	EC _i dS/m	EC _e (dS/m) in soil layer 0–0.40 m	
				Min.	Max.
Cherfech	Fine	420	0.3	1	3
			2.0	2	5
			3.5	3	7
			5.2	4	9
Messaoudia	Fine	280	2.8	3	9
Nakta	Medium	200	5.5	4	12
Ksar Gheriss	Coarse	150	4.9	2.5	10
Tozeur	Coarse, gypsum	90	3.1	5	8

and Drainage Paper 29 (FAO 1985) as a guideline for estimating the average salinity of the rootzone. The relation corresponds quite well with the examples from Tunisia, which were obtained on medium- and fine-textured soils under good irrigation and drainage conditions, and where precipitation provided about one-third of the total amount of water. But it should be clearly understood that this relation may change in the absence of rainfall or under different soil and drainage conditions that affect percolation.

On coarse-textured soils with a high infiltration rate and excellent natural drainage, high leaching fractions of 0.40 are possible. On such soils, therefore, under desert conditions and for salt-tolerant crops, high-salinity water, even with an EC_i of 6 dS/m, can be used.

On medium- and fine-textured soils, according to experience on clay loam and silty clay loam soils in Tunisia, an increase in the fraction of percolation water above about 0.25 should be avoided; otherwise, crops will suffocate from excessive watering and waterlogging. When using high-salinity water on such soils, it is useless to apply large amounts of water in an attempt to reduce soil salinity. One merely increases the risk of water stagnation and conditions that are too wet for plant growth. Instead of applying more leaching water, it is better to adapt the choice of the crops to the salinity level of the soil, as is commonly done in practice.

On heavy clay soils of low permeability (e.g. silty clay and clay soils in river basins), the net percolation fraction may not exceed 0.10, even if a good drainage system is present. On such soils, therefore, low-salinity water, preferably with an EC_i less than 0.5 dS/m, should be used.

Percolation losses vary with irrigation method, application practices, and soil types, as is shown in Table 15.14. The term 'fine' in the table refers to a range of finer-textured permeable soils, and 'coarse' to a range of coarser soils with a good-to-fair water-holding capacity. The fractions given do not apply to soils with extreme values of hydraulic conductivity and infiltration rate.

Although the losses are not equally distributed over the field – their pattern varying from year to year according to the irrigation method and the amount of water applied – the minimum percolation losses with surface irrigation and sprinkling can be

Table 15.14 Estimated deep percolation fractions as related to water application efficiency, irrigation method, and soil type (FAO 1980)

Irrigation method	Application practices	Field application efficiency in %		Average deep percolation as fraction of irrigation water delivered to the field	
		Soil texture		Soil texture	
		Fine	Coarse	Fine	Coarse
Sprinkler	Daytime application, moderately strong wind	60	60	0.30	0.30
	Night application	70	70	0.25	0.25
Trickle		80	80	0.15	0.15
Basin	Poorly levelled and shaped	60	45	0.30	0.40
	Well levelled and shaped	75	60	0.20	0.30
Furrow, Border	Poorly graded and sized	55	40	0.30	0.40
	Well graded and sized	65	50	0.25	0.35

estimated at around 0.20-0.25 for a large range of soils, if provided with sufficient drainage. The percolation losses will be higher for very coarse soils (e.g. sand) and lower for very fine soils (e.g. silty clay and clay).

Table 15.15 presents the relation between the leaching fraction (LF), the concentration factor ($n = 1/LF$), and the electrical conductivity of the saturation extract for a range of increasing conductivities of irrigation water. In this table, EC_i can be replaced by EC_{i+p} , if rainfall provides a contribution to leaching.

A comparison between the percolation fractions of Table 15.14 and the leaching fractions of Table 15.15 leads to the conclusion that, if we take an EC_e -value of about 2 as criterion, the percolation fraction exceeds the leaching requirement for low-salinity water (EC_i 0.25-0.5 dS/m) and for medium-salinity water (EC_i 0.5-1.0 dS/m). For high-salinity water ($EC_i > 1.0$ dS/m), a percolation fraction of about 0.20-0.25 is needed for leaching, but, on most soils, higher losses should be avoided to prevent damage from excessive water. The amount of subsurface water to be drained off in irrigated areas should therefore be based on the expected percolation fraction and not on the leaching requirement.

Salinity control can normally be achieved by draining off the percolation losses

Table 15.15 Long-term salinity of the rootzone, expressed as EC_e in dS/m

LF	0.025	0.05	0.10	0.20	0.25	0.40
$n (= 1/LF)$	40	20	10	5	4	2.5
EC_i 0.25 (dS/m)	5	2.5	1.2	0.6	0.5	0.3
0.5	10	5	2.5	1.2	1	0.6
1.0	20	10	5	2.5	2	1.2
2.0			10	5	4	2.5
4.0				10	8	5
6.0					12	7.5

and at the same time keeping the watertable at sufficient depth. If natural drainage and seepage can be neglected, the drain discharge will probably be in the following ranges (FAO 1980):

- Less than 1.5 mm/d: For soils with a low infiltration rate;
- 1.5-3.0 mm/d: For most soils, with the higher rate for more permeable soils and where cropping intensity is high;
- 3.0-4.5 mm/d: For extreme conditions of climate, crop, and salinity management, and under poor irrigation practices;
- More than 4.5 mm/d: For special conditions (e.g. rice irrigation on lighter-textured soils).

15.7 Sodium Hazard of Irrigation Water

15.7.1 No Precipitation of Calcium Carbonate

In Section 15.2.2, the relationship was shown between the exchangeable sodium of the adsorption complex of the soil, expressed by the ESP, and the ratio between sodium and calcium plus magnesium present in the soil solution, expressed by the SAR. The SAR is therefore also used to express the sodium hazard of irrigation water, but this does not mean that the SAR of the soil solution is equal to the SAR of the irrigation water, even in the absence of exchange or precipitation reactions. An increase in soil water concentration causes the SAR to increase in proportion to the square root of the concentration factor

$$SAR_{\text{soil water}} = \frac{n.Na_i}{\sqrt{\frac{n(Ca_i + Mg_i)}{2}}} = \sqrt{n}.SAR_i \quad (15.43)$$

Table 15.16 presents the ionic composition of the saline waters used in the water-quality test mentioned in Figure 15.25 and Table 15.12, and the relationship between ESP and SAR. The values of ESP and SAR are averages of the layer 0-0.40 m over a period of 4 years, during which the values increased slightly during summer and decreased during the rainy winter season. In Table 15.16, a good correlation appears between ESP and SAR_e, the ESP-values being slightly lower than the values calculated from SAR_e according to Equation 15.3. Since part of the water is provided by rainfall, the average concentration of the water applied equals 0.7 times (i.e. 1000/1400) that of the irrigation water and SAR_{i+p} = √0.7 SAR_i. The ratio between SAR_e and SAR_{i+p}, equalling √n, ranges around 1.5 and points towards a value between 2 and 2.5 for the concentration factor of the extract of the saturated paste.

15.7.2 Precipitation of Calcium Carbonate

Equation 15.43 for the relation between the SAR of soil water and the SAR of irrigation water holds true if there is no precipitation of salts. Irrigation waters often contain appreciable amounts of calcium and bicarbonate or even carbonate ions,

Table 15.16 Composition of saline waters used in water-quality test and relationship between ESP and SAR

		Water quality		
		B	C	D
K ⁺	(meq/l)	0.1	0.2	2.5
Na ⁺	(meq/l)	11.5	21.0	29.6
Ca ²⁺	(meq/l)	6.0	10.3	15.7
Mg ²⁺	(meq/l)	2.8	5.0	8.6
HCO ₃ ⁻	(meq/l)	1.6	2.2	2.6
Cl ⁻	(meq/l)	11.5	21.1	31.8
SO ₄ ²⁻	(meq/l)	7.1	13.1	20.3
C _{tot}	(meq/l)	20.3	36.5	55.6
EC	(dS/m)	2.1	3.5	5.2
ESP	(-)	6.7	7.8	8.8
SAR _e	(√meq/l)	7.4	8.5	9.5
SAR _i	(√meq/l)	5.5	7.5	8.5
SAR _{i+p}	(√meq/l)	4.6	6.2	7.0
SAR _e /SAR _{i+p}	(-)	1.6	1.4	1.4

which, upon concentration in soil water, precipitate as calcium carbonate. In Table 15.4a, it was shown that the solubility of CaCO₃ depends on carbon dioxide pressure and total concentration of dissimilar ions. Under average soil conditions it may be set between 5 and 10 meq/l.

For a more exact appraisal of the precipitation of CaCO₃ and the sodium hazard of irrigation water, the solubility of CaCO₃ can be determined with the graph of Figure 15.26, which is based on data published by Bower et al. (1965), who made use of earlier studies by Langelier in 1936. The chemical reactions involved are the following

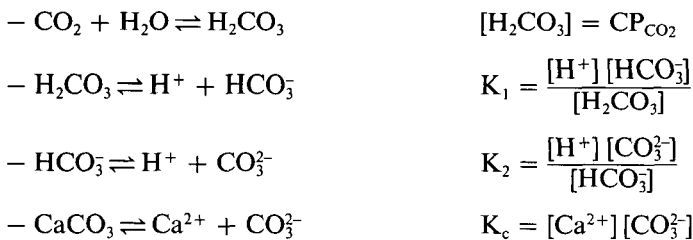

in which C is a constant, K₁ and K₂ represent dissociation constants, K_c the solubility product, and brackets denote ion activities. To convert ion activity into concentration, the Debye-Hückel correction is introduced on the right-hand axis of the graph. This correction depends on the total salt concentration of the solution, C_{tot}.

If the concentrations of Ca²⁺ and HCO₃⁻ are equal (e.g. when water not containing Ca²⁺ and HCO₃⁻ is brought into contact with solid CaCO₃), the solubility of CaCO₃ is found by selecting, on the right-hand axis, the appropriate combination of CO₂-

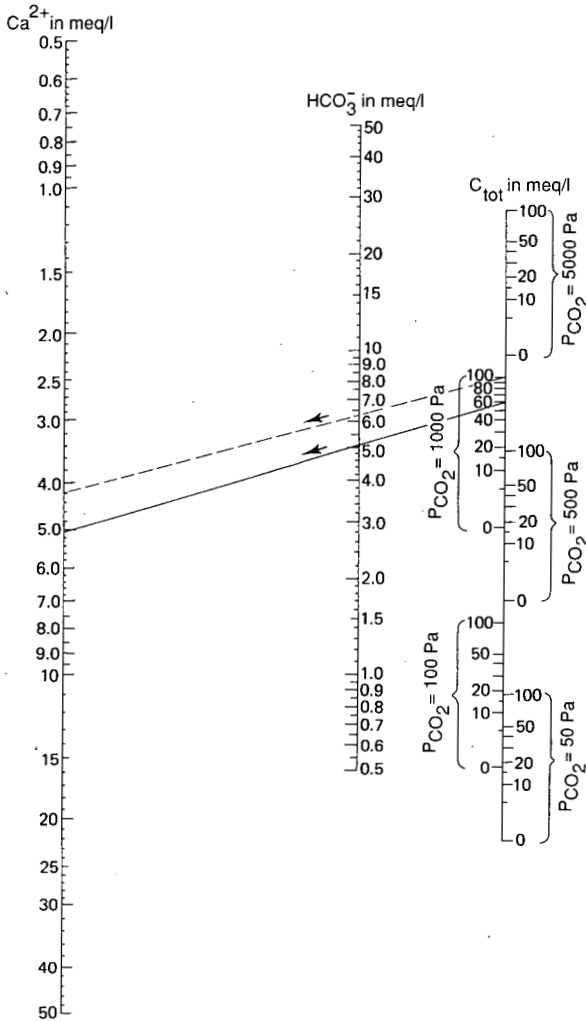

Figure 15.26 Equilibrium $\text{H}_2\text{O}-\text{CO}_2-\text{CaCO}_3$ at 25°C according to Langelier-Bower

pressure and total concentration of the solution. A straight line is drawn through this point in such a way that it intersects the Ca -axis and the HCO_3^- -axis at equal values. As an example, if $\text{P}-\text{CO}_2 = 1000 \text{ Pa}$ (corresponding with 1% of CO_2 in the soil air) and the total salt concentration of the soil solution $C_{\text{tot}} = 60 \text{ meq/l}$, one finds that the concentrations of both components are 5 meq/l (solid line in Figure 15.26). The data presented in Table 15.4a were obtained in this way.

If, in the solution, a difference exists between the concentration of Ca^{2+} and HCO_3^- , this difference will persist after precipitation. As precipitation occurs as CaCO_3 , each meq of Ca^{2+} takes away 1 meq of HCO_3^- (stoichiometric precipitation). As an example, let us take irrigation water with a total salt concentration of 22 meq/l , $3.6 \text{ meq/l Ca}^{2+}$, and $4.0 \text{ meq/l HCO}_3^-$. For a leaching fraction of 0.2, the soil water becomes five times

as concentrated, which would mean 18 meq/l Ca^{2+} and 20 meq/l HCO_3^- if there were no precipitation. This difference of 2 meq/l in favour of HCO_3^- will persist after precipitation. Thus for P- CO_2 equalling 1000 Pa and $C_{\text{tot}} = 100$ meq/l, one finds 6.2 meq/l HCO_3^- and 4.2 meq/l Ca^{2+} (dotted line in Figure 15.26).

The precipitation of slightly soluble salts has two effects:

- A favourable effect on total salinity: the total concentration will be lower than it would have been if all the salts had remained in solution;
- An unfavourable effect on the sodium hazard: the relative concentration of Na^+ increases, as does the SAR-value.

To take into account the precipitation of slightly soluble carbonate from irrigation water, Eaton (Richards 1954) developed the residual sodium carbonate or RSC concept. The RSC-value is defined as $(\text{HCO}_3^- + \text{CO}_3^{2-}) (\text{Ca}^{2+} + \text{Mg}^{2+})$, expressed in meq/l. On the basis of the RSC, Eaton presented the following classification of irrigation water:

- $\text{RSC} > 2.5$: Irrigation water not suitable;
- $1.25 < \text{RSC} < 2.5$: Irrigation water marginal;
- $\text{RSC} < 1.25$: Irrigation water probably safe.

This classification was considered tentative. And indeed, it appears that sometimes waters with higher RSC-values than indicated can be used without serious problems for soil structure and permeability.

In Eaton's experiments, only calcium and sodium were applied as cations. Calcium and magnesium are often determined together and are referred to as $\text{Ca} + \text{Mg}$ in the composition of irrigation waters. It is questionable, however, whether magnesium should be taken into account in evaluating the precipitation of carbonates. In irrigated soils under normal conditions, magnesium does not precipitate as magnesium carbonate (Suarez 1975). Magnesium probably precipitates together with calcium and is built into the crystal lattice of calcite. It is often found as an impurity in aragonite and calcite, two modifications of solid calcium carbonate.

Although Eaton's classification of waters by their RSC-value may not be correct, the RSC-value is still useful as a warning signal that the SAR of the soil solution may increase strongly, exceeding by far the normal increase proportional to the square root of the concentration factor. In the case of a positive RSC-value, the procedure presented in the next sections is more accurate and gives more insight into the SAR of the soil solution that might be expected.

15.7.3 Examples of Irrigation Waters containing Bicarbonate

We shall demonstrate the effect of the precipitation of bicarbonates by gradually concentrating irrigation water of the $\text{Ca}(\text{HCO}_3)_2$ type and of low salt concentration with an EC_i of 0.45 dS/m (Table 15.17). A 10-fold increase in concentration (Line 2) will cause Ca^{2+} to precipitate as carbonate. We can then approximate the equilibrium concentration of Ca^{2+} and HCO_3^- with the help of Figure 15.26, keeping in mind that the difference in concentration of Ca^{2+} (38 meq/l) and HCO_3^- (36 meq/l)

Table 15.17 Concentration of irrigation water in which $\text{Ca}(\text{HCO}_3)_2$ predominates ($P_{\text{CO}_2} = 1000 \text{ Pa}$)

	Composition (meq/l)						EC (dS/m)	SAR ($\sqrt{\text{meq/l}}$)
	Na	Ca	HCO_3	Cl	SO_4	C_{tot}		
1 Irrigation water	0.9	3.8	3.6	0.6	0.6	4.8	0.45	0.65
2 10-fold concentration, assuming no precipitation of salts	9	38	36	6	6	48	4.5	—
3 10-fold concentration after precipitation	9	5.8	3.8	6	6	15	1.2	5.2
4 20-fold concentration, assuming no precipitation of salts	18	76	72	12	12	96	9.0	—
5 20-fold concentration after precipitation	18	8	4	12	12	27	2.2	9.0

will remain constant. Taking, tentatively, $C_{\text{tot}} = 20$ for the concentration after precipitation, we find from the nomograph of Figure 15.26 that $\text{Ca}^{2+} = 5.8 \text{ meq/l}$ and $\text{HCO}_3^- = 3.8 \text{ meq/l}$ for a CO_2 pressure of 1000 Pa. The total concentration, found by adding the concentrations of cations, is now $C_{\text{tot}} = 15 \text{ meq/l}$ (Line 3). Figure 15.26 shows that if $C_{\text{tot}} = 15 \text{ meq/l}$ is used, the concentrations of Ca^{2+} and HCO_3^- differ only very slightly from those found for the earlier value of 20 meq/l.

The SAR-value, after a 10-fold concentration, is as low as 5.2. Even a 20-fold concentration of the irrigation water (Lines 4 and 5) will result in a fairly low salinity (EC 2.2 dS/m) and a reasonably low SAR-value of 9.0. A concentration factor of 20 means a leaching fraction of 0.05, which is certainly lower than the percentage of field irrigation losses. Waters of low total salt content that show an excess of calcium and magnesium with regard to bicarbonate, can be used without any danger of salinity or sodicity.

Table 15.18 shows irrigation water of the NaHCO_3 type, of low concentration, and seemingly of excellent quality (EC = 0.42 dS/m, SAR = 2.3). The dominance of HCO_3^- over Ca^{2+} , however, makes this water less suitable than originally supposed, its RSC-value being 0.9. If $P\text{-CO}_2 = 5000 \text{ Pa}$ (5% CO_2 in the soil air), a 5-fold increase in concentration is still acceptable, but a 10-fold increase would give rise to a high SAR. The equilibrium electrical conductivity of the soil water, EC_{fc} , will be only 1.5 dS/m, the EC_e -value equalling approximately $0.5\text{EC}_{\text{fc}} = 0.75 \text{ dS/m}$. This type of water causes high SAR-values, whereas the salinity of the soil remains low. This combination usually leads to the formation of non-saline, sodic soils.

15.7.4 Leaching Requirement and Classification of Sodic Waters

With irrigation water of low total salt concentration but containing sodium bicarbonate, the leaching requirement does not depend upon the salinity level of the

Table 15.18 Concentration of irrigation water in which NaHCO_3 predominates ($\text{P CO}_2 = 5000 \text{ Pa}$)

	Composition (meq/l)						EC (dS/m)	SAR ($\sqrt{\text{meq/l}}$)
	Na	Ca	HCO_3	Cl	SO_4	C_{tot}		
1 Irrigation water	2.5	2.4	3.3	1.3	0.5	5.0	0.42	2.3
2 5-fold concentration, assuming no precipitation of salts	12.5	12.0	16.5	6.5	2.5	25.0	2.1	—
3 5-fold concentration after precipitation	12.5	4.5	9.0	6.5	2.5	17.5	1.5	8.3
4 10-fold concentration, assuming no precipitation of salts	25	24	33	13	5	50	4.2	—
5 10-fold concentration after precipitation	25	3	12	13	5	29	2.4	20.4

soil but on its sodicity level. We can estimate the sodicity level of the soil, expressed by the SAR of the soil water, by concentrating the irrigation water while taking into account the precipitation of calcium carbonate. If calcium and magnesium are determined together, we can then use, as an approximation, the concentration of both cations, instead of calcium only, in the nomograph of Figure 15.26. A second approximation concerns the carbon dioxide pressure of the soil air. It depends upon depth, root activity, and organic matter content. We can estimate a range for the SAR-value of the soil water by assuming P- CO_2 -values of 1000 and 5000 Pa, the lower value being more representative for the tilled layer and the higher value for the soil at greater depth.

The permissible SAR-value of the soil water depends upon soil salinity, texture, and clay minerals, and upon the farmers' capacity to till to counteract an unfavourable soil structure. Tentatively, the SAR value can be put between 15 and 25 for the soil water at field capacity, but this has to be checked for local conditions.

As long as the permissible concentration factor is higher than 4 to 5, percolation losses of 0.20-0.25 will provide sufficient leaching for sodicity control. If the concentration factor appears to be lower, the farmer should not increase the water applications to provide more leaching because this may lead to excessive watering and yield depression due to water stagnating on the surface. A better solution to improve the unfavourable salt composition and the high SAR-value of the irrigation water is to apply amendments (e.g. gypsum) to the soil or the irrigation water, or to blend the irrigation water with water of better quality.

A high SAR-value is more dangerous than a high salt concentration, because it affects the permeability of the soil, which is the key to the leaching process. Sodic waters affect the structure and the permeability of the soil through their effects on the cation exchange complex. We need therefore only take the sodium hazard into account for soils in which the exchange capacity is large enough to affect the soil structure. In sand and loamy sand, the clay fraction is so small that the sodium hazard of irrigation water is not a factor to be reckoned with.

Table 15.19 Leaching fraction of bicarbonate waters calculated with Figure 15.26 ($\text{PCO}_2 = 1000 \text{ Pa}$)

	n	LF	Composition (meq/l)						SAR	RSC
			Na	Ca	Mg	HCO_3	$\text{Cl}+\text{SO}_4$	C_{tot}		
Irr. water	A1		3.5	0.7	0	3.3	0.9	4.2	5.9	2.6
Soil water		3.5	0.28	12.3	0.75	0	9.9	3.1	13.0	20
Irr. water	A2		3.5	0.35	0.35	3.3	0.9	4.2	5.9	2.6
Soil water		6.4	0.16	22.4	0.3	2.2	19.2	5.8	25.0	20
Irr. water	B1		9.4	1.7	0	7.1	4.0	11.1	10.2	5.4
Soil water		1.5	0.67	14.1	1.0	0	9.1	6.0	15.1	20
Irr. water	B2		9.4	0.85	0.85	7.1	4.0	11.1	10.2	5.4
Soil water		2.3	0.43	21.6	0.45	1.95	14.8	9.2	24.0	20
Irr. water	C1		3.3	0.2	0	1.1	2.4	3.5	10.4	0.9
Soil water		3.7	0.27	12.2	0.74	0	4.1	8.9	13.0	20
Irr. water	C2		3.3	0.1	0.1	1.1	2.4	3.5	10.4	0.9
Soil water		3.7	0.27	12.2	0.37	0.37	4.1	8.9	13.0	20

Table 15.19 presents the concentration factor and leaching fraction calculated with Figure 15.26 for three waters, under assumptions of a P-CO_2 of 1000 Pa and 20 as a limit for the SAR of the soil water. In the calculations, two approaches are followed:

- Calcium and magnesium are taken together for precipitation (Irr. water A₁, B₁ and C₁;
- Calcium and magnesium are separated into equal concentrations and magnesium does not precipitate (Irr. water A₂, B₂ and C₂).

The second approach leads to a higher concentration factor, except for water C, in which calcium does not even attain its solubility limit. The low concentration factor of water B corresponds well with its high RSC-value, indicating that this water cannot be used without amendments or blending. For water A, the concentration factor is rather low if we assume magnesium and calcium to precipitate together. Still, it can probably be used without serious problems since the leaching fraction of 0.28 is easily obtained in the top layer and the leaching requirement at greater depth is lower owing to the increased pressure of carbon dioxide and the higher solubility of calcium.

Although the RSC of water C is much lower than the RSC of water A, the concentration factor is about the same because of the very low calcium concentration. In this case, the SAR gives a much better indication of the sodium hazard than the RSC.

Another procedure for classifying irrigation waters was proposed by FAO (1985). It adapts the approach of Suarez (1981) and introduces an adjusted Sodium Adsorption Ratio to predict potential infiltration problems due to relatively high sodium or low calcium concentrations in the irrigation water.

$$\text{adj.}R_{\text{Na}} = \frac{\text{Na}}{\sqrt{\frac{\text{Ca}_x + \text{Mg}}{2}}} \quad (15.44)$$

in which

Na = sodium concentration of irrigation water (meq/l)

Ca_x = calcium concentration (meq/l), modified, according to Table 15.20, because of the EC of the irrigation water, its HCO₃⁻/Ca²⁺ ratio, and the estimated carbon dioxide pressure in the surface millimetres of the soil (70 Pa)

Mg = magnesium concentration of irrigation water (meq/l)

The adjusted R_{Na}, which predicts the SAR of the soil water near the surface, can be used instead of the SAR of the irrigation water to evaluate potential infiltration problems according to Table 15.21.

Table 15.20 Calcium concentration (Ca_x) in meq/l in near-surface soil water after irrigation with water of given HCO₃⁻/Ca ratio and EC_i (FAO 1985)

Ratio of HCO ₃ ⁻ / Ca	Salinity of applied water (EC _i) (dS/m)											
	0.1	0.2	0.3	0.5	0.7	1.0	1.5	2.0	3.0	4.0	6.0	8.0
.05	13.20	13.61	13.92	14.40	14.79	15.26	15.91	16.43	17.28	17.97	19.07	19.94
.10	8.31	8.57	8.77	9.07	9.31	9.62	10.02	10.35	10.89	11.32	12.01	12.56
.15	6.34	6.54	6.69	6.92	7.11	7.34	7.65	7.90	8.31	8.64	9.17	9.58
.20	5.24	5.40	5.52	5.71	5.87	6.06	6.31	6.52	6.86	7.13	7.57	7.91
.25	4.51	4.65	4.76	4.92	5.06	5.22	5.44	5.62	5.91	6.15	6.52	6.82
.30	4.00	4.12	4.21	4.36	4.48	4.62	4.82	4.98	5.24	5.44	5.77	6.04
.35	3.61	3.72	3.80	3.94	4.04	4.17	4.35	4.49	4.72	4.91	5.21	5.45
.40	3.30	3.40	3.48	3.60	3.70	3.82	3.98	4.11	4.32	4.49	4.77	4.98
.45	3.05	3.14	3.22	3.33	3.42	3.53	3.68	3.80	4.00	4.15	4.41	4.61
.50	2.84	2.93	3.00	3.10	3.19	3.29	3.43	3.54	3.72	3.87	4.11	4.30
.75	2.17	2.24	2.29	2.37	2.43	2.51	2.62	2.70	2.84	2.95	3.14	3.28
1.00	1.79	1.85	1.89	1.96	2.01	2.09	2.15	2.23	2.35	2.44	2.59	2.71
1.25	1.54	1.59	1.63	1.68	1.73	1.78	1.86	1.92	2.02	2.10	2.23	2.33
1.50	1.37	1.41	1.44	1.49	1.53	1.58	1.65	1.70	1.79	1.86	1.97	2.07
1.75	1.23	1.27	1.30	1.35	1.38	1.43	1.49	1.54	1.62	1.68	1.78	1.86
2.00	1.13	1.16	1.19	1.23	1.26	1.31	1.36	1.40	1.48	1.54	1.63	1.70
2.25	1.04	1.08	1.10	1.14	1.17	1.21	1.26	1.30	1.37	1.42	1.51	1.58
2.50	0.97	1.00	1.02	1.06	1.09	1.12	1.17	1.21	1.27	1.32	1.40	1.47
3.00	0.85	0.89	0.91	0.94	0.96	1.00	1.04	1.07	1.13	1.17	1.24	1.30
3.50	0.78	0.80	0.82	0.85	0.87	0.90	0.94	0.97	1.02	1.06	1.12	1.17
4.00	0.71	0.73	0.75	0.78	0.80	0.82	0.86	0.88	0.93	0.97	1.03	1.07
4.50	0.66	0.68	0.69	0.72	0.74	0.76	0.79	0.82	0.86	0.90	0.95	0.99
5.00	0.61	0.63	0.65	0.67	0.69	0.71	0.74	0.76	0.80	0.83	0.88	0.93
7.00	0.49	0.50	0.52	0.53	0.55	0.57	0.59	0.61	0.64	0.67	0.71	0.74
10.00	0.39	0.40	0.41	0.42	0.43	0.45	0.47	0.48	0.51	0.53	0.56	0.58
20.00	0.24	0.25	0.26	0.26	0.27	0.28	0.29	0.30	0.32	0.33	0.35	0.37
30.00	0.18	0.19	0.20	0.20	0.21	0.21	0.22	0.23	0.24	0.25	0.27	0.28

Table 15.21 Guidelines for infiltration problems (after FAO 1985)

SAR	EC _i (dS/m)		
	None	Slight-to-moderate	Severe
0 - 3	> 0.7	0.7 - 0.2	< 0.2
3 - 6	> 1.2	1.2 - 0.3	< 0.3
6 - 12	> 1.9	1.9 - 0.5	< 0.5
12 - 20	> 2.9	2.9 - 1.3	< 1.3
20 - 40	> 5.0	5.0 - 2.9	< 2.9

Table 15.22 Calculation of the adjusted R_{Na} of bicarbonate waters and classification with regard to infiltration problems

Irrigation water	EC _i dS/m	Ca meq/l	Mg meq/l	HCO ₃ /Ca	Ca _x meq/l	adj.R _{Na}	Problem
A1	0.4	0.7	0	4.7	0.68	6.0	Moderate
A2		0.35	0.35	9.4	0.44	5.6	Moderate
B1	1.1	1.7	0	4.2	0.80	14.8	Severe
B2		0.85	0.85	8.4	0.51	11.3	Moderate to severe
C1	0.35	0.2	0	5.5	0.62	5.9	Moderate
C2		0.1	0.1	11.0	0.40	6.6	Moderate to severe

For the irrigation waters in Table 15.19, Table 15.22 presents the calculation of the adjusted R_{Na} and the classification with regard to infiltration problems. The classification corresponds more or less with what could be expected from the leaching fraction calculated in Table 15.19. It should again be stressed that an SAR-value of 20, taken as a criterion for the soil water, and the guidelines proposed in Table 15.21, depend, besides salinity, on texture, clay minerals, and the tillage capacity of the farmer, and should therefore be checked under local conditions.

15.8 Reclamation of Salt-Affected Soils

15.8.1 General Considerations for Reclamation

Before starting with the reclamation of salt-affected soils, one needs answers to several questions:

- Does the soil contain soluble salts and what is the exchangeable sodium percentage?
- What is the cause of soil salinization? Is it due to the presence of a shallow watertable, poor quality irrigation water, or the presence of marine sediments?
- What are the physical characteristics of the soil? Is the soil coarse-, medium-, or fine-textured? What is the dominant clay mineral? What is the hydraulic conductivity in the top soil, the subsoil, and the substratum? What changes in soil physical behaviour are to be expected during leaching?

In salt-affected soils, a watertable is often present at shallow depth. If so, the first measure to be taken is to install a drainage system to control the watertable. The second measure is to apply irrigation water to leach the salts from the soil. Hence, other questions to be answered are:

- Is drainage technically feasible and economically justified?
- Is irrigation water available to leach the salts and, more importantly, to enable sustained agricultural production on the land once reclaimed?

Another problem to be solved is the presence of excessive amounts of exchangeable sodium, either in combination with poor soil structure or not. On this matter, the following questions need to be answered:

- Is the application of a chemical amendment needed, an amendment containing calcium, or a product that enhances the solubility of calcium carbonate if present in the soil?
- How much of the amendment is required?
- Is an amendment commercially and economically available?
- Which crops and what cropping pattern are to be selected for the reclamation period?

Adequate answers to the above questions will allow a decision to be made on whether or not to reclaim the land, and if so, whether to install drainage, leach the soils, and apply amendments.

A financial and economic appraisal is part of the decision-making process. It may turn out that, for one or more specific reasons, not reclaiming the land is the best alternative, particularly when the unreclaimed land has at least some production, e.g. as a meadow. The following case may serve as an illustration.

A survey of the salt-affected lands in the irrigated coastal valleys of Peru (Alva et al. 1976) indicated that, in 135 000 ha, salinization was classified as moderate to severe. The watertable fluctuated between 1.0 m to less than 0.3 m below soil surface. Reclamation was considered necessary for sustained agricultural production. On 45 000 ha, however, reclamation was assumed to be difficult, if not impossible, for a variety of reasons:

- A shortage of water;
- Flat topography and poor discharge conditions for drainage water, making the use of pump drainage likely;
- The land prone to inundation, thus requiring river training prior to reclamation;
- Poor soil conditions.

15.8.2 Leaching Techniques

Saline soils can be leached by ponding water on the field for long periods of time. This has been the traditional method; it is still common practice. Hence, leaching takes place under nearly saturated conditions.

In the past thirty years, many experiments have been conducted to compare the ponding method with intermittent leaching or leaching by sprinkler. With intermittent

leaching, water is not applied continuously but at intervals of one or two weeks during which the soil can dry out. Especially for clay soils, this method offers the advantage that cracks form during those intervals and salt is displaced by capillary movement from the interior of the soil aggregates towards the cracks. It is then washed out of the cracks during the next water application. Experimental data generally point towards water saving with intermittent or sprinkler leaching. Less water is needed to achieve the same degree of salt displacement. The amount of water required, however, is only one factor.

A second factor is the uniformity of salt removal. Saline areas are usually being drained prior to leaching. With ponding, more water is generally entering the soil than draining from it. The watertable will rise and will ultimately reach the soil surface. Then, hydrologically speaking, the ponded water case is attained, which means a fully saturated soil with water on the surface. From that moment onwards, the infiltration of water will be distributed unequally over the field, as shown in Figure 15.27, which presents the pattern of flow lines and equipotentials for the ponded water case. A large fraction of water will be infiltrating near the drain, but, further from it, infiltration will be almost negligible. Consequently, salt displacement from the area midway between drains will be less than close to the drains. A more equitable distribution of the infiltration can be obtained by making ridges parallel to the drains to prevent overland flow in the direction of the drains.

A third factor concerns the time required for reclamation, and the labour, supervision, and equipment involved. With intermittent leaching, more time may be required, although less water will be applied. Moreover, that method requires more labour and supervision, while sprinkler application requires special equipment.

The leaching techniques described above are based on the vertical migration of salts dissolved in excess water that percolates through the soil profile towards the watertable or the drain. Differing from this is surface flushing. With this technique, salt is displaced by water moving over the soil surface; hence, there is a lateral transport

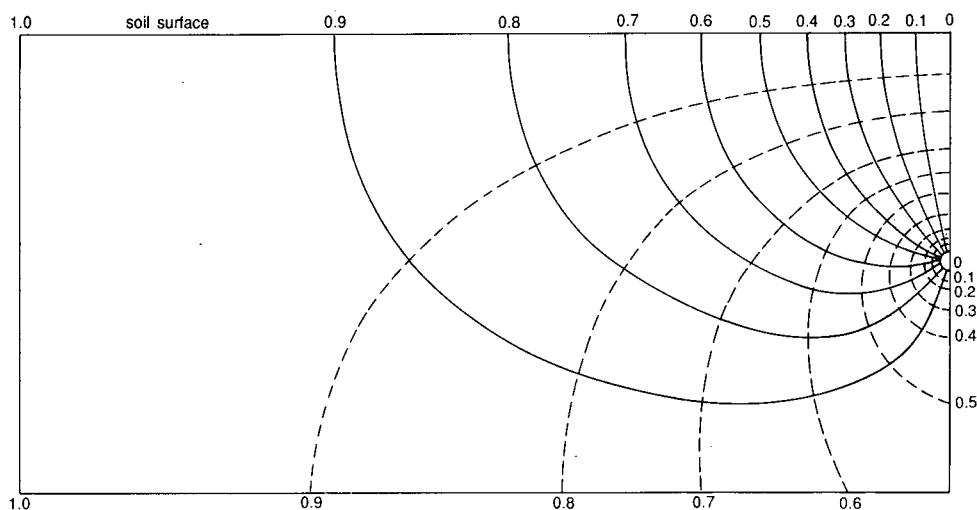

Figure 15.27 Flow lines (solid) and equipotential lines (dotted) in the ponded-water case

of salts. Surface flushing is sometimes used to remove visible crusts of salt on the surface of salt-affected soils. Experiments have shown that this method is not very effective. Nevertheless, hydrological conditions may be such that surface flushing is the only (economically feasible) technique. This is true in lowland rice cultivation on salt-affected coastal flats. In lowland rice areas, puddling is sometimes practised. With this technique, the soil is stirred with water impounded on the surface, and salts present in the topsoil dissolve. Before the rice is transplanted, the excess water is drained. It was found (De Wolf, after Van Alphen 1983) that 3-4 tons of salt per ha can be carried off in this way. Albeit a minute amount, it may mean the difference between a low level of crop production and crop failure.

Field conditions will determine what method of water application to select. If irrigation water is available abundantly and continuously or if rice can be planted as a reclamation crop, the ponding technique will be suitable. When water is scarce or expensive or when, upon completion of the reclamation, crops will be sprinkler irrigated, the intermittent water application or sprinkler technique will be the logical choice.

15.8.3 Leaching Equations

When saline soils are leached for reclamation, the leaching efficiency coefficient may differ considerably from one case to another because of differences in soil texture, structure, irrigation method, and rainfall. Moreover, saline soils often differ strongly in the salinity of their successive layers. The best way to describe the leaching of saline soils is therefore to consider the soil a more-than-one-layered profile and to take the leaching efficiency coefficient into account.

After the first application of irrigation water, we can assume that the soil water content is approximately at field capacity. The amount of irrigation water will then equal the amount of percolation water. If evaporation cannot be neglected, we can assume evaporation occurring at the soil surface and that the net amount of irrigation water I' equals $I - E$. For the salt concentration of the water entering the soil, we can write $C_i' = C_i I / I'$. Since, under these conditions, f_i equals f_r (Section 15.5.2), we can write

$$R = fR + (1 - f)R \quad (15.45)$$

$$RC_r = fRC_{fc} + (1 - f)RC_i \quad (15.46)$$

So

$$C_r = fC_{fc} + (1 - f)C_i \quad (15.47)$$

The leaching process will be illustrated with two theoretical models: a single reservoir with bypass and a series of reservoirs with bypass. We assume that there is no chemical or physical interaction between solute, solution, and soil.

The Single Reservoir with Bypass

We can consider the soil profile or the rootzone as a single one-dimensional reservoir. If mixing takes place in the reservoir and if the volume of water in the reservoir is

constant (inflow = outflow), the salt balance reads

$$C_i q dt = C_r q dt + W_{fc} dC_{fc} \quad (15.48)$$

where

- C_{fc} = average salt concentration of the reservoir solution (meq/l)
- C_i = concentration of the influent (meq/l)
- C_r = concentration of the effluent (meq/l)
- q = flow rate through the reservoir (mm/d)
- W_{fc} = water stored in the reservoir (mm)

Combining Equations 15.47 and 15.48 yields

$$-\frac{dC_{fc}}{C_{fc} - C_i} = \frac{fq}{W_{fc}} dt \quad (15.49)$$

Integration between the limits $C_{fc} = C_o$ at time $t = 0$ and C_t at time t yields

$$fqt = W_{fc} \ln \frac{C_o - C_i}{C_t - C_i} \quad (15.50)$$

which can also be written as

$$C_t = C_i + (C_o - C_i)e^{-fqT} \quad (15.51)$$

where

- C_o = salt concentration of the reservoir solution at time $t = 0$ (meq/l)
- C_t = salt concentration of the reservoir solution at time t (meq/l)
- T = time of residence (d), which equals W_{fc}/q

To calculate the amount of efficient leaching water, fqt , to obtain a specified C_t , we can use Equation 15.50, whereas the C_t that results from applying a specified amount of leaching water follows from Equation 15.51.

If we do not know the leaching efficiency coefficient, f , it can be estimated from measured values of C_i , C_o , and C_t . The relation between $(C_t - C_i)/(C_o - C_i)$, plotted on a logarithmic scale, and qt should yield a straight line, from which the leaching

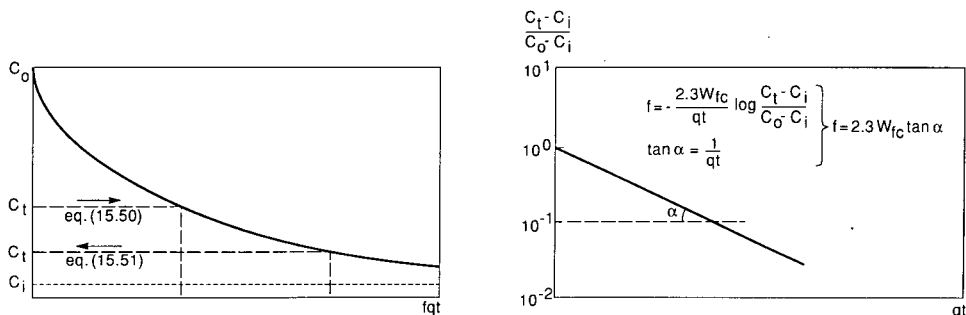

Figure 15.28 Leaching process in a single reservoir with bypass

efficiency coefficient can be calculated (Figure 15.28). If no straight line is obtained with a series of C_t data, this indicates a decrease in the f -value during the leaching process.

The salt concentrations, C (meq/l), in Equations 15.50 and 15.51 can be replaced by electrical conductivities, EC (dS/m). Note that for C_o and C_t the EC_{fc} needs to be substituted ($= 2EC_e$). How to calculate the amount of leaching water with Equation 15.50 is illustrated in the following example.

Example 15.4

Soil depth $D = 1000$ mm, $\theta_{fc} = 0.45$, $EC_e = 0.5EC_{fc}$, $f = 1$,
 $EC_i = 1$ dS/m, $(EC_e)_o = 20$ dS/m, $(EC_e)_t = 4$ dS/m, $q = 15$ mm/day.

Step 1 $W_{fc} = 0.45 \times 1000 = 450$ mm (Equation 15.14);

Step 2 $T = \frac{450}{15} = 30$ d;

Step 3 $fqt = 450 \ln \frac{(2 \times 20) - 1}{(2 \times 4) - 1} = 773$ mm (Equation 15.50) and

$$t = \frac{773}{1 \times 15} = 52 \text{ d.}$$

The Series of Reservoirs with Bypass

If the process of leaching is examined more closely, it will be clear that mixing over the entire depth of the rootzone (often 1 m and more) is not very probable. To take into account the limited range over which mixing is effective, we can suppose the soil to consist of different reservoirs (e.g. corresponding with the soil layers at depths of 0-0.20, 0.20-0.40, 0.40-0.60, and 0.60-0.80 m). Each reservoir receives the outflow from the overlying one. If the initial salt concentrations are the same for all the layers, the following expressions are found for the salt concentrations in successive reservoirs of equal volume

1st reservoir: $C_t^I = C_i + (C_o - C_i) e^{-ft/T}$

2nd reservoir: $C_t^{II} = C_i + (C_o - C_i) \left(1 + \frac{ft}{T}\right) e^{-ft/T}$

3rd reservoir: $C_t^{III} = C_i + (C_o - C_i) \left(1 + \frac{ft}{T} + \frac{f^2t^2}{2T^2}\right) e^{-ft/T}$

4th reservoir: $C_t^{IV} = C_i + (C_o - C_i) \left(1 + \frac{ft}{T} + \frac{f^2t^2}{2T^2} + \frac{f^3t^3}{6T^3}\right) e^{-ft/T}$

Nth reservoir: $C_t^N = C_i + (C_o - C_i) e^{-ft/T} \times \sum_{n=0}^{n=N-1} \left(1 + \frac{f^n t^n}{n! T^n}\right)$ (15.52)

where

$$n! = 1 \times 2 \times 3 \times \dots \times n$$

If the initial salt concentrations of the successive layers are different, the following equations are obtained

$$\begin{aligned}
\text{1st reservoir: } C_1^I &= C_i + (C_o^I - C_i) e^{-f t/T} \\
\text{2nd reservoir: } C_1^{II} &= C_i + (C_o^{II} - C_i) e^{-f t/T} + (C_o^I - C_i) \frac{f t}{T} e^{-f t/T} \\
\text{3rd reservoir: } C_1^{III} &= C_i + (C_o^{III} - C_i) e^{-f t/T} + (C_o^{II} - C_i) \frac{f t}{T} e^{-f t/T} \\
&\quad + (C_o^I - C_i) \frac{f^2 t^2}{2 T^2} e^{-f t/T} \\
\text{Nth reservoir: } C_1^N &= C_i + e^{-f t/T} \left\{ (C_o^I - C_i) \frac{f^{N-1} t^{N-1}}{(N-1)! T^{N-1}} + \right. \\
&\quad \left. (C_o^{II} - C_i) \frac{f^{N-2} t^{N-2}}{(N-2)! T^{N-2}} + \dots + (C_o^N - C_i) \right\} \quad (15.53)
\end{aligned}$$

How to calculate the leaching process with Equation 15.53 will be illustrated in the following example.

Example 15.5

The soil profile consists of four layers of 0.25 m each, with EC_{fc} -values of 12, 18, 24, and 28 dS/m to a depth of 1.0 m. It is leached by rainfall, for which we assume an f -value of 1. As $\theta_{fc} = 0.5$, the amount of soil water in a layer of 0.25 m equals 125 mm. Since $t/T = qt/W_{fc}$, we can calculate t/T from the rainfall, qt , and the amount of soil water, W_{fc} (125 mm). The desalinization is calculated as is shown in Table 15.23 for steps of 80 mm rainfall.

The same type of equations can be developed for more complicated cases (e.g. when the values of the leaching efficiency coefficient or the reservoir volume – the apparent density – are not constant but vary with depth). But then the equations become more complicated too and it is often simpler to use numerical methods.

Since leaching starts with a mixing of irrigation or rain water at concentration C_i with the soil water of the first soil layer (Layer 1) at concentration C_{s1} , the concentration of the soil solution of Layer 1 after mixing can be calculated with

$$aC_i + bC_{s1} = (a + b)C_{x1} \quad (15.54)$$

where

- a = the amount of influent water (mm)
- b = the amount of soil water in Layer 1 (mm)
- C_i = salt concentration of influent water (meq/l)
- C_{s1} = salt concentration of the soil water in Layer 1 (meq/l)
- C_{x1} = salt concentration of the soil solution of Layer 1 after mixing (meq/l)

If the amount of water retained in Layer 1 is equal to c mm, an amount $(a - c)$ with a concentration C_{x1} percolates into Layer 2 and mixes with its moisture. The concentration of the soil solution in Layer 2 after being mixed, C_{x2} , can be calculated in the same way

$$(a - c)C_{x1} + dC_{s2} = (a - c + d)C_{x2} \quad (15.55)$$

Table 15.23 Example of calculation with Equation (15.53) ($C_i = 0, f = 1$)

$$C_t^I = C_o^I e^{-t/T}$$

$$C_t^{II} = (C_o^{II} + C_o^I t/T) e^{-t/T}$$

$$C_t^{III} = (C_o^{III} + C_o^{II} t/T + C_o^I t^2/2T^2) e^{-t/T}$$

$$C_t^{IV} = (C_o^{IV} + C_o^{III} t/T + C_o^{II} t^2/2T^2 + C_o^I t^3/6T^3) e^{-t/T}$$

1. t/T	0.64	1.28	1.92	2.56	3.20	3.84	4.48	5.12
2. $t^2/2T^2$	0.21	0.82	1.84	3.28	5.12	7.37	10.04	13.14
3. $t^3/6T^3$	0.04	0.35	1.18	2.80	5.46	9.44	15.06	22.48
4. $e^{-t/T}$	0.52	0.27	0.14	0.07	0.04	0.02	0.01	0.00
5. C_o^I	12.0	12.0	12.0	12.0	12.0	12.0	12.0	12.0
6. $C_t^I = 5 \times 4$	6.3	3.3	1.8	0.9	0.5	0.3	0.1	0.07
7. C_o^{II}	18.0	18.0	18.0	18.0	18.0	18.0	18.0	18.0
8. 5×1	7.7	15.3	23.0	30.6	38.4	46.0	53.7	61.4
9. $7 + 8$	25.7	33.3	41.0	48.6	56.4	64.0	71.7	79.4
10. $C_t^{II} = 9 \times 4$	13.6	9.3	6.0	3.8	2.3	1.4	0.8	0.5
11. C_o^{III}	24.0	24.0	24.0	24.0	24.0	24.0	24.0	24.0
12. 7×1	11.5	23.0	34.6	46.1	57.6	69.2	80.6	92.2
13. 5×2	2.5	9.8	22.1	39.4	61.3	88.4	120.5	157.7
14. $11 + 12 + 13$	38.0	56.8	80.7	109.5	142.9	181.6	225.1	273.9
15. $C_t^{III} = 14 \times 4$	20.0	15.8	11.9	8.4	5.8	3.9	2.5	1.6
16. C_o^{IV}	28.0	28.0	28.0	28.0	28.0	28.0	28.0	28.0
17. 11×1	15.4	30.7	46.1	61.4	77.8	92.2	102.5	122.9
18. 7×2	3.8	14.7	33.1	59.0	92.0	132.7	180.7	236.5
19. 5×3	0.5	4.2	14.2	33.6	65.3	113.5	180.0	268.4
20. $16 + 17 + 18 + 19$	47.7	77.6	121.4	182.0	262.3	366.2	496.9	657.2
21. $C_t^{IV} = 20 \times 4$	25.2	21.6	17.8	14.0	10.7	7.9	5.6	3.9

where

d = amount of soil water in Layer 2 (mm)

To simplify the calculations (assuming the same conditions as in Example 15.5 and calculated with Equation 15.53), we suppose that:

- $C_i = 0$;
- Bulk density, and consequently θ_{fc} , is the same for all layers;
- All rainfall percolates through the entire soil profile, the soil not drying out between successive periods of rainfall, so $c = 0$ and $W_{fc} = b = d$.

We then obtain

$$\text{Layer } 0-0.25 \text{ m: } 125 \times 12 = (80 + 125)C_{x1} \rightarrow C_{x1} = 7.3 \text{ meq/l}$$

$$\text{Layer } 0.25-0.50 \text{ m: } 80 \times 7.3 + 125 \times 18 = (80 + 125)C_{x2} \rightarrow C_{x2} = 13.8 \text{ meq/l}$$

Table 15.24 shows the results of the calculations made with:

- The aid of Equation 15.53;

Table 15.24 Leaching of a soil profile by rainfall

EC – values calculated with Equation 15.53											
Layer in cm	Before leaching	After leaching with									
		80 mm	160 mm	240 mm	320 mm	400 mm	480 mm	560 mm	640 mm		
0 - 25	12.0	6.3	3.3	1.8	0.9	0.5	0.3	0.1	0.07		
25 - 50	18.0	13.6	9.3	6.0	3.8	2.3	1.4	0.8	0.5		
50 - 75	24.0	20.0	15.8	11.9	8.4	5.8	3.9	2.5	1.6		
75 - 100	28.0	25.2	21.6	17.8	14.0	10.7	6.9	5.6	3.9		

EC – values calculated with the numerical method (steps of 20 mm)											
Layer in cm	Before leaching	After leaching with									
		80 mm	160 mm	240 mm	320 mm	400 mm	480 mm	560 mm	640 mm		
0 - 25	12.0	6.6	3.7	2.0	1.1	0.6	0.3	0.2	0.1		
25 - 50	18.0	13.6	9.5	6.4	4.1	2.6	1.6	1.0	0.6		
50 - 75	24.0	20.0	15.9	11.1	8.8	6.2	4.3	2.8	1.9		
75 - 100	28.0	25.0	21.5	17.9	14.3	11.0	8.1	5.9	4.3		

EC – values calculated with the numerical method (steps of 20 mm)											
Layer in cm	Before leaching	After leaching with									
		80 mm	160 mm	240 mm	320 mm	400 mm	480 mm	560 mm	640 mm		
0 - 25	12.0	7.3	4.5	2.7	1.7	1.0	0.6	0.4	0.2		
25 - 50	18.0	13.8	10.1	7.2	5.1	3.5	2.4	1.6	1.1		
50 - 75	24.0	20.0	16.1	12.6	9.7	7.3	5.4	3.9	2.8		
75 - 100	28.0	24.9	21.5	18.0	14.8	11.9	9.4	7.3	5.5		

- The numerical method, taking steps of 20 mm;
- The numerical method, taking steps of 80 mm.

As is obvious from this table, the smaller the steps, the closer the results of the numerical method are to those obtained with Equation 15.53. In practice, the differences between them are almost negligible.

The main drawback in using the leaching equations is the unknown leaching efficiency coefficient, which, moreover, can change during the leaching process. The first salts washed out are those easily leached from the large pores; then follow the salts from the small pores, and finally those from the interior of the soil aggregates in 'dead-end' pores.

The best way to approach large reclamation projects is therefore to lay out field tests on the different soil types in the project area. These leaching tests can be conducted in large-diameter infiltrometers or by making ridges around small fields of about 10 m², depending upon the available facilities (e.g. the transport of water). The results of these tests can then be used to estimate the leaching efficiency coefficient and to calculate the leaching requirement for other saline soils in the project.

If no data are available, a rule of thumb often used is that 1 foot of soil needs 1 foot of water for desalinization. To reclaim highly saline soils ($EC_e > 40$ dS/m), Reeve et al. (1955) found as a rule of thumb that 80 and 90% of the salts are removed from the top 0.3 m of soil after a water percolation of 0.3 m and 0.6 m respectively. Experimental data often deviate from this rule. Figure 15.29 presents data from two leaching experiments:

- Dujailah, Iraq: loam to silty loam (Dieleman 1963);
- Chacupe, Peru: clay loam to clay (Alva et al. 1976).

In the Dujailah experiment, the soil was flooded to lower the salinity in the top soil. During the period of flooding, which took 7 days, a depth of water of about 140 mm had percolated through the soil profile. Then, at a ratio $R/D = 0.25$, a legume crop was planted and reclamation was continued.

In the Chacupe experiment, an initial leaching was applied. Over a period of 2 months, a depth of water of about 130 mm had percolated through the soil profile. Then, at a ratio $R/D = 0.20$, rice was planted. Crop yield was very low. A second rice crop was sown at a ratio $R/D = 1.2$, 14 months after the start of the experiment. This crop yielded satisfactorily.

Obviously, the depth of water required and the time needed for reclamation will vary from place to place, depending on:

- Soil properties: soil texture, soil structure, soil pore geometry, cracking phenomena, clay mineralogy, and physico-chemical behaviour of clays;
- Initial salt content and the chemical composition of the soluble salts. (In the above-mentioned experiments, the initial EC_e varied from 40-100 dS/m in Dujailah, and from 80-150 dS/m in Chacupe);
- Salt content and the chemical composition of the water used for leaching (rain or irrigation);
- Leaching technique and the scope for planting a salt-tolerant crop during reclamation.

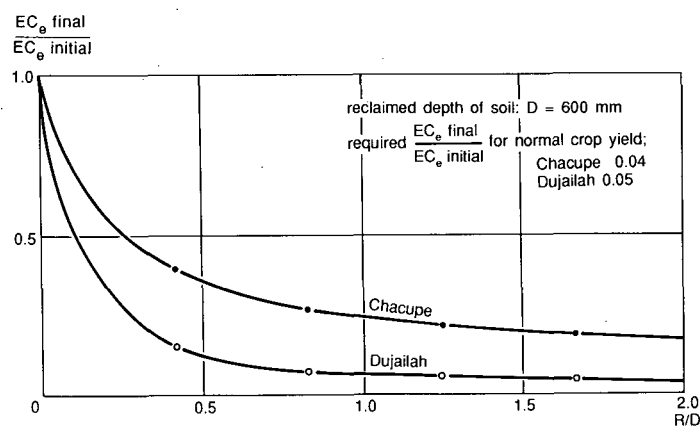

Figure 15.29 Leaching curves for a soil depth of 0.60 m

15.8.4 Chemical Amendments

The reclamation of sodic soils, particularly those that have a textural B horizon with the columnar soil structure (solonetz), is nearly always a time-consuming and often costly affair. These soils can be used for fishponds or rice cultivation. Minute amounts of salts may diffuse into the supernatant water or be removed by water percolating (if any) through the soil profile. In addition, some exchangeable sodium may be removed from the soil. Also, crops other than rice, but tolerant to exchangeable sodium and poor soil structure, can be planted. There are various grasses that still grow well under such conditions. These crops improve the soil, albeit at a slow rate, through the activity of their roots. Root activity and organic matter enhance the solubility of calcium carbonate, which, if present in the soil, makes calcium available to exchange for sodium. In all, however, the reclamation of sodic soils through fishponds or through the cultivation of rice or other crops tolerant to exchangeable sodium is a slow process, usually taking many years.

Saline sodic soils often show a good soil structure at first. After drainage and an initial leaching, when a large portion of the salts has been removed from the topsoil, the breakdown of soil structure becomes evident: the infiltration rate decreases, the process of leaching is slowed down, and the reclamation period is prolonged.

To speed up the reclamation of sodic soils or to avoid the breakdown of soil structure in saline sodic soils, chemical amendments can be applied (Abrol et al. 1988). These products should either contain a source of soluble calcium or should enhance the solubility of calcium carbonate if present in the soil.

Amendments of the second category are organic matter, sulphur, pyrites, or acid waste products such as pressmuds and waste sulphuric acid. Their application is limited to soils containing CaCO_3 . Pyrite and sulphur are most frequently used. Upon oxidation, which is a microbiological process, sulphuric acid is formed as a transitional product. It reacts with and dissolves the calcium carbonate in the soil, forming gypsum, which is a rather soluble source of calcium. The oxidation of sulphur takes some time, particularly if the living conditions for the bacteria involved are adverse.

Amendments containing a soluble source of calcium are calcium chloride, gypsum and phosphor-gypsum. Calcium chloride, being hygroscopic, is rather difficult to handle. Phosphor-gypsum is a by-product of factories producing phosphoric acid. It contains 80-90% calcium sulphate and, when dry, is a fine powder-like material. It was found to be very effective in reclaiming sodic soils (Mehta 1983).

The amendment most frequently used in the reclamation of saline sodic and sodic soils is gypsum. It is found in many places in the world and is a waste product of some industries. The quantity of gypsum required can be calculated with Equation 15.56

$$S_D = \frac{8.61 (\text{ESP}_a - \text{ESP}_f) \text{CEC } D \rho_b}{1000 f} \quad (15.56)$$

where

S_D = the amount of gypsum required in a layer of D m (ton/ha)

- D = the depth over which soil structure has to be improved or be prevented from breakdown (m). As soil structure in the topsoil is most prone to deterioration due to the mechanical impact of farm implements, rainfall, or irrigation water, a D-value varying between 0.1 and 0.3 m is usually taken
- ρ_b = the bulk density of the soil (kg/m^3)
- ESP_a = the actual exchangeable sodium percentage as found from laboratory analysis
- ESP_f = the final exchangeable sodium percentage to be arrived at after reclamation. ESP_f is usually set at 5-10
- CEC = the cation exchange capacity (meq/100 g of soil)
- f = efficiency of the gypsum application (%)

The efficiency of a gypsum application depends on various factors:

- Not all of the gypsum will be used to replace sodium; some of it will replace other cations like Mg and K;
- The distribution of gypsum will be irregular (i.e. there is a non-uniform spreading);
- Part of the gypsum will be transported with the percolating water into the subsoil, and will not replace sodium in the topsoil. This phenomenon may be more pronounced in soils rich in soluble sodium chloride. This salt enhances the solubility of gypsum (see Table 15.4b);
- The fineness of the gypsum (Mehta 1983);
- The type of soluble salts present in the soil solution (Alva et al. 1976; Dahiya et al. 1982).

The efficiency of the gypsum dressing is in the order of 40-70%. From a systematic monitoring of the reclamation of soils inundated with sea water in The Netherlands, it was concluded that the maximum efficiency arrived at was 50% (Van der Molen 1957).

The amount of gypsum required, as calculated with Equation 15.56, may serve as a guideline. If a large amount of gypsum is required, applying it in one single dose is of little use because of its rather low solubility. For instance, an application of 20 ton/ha of gypsum would require a quantity of 10 000 m³ of water to dissolve it. This represents a layer of water of 1000 mm, a quantity that is often more than applied in one cropping season. There is no consensus on whether gypsum should be incorporated into the soil or not. A top-dressing was advocated in the reclamation of the inundated soils in The Netherlands (Van der Molen 1957). In this way, the gypsum would regenerate the upper few centimetres of the soil, making it less sensitive to the impact of raindrops.

Top-dressed gypsum, particularly when fine particles are used (less than 0.25 mm), is displaced with the irrigation water towards the lower part of the field (Alva et al. 1976). Incorporating the gypsum into a dry soil to a depth of 0.05-0.10 m gave the best results. As part of a package of practices for the reclamation of sodic soils in Northern India (Mehta 1983), it was advocated that the gypsum be applied on a well-prepared but dry soil (viz. prior to the onset of the rainy season). Incorporation may not be necessary.

References

- Abrol, I.P., J.S.P. Yadav and F.I. Massoud 1988. Salt-affected soils and their management. *Soils Bulletin* 39. FAO, Rome, 131 p.
- Alva, C.A., J.G. van Alphen, A. de la Torre and L. Manrique 1976. Problemas de drenaje y salinidad en la Costa Peruana. *ILRI Bulletin* 16 (in Spanish), Wageningen, 116 p.
- Biggar, J.W., and D.R. Nielsen 1960. Diffusion effects in miscible displacement occurring in saturated and unsaturated porous materials. *J. of Geophys. Res.* 65, pp. 2887-95.
- Bower, C.A., L.V. Wilcox, G.W. Akin and M.G. Keyes 1965. An index of the tendency of CaCO_3 to precipitate from irrigation waters. *Soil Sci. Soc. Am. Proc.*, 29, pp. 91-92.
- Dahiya, I.S., R.S. Malik, and M. Singh 1982. Reclaiming a saline-sodic sandy loam soil under rice production. *Agric. Water Management* 5, pp. 61-72.
- Dieleman, P.J. (ed.) 1963. Reclamation of salt-affected soils in Iraq. *ILRI Publication* 11, Wageningen, 175 p.
- FAO 1980. Drainage design factors. *Irrigation and Drainage Paper* 38. Rome, 52 p.
- FAO 1985. Water quality for agriculture. *Irrigation and Drainage Paper* 29, Rev. 1, FAO, Rome, 174 p.
- FAO 1988. FAO-Unesco soil map of the world. Revised legend. *World Soil Resources report* 60, FAO, Rome, 119 p.
- FAO-Unesco 1973. Irrigation, drainage, and salinity : An international source book. *Hutchinson/FAO/Unesco*, London, 510 p.
- FAO-Unesco 1974. Soil map of the world 1:5 000 000. Volume I legend. *Unesco*, Paris, 59 p.
- Mehta, K.K. 1983. Reclamation of alkali soils in India. *Oxford and IBH Publishing Co.*, New Delhi.
- Reeve, R.C., A.F. Pillsbury and L.V. Wilcox 1955. Reclamation of a saline and high boron soil in the Coachella valley of California. *Hilgardia* 24, pp. 69-91.
- Richards, L.A. (ed.) 1954. Diagnosis and improvement of saline and alkali soils. *USDA Agric. Handbook* 60. Washington, 160 p.
- Rijtema, P.E. 1969. Soil moisture forecasting. *Nota* 513. Institute for Land and Water Management Research, Wageningen, 18 p.
- Suarez, D.L. 1975. Precipitation of magnesium carbonates. *Annual Report of the U.S. Salinity Laboratory*. USDA, Riverside, California.
- Suarez, D.L. 1981. Relation between pH_c and sodium adsorption ratio (SAR) and an alternative method for estimating SAR of soil or drainage waters. *Soil Sci. Soc. Amer. J.* 45, pp. 469-475.
- Unesco 1970. Research and training on irrigation with saline water. *Tech. Report of UNDP Project*, Tunisia 5. *Unesco*, Paris, 256 p.
- USDA 1975. Soil taxonomy : A basic system of soil classification for making and interpreting soil surveys. *Agric. Handbook* 436, Washington, 754 p.
- Van Alphen, J.G. 1983. Rice in the reclamation of salt-affected soils. *Seminar on Ecology and management of problem soils in Asia. Bangkok Proceedings*.
- Van Hoorn, J.W. 1979. The effect of capillary flow on salinization and the concept of critical depth for determining drain depth. In: J. Wesseling (ed.). *Proceedings of the international drainage workshop*. *ILRI Publication* 25, Wageningen: pp. 686-700.
- Van Hoorn, J.W. 1981. Salt movement, leaching efficiency, and leaching requirement. *Agr. Water Management* 4, pp. 409-428.
- Van der Molen, W.H. 1957. The exchangeable cations in soils flooded with sea water. *Versl. Landbouwk. Onderz.* 63.17. The Hague, 167 p.

16 Analysis of Water Balances

N.A. de Ridder¹† and J. Boonstra¹

16.1 Introduction

Analyses of water balances are necessary to calculate an area's drainable surplus (drainage requirement), which we define here as the quantity of water that flows into the groundwater reservoir in excess of the quantity that flows out under natural conditions. Removing the drainable surplus has two advantages: it prevents waterlogging by artificially maintaining a sufficiently deep watertable and it removes enough water from the root zone so that any salts brought in by irrigation cannot reach a concentration that would be harmful to crops.

Calculating the drainable surplus is a major problem in many irrigation and reclamation areas. The natural conditions in these areas are diverse, and different water resources may be involved in the calculations. It is therefore necessary to do field work on the general features of the groundwater regime and to study the water and salt regimes and their balances. A proper understanding of these regimes allows the drainage engineer to predict how they will be affected by drainage and reclamation works.

The factors involved in calculating the drainable surplus are derived from analysis of the overall water balance of the study area. The balance method, however, can be used only if it is possible to determine directly all components of the water and salt balance with sufficient accuracy. If the results of several independent balance analyses do not agree, the drainage engineer can compare the degree of discrepancy to get an idea of the reliability of the obtained data and to see if further observation and verification are necessary.

This chapter starts with a description of the different elements of water balance equations and goes on to discuss the water balance of the unsaturated zone, the surface water balance, the groundwater balance, and the integrated water balance. Salt balances are discussed briefly in a subsequent section. (See Chapter 15 for a more detailed treatment of salt balances in the root zone in irrigated soils.) A brief explanation of numerical groundwater models is included in Section 16.4. The chapter concludes with a few examples of water balance analysis.

16.2 Equations for Water Balances

The water balance is defined by the general hydrologic equation, which is basically a statement of the law of conservation of mass as applied to the hydrologic cycle. In its simplest form, this equation reads

$$\text{Inflow} = \text{Outflow} + \text{Change in Storage} \quad (16.1)$$

Water balance equations can be assessed for any area and for any period of time.

¹ International Institute for Land Reclamation and Improvement

It is worth noting that the word 'area' is commonly used in the professional jargon to mean 'volume', i.e. a certain part of a three-dimensional flow domain. The process of 'making an overall water balance for a certain area' thus implies that an evaluation is necessary of all inflow, outflow, and water storage components of the flow domain as bounded by the land surface, by the impermeable base of the underlying groundwater reservoir, and by the imaginary vertical planes of the area's boundaries.

The water balance method has four characteristic features. They are:

- A water balance can be assessed for any subsystem of the hydrologic cycle, for any size of area, and for any period of time;
- A water balance can serve to check whether all flow and storage components involved have been considered quantitatively;
- A water balance can serve to calculate the one unknown of the balance equation, provided that the other components are known with sufficient accuracy;
- A water balance can be regarded as a model of the complete hydrologic process under study, which means it can be used to predict what effect the changes imposed on certain components will have on the other components of the system or subsystem.

16.2.1 Components of Water Balances

Time

Water balances are often assessed for an average year. But waterlogging and salinity problems are not of the same duration or frequency throughout the world. In some regions, they are permanent (e.g. in marshy areas, which are topographic depressions with a permanently high watertable caused by a combination of surface and subsurface inflow). In others, they are temporary (e.g. in areas of incidentally high rainfall or in irrigation areas that receive large quantities of surface water only during the irrigation season). In both cases, the watertable rises to an unacceptable level because the natural drainage of the area cannot cope with the excessive recharge of the groundwater reservoir.

If the watertable remains high for long periods, crop yields will diminish. In areas where waterlogging occurs, it is necessary to assess water balances not only for an average year, but also for specific years and even for specific seasons (e.g. the growing season, the irrigation season, or, in irrigation areas in arid and semi-arid climates, the period of leaching the soil to prevent salinization).

Flow Domain

Let us say that we want to make a water balance study of a certain surface area. We can choose from two types of flow domains. They are:

- Flow domains comprising physical entities (e.g. river catchments and groundwater basins);
- Flow domains comprising only parts of physical entities (e.g. irrigation schemes and areas with shallow watertables).

Let us assess the water balance of the river catchment shown in Figure 16.1. Suppose

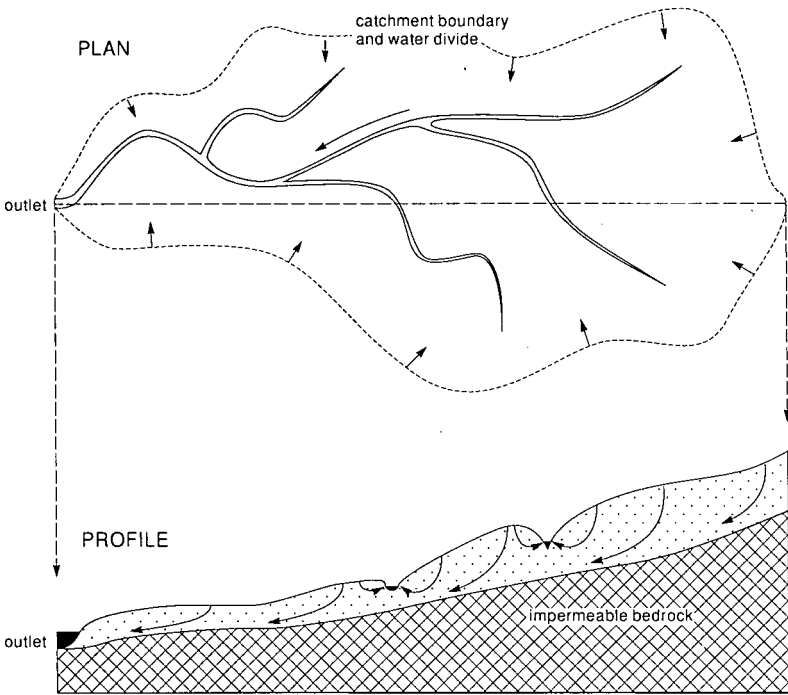

Figure 16.1 River catchment with a single outlet in bedrock

that field work has shown that the boundary of the catchment coincides with the groundwater divide. The divide can be regarded as an impermeable boundary because no groundwater flows across it.

Let us assume that the area lies in a humid climate, where changes in water storage usually follow an annual cycle. By choosing dates that are one year apart when we decide the beginning and the end of the period for which the water balance is to be assessed, we can usually ignore the change in water storage. Rainfall is measured at several meteorological stations in the catchment. The runoff from the area is measured at the outlet. Because impermeable bedrock comes close to the land surface at the outlet, preventing groundwater outflow, all water from the catchment area leaves the area as stream flow.

The overall water balance equation for the area then reads

$$\text{Rainfall} - \text{River Outflow} = \text{Evapotranspiration} \tag{16.2}$$

From this equation we can solve the unknown evapotranspiration. Dalton (1802) was among the first to use a catchment water-balance method to correlate the measured rainfall and streamflow data with the estimated evaporation data for England and Wales, as reported by Dooge (1984). It should be noted that Equation 16.2 is a strongly simplified version of the general water balance equation presented in Section 2.5.

Artificially determined areas such as irrigation areas and areas in need of drainage usually cover only part of a river catchment or groundwater basin. Therefore, it is

necessary to account for surface and subsurface inflow and outflow across the vertical planes of the boundaries of these areas. If we determine all their inflow, outflow, and water storage components, we can assess the overall water balance. This is how water balance studies for subsurface drainage are usually done.

In overall water balances, we consider the flow domain vertically – from the soil surface to the impermeable base of the groundwater reservoir. The impermeable base may consist of massive hard rock or of a clay layer whose permeability for vertical flow is so low that it can be regarded as impermeable. (These are the aquicludes mentioned in Chapter 2.) Three reservoirs occur in this flow domain: at the surface itself, in the zone between the surface and the watertable, and in the zone between the watertable and the impermeable base. Because the reservoirs are hydraulically connected, it is often necessary to assess partial water balances for each of them in order to specify the drainable surplus. These water balances are referred to here as the surface water balance, the water balance of the unsaturated zone, and the groundwater balance. We shall discuss them in more detail in the sections that follow.

It is important to note that, at certain depths, there can be clay layers that behave more like aquitards than like aquicludes. The occurrence of these aquitards implies the presence of one or more confined aquifers underneath. In principle, then, it is possible to consider either a multiple aquifer system as a whole or the shallow aquifer alone. In water balance studies for subsurface drainage, it is common to consider only the shallow aquifer. This approach makes it necessary to consider the possible interaction between the deeper, confined water and the shallow, unconfined water.

16.2.2 Water Balance of the Unsaturated Zone

For any drainage study, it is absolutely essential to understand the water regime in the unsaturated zone, which extends from the land surface to the watertable. It is in this zone that favourable conditions for crop growth must be created.

Some components of a water-balance study of the unsaturated zone are (Chapter 11):

- Determine the soil-water storage;
- Assess the soil-water balance and define the relation between it, the water balance of the underlying saturated zone (zone below the watertable), and the hydrometeorological factors;
- Assess the infiltration, evaporation and evapotranspiration, seepage and percolation, and groundwater movement (Chapters 4, 5, and 9).

Clearly, for large areas, the time and money necessary to conduct such a study would be prohibitive. It would be better to do the research on balance plots or in a pilot area whose soil and hydrology are representative of conditions in the surrounding area.

The unsaturated zone consists of pores that are filled partially with water and partially with air. It can be referred to sometimes as the aeration zone or the vadose zone (a term derived from the Latin word *vadosus*, meaning 'shallow'). The name 'unsaturated' can be misleading because there are portions of the zone that may actually be saturated even though the pressure of the water is below atmospheric

pressure. Examples of saturated portions are the capillary fringe above the watertable (Chapter 7), the rain-saturated topsoil, and the saturated layers of clay that hold water more tightly than the underlying coarser sediments.

Figure 16.2 shows the three subzones of the unsaturated zone: the soil-water zone, the intermediate vadose zone, and the capillary fringe. The soil-water zone extends from the surface down through the major root zone of crops and vegetation. It is not saturated except for the times when the land surface receives water from precipitation or (in irrigated areas) for irrigation. Its thickness varies with soil type and with the types of crops and vegetation, ranging from less than one metre to several metres.

The intermediate vadose zone extends from the lower boundary of the soil-water zone to the upper limit of the capillary fringe. Its thickness varies from zero in areas with a shallow watertable to many tens of metres in areas with a deep watertable. Any excess water from rain or irrigation that has escaped evapotranspiration in the overlying soil-water zone, passes the intermediate vadose zone as piston flow and eventually reaches the watertable, i.e. the zone of saturation. In areas with a shallow watertable, the boundary zones merge and we can ignore the processes occurring in the intermediate vadose zone.

The capillary fringe extends from the watertable up to the maximum height of capillary rise, which varies with soil texture (Table 16.1). This table shows that the thickness of the capillary fringe varies inversely with the grain size of the soil. Just above the watertable, almost all the pores contain water. At a somewhat higher level, only the smaller, connected pores contain water. Higher still, only the smallest of these contain water. Note that the water pressure in the capillary fringe is less than

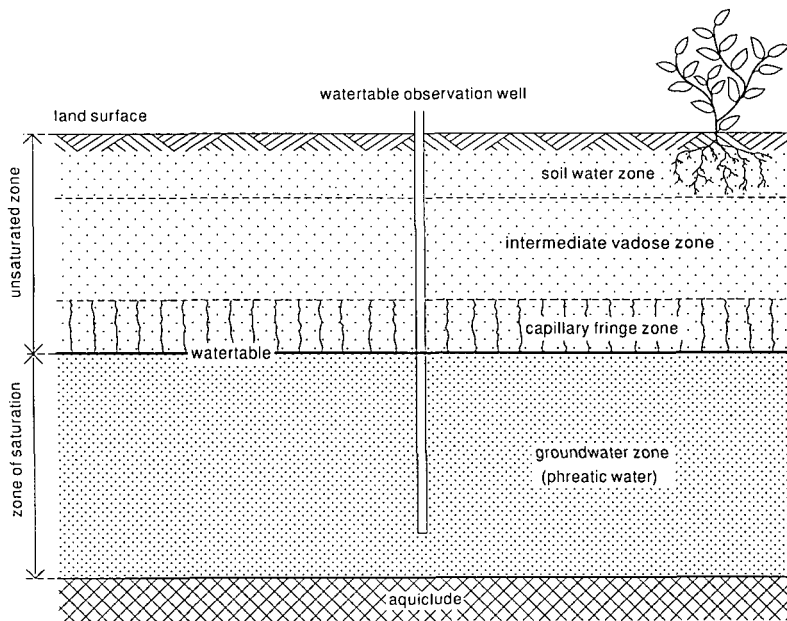

Figure 16.2 Three subzones of the unsaturated zone

Table 16.1 Capillary rise in different soils (after Lohman 1972)

Soil type	Grain size mm		Capillary rise mm
Fine gravel	2	- 5	25
Very coarse sand	1	- 2	65
Coarse sand	0.5	- 1	135
Medium sand	0.2	- 0.5	246
Fine sand	0.1	- 0.2	428
Very fine sand	0.005	- 0.1	1055
Coarse silt	0.002	- 0.005	>2000

atmospheric, which means that water from this zone will not flow into a well, drain, or open borehole.

In areas with a shallow watertable, the capillary fringe may extend into the root zone of the crops and vegetation. A vertical flux from the saturated zone may then develop and move up into the unsaturated zone, from where it is removed by evapotranspiration. The rate of capillary rise, and the subsequent evaporation at the surface, decrease as the depth of the watertable increases.

Infiltrating rain and irrigation water increase the soil-water content and can cause the watertable to rise. The time required for the infiltrating water to reach the watertable increases in proportion to the depth of the watertable. Clearly then, if we want to assess the water balance of the unsaturated zone, we must consider all waters that infiltrate into it due to precipitation, irrigation, and seepage. We must know not only the maximum water-holding capacity of the soil, but also the amount of moisture stored in the zone, the actual rate of evapotranspiration of the crops, the percolation to the groundwater, and the rate of capillary rise from the groundwater.

The water balance of the unsaturated zone reads

$$I - E + G - R = \frac{\Delta W_u}{\Delta t} \quad (16.3)$$

where

- I = the rate of infiltration into the unsaturated zone (mm/d)
- E = the rate of evapotranspiration from the unsaturated zone (mm/d)
- G = the rate of capillary rise from the saturated zone (mm/d)
- R = the rate of percolation to the saturated zone (mm/d)
- ΔW_u = the change in soil water storage in the unsaturated zone during the computation interval of an equivalent layer of water (mm)
- Δt = the computation interval of time (d)

The common assumption is that the flow direction in the zone is mainly vertical, so no lateral flow components occur in the water balance.

In Figure 16.3, a rise in the watertable Δh (due to downward flow from, say, infiltrating rainwater) is depicted during the time interval Δt . Conversely, during a period of drought, we can expect a decline in the watertable due to upward flow from capillary rise and to subsequent evapotranspiration by the crops and natural

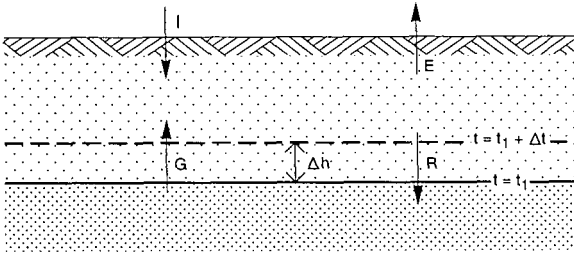

Figure 16.3 Water balance components of the unsaturated zone

vegetation. In both situations, it should be certain that the position of the watertable at the beginning and the end of the time interval is what accounts for the change in the volume of the unsaturated zone and for the inherent change in soil-water storage.

Note that in areas with deep watertables, the component G will disappear from the water balance equation of the unsaturated zone.

Most of the components of Equation 16.3 cannot be measured in the field. Some components can be assessed only from combinations of other, partial water balances.

16.2.3 Water Balance at the Land Surface

Because the rate of infiltration (I) in Equation 16.3 is the recharge into the unsaturated zone, its value is related to the inflow and outflow components of the surface water balance. These components are:

- Water that reaches the land surface from precipitation;
- Water that enters the water balance area by lateral surface inflow and leaves it by lateral surface outflow;
- Water that evaporates from the land surface.

The difference between the components is due to changes in surface water storage. Infiltration in the unsaturated zone can therefore be expressed by the following equation

$$I = P - E_o + 1000 \frac{Q_{si} - Q_{so}}{A} - \frac{\Delta W_s}{\Delta t} \quad (16.4)$$

where

- P = precipitation for the time interval Δt (mm)
- E_o = evaporation from the land surface (mm/d)
- Q_{si} = lateral inflow of surface water into the water balance area (A) (m^3/d)
- Q_{so} = lateral outflow of surface water from the water balance area (A) (m^3/d)
- A = the water balance area (m^2)
- ΔW_s = the change in surface water storage (mm)

Note that we can make a water balance analysis very much simpler by selecting a suitable area and a suitable time period. For example, if we choose a rainy period, we shall not have to consider evaporation. Conversely, if we choose a dry period,

precipitation can be eliminated. We can select an area without any inflow and outflow of surface water, or we can select a time period that has the same surface water storage at the beginning and end.

In irrigated areas, the major input and output of a water balance are usually determined by two artificial components, namely the application of water for irrigation and (in arid zones) for leaching the soil, and the removal of excess irrigation water (surface drainage) and excess groundwater (subsurface drainage).

Figure 16.4 shows the components of the surface water balance in an area of basin irrigation. On the left, an irrigation canal delivers surface water to an irrigation basin (Q_{ib}). A portion of this water is lost through evaporation to the atmosphere (E_{ob}). Another portion infiltrates at the surface of the basin (I_b), increasing the soil-water content in the unsaturated zone. Any surface water that is not lost through either evaporation or infiltration is discharged downslope by a surface drain (Q_{ob}). Both the irrigation canals and the surface drains lose water through evaporation ($E_{oc} + E_{od}$) to the atmosphere and through seepage to the zone of aeration ($I_c + I_d$).

We can still describe the surface water balance in this area with Equation 16.4 if we substitute ($Q_{ic} + Q_{id}$) for Q_{si} , and ($Q_{oc} + Q_{od}$) for Q_{so} . Note that infiltration (I) now comprises the combined effect of the infiltration of rainfall, the infiltration of irrigation water at the fields, and the seepage losses of the irrigation canals and the surface drains to the unsaturated zone. Note also that E_o comprises not only evaporation of rainwater that did not infiltrate into the soil, but also evaporation of water in canals, basins, and drains.

In other areas, irrigation is practised with borders, furrows, sprinklers, and (where the terrain is sloping) contour line ditches. In principle, we use the same components to make surface water balances for these areas as we did for basin irrigation areas.

Other examples of surface water balances are discussed in Chapter 4, where the curve number method is based on $I = P - Q_{so} - \Delta W_s$ (where $\Delta W_s = E_o$ after the rain has ceased), and in Chapter 15, where effective irrigation water (I_i) and effective precipitation (P_e) in the water balance of the irrigated soil can be assessed from Equation 16.4 (where $I = I_i + P_e$).

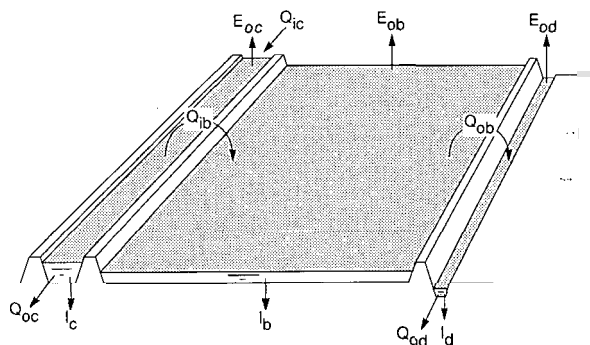

Figure 16.4 Surface water balance components for a basin-irrigated area

16.2.4 Groundwater Balance

The water balance for the saturated zone, also called the groundwater balance, can generally be expressed as follows (see Figure 16.5)

$$R - G + 1000 \frac{Q_{gi} - Q_{go}}{A} = \mu \frac{\Delta h}{\Delta t} \quad (16.5)$$

where

$Q_{gi} = Q_{gih} + Q_{giv}$ = the total rate of groundwater inflow into the shallow unconfined aquifer (m^3/d)

$Q_{go} = Q_{goh} + Q_{gov}$ = the total rate of groundwater outflow from the shallow unconfined aquifer (m^3/d)

Q_{gih} = the rate of horizontal groundwater inflow into the shallow unconfined aquifer (m^3/d)

Q_{goh} = the rate of horizontal groundwater outflow from the shallow unconfined aquifer (m^3/d)

Q_{giv} = the rate of vertical groundwater inflow from the deep confined aquifer into the shallow unconfined aquifer (m^3/d)

Q_{gov} = the rate of vertical groundwater outflow from the shallow unconfined aquifer into the deep confined aquifer (m^3/d)

μ = the specific yield or effective porosity, as a fraction of the volume of soil (-)

Δh = the rise or fall of the watertable during the computation interval (mm) and the other symbols as defined earlier.

When the layer beneath the shallow unconfined aquifer is impermeable, the rates of vertical groundwater inflow and outflow equal zero, the total groundwater inflow equals the horizontal groundwater inflow, and the total groundwater outflow equals the horizontal groundwater outflow.

The base of an unconfined aquifer is, in reality, seldom impermeable; it is the first clay layer struck at some depth during borehole drilling. In sandy areas, groundwater

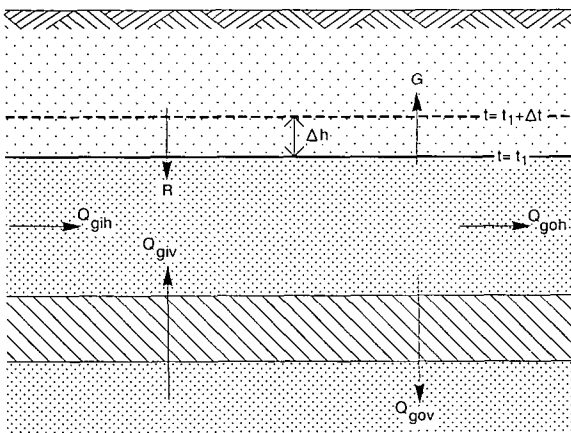

Figure 16.5 Groundwater balance components of the shallow aquifer of a multiple aquifer system

underlying the 'impermeable' base is confined. In discharge areas of the groundwater system, the aquifer receives confined water from beneath, and the quantity of inflow per computation interval of time must be included in the water balance. The total groundwater inflow is then equal to the sum of horizontal and vertical inflow.

In irrigation areas, the watertable in the unconfined aquifer can be appreciably higher than the piezometric surface in the deep aquifer. The resulting downward seepage from the shallow aquifer to the deep aquifer, over the time interval Δt , must then be included in the water balance. The total groundwater outflow then equals the sum of horizontal and vertical outflow. This flow constitutes what is called the 'natural drainage' of the area. In areas with an operational field drainage system, the drain discharge should be a separate component of the water balance.

We can determine the horizontal groundwater inflow and outflow through the boundaries of the area by using watertable contour maps (Chapter 2), which show the direction of groundwater flow and the hydraulic gradient, and by considering transmissivity at the boundary (Chapter 10). We can determine upward and downward seepage through an underlying semi-confined layer by considering vertical gradients and the shallow aquifer's hydraulic resistance. And we can calculate the change in storage by using groundwater hydrographs and the specific yield or drainable pore space of the shallow aquifer.

To get the data necessary for these direct calculations of horizontal and vertical groundwater flow, and of the actual amount of water going into or out of storage, we must install deep and shallow piezometers (Chapter 2) and conduct aquifer tests (Chapter 10).

In some areas with limited surface water resources, groundwater is used both for human consumption and for irrigation. When this occurs, the rate of groundwater abstraction must be accounted for in the water balance. If pumped wells provide irrigation water, we must keep track of the amount of return flow, i.e. the portion of the total groundwater abstraction that returns to the deeper layers and so recharges the groundwater reservoir. Return flow must also be accounted for in the water balance.

According to Equation 16.5, we can calculate the value of the net percolation as $R^x = R - G$. In areas with deep watertables, there is no upward flux by capillary rise, and so the actual percolation equals the calculated net percolation. In areas with shallow watertables, it is possible to determine only the net percolation.

16.2.5 Integrated Water Balances

The partial water balances that we discussed in the three previous sections are often combined to form integrated water balances. For example, by combining Equations 16.3 and 16.4, we get the water balance of the topsoil

$$P - E_o - E + G - R + 1000 \frac{Q_{si} - Q_{so}}{A} = \frac{\Delta W_s + \Delta W_u}{\Delta t} \quad (16.6)$$

To assess the net percolation $R^x = R - G$, we can use Equation 16.6. We can also assess this value from the groundwater balance (Equation 16.5). And, if sufficient data are available, we can use both of these methods and then compare the net

percolation values obtained. If the values do not agree, the degree of discrepancy can indicate how unreliable the obtained data are and whether or not there is a need for further observation and verification.

Another possibility is to integrate the water balance of the unsaturated zone with that of the saturated zone. Combining Equations 16.3 and 16.5, we get the water balance of the aquifer system

$$I - E + 1000 \frac{Q_{gi} - Q_{go}}{A} = \frac{\Delta W_u}{\Delta t} + \mu \frac{\Delta h}{\Delta t} \quad (16.7)$$

We can assess the infiltration from Equation 16.7, provided we can calculate the total groundwater inflow and outflow, the change in storage, and the actual evapotranspiration rate of the crops. We can also assess the infiltration from the surface water balance (Equation 16.4). And, if sufficient data are available, we can follow the same procedure we followed above.

Finally, let us integrate all three of the water balances described in the previous sections. This overall water balance reads

$$P - E_o - E + 1000 \frac{Q_{si} - Q_{so}}{A} + 1000 \frac{Q_{gi} - Q_{go}}{A} = \frac{\Delta W_u}{\Delta t} + \frac{\Delta W_s}{\Delta t} + \mu \frac{\Delta h}{\Delta t} \quad (16.8)$$

Equation 16.8 shows that the vertical flows I, R, and G (all important linking factors between the partial water balances) disappear in the overall water balance. Nevertheless, these linking factors determine to a great extent whether there are drainage problems or not.

For an example, let us look at Figure 16.6, which shows all the terms of the overall water balance for an area with basin irrigation. The overall water balance can be described by Equation 16.8 if we make the following substitutions:

$$\begin{aligned} E_o &= E_{oc} + E_{ob} + E_{od} \\ Q_{si} &= Q_{ic} + Q_{id} \end{aligned}$$

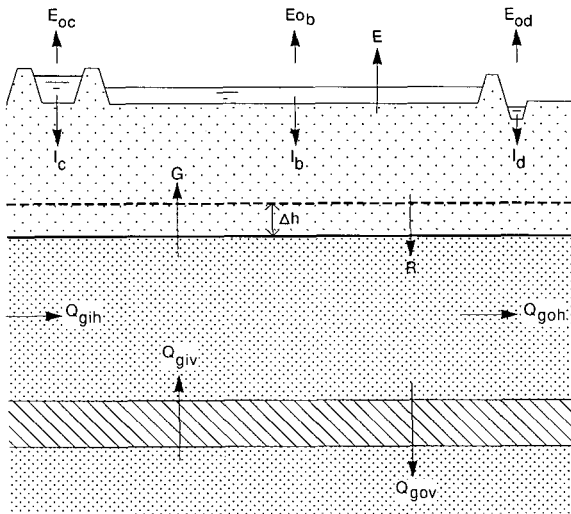

Figure 16.6 Overall water balance components for a basin-irrigated area

$$\begin{aligned}
 Q_{so} &= Q_{oc} + Q_{od} \\
 Q_{gi} &= Q_{gih} + Q_{giv} \\
 Q_{go} &= Q_{goh} + Q_{gov}
 \end{aligned}$$

When water balances are assessed for a hydrologic year, changes in storage in the various partial water balances can often be ignored or reduced to zero if the partial balances are based on long-term average conditions. In Equations 16.3 to 16.8, the sum of the various inflow components then equals the sum of the various outflow components. Drainage designers use this concept of steady state frequently. Their reasons for doing so are explained in Chapter 17.

16.2.6 Practical Applications

Water balance analyses are particularly useful in land reclamation and drainage projects because they provide insight into:

- The sources of local groundwater flow, i.e. the difference between the outflow and inflow of groundwater in the study area;
- The portions of rainfall and irrigation water that infiltrate at the land surface, evaporate from the surface or from the unsaturated zone, or leave the surface as overland flow;
- The quantity of, and the monthly or annual changes in, groundwater flow;
- The quantity of groundwater that must be drained artificially to maintain the watertable at a suitable depth, i.e. the drainable surplus.

We can ask ourselves if the knowledge we gain by investigating an experimental plot or a tract of several hectares is valid for the rest of the area under study (e.g. a large river basin or a delta plain). The answer is 'no' because throughout the river basin there are spatial variations in rainfall, evaporation, land use, soil, and hydrogeological conditions. The best way to obtain the water balance for the greater area is to divide the basin into hydrogeological sub-areas. The division should be based on watertable contour maps of the aquifer system and on well hydrographs. Variations in the spacing of the watertable contours reflect differences in the lithology of the aquifer and thus in the transmissivity. An analysis of the available well hydrographs makes it possible to select those wells whose water level fluctuations are similar. With this information, we can distinguish the hydrogeological sub-areas whose watertables react similarly to the processes of groundwater recharge and discharge. If we assess monthly water balances for these sub-areas, and then add up all the corresponding components of the balances, we obtain the annual water balance for the entire basin. These basin discretizations require sufficient and accurate data on the watertable fluctuations throughout the basin, on the specific yield of the unsaturated zone, on the thickness and hydraulic conductivity of the saturated zone, and on soil water content. They also require a network of stream-gauging stations to supply accurate data on the surface water inflow and outflow of the sub-areas.

A river catchment usually consists of a network of natural drainage channels that eventually join the main river. Each of these channels drains a certain area (sub-catchment). Because, over the catchment, there are variations in rainfall

distribution, soil and hydrogeological conditions, and land use and vegetation, the sub-catchments react differently during a hydrologic event (e.g. a rainstorm). Figure 16.7 illustrates the reactions of four minor catchments in a rainstorm. The peak flows show not only a marked difference, but also a time lag.

The river runoff depends not only on the hydrology of the catchment, but also on the distribution and intensity of the rainfall, and on the evapotranspiration and storage capacity of the unsaturated zone. In the humid climates of the western hemisphere, the winter season is characterized by low evapotranspiration and a fairly regularly distributed rainfall, whereas in summer evapotranspiration is high and rainfall is irregular. This means that the relation between rainfall and peak runoff is better in winter than in summer.

When considering the soil water content, we must be aware that different soil types have different water retention curves (Figure 16.8). These curves characterize the ability of the soil to retain water during gravity drainage or drying. We must also be aware of the difference in the relation between capillary flux and soil water content when a soil is absorbing water through infiltration and when it is losing water through drainage. One reason for this difference (hysteresis) is the entrapment of air in the soil during the wetting period, which means that the pores of the soil do not completely fill with water even when the capillary flux is zero.

In most soils, the relation between depth to the watertable and soil water storage is fairly direct, which makes it possible to use these relations to estimate the soil water

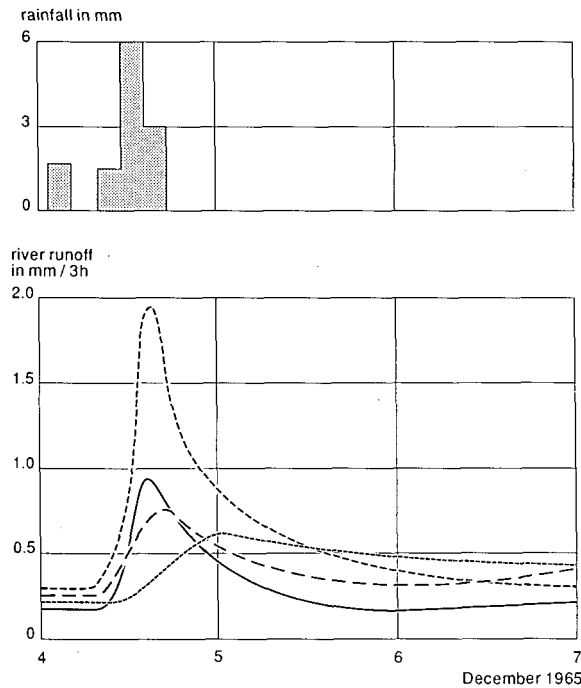

Figure 16.7 River hydrographs of four minor catchments recorded for the same rainstorm (after Colenbrander 1970)

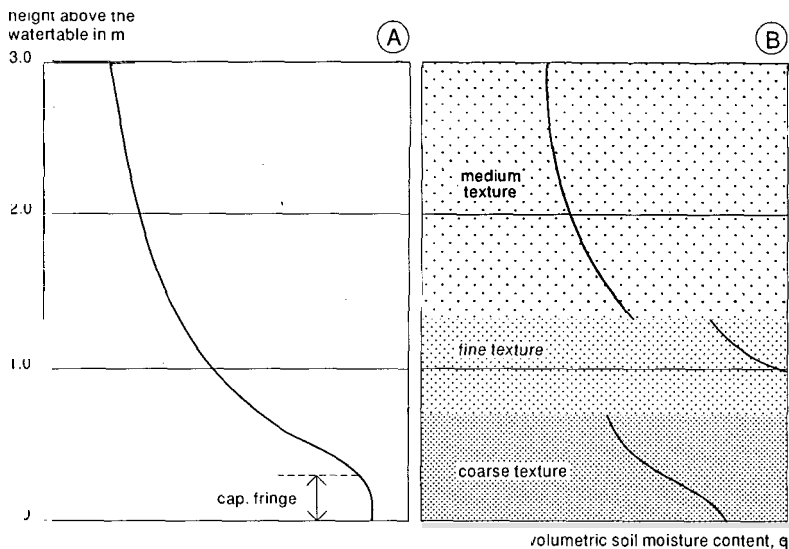

Figure 16.8 Typical equilibrium distribution of water in soils above the watertable
 A: in homogeneous soils
 B: in stratified soil

content. We can find the value of the specific yield or drainable pore space of the soil for different depths from the slope of the curves. The specific yield is defined in Chapter 2 as the change in soil water content divided by the change in watertable. The specific yield at equilibrium soil water content varies with the type of soil, ranging commonly from 5 to 15 per cent. The equilibrium soil water content is the water content of the soil at which the suction corresponds with the height above the watertable. We can estimate the change in soil water content from the change in watertable by assuming a constant specific yield (say 10% in sandy soils). In most soils, however, the specific yield is not constant, but variable according to the groundwater depth (Table 16.2).

The specific yield can be derived from soil water characteristics (pF curves), and from the known amount of water released from or added to storage and the corresponding change in watertable. A prerequisite to these calculations is that the soil water content before and after the change in watertable must correspond with the equilibrium soil

Table 16.2 Specific yield of two soil types at different watertable depths

Watertable depth cm	Specified yield %	
	Marine clay	Loamy sand
30	5.4	22.3
50	5.1	19.5
70	4.9	16.8
100	4.3	13.0

water content. So it is advisable to measure the soil water content, even when the water deficit of the soil profile and the evapotranspiration are so small as to be negligible. Only then will it approach the equilibrium soil water content.

Direct measurements of soil water content by neutron probing are preferable to calculations from pF curves. The soil water content derived from pF curves is higher than that obtained by neutron probing because pF curves assume that equilibrium soil water conditions prevail (Figure 16.9). The calculations for the shallow soil layers are too high because of the entrapped air in some of the pores. Measurements with a neutron probe automatically account for entrapped air in the soil profile (Chapter 11). For the saturated zone, the discrepancies between measured and calculated soil water contents are much smaller because little or no air is present in soil that is permanently waterlogged.

Finally, we must realize that the depth of the watertable plays a crucial role in evaluating the discharge from an area. If the groundwater is deep, say many metres below the ground surface, we only have to consider the groundwater inflow and outflow for a specified area. In areas with shallow watertables, however, say less than 3 m below the ground surface, there is considerable groundwater outflow due to capillary rise, i.e. an upward flux from the watertable, which can bring the groundwater to the land surface, where it is then lost to evaporation (if the soil is barren) or to evapotranspiration (if the soil has a vegetative cover). The loss of groundwater to the rootzone of crops can also be great, especially in the dry season, when the soil water storage is partly depleted. But the size of these losses depends on the soil type (Figure 16.10). Very fine sandy loam, for example, has a very high capacity for capillary rise into the rootzone.

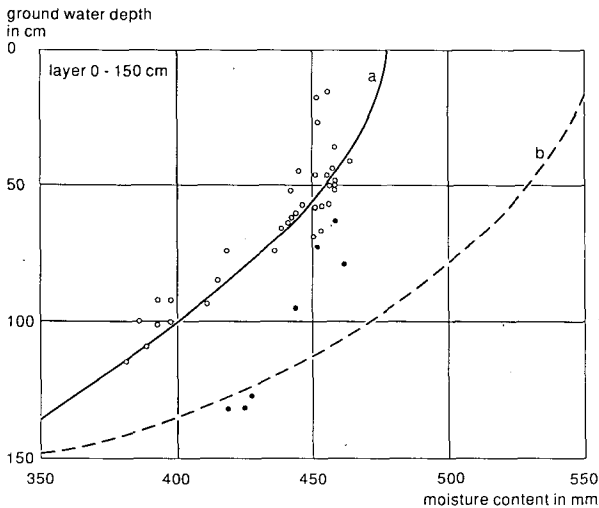

Figure 16.9 The relation between groundwater depth and water content of sandy humus podzol soils in the eastern part of The Netherlands. Curve a determined by neutron logging, curve b calculated from pF-curves (after Colenbrander 1970)

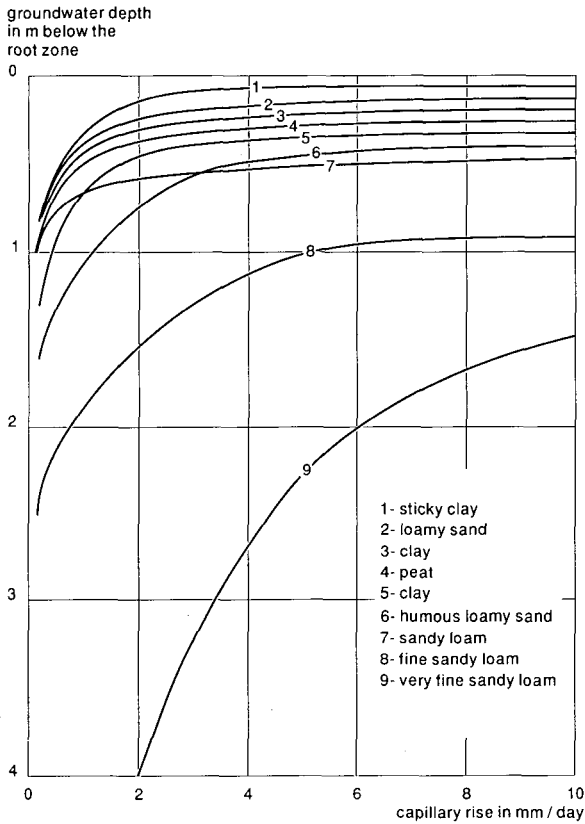

Figure 16.10 Capillary rise of groundwater to root zone in mm/day for different groundwater depths and soil textures under moist conditions (soil water tension of root zone about 5 m) (after Doorenbos and Pruitt 1977)

We must also realize that the time interval we choose for a water balance study can affect the result of our calculations.

As an example, let us say that there was a heavy rainstorm just before the beginning of our chosen time interval. Although the storm will not appear in the water balance, its effects will – on soil water content, groundwater recharge, and groundwater flow. Under these circumstances, it is advisable to shift the time interval so that it begins before the rainstorm and ends a few days after the rain has ceased. If we cannot do all our measurements and observations on the same day, then we should at least do them on consecutive days.

Meteorological conditions vary throughout the year and from one year to another. Accordingly, there are wet, dry, and normal years. Because of these variations we must investigate how much the hydrologic conditions in the year under study deviate from those in a normal or average year. A study of this kind requires long-term records of precipitation, evapotranspiration, and river discharge.

16.2.7 Equations for Water and Salt Balances

So far, we have considered only the movement of groundwater. We shall now discuss the quality of groundwater, which is determined by the amount and nature of the solutes it contains. The movement and build-up of these solutes (e.g. salt and chemical and organic pollutants) can lead to the salinization and even to the pollution of the groundwater and the soil. These problems can, in turn, effect aquatic ecosystems, crop yields, and ultimately human health. We can establish salt balances by coupling the movement of salts and other solutes to the movement of the groundwater. The equations for these calculations are discussed below.

Groundwater quality is a major factor in drainage studies. Drainage water is sometimes re-used for irrigation and other purposes, either in the project area or in downstream areas. When this water is re-used, it is necessary to estimate for the particular drainage system the quantities of salts and other solutes that are being swept along with the drain effluent. These amounts are usually estimated from salt balances.

The salt balances discussed here focus on salts that are present in both a liquid and a solid state and that, in solution, will move at the same density and at the same velocity as water. The salt balances deal with the major elements in natural waters, namely the cations calcium, magnesium, sodium, and potassium, and the anions bicarbonate, carbonate, sulphate, and chloride. Minor elements like boron, fluoride, and nitrate, and chemicals like pesticides and herbicides are excluded. By and large, it is the major elements that control the chemical character of the water. Their concentrations are expressed in tons/ha.

We can say that the total water balance of an area over a long period of time is in a steady state. The salt balance, however, is not in a steady state. Salt enters the system at the land surface through the inflow of canal water or surface water and through precipitation. It leaves the system through surface drains or field runoff. Salt can also enter the system through groundwater inflow and leave through groundwater outflow. Changes in salt storage are determined by the surface water conditions, by the soil moisture, and by the groundwater regime. Salt ions need different periods of time to travel through the system, depending on the length of the path they take. Salt ions in the groundwater zone follow the same paths as water molecules – along the streamlines towards the drains or pumped wells. These streamlines may reach far below drain depth (Chapter 8), mobilizing the salts and other solutes that occur in the deeper parts of the aquifer.

It is possible to derive partial salt balances for the land surface, the unsaturated zone, and the groundwater zone. To do this, let us consider a column of soil. This column extends from the land surface to the impermeable base and is bounded on both sides by imaginary vertical planes. Let us further assume that the hydraulic system of the column is in a steady state, so that the watertable is constant (Figure 16.11).

If we also assume that there is no addition or removal of salts by the wind, and that evaporation and crop evapotranspiration occur at the land surface, the balance of soluble salts at the land surface is

$$S_{si} - S_{so} + S_p + S_c - S_i = \Delta S_s \quad (16.9)$$

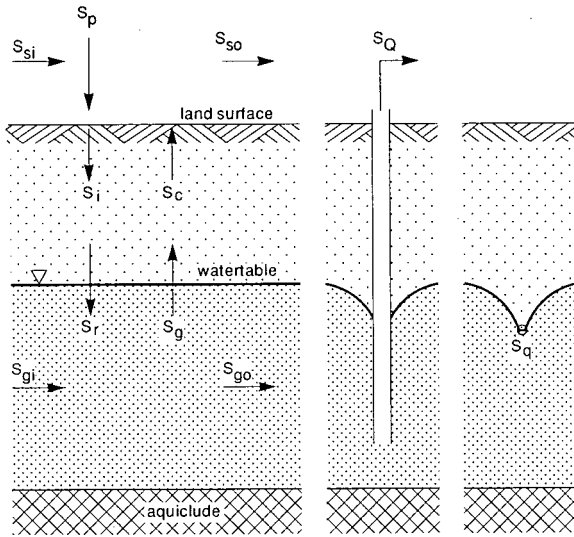

Figure 16.11 A salt balance

where

- S_{si} = the quantity of salt brought in by surface water and canal inflow (tons/ha)
- S_{so} = the quantity of salt removed by surface drainage (tons/ha)
- S_p = the quantity of salt brought in by precipitation (tons/ha)
- S_c = the quantity of surface salt brought in by capillary rise (tons/ha)
- S_i = the quantity of salt removed by infiltrating surface water (tons/ha)
- ΔS_s = the change in the quantity of salt stored at the land surface for the given time interval Δt (tons/ha)

The quantities of salt are expressed in tons/ha. If salts are introduced or removed in solid particle form (e.g. by the application of fertilizers or the removal of crops), additional terms will have to be included in Equation 16.9.

We can write the salt balance of the unsaturated zone, excluding the capillary fringe, as

$$S_i - S_c + S_g - S_r = \Delta S_u \quad (16.10)$$

where

- S_g = the quantity of salt brought into the unsaturated zone by upward flow from the groundwater zone (ton/ha)
- S_r = the quantity of salt removed by downward flow to the groundwater zone (ton/ha)
- ΔS_u = the change in the quantity of salt stored in the unsaturated zone for the given time interval Δt and for the other symbols as defined for Equation 16.9 (tons/ha)

These equations are in an extremely simplified form. Salt accumulation due to

evaporation and crop evapotranspiration, for example, is more complicated than the equations would lead us to believe here. It occurs both at the surface and in the rootzone, and its distribution decreases with depth. Nevertheless, it is possible to adjust these and other components in the salt balance with a multi-layered soil column (e.g. the four-layered rootzone in Section 15.5.1 of Chapter 15). With these adjustments, the component S_c will not appear in the surface salt balance (Equation 16.9), but in the salt balance of the subsequent soil layers or the compartments in the upper soil profile.

The salt balance of the groundwater zone, including the capillary fringe, is

$$S_r - S_g + S_{gi} - S_{go} - S_q = \Delta S_g \quad (16.11)$$

where

S_{gi} = the quantity of salt brought in by the inflow of groundwater (tons/ha)

S_{go} = the quantity of salt removed by the outflow of groundwater (ton/ha)

S_q = the quantity of salt removed by subsurface drainage flow, either by tubewells or subsurface drains (tons/ha)

ΔS_g = the change in the quantity of salts stored in the groundwater zone for the given time interval Δt and for the other symbols as defined for Equation 16.10 (tons/ha)

If the quality of the groundwater is heterogeneous in a vertical direction, we can divide the saturated zone into horizontal compartments, as we did when making the water balance.

If we integrate the three salt balances, neglecting S_p (because the quantity of salt introduced with precipitation is usually small compared with the other components), we obtain the total salt balance

$$S_{si} - S_{so} + S_{gi} - S_{go} - S_q = \Delta S_s + \Delta S_u + \Delta S_g \quad (16.12)$$

In all these balances, the change in salt storage refers to salt in solution and salt solids. The storage of highly soluble salts in the effective zone of full saturation, i.e. in surface waters and in the groundwater zone and the capillary fringe, is often assumed to be constant. Note that these equations omit the precipitation and solution of slightly soluble salts, and that the effect of these processes becomes more pronounced at high salt concentrations (Chapter 15).

Factors that we must consider when investigating the salt build-up in drainage projects include:

- The concentration of salt in the groundwater;
- The concentration of salt in the soil layers above the watertable;
- The depth and spacing of the drains;
- The rate and depth of pumping of tubewells.

The first two factors are fixed by nature or by the past and present land use of the project area. The other factors are engineering variables.

In areas with a thick unconfined aquifer (the impermeable layer is at great depth), it is possible to limit an assessment of the total balance to the upper part of the aquifer,

say the top 10 m, because the groundwater salinity below this depth does not change over short periods. It does change, however, when deep tubewells are installed and operated. When there is deep pumping, therefore, the assessment must include data from a much greater depth to take into account the effects of partial penetration by the tubewells.

To estimate the changes in the salt concentration of the groundwater reservoir, it is necessary to make a water and salt balance of the unsaturated zone. It is through this zone that water and salt move to the groundwater. In areas with shallow watertables, water and salt move to the surface through capillary rise, where the water evaporates and the salt concentrates in the upper soil layers.

If we have a salt balance of the unsaturated zone, we can estimate the net quantity of salt that enters the groundwater reservoir through the percolation of precipitation and irrigation water. The salt balance of the groundwater reservoir can then be assessed with this quantity (Brown et al. 1977).

For salt balance studies, we can use the same data we used for the total water balance, the water balance of the unsaturated zone, and the water balance of the groundwater reservoir. These studies are usually made in experimental plots or key plots, in combination with studies of soil water and groundwater movements. A network of nested piezometers is necessary to measure the water levels and to take water samples for tests of the salt concentration. It is common to measure the salt concentrations in the unsaturated zone before and after the soil is leached and before and after the growing season (Chapter 15).

16.3 Numerical Groundwater Models

16.3.1 General

The process of setting up partial or integrated water balances can be complicated and time-consuming. Spatial variation in the contributing components can make it necessary to split up the study area into various sub-areas. Each of the sub-areas will require a separate water balance, and all of these balances will have to be aggregated. In addition, the sub-areas may require a monthly water balance, and these will also have to be aggregated if a seasonal or annual water balance is needed.

Another complicating factor is that groundwater exhibits a number of non-linear features. These include the hydraulic conductivity and specific yield of the aquifer system (which are functions of the watertable height), moving boundaries, and the effect of hysteresis on the relationship between capillary flux and soil water content.

Problems of non-linearity and spatial variation are quite often oversimplified or even neglected when water balances are being set up manually. To avoid the risk of oversimplification, it is possible to use numerical groundwater models to solve the problems. A groundwater model can be defined as a simplified version of the real groundwater system. It describes the flow characteristics and gives pertinent assumptions and constraints. It expresses the conceptual representation of the system in causal relationships among the system's various components and between the system and its environment.

Groundwater models are based on two well-known equations: Darcy's equation

and the equation of conservation of mass (Chapter 7). The combination of these two equations results in a partial differential equation that can be solved by numeric approximation. The two best-known approximation methods are the finite difference method and the finite element method. Both require that space be divided into small but finite intervals. The sub-areas thus formed are called nodal areas, as they each have a node that connects it mathematically to its neighbours. The nodal areas make it possible to replace the partial differential equation with a set of algebraic equations.

16.3.2 Types of Models

There are many types of groundwater models, but for our purposes let us start with a description of steady-state and unsteady-state models. As their name suggests, steady-state models assume that groundwater flow is in steady state, i.e. that the hydraulic heads do not change with time, and that the change in storage is equal to zero. Steady-state models are often used in situations where the hydrologic conditions are either average or do not change much over time. Unsteady-state models assume that the hydraulic heads change with time. Although these models are better at simulating the actual behaviour of groundwater systems, they require far more input data than do steady-state models. Because these data are scarce, unsteady-state models are not used as often as steady-state models.

For both types of models, we must input the geometry of the aquifer system, the type of aquifer, and the hydraulic characteristics of the aquifer. Although there may be variation from one node to another, we can assume that within a nodal area these data are constant and time-independent.

For steady-state models, we must prescribe external stress at the internal nodes and boundary conditions at the boundary nodes. Examples of external stress are recharge of the groundwater system by infiltrating rainfall and discharge from the groundwater system by tubewell pumpage. As boundary conditions, we must prescribe either a constant head or a constant flux.

Time simulation in unsteady-state models is a succession of small but finite intervals. For each of these time steps, specific values for external stress must be prescribed at the internal nodes and values for head or flux at the boundary nodes, as they may change with time. Initial conditions must also be prescribed. Usually, we can interpolate the values of the head at the internal nodes from a watertable contour map.

Now that we have considered these models, let us look at prediction models. Prediction models simulate the behaviour of the groundwater system and its response to stress. They are categorized as either unsaturated-zone models, saturated-zone models, or integrated models.

Unsaturated-zone models simulate vertical, one-dimensional flow. They use a succession of different soil layers, usually extending from the land surface to the saturated zone, to represent a vertical soil column. To each of these soil layers, they attribute a soil-moisture retention curve and values of the hydraulic conductivity as a function of soil-moisture content. In addition, they require values for the initial moisture content in the profile and for the boundary conditions at the top and bottom of the column. The boundary conditions at the top are described by values of rainfall,

potential soil evaporation, and potential evapotranspiration. The boundary conditions at the bottom are described by pressure head or flux conditions. The soil layers themselves may consist of various compartments. Each compartment is represented by a nodal point; the values for pressure head, unsaturated hydraulic conductivity, and soil moisture content are calculated at these points.

Saturated-zone models simulate the horizontal, two-dimensional flow. They discretize the aquifer system into a network of nodal areas. To each nodal area, they attribute values for the thickness, the saturated hydraulic conductivity, the specific yield, and the storage coefficient. In addition, they require values for the initial pressure heads in each nodal area and for the boundary conditions at the top and sides (lateral boundary conditions). We can obtain a value for the boundary conditions at the top by calculating the net recharge to the aquifer system first and then setting up water balances for the unsaturated zone. To define the lateral boundary conditions, we can use pressure head conditions and flux conditions, but it is more common to use pressure head conditions.

Each nodal area can consist of various aquifer types. The multi-layered (pseudo three-dimensional) groundwater models simulate the interaction between the various aquifers by calculating vertical flow through the aquitards. Each nodal area is represented by a nodal point, or by different nodal points in multi-layered aquifers; values for the hydraulic head are calculated at these points.

A third type of prediction model is the integrated model. These models can integrate the flow in the unsaturated zone with the flow at the land surface, with the flow in the saturated zone, with both of these flows, and with crop production.

All three types of models predict pressure head and groundwater head at the nodes as a function of prescribed, time-varied, external stress. They use these heads to calculate the relevant water balance components – net recharge, horizontal and vertical flow rates, changes in storage – for each nodal area. It is common to aggregate these components to obtain a water balance for the whole model area.

There is a special category of groundwater models that run in the so-called ‘inverse mode’. These models calculate the external stress as a function of prescribed time-varied heads. They can be particularly useful for determining the drainable surplus from field investigations.

For more information on all these models, refer to Feddes et al. (1988), IGWMC (1992), and to Volp and Lambrechts (1988).

16.4 Examples of Water Balance Analysis

Let us now consider a rectangular farm, 1600 m long and 860 m wide, that is located in a flat alluvial plain. An irrigation channel crosses the farm approximately in the middle. The crops cultivated on the farm are irrigated with water from this canal. Rice is grown in a strip on both sides of the canal, and cereals and other field crops on the remaining parts of the farm.

The lands surrounding this farm are also cultivated, but because of a shortage of irrigation water, they are not supplied with water from the canal. Some farmers have a shallow hand-dug well and use its water to irrigate small patches of the land.

During the irrigation season, it was found that the watertable in parts of the irrigated

farm was rather shallow, and the question arose whether the farm land needed artificial drainage.

Shallow piezometers were placed in a regular grid, and monthly readings were made of the depths to the watertable. This observation network was also surveyed, so the observed watertable depth data could be converted to absolute watertable elevation data. Groundwater samples were taken from the piezometers and their electrical conductivity was determined.

16.4.1 Processing and Interpretation of Basic Data

The above data were processed to produce depth-to-watertable maps, watertable contour maps, and electrical conductivity maps (Chapter 2). Their results and interpretation are briefly summarized below.

Figure 16.12 shows the depth-to-watertable map on a certain date in the irrigation season. The watertable in the middle of the farm is shallow, less than 1 m below the land surface, and along the canal, even less than 0.5 m. This is caused partly by leakage from the canal, but mainly by the heavy percolation from the rice fields near the canal. In the other parts of the farm, less irrigation water is applied (cereals and field crops), percolation is less, and the watertable deeper (2–3 m).

The direction of groundwater flow can be derived from the watertable contour map (Figure 16.13). The flow direction is perpendicular to the contour lines (equipotential lines). In the middle of the farm, near the canal, a groundwater mound has formed from where water flows in all directions. Everywhere along the farm boundaries groundwater flows out from the farm, except in the northeast and southeast where the boundary is nearly perpendicular to the watertable contour lines. This means that these parts of the boundary are flow lines across which, by definition, no groundwater flows. Along the other parts of the farm boundary, the watertable gradient varies from about 1:200 to 1:400. This indicates that the aquifer system is more or less homogeneous.

Figure 16.14 shows the electrical conductivity map of the shallow groundwater. The least saline groundwater is found in the middle of the farm, even though the watertable there is at its shallowest. The heavy percolation in this part of the farm apparently prevents capillary rise, and since groundwater flows away from this area in all directions, soil and groundwater cannot become salinized. In the direction of flow, however, the salinity increases rapidly, and just beyond the farm boundaries, i.e. in the non-irrigated areas, it reaches its highest values ($EC = 20$ to 25 dS/m). Farmers in these areas suffer in three ways: they do not receive surface water from the canal for irrigation because it is in short supply, they cannot use groundwater because it has become too saline, and their lands are in danger of becoming salinized because the inflow of groundwater from the irrigated farm causes the watertable in their land to rise to or within critical heights and the capillary rise to become important.

From this information, it is clear that no artificial drainage for salinity control is required for the irrigated farm itself. Even for watertable control no drainage is required because rice is being grown in the area with the shallowest groundwater depths. To protect the surrounding area, it would, however, be advisable to impose certain watertable control measures within the irrigated farm. Changing the cropping

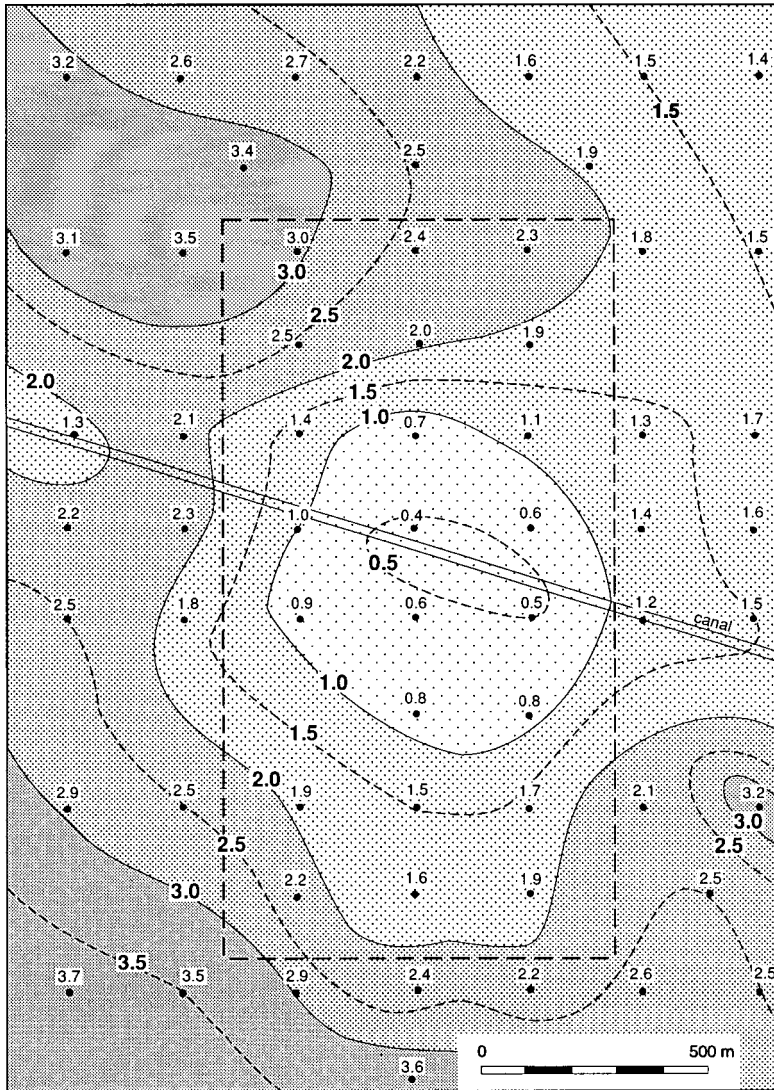

Figure 16.12 Depth-to-watertable map:

● 1.6 = observation well, watertable depth 1.6 m below soil surface

pattern (rice should never be cultivated on relatively light soils) will undoubtedly alleviate the problem.

16.4.2 Water Balance Analysis With Flow Nets

So far, we have discussed how to make a qualitative water balance analysis. Here, and in the next section, we shall discuss how to make a quantitative analysis by setting up water balances for the saturated zone.

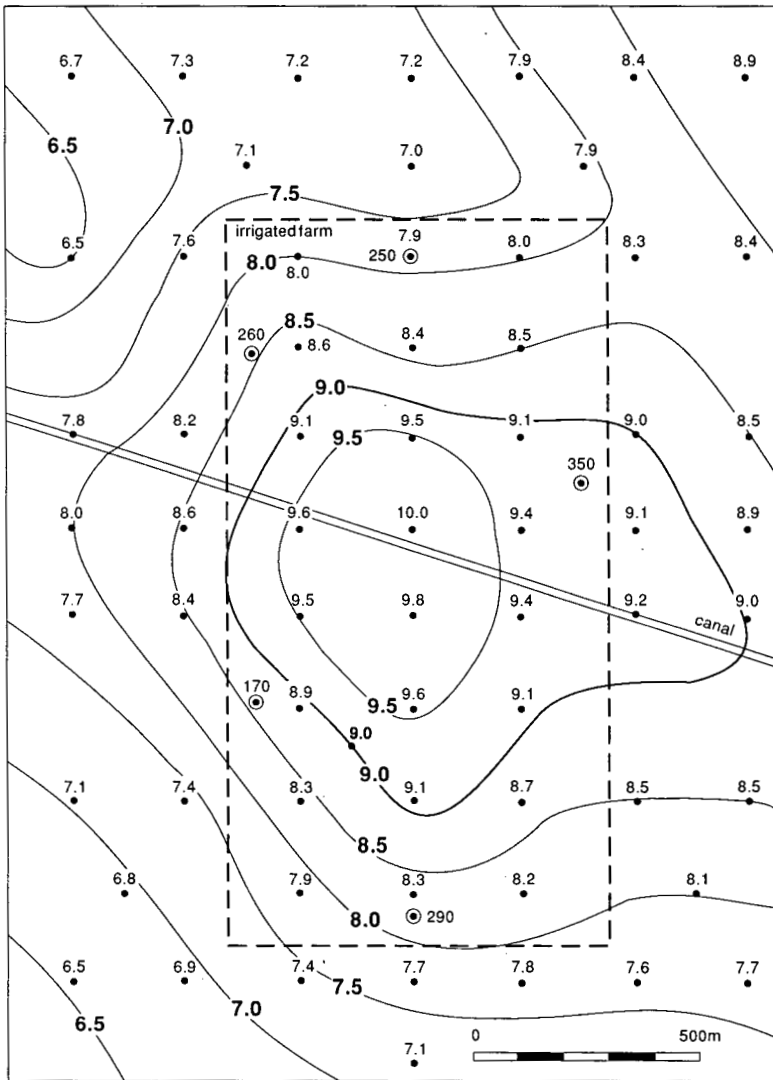

Figure 16.13 Watertable contour map:

- 8.3 = observation well, watertable elevation 8.3 m above sea level
- ⊙ 290 = aquifer test site, transmissivity $KD = 290 \text{ m}^2/\text{d}$

Example 16.1

Let us make a water balance for the irrigated farm. For simplicity, let us assume that the data in Figures 16.12, 16.13, and 16.14 are representative of the irrigation season, i.e. let us assume that the groundwater system is in a steady state during the irrigation season.

To calculate the rate of groundwater flow across the farm boundaries, we need to know the watertable gradient and the aquifer transmissivity. Because the equipotential lines in Figure 16.13 do not coincide with the farm boundaries, but cross

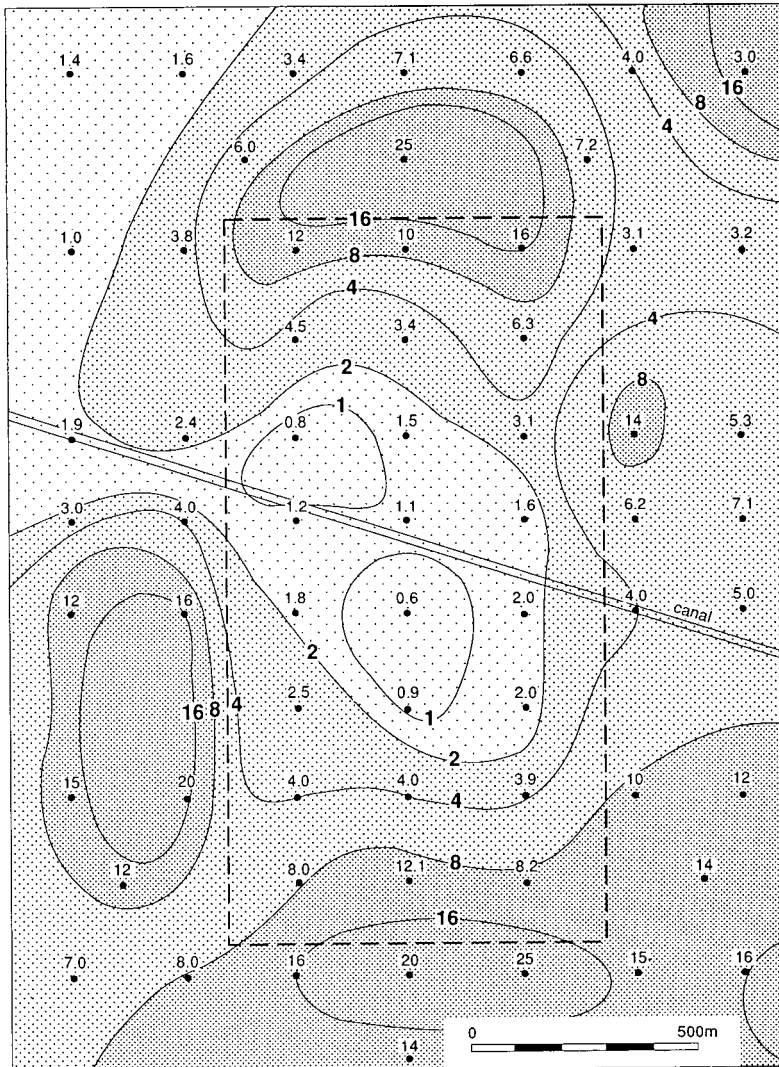

Figure 16.14 Electrical conductivity of the shallow groundwater in dS/m

them obliquely, we must construct a flow net (Figure 16.15). This should be done according to the following specifications:

- To construct the first 'square', select a pair of equipotential lines that run along both sides of the boundary of the water balance area. Draw a first flow line at an arbitrarily chosen location; the smoothly drawn flow line should intersect both equipotential lines at right angles. Draw a second flow line in such a manner that the distance between the two equipotential lines midway between the two flow lines is equal to the distance between the two flow lines midway between the two equipotential lines. Like this, a square will generally have four slightly curved sides;
- To construct the next square, use the same pair of equipotential lines if these lines

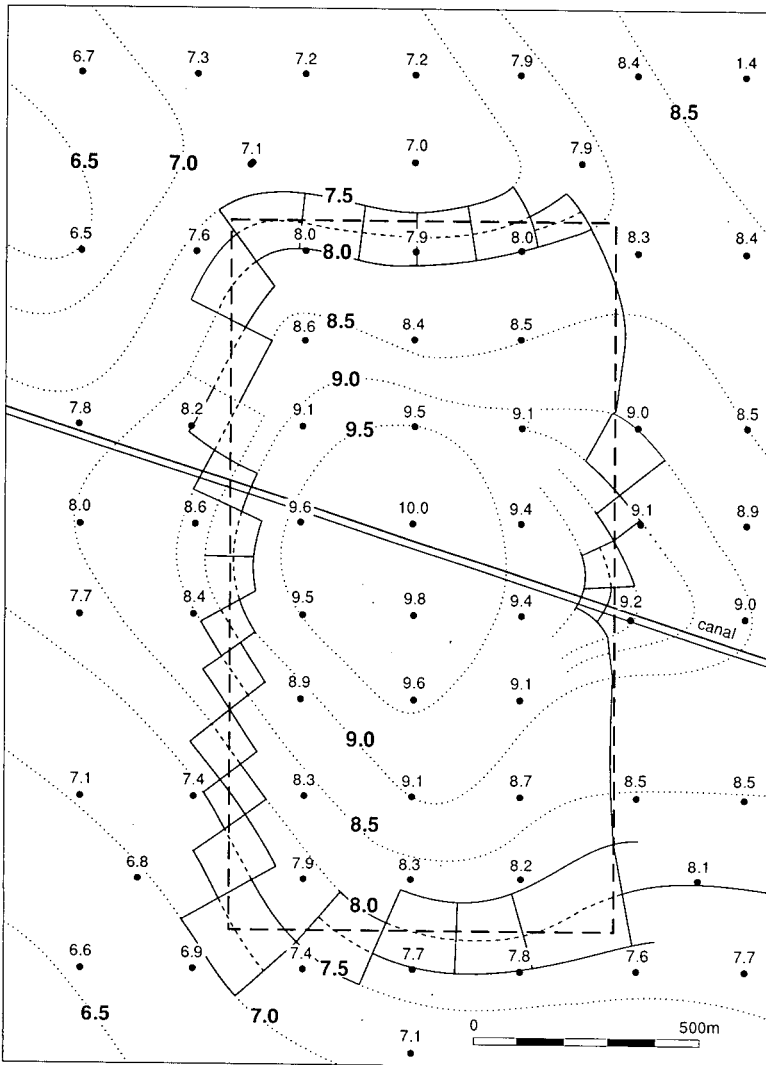

Figure 16.15 Watertable contour map with a flow net constructed along the farm boundaries

- still follow the boundary of the water balance area. Draw the next flow line. If the equipotential lines start to deviate from the area boundary, extend the flow line to another pair of equipotential lines that do follow the boundary. The squares should follow the boundaries of the water balance area as closely as possible;
- Continue this process until the last flow line drawn coincides with the first flow line drawn, i.e. until the water balance area is fully enclosed by squares.

Figure 16.15 shows that to construct a system of squares along the four boundaries of the irrigated farm, it was necessary in some places to reduce the contour interval from 0.50 m to 0.25 m, and even to 0.10 m and 0.05 m in the east of the farm.

Information on the transmissivity of the aquifer was obtained from the analysis of five aquifer test sites. These sites are shown in Figure 16.13 together with their transmissivity values, which were attributed to certain sections of the farm boundary.

We can calculate the rate of horizontal groundwater flow through each square using Darcy's equation

$$Q = KD s \Delta y = KD \frac{\Delta h}{\Delta x} \Delta y \quad (16.13)$$

with

- KD = the transmissivity of the aquifer (m^2/d)
- s = the hydraulic gradient (-)
- Δy = the width over which groundwater flow occurs, i.e. the perpendicular distance between two flow lines (m)
- Δh = the difference in hydraulic head between two contour lines (m)
- Δx = the distance between two contour lines, as measured in the direction of flow (m)

Because the squares were constructed so that Δx equals Δy , the total groundwater flow across the boundaries of the water balance area reduces to $Q = n KD \Delta h$, where n is the number of squares provided the proper KD and Δh values are attributed to each square.

For the flow net in Figure 16.15, this procedure yielded the following results: starting in the northeast and moving anti-clockwise

$$Q = (1 \times 250 \times 0.25) + (5 \times 250 \times 0.50) + (3 \times 260 \times 0.50) + (7 \times 170 \times 0.50) + (6 \times 290 \times 0.50) + (1 \times 350 \times 0.05) + (3 \times 350 \times 0.10) = 2665 \text{ m}^3/d$$

For the irrigated farm, Equation 16.5 (the groundwater balance) reduces to

$$R - G - 1000 \frac{Q_{go}}{A} = 0 \quad (16.14)$$

in which Q_{go} is the horizontal outflow of groundwater. This is so because:

- We assumed the aquifer could be treated as an unconfined aquifer (no vertical inflow or outflow of groundwater);
- We observed no horizontal groundwater inflow anywhere along the boundaries of the irrigated farm, so $Q_{gi} = 0$;
- We assumed the groundwater system was in a steady state during the irrigation season, so $\mu \Delta h / \Delta t = 0$.

If we assume that $Q_{go} = 2665 \text{ m}^3/d$ and that $A = 1600 \times 860 = 1\,376\,000 \text{ m}^2$, then Equation 16.14 yields

$$R - G = 1000 \frac{2665}{1\,376\,000} = 1.9 \text{ mm/d}$$

And if we assume that steady-state conditions prevail in the unsaturated zone, Equation 16.4 then yields $I - E = 1.9 \text{ mm/d}$. This is the net infiltration rate, and

it represents an average taken over the total area of the irrigated farm. We can expect the net recharge to be substantially higher in the middle of the farm and lower along the fringes.

16.4.3 Water Balance Analysis With Models

So far, we have used the groundwater balance to estimate the natural drainage (some 2 mm/d) on the irrigated farm. This value does not, however, represent the drainable surplus, as we shall see below.

Example 16.2

Let us now use a groundwater simulation model for the saturated zone to get additional information on the irrigated farm's drainable surplus. To develop the model, we can use an updated version of the SGMP groundwater model (Boonstra and De Ridder 1990). The water balance area on the farm is discretized into a network of rectangles, called a 'nodal network' (Figure 16.16). Most of the nodes coincide with the locations of the observation wells shown in Figure 16.12. Because the network of observation wells is slightly irregular, it is necessary to use the watertable contour map to interpolate the watertable elevation for the nodes that did not coincide with observation wells.

The observed (interpolated) watertable elevations were assigned to the nodes of the groundwater model. The reported transmissivity values from the five aquifer test sites were used to make a map that showed lines of equal transmissivity. The nodal network map was superimposed on the transmissivity map and, for each nodal area, the corresponding transmissivity value was determined and fed into the database of the model. The model was then run in the inverse mode.

The model yielded a set of nodal net recharges (Figure 16.16). The recharge values range from 9.6 mm/d in the middle of the farm to - 5.6 mm/d in certain areas. In these other areas, the percolation losses from irrigation are apparently so small that the capillary rise rate exceeds them. The first line in Table 16.3 shows the overall water balance of the irrigated farm according to the inverse model run. Note that the boundaries of the farm do not coincide exactly with the sides of the nodal areas.

Table 16.3 shows that the total groundwater outflow calculated from the flow net corresponds reasonably well with the outflow calculated by the model. The similarity proves that a groundwater model run in inverse mode will yield the spatial distribution of net recharge values. In addition, it proves that the model can simulate a watertable

Table 16.3 Water balance components of the irrigated farm according to the model runs, in m³/d

Actual and simulated watertable elevations	Net recharge	Groundwater outflow	Drain discharge
Actual situation	2551	2551	-
Watertable depth \geq 1.0 m	2551	2033	518
Watertable depth \geq 1.5 m	2551	1377	1174

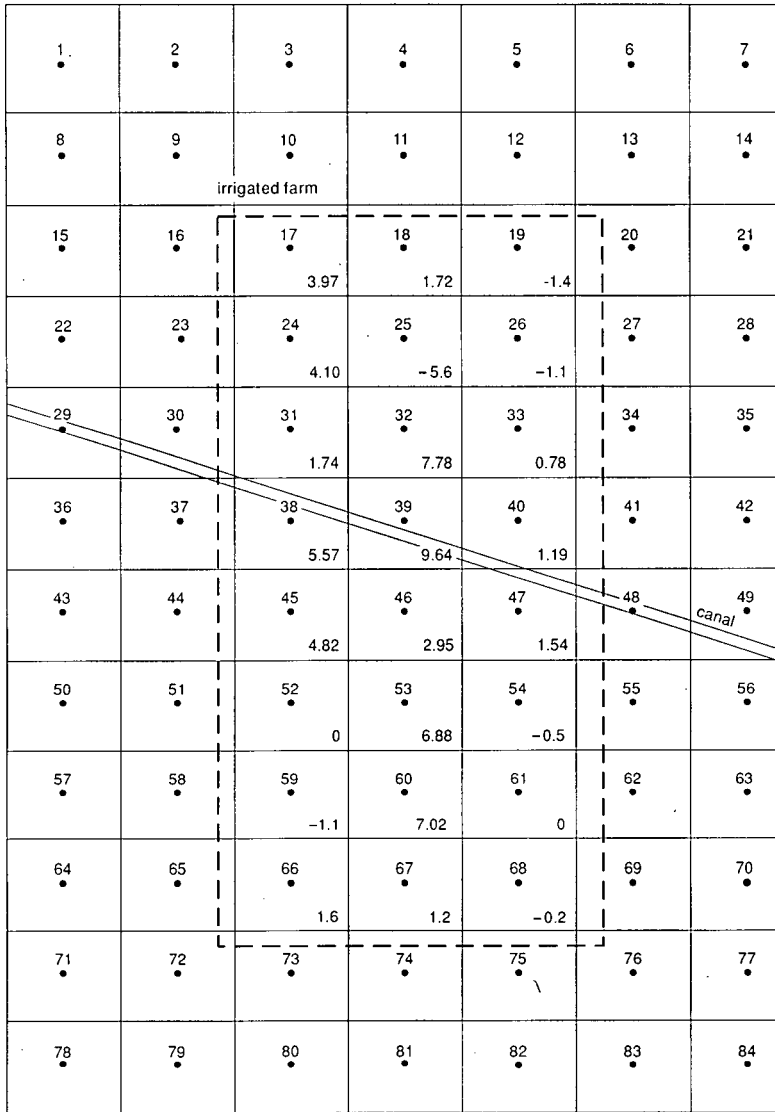

Figure 16.16 Lay-out of nodal network with nodal areas of $250 \times 200 \text{ m}^2$ and calculated nodal net recharge values within the irrigated farm

regime that is controlled by subsurface drainage. The simulation can be done in SGMP if certain watertable levels are prescribed for each node separately. If the calculated watertable elevations exceed these levels during a simulation run, the model will introduce artificial negative flow rates. This adjustment yields calculated watertable elevations equal – within a given range – to the prescribed levels.

Two situations were simulated: one with a minimum watertable depth of 1 m and one with a minimum watertable depth of 1.5 m. Table 16.3 shows the results of the simulation runs. As expected, they showed that subsurface outflow decreases as the

drainage level drops. Table 16.4 shows the drainable surplus of each nodal area in the two simulated situations with the existing watertable above the prescribed levels.

Table 16.4 shows that the actual (required) drainable surplus depends on the average watertable depth to be maintained. Table 16.4 also shows that the area in need of artificial drainage is somewhat smaller than indicated in Figure 16.12. The discrepancy means that implementing an artificial drainage system in the middle of the irrigated farm will automatically result in a greater watertable depth in the surrounding area, especially within the farm.

Note that installing a tubewell-drainage system instead of a subsurface drainage system can cause a substantial increase in the required drainable surplus if the watertable depth inside the farm drops below the levels in the area surrounding the farm; groundwater will then be 'attracted' from the surrounding areas to the farm.

By providing this kind of information, groundwater simulation models can help the drainage engineer to design subsurface drainage systems. The great advantage of these models is their ability to illustrate the consequences of man-made interference in the natural flow system without the need for actual implementation.

16.5 Final Remarks

Water balances can be assessed for any area and for any period. For studies of a particular area, two types of water balances can be assessed. They are:

- Water balances comprising physical entities (e.g. river catchments and groundwater basins);
- Water balances comprising only parts of physical entities (e.g. irrigation schemes and areas with shallow watertables).

The two types are very similar, their main differences being the emphasis in the first on the spatial variability of the contributing factors and the subsequent division into hydrogeological sub-areas, and the importance in the second of surface and subsurface inflow and outflow across the area's artificial boundaries. Spatial variability is less important in studies comprising relatively small areas.

Table 16.4 Drainable surplus calculated by SGMP for each nodal area (50 000 m²) with watertable control (mm/d)

Nodal area number	Watertable depth not to be exceeded	
	1.0 m	1.5 m
32	-	2.5
39	5.4	6.6
40	0.5	3.4
45	-	0.5
46	-	0.5
47	4.6	6.7
53	-	1.4
54	-	1.9

Water balance studies for subsurface drainage usually fall into the second category. The need for artificial drainage often arises in areas irrigated with surface water. Irrigation is accompanied by inevitable water losses even when the efficiency (water conveyance), distribution, application, and use is relatively high (Chapter 14). The unavoidable losses from the irrigation system are usually higher than the amounts of irrigation water required for salinity control. Due to these losses, watertables in irrigated areas often rise steadily, reaching a rate of 4 m a year in exceptional situations (Schulze and De Ridder 1974). Even when this rise is slow, it will eventually lead to drainage problems. Figure 16.17 illustrates an example of such a situation. It depicts two groundwater hydrographs situated in an area where surface water irrigation started around 1900. It took some forty years before the water levels, having an initial depth of some 16 m, rose close to the land surface and then stabilized due to capillary flow and subsequent evaporation and evapotranspiration.

Groundwater recharge through infiltration and capillary rise from the shallow watertable are flow components vital to an analysis of the critical groundwater conditions and the salt balance of the rootzone. From a theoretical viewpoint, the two components do not occur simultaneously but rather over fairly long time intervals (e.g. recharge during the irrigation season and capillary rise during the subsequent fall season). The components can appear alternately during a shorter interval (e.g. recharge while irrigation water is being applied and for 2 to 5 days afterwards, and capillary rise during the remaining days until the next irrigation).

Net groundwater inflow can be assessed from the calculation of horizontal and vertical groundwater flows. Let us consider, for example, the difference between lateral groundwater inflow and upward groundwater flow, and between lateral groundwater outflow and downward groundwater flow. Let us call this difference the 'net subsurface inflow' and give it the symbol $Q_{ni} = Q_{gi} - Q_{go}$. Clearly, net subsurface inflow can attain positive and negative values, depending on the differences in watertable elevations between the balance area and the surrounding area. The practical consequences of the value and sign of Q_{ni} are important in the analysis of the groundwater regime prevailing in the balance area.

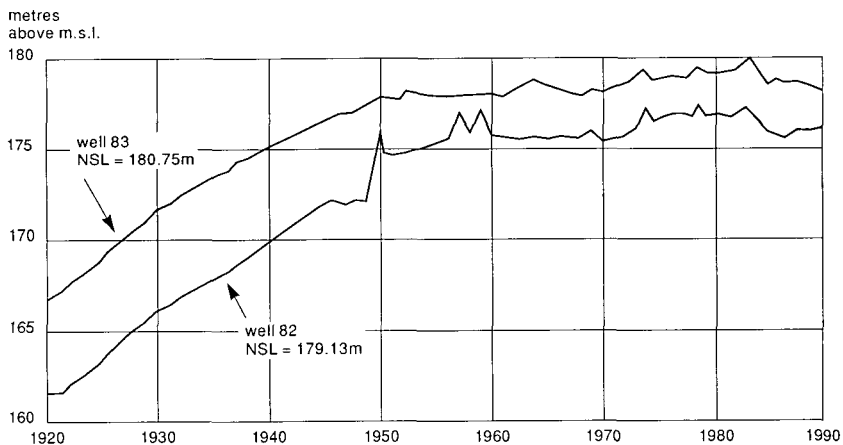

Figure 16.17 Long-term groundwater hydrographs showing rise of the watertable due to irrigation

Negative values of Q_{ni} indicate that the groundwater is being recharged from the top and that there is no danger of cumulative salinization of the rootzone. But if the natural drainage cannot cope with the total recharge from percolation, the watertable will rise to unacceptable heights or remain at already shallow depths, and subsurface drainage will still be necessary to control it.

Positive values of Q_{ni} indicate that groundwater is 'lost'. Under natural conditions this situation often occurs in topographical depressions and low-lying valley bottoms. In these areas, the shallow groundwater system loses part of its water to capillary rise and subsequent evapotranspiration. Artificial drainage is then required to control the watertable and protect the rootzone against cumulative salinization. Positive values of Q_{ni} also occur in areas where groundwater is abstracted by tubewells for drinking water and irrigation. Artificial drainage is usually not required under these conditions.

References

- Boonstra, J. and N.A. de Ridder 1990. Numerical modelling of groundwater basins, 2nd. ed. ILRI Publication 29, Wageningen, 226 p.
- Brown, R.H., A.A. Konoplyantsev, J. Ineson and V.S. Kovalevsky 1977. Groundwater studies – an international guide for research and practice. Studies and reports in hydrology, vol. 7. Unesco, Paris.
- Colenbrander, H.J. 1970. Hydrologisch onderzoek in het Leerinkbeek gebied : 2e interim rapport. Provincie Gelderland, Arnhem, 335 p.
- Dalton, J. 1802. Experiments and observations to determine whether the quantity of rainfall and dew is equal to the quantity of water carried off by the rivers and raised by evaporation, with an enquiry into the origin of springs. Mem. Proc. Lit. Phil. Soc., Manchester 5, part 2, pp. 346-372.
- Dooge, J.C.I. 1984. The water of the earth. Hydrol. Sci. J., 29, 2, 6, pp. 149-176.
- Doorenbos, J. and W.O. Pruitt 1977. Crop water requirements. FAO Irrigation and Drainage Paper 24, Rome, 144 p.
- Feddes, R.A., P. Kabat, P.J.T. van Bakel, J.J.B. Bronswijk and J. Halbertsma 1988. Modelling soil water dynamics in the unsaturated zone – state of the art. J. Hydrol., 100, pp. 69-111.
- IGWMC 1992. IGWMC Software Catalog. Golden, Colorado, 40 p.
- Lohman, S.W. 1972. Groundwater hydraulics. I.S. Geological Survey, Professional Paper 708. U.S. Government Printing Office, Washington, 70 p.
- Schulze, F.E. and N.A. de Ridder 1974. The rising watertable in the West Nubarya area of Egypt. Nature and Resources 10, 1, pp. 12-18.
- Volp, C. and A.C.W. Lambrechts 1988. The SAMWAT database for computer models in water management. SAMWAT Report, 2, The Hague, 142 p.

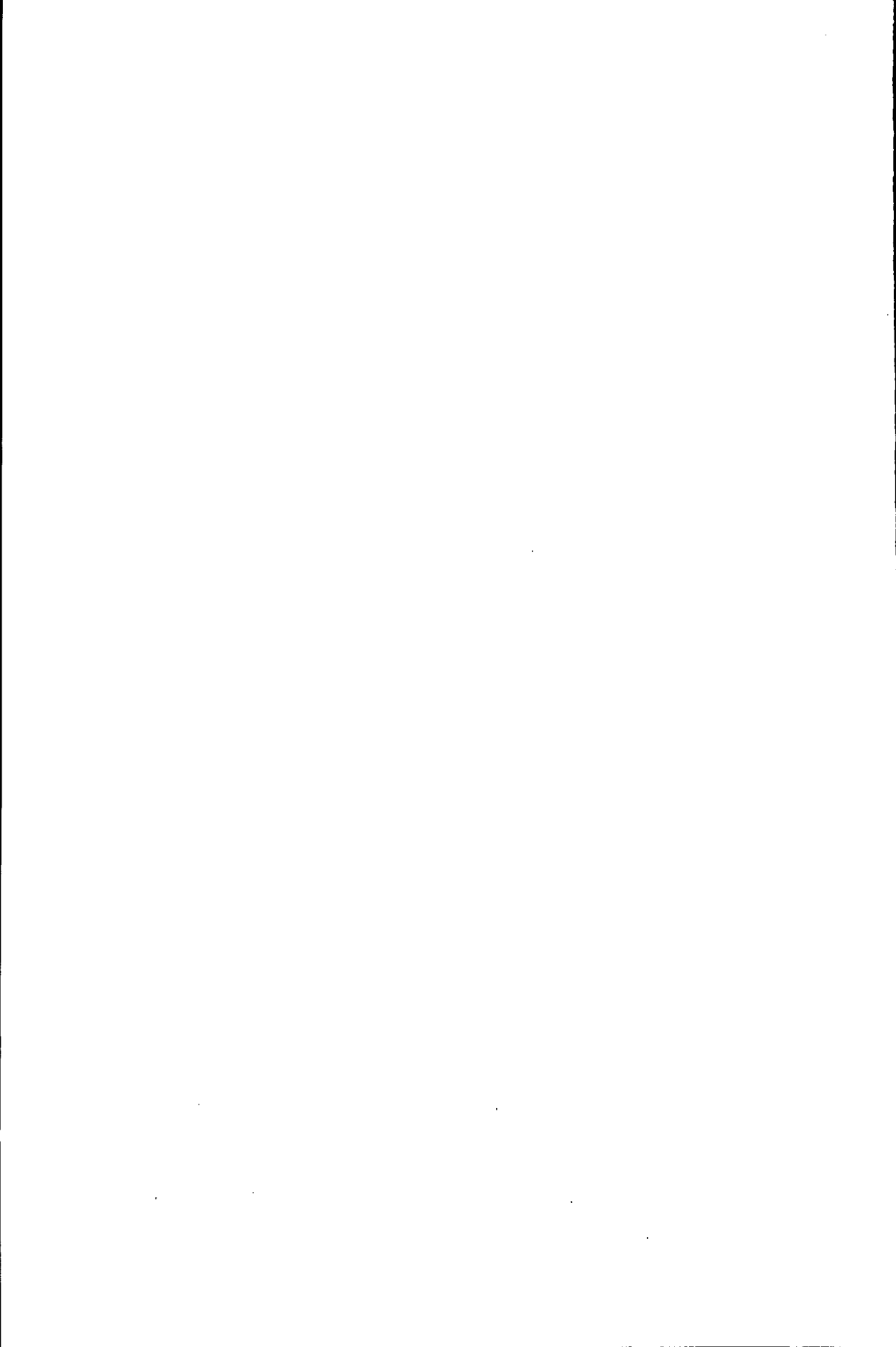

17 Agricultural Drainage Criteria

R.J. Oosterbaan¹

17.1 Introduction

'Agricultural drainage criteria' can be defined as criteria specifying the highest permissible levels of the watertable, on or in the soil, so that the agricultural benefits are not reduced by problems of waterlogging.

If the actual water levels are higher than specified by the criteria, an agricultural drainage system may have to be installed, or an already installed system may have to be improved, so that the waterlogging is eliminated. If, on the other hand, a drainage system has lowered water levels to a depth greater than specified by the criteria, we speak of an over-designed system.

Besides employing agricultural drainage criteria, we also employ technical drainage criteria (to minimize the costs of installing and operating the system, while maintaining the agricultural criteria), environmental drainage criteria (to minimize the environmental damage), and economic drainage criteria (to maximize the net benefits).

This chapter deals mainly with the agricultural criteria. The technical criteria will be discussed in Chapters 19 to 23, but some examples will be given in this chapter. Environmental aspects will be comprehensively treated in Chapter 25, but are also briefly discussed in this chapter.

A correct assessment of the agricultural drainage criteria requires:

- A knowledge of the various possible types of drainage systems;
- An appropriate index for the state of waterlogging;
- An adequate description of the agricultural objectives;
- Information on the relationship between index and objective.

In Sections 17.2 to 17.4, this chapter aims to bring the above subjects into perspective and to illustrate their relationships based on information derived from literature. Section 17.2 concentrates on the types of drainage systems, Section 17.3 on the formulation of drainage criteria, and Section 17.4 on the soil and water factors intermediate between engineering and agriculture. Section 17.5 gives some examples of agricultural and other drainage criteria developed and used in various agro-climatological regions of the world.

17.2 Types and Applications of Agricultural Drainage Systems

17.2.1 Definitions

'Agricultural drainage systems' are systems which make it easier for water to flow from the land, so that agriculture can benefit from the subsequently reduced water

¹ International Institute for Land Reclamation and Improvement

levels. The systems can be made to ease the flow of water over the soil surface or through the underground, which leads to a distinction between 'surface drainage systems' and 'subsurface drainage systems'. Both types of systems need an internal or 'field drainage system', which lowers the water level in the field, and an external or 'main drainage system', which transports the water to the outlet.

A surface drainage system is applied when the waterlogging occurs on the soil surface, whereas a subsurface drainage system is applied when the waterlogging occurs in the soil. Although subsurface drainage systems are sometimes installed to reduce surface waterlogging and vice versa, this practice is not recommended, with exceptions as illustrated in Section 17.2.3. Under certain conditions, combined surface/subsurface drainage systems are feasible (Chapter 21).

Agricultural drainage systems do not necessarily lead to increased peak discharges. Although this may occur, especially with surface drainage, the reduced waterlogging can lead to an increase in the storage of water on or in the soil during periods of peak rainfall, so that peak discharges are indeed reduced (Oosterbaan 1992). A drainage engineer should see to it that the flow of water from the soil occurs as steadily as possible instead of suddenly.

Sometimes (e.g. in irrigated, ponded rice fields), a form of temporary drainage is required whereby the drainage system is only allowed to function on certain occasions (e.g. during the harvest period). If allowed to function continuously, excessive quantities of water would be lost. Such a system is therefore called a 'checked drainage system'. More usually, however, the drainage system should function as regularly as possible to prevent undue waterlogging at any time. We then speak of a 'regular drainage system'. (In literature, this is sometimes also called 'relief drainage'.)

The above definition of agricultural drainage systems excludes drainage systems for cities, highways, sports fields, and other non-agricultural purposes. Further, it excludes natural drainage systems. Agricultural drainage systems are artificial and are only installed when the natural drainage is insufficient for a satisfactory form of agriculture. The definition also excludes such reclamation measures as 'hydraulic erosion control' (which aims rather at reducing the flow of water from the soil than enhancing it) and 'flood protection' (which does not enhance the flow of water from the soil, but aims rather at containing the water in watercourses). Nevertheless, flood protection and drainage systems are often simultaneous components of land reclamation projects. The reason is that installing drainage systems without flood protection in areas prone to inundation would be a waste of time and money. Areas with both flood protection and drainage systems are often called 'polders'. Sometimes, a flood-control project alone suffices to cure the waterlogging. Drainage systems are then not required.

In literature, one encounters the term 'interceptor drainage'. The interception and diversion of surface waters with catch canals is common practice in water-management projects, but it is a flood-protection measure rather than a drainage measure. The interception of groundwater flowing laterally through the soil is usually not effective, because of the low velocities of groundwater flow (seldom more than 1 m/d and often much less). In the presence of a shallow impermeable layer, subsurface interceptor drains catch very little water and generally do not relieve waterlogging in extensive

agricultural areas. In the presence of a deep impermeable layer, the total flow of groundwater can be considerable, but then it passes almost entirely underneath the subsurface interceptor drain. The upward seepage of groundwater cannot be intercepted by a single interceptor drain: here, one needs a regular drainage system.

17.2.2 Classification

Figure 17.1 classifies the various types of drainage systems. It shows the field (or internal) drainage systems and the main (or external) systems. The function of the field drainage system is to control the watertable, whereas the function of the main drainage system is to collect, transport, and dispose of the water through an outfall or outlet.

In the figure, the field drainage systems are differentiated in surface and subsurface drainage systems. The surface systems are differentiated in regular systems and checked systems as defined in Section 17.1.

The regular surface drainage systems, which start functioning as soon as there is an excess of rainfall or irrigation, operate entirely by gravity. They consist of reshaped or reformed land surfaces (Chapter 20) and can be divided into:

- Bedding systems, used in flat lands for crops other than rice;
- Graded systems, used in sloping land for crops other than rice, which may or may not have ridges and furrows.

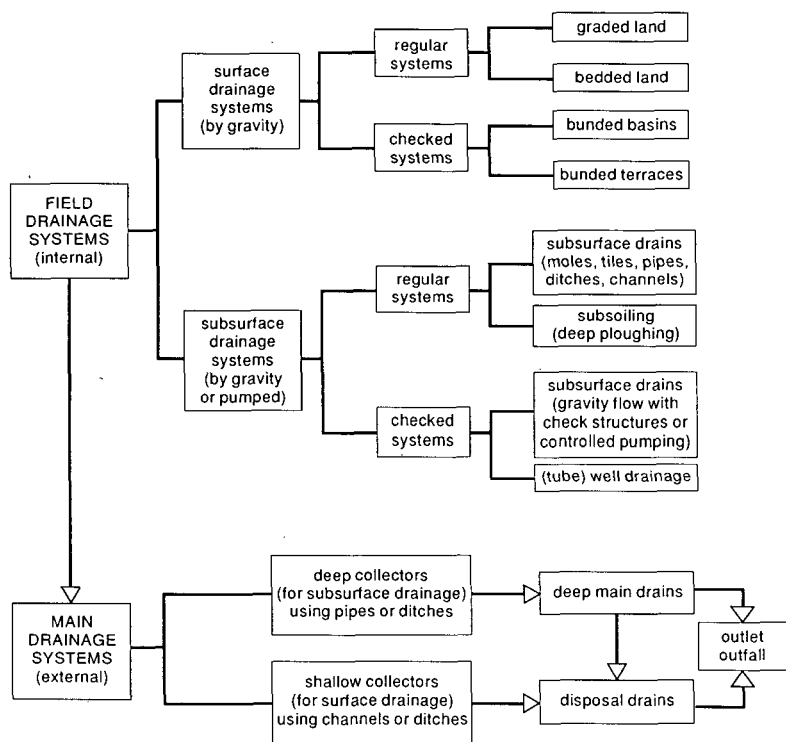

Figure 17.1 Classification of types of agricultural drainage systems

The checked surface drainage systems consist of check gates placed in the bunds surrounding flat basins, such as those used for rice fields in flat lands. These fields are usually submerged and only need to be drained on certain occasions (e.g. at harvest time). Checked surface drainage systems are also found in terraced lands used for rice (Oosterbaan et al. 1987).

In literature, not much information can be found on the relationship between the various regular surface field drainage systems, the reduction in the degree of waterlogging, and the agricultural or environmental effects. It is therefore difficult to develop sound agricultural criteria for the regular surface field drainage systems. Most of the known criteria for these systems concern the efficiency of the techniques of land levelling and earthmoving (Chapter 20). Similarly, agricultural criteria for checked surface drainage systems are not very well known.

Like the surface field drainage systems, the subsurface field drainage systems can also be differentiated in regular systems and checked systems (Figure 17.1). When the drain discharge takes place entirely by gravity, both types of subsurface systems have much in common, except that the checked systems have control gates that can be opened and closed according to need. They can save much irrigation water (Qorani et al. 1990). A checked drainage system also reduces the discharge through the main drainage system, thereby reducing construction costs.

When the discharge takes place by pumping, the drainage can be checked simply by not operating the pumps or by reducing the pumping time. In North-West India, this practice has increased the irrigation efficiency and reduced the quantity of irrigation water needed, and has not led to any undue salinization (Rao et al. 1992).

The subsurface field drainage systems consist of horizontal or slightly sloping channels made in the soil; they can be open ditches, buried pipe drains, or mole drains; they can also consist of a series of wells. The channels discharge their water into the collector or main system either by gravity or by pumping. The wells (which may be open dug wells or tubewells) have to be pumped, but sometimes they are connected to drains for discharge by gravity. In some instances, subsurface drainage can be achieved simply by breaking up slowly permeable soil layers by deep ploughing (subsoiling), provided that the underground has sufficient natural drainage. In other instances, a combination of subsoiling and subsurface drains may solve the problem.

Subsurface drainage by wells is often referred to as 'vertical drainage', and drainage by channels as 'horizontal drainage', but it is better to speak of 'field drainage by wells', or 'field drainage by ditches or pipes'.

The main drainage systems consist of deep or shallow collectors, and main drains or disposal drains (Figure 17.1). Deep collectors are required for subsurface field drainage systems, whereas shallow collectors are used for surface field drainage systems, but they can also be used for pumped subsurface systems. The terms deep and shallow collectors refer rather to the depth of the water level in the collector below the soil surface than to the depth of the bottom of the collector. The bottom depth is determined both by the depth of the water level and by the required discharge capacity.

The deep collectors may either discharge their water into deep main drains (which are drains that do not receive water directly from field drains, but only from collectors), or their water may be pumped into a 'disposal drain'. Disposal drains are main drains

in which the depth of the water level below the soil surface is not bound to a minimum, and the water level may even be above the soil surface, provided that embankments are made to prevent inundations. Disposal drains can serve both subsurface and surface field drainage systems. Deep main drains can gradually become disposal drains if they are given a smaller gradient than the land slope along the drain. The final point of a main drainage system is the gravity outlet structure or the pumping station.

The technical criteria applicable to main drainage systems depend on the hydrological situation and on the type of system. These criteria will be discussed in Chapter 19, but some examples are given in Section 17.5.1 (for temperate humid zones) and in 17.5.4 (for tropical humid zones). Pumping stations will be discussed in Chapter 23 and gravity outlet structures in Chapter 24.

17.2.3 Applications

Surface drainage systems are usually applied in relatively flat lands that have soils with a low or medium infiltration capacity, or in lands with high-intensity rainfalls that exceed the normal infiltration capacity, so that frequent waterlogging occurs on the soil surface.

Subsurface drainage systems are used when the drainage problem is mainly that of shallow watertables. When both surface and subsurface waterlogging occur, a combined surface/subsurface drainage system is required. Sometimes, a subsurface drainage system installed in soils with a low infiltration capacity and a surface drainage problem improves the soil structure and the infiltration capacity so greatly that a surface drainage system is no longer required (De Jong 1979). On the other hand, it can also happen that a surface drainage system diminishes the recharge of the groundwater to such an extent that the subsurface drainage problem is considerably reduced or even eliminated.

The choice between a subsurface drainage system by pipes and ditches or by tubewells is more a matter of technical criteria and costs than of agricultural criteria, because both types of systems can be designed to meet the same agricultural criteria and achieve the same benefits. Usually, pipe drains or ditches are preferable to wells. However, when the soil consists of a poorly permeable top layer several metres thick, overlying a rapidly permeable and deep subsoil, wells may be a better option, because the drain spacing required for pipes or ditches would be very narrow whereas the well spacing can be very wide.

When the land needs a subsurface drainage system, but saline groundwater is present at great depth, it is better to employ a shallow, closely-spaced system of pipes or ditches instead of a deep, widely-spaced system. The reason is that the deeper systems produce a more salty effluent than the shallow systems. Environmental criteria may then prohibit the use of the deeper systems.

In some drainage projects, one may find that only main drainage systems are envisaged. The agricultural land is then still likely to suffer from field drainage problems. In other cases, one may find that field drainage systems are ineffective because there is no main drainage system. In either of these cases, the installation of an incomplete drainage system is not recommended.

17.3 Analysis of Agricultural Drainage Systems

17.3.1 Objectives and Effects

The objectives of agricultural drainage systems are to reclaim and conserve land for agriculture, to increase crop yields, to permit the cultivation of more valuable crops, to allow the cultivation of more than one crop a year, and/or to reduce the costs of crop production in otherwise waterlogged land. Such objectives are met through two direct effects and a large number of indirect effects.

The direct effects of installing a drainage system in waterlogged land are (Figure 17.2):

- A reduction in the average amount of water stored on or in the soil, inducing drier soil conditions and reducing waterlogging;
- A discharge of water through the system.

The direct effects are mainly determined by the hydrological conditions, the hydraulic properties of the soil, and the physical characteristics of the drainage system. The direct effects trigger a series of indirect effects. These are determined by climate, soil, crop, agricultural practices, and the social, economic, and environmental conditions. Assessing the indirect effects (including the extent to which the objectives are met) is therefore much more difficult, but not less important, than assessing the direct effects.

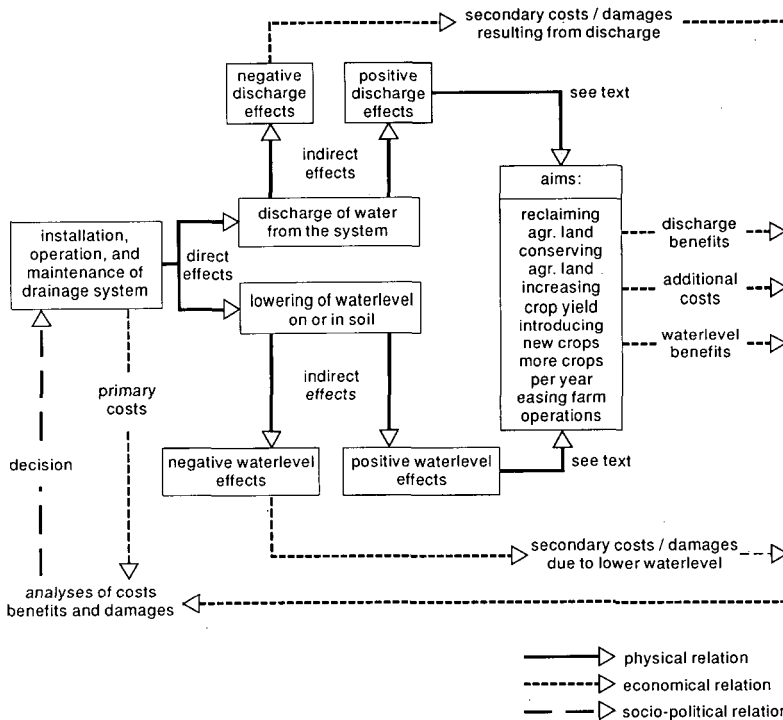

Figure 17.2 Diagram of the effects of drainage on agriculture and the economic evaluation

The indirect effects, which can be physical, chemical, biological, and/or hydrological, can be either positive or negative. Some examples are:

- Positive effects owing to the drier soil conditions: increased aeration of the soil; stabilized soil structure; higher availability of nitrogen in the soil; higher and more diversified crop production; better workability of the land; earlier planting dates; reduction of peak discharges by an increased temporary storage of water in the soil;
- Negative effects owing to the drier soil conditions: decomposition of organic matter; soil subsidence; acidification of potential acid sulphate soils; reduced irrigation efficiency; increased risk of drought; ecological damage;
- The indirect effects of drier soil conditions on weeds, pests, and plant diseases: these can be both positive and negative; the net result depends on the ecological conditions;
- Positive effects owing to the discharge: removal of salts or other harmful substances from the soil; availability of drainage water for various purposes;
- Negative effects owing to the discharge: excessive leaching of valuable nutrients from the soil; downstream environmental damage by salty or otherwise polluted drainage water; the presence of ditches, canals, and structures impeding accessibility and interfering with other infrastructural elements of the land.

Many of the indirect effects are mutually influenced and also exert their influence on the direct effects. For example, as a result of drainage, the following may happen:

- The more intensive agriculture increases the evapotranspiration and consequently may reduce the discharge, unless this leads to an increased irrigation intensity;
- The more stable soil structure may increase the infiltration and the subsurface drain discharge, and decrease the surface runoff.

Both of the above effects sometimes neutralize each other so that the drain discharge is not appreciably affected.

The above considerations illustrate that, in developing agricultural drainage criteria, one needs a clear conceptual framework and a systems approach. Rules of thumb may be useful in the initial stages of reclaiming land by drainage, but subsequently a systematic monitoring program is required to validate or improve the criteria used with the aim, in the future, of avoiding ineffective and inefficient drainage systems and of mitigating negative effects.

17.3.2 Agricultural Criterion Factors and Object Functions

In agricultural drainage, one is dealing with agricultural, environmental, engineering, economic, and social aspects.

The agricultural aspects concern 'object factors' and 'criterion factors'. Object factors represent the agricultural aims (Figure 17.2) that are to be achieved to the highest possible degree (maximization) through a process of optimization, yielding 'agricultural targets' (see the insert in Figure 17.3). Optimizing is done with criterion factors, which are factors that are affected by the drainage system and at the same time influence the object factors.

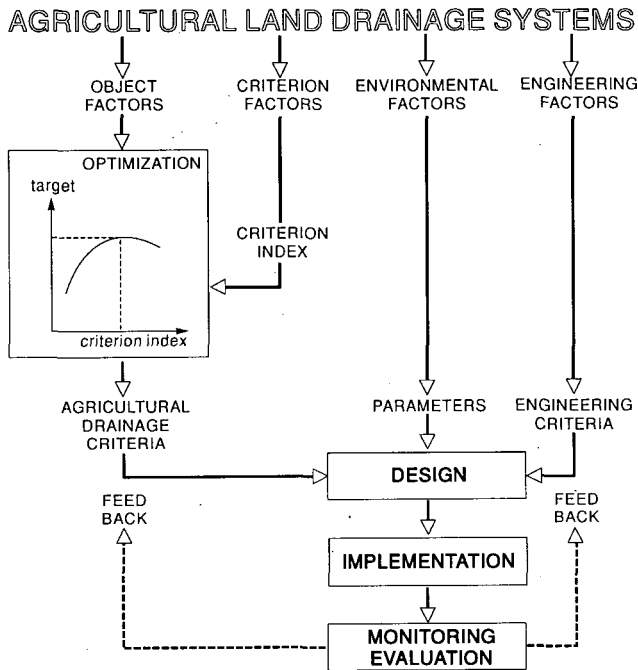

Figure 17.3 The role of agricultural, environmental, and engineering factors in the optimization, design, and evaluation of drainage systems

Examples of criterion factors are the degree of waterlogging, the dryness or wetness of the soil, and the soil salinity.

Owing to its variation in time and space, a criterion factor can be specified in different ways. A chosen specification can be called a 'criterion index'. Examples of such indices are:

- The average depth of the watertable during the cropping season;
- The average depth of the watertable during the off-season;
- The exceedance frequency of the watertable over a critically high level;
- Seasonal average salinity of the rootzone;
- Salinity of the topsoil at sowing time;
- Average, minimum, or maximum number of days that the soil is workable during a critical period.

The relationship between an object factor and an index can be called 'object function of the index' and is also known as 'response function' or 'production function'.

The optimization procedure through the object function leads to a tolerance, or even an optimum, value of the index, which can be called an 'agricultural drainage criterion'. It serves as an instruction to the designer of the drainage system because it stipulates the agricultural condition the system must meet to be effective (i.e. to fulfil its purpose). Also, the instruction can prevent the design and implementation of a system that is unnecessarily intensive, expensive, and even detrimental (Oosterbaan 1992).

'Environmental factors' are factors representing the given natural or hydrological conditions under which the system has to function. Examples of these factors are irrigation, rainfall, the soil's hydraulic conductivity, natural surface or subsurface drainage, topography, and aquifer conditions.

For design purposes, the environmental factors must be specified as 'environmental indices', in the same way as the criterion factors are specified as criterion indices. Examples of environmental indices are the average seasonal rainfall, the extreme daily rainfall, the arithmetic or geometric mean of the hydraulic conductivity, and the variation in hydraulic conductivity with depth in the soil. Through a process of optimizing the engineering aspects, the environmental indices yield 'environmental parameters', which are fixed values of the indices, chosen as engineering or design criteria, in similarity to the agricultural criteria. Examples of such parameters are design values for rainfall, discharge, and hydraulic conductivity.

The engineering aspects include 'engineering factors' and 'engineering objectives'. The objectives usually aim at minimizing the costs, and relate to the efficiency of the drainage system. A fully efficient drainage system fulfils the agricultural criteria at the lowest possible input level of materials and finances.

The engineering factors are factors representing the technical and material components of the drainage system (e.g. the layout, the longitudinal section and the cross-section of the drains, and the kind and quality of materials). The choice of the engineering factors is specified in the tender documents produced after the design has been completed.

Optimizing the engineering aspects results not only in environmental parameters, but also in 'engineering criteria'. Both serve as instructions to the designer of the drainage system to secure an efficient design. The engineering criteria, which aim at minimizing costs, can also be called 'efficiency criteria', whereas the agricultural criteria, which aim at maximizing benefits can also be called 'effectiveness criteria'. Engineering criteria will be discussed in Chapters 19-22.

After the design procedure has been completed, and before the drainage project can be offered for implementation, it has to be analyzed on costs, benefits, and side-effects. Through a survey of environmental factors, the agricultural criteria provide tools for an estimate of the drainage needs and the expected benefits. For example, with criteria specifying a minimum permissible depth of the watertable and a depth-to-watertable map, one can judge the extent of the drainage problems. With the response function, the expected benefits can also be estimated, assuming a drainage system is installed that meets the criteria. Examples of such an analysis are given by Nijland and El Guindy (1984) and Oosterbaan et al. (1990).

Summarizing, one can say that the role of agricultural criterion factors and indices, and their object (production) functions, is threefold:

- They serve to assess the magnitude of drainage problems in hitherto undrained lands and to predict the benefits of a drainage system;
- They serve to develop agricultural drainage criteria and instructions to the designer of the drainage system so that the system fulfils the agricultural objectives;
- They serve to check the (agricultural) effectiveness of a drainage system after its implementation and to assess the need for upgrading the system.

17.3.3 Watertable Indices for Drainage Design

Presented in this section are examples of how the depth of the watertable below the soil surface is used as a criterion factor for the development of watertable indices and agricultural criteria for the design of a subsurface drainage system.

The depth of the watertable is often used as a criterion factor because it can be related to crop production on the one hand, and to drain depth and spacing on the other. Since the watertable in the soil fluctuates with time, as illustrated in Figure 17.4, the behaviour of the watertable has to be characterized by an appropriate index. Various indices that feature the average depth and extremely shallow depths have been developed. The relevant question is: 'Which of the indices is better?' Before this question can be answered, a depth-duration-frequency analysis of the watertable has to be made.

Figure 17.5 shows a typical frequency distribution of the daily average depth of the watertable. The distribution is skew with mode > median > mean (Chapter 6). It has a considerable standard deviation, and the 10% and 1% extremely shallow depths deviate much from the mean, mode, and median.

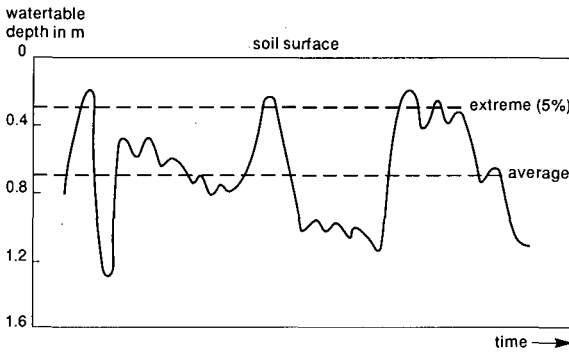

Figure 17.4 A fluctuating watertable with an indication of the average depth and an infrequent shallow depth of the watertable

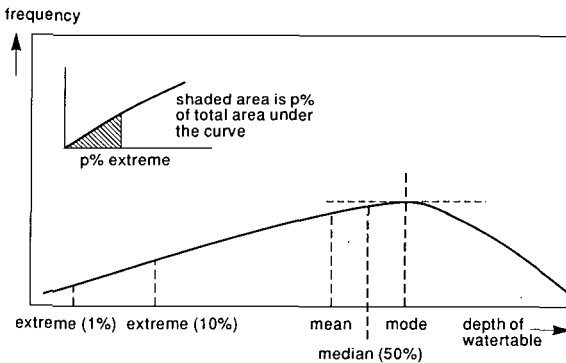

Figure 17.5 A frequency distribution of the daily average watertable depths with some of its characteristic values

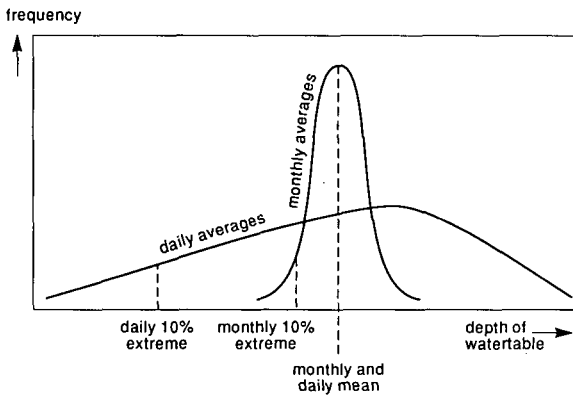

Figure 17.6 Frequency distributions of daily average and monthly average depths of the watertable

Figure 17.6 shows the same distribution together with the frequency distribution of the monthly averages. As can be seen, the mean values of the daily and monthly averages coincide, but the standard deviation of the monthly averages is much smaller than that of the daily averages, and the monthly extremes are much closer to the mean. Hence, the longer the duration that is taken, the better the mean value represents the frequency distribution. It depends on the crop-response function whether the mean value over a long duration can be used as a watertable index, or whether short-term extreme values, even though they occur infrequently, need to be considered.

Figure 17.7 shows the production of sugarcane as a function of the average depth of the watertable during the growing season from December to June (indicated by circles), and the number of days during which the watertable is shallower than 0.5 m below the soil surface in the same period (indicated by dots). The function shows that both indices give the same result, because the long-term average depth and the number of extremely shallow depths are apparently strongly correlated. This is logical because, when the average depth is great, a shallow depth is relatively infrequent, and vice versa. Therefore, if one employs either of these indices, the other will not provide any additional explanation of variations in yield. In this example, it is better to use the seasonal average depth as an index because it can be determined with a higher statistical certainty and it leads to a simpler design procedure than when the number of exceedances of a reference level needs to be taken into account.

If the yield data of Figure 17.7 represent random samples from an area, the figure also shows that a large part of the area has serious drainage problems and that, if a drainage project could ensure a seasonal average watertable depth of 0.75 m, or somewhat deeper, a large production increase could result. This increase can be calculated from the data by a segmented linear regression analysis (Chapter 6; Oosterbaan et al. 1990).

In literature, the following watertable indices have been used:

- 1) The depth of the watertable at harvest date (Oosterbaan 1982);
- 2) The average depth of the watertable during a season with rainfall excess (Figures 17.7 and 17.8);
- 3) The average depth of the watertable during the irrigation season (Figure 17.9; Nijland et al. 1984; Safwat Abdel-Dayem and Ritzema 1990);

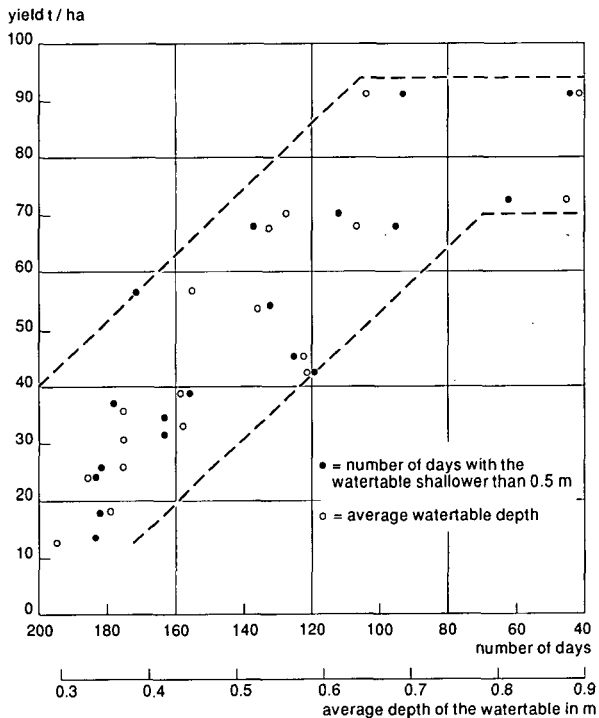

Figure 17.7 A plot of yield data of sugar cane versus average depth of the watertable and number of days with a watertable shallower than 0.5 m during the growing season from December to June in N. Queensland, Australia (Rudd and Chardon 1977)

- 4) The frequency or number of days during the growing season with a watertable shallower than a certain reference level (Figure 17.7; Doty et al. 1975);
- 5) The Sum of the Exceedances (SE_x) of daily watertables over a fixed reference level at x cm below the soil surface (Figure 17.10; Sieben 1965; Feddes and Van Wijk 1977);
- 6) The time it takes for the watertable to fall from a certain critically high level to a safe lower level (Figure 17.11).

The first index is easily determined. Although it is a once-only reading, it can sometimes be representative of the watertable regime. Nevertheless, literature does not provide much information on the value of this index and it will therefore not be further discussed.

The second index is useful in areas with a pronounced humid period. The example given in Figure 17.8 concerns an area in England. It illustrates the effect of off-season drainage, because in England the growing period is in summer whereas the data on the watertable depth were collected in winter. It appears that the depth in winter exerts a marked influence on the yield in summer, probably because a well-drained soil warms up faster in spring than a waterlogged soil, so that crop growth can start earlier. Also, waterlogging in spring may create unfavourable chemical or physical soil conditions. In summer, there is usually no drainage problem in England because the evapotranspiration is then much higher than in winter, and the watertables are therefore deep (> 1 m).

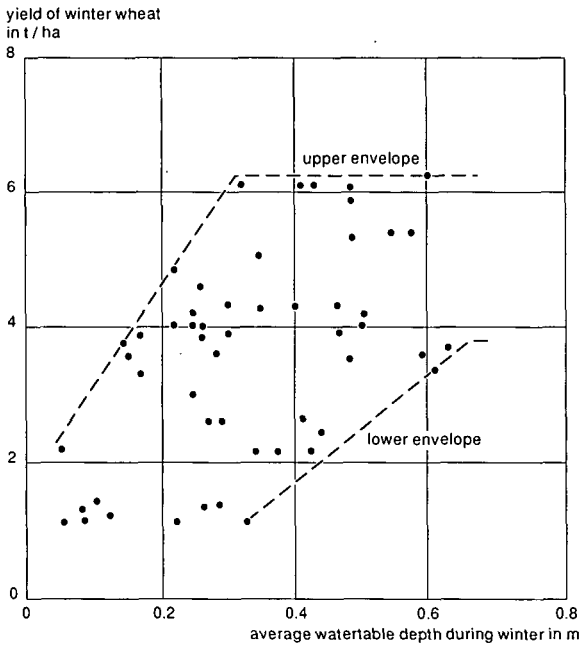

Figure 17.8 A plot of the yield of winter wheat versus average depth of the watertable in winter in a heavy clay soil; 5 years of observation (unpublished data, FDEU, Min. Agr., U.K.)

From the data of Figure 17.8, we can conclude that, if drainage could maintain the watertable in winter at an average depth of 0.50 m or more, a considerable yield benefit would result. This depth would be a good agricultural drainage criterion for the area in which the data were collected. The trend in the figure suggests that maintaining an average watertable deeper than 0.60 m would be excessive: the costs would be higher and there would be no additional crop response.

The data of Figure 17.8 also reveal that, under good agricultural conditions (represented by the upper envelope), the permissible average depth of the watertable (about 0.30 m) is shallower than the permissible depth (about 0.60 m) under poor agricultural conditions (represented by the lower envelope). It appears that, in this example, favourable agricultural conditions compensate for unfavourable watertable depths. Further, the data show that the relationship between crop production and depth of the watertable is subject to considerable scatter, which is logical because crop production is not determined exclusively by the depth of the watertable but by many other agricultural conditions. The data of Figure 17.8, which were collected in farmers' fields, are more representative of reality than data obtained under controlled conditions where only the drainage situation is varied and all other production factors are kept constant.

The third index, used in the example of Figure 17.9, shows that the critical value of the average seasonal depth of the watertable in irrigated cotton fields in the Nile Delta is about 0.90 m. This would be a good field drainage criterion. The figure shows that a small majority of the data (about 60%) are found in the range of watertable depths of over 0.90 m (the safe depth). This indicates that the yield increase of a

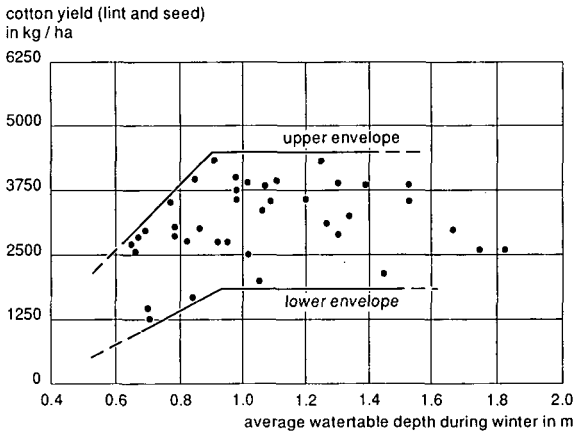

Figure 17.9 A plot of cotton yield (lint + seed) versus average depth of the watertable in the Nile Delta, Egypt (Nijland and El Guindy 1984)

drainage project would be less than in the example of Figure 17.8, where the vast majority of the data (about 90%) are below the safe depth. Unlike Figure 17.8, Figure 17.9 makes no distinction between the breakpoints of upper and lower envelope. For the rest, many of the conclusions drawn from Figure 17.8 are also applicable to Figure 17.9.

Together with the second index, the fourth index is shown in the example of Figure 17.7 and needs no further discussion.

The fifth index (the SE_x value; Figure 17.10) was developed by Sieben (1965). Figure 17.10, referring to the same cotton experiments as in Figure 17.9, reveals that the yield does not respond much to the SE_x index. Therefore, in the example given, the SE_x index has less value for the development of a drainage criterion than the second index used in Figure 17.9. It appears that short-term exceedances of the watertable over a shallow reference level are not harmful for irrigated cotton. This may be explained by the fact that irrigation supplies are usually much more regular in magnitude and time than rainfall is. In addition, the regular irrigation may be

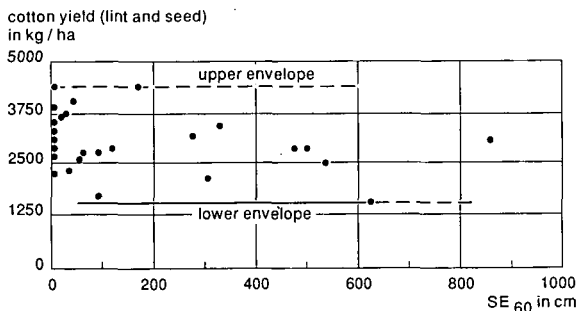

Figure 17.10 A plot of cotton yield (lint + seed) versus SE_{60} in farmers' fields in the Nile Delta (Advisory Panel 1982)

number of workable days,
 Mar 15 - Apr 15
 5 years return period

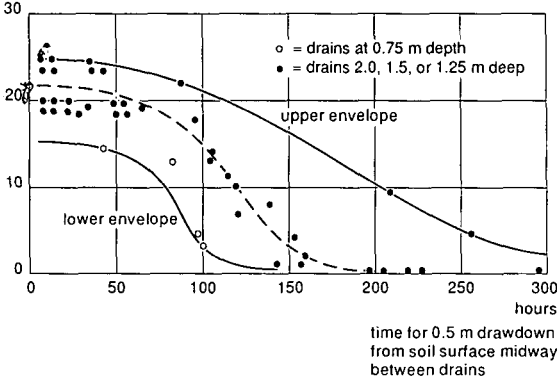

Figure 17.11 A plot of drawdown time of the watertable versus number of workable days for different drainage systems in North Carolina, U.S.A. (Skaggs 1980)

instrumental in expelling the noxious gasses formed in the soil by the plant roots, whereas the subsequent evaporation enhances the entry of fresh air into the soil. Only long-term shallow depths of the watertable appear to be damaging.

In literature, not many examples can be found of the sixth index for crop production. Therefore, instead of crop yield, the workability of land was chosen as an object factor as shown in Figure 17.11. This figure, like the previous ones, shows a large scatter of data. Yet it permits the conclusion that the longest permissible time of drawdown from the soil surface to a depth of 50 cm is about 75 hours or about 3 days. With a shorter drawdown time (i.e. with a faster drawdown rate), the number of workable days does not increase, and its maximum value is about 20 days a month.

The drawdown rate of the watertable as a criterion index should be used with great care, because it does not specify how frequently the watertable rises to critically high levels. If not used with care, one runs the risk of developing drainage criteria for situations that seldom occur.

17.3.4 Steady-State Versus Unsteady-State Drainage Equations

In the design procedure, given the proper criteria and the correct environmental parameters, one can use steady-state and unsteady-state equations (Chapter 8) to determine the required characteristics of the drainage system (e.g. the depth and spacing of the drains). Both types of equations use the recharge to the drainage system, which can be found from the groundwater balance (Chapter 16). After introducing a drainage term q_d , we can rewrite Equation 16.5 as

$$q_d = R_d - \mu \frac{\Delta h}{\Delta t} \quad (17.1)$$

q_d = drain discharge (mm/d)
 R_d = net recharge rate (mm/d)

- μ = drainable pore space (-)
 Δh = change in watertable depth (m)
 Δt = period (d)

In a steady-state situation, the net recharge rate (R_d) equals the drain discharge (q_d) and the watertable is at the same level at the beginning and the end of the period (Δt) under consideration.

In unsteady-state, recharge and discharge are not equal. When $R_d > q_d$, the watertable is rising, and the discharge q_d increases and tends to become equal again to the recharge R_d . When $R_d < q_d$, a reverse process occurs. Hence, under natural conditions with a varying recharge over time, the watertable fluctuates about a certain equilibrium level: its average depth (Figure 17.4). The storage $\mu\Delta h$ is therefore a temporary, dynamic storage, which is needed to induce the drain discharge q_d . It is discerned from the storage of water which will not reach the drains and which can be called 'dead storage'.

Over a long time span (e.g. a season), the change in water level Δh is small compared with the recharge and the discharge, so that Equation 17.1 can be simplified to $q_d = R_d$ (i.e. the steady state). The expression 'steady state' does not deny that the watertable fluctuates during the period under consideration, and it would therefore also be possible to speak of an 'average state' or a 'dynamic equilibrium'.

If a better explanation of the yield variation is provided when the criterion index is taken as the average depth of the watertable over a prolonged period of time (e.g. a season), rather than the index representing short-term (e.g. daily) extreme values, it follows that the drainage design is preferably made with steady-state drainage equations.

The long-term, steady-state index of the watertable can also give a significant explanation of such object factors as the workability of the land and the subsidence of peat soil (Section 17.4.3). The design of drainage systems that have to take workability and subsidence into account can therefore also be done with steady-state equations.

When steady-state equations are used, the design drain discharge is taken equal to the average net recharge over the period of time used for the criterion index.

The steady-state drainage equations are easier to apply than the unsteady-state equations (e.g. the drainable porosity, μ , need not be known). In addition, the long-term averages can be determined with a higher statistical reliability than short-term extremes.

When the relationship between the level of the watertable and the object factor indicates that short-term extreme levels are more decisive than the long-term averages, the choice between steady-state and unsteady-state equations is determined by the ratio of the storage capacity of the envisaged drainage system to the volume of the infrequent, extreme, recharge and discharge over the defined short period (Oosterbaan 1988). This volume is usually so high in comparison with the storage capacity that storage effects can be neglected. Consequently, steady-state equations can also be used for drainage systems that have to cope with infrequent, extreme discharges of short duration. For example, collector and main drains are often required to cope with 24-hour design discharges having return periods of 10 years or more. Such discharges are so high that the volume of water transported through the drain in one day is very

large compared with the volume of water stored in the drain. Hence, the Manning equation can be used to determine the system's dimensions and discharge capacity (Chapters 19, 20, and 21).

17.3.5 Critical Duration, Storage Capacity, and Design Discharge

The maximum permissible length of the period (the critical duration) to be used for the watertable index, and the degree to which this index explains the yield, are influenced by the storage capacity of the drainage system. The critical duration and storage capacity determine the design discharge, as will be explained below.

Reducing the surface or subsurface waterlogging by drainage creates a potential for both dynamic and dead storage of water during periods of peak recharge. Thus the drainage system creates a buffer capacity in the soil, ensuring that the discharge is steadier and smaller than the recharge. A large buffer capacity permits the adoption of a longer period of critical duration and the use of average recharge and discharge rates over this period. In contrast, a small buffer capacity needs an assessment of the infrequent, extreme, recharge and discharge rates and the adoption of shorter periods of critical duration.

Tubewell drainage systems, which can lower the watertable to a great depth (5 to 10 m), create a large buffer capacity. For these systems, the seasonal or yearly average depth of the watertable can be used as a criterion factor. In the water balance over the corresponding long period of time, the change in storage can be ignored. Consequently, one can calculate the design discharge from the average net recharge over a full season or year, and apply steady-state well-spacing formulas (Chapter 22).

Field drainage systems by pipes or ditches create a medium storage capacity. In regions with low rainfall intensities (say less than 100 mm/month) and in irrigated lands in arid or semi-arid regions, one can base the drainage design on average monthly or seasonal water levels, taking into account the month or season with the highest net recharge. As the change in storage over such periods is still small, the design discharge can be calculated from the average net recharge over the corresponding critical period.

In regions having seasons with high rainfall (say more than 100 mm per month), it is likely that the problem is one of surface drainage (i.e. waterlogging on the soil surface) rather than of subsurface drainage. Here, a subsurface system would not be appropriate, or it could be combined with a surface system. In a combined system, the design discharge of the subsurface system has to be calculated from a water balance after the discharge from the surface system has been deducted.

A surface field drainage system, consisting of beddings in flat lands or mildly graded field slopes in undulating lands, creates only small capacities for storage. Critical periods are therefore short (say 2 to 5 days). The design discharge must then be based on the recharge over the same short period, taking into account a recharge rate that is exceeded once or only a few times a year, or even once in 5 to 10 years. Surface systems that are able to cope with such rare recharges will also considerably reduce crop damage from any waterlogging that results from even more intensive, though more exceptional, recharges. The use of the water-level index as a criterion factor for surface field drainage systems is not common. This is because, unlike a subsurface

field drainage system, the design of a surface field drainage system cannot easily be derived from such an index.

The design criteria for collector drainage systems depend on the type of field drainage system. When a collector drain serves subsurface systems only, its water level must be deep enough to permit the free outflow of water from the field drains. As the storage capacity of the collectors is relatively small, their design discharge is not based on the average monthly or seasonal discharge of the field drains, but on a higher, though less frequent, peak discharge as may occur during a shorter period (e.g. 10 days). Subsequently, the cross-section of the collectors can be calculated with Manning's steady-state formula.

When ditches are used as collectors for subsurface drainage systems, they are preferably narrow and deep to maintain a deep water level. For a collector that serves surface field drainage systems only, its water level can be much shallower and may come close to the soil surface. However, as the design of surface systems is based on the less frequent peak discharge of a shorter critical duration, and as the collector system has even less storage capacity than the field system, its design discharge is taken higher than that of the field drains. Manning's formula can also be used to calculate the cross-sections of collector drains for surface field drainage. In contrast to the narrow cross-sections of collectors for subsurface field drainage, those for surface field drainage are preferably wide and shallow.

When a collector drain serves both surface and subsurface field drainage systems, one often uses a combination of criterion values for the water level in the collector: there is a high water-level criterion (HW criterion) and a normal water-level criterion (NW criterion). Each of these levels is specified with a certain tolerable frequency of exceedance. The corresponding discharge requirement (design discharge) can then be calculated from a water balance. How the capacity and dimensions of the collector system are calculated will be illustrated in Section 17.5.1.

An example of the influence of the length of the critical duration on the average design discharge is presented in Table 17.1. It shows that the design discharge for drainage by pumped wells, with a critical duration of 6 to 12 months, can be taken as 1.1 to 1.6 mm/d, whereas drainage by pipes or ditches, with a critical period of 1 month to a growing season, requires a design discharge of 2.6 to 2.8 mm/d.

17.3.6 Irrigation, Soil Salinity, and Subsurface Drainage

Subsurface drainage systems are often used in irrigated, waterlogged, agricultural lands in arid and semi-arid regions to reduce or prevent soil salinity. The salt balance of these lands depends largely on the water balance, in which the amount of irrigation water is a dominant term (Chapter 15). When sufficient irrigation water is applied, the effect of drainage on the salt balance stems from the discharge of salts along with the drainage water. Hence, drainage for salinity control is primarily based on the discharge effect rather than on a lowering of the watertable. Criteria for salinity control should therefore be sought in the amount of irrigation water needed to provide sufficient leaching, rather than in the depth of the watertable.

With a well-designed and properly-operated irrigation system, the watertable need not be kept at extra deep levels to control soil salinity. If, on the other hand, the

Table 17.1 Average drainage rate (mm/d) as a function of length of the critical period in an irrigated area of Iraq (Euroconsult 1976)

Crop	Peak month	Growing season	Peak half year	Whole year
Wheat	2.0	1.6	-	-
Maize	3.0	2.3	-	-
Potatoes	4.5	2.6	-	-
Combination *	2.8	-	1.6	1.1

* A cropping pattern of 2/3 winter wheat, 1/3 spring potatoes and 1/3 summer maize

irrigation system is poorly designed and operated, even maintaining very deep watertables will not alleviate soil salinity. For example, Safwat Abdel-Dayem and Ritzema (1990) and Oosterbaan and Abu Senna (1990) have shown that, for Egypt's Nile Delta, average seasonal depths of the watertable in the range of 1.0 to 1.2 m are amply sufficient for effective salinity control, whereas maintaining deeper watertables may even negatively affect the irrigation efficiency. Also Rao et al. (1990) have shown that the time-averaged depth of the watertable during the critical drainage season (i.e. the monsoon season) need not be much more than 0.8 m below the soil surface to allow the adequate reclamation of saline soils.

Often, one relates the required depth of the watertable for salinity control to the upward capillary flow in the soil resulting from a constant depth of the watertable and a very dry topsoil. Such conditions imply that, in the absence of irrigation or rain, there is a steady upward seepage of groundwater from the aquifer. When such lands are irrigated and drained, these capillary-flow conditions no longer exist. Instead, there is a net downward percolation of water through the soil. Van Hoorn (1979) therefore writes: 'The argument for applying deep drainage systems to reduce capillary flow is often used in cases for which it is not valid.'

In semi-arid regions with pronounced wet and dry seasons, it is possible to restrict the drainage to the wet season only. The evacuation of salts during this period is sufficient to maintain a favourable salt balance in the soil, even though some resalinization may take place during the dry season. In addition, the use of salty drainage water with an electrical conductivity up to 10 dS/m for irrigation in the dry season does not negatively affect yields as long as sufficient leaching occurs in the wet season to prevent any annual salt accumulation (Sharma et al. 1990).

Using drainage water for irrigation in the dry season and evacuating it only in the wet season has two advantages:

- In the dry season, when the evacuation of salty drainage water into rivers with a low discharge is environmentally undesired, and when irrigation water is scarce, the drainage water can be used for additional irrigation and environmental problems are avoided;
- In the wet season, when the evacuation of salty drainage water into rivers with a high discharge is environmentally acceptable, and when irrigation is only complementary to rainfall, the drainage water can be evacuated for salinity control.

Rao et al. (1992) describe a successful experiment in which the drainage is completely stopped during the dry season so that the crops can profit from the capillary rise, and scarce irrigation water is saved.

Comparing the discharge from a drainage system in irrigated lands with that from rain-fed lands, we find that the discharge from irrigated lands is more regular. The reason is that the rainfall regime is usually erratic and the irrigation regime is not. This explains why, in irrigated lands, the steady-state drainage criteria are often successfully applied. The main reason for this is that the recharge from irrigation water is irregularly distributed in space, because the fields are not all irrigated at the same time. Thus, the resulting groundwater flow is three-dimensional because the flow occurs both in the direction of the drains and in the direction of neighbouring fields that have not recently been irrigated and therefore have a lower watertable than the irrigated field. This means that two-dimensional unsteady-state drainage formulas cannot be used. In the long run, the flow of groundwater from one field to the other can be ignored because, on other occasions, when the second field is irrigated and the first field is not, the direction of the groundwater flow is reversed. Hence, the two-dimensional steady-state drainage formulas indeed remain applicable, at least when the watertable index shows that long-term averages can be used, as was discussed in Section 17.3.3.

The design discharge of subsurface drainage systems in irrigated land is often determined on the basis of the field irrigation efficiency (Chapter 14) and the leaching requirement for salinity control (Chapter 15). Usually, the irrigation efficiency is quite low owing to high percolation losses, and the leaching requirement is therefore amply satisfied. When, in addition, rainfall also contributes to the leaching, the leaching requirement need not feature as a design factor. If, on the other hand, the irrigation is insufficient to produce the required leaching, a drainage system based on the leaching requirement will be ineffective for salinity control.

The leaching requirement for salinity control is based on a 'leaching efficiency', but, in irrigated arid lands with very little rainfall, the irregularity with which the irrigation water is distributed over the field also has to be taken into account. Here, we should distinguish between 'systematic irregularity' and 'random irregularity'.

Systematic irregularity stems from the irrigation technique. With surface-flow irrigation in basins, furrows, or border strips, the irrigation water is normally introduced at one end of the field. While running down the field, the water infiltrates into the soil. As the contact time between water and soil is longer in the upstream part of the field than in its downstream part, more water infiltrates at the upper end

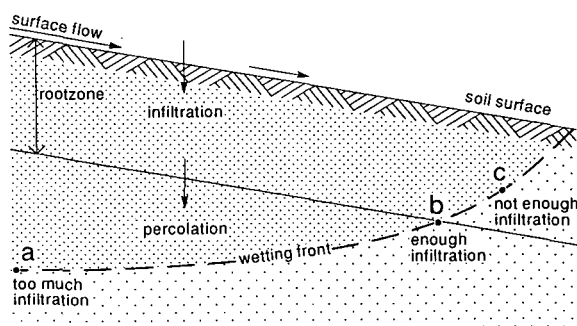

Figure 17.12 Illustration of the systematic irregularity in the spatial distribution of the deep percolation in an irrigated field

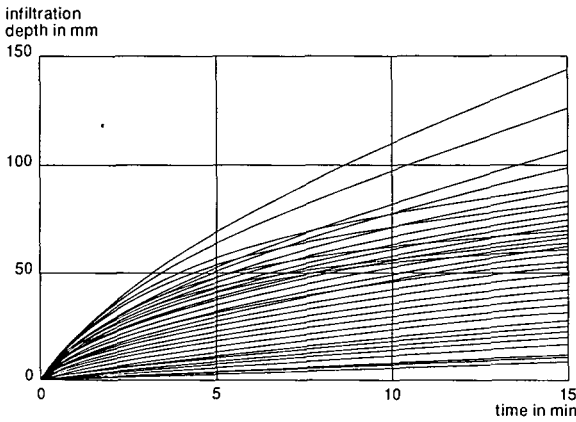
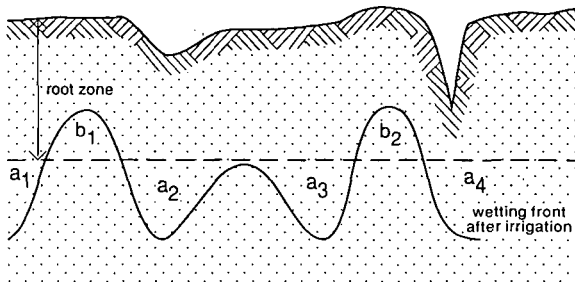

Figure 17.13 Accumulated infiltration versus time measured with 63 infiltrometers set at 1.0 m spacing on a 7 by 9 m grid in a sandy loam soil (Jaynes et al. 1988)

than at the lower end (Figure 17.12). Hence, the leaching requirement is sometimes not covered in the lower parts, where insufficient deep percolation takes place and where salinization may occur even though there is a low field irrigation efficiency.

The random irregularity stems from natural random differences in infiltration capacity (Figure 17.13) and in the water-holding capacity of the soil, as well as from irregularities in the surface level of the soil. This is illustrated in Figure 17.14. In places where the soil surface has a relatively high elevation, even if the difference is only a few centimetres, or in places with a low infiltration and/or water-holding capacity, the leaching requirement may not be met. This phenomenon often gives rise to a patchy development of soil salinity.

The problems of insufficient leaching are more pronounced as the irrigation water is scarcer. Although, with water scarcity, a high field irrigation efficiency may be achieved, there may be insufficient water for full evapotranspiration by the crop and for leaching.



- a₁ excess due to high infiltration capacity
- b₁ shortage due to low infiltration capacity
- a₂ excess due to depression in soil surface
- a₃ excess due to low moisture holding capacity
- b₂ shortage due to elevation of soil surface
- a₄ excess due to cracking

Figure 17.14 Illustration of the random irregularity in the spatial distribution of the deep percolation in an irrigated field

It follows from the above considerations that, if the irrigation system is inadequate, a drainage system cannot guarantee proper salinity control. In other words, with a scarcity of irrigation water, poor land levelling, and/or randomly irregular soils, salinity problems are difficult to cure, even with an intensive drainage system.

17.3.7 Summary: Formulation of Agricultural Drainage Criteria

The previous discussion of field drainage criteria can be summarized as follows.

If one expresses the agricultural drainage criterion as the permissible minimum value of the average depth of the watertable during a prolonged period, one has formulated a long-term, steady-state criterion. An example of a long-term, steady-state criterion for a subsurface drainage system in irrigated agricultural land is: 'The average depth of the watertable during the irrigation season should be at least 0.8 m, but need not be more than 1.0 m'. An example for humid areas is: 'The average depth of the watertable during the critical humid season should be at least 0.6 m, but need not be more than 0.8 m'. The critical humid season may be either the winter period, as in the temperate zones of Europe where the excess rainfall occurs mainly in winter (off-season drainage), or the summer/cropping season, as in those tropical or subtropical regions where the excess rainfall occurs during the summer or during an important cropping period (in-season drainage). The corresponding discharge rate of the drainage system must be calculated from a water balance as an average rate during the corresponding period, whereby the storage term may be ignored.

When one expresses the agricultural drainage criterion in terms of a critically high level above which the watertable may rise only infrequently and for short periods, one has formulated a short-term, unsteady-state criterion. An example of such a short-term criterion for a subsurface drainage system is: 'The watertable may be higher than 0.3 m below the soil surface only for one day a year'. The corresponding discharge rate of the drainage system then has to be calculated from a short-term water balance with an infrequent, extreme, recharge whereby the dynamic storage term must be taken into account. This complicates the calculations considerably. In irrigated lands, the presence of three-dimensional flow of groundwater complicates the assessment of the storage even more.

The decision as to which type of criterion to apply should be based on the considerations discussed in the previous sections.

There are certain types of criteria that use conditional statements, for example:

- When the watertable reaches a specified height (h) above the drain level, the drains should be able to function at a specified rate of discharge (q). The ratio h/q or q/h is then often employed as a drainage criterion;
- When, after a sudden recharge, the watertable has reached a specified critical height (h_0) above drain level, the drainage system should be able to effect a specified drawdown of the watertable to a height (h_i) in a specified period of time (t) after the recharge has ceased. The ratio h_i/h_0 is then often employed as a criterion.

These criteria can only be used where extensive local experience is available. One has to know how frequently the specified events occur and to which drain depth they

are related. Otherwise, one runs the risk of applying the criteria to situations that occur far too often or that never occur.

17.4 Effects of Field Drainage Systems on Agriculture

17.4.1 Field Drainage Systems and Crop Production

To obtain a quantitative insight into the effects of drainage on agriculture, one can do experiments with varying drainage designs and measure the corresponding crop production. This straightforward procedure is illustrated in Figure 17.15. The engineering factors mentioned in the figure depend on the type of drainage system involved (Section 17.3.2). Some of the engineering factors are specified in Table 17.2.

The effect of the engineering factors can be studied step by step (e.g. by using a range of drain spacings as shown in Figure 17.16), or by simply considering the 'with and without' case (e.g. by comparing the crop production in drained and undrained land as shown in Table 17.3).

Many data of the with/without comparison have been published by Trafford (1972), Baily (1979), and Irwin (1981). The first author reviewed data from literature and also quotes cases of unsuccessful drainage systems. Found et al. (1976) studied the economic impact of several drainage systems in Ontario, Canada. Some of their conclusions are:

- The benefit/cost (B/C) ratios of drains varied from 0.1 to 20, which indicates that some of the systems are uneconomical and other systems are highly beneficial;
- Influential factors on the B/C ratio were:

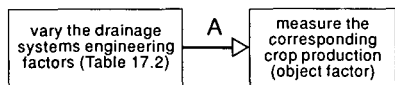

Figure 17.15 Illustration of a straightforward method of analysis of drainage effects on agriculture

Table 17.2 Examples of engineering factors by type of drainage system

Type of drainage system	Engineering factor
Subsurface drainage system	Depth, spacing, and dimensions of ditches or pipe drains
Tubewell drainage system	Depth, spacing, and dimensions of wells, pump capacity
Surface drainage system	Length and slope of the fields, dimensions of furrows and bedding
Main drainage system	Depth, width, cross-section, and slope of drains, spacing of the network

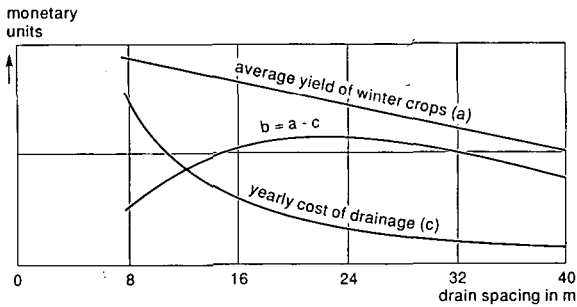

Figure 17.16 Example of Relation A of Figure 17.15 showing net benefit (b) of winter crops as a function of drain spacing in a 60% clay soil in Sweden (Eriksson 1979)

Table 17.3 Annual maize production (t/ha) with and without field drainage systems and different doses of N-fertilizer (Schwab et al. 1966)

Type of drainage system	N fertilizer (kg/ha)		
	0	100	200
Subsurface field drainage system	3.7	5.9	7.0
Surface field drainage system	3.5	5.1	6.2
Without field drainage system	2.5	3.0	4.0

- The productivity of the environment: poor soils and adverse climatic conditions decreased B/C ratios;
 - Local initiative to take advantage of the drainage facilities: some farmers did not make the necessary additional investments;
 - Quality of engineering: some drains were too elaborate and costly for their purpose;
- Despite its significance, little analysis of the full effects of drainage systems has been undertaken.

When the relationship between engineering factors and crop production (Relation A in Figure 17.15) is established in a certain area, it has no validity for application elsewhere, because it depends on the area's pedological, climatic, hydrological, topographic, agronomic, and socio-economic conditions. A more universal applicability of experiences can be promoted by introducing additional factors into Relation A. In Figure 17.17, for example, the watertable regime is used as an additional intermediate factor, so that Relation A is divided into Relations B and C.

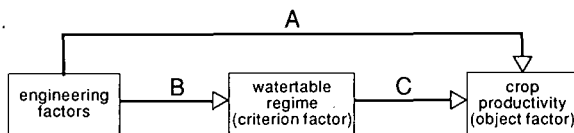

Figure 17.17 Relation A of Figure 17.15 is divided into Relations B and C by means of the watertable regime

Relation B represents a direct effect of a drainage system (Section 17.3.1, Figure 17.2). It is entirely a hydraulic function and lends itself to the development of generalized drainage formulas (Chapter 8). These formulas have more than local value because they include parameters to represent natural conditions like recharge and hydraulic conductivity. A difficulty is still to survey and correctly assess these parameters, because of their wide variation in time and space (Chapters 12 and 16).

Relation C represents an indirect effect of a drainage system and has already been discussed in Section 17.3.3. This relationship is very site specific and is therefore not universally applicable. A more universal applicability can be obtained by dividing Relation C into other relationships with the help of the proper additional factors (Section 17.4.3). This, however, leads to complicated interactions and therefore constrains practical application. Hence, the establishment of empirical relationships of the C-type remains a necessity in any region where a drainage project is proposed.

Implementing and operating a drainage system can have far-reaching effects, not only on the crop production but also on the total cropping system of an area. This is illustrated in Figure 17.18, which shows profound changes in the cropping pattern in England and Wales after drainage systems had been introduced.

17.4.2 Watertable and Crop Production

The use of the watertable as an index for crop production was explained in Section 17.3.3. In this section, some additional data are given on Relation C (Section 17.4.1) between crop production and the watertable regime.

Figure 17.19 shows the relationship between the yield of wheat in farmers' fields in the Nile Delta and the average depth of the watertable during the growing season

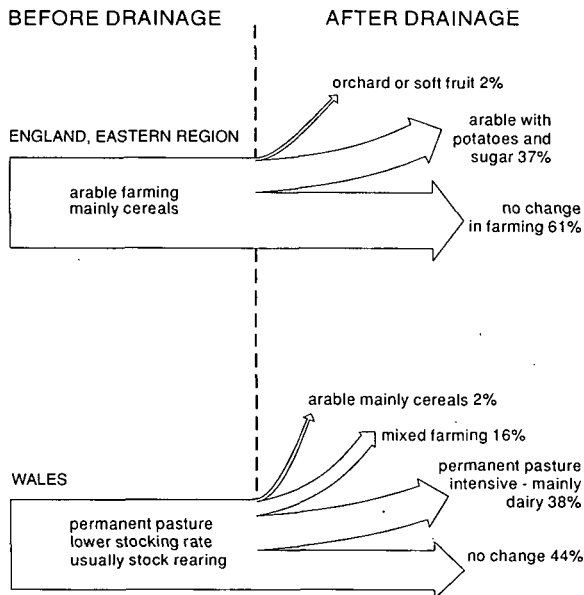

Figure 17.18 Changes in cropping pattern as a result of drainage (FDEU 1972)

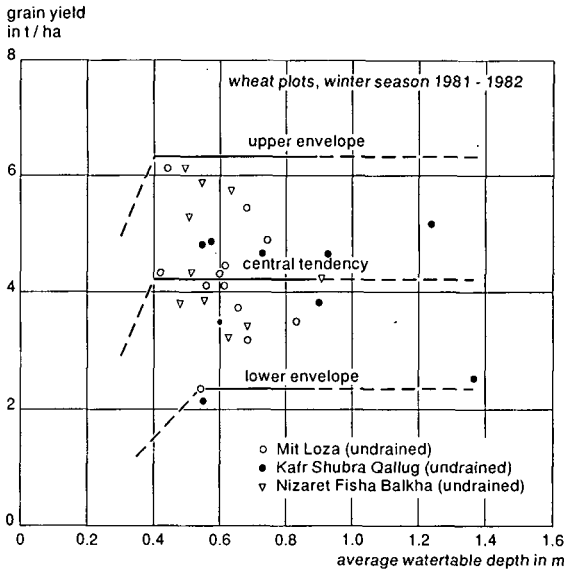

Figure 17.19 A plot of data on the yield of wheat in farmers' fields and the average seasonal depth of the watertable in the Nile Delta, Egypt (Advisory Panel 1982)

for wheat (i.e. winter). The figure reveals that in most fields the average depth was more than 0.5 m, and no clear relationship with the yield can be detected. This indicates that the fields did not suffer from serious drainage problems and that the critical depth (i.e. the minimum permissible depth) of the watertable is 0.5 m or less. There are insufficient data on a watertable depth of less than 0.5 m to determine the value of the critical depth accurately, but it can be concluded that the lowest crop yields observed are not due to a shallow watertable but to other, unfavourable, agricultural conditions.

Figure 17.20 shows similar yield data for wheat (a winter crop) and for maize and cotton (summer crops) in the drained Mashtul Pilot Area in the Nile Delta. It appears

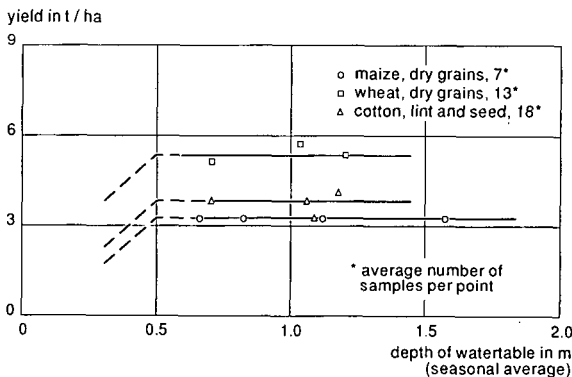

Figure 17.20 The yield of some irrigated crops versus seasonal average depth of the watertable. Data from the Mashtul Pilot Area in the Nile Delta, Egypt (Safwat Abdel-Dayem and Ritzema 1990)

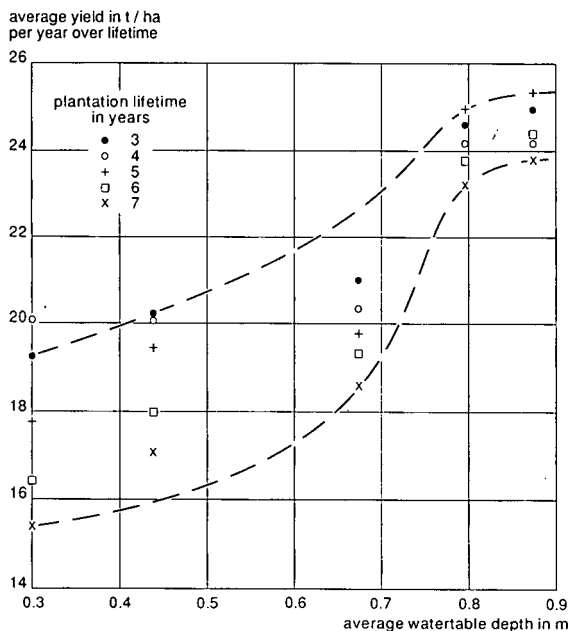

Figure 17.21 Relationship between banana yield, plantation age, and average depth of the watertable in Surinam (Lensefink 1972)

that the area is adequately drained, because no clear relationship can be detected between the average depth of the watertable and the yields, and all seasonal average depths of the watertable were deeper than 0.5 m. Some fields in the pilot area were even excessively drained (i.e. the watertable is much deeper than required). As in Figure 17.19, the critical value of the watertable for the crops investigated in Figure 17.20 cannot be determined accurately because of the lack of data on very shallow watertables. Anyway, it is likely that depths of 0.6 to 0.7 m are safe for all three crops.

Figure 17.21 shows the relationship between banana yield, plantation age, and average depth of the watertable in Surinam. For all ages, a depth of 0.8 m is a safe depth. The banana production is reduced at depths of 0.7 m or less. The lowest yields were obtained on plantations that were seven years old.

Table 17.4 shows the relative yields of potatoes, onions, maize, and carrots in

Table 17.4 Relative yields (in %) of crops with different depths of the watertable in a muck soil (Harris et al. 1962)

Crop	Number of years	Depth of watertable (m)			
		0.4	0.6	0.8	1.0
Potatoes	12	46	94	97	100
Onion	11	63	109	113	100
Sweet corn	4	61	100	92	100
Carrots	4	59	93	96	100
Average		63	98	100	100

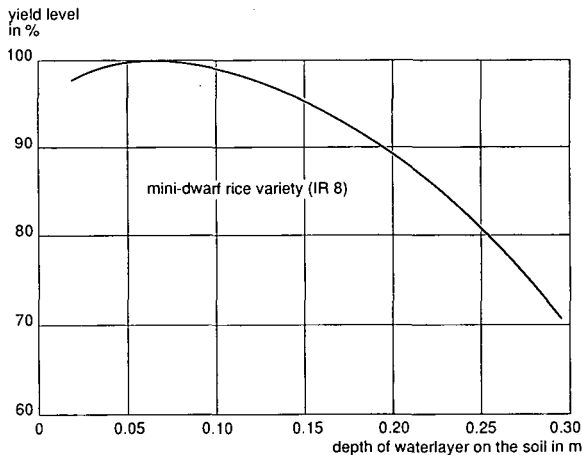

Figure 17.22 Production of a dwarf rice variety as a function of the depth of the standing water layer on the soil surface (personal communication from K.J. Lenselink and J. de Wolf, ILRI, Wageningen, The Netherlands)

dependence of the depth of the watertable in a muck soil. A depth of 0.6 m is safe for all four crops, although potatoes and carrots perform slightly better when the depth is 0.8 m or more. The yield of onions even decreases at depths of more than 0.8 m. This effect is probably related to the quality of the muck soil.

Figure 17.22 gives the expected production of a high-yielding dwarf rice variety in relation to the average depth of the standing water layer on the soil. It appears that a depth between 0 and 0.1 m guarantees maximum possible yields. Depths of more than 0.15 m lead to yield reductions. Nevertheless, there are many sturdy rice varieties that can withstand much higher depths.

Figure 17.23 shows that, in farmers' rice fields in the Nile Delta, the average seasonal

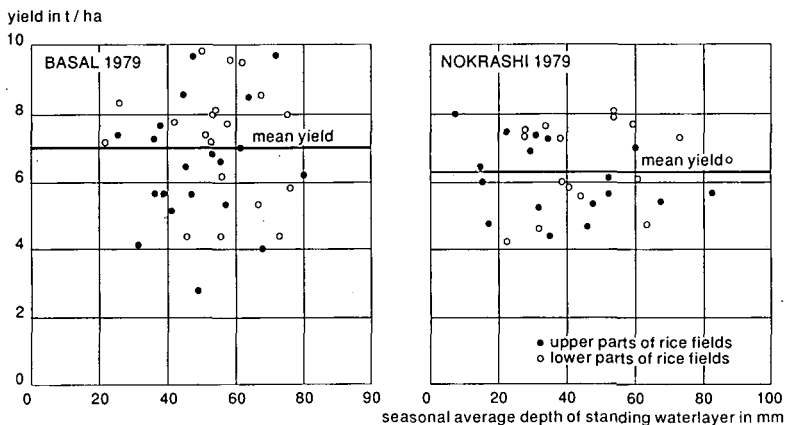

Figure 17.23 A plot of rice yields in farmers' fields versus seasonal average depth of the standing water layer on the soil surface in the Nile Delta, Egypt (Nijland and El Guindy 1986)

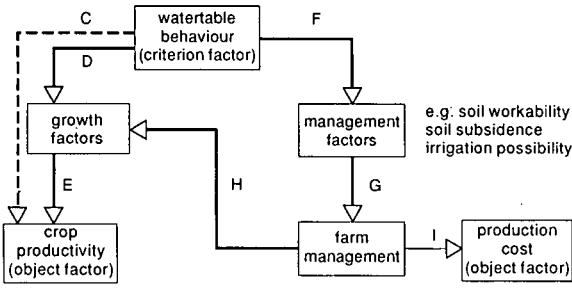

Figure 17.24 A further breakdown of Relation C of Figure 17.15 into Relations D, E, F, G, H, and I, using soil-related growth and management factors

depth of the standing water layer on the fields ranges between 0 and 0.1 m, and that within this range the yield is independent of the depth: there are no drainage problems.

17.4.3 Watertable and Soil Conditions

To enable a wider application of the relationship between the depth of the watertable and the agricultural effects, we can separate Relation C, discussed in the previous paragraphs, into Relations D and E, using the soil-related growth factors of the plants as intermediate factors (Figure 17.24). These factors can be distinguished in soil physical, chemical, biological, and hydrological factors, which are highly interactive (Figure 17.25).

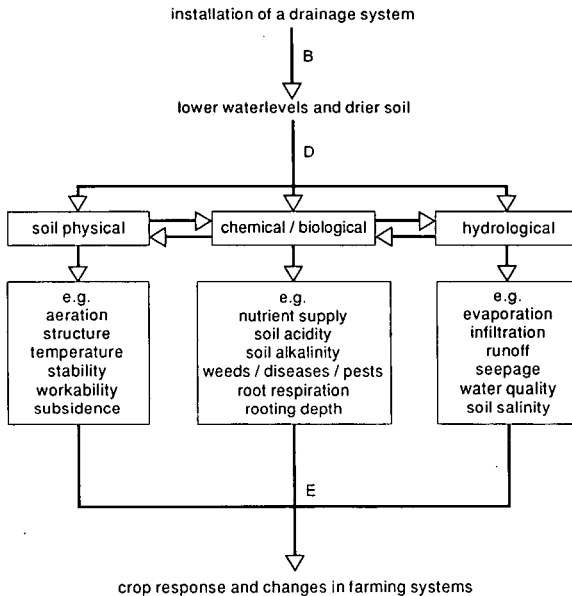

Figure 17.25 Soil physical, chemical/biological, and hydrological interactions in Relations D and E of Figure 17.24

Figure 17.24 also shows a separation using the soil-related farm-management factors as intermediates (Relations F and G). The management factors have an influence on the farm management (depending on the farmer's response), which again exerts an influence on the growth factors (Relation H), but also on the cost and effort put into crop production (Relation I). All this may result in a profound change in the cropping system after the introduction of drainage systems, as was illustrated in Figure 17.18.

A disadvantage of the drainage-response model of Figures 17.24 and 17.25 is its complexity, the usual lack of data, and the difficulty of collecting the necessary information to make it functional. In drainage design, therefore, one usually has to depend on empirically-obtained relationships of the C-type. Nevertheless, an insight into the soil-related growth and management factors is important, and for this reason some examples will be discussed below.

Soil Structure

A good soil structure favours both the soil aeration and storage of soil water, reduces impedance to root growth, and provides stable traction for farm implements. A drainage system affects the soil structure through its influence on the watertable (Relation E; Figures 17.24 and 17.25). Figure 17.26 shows the influence of groundwater depth on pore volume % for two pore-size classes (< 30 micron and > 30 micron). As can be seen, the percentage of large pores increases with increasing depth of the watertable. As a result, when the depth of the watertable increases from 0.4 m to 1.0 m, the hydraulic conductivity of the soil layer between 0.5 and 0.9 m depth increases from 0.35 m/d to 2.5 m/d (Van Hoorn 1958). It appears that maintaining the watertable at a depth greater than 0.4 m exerts a beneficial influence on soil structure and structurally-determined soil properties.

Soil Temperature

The reduced water content and the increased air content brought about by a drainage system result in a lowering of the specific heat of the soil, because water requires five times more heat to raise its temperature than dry soil. Consequently, waterlogged soil with about 50% moisture requires 3 times more heat to warm up than dry soil. In addition, the cooling effect of the greater evaporation from a wet soil delays a temperature rise. In temperate climates, both these effects cause a delay of growth in spring. In general, it can be stated that the temperature of the soil surface is favourably changed by a drainage system, which will promote early planting in spring in areas with cold winters, which in turn leads to a yield increase. This chain of reactions gives a good example of the interactions existing between Relations E, F, G, H, and I in Figures 17.24 and 17.25. Wesseling (1974) and Feddes (1971) have reviewed the influence of drainage systems on temperature and of temperature on plant growth.

Sometimes, wet soils have a favourable effect. In hot climates, for example, a wet soil prevents an excessive rise in soil temperature during the day, so that a lower, more favourable soil temperature is maintained. In climates with an occasional night frost during the growing season, wet soils are able to release more heat than dry soil and thus maintain a higher night temperature. In fields with a watertable deeper than 1.0 m, Harris et al. (1962) reported a 50% stand reduction of maize, potatoes, and peppermint due to a frost in June, whereas no damage was observed in fields with a watertable at 0.4 m depth. This example shows that excessive drainage should be avoided.

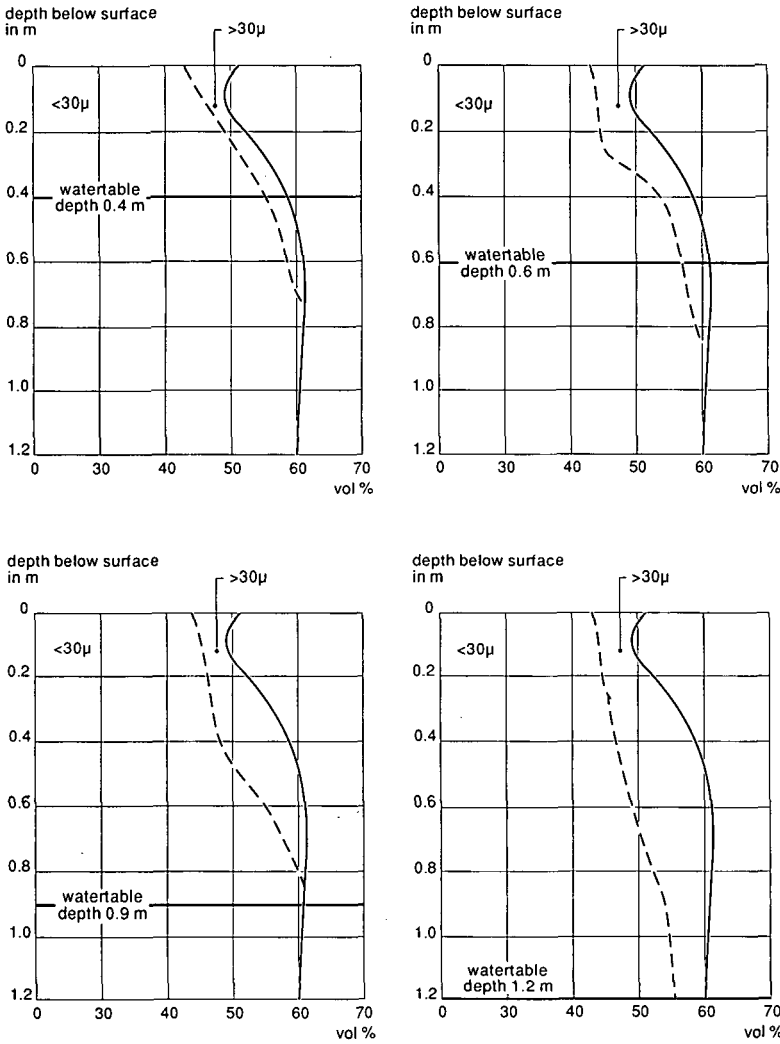

Figure 17.26 Influence of groundwater depth on water and air content, and pore-size distribution (Van Hoorn 1958)

Soil Workability and Bearing Capacity

With an adequate drainage system, the average water content of the topsoil, even in humid areas, will seldom rise above field capacity. This is important, because there is a narrow range of soil-water contents for tillage operations, which for most soils is below field capacity. Working the soil at higher water contents gives rise to mechanical difficulties and destroys the soil structure, especially in clayey soils. Such a deteriorated soil can be very hard when dry, and as a result of compaction (plough-sole, tractor-sole, or traffic layer) and crust formation, both the infiltration and hydraulic conductivity are low.

In grazed grasslands, the bearing capacity of the soil and its resistance to puddling

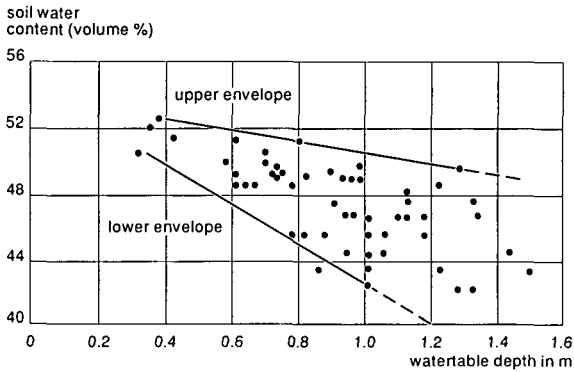

Figure 17.27 Relation between soil water content at 0.15 m depth and watertable depth in a silt loam soil in S. Carolina, U.S.A., from January through May 1970 (Young and Ligon 1972)

(trampling) by the hoofs of cattle can be favourably influenced by a drainage system (Berryman 1975).

In Chapter 11, the equilibrium relationship between soil-water content and watertable depth was discussed, including hysteresis. It is not always easy to find such a relationship under field conditions. An example of the scatter in the relationship between the soil-water content and the depth of the watertable is shown in Figure 17.27. Still, the figure shows the expected trend that the average water content of the soil at 0.15 m depth is considerably less with deeper watertables than with shallow ones. On the other hand, a deep watertable and an intensive subsurface drainage system are no absolute guarantees of a soil-water content below field capacity, especially not on rainy days.

For a silt loam soil in The Netherlands, Figure 17.28 presents an example of the relationship between the percentage of workable days in April, the drainage intensity

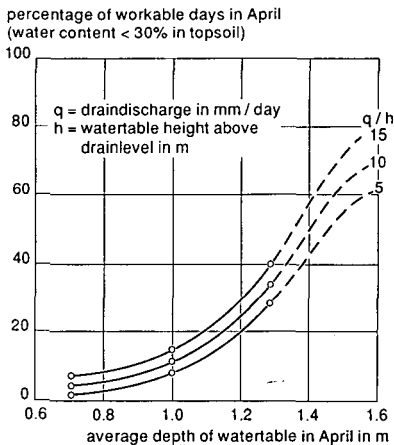

Figure 17.28 Drainage and workability of a silt loam soil under Dutch climatic conditions. Data obtained with a simulation model covering a period of 35 years (adapted from Wind and Buitendijk 1979)

(q/h ratio), and the average depth of the watertable. The figure shows that the average depth of the watertable exerts a great influence on the number of workable days (Relation F in Figure 17.24). The influence of the q/h ratio is much smaller. Unfortunately, the calculations were made only up to watertable depths of 1.3 m, so that the maximum number of workable days cannot be determined.

Other examples have been presented by Nolte et al. (1982).

Soil Subsidence

Newly reclaimed wetland clay soils will subside when drainage is introduced. These soils, which are originally supersaturated with water, subside because of the loss of water (Chapter 13). Any soil will subside if the watertable is pumped down to several tens of metres (Todd 1980). Such pumping is not generally done for drainage, however, but for water supplies, and is therefore not further discussed here.

Drained peat soils subside for two reasons. The first is physical, because the soils shrink with the loss of water. The second is chemical, because the organic matter oxidizes and decomposes. Figure 17.29 illustrates the shrinkage of peat soils in The Netherlands as a function of seasonal average depth of the watertable. When the shrinkage is used as an object factor, this average depth can also be used as a drainage criterion.

Irrigated gypsiferous soils can also subside. When irrigation water is applied to them, the gypsum in the soil dissolves and is removed by natural or artificial drainage (Van Alphen and de los Rios Romero 1971).

Nutrient Supply from the Soil

Various processes activated by bacteria, fungi, and other micro- and macro organisms in the soil depend on the aeration and the drainage status of the soil. Minessy et al. (1971) have shown that the uptake of mineral nutrients (N, P, K, Ca, Mg) by orange and mandarin trees in Egypt increases with increasing depth of the watertable. Yamada (1965) reported that the continuous flooding of rice fields causes a chemical reduction of the soil and an accumulation of toxic products like hydrogen sulphide (H_2S). An occasional drainage of water from the fields results in a favourable oxidation of the harmful substances.

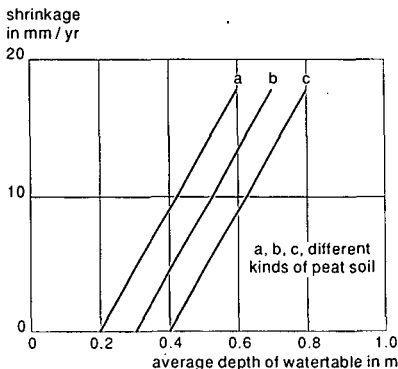

Figure 17.29 Subsidence of peat soils in The Netherlands as a function of average watertable depth (Schothorst 1978)

Nitrogen (N) fixation and nitrification by micro-organisms are other examples of aerobic processes that are influenced by the soil moisture content and exert an important influence on plant growth. Van Hoorn (1958) found that, when the average depth of the watertable is 0.6 m, the soil releases only 60 kg N per ha per year, but, when this depth is 1.2 m, it releases 120 kg N per ha per year. Thus, when the depth of the watertable is 0.6 m, and an amount of 60 kg N per ha is applied in the form of a nitrogen fertilizer, the yields will be comparable in both cases. Apparently, certain agricultural practices can compensate for the effects of poor drainage conditions, as was already mentioned in Section 17.3.3 (Figure 17.8).

In confirmation, Figure 17.30 shows the combined influence of N-fertilization and average depth of the watertable on grassland in peat soil in The Netherlands. With shallow watertables, a high N-dose has a considerable effect on the yield, but when the watertable is at 0.5 m or more, the effect vanishes. Also in Table 17.3 (Section 17.4.1) it is seen that an N-dose in undrained fields leads to similar yields as in drained fields without fertilizer application. However, contrary to the tendency shown in Figure 17.30, the data of Table 17.3 show that the effect of fertilizing is large in the well-drained fields. The effect of fertilizer on crop production in relation to the drainage status of the soil is apparently dependent on local conditions. This also holds for the quality of the produce.

Shalhevet and Zwerman (1962), conducting experiments with a maize crop, proved that the N-fertilizer could best be given in the form of nitrates when the watertable is shallow and as ammonia when the watertable is deep. Nitrate is more mobile than ammonia, however, and may therefore be easily leached by the drainage water and cause excessive nitrification of the water in the main drains (Bolton et al. 1970).

Soil Sodicty

Sodic soils are soils with an excess sodium at the exchange complex and they have a pH above 8. Sodic soils containing CaCO_3 can be reclaimed by incorporating acidifying materials in the soil, either through organic matter, sulphur compounds, or a reclamation crop. (Many grasses serve this purpose.) The acids dissolve the precipitated CaCO_3 . If necessary, gypsum can also be added. The Ca^{2+} in the gypsum

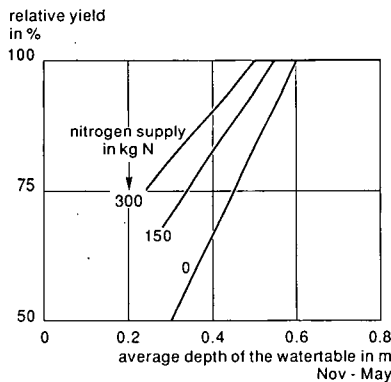

Figure 17.30 Nitrogen supply, average depth of watertable, and yield of grassland in The Netherlands (Feddes and Van Wijk 1977)

or in the dissolved CaCO_3 displaces sodium from the exchange complex. Subsequently, the excess sodium needs to be leached. If the natural drainage is insufficient for the necessary leaching, an artificial drainage system may have to be installed.

Soil Acidity

Soil acidity is related either to organic-matter production and natural leaching of the soil, or to the presence of acidifying sulphuric minerals in the soil.

If the acidity is due to the first cause, ferralitic soils may be formed. These soils are not the primary concern of the drainage engineer, because they are associated with excessive natural drainage.

If the acidity is related to the second cause, we are dealing with 'potential acid sulphate soils' or 'cat clays' (Chapter 3). If they are drained, either by natural causes or by artificial drainage, the resultant oxidation and hydrolysis of the acidifying minerals produces sulphuric acid and iron oxides. The pH of these 'actual acid sulphate soils' is below 4. There are examples of relatively successful reclamations of these soils by farmers, done with time and patience, but large-scale interferences often lead to disaster.

Soil Salinity

Saline soils form chiefly under conditions of permanent or recurrent waterlogging (Chapter 3). Crop production on saline waterlogged soils is seldom rewarding. Artificial drainage may solve the salinity problems, as was discussed in Section 17.3.6 and Chapter 15.

17.4.4 Summary

The development of agricultural drainage criteria is an inter-disciplinary science. Before drainage criteria are developed in any drainage project, the following aspects have to be considered:

- Pedology and agriculture (chemical/physical/biological soil conditions; crop production; farm operations; irrigation);
- Hydrology and geology (surface and subsurface water balances; river and aquifer conditions);
- Hydraulics (flow of water under the influence of hydraulic gradients and resistances or conductivities);
- Technology (presence or absence of labour and machinery; quality of materials and maintenance);
- Socio-economy (farmers' organizations; farmers' attitudes; rural laws; distribution of benefits and costs; compensations);
- Environment (natural resources; ecology; side-effects).

Hence, establishing agricultural, technical, and environmental criteria for land drainage systems needs a careful approach and should not be done merely from handbooks. Because of the large variation in local conditions, the introduction of land drainage systems ought to be done by combining theoretical insight with local experience. Otherwise, the drainage project may be either too costly or non-beneficial, if not damaging.

17.5 Examples of Agricultural Drainage Criteria

17.5.1 Rain-Fed Lands in a Temperate Humid Zone

How drainage criteria are used for the design of drainage systems in rain-fed lands in temperate humid zones will be exemplified with design particulars for field and collector drainage systems in The Netherlands.

Example 17.1 Field Drainage Systems in The Netherlands

The water balance of field drainage systems in many parts of The Netherlands can be written in the simple form, neglecting groundwater flow components

$$D_r = q_d \Delta t = P - E - \Delta W \quad (17.2)$$

where

- D_r = drainage (mm)
- q_d = drainage rate (mm/d)
- Δt = period (d)
- P = precipitation (mm)
- E = evapotranspiration (mm)
- ΔW = water storage (mm)

Figure 17.31 presents the monthly balances of rainfall (P) and evapotranspiration (E) in The Netherlands. It shows that, in summer, the evapotranspiration exceeds rainfall and $\Delta W = P - E$, so that, according to Equation 17.2, no drainage is required ($q_d = 0$), except in areas with a strong upward seepage of groundwater. In winter, the rainfall exceeds the evapotranspiration plus the storage by about 180 mm, which, for 4 months, gives an average drainage rate $q_d = 1.5$ mm/d. Crop-response functions have indicated that, in winter, an average depth of the watertable of 0.9 m below the soil surface is amply sufficient. This represents a long-term, steady-state agricultural criterion for subsurface drainage systems. Assuming a drain depth of 1.0 m, we find the average hydraulic head to be $h = 1.0 - 0.9 = 0.1$ m. Defining the drainage intensity ratio as q_d/h (d^{-1}), we find $q_d/h = 0.0015/0.1 = 0.015 d^{-1}$.

In The Netherlands, when the depth of the watertable midway between the drains is 0.5 m, subsurface field drainage criteria are expressed as a normative discharge ($q_d = 7$ mm/d). This normative discharge and reference level of the watertable are exceeded only once a year on average, so we are dealing with a short-term, unsteady-state situation. The drainage intensity ratio becomes $q_d/h = 0.007/(1.0 - 0.5) = 0.014$ day $^{-1}$, which is only slightly less than the ratio $q_d/h = 0.015$ found for the steady-state situation.

The q_d/h ratio for the steady state is very sensitive to changes in drain depth; for example, if we take a drain depth of 1.1 m instead of 1.0 m, the q_d/h ratio becomes 0.0075 instead of 0.015. Therefore, and because the agricultural effects of drainage are usually more responsive to average long-term water levels than to short-term extreme water levels, the q_d/h ratio should not be employed as a drainage criterion outside The Netherlands or without extensive empirical evidence.

For situations in which the incoming or outgoing groundwater flows cannot be ignored, Van Someren (1958) used the observed watertable depths to derive normative

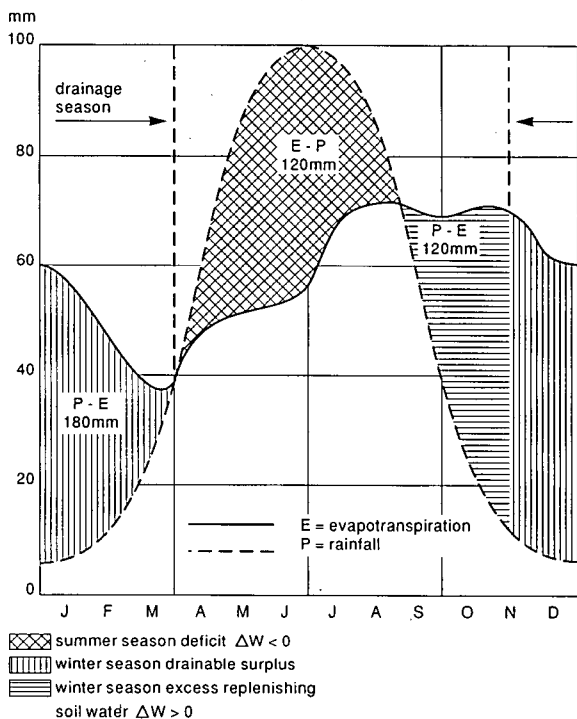

Figure 17.31 Monthly values of rainfall, evapotranspiration, storage, and drainage surplus in The Netherlands

discharges and reference levels of the watertable for a subsurface field drainage system (Table 17.5). The underlying principle is that shallow watertables indicate net groundwater inflow and upward seepage, and deep watertables indicate net groundwater outflow and natural drainage. The table shows that the drainage rates, q_d , diminish as the observed watertables are deeper (i.e. as the upward seepage reduces and the natural drainage increases). Since this is not generally true in other parts of the world, Table 17.5 is not directly applicable outside The Netherlands.

With the established intensity ratio's for subsurface drainage, either for long-term steady-state or short-term unsteady-state conditions, one can proceed to design the subsurface field drainage systems. The steady-state conditions permit the use of steady-state drainage equations. Since the data of Table 17.5 have already taken the storage into account (they are specified in terms of normative drain discharge exceeded on an average of only once a year, which equals the corresponding recharge, less storage), here too steady-state drainage equations can be used.

Example 17.2 Collector Drains in The Netherlands

In The Netherlands, we recognize two criteria for water levels in open collector drains (Figure 17.32): a high water-level criterion (HW) and a normal water-level criterion (NW). The HW criterion specifies that the water level in the collector may exceed a level of 0.5 m below the soil surface only 1 day a year. The NW criterion specifies

Table 17.5 Normative extreme discharge (q_d) and corresponding watertable depth (j) for subsurface field drainage systems in The Netherlands, by type of land use. The q/h ratios (d^{-1}) (where the height $h = 1.1 - j$, for a drain depth of 1.1 m) are indicated between brackets (Van Someren 1958)

Reference level observed to be exceeded by the watertable only once a year (m below soil surface)	Normative discharge (mm/d)		
	Grassland $j = 0.3$ m	Arable land $j = 0.5$ m	Orchards $j = 0.7$ m
0	7 (0.009)	7 (0.012)	7 (0.018)
0.1	7 (0.009)	7 (0.012)	7 (0.018)
0.2	3 (0.004)	5 (0.008)	6 (0.015)
0.3	0	3 (0.005)	5 (0.013)
0.4	-	0	4 (0.010)
0.5	-	-	3 (0.008)
0.6	-	-	2 (0.005)
0.7	-	-	1 (0.003)
≥ 0.8	-	-	0

that the water level in the collector may exceed the outfall level of the laterals (i.e. 1.0 to 1.1 m below soil surface) no more than 15 days a year. For collectors serving small areas, the second criterion is the most critical and will therefore be adopted for the design, whereas for collectors serving large areas, the first criterion is the appropriate one.

According to Blaauw (1961), the collector discharge (q_{15}) that is exceeded 15 days a year is about half the discharge (q_1) that is exceeded only 1 day a year ($q_{15} = 0.5q_1$). In general, he found for the discharge that is exceeded in x days a year

$$q_x = q_1(1 - 0.44 \log x) \text{ mm/d}$$

The extreme discharge, q_1 , is found from the empirical relationship

$$q_1 = 8.64 B (0.53 - 0.05 \log A) \text{ mm/d}$$

where A is the area (ha) served by the collector, and B is a factor depending on the area's hydrological conditions. The value of B is usually between 2 and 3, depending on the soil type, kind of cropping system, and intensity of the field drainage system, but when upward seepage or natural drainage occurs, the factor B may go up to 4 or down to 1, respectively.

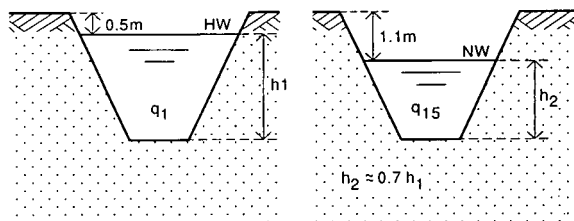

Figure 17.32 High water-level (HW) and normal water-level (NW) criteria used in The Netherlands for the design of collectors

With the water-level criteria and the corresponding discharges thus determined, we can proceed with the design of the capacity and dimensions of the collector system, using Manning's steady-state formula (Chapter 19), because the dynamic storage of water in the collector system is small compared with recharge and discharge (Section 17.3.4).

17.5.2 Irrigated Lands in Arid and Semi-Arid Regions

How subsurface drainage criteria are used in arid zones and how the corresponding water balances are applied will be illustrated with one case from Egypt and two from Peru.

Example 17.3 Egypt

For Egypt's Nile Delta, the agricultural drainage criterion reads: 'The seasonal average depth of the watertable midway between the drains should be 1.0 m.' (Safwat Abdel-Dayem and Ritzema 1990). Although there are indications that this depth could be somewhat less (Figures 17.19 and 17.20), the value 1.0 m was adopted for safety reasons. On the other hand, it would be inefficient to lower the average watertable to more than 1.2 m, because this would increase the deep percolation losses and reduce the irrigation efficiency (Oosterbaan and Abu Senna 1990).

Starting from the overall water balance given in Chapter 16 (Equation 16.8), we may ignore rainfall, surface evaporation, and surface runoff, and add a drainage term to obtain

$$q_d = q_{si} - E + q_{gi} - q_{go} \quad (17.3)$$

where

- q_d = drainage rate (mm/d)
- q_{si} = surface irrigation (mm/d)
- E = evapotranspiration rate (mm/d)
- q_{gi} = groundwater inflow (mm/d)
- q_{go} = groundwater outflow (mm/d)

The continuous irrigation throughout the year and the steady-state long-term agricultural criterion for subsurface drainage in Egypt permits us to neglect also the change in storage.

In many parts of the Nile Delta, it has been observed that there is natural drainage of groundwater to an underlying deep aquifer (so that $q_{go} > q_{gi}$). Hence, we can expect the value of q_d to be relatively small.

Safwat Abdel-Dayem and Ritzema (1990) reported on measurements of drain discharge and found an average rate of $q_d = 0.6$ mm/d. This discharge includes the discharge from subsurface-drained rice fields, which is in fact not desired (Qorani et al. 1990). When the drain discharge rates were determined per crop, these rates were found to be distributed as shown in Table 17.6. From that table, we can conclude that, if the drainage from the rice fields could be restricted, a design discharge rate of $q = 0.4$ mm/d (corresponding to the average discharge rate of the maize fields) would be amply sufficient for the design. The value of q_d can be so low because it

Table 17.6 Average drain discharge in Egypt's Nile Delta per season and per crop (Safwat Abdel-Dayem and Ritzema 1990)

Season	Winter		Summer		
Crop	Berseem	Wheat	Cotton	Maize	Rice
Drain discharge (mm/d)	0.2	0.1	0.1	0.4	1.3

is only supplementary to the natural drainage.

With the steady-state agricultural criterion for a subsurface field drainage system (i.e. the seasonal average depth of the watertable midway between the drains equals 1.0 m) and the corresponding design discharge rate (i.e. $q_d = 0.4$ mm/d), we can proceed with the design of the field drainage system, using steady-state equations.

In a pilot area in the Nile Delta, it was found that the rate of natural drainage to the underground ($q_{go} - q_{gi}$) amounted to 0.5 mm/d (Oosterbaan and Abu Senna 1990). The total water flow through the profile for this area would amount to 0.9 mm/d, the artificial drainage contributing 0.4 mm/d and the natural drainage 0.5 mm/d.

The irrigation rate causing this drainage flow amply satisfies the leaching requirement, as is shown in Figure 17.33. Before the drainage system was installed, the area had a slight salinity problem, because a small percentage of salinity data were higher than the critical value $EC_e = 5$ dS/m and the corresponding yields were lower than average. After the drainage system had been installed, all soil salinity data showed an EC_e below 2 dS/m, a very safe value, and the corresponding crop yields are independent of soil salinity. No additional amount of leaching water therefore need be included in the design discharge. We can also note from Figure 17.33 that the average crop yield (5 t/ha) after drainage is higher than the average yield of the data with $EC_e < 5$ dS/m before. Apparently, by reducing the soil salinity and lowering the watertable, drainage has contributed to the general yield improvement. In addition, improved agricultural practices upon the introduction of drainage have had a further positive effect on crop yields.

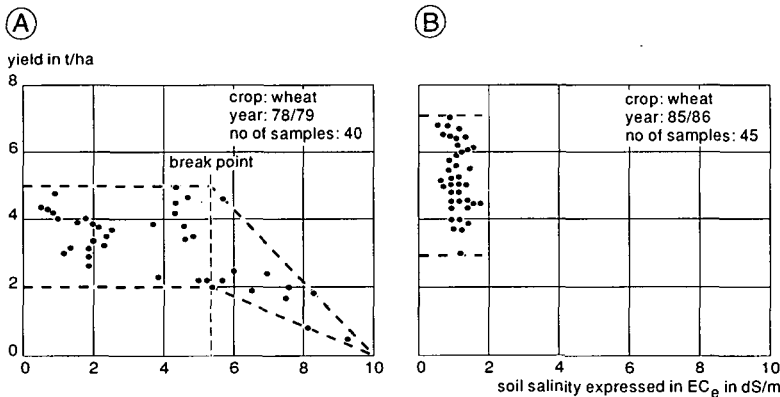

Figure 17.33 Example of the relationship between crop yield and soil salinity (A) before and (B) after the installation of the subsurface drainage system in a pilot area in the Nile Delta, Egypt (Safwat Abdel Dayem and Ritzema 1990)

The subsurface drainage systems of the Nile Delta consist of piped field drains and piped collector drains. The discharge capacity and the required diameter of the collectors should not be based on the average discharge rate, but on a more extreme and less frequent rate. This is because the collector system has a small buffer capacity and it has to function properly during the relatively short periods of peak discharge, otherwise the field drainage system fails. For the design of the collector system, Safwat Abdel-Dayem and Ritzema (1990) proposed to use the discharge rate from maize fields that is exceeded only 10% of the time. This rate was found to be 1.2 mm/d. Such a design discharge would also provide a certain safety margin because it occurs only infrequently.

With the technical criterion: 'The collector pipe is just filled to the top at the design discharge', the design procedure of the collector drains can start, based on Manning's steady-state formula, even though the design discharge rate is essentially unsteady.

Example 17.4 Coastal Peru

The first Peruvian example concerns an area in the coastal delta of a river that originates in the Andean mountain range. The coastal area is arid, and agriculture is totally dependent on irrigation from rivers descending from the Andes, where rainfall does occur. The irrigation in the river valleys is accompanied by considerable percolation losses. In the underlying deep and permeable aquifers, the percolation losses are transported towards the coast. A salt water wedge intruding from the ocean and a decreasing land slope towards the coast forces the aquifer water to flow upwards, and the watertable becomes shallow (Figure 17.34). The continuous upward seepage of groundwater feeds capillary rise into the unsaturated zone. The subsequent evaporation causes salts to accumulate in the topsoil. For these two reasons, irrigation and agriculture can only be practised in seepage zones when a subsurface drainage system is installed.

The area in the delta has light-textured soils and it had to be prepared for irrigated sugarcane (Suclla Flores 1972). This cane has a growing season of 14 to 16 months, with irrigation for a period of 10 to 12 months (the vegetative period), followed by an unirrigated period of 4 to 6 months (the ripening or drying period), during which the cane augments its sugar content. The average depth of the watertable in the

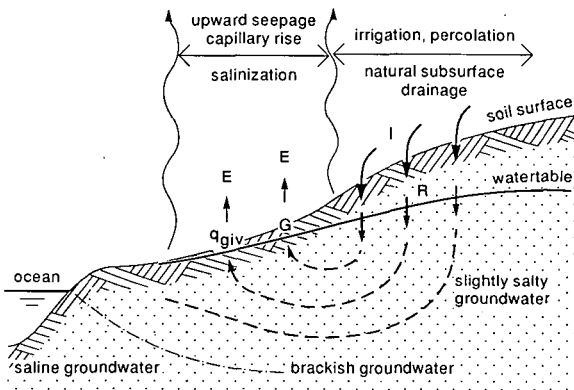

Figure 17.34 Cross-sectional sketch of the geohydrological situation in Coastal Peru (Example 17.4)

irrigation season is permitted to be 0.8 m (such a value is also found from Figure 17.7, which refers to sugarcane in Australia), but during the ripening period the average depth should be more than 1.3 m; otherwise the crop uses too much of the capillary rise and the ripening does not proceed well. There are therefore two agricultural criteria for the subsurface drainage system, and the system has to satisfy both. The slight resalinization of the soil during the ripening period is not a problem, because, with the first consecutive irrigations, the accumulated salts will be removed again quickly.

The rate of upward seepage from the deep aquifer (called q_{giv}) can be estimated from the equilibrium depth of the watertable before irrigation and drainage systems were introduced. In that situation, the topsoil was dry ($pF = 4.0$) and the seepage rate equalled the steady rate of capillary rise from the saturated zone (G), which also equalled the rate of evapotranspiration ($q_{giv} = G = E$). Under such conditions, the rate of capillary rise can be found from the steady-state relationship between depth of watertable, hydraulic properties of the soil, and soil-water content (Chapter 11). An example is shown in Figure 17.35. If the average depth of the watertable before drainage was 0.8 m, the estimated rate of capillary rise from the saturated zone was 2.0 mm/d, which gives us the value of the average seepage rate q_{giv} .

In the seasonal water balance of the soil profile, we may ignore the storage term, and we get

$$q_d = R - G + q_{giv} \quad (17.4)$$

where

- q_d = drainage rate (mm/d)
- R = percolation rate (mm/d)
- G = capillary rise (mm/d)
- q_{giv} = upward seepage (mm/d)

The irrigation system is designed to apply 2400 mm/yr (i.e. during the vegetative period), of which 800 mm/yr is assumed to be lost as deep percolation. The average

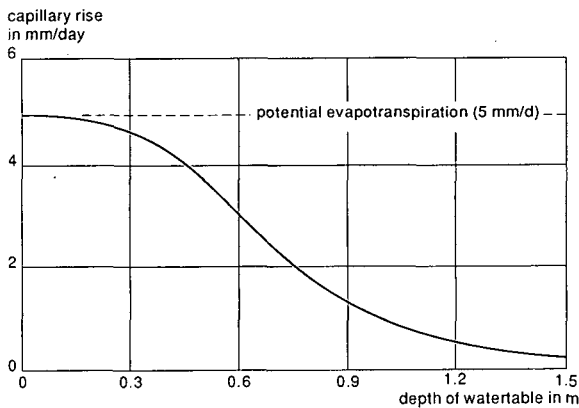

Figure 17.35 The relationship between depth of the watertable and rate of capillary rise in Example 17.4, under the conditions that the watertable depth is steady, the rates of upward seepage and capillary rise are equal, there is no irrigation or rainfall, and the topsoil is dry ($pF = 4$)

Table 17.7 Estimate of the drain discharge from the components of the water balance for irrigated sugarcane in Coastal Peru (Example 17.4)

Area	Seepage rate q_{giv} (mm/d)	Percolation rate R (mm/d)	Capillary rise G (mm/d)	Drain discharge $q_d = q_{giv} + R - G$ (mm/d)
Irrigation season				
A	2.0	2.2	0	4.2
B	3.0	2.2	0	5.2
C	1.0	2.2	0	3.2
Ripening season				
A	2.0	0	0.5	1.5
B	3.0	0	0.5	2.5
C	1.0	0	0.5	0.5

percolation rate thus equals $R = 800 / 365 = 2.2$ mm/d, and the capillary rise G is nil. Hence, the average drain discharge during the irrigation season can be estimated from Equation 17.4 as $q_d = 2.2 + 2.0 = 4.2$ mm/d (see Table 17.7). During the ripening period, there is no percolation ($R = 0$), but some capillary rise will take place as the soil becomes dry; it is estimated at $G = 0.5$ mm/d (Figure 17.35). The drain discharge is now estimated from Equation 17.4: $q_d = 2.0 - 0.5 = 1.5$ mm/d.

The capillary rise ($G = 0.5$ mm/d or 90 mm over 180 days) will cause some salinity build-up in the rootzone, but the amount of percolation of 800 mm/yr is amply sufficient to cover the leaching requirement, even when its irregular spatial distribution in the field is taken into account.

To satisfy the agricultural criterion for the ripening period, the depth of the drains (g) should be greater than the watertable depth (j) of 1.3 m; say 1.5 m. The available hydraulic head (h) during the irrigation period is $h = g - j = 1.5 - 0.8 = 0.7$ m, and, during the ripening period, it is $1.5 - 1.3 = 0.2$ m.

The required drain spacings for the irrigation and ripening periods can now be calculated with the equations given in Chapter 8. The drain spacing adopted should be the one that satisfies both drainage criteria. It should also be possible to vary the drain depth (say from 1.5 to 1.7 m) so that an optimum combination of drain depth and drain spacing can be found. Table 17.8 presents an example of the result of calculations for areas with different seepage rates. The table shows that the required drain spacings are wider as the drain depth increases and the seepage diminishes. In Area B, which has the highest seepage rate, the ripening period appears to be critical for drainage design, because this period requires the smaller drain spacings. In Area C, which has the lowest seepage rate, the vegetative period (corresponding to the irrigation season) is critical. In Area A, the seasonal influence on the required drain spacing depends on the drain depth. The possible combinations are therefore:

- Area A: 1.5 m depth with 77 m spacing, and 1.7 m depth with 120 m spacing, determined by, respectively, the ripening period and the vegetative period (irrigation season);

Table 17.8 Calculation of drain depth and spacing in Coastal Peru (Example 17.4)

Area	Drain depth g (m)	Depth of the watertable j (m)	Hydraulic head $h = g - j$ (m)	Drain discharge* q_d (mm/d)	Calculated drain spacing** L (m)
Irrigation season					
A	1.5	0.8	0.7	4.2	96
B	1.5	0.8	0.7	5.2	81
C	1.5	0.8	0.7	3.2	120
Ripening season					
A	1.5	1.3	0.2	1.5	77
B	1.5	1.3	0.2	2.5	51
C	1.5	1.3	0.2	0.5	196
Irrigation season					
A	1.7	0.8	0.9	4.2	120
B	1.7	0.8	0.9	5.2	100
C	1.7	0.8	0.9	3.2	150
Ripening season					
A	1.7	1.3	0.4	1.5	140
B	1.7	1.3	0.4	2.5	91
C	1.7	1.3	0.4	0.5	355

* From Table 17.7

** Calculation based on the method presented in Figure 8.4 (Chapter 8) using a hydraulic conductivity $K = 1.0$ m/d, a drain radius $r = 0.1$ m, and a depth of the impermeable layer $D = \infty$ m

- Area B: 1.5 m depth with 51 m spacing, and 1.7 m depth with 91 m spacing, both determined by the ripening period;
- Area C: 1.5 m depth with 120 m spacing, and 1.7 m depth with 150 m spacing, both determined by the vegetative period.

In view of the difficulty of installing drains below the watertable, it is a sound technical practice to place the drains as shallowly as possible (i.e. at 1.5 m depth).

NOTE

The requirement of a fairly deep drain depth in this example is dictated more by the specific crop requirements during the ripening period than by the need for salinity control, which is automatically fulfilled by the percolation losses. Under most agricultural conditions, drain depths can be shallower than 1.5 m, which often enhances ease of installation and reduces installation cost per m length of drain. This offsets the disadvantage of needing more drains per ha than with deeper drains.

Example 17.5 Northern Peru

Figure 17.36 shows a cross-section through sloping agricultural land in Northern Peru. The land is arid and is equipped with an irrigation system. The land had to be abandoned, however, owing to problems of waterlogging and salinity. The soil is sandy, but at some depth the presence of a compact clay layer was noted. At the downslope end of the land, this clay layer rises to the soil surface, but farther upslope it is deeper. Here, massive irrigation occurred and the resultant percolation losses continued downslope as groundwater flow.

Since the slope (s) of the watertable at the right-hand side of the figure equals the slope of the interface of the clay layer, which is about 1% ($s = 0.01$), and the hydraulic conductivity of the sandy soil could be estimated at $K = 2 \text{ m/d}$, the amount of horizontal groundwater flow per metre width through the sandy layer could be calculated, with Darcy, as $K.D.s = 2 \times 2 \times 0.01 = 0.04 \text{ m}^2/\text{d}$, where D is the level of the watertable above the interface. Over a length of 1000 m (Figure 17.36), this means a horizontal groundwater inflow rate, q_{gih} , of 0.04 mm/d.

Since the land considered is no longer irrigated, the climate is dry, and the watertable remains shallow, we can conclude that the continuous capillary rise from the watertable and the subsequent evapotranspiration of the weeds and shrubs is fed by an inflow of groundwater. According to the physical principles of steady-state capillary rise, its rate can be estimated from the depth of the watertable (Chapter 11). Thus the rate of capillary rise could be estimated at $G = 3 \text{ mm/d}$. Hence, the upward seepage of groundwater, q_{giv} , also equals 3 mm/d.

The value of q_{giv} is almost 100 times greater than the value of q_{gih} . This leads to the conclusion that the clay layer has sufficient permeability to permit the passage of the seepage flow. Hence, the greater part of the groundwater seeping up into the land originates from a great depth, and there must be a deep and permeable aquifer below the clay layer. We can therefore conclude that, somewhere downslope of the

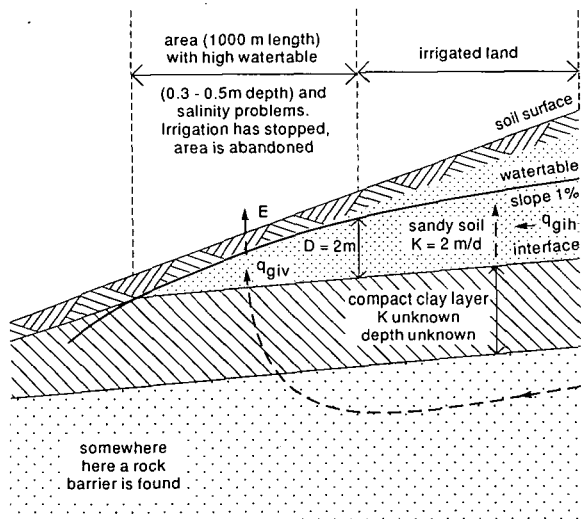

Figure 17.36 Cross-sectional sketch of the hydrological situation in Northern Peru (Example 17.5)

land, there must be an underground barrier to the flow of groundwater which forces this flow upwards.

The technical solution to the problem of waterlogging would be to install a regular subsurface field drainage system or to introduce pumped wells, employing the usual agricultural criteria for subsurface field drainage systems (Section 17.3.7), while ensuring that irrigation can be effectively resumed. For example, we could use the agricultural criterion that the average depth of the watertable during the irrigation season should be 0.8 m, which satisfies the requirements of most crops. We can find the corresponding design discharge from a water balance, taking into account the percolation stemming from the irrigation and the upward seepage of the groundwater, both taken as an average rate during the season considered.

The example of Northern Peru shows that the mere horizontal flow of groundwater contributes little to the subsurface drainage problem, but that the main causes must be sought in vertical recharges from percolation and/or upward seepage. Intercepting the almost horizontal flow, q_{gih} , would therefore not alleviate the problem. The reasons are two-fold:

- If the impermeable layer is shallow, an interceptor drain would catch 100% of the horizontal groundwater flow, but the amount of flow is so small that it cannot create an extensive problem of waterlogging, so the interceptor drain is hardly needed;
- If the impermeable layer is deep, there is an aquifer with a high transmissivity which can cause waterlogging over an extensive area, but an interceptor drain would catch only a very small fraction of the groundwater flow and would not significantly solve the extensive waterlogging problem.

17.5.3 Irrigated Lands in Sub-Humid Zones

Sub-humid zones are often characterized by a rainy season with high rainfalls (say more than 100 mm per month, and with extreme rainfalls up to 100 mm per day), followed by a dry season. The rainy season may coincide with a cool winter period (e.g. as in North-West Africa), or with a hot summer period (e.g. the monsoon in South-East Asia and West Africa, south of the Sahara). However, also in tropical areas without distinct winter or summer seasons, there may be pronounced rainy and dry seasons (e.g. East Africa).

In the sub-humid zones, irrigation is often practised during the dry season, but also during the rainy season if the rainfall is erratic. When drainage problems occur, salinity problems are often also apparent. The drainage systems to solve these problems should be clearly distinguished in surface drainage systems for the rainy season, subsurface drainage systems for the dry (irrigated) season, and perhaps combined surface and subsurface drainage systems for the rainy season. The drainage criteria have to reflect this differentiation. In addition, a thorough study is required to check whether the drainage problem is entirely the result of local rainfall or of incoming groundwater, or whether inundations from side slopes, rivers, lakes, or seas are the main cause. Where such inundations occur, a drainage system should not be implemented without a flood control system, and perhaps this alone will be sufficient to relieve the waterlogging.

In the following, an example will be given of the development of criteria for subsurface field drainage systems by pipes in North-West India, which has a monsoon climate. Unfortunately, the practice of combined surface and subsurface drainage systems in sub-humid zones is not well developed, so that we have little experience on drainage criteria for combined systems to draw from. In irrigated lands of the sub-humid zones, drainage systems are often lacking or, if present, are either solely surface or solely subsurface systems. When there is only surface drainage, salinity problems are not counteracted, and when there is only subsurface drainage, the surface drainage problems either persist or are tackled with an excessively expensive subsurface system geared to cope with very high discharges.

Example 17.6 North-West India

Rao et al. (1990) describe the results obtained with subsurface drainage by pipes in an experimental area in North-West India. The area was waterlogged during the monsoon period and was very saline. Pipe drainage systems were installed at a depth of 1.75 m and with spacings of 25, 50, and 75 m. The average drain discharge was, respectively, 2.7, 1.1, and 0.9 mm/d during the irrigation season from October to February. This reveals that the discharge of the drainage system with 25 m spacing was high, that more irrigation water was applied there, and that the irrigation was less efficient.

After drain installation, the area's annual rainfall of about 700 mm, occurring mainly in the months of July to September (the monsoon season), desalinated the soil. The rainwater was conserved in the field by bunds, so surface drainage was impeded and infiltration was enhanced. Table 17.9 shows the measured soil salinities. The initial soil salinity corresponded to an electric conductivity of a saturated paste (EC_e) of about 50 dS/m in the surface layer of 0.20 m, and about 20 dS/m in the deeper layers down to 1.2 m. Within 4 months, the soil salinities had come down to levels that were generally below 10 dS/m. The reduction in soil salinity as well as the yield increase of the crops was faster with the 25 m spacing than with the larger spacings. After a period of three years, however, significant differences were no longer observed.

The faster reclamation with the 25 m spacing was achieved at the cost of a much more expensive drainage system and of less efficient irrigation in the post-monsoon season.

Table 17.9 Soil salinity (EC_e in dS/m) in the Sampla pilot area before (June 1984) and at the end of the first monsoon season after drain installation (October 1984) (Rao et al. 1990)

Depth of soil layer (m)	Drain spacing (m)					
	25		50		75	
	June	Oct.	June	Oct.	June	Oct.
0 - 0.2	50.7	5.3	50.7	8.1	46.1	8.3
0.2 - 0.4	23.6	4.0	19.4	4.7	26.4	9.1
0.4 - 0.6	19.4	3.7	15.8	7.9	13.4	9.0
0.6 - 0.9	17.0	4.8	16.8	11.1	11.1	9.4
0.9 - 1.2	12.2	7.6	15.5	14.3	12.6	10.2

With the 25, 50, and 75 m spacings, the watertable rose above 1.0 m for about 85, 90, and 108 days, respectively, during the 5-year period from 1984 to 1988. Yet, during the monsoon season, the time-averaged depth of the watertable remained well below 0.8 m with all spacings. This suggests that the spacings can be fairly wide (> 75 m) and/or that the drain depths can be considerably reduced.

The average discharge rates during the monsoon season (i.e. from July to September) for the 25, 50, and 75 m spacings were, respectively, 8.1, 2.2, and 1.1 mm/d. The rate for the 25 m spacing is very high, and is difficult to explain. It is much higher than the leaching requirement. In such a situation, one ought to consider a combination of surface and subsurface drainage systems to relax the subsurface drainage requirements, or one ought to examine whether water conservation could be improved. The last objective could be achieved by restricting the drain outflow (Qorani et al. 1990), but also by reducing drain depth and increasing the spacing (Oosterbaan and Abu Senna 1990).

The evacuation of the salty drainage water in the dry season is not desirable because it would contaminate the river water below the outlet. It was found that the drainage water can be re-used for irrigation in the dry season when the salt concentration of the drainage water is reduced from the usual 12 kg/m³ to 6 kg/m³ by mixing it with fresh irrigation water (Sharma et al. 1990). With such a mix, the crop production is hardly affected, provided that the resulting accumulation of salts in the soil is removed by drainage during the rainy season. Evacuating the salty drainage water in the rainy season is not harmful owing to the high river discharges so that the contamination of the river water is negligible. Instead of pumping the drainage water for irrigation, one can also refrain from pumping, letting the crops use groundwater directly (Rao et al. 1992), thereby saving irrigation water.

Suitable drainage criteria appear to be the following:

- During the monsoon season, the average depth of the watertable should be 0.8 m to ensure sufficient dryness of the soil;
- During the dry season, the average depth of the watertable should be 0.5 m to ensure an efficient irrigation and to provide an opportunity for the plants to use groundwater by capillary rise, yet providing sufficient soil aeration.

With these criteria, an adequate salt balance of the soil is guaranteed and environmental requirements are met.

The design discharge during the monsoon season follows from the average excess rainfall in that period. During the dry season, the water balance will show that the design discharge is nil, so that no drainage is required. The required depth of the watertable is brought about naturally.

17.5.4 Rain-Fed Lands in Tropical Humid Zones

The humid tropics are characterized by long-lasting rainy seasons (more than 8 months) with an annual rainfall exceeding 2000 mm. Waterlogging occurs frequently in the flat areas. As in the sub-humid zones, one has to assess the extent to which inundations from rivers, lakes, or seas contribute to the waterlogging. When the inundations have a strong influence, no attempt should be made to implement a

drainage system without a flood-control scheme. Further, investigations ought to be made to check whether an adjustment of the cropping system would be sufficient to eliminate the drainage problem. If a drainage system is still found to be necessary, a surface drainage system is usually the appropriate choice, because subsurface drainage systems in the humid tropics are often prohibitively expensive as they would have to be designed for very high discharge capacities and would need very narrow spacings. Only when the soil's hydraulic conductivity is very high could the spacing be wide enough to be practically feasible.

In the following paragraphs, an example will show how the discharge capacity was determined for the collectors serving a surface drainage system in a coastal plain in Guyana. Another example will demonstrate the effects of subsurface drainage systems on agriculture in a coastal plain of Kalimantan, Indonesia.

Example 17.7 Guyana

This example concerns the collectors for surface drainage systems in sugarcane plantations in the coastal region of Guyana (Naraine 1990).

According to Equation 16.4 (Chapter 16), the surface water balance, for a period of one day, reads

$$D_{so} = P - I - E_0 + D_{si} - \Delta W_s \tag{17.5}$$

where

- D_{so} = runoff depth (mm)
- P = precipitation (mm)
- I = infiltration (mm)
- E_0 = evaporation from the surface (mm)
- D_{si} = surface inflow depth (mm)
- ΔW_s = change in storage of surface water (mm)

In this example, the term D_{si} can be set equal to zero. Because we consider a short period with intensive rainfall, the term E_0 can also be neglected. Thus Equation 17.5 can be reduced to

$$D_{so} = P - I - \Delta W_s$$

The Curve Number Method (Chapter 4) uses this balance (Equation 4.2) to calculate the runoff. This will also be done here.

Table 17.10 shows data on the cumulative 5-day rainfall with a 10-year return period and the resulting cumulative surface runoff D_c calculated with the Curve Number method, using a Curve Number value of 40. This empirical method takes into account the storage ΔW_s and infiltration I in the sugarcane fields, but not the dynamic storage in the fields that is needed to induce the discharge, as will be explained below. Table 17.10 also shows the daily surface runoff D_i and the surface runoff rate q_{so} as a time average of the cumulative surface runoff: $q_{so} = D_c/t$, where t is the time (days). Note that $D_c = \sum D_i$ and $q_{so} = \sum D_i/t$.

The design discharge of the main drainage system can be chosen as the maximum value of the average surface runoff rate: $q_{design} = q_{so(max)} = 35 \text{ mm/d}$. It occurs after 3 days, which is the critical period because, with shorter or longer durations, the q_{so} values are less than 35 mm/d.

Table 17.10 Example of a rainfall-runoff relationship with a return period of 10 years in the case study of Guyana, using the Curve Number method with a Curve Number value $CN = 40$

Duration t (d)	Cumulative rainfall P (mm)	Surface runoff		Average surface runoff rate $q_{so} = D_c/t$ (mm/d)
		Cumulative D_c (mm)	Daily D_i (mm)	
1	2	3	4	5
1	150	14	14	14
2	250	59	45	29
3	325	104	45	35
4	360	128	24	32
5	375	138	10	28

The cumulative surface runoff (D_c , Column 3 in Table 17.10) is plotted in Figure 17.37 against the time. It shows a curve with an S-shape. The slope of the tangent line from the origin to this curve indicates the required discharge capacity of the collectors, with a return period of 10 years ($q_{design} = 35 \text{ mm/d}$).

The S-shape of the runoff curve, which is initially quite flat, shows that the drainage system cannot immediately function at its maximum capacity: there is a delay in the functioning and a necessary dynamic storage. The daily dynamic storage can be found from

$$\Delta W_i = D_i - q_{so} \quad (17.6)$$

Table 17.11 shows the development of ΔW_i and cumulative dynamic storage $\Delta W_c =$

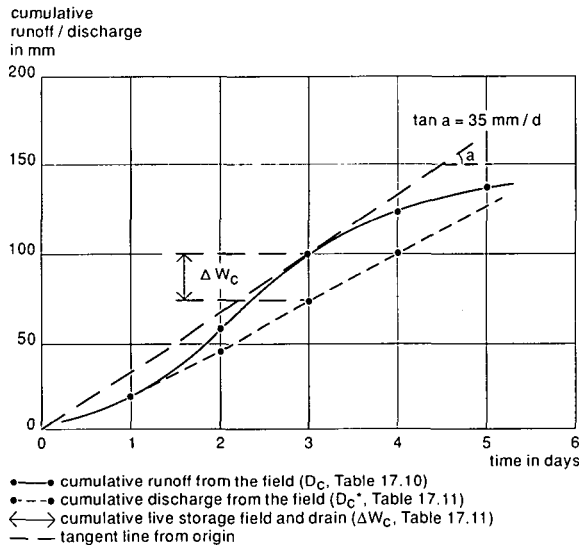

Figure 17.37 Runoff and discharge versus time in the example of Guyana

Table 17.11 Daily and cumulative dynamic storage and discharge derived from Table 17.10.

Time (d)	Storage		Discharge	
	Daily ΔW_i (mm)	Cumulative ΔW_c (mm)	Cumulative D_c^* (mm)	Daily D_i^* (mm)
1	0	0	14	14
2	16	16	43	29
3	10	26	78	35
4	-6	20	108	30
5	-18	2	136	28

$\Sigma \Delta W_i$ with time. Further, it shows the cumulative discharge $D_c^* = D_c - \Delta W_c$ and the daily discharge $D_i^* = D_i - \Delta W_i$. Note that $D_c^* = \Sigma D_i^*$.

It can be seen from Table 17.11 that the daily storage ΔW_i is positive up to the critical time $t = 3$ days, after which it becomes negative. The cumulative storage $\Delta W_c = \Sigma \Delta W_i$ therefore increases up to $t = 3$ days, and afterwards decreases. The table also shows that the maximum daily discharge ($D_i^* = 35$ mm/d) occurs during the 3rd day and it equals the design discharge q_{design} determined from the tangent line in Figure 17.37 and from $q_{\text{so(max)}}$ in Table 17.10.

Naraine (1990) plotted the yield versus the number of high-water days (NHW), defined as the number of days per season during which the water level in the collectors exceeded a level corresponding to a depth of 0.9 m below the soil surface (Figure 17.38). The figure shows that there is a tendency towards decreasing crop yields when the NHW value is greater than about 7. Therefore $\text{NHW} = 7$ can be taken as a design criterion for the collector drainage system.

The above analysis shows that the design of the collector drainage system can be based on criteria that use the same principles as described for collector drainage systems in The Netherlands (Section 17.5.1); only the quantitative values need to be adjusted:

- There should be a high water-level criterion (HW) specifying the water level in the drain that may be exceeded only once in 10 years. (In the example of Guyana, however, this level has not yet been determined.) The corresponding discharge is 35 mm/d;
- There should be a normal water-level criterion (NW) specifying that the water level in the drain may be shallower than 90 cm below soil surface only for 7 days per season. (The corresponding discharge in the example of Guyana has yet to be defined).

Despite the relative shortcomings in the example of Guyana, the analysis permitted Naraine to distinguish the well-drained and the poorly-drained plantations and to recommend criteria for improved drainage systems and to calculate a benefit/cost ratio.

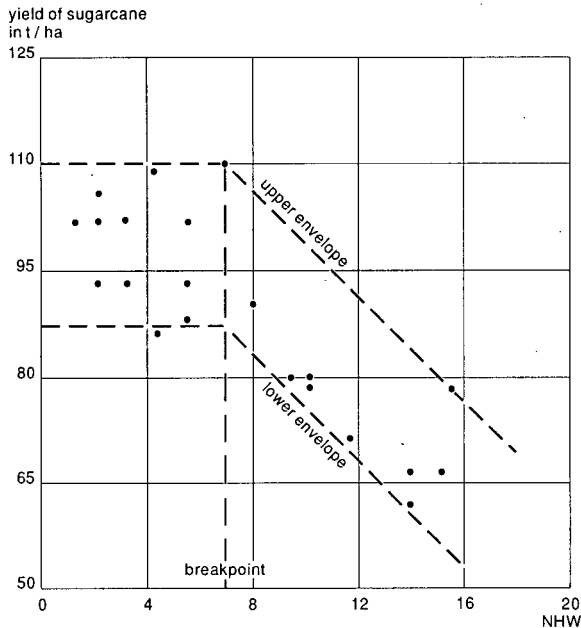

Figure 17.38 Crop yield versus number of days (NHW) with a high water level (above 90 cm below soil surface) in the collector system in the example of Guyana (Naraine 1990)

Example 17.8 Indonesia

The coastal area of Southern Kalimantan, Indonesia, is characterized by the presence of large, deep rivers, between which flat marine and alluvial soils have formed. The soils often contain large amounts of organic matter and/or large amounts of acidifying sulphuric material.

The climate is characterized by an annual rainfall of about 2800 mm, of which roughly 2000 mm evaporates. The excess rainfall, therefore, is about $P - E = 800$ mm/yr. Despite the high excess rainfall, few inundations from the rivers occur owing to their enormous hydraulic transport capacity. Inundations are only apparent near the sea shore and stem from oceanic tides.

Long ago, the inhabitants dug canals from the riversides into the interior of the land. These hand-dug canals are 5 to 10 km long and are spaced at 300 to 500 m. They have an important drainage function as they evacuate the main part of the excess rainfall; they are also used for transport by boat.

A research project in the region has established that the hydraulic conductivity of the soils is extremely high (AARD and LAWOO 1992). Over a depth of $D = 2$ m or more, the highly cracked soils have a hydraulic conductivity of $K = 100$ to 300 m/d. The soils' hydraulic transmissivity values therefore range between $KD = 300$ and 800 m^2/d . During the months with the highest rainfalls (November to May), the excess rainfall $P - E$ (equalling the net recharge R_d) can be estimated at 700 mm to 800 mm, giving an average of about $R_d = 3$ mm/d. From Equation 17.1 (Section 17.3.4), setting $\Delta h = 0$, we find that the average drain discharge q_d also equals 3 mm/d. Using a canal spacing of $L = 500$ m and a transmissivity value $KD = 500$

m²/d, we can calculate the hydraulic head h , using Hooghoudt's drainage formula (Chapter 8) and taking $q = q_d/1000$ m/d, as

$$h = \frac{q L^2}{8KD} = \frac{0.003 (500)^2}{8 \times 500} = 0.2 \text{ m}$$

Since the water level in the canals has an average depth, g , of about 0.5 m below the soil surface, the average depth of the watertable, j , is found at $j = g - h = 0.5 - 0.2 = 0.3$ m below the soil surface. For short periods with high intensity rainfalls, the watertable may rise close to the soil surface, so that the hydraulic head equals $h = 0.5$ m. The discharge rate of the canals then becomes

$$q = \frac{8KDh}{L^2} = \frac{8 \times 500 \times 0.5}{500^2} = 0.008 \text{ m/d}$$

This is a high value, and many farmers in the region have observed that it is difficult to maintain a permanent water layer on their rice fields, and that high water levels in their fields after intensive rainfall drop in a matter of 2 or 3 days. Therefore, the drains are equipped with check gates.

It is not yet possible to decide whether the region is excessively drained by the traditional hand-dug canals or not. To evaluate the agricultural drainage criteria, it would be necessary to take into account the drainage requirements of crops other than rice, the extent to which rice fields and fields with other crops are contingent, and the possibility that occasionally deeper watertables may have a favourable effect on the soil structure or the quality of the soil's organic matter. There are indications that maintaining the watertable at a modest depth below the soil surface during a period with non-rice crops, has a positive effect on the soil's fertility and acidity (AARD & LAWOO 1992).

References

- AARD & LAWOO 1992. Acid sulphate soils in the humid tropics : water management and soil fertility. AARD, Jakarta, 283 p.
- Advisory Panel on Land Drainage in Egypt 1982. The influence of the watertable depth, soil salinity, and groundwater salinity on the crop production of cotton. Drainage Research Institute, Cairo.
- Baily, A.D. 1979. Benefits from drainage on clay soils. Paper No. 79-2549, ASAE winter meeting, American Society of Agricultural Engineers, St. Joseph.
- Berryman C. 1975. Improved production from drained grassland. Techn. Bulletin 75/7, Field Drainage Experimental Unit, Cambridge.
- Blaauw, H. 1961. De berekeningen van waterlopen en kunstwerken. Cultuurtechn. Tijdschr., 1, 3, pp. 79-100.
- Bolton, E.F., J.W. Aylersworth and F.R. Hore 1970. Nutrient loss through tile drains under three cropping systems and two fertility levels on a Brookston clay soil. Canadian Journal of Soil Science, 50, 3, pp. 275-279.
- De Jong, M.H. 1979. Drainage of structured clay soils. In: J. Wesseling (ed.), Proceedings of the International Drainage Workshop. ILRI Publication 25, Wageningen, pp. 268-280.
- Doty, C.W., S.T. Currin and R.E. McLin 1975. Controlled subsurface drainage for southern coastal plains. Journal of Soil and Water Conservation, 30, 2, pp. 82-84.
- Eriksson J. 1979. Soil functions and drainage. In: J. Wesseling (ed.), Proceedings of the International Drainage Workshop. ILRI Publication 25, Wageningen, pp. 180-212.
- Euroconsult 1976. Technical and economic evaluation of different drainage techniques. Euroconsult, Arnhem.

- FDEU 1972. Annual Report. Field Drainage Experimental Unit, Ministry of Agriculture, Cambridge.
- Feddes, R.A. 1971. Water, heat and crop growth. Thesis, Agricultural University, Wageningen, 184 p.
- Feddes, R.A. and A.L.M. van Wijk 1977. An integrated model approach to the effect of water management on crop yields. *Agricultural Water Management*, 1, 1, pp. 3-20.
- Found, W.C., A.R. Hill and E.C. Spence 1976. Economic and environmental impacts of agricultural land drainage in Ontario. *Journal of Soil and Water Conservation*, 31, pp. 20-23.
- Harris, C.R., H.T. Erickson, N.K. Ellis and J.E. Larson 1962. Water level control in organic soil, as related to subsidence rate, crop yield and response to nitrogen. *Soil Science*, 94, pp. 158-161.
- Irwin, R.W. 1981. On farm drainage benefit. *Omaf Res. Progr.* 39, Proj. A-39-742, School of Engineering, University of Guelph, Canada.
- Jaynes, D.B., R.C. Rice and R.S. Bowman 1988. Independent calibration of a mechanistic-stochastic model for field-scale solute transport under flood irrigation. *Soil Science Society of America Journal*, 52, pp. 1541-1456.
- Lenselink, K.J. 1972. Drainage requirements for banana in the young coastal plain (in Dutch, title translated by author). *De Surinaamse Landbouw*, Vol. 20, pp. 22-36.
- Minessy, F.A., M.A. Barakat and E.M. El Azab 1971. Effect of some soil properties on root and top growth and mineral content of Washington Navel orange and Balady mandarin. *Plant and Soil*, 34, pp. 1-15.
- Naraine, D.S. 1990. The development of drainage criteria and their application to sugar cane cultivation in Guyana. MSc. thesis, International Institute of Hydraulic Engineering, Delft.
- Nijland, H.J. and S. El Guindy 1984. Crop yields, soil salinity and watertable depth in the Nile Delta. In: *ILRI Annual Report 1983*, Wageningen, pp. 19-29.
- Nijland, H.J. and S. El Guindy 1986. Crop production and topsoil/surface water salinity in farmers' irrigated rice fields, the Nile Delta. In: K.V.H. Smith and D.W. Rycroft (eds.), *Hydraulic Design in Water Resources Engineering : Land Drainage*. Proceedings of the 2nd International Conference, Springer, Berlin, pp. 383-392.
- Nolte, B.H., N.R. Fausey and R.W. Skaggs 1982. Time available for field work in Ohio. Summer Meeting, Paper No. 82-2076, American Society Agricultural Engineers, St. Joseph.
- Oosterbaan, R.J. 1982. Crop yields, soil salinity and watertable depth in Pakistan. In: *ILRI Annual Report 1981*, Wageningen, pp. 50-54.
- Oosterbaan, R.J. 1988. Agricultural criteria for subsurface drainage: a systems analysis. *Agricultural Water Management*, 14, pp. 79-88.
- Oosterbaan, R.J. 1992. Agricultural land drainage : a wider application through caution and restraint. In: *ILRI Annual Report 1991*, Wageningen, pp. 21-36.
- Oosterbaan, R.J., H.A. Gunneweg and A. Huizing 1987. Water control for rice cultivation in small valleys of West Africa. In: *ILRI Annual Report 1986*, Wageningen, pp. 30-49.
- Oosterbaan, R.J. and M. Abu Senna 1990. Using Saltmod to predict drainage and salinity in the Nile Delta. In: *ILRI Annual Report 1989*, Wageningen, pp. 63-75.
- Oosterbaan, R.J., D.P. Sharma, K.N. Singh and K.V.G.K. Rao 1990. Crop production and soil salinity: evaluation of field data from India by segmented linear regression. In: *Symposium on land drainage for salinity control in arid and semi-arid regions*, Vol. III. Drainage Research Institute, Cairo, pp. 373-383.
- Qorani, M., M.S. Abdel Dayem and R.J. Oosterbaan 1990. Evaluation of restricted subsurface drainage in rice fields. In: *Symposium on land drainage for salinity control in arid and semi-arid regions*, Vol. 3. Drainage Research Institute, Cairo, pp. 415-423.
- Rao, K.V.G.K., P.S. Kumbhare, S.K. Kamra and R.J. Oosterbaan 1990. Reclamation of waterlogged saline alluvial soils in India by subsurface drainage. In: *Symposium on land drainage for salinity control in arid and semi-arid regions*, Vol. 2. Drainage Research Institute, Cairo, pp. 17-25.
- Rao, K.V.G.K., D.P. Sharma and R.J. Oosterbaan 1992. Subirrigation by groundwater management with controlled subsurface drainage in semi-arid areas. *International Conference on Supplementary Irrigation and Drought Management*, Bari, Italy.
- Rudd, A.V. and C.W. Chardon 1977. The effects of drainage on cane yields as measured by watertable height in the Machnade Mill area. In: *Proceedings of the 44th Conference of the Queensland Society of Sugar Cane Technology*, Australia.
- Safwat Abdel-Dayem and H.P. Ritzema 1990. Verification of drainage design criteria in the Nile Delta, Egypt. *Irrigation and Drainage Systems*, 4, 2, pp. 117-131.
- Schothorst, C.J. 1978. Het zakkingsproces bij ontwatering van de westelijke veenweide gronden. *Landbouwkundig Tijdschrift*, 6, pp. 167-175.

- Schwab, G.O., G.S. Taylor, J.L. Fouss and Ehud Stibbe 1966. Crop response from tile and surface drainage. Soil Science Society of America Proceedings, 30, pp. 634-637.
- Shalhevet, J. and P.J. Zwerman 1962. Nitrogen response of corn under variable conditions of drainage. Soil Science, 93, pp. 172-182.
- Sharma, D.P., K.N. Singh, K.V.G.K. Rao and P.S. Kumbhare 1990. Re-use of saline drainage water for irrigation in a sandy loam soil. In: Symposium on land drainage for salinity control in arid and semi-arid regions, Vol. 3. Drainage Research Institute, Cairo, pp. 304-312.
- Sieben, W.H. 1965. Het verband tussen ontwatering en opbrengst bij de jonge zavel gronden in de Noordoostpolder. Van Zee tot Land, 40, Tjeenk Willink, Zwolle, 117 p.
- Skaggs, R.W. 1980. Combination surface-subsurface drainage systems for humid region soils. Journal Irrigation and Drainage Division, Proceedings American Society of Civil Engineers, 106, IR4, pp. 265-283.
- Suella Flores, J.A. 1972. Diseño de la infraestructura de recuperación en zonas afectadas con problemas de drenaje en el Anexo Chiquitoy - C.A.P. Cartavio, Trujillo - Peru. Tesis, Programa Académica de Ingeniería Agrícola, Universidad Nacional Agraria 'La Molina', Lima.
- Todd, D.K. 1980. Groundwater hydrology, 2nd. ed. Wiley, New York, 535 p.
- Trafford, B.D. 1972. The evidence in literature for increased yields due to drainage. Technical Bulletin 72/5, Field Drainage Experimental Unit, Cambridge.
- Van Alphen, J.G. and F. de los Rios Romero 1971. Gypsiferous soils. ILRI Bulletin 12, Wageningen, 44 p.
- Van Hoorn, J.W. 1958. Results of a groundwater level experimental field with arable crops on clay soils. Netherlands Journal of Agricultural Science, 6, pp. 1-10.
- Van Hoorn, J.W. 1979. The effect of capillary flow on salinization and the concept of critical depth for determining drain depth. In: J. Wesseling (ed.), Proceedings of the International Drainage Workshop, ILRI Publication 25, Wageningen, pp. 686-700.
- Van Someren, C.L. 1958. Het drainage-onderzoek in Nederland. Cultuurtechnische Dienst, Utrecht, 51 p.
- Wesseling, J. 1974. Crop growth and wet soils. In: J. van Schilfgaarde (ed.), Drainage for agriculture. Agronomy 17, American Society of Agronomy, Madison, pp. 7-38.
- Wind, G.P. and J. Buitendijk 1979. Simulation over 35 years of the moisture content of a topsoil with an electric analog. In: J. Wesseling (ed.), Proceedings of the International Drainage Workshop. ILRI Publication 25, Wageningen, pp. 214-219.
- Yamada, N. 1965. Some problems of irrigation and drainage in rice culture. International Rice Commission Newsletter, 14, 3, pp. 13-28.
- Young, T.C. and J.T. Ligon 1972. Watertable and soil moisture probabilities with tile drainage. Transactions of the American Society of Agricultural Engineers, 15, 3, pp. 448-451.

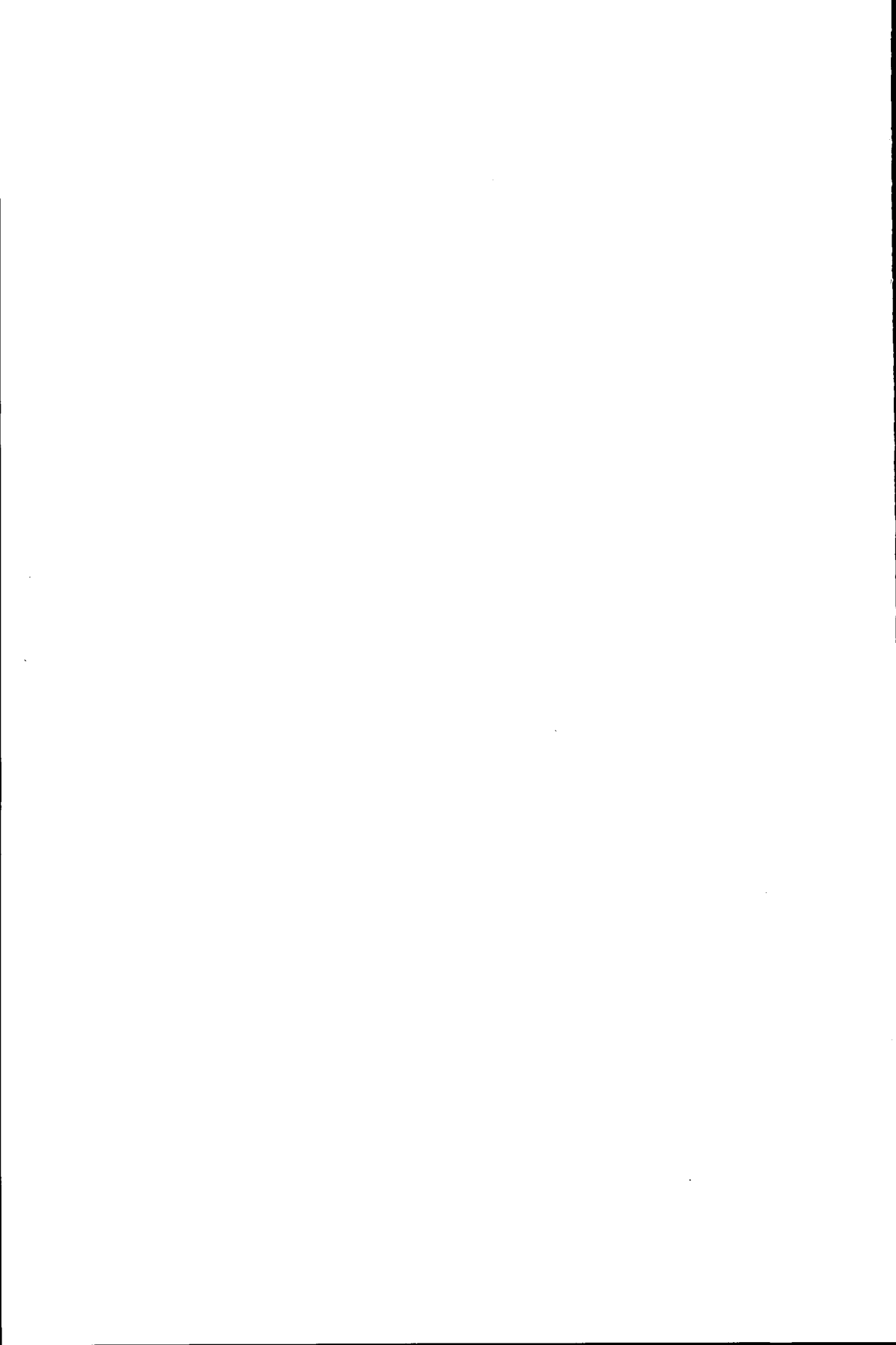

18 Procedures in Drainage Surveys

R. van Aart¹ and J.G. van Alphen²

18.1 Introduction

Previous chapters have covered the various elements of land drainage theory, as well as methods of investigations and surveys. Since these subjects were treated separately and somewhat in isolation, step-by-step instructions on how to proceed when faced with a land-drainage problem will now be given.

True land-drainage projects seldom occur. Land drainage usually forms part of an agricultural development project. The project area may measure from some hundreds of hectares to tens of thousands of hectares.

Planning and implementing an agricultural development project is an interdisciplinary undertaking. The land-drainage engineer is only one of the specialists whose contribution is required. A drainage project may be part of a national, regional, or local development plan. Depending on the activities to be performed during the planned development process, a number of phases can be discerned.

These phases follow a certain sequence, and during the planning process, each phase requires information at an appropriate level of detail. The setting of goals and the formulation of projects is usually based on existing information; little time is spent on fieldwork. On the other hand, drawing up the plan and implementing the project requires a great deal of information, necessitating detailed investigations and surveys. Generally, information at three levels is required: at the reconnaissance, feasibility, and post-authorization level (USBR 1971).

At Reconnaissance Level

When drainage problems have to be tackled, the first step is to conduct a reconnaissance study. Its main objective is to make an inventory of the problems and to formulate possible alternative solutions. The feasibility of the proposed project should be identified on its technical and economic merits.

At Feasibility Level

This phase comprises the additional activities required to select one preliminary plan from among the possible options. The feasibility study should enable financing agencies to appraise the project and to decide whether or not to execute it. Field surveys and investigations are needed to prepare the drainage plan in more detail.

At Post-Authorization Level

The post-authorization phase comprises the final design of the project and the preparation of tender documents.

This chapter will elaborate on the concepts of reconnaissance, feasibility, and

¹ International Institute for Land Reclamation and Improvement

² International Agricultural Centre

post-authorization as they are related to land-drainage surveys. It should be borne in mind that the procedures outlined will not be unconditionally applicable under all circumstances. They may have to be modified or adjusted to take local conditions into account, or to comply with the special wishes of a governmental or regional planning commission.

18.2 The Reconnaissance Study

A reconnaissance study comprises the desk and field research needed to obtain a general knowledge of the development potential of the project area. To formulate the project, a broad inventory of the land, water, and human resources has to be made. A great degree of reliance is placed upon existing data or on indirect sources of information. Field work is usually kept to a minimum.

A physical plan has to be prepared so that the technical options can be assessed. Costs and benefits should be estimated to allow an appraisal of the economic feasibility of the project. The study must give a clear picture of possible constraints to development and whether further investigations are justified.

Experience has shown that further investigations will only be justified if the project as a whole is likely to double or triple the gross output. It is stressed that this doubling or tripling of gross output refers to all planned project activities; improved drainage is just one of these.

Frequent consultations are needed between the land-drainage engineer and the other specialists in the team, particularly with the agronomist, the soil scientist, the economist, the irrigation engineer, and the hydrologist. Often the functions of land-drainage engineer and irrigation engineer are combined in the same person, who sometimes has the function of hydrologist as well. In many countries, this multidisciplinary scientist is a civil engineer whose contact with the agronomist and soil scientist is often too superficial. This lack of understanding between them may result in a project with major emphasis on main drainage works, and less on field drainage systems. The ultimate goal, however, is better crop production, and this can basically only be achieved by means of proper field drainage.

Figure 18.1 presents the steps to be followed in a drainage reconnaissance study. These are:

- Collecting and evaluating basic data, such as data on topography, climate, hydrology, physiography, soils, and present land use. The data available may vary in their degree of detail and accuracy. It will therefore usually be necessary to undertake some field trips to get a better appraisal of the nature of the problem (e.g. 'Is there a surface or subsurface excess of water?'), its extent (the size of the problem area), and its magnitude (e.g. a decline in crop yields). Such field trips should preferably be undertaken with the agronomist and the soil scientist;
- Planning the potential land use. This calls for teamwork; the land drainage engineer is only one member of the team. There will usually be several possible alternatives for potential land use. For instance, it may be possible to grow food or cash crops, or to rear cattle, or to irrigate, or to practise rain-fed farming with or without supplemental irrigation, or to grow one or more crops a year. Social constraints

BASE DATA COLLECTION: - topography - climate - hydrology - geology and physiography - soils - present land use
PROJECT FORMULATION: - (preliminary) lay-out - main irrigation system - water application - potential land use - flood hazard - defining drainage problem . surface drainage . subsurface drainage . discharge by gravity or pumping
PHYSICAL PLAN: - preliminary lay-out - main drainage system - aspects of field drainage system
COSTS AND BENEFITS: - cost estimate land drainage works - estimate benefits land drainage works

Figure 18.1 Steps to follow in a drainage reconnaissance study

or specific soil conditions may prevent some crops from being grown. There may or may not be well-established market outlets or facilities for processing certain crops. Some alternative types of land use, though technically sound at first sight, may have to be dropped for socio-political or agro-economic reasons;

- Defining the land-drainage problems, albeit in general terms, for the various land-use options. The following issues should be addressed:
 - The location and extent of the problem;
 - The origin of the excess water;
 - Inundation and the need for flood control;
 - Salinity and sodicity (alkalinity), acidity, high organic-matter content;
 - Is there a surface and/or a subsurface drainage problem?
 - Can excess water be disposed of by gravity or is pumping required?
 - Can engineering problems be expected?
 - The general layout of the main drainage system;
 - Should drainage works be executed mainly by machinery or can manual labour be employed?
 - The costs and benefits of the land-drainage works;
 - How and by whom are the land-drainage works to be operated and maintained?

The question of operation and maintenance is all too often overlooked. No one will dispute that all constructions, including land-drainage works, require maintenance. The issue is who is responsible for, and who is going to pay for, the operation and maintenance of the drainage systems. In many agricultural development projects, this issue is decided, at least on paper, but, unfortunately, land drainage is usually given the lowest priority. One should remember, however, that it is always the weakest link that determines the success or failure of a project. The land-drainage engineer should be fully aware of this fact. He should therefore conduct opinion polls

on the need for land drainage, do extension work on the purpose of land drainage, and work in close cooperation with the users of the land, irrespective of the size of their holdings.

18.2.1 Basic Data Collection

For a proper assessment of the land-drainage problem and the costs of the drainage works, it is essential to have topographic and geological maps, aerial photos, and information about climate, soils, and land use.

Topography

A topographic map on a scale of between 1:50 000 and 1:100 000 showing contour lines of the land surface is an indispensable tool in reconnaissance drainage surveys. The map should show all topographic and physiographic features relevant to drainage: towns, villages, roads, railways, paths and tracks, rivers and streams, natural drainage channels, canals, ditches, cultivated land, waste land, and natural vegetation. If a topographic map of the proper scale does not exist, little else can be done than to have one made, preferably from controlled aerial photo mosaics.

On 1:100 000 maps, contour lines are often presented at 5.0 to 10.0 m intervals. In sloping areas, this may provide sufficient detail, but in flat areas, more precise information is required, say at 1.0 m intervals. The topography of the area governs such matters as the siting of observation points; the alignment and slope of main canals, collector ditches, and field laterals; the maximum length of the field laterals; the installation of weirs; and the selection of the drainage outlet. Spot elevations of the land surface should be shown on the topographic map, enabling the slope of the land to be derived. A simple geodetic field survey will provide this information.

At the proposed drainage outlets, detailed information on the water levels in the river or sea should be available. High river-water elevations and the effect of the tide on drainage-outlet elevations should be established. (Data requirements will be discussed in Chapter 24.) Unfortunately, data on river-water levels during peak discharges are often scanty.

A thorough analysis of topographic data is needed. Such an analysis may, for example, reveal the direction of natural drainage or the concentration point of this flow. Sudden changes in topographic level and specific geomorphic features (e.g. alluvial fans, abandoned and filled stream channels, natural drainage courses, springs, seeps, and abandoned wells) can all have an impact on the drainage problem. Surface drainage difficulties can be expected, for instance, if slopes are less than 0.1%, and especially if they are less than 0.05%.

Climate

Climate has a major impact on the environment and is often responsible for variations in soils, water, and the appearance of plants. It is a decisive factor in determining the type of drainage system to be applied.

In humid climates, drainage is largely required to evacuate excess rainfall, whereas, in arid and semi-arid climates, drainage is needed mainly to remove excess irrigation water.

As the land-drainage measures to be taken are closely related to the crops to be cultivated, an agro-ecological-zone classification of the project area is a useful tool during a reconnaissance study. To determine the project area's agro-ecological zone, the main climatic data needed are the average monthly temperature and the average annual precipitation. In addition, a balance of the water available for the proposed crops should be prepared. This requires data on potential evapotranspiration and monthly rainfall. The agro-ecological-zone classification makes clear whether it is possible to cultivate rain-fed crops or whether there is a need for irrigation.

An assessment of the magnitude of the land-drainage problem also requires information on rainfall intensity. Data on 24-hour rainfall should be examined, and return periods of high-intensity rainfall should be determined. Many countries lack a network of meteorological stations where climatic data have been collected over an extended period of years. Hence, choosing representative climatic data for the project area may not be easy. (For more information on rainfall-data handling, see Chapter 6.)

Hydrology

It is recognized nowadays in hydrology that surface water and groundwater should be considered together. This is especially valid in arid and semi-arid regions, where the hydrology is characterized by a high variability of rainfall, intermittent and sometimes short-lived river flow, high evaporation rates, the importance of the soil moisture in the runoff process, and the sometimes high salinity of surface water, soil moisture, and groundwater.

The hydrological regime of a river depends on the rainfall, the evaporation, and the physiographic characteristics of the river basin (see Chapter 2). In many basins, the rivers have their catchment areas in a region with a climate different from that of their alluvial river plains, so the hydrological regime will then be affected by the hydrometeorological conditions of both regions.

Rivers situated entirely in arid and semi-arid regions have an erratic, flash-type regime, reflecting the variability in rainfall. In contrast, many monsoonal rivers in the humid tropical zone have a long period of sustained high flow during the wet season, followed by a gradual decrease in flow during the dry season. The same holds true for rivers like the Indus, which rise in snow-covered mountains and debouch into arid river plains. Examples of both gentle and erratic river regimes are shown in Figure 18.2.

An understanding of the hydrological regime of the particular river plain in which the project is to be sited gives a good insight into the possibility of natural drainage

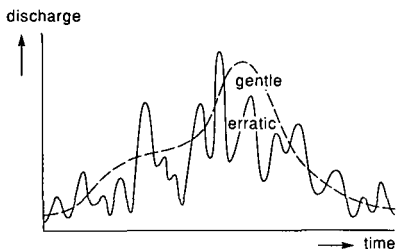

Figure 18.2 Gentle and erratic river regimes

in the upper reaches of the river and into the process of salt-water intrusion in coastal areas.

The natural salinity of the river water also depends greatly on the conditions in the river catchment. Catchments in the arid zone show relatively high salinities. For example, the salinity of the Banas River in India, fed by monsoonal rains and debouching into the Rann of Kutch, varies between 1.0 and 2.0 dS/m salt. In contrast, the water of the Indus River, which is fed by snow-melt water, ranges from 0.3 to 0.5 dS/m salt.

Most alluvial plains contain pervious strata consisting of unconsolidated formations of considerable depth. These pervious strata, which act as aquifers, are interbedded with semi-pervious strata, which act as aquicludes. The groundwater in the aquifers has a salinity that varies with location and depth. The salinity is generally low under the upstream parts of the delta and increases towards the sea. There is also a general increase in salinity with depth.

Nevertheless, there are many departures from this general picture. The distribution of the salinity of the deep groundwater is determined by the geological history of the alluvial plain, with transgressions and regressions that have occurred during the deposition of the subsoil. The actual distribution in a given case cannot be predicted, and extensive geohydrological investigations are required to make an inventory.

Geology and Physiography

During a reconnaissance survey, a certain knowledge of the geology of the project area and its surroundings will be acquired. Since geological conditions can cause drainage problems, a geological map of the region may be most helpful in delineating problem areas.

Geological maps will usually not show detailed information of the geology of alluvial plains. Hence, major and minor landscape features will have to be mapped on the basis of aerial photographs, with a limited amount of field work to confirm their formation.

In a reconnaissance survey, there will usually not be sufficient time or money available for exploratory drillings. Yet, it is of crucial importance that some knowledge be gained of the geological conditions of the project area. The geological map should be supplemented by a number of cross sections showing the lithological sequence, the depth and thickness of water-transmitting layers, and the depth of the impervious layer. For this purpose, a search should be made for the logs of existing wells (both deep wells and village wells). If such logs do not exist, a number of hand auger holes can be made to a depth of 5 m, provided that there are no rocks or encrusted soil layers near the surface. For reasons of efficiency and economy, this work can be coordinated with that of the soil survey.

Soils

A soil map at a scale of between 1:50 000 and 1:100 000, based on a systematic soil survey, will supply plenty of data on the project area's soil resources. The soil map should provide a clear answer to the question of whether the soils are suitable for the proposed crops, or, if not, what other crops could be grown successfully (see Chapter 3). Special attention should therefore be given to the conditions of the upper rootzone (0.0 to 0.3 m): its workability, water-holding capacity, erodibility, and, if

irrigation is to be practised, its infiltration rate and whether crusts or impeding layers occur or will form. Factors to be studied in the lower rootzone (0.3 to 1.2 m) are the effective soil depth, subsurface drainage (particularly layers that would limit water percolation), and water-holding capacity.

A classification of the soils according to a standard taxonomy may provide much useful information on the extent of the drainage problem. Systematic field soil surveys will enable the areas with salt-affected soils to be delineated, but the cause of soil salinization still has to be found.

The depth of soil observation in systematic soil surveys is generally limited to 1.2 to 1.5 m. In the case of subsurface drainage problems, some data on soil stratification and the hydraulic conductivity of the shallow substratum (1.5 to 5.0 m) should be acquired.

Land Use

Prior to planning a drainage system, one must know what the land is to be used for. The proposed land use will largely determine the degree of drainage required and the type of drainage system that will be installed. This calls for a proper knowledge of the suitability of the soil for certain crops. The degree and type of drainage depends on whether the land will be used for, say, annual or perennial crops, cotton or rice, wheat or irrigated pasture. The type of crop is an important factor in determining the design of the drainage system and thus the cost of the drainage works.

If rain-fed crops are to be grown, the monthly water balance provides only rough figures on water excesses or deficits. For land drainage, daily rainfall figures are needed.

For irrigation projects, a reliable estimate of the water losses should be made. In existing irrigation projects, data are rarely available on the efficiency of water use or on the water losses, even if the drainage problems are obvious (salinity!). For new projects, irrigation efficiencies are all too often overestimated. Useful data on the various factors that determine the efficiency of water use have been presented by Bos and Nugteren (1990).

Non-agricultural land use, such as pastures, range lands, forests, and nature reserves, should also be considered, particularly when the land is not very suitable, or entirely unsuitable, for cropping, or when heavy investments would be needed to make the land agriculturally productive.

Examples are depressions with a high watertable and high salinity or sodicity, seepage areas along irrigation canals, and areas with very heavy swelling clays that would require costly methods to improve them.

To define alternative land-use systems, it is customary to conduct a land-classification survey. Any land classification involves two steps: a resource inventory, followed by an analysis and categorization. There are a number of land-classification systems that could be adopted. One such system is the U.S. Bureau of Reclamation's Irrigation Suitability Classification, which can be adapted to different environments with potential for irrigation/drainage development.

When a drainage project is being planned, due consideration should be given to any adverse environmental effects that may be created (see Chapter 25).

18.2.2 Defining the Land-Drainage Problem

Soils, climate, topography, and other conditions vary from place to place, and so, too, do the conditions that contribute to a land-drainage problem. Though complex in nature, two types of problems are usually distinguished, though they may occur in combination:

- Surface drainage problems, where there is an excess of water on the land surface. Surface drainage then aims at an orderly removal of excess water from the surface of the land (see Chapter 20);
- Subsurface drainage problems, where there is an excess of water within the soil at close proximity to the land surface. Subsurface drainage then aims at removing the excess water from the soil and maintaining the watertable at an adequate level. In arid and semi-arid areas, a high watertable is invariably accompanied by soil salinization, so accurate watertable management is also required for salinity control (see Chapters 15, 21, and 22).

Surface and subsurface drainage alike require a system to collect all excess water from the problem area and to evacuate this water beyond the project boundary without affecting neighbouring agricultural land.

Surface Drainage Problems

A reconnaissance survey should focus on the following factors:

- Climate (i.e. high-intensity rainfall);
- Topography (i.e. flat land or only slightly sloping land);
- Soil conditions (i.e. soils characterized by a very low infiltration rate or a slowly permeable horizon at shallow depth);
- Hydrology (i.e. flooding resulting from the inflow of water from neighbouring or distant areas).

Areas suffering from flooding must be investigated for the location and extent of the flooding, the frequency, depth, and duration of the flooding, and the time of the year in which flooding may occur. River water levels and discharges should be evaluated and a study made of the rainfall characteristics (depth, duration, and frequency analysis) and of the watershed characteristics (size, shape, relief, vegetation, and soil).

Clear statements must be made on whether flood-protection measures are needed, and whether upstream regulatory works can be implemented to minimize peak river discharges. In large projects, this will usually be the task of a hydrologist, rather than of a land-drainage engineer.

On flat land, the presence of excess water may be due to the inadequate storage capacity of natural water courses, obstructions in such water courses, irregular topography (local depressions), poor topsoil conditions (low infiltration rate), low storage capacity of the subsoil (dense layers close to the soil surface or shallow watertables), or to the absence of an outlet.

Whereas the rainfall characteristics largely determine the amount of excess water to be expected in the project area in a given period, it is the land use and the weather conditions (evapotranspiration) that dictate the time allowed for the removal of the excess water. For example, winter wheat in a subtropical climate can withstand several

days of flooding without being damaged if the temperature is relatively low and the sky is cloudy.

The reconnaissance survey should provide clear statements on whether a main drainage system is required, and, if so, whether its task will be to intercept and collect flood water from adjacent sloping land, or to collect and remove excess surface water that occurs locally in the project area, or whether it must perform both tasks. An estimate of the quantities of excess surface water to be removed per unit of time must be made. In regions that are comparatively unexplored, this will require a number of field measurements. (Methods of estimating runoff on flat and sloping lands are presented in Chapters 4 and 20.)

Obviously, to keep the costs of excavation to a minimum, excess surface water from an agricultural area should be removed along the shortest possible routes. The results of a reconnaissance survey will show whether natural drainage ways can be used to remove the water or whether an artificial drainage system will have to be installed. Since the direction and alignment of the main canals depend largely on the topography and the slope of the land, the number of alternative routes for the main canals will be limited, unless ample use is made of weirs, drop structures, pumping stations, etc., which will undoubtedly raise the cost of the venture (see Chapter 19).

Conditions at the outlet merit special attention during a reconnaissance survey. It must be investigated whether the excess surface water can be disposed of by gravity or whether a pumping station will have to be constructed. In addition, the quality of the drainage water should be studied, and whether it is possible to mix it with river water of better quality for conjunctive use. The survey report should be accompanied by a map showing roughly the routes of the main drainage canals and the possible sites for the outlet (with or without a pumping station). If necessary, suggested sites for storage reservoirs, embankments, protection works, culverts, bridges, drop structures, etc., should also be shown on the map, and an estimate of their costs should be included in the report.

Environmental aspects, such as the effect of drainage on health, could have a major impact and should also be reviewed. (This subject will be dealt with in Chapter 25.)

Subsurface Drainage Problems

A reconnaissance survey should focus on the following topics:

- An assessment of the groundwater behaviour (i.e. the depth of the watertable at different times of the year, rapid changes in depth, the general direction of the groundwater flow, the salt content of the groundwater, and the areas of groundwater recharge, transmission, or discharge);
- An assessment of the drainability of the project area (i.e. a study of the possible outlets, of the ability of the subsoil to transmit water, and the depth to a layer of very low hydraulic conductivity).

Maps showing the contour lines of the watertable are not generally available, so its behaviour has to be assessed indirectly from vegetation, land use, or soil salinization. Aerial photo interpretation can be of great help.

When irrigation is introduced, the watertable behaviour usually undergoes a drastic change (see Chapter 2). Data on the geomorphology and the subsoil conditions, as well as estimates of irrigation efficiency, should be evaluated to indicate whether

subsurface drainage will be needed in the future (see Chapter 14). As previously mentioned, irrigation efficiencies are often overestimated, and consequently the future need for land drainage is all too often underestimated. The need for drainage thus only becomes apparent after the irrigation project has been implemented and its financial resources have been exhausted.

Soil maps based on systematic soil surveys are often available. Sometimes these maps (or the soil reports) supply some information about the watertable. This information, however, should be handled with great care because it is usually based on a single observation in a soil pit or auger hole. Even so, soil maps can be extremely useful in delineating areas of moist or wet soils.

In the case of subsurface drainage problems, the drainage engineer has to make clear statements on:

- Whether the soil profile is homogeneous or layered;
- The depth to the impervious base, usually a poorly pervious clay bed;
- The presence or absence of a pervious or highly pervious horizon at or below drain depth (between 1.5 and 2.5 m);
- The presence or absence of impeding horizons within the upper 2 m of the soil profile;
- The depth to the watertable and the zone in which it fluctuates during the year (mottling may be an indication);
- The salinity of the groundwater (electrical conductivity and sodium adsorption ratio);
- The type of drainage system (pipe drains or tubewells) to be adopted.

In general, the depth of observation in systematic soil surveys is limited to 1.2–1.5 m. Hence, during a reconnaissance survey, a number of augerings or soil pits should be made to a depth of 2.0 – 2.5 m and a few augerings to a depth of 5.0 m. A rough guide to the number of these deep augerings, which, in alluvial material, can be done by hand auger, is 1 per 200 – 1000 ha. An exact number cannot be given because that will depend on the size of the project area and on the complexity of its geology and physiography. (For more details, see Chapter 2.) Nor can any strict rules be given for the siting of the borings, but the physiography and the direction of sedimentation will serve as guidelines. Borings should be made in each physiographic unit, preferably in a number of cross-sections perpendicular to the natural drainage ways, or in a series of traverses aligned in the direction of sedimentation. For each cross-section, the elevation of the land subsurface, the location of the soil profile, and the depth to the watertable should be drawn. Particular attention should be given to the zone between 1.5 and 2.5 m below the surface, because the hydraulic conductivity of the material below drain depth largely decides the drain spacing. Also, the material at and just below drain depth will indicate whether problems can be expected with drain installation. (Chapter 12 elaborated on this issue.)

To gain some knowledge of the natural drainage out of the project area, or of the inflow of groundwater into it, a number of deep borings should be made along the boundaries of the project area. These borings should penetrate the entire aquifer through which groundwater may be entering or leaving the project area. A few

pumping tests should then be performed, which will allow the aquifer's transmissivity to be calculated. This information, together with a watertable contour map, allows the rate of groundwater inflow or outflow to be calculated. In low-lying land partly surrounded by higher-lying land, the inflow of groundwater may considerably exceed the outflow, thus causing waterlogging. This phenomenon should not be underestimated. If deep main canals cut through the top layer, they may intercept unexpectedly large amounts of seepage. (For details, see Chapters 9, 10, and 16.)

In summary, a reconnaissance drainage survey provides information on the need for drainage and on the type of drainage system to be adopted (pipe drains or tubewells), and enables a tentative layout of the main drains and the outlet to be prepared.

At the end of a reconnaissance survey, a statement should be made on whether the drainage works appear to be economically and/or technically feasible. If the answer is positive, the more detailed feasibility study will then have to be done. A brief statement should also be made on the environmental impact of the proposed drainage works.

18.2.3 Examples

Some examples of reconnaissance drainage surveys are presented to indicate how existing data have been used and what additional field data had to be collected. The examples were selected at random; they are not necessarily representative of land-drainage conditions frequently found in nature.

Example 18.1 Peru

Irrigation is important in the agriculture of Peru. About one-third of the agricultural land is irrigated, the greater part of it being located in the river valleys in the arid coastal region. There, the irrigated area covers some 750 000 ha, and yields approximately 50% of the country's agricultural production.

Salinity has long affected crop growth. In the early sixties, it was estimated that 30% of the cultivated area was affected by salinity.

In 1973, a national plan was launched to rehabilitate the coastal agricultural lands. This plan was based largely on the outcome of a reconnaissance survey of the drainage and salinity conditions. The survey covered 757 000 ha in 42 valleys (Alva et al. 1976). About 34% of the area was found to be suffering from salinity and/or drainage problems (see Table 18.1).

Table 18.1 Areas affected by drainage and/or salinity problems in the coastal region of Peru

Problems	Area	
	(ha)	(%)
No problems	501 780	66.5
Slight drainage and salinity problems	102 360	13.5
Moderate to severe salinity problems	19 385	2.5
Moderate to severe drainage and salinity problems	133 485	17.5

A variety of basic data was available:

- Soil maps, scale 1:50 000 to 1:100 000: The maps presented soil-mapping units, suitability for irrigation classes, land use, and sometimes soil salinity. Soil maps were available for 34 of the 42 valleys;
- Aerial photos, scale 1:17 000 or 1:60 000;
- Topographic maps, scale 1:100 000, with contour lines at 10.0 m intervals;
- Discharges of some rivers, although usually no long-term records;
- Geological information, although usually no data on quaternary deposits;
- Watertable observations: A systematic survey of the watertable had been undertaken in only one valley, and few or no data were available for the other valleys.

Photos and maps were studied in the office, and this was followed by a field inspection. The occurrence and the severity of the drainage and salinity problems were to a large extent governed by the geomorphology of the river valleys. In the central and northern part of Peru, where rivers had deposited an alluvial fan, drainage and salinity problems were mainly found in the lower part of the valley, and groundwater salinity was usually high. In the southern part of Peru, the river valleys are narrow and deeply incised because of a geological uplift of the region. There, a braided river system is common, and shallow groundwater, usually of low salinity, is found in many places.

In general, the field inspections were made only in those areas that had been classified as affected on maps and photos. On the average, 3000 ha of land could be inspected daily. Attention was given to the following items:

- Crop growth and signs of salt damage;
- Evaluation of possible sites for the discharge of excess water;
- Inundation by rivers.

In addition, a limited number of augerings were done to a depth of 2.0 to 6.0 m. Occasionally, the hydraulic conductivity was measured. Information was collected from local administrative centres of the Ministry of Agriculture and from the farmers, but usually this information was verbal and was sometimes biased.

This study not only determined the location and the extent of the problem areas, but also indicated the potential for improvement.

Areas suffering only from salinity were considered easily reclaimable, at least in theory. The limited availability of irrigation water, however, and its generally poor quality, has restricted saline soil reclamation to a few hectares.

In areas with only slight problems of drainage and salinity, immediate land-drainage measures were not considered necessary. Of the 133 000 ha of land with moderate to severe drainage and salinity problems, approximately 90 000 ha could be improved. The remaining 43 000 ha are regarded as non-reclaimable for a variety of reasons:

- Availability of irrigation water: Water is not needed solely for leaching, but also for the renewed irrigation of land currently abandoned because of waterlogging and salinity;
- Soil and subsoil conditions: Soils overlying slowly pervious materials at shallow depth require too narrow a spacing between field drains. A spacing of 50 m between field drains was tentatively taken as a minimum;

- Excessive inflow of groundwater, usually limited to small isolated spots. Here also, too narrow a spacing between field drains would be needed to solve the problem;
- Outlet conditions: The discharge of drainage water was considered too difficult if a low topographical location necessitated pumping. Rivers that frequently overflow or erode their banks formed a further constraint.

Example 18.2 Pakistan

The Drainage IV Project area is situated between the Ravi and Chenab Rivers in the Punjab, Pakistan. It has a gross command area of 141 700 ha, of which 118 000 ha is under canal command.

The area is part of the Indus Plain, which consists of a vast stretch of alluvial deposits, mainly of unconsolidated sand and silt, with minor amounts of clay and gravel. The climate is arid and is characterized by large seasonal fluctuations of both temperature and precipitation. Annual precipitation is only about 250 mm, half of which falls in July and August.

The flat topography, with an average gradient of 0.02%, and the absence of a well-defined natural drainage system in the project area have created a severe surface drainage problem. This has been compounded by the construction of roads, railways, and irrigation works that obstruct surface runoff. To alleviate this problem, a system of surface drains was constructed some eighty years ago. This system, however, is inadequate because of poor design and maintenance, as evidenced by clogged channels and insufficient capacities.

Under the Drainage IV Project, it was decided to rehabilitate existing drains, to install new drains, and to construct stream-gauging stations on drains.

The soils are generally medium-textured in the topsoil, and become coarser with depth. Of a total cultivable command area of 188 000 ha, approximately 48 000 ha are broadly regarded as being suitable for subsurface drainage. Of that area, 29 700 ha have been selected for drainage in three units, to be constructed during the currency of the Project.

The area is badly affected by waterlogging and salinity. A survey of the depth of the watertable and the salinity of the soil was made in January-February 1983. The results are presented in Tables 18.2 and 18.3.

A land-use map at a scale of 1:50 000 was prepared in June-July 1983. It distinguished six land-use classes, namely:

- Class I land is good arable land with a watertable deeper than 1.8 m. It covers about 40% of the total area and does not need subsurface drainage;

Table 18.2 Status of waterlogging

Depth of watertable (m below surface)	Percentage of area
< 0.9	54
0.9 - 1.5	31
1.5 - 3.0	12
> 3.0	3

Table 18.3 Status of salinity of the soil (0 – 1.8 m)

Status	Percentage of area
Non-saline - non-sodic	64
Saline	7
Non-saline sodic	6
Saline - sodic	23

- Class II is fairly good arable land that is in need of subsurface drainage;
- Class III is fair arable land in need of subsurface drainage;
- Class IV is fair arable land with higher soil salinity than Class III, and is also in need of subsurface drainage (Classes II, III and IV are lands that are poorly drained with watertables varying from 0.9 m to 1.8 m below the surface);
- Class V is not arable under the existing conditions; it is currently non-productive or has very poor crop productivity due to salinity/sodicity and/or a high watertable (within a depth of 0.9 m): it needs subsurface drainage;
- Class VI is non-arable land that is excluded from development.

On the basis of the land-use map, the depth of the watertable, and the salinity status of the soil, the 29 700 ha selected for subsurface drainage belong to the following classes: Class II, 1300 ha; Class III, 19 200 ha; Class V, 8000 ha; and Class VI, 1200 ha. Figure 18.3 shows the project area and the area ultimately selected for subsurface drainage.

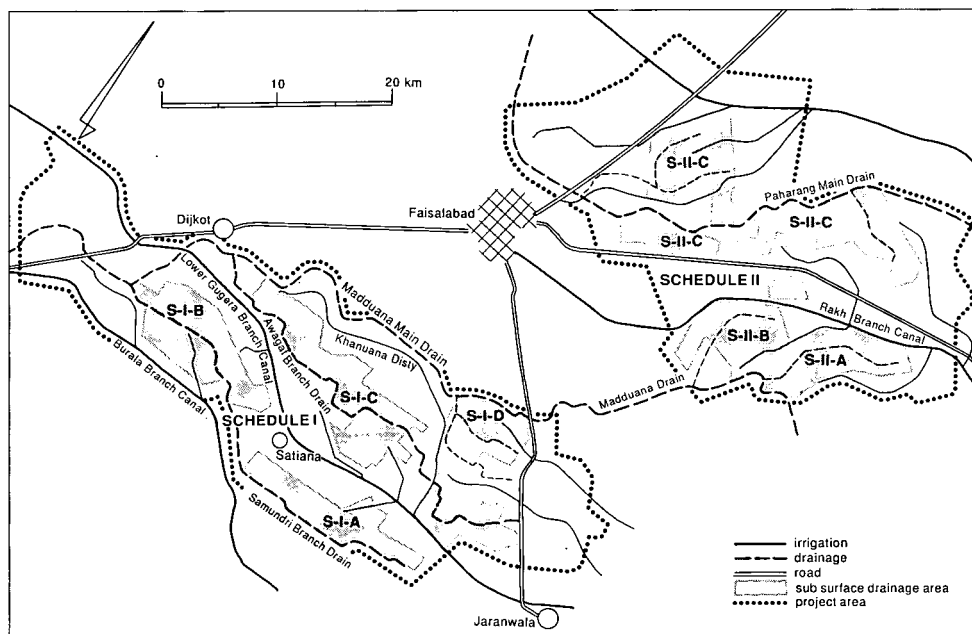

Figure 18.3 Project area and subsurface drainage area of Drainage IV Project

18.2.4 Institutional and Economic Aspects

So far, attention has only been focused on the technical aspects of a reconnaissance study. Some remarks on the institutional and economic aspects are therefore fully warranted.

The initiative for a reconnaissance study is usually taken by the national government. Although the study is often part of an overall national water-resources-development plan, its implementation mainly depends on the available construction capacity and the financial resources. Lack of resources for major engineering works such as a major outfall drain to the sea can considerably delay drainage construction. This has happened, for instance, in the Lower Indus Plain and the Lower Mesopotamian Plain.

Reconnaissance studies are generally implemented by a public authority (e.g. the U.S. Bureau of Reclamation), an international agency (e.g. FAO), or by an international company working under contract to a public authority (e.g. the Egyptian Public Authority for Drainage Projects/EPADP in Egypt, and the Water and Power Development Authority/WAPDA in Pakistan).

These Authorities are also responsible for securing the funds for project execution, funds that are often provided by international banking consortia or donor countries.

At reconnaissance level, the project should be economically viable, which means that it should meet a pre-set minimum rate of economic return.

18.3 The Feasibility Study

The objective of a feasibility (or semi-detailed) study is to demonstrate that the project is technically and environmentally sound, as well as being economically, financially, and administratively workable (FAO 1983). In land drainage, nearly all problems – however difficult they may be – can be solved. The question is: ‘At what cost?’ A feasibility study should indicate the best of the alternative solutions under the existing technical and other constraints.

Funds for project implementation will have to be secured, and can only be obtained if a proper account is given of the project’s costs and benefits. Evaluating the direct profitability of the project and preparing a cost-benefit analysis are not the tasks of a drainage engineer. He or she, however, should provide the economist with the information that is needed to prepare an economic and financial appraisal of the project.

The drainage engineer, in cooperation with the agronomist and the irrigation engineer, has to estimate the expected increases in crop yields and in the gross agricultural outputs that the project will bring about. He or she must also calculate the costs of the drainage works, including both the capital cost of construction and the costs of operation and maintenance.

In general, the costs of the major engineering works should be estimated to an accuracy of some 10% (FAO 1983; Bergmann and Boussard 1976). Hence, the main drainage system should be designed to a sufficient degree of detail; there may be no scope for radical changes at a later design stage, or during the tendering and construction phases.

A map should be prepared showing the layout of the main drains and the location of structures in the main drains and at the outlets. Cross-sections and longitudinal profiles of the main drains and drawings of the structures are needed. A detailed account of the design criteria should be presented, and pumped drainage, if needed, should be carefully justified.

On-farm drainage systems (field drainage) can generally be designed on a model basis. Typical designs of field-drainage systems should be made for sample areas of some tens to a hundred hectares, which are representative of the soils, relief, and principal farm types. Attention should be given to drainage machinery and drainage materials, particularly when the on-farm drainage is to be a subsurface system. The equipment and materials needed will often have to be imported, and this requires foreign currency.

How the project is to be executed and how it is to be operated once it has been implemented is of great importance. Administrative arrangements should therefore be carefully documented.

18.3.1 Topography

A plan of the drainage network is an essential part of the feasibility study. This plan should be presented on a map at a scale of 1:10 000. Generally, contour lines at an interval of 0.5 m will suffice, except on very flat land, when 0.25 m contour intervals should be used.

Of the various sample areas maps at a scale of 1:5000 are needed for the design of the field-drainage systems. For areas where important structures are to be built and for the areas around the drainage outlets, maps at a scale of 1:5000 to 1:2500 and with contour intervals of 0.25 m or less are needed.

Surface-drainage problems occurring in flat land can usually only be solved by land grading. This requires information on the micro-relief (see Chapter 20).

18.3.2 Drainage Criteria

For the proper dimensioning of the field and main drains, and of the pumping station, if any, the discharge criteria of the project area must be assessed.

The main question to be answered is: 'What quantities of excess water drained from the fields will the main drainage system have to cope with per unit of time in different parts of the year?'

As a drainage system is designed primarily to control water levels, the drainage criteria should preferably be based on a description of the desired water-level regime. Agricultural requirements (e.g. the crops to be cultivated, soil tillage, and soil salinization) determine the desired regime. (The principles of assessing the agricultural drainage criteria were discussed in Chapter 17.)

In areas with high rainfall intensities, surface runoff can be appreciable, particularly on soils with a low infiltration rate, such as clay soils, soils with a slowly pervious layer at shallow depth (Planosols), and soils prone to surface sealing. The gradient is another important factor: on very flat land, excess rainwater will stagnate on the

soil surface, whereas on sloping land, excess water will rapidly flow towards the lowest spots.

Where there is a high infiltration rate or a low rainfall intensity, most of the rainwater, if not all of it, will infiltrate into the soil. When this exceeds the evapotranspiration, the watertable may rise. The height to which the groundwater is allowed to rise depends on the type of crops that will be grown, on the capillary properties of the soil, and on the quality of the groundwater.

If external water – whether it be excess rain, irrigation water, or net groundwater inflow – should cause the watertable to rise to a level detrimental to crop growth, it must be drained off by field drains and collectors that discharge into a main drainage system. The same is true for flat land, where water stagnates on the soil surface. During the growing season, most crops will be seriously affected if water remains on the soil surface for more than a few days.

A careful study of the runoff of streams that drain into the area should be made on the basis of precipitation data and discharge measurements in the stream channels. A decision needs to be made on whether this surface water will pass through the project area or will be diverted around the area. The disposal of waste water or sewage water also needs to be taken into account. (Chapters 19 and 23 will discuss engineering aspects such as permissible flow velocities in canals, cross-sections of canals, embankment protection, structures, and pumps.)

To dimension the main drainage system and to compute the spacing between field drains, not only is an assessment of the drainage criteria required, but also details from the basic data obtained during the reconnaissance study. There will usually be some field work still to be done, although the amount and coverage of the drainage investigations depend much on the knowledge and experience of the drainage engineer. What is now required is a clear picture of:

- The rainfall intensity and frequency of occurrence;
- The deep percolation losses from irrigation and precipitation;
- The amount of surface runoff from precipitation, and surface waste from irrigation;
- River discharge, including the peak discharge, the frequency of its occurrence, and the risk of inundation;
- The soil texture and soil salinity, preferably to a depth of 4.0 to 5.0 m, and whether slowly pervious layers occur within that depth;
- The hydraulic conductivity of the soil profile, especially that of the layer at a depth of 1.5 to 2.5 m;
- The occurrence and depth of an ‘impervious’ base layer;
- The depth to the watertable, the watertable fluctuation, and the chemical composition of the groundwater;
- The piezometric head of the groundwater at different depth intervals, (e.g. at 3, 5 and 10 m), or at any other depth depending on the subsurface geological conditions, as a basis for estimating the upward or downward flow of groundwater, the inflow into and outflow from the project area, and the natural drainage.

The techniques and methods to be applied in collecting all this information have been discussed in previous chapters. Some pertinent questions, however, remain to be answered. These are:

- How many observations should be made?

- How important is the contour map of the impervious base layer and the contour map of the aquifer?
- How should drainage sub-areas (or sample areas) be delineated, each of which is characterized by a single drain spacing?
- How should rainfall data be handled and evaluated?

18.3.3 The Observation Network and the Mapping Procedure

The required density of observations on soil, subsoil, shallow substratum, and groundwater conditions depends mainly on the geomorphology of the area and the corresponding homogeneity or heterogeneity to be expected. Hence, to attain the same level of accuracy, fewer observations are needed in areas of homogeneous soils, subsoils, and shallow substrata than in areas where these are heterogeneous. The expected spacing between field drains also has a certain bearing on the density of the observation sites, in that the wider the drain spacing, the more widely-spaced the network of observations can be. This is only important if information on the subsoil and the shallow substratum (stratification, hydraulic conductivity, and depth to the impervious layer) is available prior to the feasibility study being undertaken. Useful data may have been collected during the reconnaissance survey.

In drainage investigations, a generally accepted density of hydraulic conductivity measurements is one per 10 to 20 ha. One deep boring to a depth of 4.0 to 5.0 m per 50 ha will suffice in most cases. There are, however, differing opinions on these densities.

It used to be common practice in The Netherlands to make one hydraulic conductivity measurement per 5 to 10 ha (Van der Meer 1979). The number of borings to a depth of 2.0 to 4.0 m was only a fraction of the hydraulic conductivity measurements.

In the valley and delta of the River Nile, it was found that one observation per 4 ha was sufficient to gain a proper knowledge of the main soil characteristics.

Taking into account soil variability and expected drain spacing, FAO (1983) arrived at a range of areas to be covered by one hydraulic conductivity measurement. These varied from 40 – 75 ha in homogeneous soils and drain spacings of over 75 m, to less than 5 ha in heterogeneous soils and drain spacings of 30 m or less. For deep borings, one measurement covers about 500 ha in uniform soils where a wide drain spacing is expected, and 10 ha in stratified soils where a narrow drain spacing is expected. In the Nile Delta, one deep boring per 40 ha is considered a minimum.

Soil maps are usually available or are being prepared. Hence, a logical question that could be raised is whether a conventional soil map might be used as a basis for selecting observation sites.

Figures 18.4A and B present examples of the texture of a sample area to a depth of 1.2 m and from 1.8 to 2.2 m. Table 18.4 presents the hydraulic conductivity (the geometric average) for the various textural groupings. Because soil maps are usually based on observations to a depth of 1.2 m, the examples make clear that, for drainage investigations, it can be misleading to select observation sites from soil maps.

Hydraulic conductivity measurements – an important item in drainage

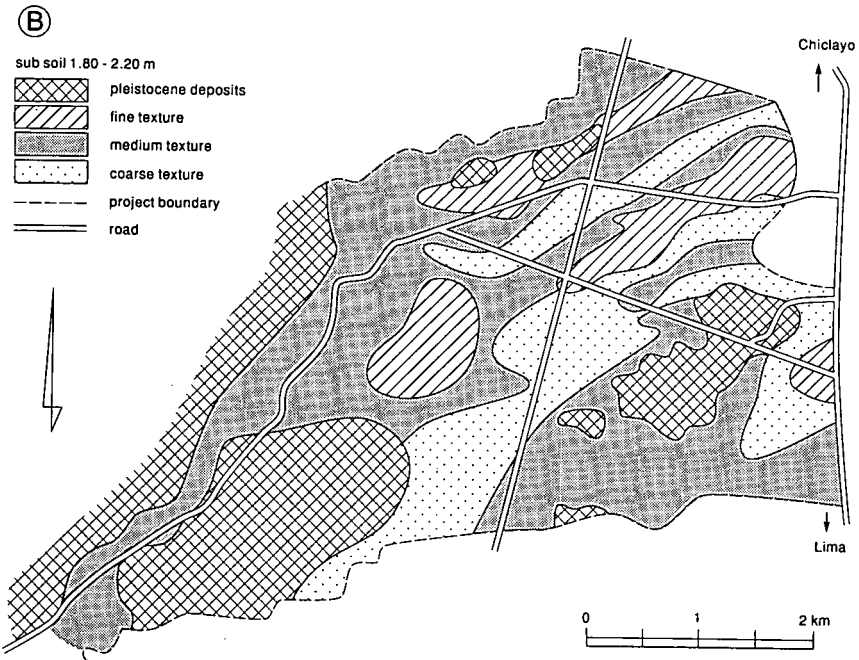
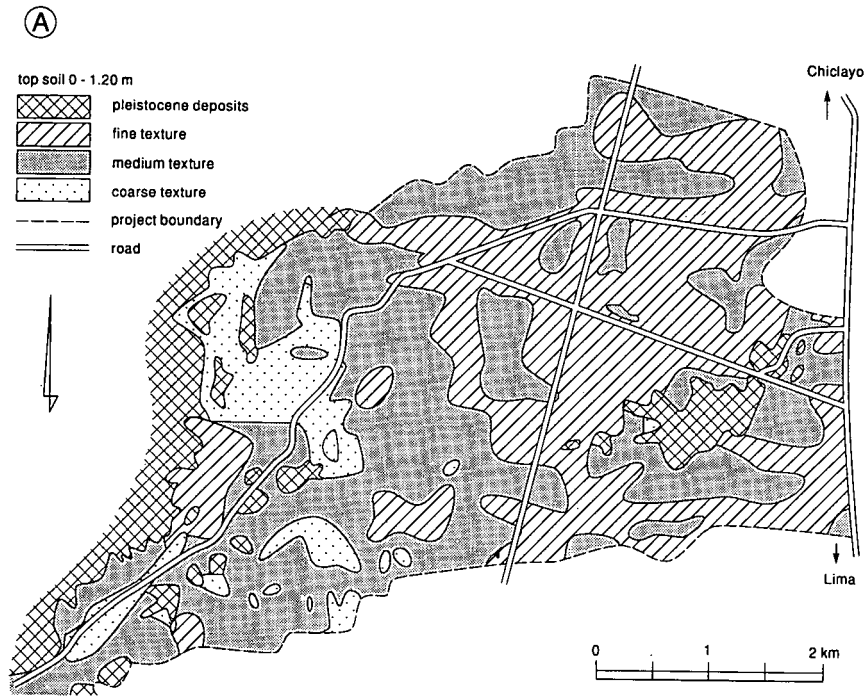

Figure 18.4 A: Soil texture from surface to a depth of 1.2 m of a sample area
 B: Soil texture from 1.80 to 2.20 m below the soil surface of a sample area

Table 18.4 Hydraulic conductivity according to soil texture of the sample area

Texture	Hydraulic conductivity (m/d)	
	Mean	Standard deviation
Fine	0.20	0.15
Medium	1.00	0.59
Coarse	4.75	2.33

investigations – are time-consuming. The number of these measurements can be reduced if a relationship can be established between the soil-profile characteristics and the drain spacing (see Chapter 12). A statistical investigation conducted by the Dutch Government Service for Land and Water Use (Van der Meer 1979) revealed such a relationship. It showed that many of the auger-hole measurements could be replaced by profile descriptions, and that if the depth of the profile observation was increased to 1.5 m, the number of auger-hole measurements could be even further reduced. It should be borne in mind that, in The Netherlands, the depth of observation can be limited to approximately 1.5 m because of the geological conditions, the relatively narrow drain spacings (often less than 30 m), and the shallow drain depth (1.0 to 1.2 m).

The idea that drainage engineers (and other specialists) could make better use of soil maps is an interesting one that merits a closer look. It is the task of the drainage engineer to define what soil and subsoil properties are of importance in land drainage. The degree of detail which it is possible to attain should be discussed with the soil surveyor.

In practice, a grid system is used to mark the sites at which the hydrological characteristics of the soil, subsoil, the shallow substratum, and the groundwater are to be observed and measured. Such a system has the advantage of being objective with respect to the unknown geological conditions below 1.2 m, while the observation sites are easily detected in the field.

Deep borings and piezometers are often sited in a rectangular grid, which may be oriented in any convenient direction. It is advisable, however, to have one axis of the grid coinciding with the general direction of groundwater flow. Under normal conditions, this will be perpendicular to the land surface contour lines and parallel to the main direction of sedimentation.

In planning the layout of a grid or the traverses, one should make use of all available information on geology, physiography, and soils, and of any aerial photo mosaics.

The location of the augerhole traverses or gridlines should be perpendicular to the land surface contours, to a river, and to the boundaries of soil mapping units, and parallel to the main direction of sedimentation. (See also Chapter 2, Figure 2.15.)

In cases where a provisional layout of the collector system can be made first, the observations can be taken in lines parallel to the collector.

The required density of the network depends on:

- The intensity of the survey and the corresponding mapping scales;
- The geomorphology of the area and the corresponding homogeneity or heterogeneity to be expected.

The distance between two consecutive gridlines should be two or more times the distance between the observations along each gridline. The minimum mapping distance between two observation sites on a given gridline is 1 cm, and that between two gridlines is 2 cm. These distances result in one observation per 8 ha at a mapping scale of 1:20 000, and one observation per 50 ha at a mapping scale of 1:50 000.

Wider spacings can be used if the available geological, physiographic, and soil data suggest relatively homogeneous conditions. Nor will it be necessary to install a piezometer at each nodal point of the grid or in each auger hole of a traverse. On the other hand, some additional piezometers may be necessary where grid lines cross

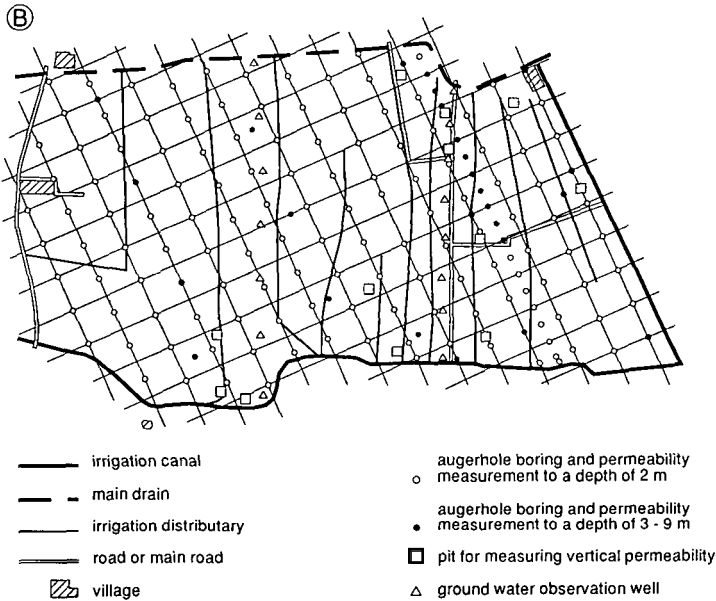
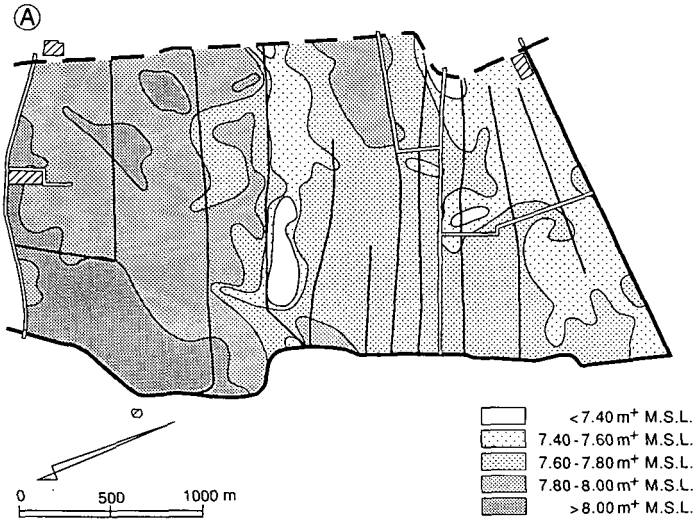

open water courses, so as to determine the precise shape of the watertable near such channels. If the soil and subsurface geological conditions are found to vary considerably between two nodal points of the grid, some additional auger holes will be needed to determine the location of transition zones.

All the information on soils, soil characteristics, and groundwater collected at the nodal points of the grid should be processed and transferred to working maps at a scale of 1:2500 or 1:10 000, depending on the size of the area and the accuracy required.

©

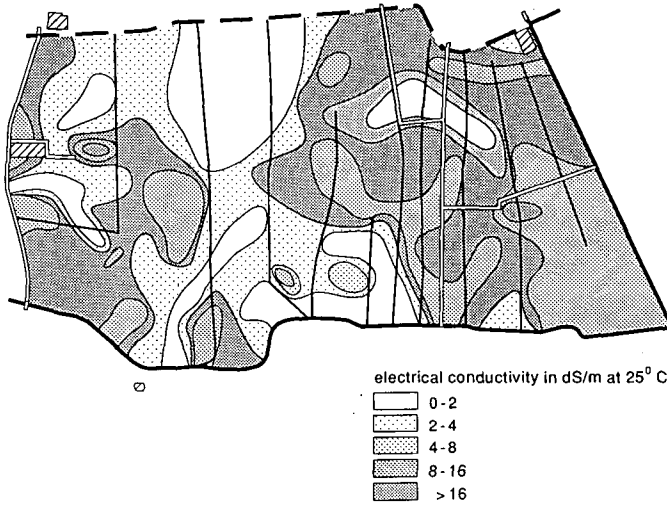

©

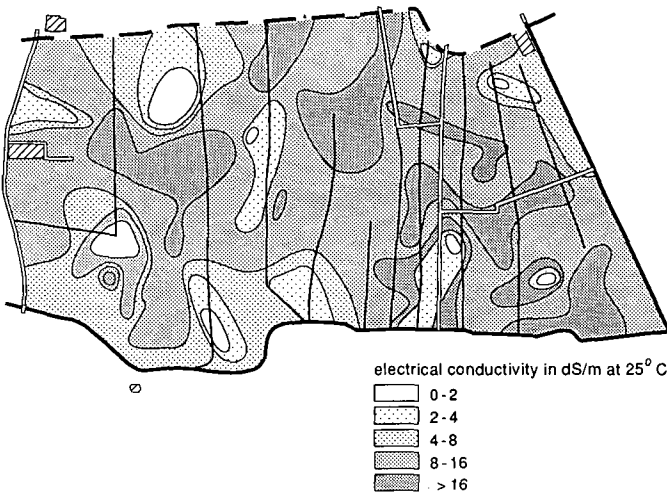

Figure 18.5 (A to F) gives examples of the different types of maps to be prepared. Since they are self-explanatory, they will not be discussed further.

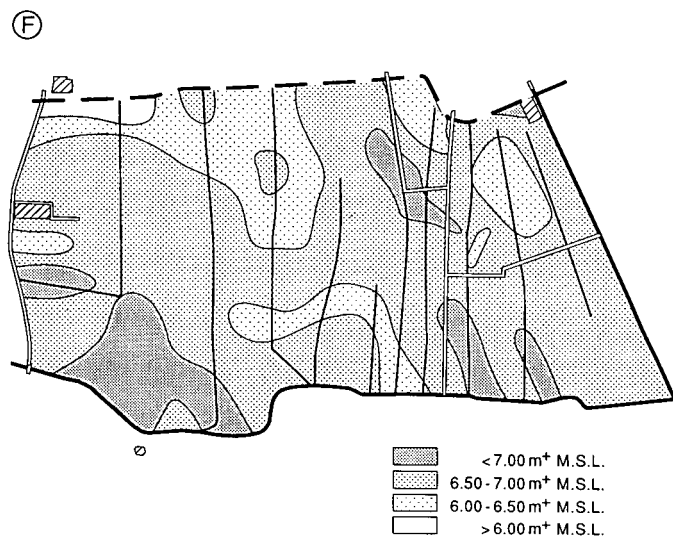
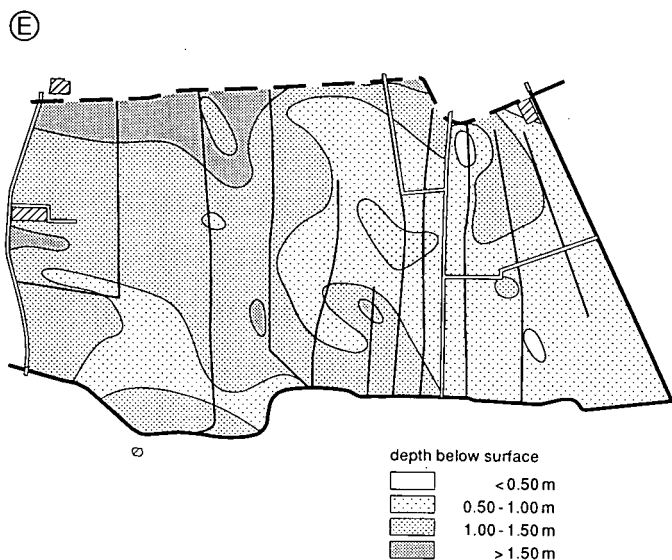

Figure 18.5 Examples of maps usually prepared in a detailed survey (FAO 1966):

- A: Contour map of the land surface
- B: Grid system and observation network
- C: Salinity of the surface soil (0-0.5 m)
- D: Salinity of the groundwater
- E: Relative depth of the groundwater
- F: Absolute depth of the groundwater

18.3.4 The Hydraulic Conductivity Map

Figure 18.6 presents a map of the hydraulic conductivity of the soil below the watertable.

The hydraulic-conductivity measurements were taken at the nodal points of the grid system and, provided that the impervious base layer lies some metres below the watertable, these may be taken at regular depth intervals of, say, 1 m. The maximum depth of a hand auger hole being approximately 5.0 m, three or four measurements can usually be made in one hole. The shallow measurements can be taken by the auger hole method, but the deeper ones call for the use of the piezometer method. It is often difficult, and sometimes impossible, to take measurements in the lower horizons.

In these circumstances, and also when the impervious base layer lies deeper than 5 m, one has to estimate the hydraulic conductivity of the lower horizon from the lithology as described in the logs of hand borings or from those of mechanically-made deep borings. In situations where the aquifer is thick, a limited number of pumping tests will have to be performed to find the value of the hydraulic conductivity. The test wells need not be deeper than about 1/4 to 1/6 of the estimated drain spacing because this depth of the transmission zone plays the major role in the flow of groundwater towards the drains.

The measurements at successive depths have to be processed. If all the successive K-values have the same order of magnitude, a homogeneous soil profile can be assumed. The average K-value then equals the sum of the thicknesses of the various layers, multiplied by their respective hydraulic conductivities and divided by the total thickness of all layers. All nodal point K-values are then plotted on the map and lines of equal hydraulic conductivity are drawn.

More often than not, a soil profile is made up of alternating layers of varying texture and thickness. In such a situation, the above procedure for homogeneous soils is also applied.

It may happen, however, that a distinctly two-layered profile occurs (e.g. loam on

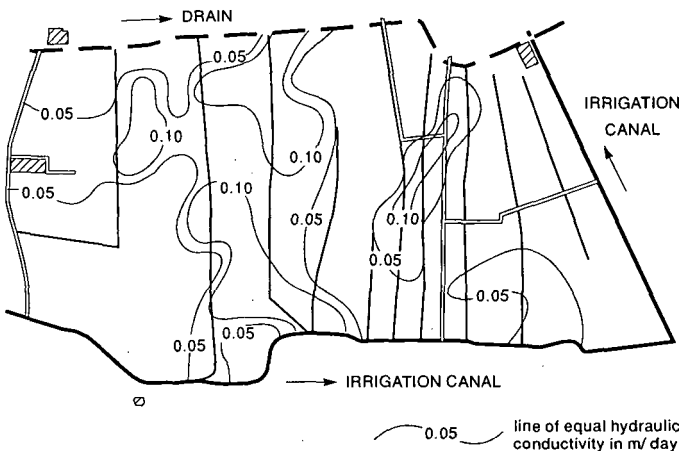

Figure 18.6 Contour map of the hydraulic conductivity below the watertable

sand, clay on fine sand, fine clayey sand on coarse clay-free sand). If so, two K-values have to be plotted on the map, one for the top layer and the other for the sub-layer. The procedure to be followed is then somewhat different from the above, because first the boundary between the two layers has to be detected. It is common practice to work with two bore holes of different depths, taking care that the bottom of the shallow hole is at least 10 to 15 cm above the lower layer (Van Beers 1983).

18.3.5 The Contour Map of the Impervious Base Layer

The occurrence and depth of the impervious base layer is of major importance in any study of subsurface drainage because it has a great bearing on the spacing of the field drains. The deeper this impervious layer, the greater the thickness of the overlying water-transmitting layer, and consequently the wider the drain spacing can be. This will now be demonstrated.

Assume a homogeneous soil with a hydraulic conductivity $K = 0.5$ m/d. The impervious base layer is found at two different depths: 3 and 5 m below the soil surface.

From Hooghoudt's equation (see Chapter 8, Section 8.2.2), we find that the drain spacings are respectively 58 and 73 m for a discharge $q = 2$ mm/d, pipe drains with a wetted perimeter $u = 0.3$ m, an average watertable at 1.0 m, and an available head $h = 0.8$ m. This difference in drain spacing clearly indicates the effect of the depth of the impervious base layer.

If no impervious base layer is found within 5.0 m of the surface, deeper observations may be required. Hence, if, in the above example, the impervious base layer were to be located at great (infinite) depth, the drain spacing would be 112 m. It thus makes sense to do some deep augerings beyond a depth of 5.0 m below the surface.

Recommended depths of observations are 1/8 to 1/20 of the expected drain spacing in homogeneous and stratified soils respectively (FAO 1983). The crucial question is: 'What drain spacing can be expected?' This question can only be answered through trial and error. An example may illustrate this.

In the above-mentioned homogeneous soil, with an impervious base layer at a depth of 10 m, a drain spacing of 92 m is required. If deep augerings to this depth did not reveal any sign of the impervious base layer, borings to an even greater depth could be considered. Deep borings, however, are time consuming and costly. The available data indicate that the drain spacing will be somewhere between 92 and 112 m. Other factors (e.g. plot size) will dictate what drain spacing to apply in practice.

If, in the above-mentioned homogeneous soil, a hydraulic conductivity $K = 2.0$ m/d was found, the drain spacing would be 212 m where the pervious base layer lies at a depth of 10 m, and 358 m where it lies at an infinite depth. The relatively large increment in drain spacing with increasing depth of the impervious base layer warrants borings beyond a depth of 10 m.

18.3.6 Field-Drainage System in Sub-Areas

As a result of the generally large spatial variation in the hydrological characteristics of the soil, subsoil, and substratum, one single spacing between field drains is seldom

applicable to the entire project area. To cope with these large variations in the hydrological characteristics of the flow medium, the drain spacing, L , is usually calculated for each nodal point where the K - and D -values have been determined. Because L varies with the square root of K and D , the L -value will vary less than the K - and D values do separately.

The values of L thus obtained are plotted on a map on which the collector drainage system has already been delineated. The next step is to divide the whole area into a number of drainage sub-areas, each of them characterized by a single drain spacing. These sub-areas are defined as areas whose drain spacings may differ but which have roughly the same order of magnitude. The uniform drain spacing of a sub-area is found simply by calculating the arithmetic mean of the various drain spacings inside the sub-area (Figure 18.7). The drainage sub-areas should, in principle, coincide with the collector block boundaries, but if two or more collector units have equal drain spacings they may be combined to form one unit.

It is obvious that within a drainage sub-area we may, at certain locations, find a calculated drain spacing that deviates substantially from the mean spacing. Such an extreme value is usually disregarded and the sub-area's mean spacing is maintained. Only when, in a certain part of the sub-area, several drain-spacing values deviate greatly from the mean, can a narrower or wider drain spacing be adopted in that particular part, as is required.

18.3.7 Climatological and Other Hydrological Data

Drainage standards and recommended practices should be based on carefully collected and evaluated climatological and hydrological data. There are many different kinds

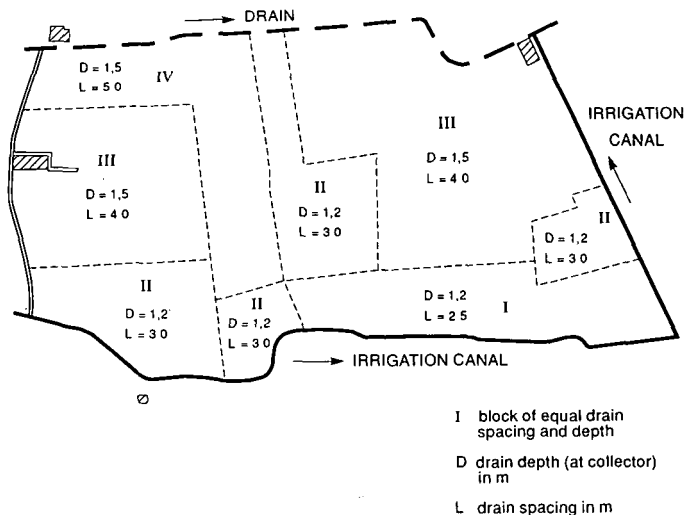

Figure 18.7 Distinction of drainage sub-areas, each of them characterized by the same drain spacing and drain depth (FAO 1966)

of climatological and other hydrological data, the most important ones for drainage surveys being precipitation, runoff, evaporation, river flow and quality, and groundwater flow and quality. Much of this information can be obtained from existing networks.

Precipitation

Rainfall is the most significant climatic feature influencing the design of a drainage system. The availability of reliable records over a sufficient number of years is therefore of primary importance, particularly in humid regions.

The minimum density of precipitation networks is as follows (WMO 1981):

- Flat regions of temperate, Mediterranean, and tropical zones need one station for 600 – 900 km², decreasing to 900 – 3000 km² for difficult conditions;
- Mountainous regions in temperate, Mediterranean, and tropical zones need one station for 100 – 250 km², decreasing to 250 – 1000 km² for difficult conditions;
- Arid zones need one station for 1500 – 10 000 km².

The number of rainfall stations determines the accuracy of measurement, whereby the larger the area under consideration, the lower the network density required to determine the area's average rainfall. This is clearly shown in Figure 18.8, which gives the relationship between the rain-gauge network density, the drainage area for the relatively flat Muskingum Basin, U.S.A., and the percentage standard error of estimates.

In some countries, rainfall figures are often the only available data. Precipitation depths can be converted to stream flows, from which hydrographs can be readily derived. There are also methods of extrapolating rainfall to extreme values in order to estimate the effect of floods.

Mean Rainfall Over a Basin

Rainfall records from a network can be analyzed with one of the following methods:

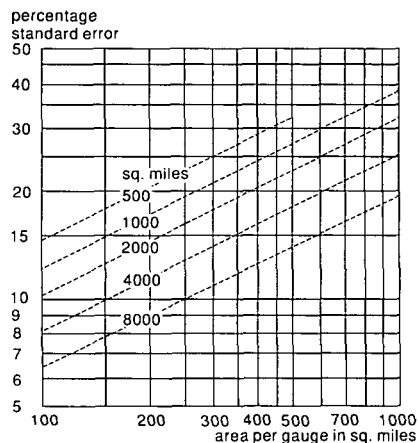

Figure 18.8 Rain-gauge network and percentage standard error for different drainage areas (Wiesner 1970)

the arithmetic mean method, the Thiessen mean method, and the isohyetal or isopluvial method. These were discussed in Chapter 4, Section 4.2.1.

Depth-Duration-Frequency Relationships to Determine a Drainage Design Discharge

When rainfall records over a sufficient number of years exist, it is possible to make a rainfall-frequency analysis, analyzing rainfall for both frequency and duration. These relationships can be assumed representative of the area surrounding the recording station. Thirty to forty years of rainfall records are usually required to give a stable frequency distribution.

When rainfall records over a sufficient number of years do not exist, recourse can be made to generalized methods of estimating the relationships between depth, duration, and frequency. These include empirical formulas relating depth, duration and frequency, and maps with isopluvials, from which the rainfall depth for any particular location and a certain combination of duration and frequency can be read.

In the design of the drainage capacity, the frequency of the total rainfall over short periods of one to ten days is important. From the available daily totals for certain critical periods, rainfall frequency curves can be derived. From these curves, the maximum total rainfall for a certain period (n days) and its frequency can be read.

(For the application of depth-duration-frequency relationships in determining a drainage design discharge, see Chapter 6.)

Runoff

Runoff is that part of the precipitation which flows to stream channels, to lakes, or directly to the sea. There are a number of methods of predicting runoff, distinguishing between direct runoff and groundwater runoff (see Chapter 4).

To establish relationships between rainfall and runoff, long-term records are required: 10-year records are of some value; 25-year records are generally reliable; 50-year records are the optimum. Duration-frequency maps can be prepared for intense storms of 12, 24, and 48 hours, and for expected recurrences of once every 1, 2, 3, 4, 5, and 10 years.

Regular rainstorm and flood observation networks generally give an incomplete picture of storm rainfall distribution. It is therefore important to collect factual information in a storm and flood area just after a severe occurrence.

Evaporation

Evaporation can be estimated directly by extrapolation from pan measurements, and indirectly through water-budget and energy-budget methods, or through an aerodynamic approach.

The need for evaporation data increases with the degree of aridity. The minimum density of evaporation networks is as follows (WMO 1981):

- Arid regions need one station for 30 000 km²;
- Humid temperate regions need one station for 50 000 km²;
- Cold regions need one station for 100 000 km².

It is recommended that standard pans (e.g. the U.S. Weather Bureau Class A pan) be used in the network, and that the data be converted to free water evaporation. Since short periods of evaporation measurement of the order of one day or less are

not very reliable, monthly evaporation data are generally used in drainage studies. Computations of evaporation from climatological observations can strengthen the estimates from pan data. (For more information, see Chapter 5.)

River Flow and Its Quality

River flow is an important factor in the magnitude and frequency of flooding. A river-gauging network can provide an insight into the availability of surface water resources.

The minimum density of river-gauging networks is as follows (WMO 1981):

- Flat regions in temperate, Mediterranean, and tropical zones need one station for 1000 – 2500 km², decreasing to 3000 – 10 000 km² for difficult conditions;
- Mountainous regions in temperate, Mediterranean, and tropical zones need one station for 300 – 1000 km², decreasing to 1000 – 5000 km² for difficult conditions;
- Arid zones need one station for 5000 – 20 000 km², depending on feasibility.

At each gauging station, a continuous record of mean discharge for each day, month, and year is tabulated, which may be computed from a record of stages and the stage-discharge relationship.

In cases where the chemical quality of the water, and especially its salt content, is an important factor in a drainage project, records of water quality should be obtained at a minimum of 25% of the stations in arid regions and at 5% of the stations in humid temperate and tropical regions (WMO 1981).

Groundwater Flow and Its Quality

For drainage projects, the main aim of a groundwater network is to determine the direction of groundwater flow, the depth to the watertable, and the mineralization of the groundwater.

The density of the network depends on the size and hydrogeological complexity of the area, and varies from one observation point per km² for areas with a shallow watertable (which may lead to secondary salinization of soils), to one observation point per 4 to 20 km² for areas with a deep watertable. For small project areas, the network should be more closely spaced, with the observation wells placed some 500 m apart (WMO 1981).

18.3.8 Institutional and Economic Aspects

As previously stated, the aim of a feasibility study is to determine the technical feasibility of a proposed drainage project, the economic benefit, and the financial return to the farmers. It should also deal with the financial implications for the authority operating the project and the way the investments made in the project should be repaid.

The initiative for a feasibility study is usually taken by the national government. The project is then implemented either by a public authority with its own staff, such as WAPDA in Pakistan, or in association with an international consulting firm.

Throughout the project, data on soil, watertable depth, and the salinity status of the soil and the groundwater are being collected by the authority and properly

archived. In Egypt, for example, this is being done by the Field Investigation and Design Directorate of EPADP.

In the feasibility study, the major drainage works are designed to that degree of detail needed to allow the quantity of engineering work to be estimated to an accuracy of some 10%. It should be in sufficient detail to allow cost estimates to be made.

All project activities should be described in detail, starting with the field investigations, and progressing, via design and tendering, to construction and project implementation.

A further important aspect to be dealt with is how the project should be executed and operated, and what organization will handle this task.

18.4 The Post-Authorization Study

After the feasibility study has been completed and the most appropriate drainage system has been selected, a post-authorization (or design) study should be made. This study should start with the preparation of a basic map, making use of existing topographic maps with relevant field characteristics and boundaries. If necessary, the maps can be checked and updated from recent aerial photographs. Next, the working map should be checked in the field, especially the widths of roads, open drains, canals, and bridges, and perhaps the exact location of trees and buildings. For the basic map, a scale of 1:10 000 or 1:5000 is recommended.

The definitive project design is made on this basic map. It may happen that, apart from the data collected in previous surveys, additional data will be required before the construction design and detailed cost estimates can be made. If, for example, there is any doubt about the applicable drain spacing, additional measurements of the hydraulic conductivity should be made.

The post-authorization study encompasses the following components:

- The preparation, on the topographic map, of the alignment of the main drains, collectors, laterals, interceptor drains, relief drains, and pipelines. The spacing of the collectors is often determined by the standard length of the laterals. The collector alignments are further fixed by the field boundaries. The length of a collector is restricted either by a field boundary or by the available slope. The available slope is fixed by the shallowest permissible drain depth, the maximum water level in the main drain, and the slope of the land surface. It is customary to draw up various alternatives for the collector layout, from which the best solution is selected. Next, the collector alignments, and more specifically the levels, are checked in the field. The use of sub-collectors involves a greater collector length, a more complicated system, and higher costs. The advantages of using sub-collectors, however, are that the laterals can be designed parallel to the minor infrastructure, thereby avoiding an excessive number of crossings. The length of the laterals is determined either by fixed boundaries or by a fixed length, whereas the lateral spacing and depth are indicated on the maps.

It is often decided to place the laterals perpendicular to the collectors. If so, it may happen that the laterals do not run parallel to the minor infrastructure. In such a case, it is advised to install the laterals at such an angle with the collector that the number of crossings with the minor infrastructure is minimized (Other aspects of layout will be discussed in Chapter 21);

- Surveying and plotting the length profiles and cross-sections needed for the design and for estimating quantities. The cross-sections of the main drains are drawn at a scale of about 1:200, whereas the longitudinal sections are drawn at scales of about 1:10 000 for the horizontal profile and 1:100 for the vertical profile;
- Investigating the geological features and the groundwater characteristics and any necessary testing to determine the channel stability;
- Determining all other structures and appurtenant facilities to complete the design (e.g. bridges, culverts, inlet structures to open or close drains, floodgates, pumping facilities, dikes). The necessary information for the hydraulic foundation and structural design of each facility should be collected;
- Drafting the construction specifications for the various work items;
- Estimating the needs and costs of additional necessary improvements (e.g. land grading, land smoothing, extra field drains, and other drainage structures not yet incorporated in the project design);
- Estimating the quantities and costs of all project features.

The post-authorization or detailed design study is generally done by a special department of the authority responsible for the execution of drainage projects. In Egypt, for example, the Field Investigation and Design Directorate under the Research and Design Department of EPADP is responsible for all pre-drainage investigations and the design of field drainage works. In Pakistan, specially-created project directorates within WAPDA are responsible for these activities.

For more details on the design of subsurface drainage systems, see Chapter 21.

The design of drainage networks in Egypt, which changed from a manual system to a computer-aided one, is described in detail by Camel et al.(1991). They have shown that the complete computerization of drainage design, with digitized inputs and outputs, is technically possible in Egypt, but not yet realistic or economically feasible for daily use. Fully computerized procedures require not only very accurate input data, but also expensive digitized maps. Therefore, the Egyptian authorities have chosen an intermediate solution of computer-aided design. Its main characteristics are:

- Processing and storing field data in the computer;
- Drawing the layout of the drainage system by hand;
- Calculating the drain spacings with the computer;
- Calculating the collectors and subcollectors with the computer;
- Calculating the list of quantities with the computer.

The advantages of the computer-aided design over the manual design are, among others, the reduced costs of excavation and construction as a result of a more exact design level of the collectors and the use of smaller diameter collector pipes.

18.5 Implementation and Operation of Drainage Systems

18.5.1 Execution of Drainage Works

Drainage works are generally executed by a contractor under the supervision of the public drainage authority. A contractor is selected by tendering, usually from a list of contractors drawn up by the authority in a pre-qualification process. It is customary to award the contract to the lowest bidder.

In the execution of drainage projects, four phases can be distinguished: preparation, execution, inspection, and registration of data. This has been extensively described by RIJP/EPADP (1985) and summarized by Abdel Fatah Salman et al. (1991).

During the construction of the drainage system, the work should be inspected. This inspection should cover both the total output (quantity control) and technical factors (quality control). Both types of inspection should be done regularly during execution because this enables any faults to be corrected immediately.

In Egypt, the contractor keeps records of the progress in the schedule of drainage execution in his office. Figures are prepared on the designed schedule, the estimated schedule, and the actual schedule, on the stages of execution for the main collectors, on the progress of laying lateral and main collectors, on the production of cement pipes, and on payments made to the contractor by EPADP. This gives a good insight into the progress of drainage construction.

Also in Egypt, time-and-motion studies on the capacity and productivity of drainage machines have been conducted since 1982. These studies have revealed the worsening condition of the older machines, which can be avoided by efficient management and good maintenance, repair, and driving. In-service training has improved these factors to such an extent that the organizational losses have been reduced by 20% and the net operating time of drainage machines has been increased by 25% (Abdel Fatah Salman et al. 1991).

18.5.2 Operation and Maintenance of Drainage Systems

A subject that is often overlooked is the operation and maintenance of drainage projects after they have been implemented. The institutions charged with this task are often inadequately equipped for the job. This could either be the result of inadequate financial resources, or because of institutional, technical, and managerial weaknesses.

During the construction phase of a drainage project, an operation and maintenance unit should be established in the field, and its staff should be trained. This unit will have to undertake a considerable amount of preparatory work in formulating a plan to operate and maintain the project.

Apart from routine operation and maintenance work, major problems in maintaining open drains may include erosion, settlement, sloughing, silting, vegetation, and seepage. For the maintenance of pipe drains, the problems may be physical

blockages, organic and biological blockages, chemical or mineral sealing, and outlet restrictions.

In Egypt, a department within EPADP has been charged with this task. In Pakistan, after completion of the Project and a bridging period of 18 months, WAPDA will hand over the Project and its operation and maintenance to the Provincial Irrigation Department.

For more details about the management, operation, and maintenance of drainage systems, see ICID (1989) and Johnston and Robertson (1992).

18.5.3 Monitoring and Evaluating Performance

A government needs to make a quantitative assessment of the effectiveness of its investment in drainage. This will ensure that the best possible use is made of the funds to be spent on future drainage works. A monitoring and evaluation (M & E) program could make such an assessment and could contribute to the development of suitable planning criteria.

It is recommended that a drainage project be regularly monitored and evaluated, in terms of both its physical and its economic aspects. This will show whether the project is functioning properly. Monitoring and evaluation should usually be considered from a long-term viewpoint and should be based on parameters that are relatively easy to evaluate.

Consideration should be given to proper collection, storage, and retrieval of data. This is of the utmost importance for the subsequent physical and economic analysis of the project.

In a drainage monitoring program, the items to be considered are:

- Crop production;
- Drainage water quantity and quality;
- Groundwater quality and level;
- Soil salinity.

In Pakistan, within WAPDA, the SCARP Monitoring Organisation (SMO) has been entrusted with the monitoring and evaluation of the impact of drainage. In Egypt, within EPADP, a specially designated Monitoring and Evaluation Directorate fulfils this function. Currently, a program is being pursued with the following objectives:

- To continue the monitoring of soil and water characteristics that was initiated in the eighties, and to add to that the collection of crop-yield data;
- To evaluate the impact of drainage on crop yields;
- To develop planning criteria for the priority-ranking of areas still to be drained or to be rehabilitated.

To meet these objectives, the Directorate plans to collect data on watertable depths, soil salinity, crop yields, and to observe the presence or absence of discharge in manholes and collector outlets.

This information is expected to provide quantitative relationships between crop yields and the physically constraining factors of soil and water, and to gain an insight into how greatly drainage works can influence these factors.

References

- Abdel Fatah Salman, M.A. Sayed Ahmed, J. Penninkhof, and G.J.M. Tijs 1991. Execution of drainage works in Egypt. In: Flevovericht 320. Design and execution of drainage projects in Egypt, pp. 9-25.
- Alva C.A., J.G. van Alphen, A. de la Torre, and L. Manrique 1976. Problemas de drenaje y salinidad en la Costa Peruana. ILRI Bulletin 16, Wageningen, 116 p.
- Bergmann H., and J.M. Boussard 1976. Guide to the economic evaluation of irrigation projects. Rev. ed. OECD, Paris, 257 p.
- Bos M.G., and J. Nugteren 1990. On irrigation efficiencies. 4th ed. ILRI Publication 19, Wageningen, 140 p.
- Camel, F., W. Wedad, G. Menting, and H.J. Nijland 1991. Computer-aided design of drainage networks. In: H.J. Nijland (ed.), Design and execution of drainage projects in Egypt. Flevovericht 320, Directie Flevoland, pp. 27-37.
- FAO 1966. Pilot project for drainage of irrigated land, United Arab Republic. Report of NEDECO/ILACO, Vols. I-IV. FAO No. SF 4/5 UAR/1, Rome.
- FAO 1983. Guidelines for the preparation of irrigation and drainage projects. Rev. ed. FAO, Investment Centre, Rome. 31 p.
- International Commission on Irrigation and Drainage 1989. Planning the management, operation, and maintenance of irrigation and drainage systems. World Bank Technical Paper 99, Washington, 150 p.
- Johnston, W.R. and J.B. Robertson (eds.) 1992. Management, operation, and maintenance of irrigation and drainage systems. 2nd ed. ASCE Manuals and Reports on Engineering Practice 57, New York, 432 p.
- RIJP/EPADP 1985. How to do it manual on some aspects of tile drainage in Egypt. RIJP-Rapport 7, Lelystad.
- USBR 1971. Planning of projects for development of water resources. U.S. Bureau of Reclamation.
- Van Beers W.F.J. 1983. The auger hole method. Rev. ed. ILRI Bulletin 1, Wageningen, 32 p.
- Van der Meer W. 1979. Pre-drainage research in land consolidation areas. In: J. Wesseling (ed.), Proceedings of the International Drainage Workshop. ILRI Publication 25, Wageningen, pp. 136-149.
- Wiesner, C.J. 1970. Hydrometeorology. Chapman and Hall, London, 232 p.
- WMO 1981. Guide to hydrological practices. Vol. I. Data acquisition and processing. 4th ed. WMO 168, Geneva.

19 Drainage Canals and Related Structures

M.G. Bos¹

19.1 Introduction

The contents of this chapter follows the design process of a main drainage canal system and the related structures. Section 19.2 discusses the factors that influence the lay-out of the canal system. This discussion is rather general because each situation yields a different lay-out. Section 19.3 gives a review of the most important criteria that determine the shape and the capacity of a drainage canal. Upon availability of a lay-out, the shape and capacity of the canal system, the hydraulic dimensions can be calculated by use of Manning's equation. This is treated in Section 19.4. The next section discusses maximum permissible velocities for earthen canals as a function of soil type, capacity, etc. If the maximum permissible velocity is surpassed, the designer has two basic options: protection against scour by use of a pervious lining of the canal (Section 19.6), or the use of energy dissipators (Section 19.7). The last section deals with culverts and small bridges.

This chapter deals with operation, maintenance and construction factors only as far as they influence the design of the system.

19.2 General Aspects of Lay-Out

Systems of drainage canals and their related structures collect and carry away excess water to prevent damage to crops and to allow farm machinery to work the land. Besides these agricultural functions, a drainage canal system may have to supply water for irrigation in the dry season, act as a means of transport for shipping, etc. In this chapter, we shall concentrate on the agricultural functions of the system.

Broadly speaking, there are two kinds of drainage canal systems:

- A system to intercept, collect, and carry away water from sloping land adjacent to an agricultural area. Most of the water in this system originates from surface runoff. It will be discharged for brief periods only, causing high flow rates and sediment transport;
- A system to collect and carry away water from a relatively flat agricultural area. Here, the main source of water is precipitation on the area or irrigation. Because of surface detention and groundwater storage, water is discharged over a longer period than above. Furthermore, the flat gradient canals have little or no sediment transport capacity.

In designing a drainage canal system for an agricultural area that is partly bounded by sloping lands, the engineer can either design two canal systems, which drain the sloping and agricultural area separately, or he can design a combined system.

¹ International Institute for Land Reclamation and Improvement.

19.2.1 Sloping Lands

If a flat agricultural area is partly surrounded by sloping lands, the surface runoff from these lands should be intercepted and discharged to prevent inundation of the agricultural area. The extent to which drainage problems in the agricultural area are caused by this surface runoff should be determined by making a water balance of the area. Runoff from sloping lands causes two major problems in the downstream areas; (i) rainfall causes high discharges of short duration, (ii) the surface runoff causes erosion, and the related sediment transport down the steep gradient of the channels causes sedimentation in the flatter channel reaches.

Both problems can be eased by a combination of the following techniques:

- Planting trees and encouraging the growth of natural vegetation on steep slopes;
- Contour ploughing and terracing intermediate slopes (up to 10%). Terracing is the levelling of the slopes along the contour lines in combination with the planting of crops;
- Encouraging the growth of crops that give a soil cover during the rainy season;
- Constructing retention reservoirs in the streams to temporarily store peak runoff (see Photo 19.1).

These techniques are a form of erosion control; their application greatly eases the downstream drainage problems.

In sloping areas, the main drainage system usually will be limited to the reconstruction



Photo 19.1 A retention reservoir is used to reduce the downstream flow rate

of channel reaches (Section 19.6) and to the construction of energy dissipators (Section 19.7).

Streams originating in sloping areas can be connected to a major river, lake, or sea along two alternative routes; (i) via an interceptor canal, which channels the water around the agricultural area to a suitable outlet, or (ii) via a canalized stream through the agricultural area.

The major advantage of the interceptor canal is that peak discharges and sediments from the sloping lands do not disturb the functioning of the drainage system in the flatter agricultural area.

It is possible to limit the required discharge capacity of a channel that transports water from sloping lands to a suitable outlet if the channel discharges from one of the following two structures:

- A retention reservoir that is filled by the peak stream flow, which is then released through a bottom outlet. As a result, the discharge peak is lower, but of longer duration;
- A regulating structure that consists of a weir of limited discharge capacity in the stream and a side weir immediately upstream of it. If the stream flow exceeds a predetermined rate, it overtops the crest of the side weir. Most of the additional stream flow then discharges over the side weir into an area where inundation or overland flow causes little damage.

Which of these two lay-outs (or an intermediate lay-out) is the best solution can usually only be decided after a reconnaissance study.

19.2.2 The Agricultural Area

The agricultural areas that require drainage are usually coastal plains, river valleys, or plains where the inefficient use of irrigation water has caused waterlogging. In coastal plains, the drainage problems are exacerbated by some hydrological feature, typical of such plains, being:

- The gentle hydraulic gradient of the rivers in the coastal plain, which leads to low flow velocities and the deposition of sediments;
- The effect of tidal levels on river water levels near the sea and of saline water intrusion;
- The complicated network of river branches and ramifications, which can cause natural drains to disappear in coastal swamps giving the river or stream what is known as a 'bad outlet' (Section 19.2.3);
- The rapid changes in channel configuration that can occur after each major flood;
- The low elevation of the coastal plain with respect to the level of rivers and the sea. To prevent the inundation of the coastal plain, dykes along the rivers and the sea shore are essential.

To illustrate alternative lay-outs of the drainage canal system, let us consider an irrigated coastal plain that lies between sloping lands (hills) and the sea. The plain is intersected by parallel rivers and streams and by an irrigation canal system. Depending on factors such as: run-off from the sloping land, construction and maintenance cost of canals, quality of drainage outlets, etc., alternative lay-outs can be considered:

Combined Drainage System

Figure 19.1 shows a drainage canal lay-out that combines the drainage system of the sloping land with that in the plain. All run-off from the sloping land is intercepted and carried away by canalized streams. These streams, and the lateral drains along the river dykes, flow into a main drain that runs parallel to the sea dyke. One drainage sluice with a well-defined, stable (suitable) outlet has been planned on that drain. The other streams are dammed by the sea dyke. Concentrating all the drainage water discharge through one sluice eases sedimentation problems in the outlet channel.

Separate System for Sloping Land

If relatively high discharges come from the sloping lands, or if the plain is wide, intercepting and diverting streams into the nearest river is a sound alternative to the lay-out shown in Figure 19.2. The streams are dammed and the interceptor drains discharge all water from the sloping lands through two sluices into the rivers. As a result, the coastal plain has a separate drainage system that discharges precipitation, unused irrigation water, and groundwater inflow. Drainage has been decentralized into three independent systems: two for the sloping land and one for the coastal agricultural area.

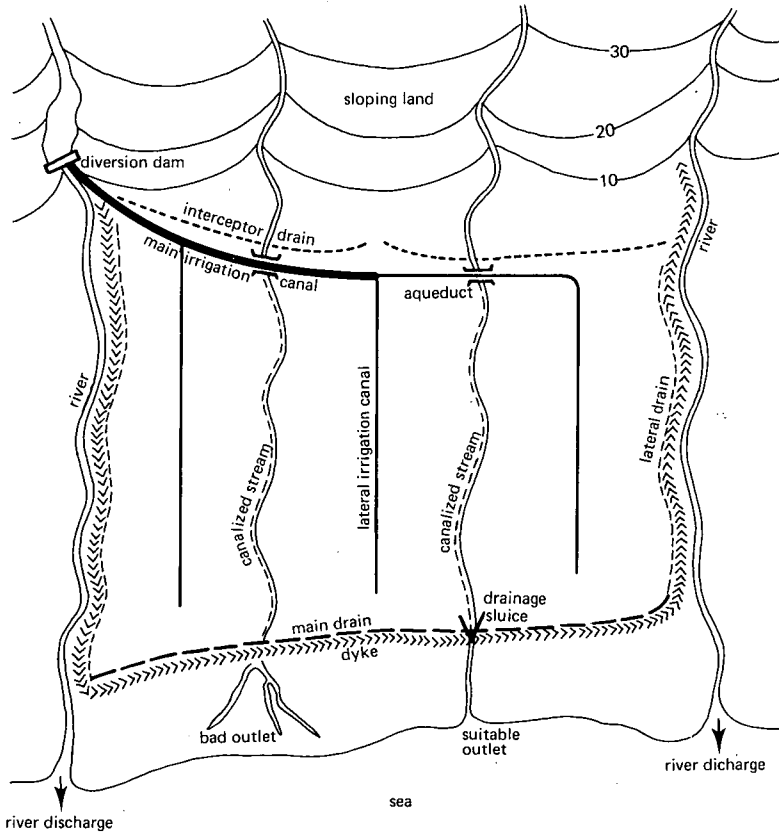

Figure 19.1 The sloping land and coastal plain are drained by one combined system (Storsbergen and Bos 1981)

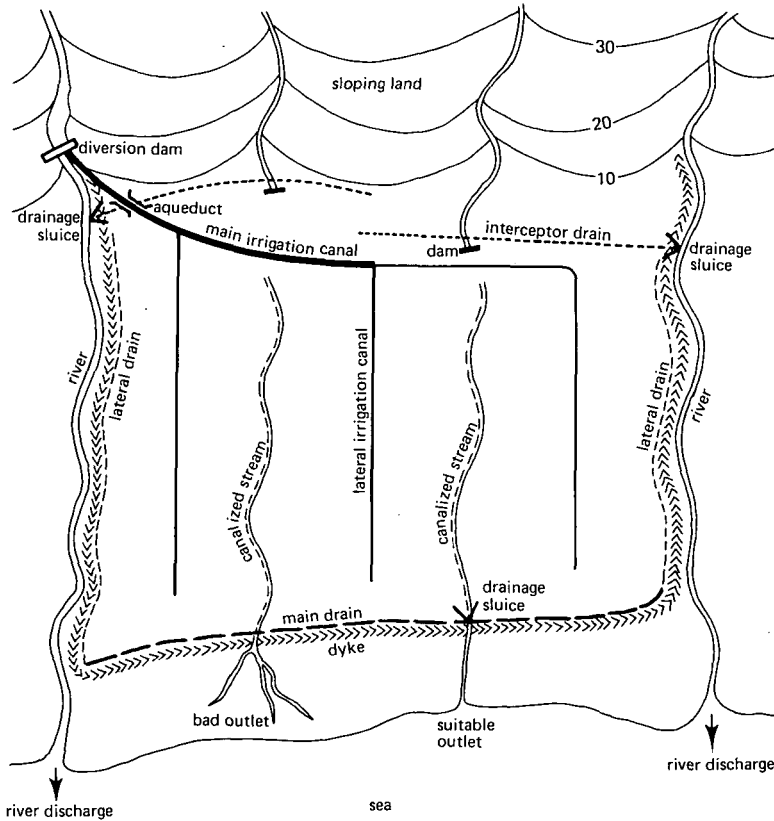

Figure 19.2 The sloping land and coastal plain are drained by three separate drainage systems (Storsbergen and Bos 1981)

Two Drainage Systems in a Coastal Plain

The transport of mud and sand along a coastline often blocks the outlets of all minor streams into the sea, and dredging may be needed to maintain a sufficient depth at the river mouths. Under such circumstances, none of the stream mouths is suitable as a drainage outlet. Water that is collected by the main drain along the coastal dyke is then discharged into the nearest river. Figure 19.3 shows four separate drainage canal sub-systems: two for the sloping lands and two for the coastal plain.

19.2.3 Drainage Outlet

The site where drainage water is to be discharged into a river, lake, or sea influences the lay-out and functioning of the drainage system. To ensure the uninterrupted discharge of water throughout the drainage season, the outlet should not be blocked by a sand bank or vegetated flats, nor should it be at the inner curve of a river, where sedimentation occurs.

At the outlet, the main drainage canal usually cuts through the natural river

embankment or the dyke. To prevent flooding of the agricultural area, the outlet is usually fitted with a sluice, which can be closed when the outside water level is high. The sluice should be near the lowest part of the area to be drained. Soil conditions in such a location, however, may cause foundation problems, and the sluice may have to be moved.

To avoid damage if there is a change of the river course or coast line, sluices are built at a certain distance from the river or sea. The entire length of the main canal reach downstream of the sluice must be protected, and some length of river embankment or coast must be protected against erosion.

To operate and maintain the gates properly, it is essential that the sluice be accessible throughout the year. The cost of constructing and maintaining an all-weather access road may influence the choice of a site for the drainage outlet.

If the hydraulic gradient over the outlet sluice is insufficient to discharge all drainage water within a selected period (3 or 5 days), a pumping station may be added to the outlet. In such a case also the cost of power supply to the pumping station influences its location.

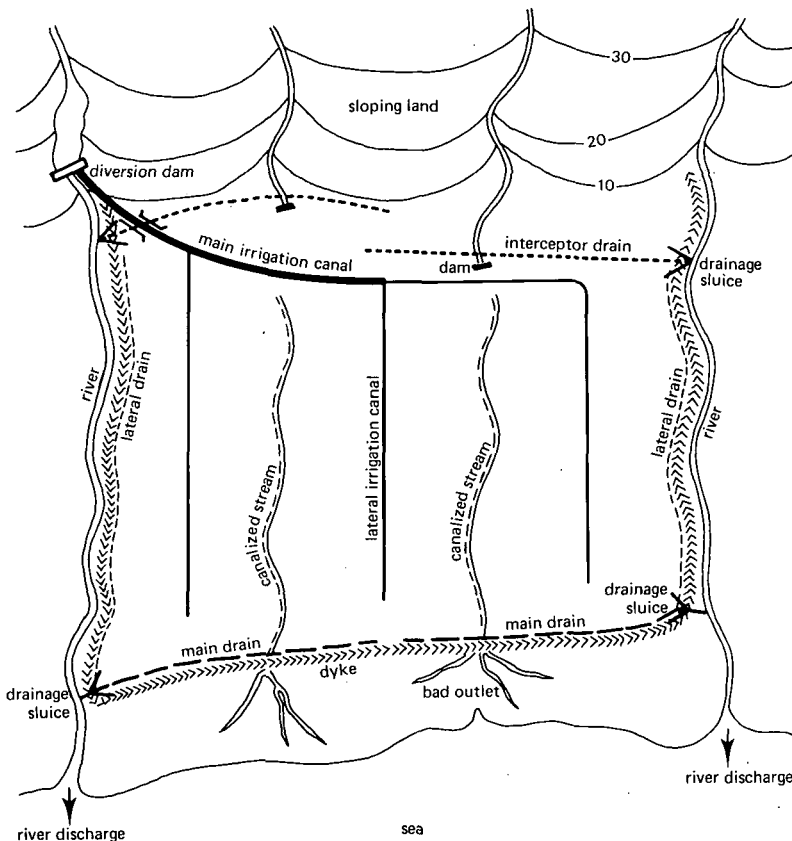

Figure 19.3 The sloping land and the coastal plain are drained by four separate systems (Storsbergen and Bos 1981)

19.2.4 Locating the Canal

To determine the location, hydraulic properties, visual characteristics, and condition of existing channels, planned canals, and related structures, one needs a 1:10 000 scale topographical map with a contour interval of 0.50 m or less, and a 1:10 000 controlled photo mosaic. Maps, especially in flat topography, should be field checked. This step should be done in the earliest planning stage to avoid the need for major revisions later. The following information is needed to plan a canal system (adapted from U.S. Dept. of Agriculture 1977):

- 1) The drainage area at junctions of existing streams and all flow control points. Drainage areas should also be delineated for the 'land level units' that will be described in Section 19.3;
- 2) The approximate profiles in existing channels, showing the elevation of the channel bottom, low bank, points of natural low ground away from but subject to drainage into the channel, and elevation and dimensions of all structures in or over the channel. The condition and serviceability of all structures should be recorded. Adequate survey data are needed for all structures to compute the discharge capacity for each;
- 3) The representative channel and valley cross sections for each hydraulic or economic reach. Additional cross sections should be taken as needed for a reliable estimate of: quantities of excavation and land clearance, damage evaluation in the plain or valley because of high water levels (see Section 19.3.2), and to permit the computation of storage in flood plains, ponds and marshes (see Section 19.3.3);
- 4) Manning's coefficient 'n' for each existing channel. Even if channel elements are very uniform, the n value should be estimated for each 1-km reach;
- 5) The location and elevation of all soil investigation sites along the proposed canals. To determine the maximum permissible velocities and bank slopes, soil investigations should extend to a depth of at least 3 m below the anticipated future canal bottom (Figure 19.4). Use the Unified Soil Classification of Section 19.3.4;
- 6) The landscape character and use patterns along major existing and anticipated drains. Data must include: scenic views, area and density of brush and trees, and isolated but valuable trees;
- 7) The location and ownership of boundary lines in the vicinity of all probable canals and structures;
- 8) The other significant features that will be affected such as roads, pipelines, power and telephone lines, buildings, wells, cemeteries, and fences.

Based on the above information, the center line of all the canal system is drawn in pencil on the photo mosaic, showing curves, intersecting angles, and so on. Mark the stationing on these center lines with a short dash at each 100-m point.

After this preliminary design phase at the office, the canal location should be field-checked. For this check, one should walk the full length of the canal's center line, noting the following on the preliminary design drawing:

- a) The probable realignment of the center line;
- b) The points of significant breaks in the grade;
- c) The location of all rock outcrops or critical soil conditions;
- d) The approximate locations of points where more cross sections could be obtained;

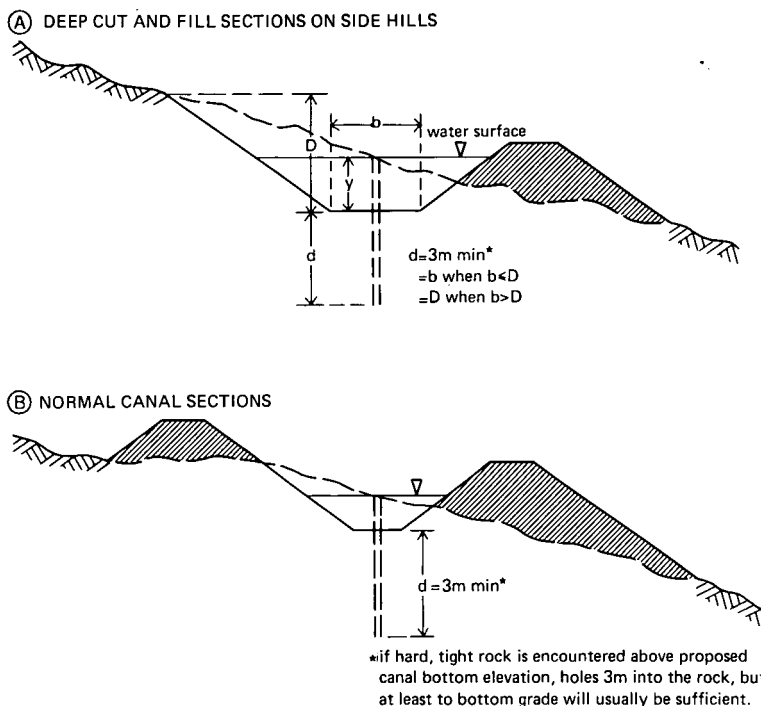

Figure 19.4 Depth of preliminary exploratory holes for canal alignment (after U.S. Bureau of Reclamation 1973)

- e) The location of significant canal junctions and places where side inlets may be needed;
- f) If not already visible on the aerial photo, note the location of all buildings, utilities and structures that may be affected by the drainage canal works. These include, but are not limited to, facilities that are within 100 m of the alignment and 1 m below the future canal bottom;
- g) The location of valuable landscapes and large individual trees adjacent to the alignment.

Following the field check, one should accurately establish the revised center line on the photo mosaic. The final alignment should be based on the previous cross sections, and geological and environmental data. Indicate on the photo mosaic where the cross sections and soil surveys were made.

19.2.5 Schematic Map of Canal Systems

Maps showing the layout of a drainage canal system must give detailed information on the location of canal reaches and related structures. Normally, this information is given on the same map that shows the irrigation canal system, roads, and the boundaries of irrigation units. To keep such maps legible, standard symbols must

be used to indicate the center line of the canals and related structures. The schematic map in Figure 19.5 uses these symbols. It shows:

- The location of the center lines of drains and irrigation canals, numbered for each reach;
- The radii of the center lines;
- The reserve boundaries of canals and boundaries of any adjacent obstructions, roads, and land level units. The area of land level units must be shown also;

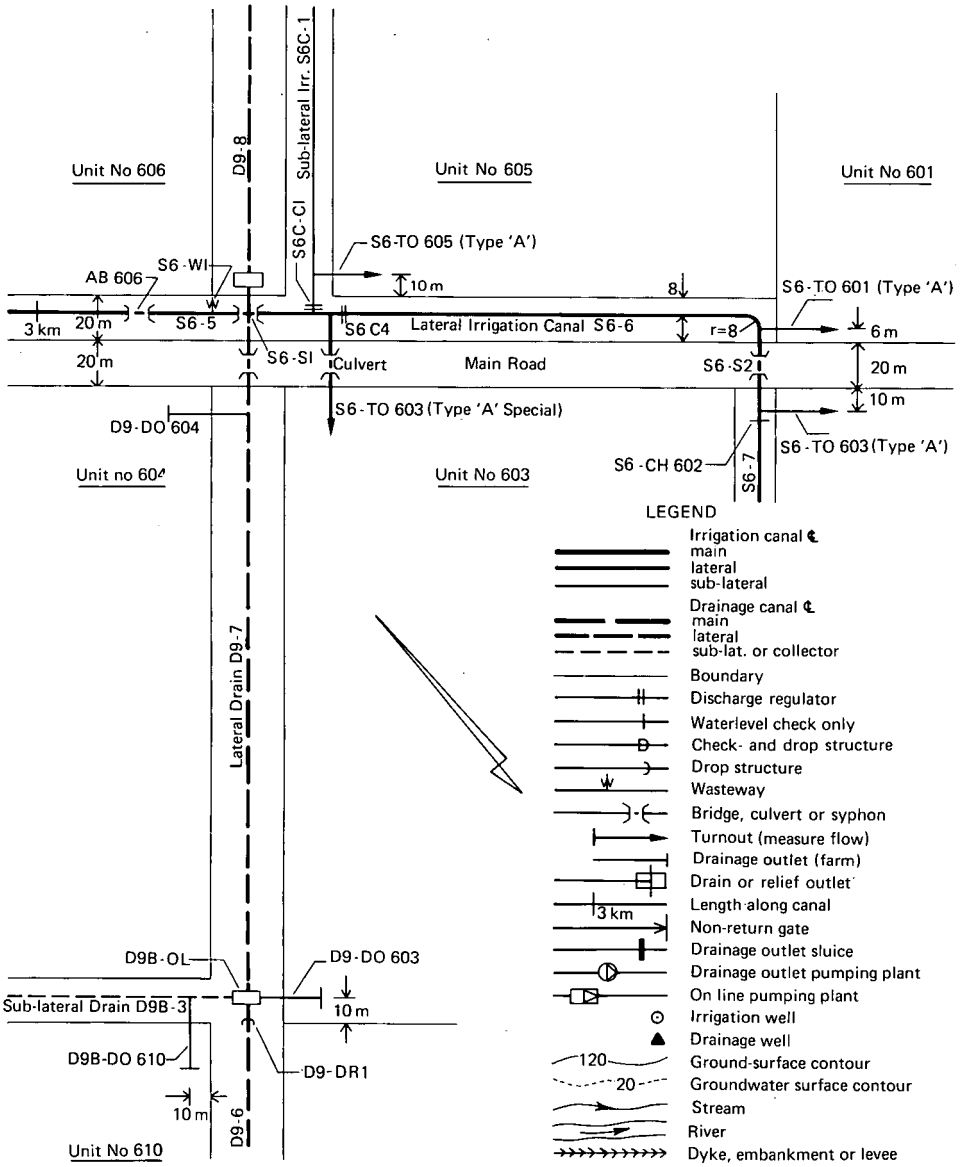

Figure 19.5 Example of a schematic map (after PWD 1967 and own data)

- The boundaries and number of irrigation units (if applicable);
- All structures, numbered and with position dimensioned with respect to center lines or boundaries;
- The north point and scale.

A schematic map must be supplemented by longitudinal profiles of all main and lateral canals. On both the map and longitudinal profile, a certain notation has been used to identify a canal reach and its related structure. After the system has been constructed, this notation must also appear on the structure.

The notation consists of two parts: (i) the number of the canal and (ii) the number of the canal reach or the structure identification number. It is presented below in Table 19.1.

Table 19.1 Notation for canals and related structures

Type of canal or structure	First part of notation (i)	Second part of notation (ii)	
Drainage canal:			
main	MD	Number only; assigned consecutively from upstream end of canal or drain	
lateral	D9		
sublateral	D9B		
Irrigation canal:			
main	MS		
lateral	S6		
sublateral	S6C		
Discharge regulator		C	Plus number; assigned consecutively from upstream end of canal or drain
Water-level check		CH	
Drop structure		DR	
Check-and-drop structure		CD	
Wasteway		W	
Bridge, culvert, or syphon		S	
On-line pumping plant		P	
Turnout (measures flow)		TO	Number of structure; identical to farm block number or number of irrigation unit served or adjacent
Drainage outlet (farm)		DO	
Irrigation well		SW	
Drainage well		DW	
Farm access bridge		AB	
Drain or relief outlet		OL	No number
Non-return gate		NG	
Drainage outlet sluice	} Proper name only		
Drainage outlet pumping station			
River diversion dam			
Storage dam			

19.3 Design Criteria

19.3.1 Design Water Levels

In designing a drainage canal, an engineer distinguishes two water levels:

- The water level at which the canal embankment is overtopped and the adjacent area is inundated. Whether this water level is exceeded depends upon the design discharge capacity of the canal reach and the related structure (Section 19.3.2);
- The water level that is needed to maintain a sufficiently low watertable during the drainage season. This water level is related to the depth of the watertable that is required to improve crop growth, allow farm machinery to work the land, limit subsidence, prevent salinity, etc. This water level is usually given as a value that, on the average, should not be exceeded during a number of days (say 10) per drainage season. It has a direct impact on the depth, f_n , of a drainage pipe or field ditch (Figure 19.6).

Hence, at 'normal discharge', the water level in the collector drain should be a distance, F_n , below the land surface about 10 days a year. This distance is often called freeboard. The freeboard equals

$$F_n = f_n + Ls/2 + 0.10 \quad (19.1)$$

where

F_n = required freeboard in a collector drain at normal discharge, Q_n , occurring about 10 days a year (m)

f_n = drain depth based on various design criteria (m)

$Ls/2$ = head loss due to the gradient, s , of the field drain over half its length, L , (m)

0.10 = a safety margin in metres that guarantees an undisturbed flow of Q_n most days of the year

To determine the related water levels in the drainage canals, one must have a good contour map of the area. The scale of this map should be 1:10 000 or larger, and

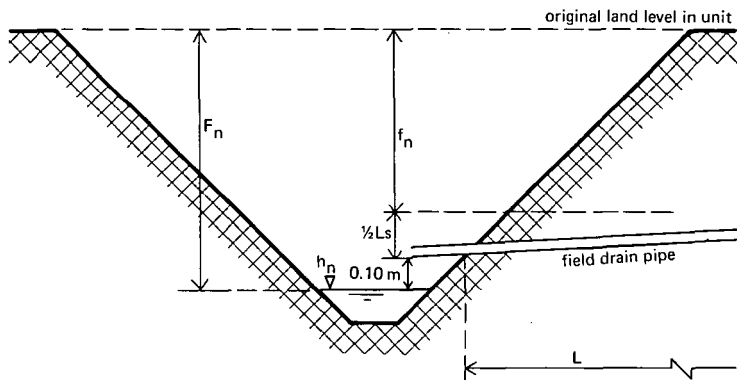

Figure 19.6 Freeboard in a collector drain at 'normal discharge'

the contour interval 0.50 m or less. On this map, 'land and level units' are drawn in which less than 10 per cent of the area is below a certain elevation. As a rule of thumb, the area of 'land level units' is as follows:

- In flat areas: greater than 200 ha, with a level interval of about 0.25 m;
- In sloping areas: greater than 50 ha, with a level interval of 0.50 m or more.

The elevation of each 'land level unit' should be decreased by the required freeboard, F_n , in the local collector drain to find the design water level for Q_n . The resulting water levels now can be written on the topographical map in each 'land level unit'. As mentioned earlier, this level, h_n , will be exceeded about 10 days a year. The h_n levels are used to determine the available hydraulic gradient for canal reaches.

19.3.2 Design Discharge Capacity

A major problem in designing a drainage canal system is determining the discharge capacity which various canal reaches have to handle without overtopping their embankments and inundating the adjacent areas. This is the design discharge for bank-full-flow. It depends on the construction cost of a canal reach and its related structures, and on the damage that will be inflicted if a discharge exceeds the design. These two factors can be combined if we assume that:

- 1) The probability of a certain discharge being exceeded can be described by a double exponential distribution;
- 2) Damages occur only if an existing, or studied discharge, capacity is exceeded;
- 3) If the discharge is exceeded, inundations damage buildings, infrastructures, crops, etc. in the area to be drained;
- 4) All damages can be repaired within one year.

Enlarging the capacity of the drainage canal system decreases the frequency of damage. But regardless of the planned capacity, there is always the chance that the design discharge will be exceeded and damages incurred. In this context, two questions arise: Is it better to use the existing, or presently studied, discharge capacity for the drainage canal system, or must the capacity be increased? And if it is economically justified to increase the capacity of the system, then by how much? We can answer these questions by applying the following procedure.

Determine the Investment Costs

As illustrated in Figure 19.7, increasing the discharge capacity of a drain requires higher investment costs. The example curve in the figure assumes a linear relationship between investment cost and discharge capacity, which only holds true if the same investment must be made along the entire canal system. In reality, one reach and/or structure of the drainage system may require a higher investment cost than another to increase its capacity. And an initial cost must be made to realize any discharge capacity of a canal.

Determine the Damage due to Inundation

If, for example, the existing or presently studied discharge capacity of a drainage

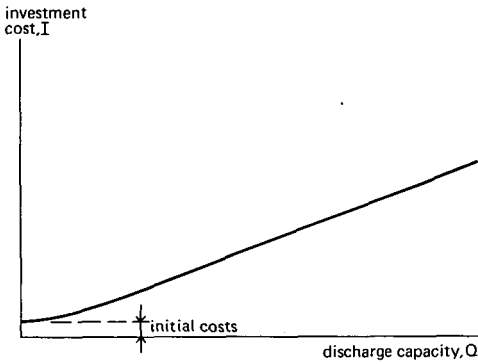

Figure 19.7 Investment cost as a function of canal discharge capacity

system is doubled from a Q_{10} , with a frequency of occurrence once every 10 years, to a Q_{20} , the damage from inundation decreases. To capitalize on the damages that occur if the discharge capacity is exceeded, we assume that they will be covered by a fictitious insurance company. Such a company is necessarily fictitious as there is usually no organization that is willing or able to offer insurance of this type. Damages include: repair or replacement of canals, structures, and pumping stations; loss of productivity of the land; damage to roads, buildings, and so on. The total damage, W , is expressed in monetary terms. Theoretically, the 'insurance company' would need to receive an annual premium equal to the product of the total damage, W , and its frequency of occurrence, F . This annual premium can be paid from the interest on a capital, R , deposited in a bank. The capitalized cost of damage, R , from exceeding a discharge capacity, Q , can be plotted as illustrated in Figure 19.8.

- Hence, the total cost of a drainage canal system (and related structures) consists of:
- The construction cost of all canal reaches, related structures, pumping stations, sluices, and so forth;
 - The capitalized cost of the 'insurance premium'.
- Both costs are a function of the discharge capacity of the drainage system.

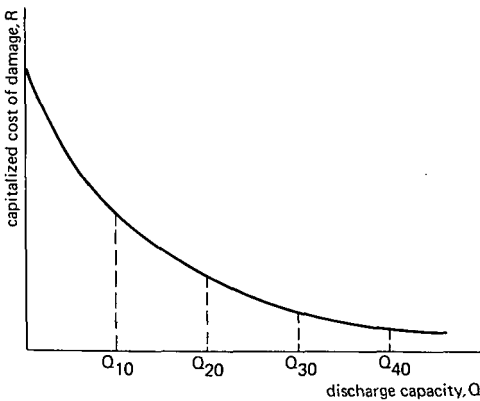

Figure 19.8 Capitalized cost of damage from inundation as a function of drain discharge capacity

The optimum design discharge capacity, Q_d , is obviously that capacity when the total costs, $K = I + R$, are minimal. Superposing the curves in Figures 19.7 and 19.8, we get the optimum, Q_d , as shown in Figure 19.9. For this optimum discharge capacity, the distance BC is the construction cost, I , and the distance AB the related capitalized cost of damage, R .

The capitalized cost of damage because of inundation of an area is strongly influenced by the land use in that area. For example, if only grassland is being drained damage will be low, but fairly high if there are villages, through roads, and so forth in the drained area. If part of the drained area is rural and another part is urban/industrial, different capitalized costs of damage must be determined for the related parts of the drainage system. Because of this influence of land use on the capitalized cost of damage, and thus on the design discharge, increased economic development in the drained area will call for a related increase of the discharge capacity of the drainage system.

Over the distance OC , the general R - Q curve falls sharply while the I - Q curve rises gradually, so the summarized K - Q curve is steeper to the left of A than to its right. This general shape of the K - Q curve has a significant consequence if the drainage canal system is not constructed to accommodate the optimum design discharge. Whether the actual design discharge is too high (OF) or too low (OF'), the total cost of the system will exceed AC . The difference in cost, either DE or $D'E'$, is named 'regret', i.e. the capital lost because the optimum solution was not constructed. A closer look at Figure 19.9 shows that the regret DE is much smaller than $D'E'$, indicating that it is more economical to 'overdesign' the system. This general rule is amplified as damages in the area increase with time because of future development.

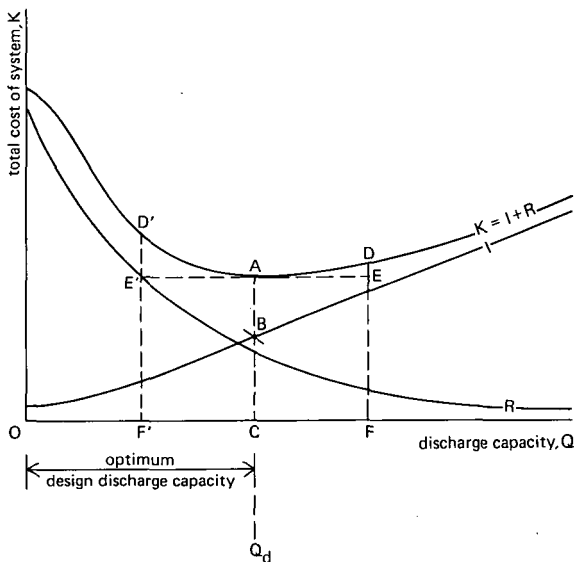

Figure 19.9 Total cost, $K = I + R$, for different discharge capacities of a drainage canal system

19.3.3 Influence of Storage on the Discharge Capacity

We can determine the available hydraulic gradient of the drainage canals with the procedure described in Section 19.3.1. Parallel to this gradient is a high-water-line related to the optimum design discharge capacity (Section 19.3.2) of the canal system. Above this high-water-line, there is often a natural freeboard in some canal reaches that allows water to be stored. Storage is also possible in small lakes or swamps that do not transport water. While these storage areas are being filled, the flow rate in downstream canal reaches and/or structures is reduced. To justify a reduction, storage capacity must be significant with respect to the volume of incoming flow and stored water must be discharged rapidly after a high water peak passed so that the storage capacity can be used again upon occurrence of the next peak. Suitable storage can be found in small lakes or swamps close to a drainage outlet, sluice, or pumping station, or in well drained permeable soils above design groundwater level. Also temporary inundation of low-lying rice fields, grassland, and so on, is a good method of storage.

To illustrate the impact of storage capacity on the design discharge capacity of a structure or canal reach downstream of this storage, Figure 19.10 gives six drain

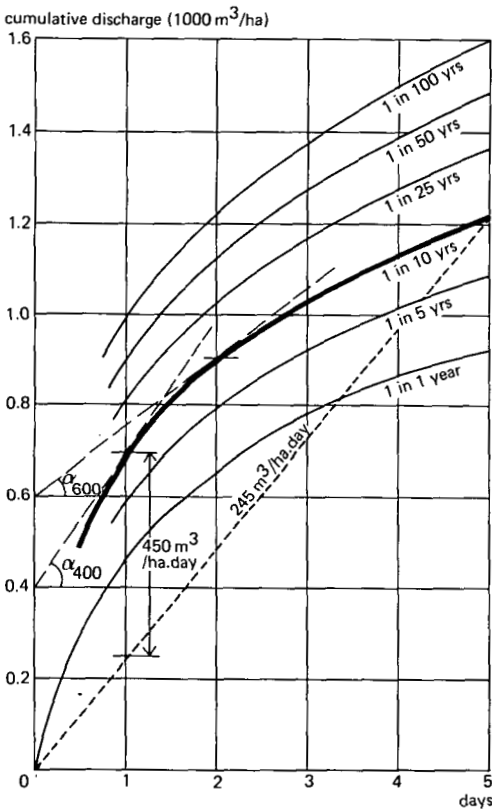

Figure 19.10 Discharge duration curves with varying frequencies of occurrence

discharge duration curves. Such a curve does not represent a 'maximum discharge' but the envelope of maximum discharged volumes (in m^3/ha) for various periods (in days), with a given frequency of occurrence. If we used the procedure in Section 19.3.2 to find an optimum design discharge with a frequency of occurrence of, say, once every 10 years, we can obtain the following information from Figure 19.10:

- If there is no significant storage capacity in the drainage system it must discharge over $700 \text{ m}^3/\text{d}$ per ha in the first day;
- If there is an average storage capacity of $400 \text{ m}^3/\text{ha}$, the required discharge capacity for drains and structures equals the tangent of α_{400} , which is $300 \text{ m}^3/\text{d}$ per ha. The storage capacity thus considerably reduces the required discharge capacity;
- More storage capacity, say $600 \text{ m}^3/\text{ha}$, would reduce the discharge capacity to a low figure of $\tan \alpha_{600} = 150 \text{ m}^3/\text{d}$ per ha. A serious disadvantage of such a low discharge capacity is that the storage cannot be emptied 'rapidly'. In this context, the term 'rapidly' generally means that the cumulative discharge of 5 days must be carried away in 5 days. In Figure 19.10, this rule of thumb would lead to a minimum discharge capacity of $245 \text{ m}^3/\text{d}$ per ha, which would require an average storage capacity of $450 \text{ m}^3/\text{ha}$. If this storage capacity is not feasible, the discharge capacity must be correspondingly higher.

19.3.4 Suitability of Soil Material in Designing Canals

Unified Soil Classification System

To classify soil material as to its suitability in constructing canals, I advise using the 'Unified Soil Classification System', as adapted in 1952 by the U.S. Bureau of Reclamation and the U.S. Army Corps of Engineers. The laboratory work for the identification procedures of this classification system is given in Figure 19.11. In classifying soils, we must realize that with soils consisting largely of fine grains the amount of water present in the voids has a pronounced effect on the soil properties.

Three main states of soil consistency are recognizable:

- The liquid state, in which the soil is either in suspension or behaves like a viscous fluid;
- The plastic state, in which the soil can be rapidly deformed or molded without rebounding elastically, changing volume, cracking, or crumbling;
- The solid state, in which the soil will crack when deformed or will exhibit elastic rebound.

When describing these states, we customarily consider only that fraction of the soil that is finer than the 0.4 mm sieve size (the upper limit of the fine sand component). For this fraction, the water content, expressed as a percent of dry mass, at which the soil passes from the liquid state into the plastic state is called the liquid limit, w_L . Similarly, the water content at which the soil passes from the plastic state to the solid state (or semi-solid state) is called the plastic limit, w_p . The difference between the liquid limit and the plastic limit corresponds to the range of the water content within which the soil remains plastic. This range is called the plasticity index, PI. Highly plastic soils have high PI values. In a non-plastic soil, the plastic limit and the liquid limit are the same, and the PI equals 0. These limits of consistency are called 'Atterberg limits', after a Swedish soil scientist.

Figure 19.11 Laboratory work for Unified Soil Classification

LABORATORY WORK FOR UNIFIED SOIL CLASSIFICATION

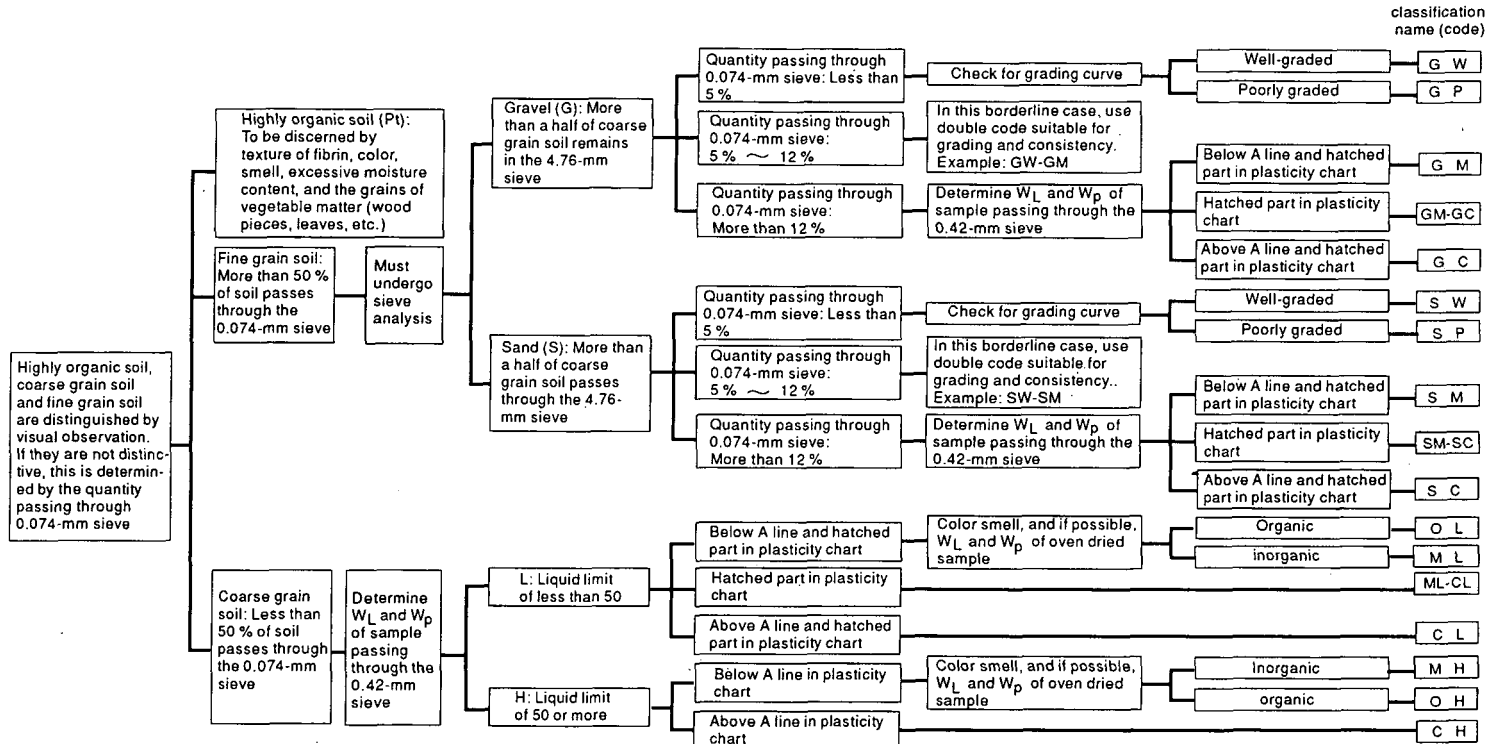

The source of this chart is Earth and Earth-Rock Dams, 1963, p 268

In the case of equal W_L , toughness and dry strength increase with the increase of I_p

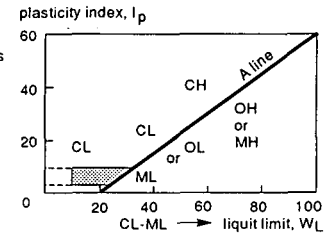

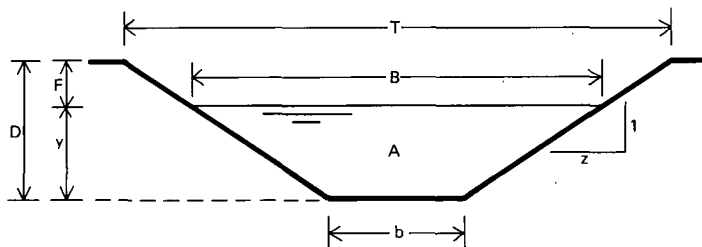

Figure 19.12 Terminology

Side Slope of the Canal

For an earthen canal, a designer usually assumes a trapezoidal cross-section (Figure 19.12). He makes the side slopes as steep as possible to limit excavation and expropriation costs. Side slopes depend on factors such as the soil in which the canal is excavated, canal depth, groundwater flow into the canal, surcharge onto the bank, and so on.

As mentioned earlier, canal depth influences the side slopes. A stable side slope must be flatter as canal depth increases. Table 19.2 gives minimum recommended side slopes (excluding rock). Depending on the soil in which the canal is planned to be excavated, the side slope may be flatter than those shown in Table 19.2.

Table 19.3 lists minimum side slope ratios ($z = \text{horz/vert}$) for canals in different soils. Use flatter side slopes if groundwater seeps through the canal banks or if a public road runs along the canal.

A designer usually determines the side slopes not on the basis of extensive studies



Photo 19.2 Localized failure of a side slope upon construction (Courtesy, L. Molenaar)

Table 19.2 Minimum side slope ratios for various depths of earthen canals

Canal depth, D	Minimum side slope ratio, $z = \text{horz./vert.}$
$D \leq 1 \text{ m}$	1.0
$1 < D < 2$	1.5
$D \geq 2 \text{ m}$	2.0

of soil mechanics, but on the interpretation of soil samples taken along the center line of the planned canal. For a given canal reach, he selects one side slope which, upon construction, may prove to be too steep for a short length of canal (see Photo 19.2). To correct such localized failures, newly constructed systems must be reconstructed after the first drainage season.

Table 19.3 Minimum side slopes for earthen canals in different soil materials

Group symbol	Typical names	Minimum side slope ratio (horz./vert.)
Rk	Rock	0.25
GW	Well-graded gravels, gravel-sand mixtures, little or no fines	2.5
GP	Poorly graded gravels, gravel-sand mixtures, little or no fines	2.5
GM	Silty gravels, poorly graded gravel-sand-silt mixtures	1.5
GC	Clayey gravels, poorly graded gravel-sand-clay mixtures	1.0
SW	Well-graded sands, gravelly sands, little or no fines	2.5
SP	Poorly graded sands, gravelly sands, little or no fines	2.5
SM	Silty sands, poorly graded sand-silt mixtures	2.0
SC	Clayey sands, poorly graded sand-clay mixtures	2.5
ML	Inorganic silts and very fine sands, rock flour, silty or clayey fine sands with slight plasticity	1.5
CL	Inorganic clays of low to medium plasticity, gravelly clays, sandy clays, silty clays, lean clays	2.0
OL	Organic silts and organic silt-clays of low plasticity	2.0
MH	Inorganic silts, micaceous or diatomaceous fine sandy or silty soils, elastic silts	3.0
CH	Inorganic clays of high plasticity, fat clays	3.0
OH	Organic clays of medium to high plasticity	3.0
Pt	Peat and other highly organic soils	1.0
	stiff	3.0
	soft	3.0

class-ification	water permeability characteristic				compaction characteristic				shearing characteristic			erosion resistance	expansion / shrinkage		freezing	suitability as banking mat.		suitab. foundation mat.									
	code	illustration	order	in time of compaction	coeff. in cm/s	necessity of lining	order	workability	dry density t/m ³	suitable for machine	order		shearing strength	cohesion		angle of internal friction	order	character	order	character	order	suitability	order	suitability	order	suitability	order
GW		14	very large	>10 ⁻²	yes	15	very good	2.0 to 2.1	tractor, rubber tire, vibration	1	very large	small	very large	2	very large	14	hardly any	15	none to very small	-	unsuitable	-	unsuitable	-	low	1	high to low
GP		16	very large	>10 ⁻²	yes	8	good	1.8 to 2.0	tractor, rubber tire, vibration	3	large	small	large	3	very large	16	hardly any	17	none to very small	-	unsuitable	-	unsuitable	-	low	3	highest
GM		12	medium to small	10 ⁻³ to 10 ⁻⁶	yes to no	12	good	1.9 to 2.1	rubber tire, sheep's foot vibration	7	large	ordinary	large	5	large	12	very small	10	small to ordinary	6	some-what	5	suitable	3	high	4	high
GC		6	small	10 ⁻⁶ to 10 ⁻⁸	no	11	good	1.8 to 2.1	rubber tire, sheep's foot	9	large	ordinary	ordinary	4	large	10	small	11	small to ordinary	2	most suitable	2	most suitable	4	high	6	high
GW-GC		8	small	10 ⁻⁵ to 10 ⁻⁷	no	16	good	1.8 to 2.1	rubber tire, sheep's foot	4	large	ordinary	large	1	very large	11	small	12	small to ordinary	1	most suitable	1	most suitable	1	highest	5	high
SW		13	large	>10 ⁻³	yes	13	very good	1.8 to 2.1	tractor, vibration	2	very large	small	very large	8	ord-inary	13	hardly any	14	none to very small	-	unsuitable	9	ordinary, high grade pavement	-	low	2	highest
SP		15	very large	>10 ⁻³	yes	13	ord-inary	1.6 to 1.9	tractor, vibration	6	large	small	large	9	ord-inary	15	hardly any	16	none to very small	-	unsuitable	9	ordinary, high grade pavement	-	low	7	high
SM		11	medium to large	10 ⁻³ to 10 ⁻⁶	yes to no	10	ord-inary	1.8 to 2.0	rubber tire, sheep's foot vibration	8	large	small	large	10	small	9	very small-ordinary	7	small to large	7	ordinary (erosion limit)	6	suitable	5	high	10	high to low
SC		5	small	10 ⁻⁶ to 10 ⁻⁸	no	9	ord-inary	1.7 to 2.0	rubber tire, sheep's foot	10	ordinary	ordinary	ordinary	7	ord-inary	7	small to ordinary	8	small to large	4	suitable	4	suitable	6	high	9	high to low
SW-SC		7	small	10 ⁻⁵ to 10 ⁻⁷	no	14	good	1.7 to 2.1	rubber tire, sheep's foot	5	large	ordinary	large	6	large	8	small to ordinary	9	small to large	3	most suitable	3	most suitable	2	highest	8	high to low
ML		10	medium to small	10 ⁻³ to 10 ⁻⁶	yes to no	5	ord-inary	1.5 to 1.9	rubber tire, sheep's foot	12	ordinary	small	ordinary	-	very large	6	small to ordinary	1	ordinary to very large	8	ordinary (erosion limit)	8	some-what suitable	8	high to low	12	high to low
CL		3	small	10 ⁻⁶ to 10 ⁻⁸	no	6	ord-inary	1.5 to 1.9	rubber tire, sheep's foot	11	ordinary	large	small	11	small	5	ordinary	3	ordinary to large	5	some-what suitable	7	some-what suitable	7	high to low	11	high to low
OL		4	medium to small	10 ⁻⁴ to 10 ⁻⁶	no	3	bad	1.3 to 1.6	rubber tire, sheep's foot	15	small	unknown	unknown	-	very small	4	ordinary to large	4	ordinary to large	9	ordinary (erosion limit)	12	ordinary	9	high to low	13	low
MH		9	medium to small	10 ⁻⁴ to 10 ⁻⁶	no	2	bad	1.1 to 1.5	sheep's foot	14	ordinary to small	large	small	-	very small	3	large	2	ordinary to very large	-	unsuitable	13	ordinary	10	high to low	14	low
CH		1	small	10 ⁻⁶ to 10 ⁻⁸	no	4	bad	1.2 to 1.7	sheep's foot	13	ordinary to small	large	small	12	small	2	large	5	ordinary	10	unsuitable	11	ordinary	11	high to low	15	low
OH		2	small	10 ⁻⁶ to 10 ⁻⁸	no	1	bad	1.0 to 1.6	sheep's foot	16	small	unknown	unknown	-	very small	1	large	6	ordinary	-	unsuitable	14	unsuitable	12	high to low	16	low
Pt		-	-	-	-	-	-	-	-	-	small	-	-	-	very small	-	very large	13	small	-	unsuitable	banking for surfaced-lined canal	-	low	-	low	
remarks	order: in order of coefficients of water permeability				order: in order of densities																						

Table 19.4 Suitability of soil material in designing canals (the codes in the first column are explained in Table 19.3)

Suitability of a Soil as Construction Material

Soil classification is a major factor influencing the construction of earthen canals, embankments, and dikes. Table 19.4 lists the suitability of the different soil classes as construction material for canals. Data are included that are not relevant for drainage canals, but as most of this chapter also applies to un-lined irrigation canals, this additional information has been given as well.

19.3.5 Depth of the Canal Versus Width

An important criterion that influences the shape of the canal cross section is the ratio between bottom width, b , and canal depth, D . In selecting the ratio, b/D , we must take the following points into consideration:

- 1) Cost of construction, including expropriation of land;
- 2) Methods of maintenance;
- 3) Permissible fluctuation of the water level and minimum water depth;
- 4) Available or permissible hydraulic gradient;
- 5) Function of the canal.

Re 1: The water level in canals that collect water from the adjacent area always lies below the original land surface. As shown in Figure 19.13A, such wide and shallow canals require more excavation and expropriation than deeper canals, where water flows at a similar average velocity.

Conveyance drains that transport flood water through a low-lying area with the water

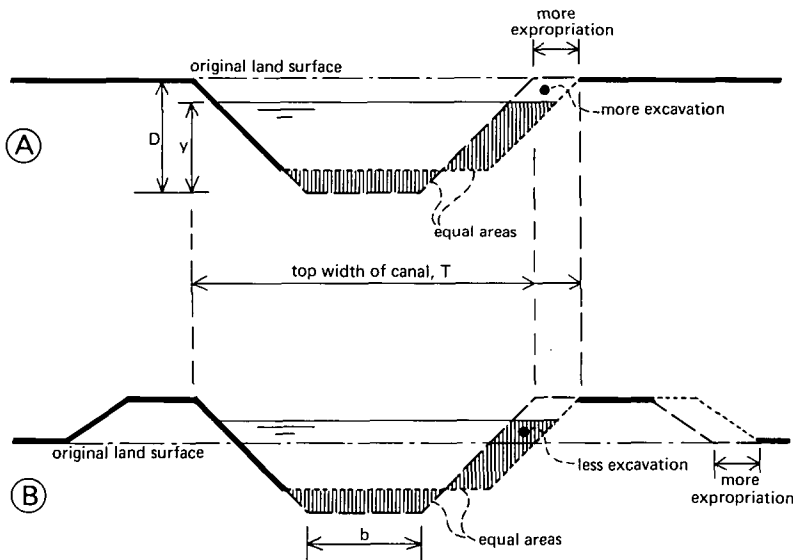

Figure 19.13 Comparison of canals of different widths having the same wetted area

surface above land level (Figure 19.13B) require less excavation if the canals are wide, but more expropriation. If the design water level is at land surface, the excavation of narrow deep canals is equal to that of wide shallow canals, where water flows at the same average velocity. To minimize construction cost, the designer will try to balance excavation and backfill along a canal reach.

Re 2: The method chosen to remove aquatic weeds and silt from a canal to maintain the cross-section and keep the hydraulic resistance (Manning's n-value) below the design value influences the design. Specialized maintenance equipment usually is mounted on a tractor or hydraulic excavator. Figure 19.14 gives an example of how the reach of the equipment influences the top width and depth of a canal. If the permitted depth is exceeded, a berm of sufficient width (> 3.50 m) must be designed to accommodate the machinery. Photo 19.3 gives an example of how a machine can clean an entire canal just by working from the maintenance track on one side. If the top width of the canal were, say, 1 m wider, the machine would have to make a second run through the field on the left, making maintenance almost twice as costly.

Re 3: The water levels of narrow, deep canals fluctuate strongly with different actual flow rates. This fluctuation may damage side slopes if it occurs rapidly and creates a steep watertable gradient. If storage capacity is needed in a drainage system that discharges through a tidal gate or pumping station, wide canals with little fluctuation are advantageous.



Photo 19.3 This machine can clean a drain with this top-width by working from one side only.

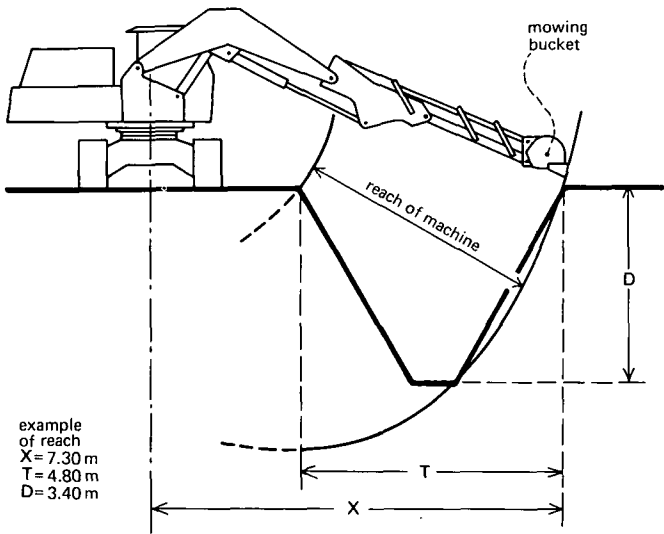

Figure 19.14 Relation between the reach of a machine and the size of canal that can be maintained

Re 4: As a preliminary to Section 19.5, note that we commonly use Manning's equation to calculate the average velocity in canals with uniform flow

$$v = \frac{1}{n} R^{2/3} s^{1/2} \quad (19.2)$$

where

- v = average flow velocity (m/s)
- n = resistance coefficient (-)
- R = hydraulic radius ($R = A/P$) (m)
- A = cross-sectional area of flow (m^2)
- P = wetted perimeter (m)
- s = hydraulic gradient (-)

Many areas to be drained have a rather flat topography so that the hydraulic gradient is limited. Rewriting of Equation 19.2 to

$$s = \frac{v^2 n^2}{R^{4/3}} \quad (19.3)$$

we see that, with a constant value for v , the hydraulic gradient is at a minimum if $R = A/P$ is at a maximum. Hence, the wetted perimeter must be as small as possible. As illustrated in Figure 19.15, this is true if the bottom and side slopes of the canal are tangent to a circle. These requirements indicate rather narrow, deep canals, and hold for concrete lined irrigation canals and small earthen canals. Larger earthen canals usually have a larger b/D ratio.

Re 5: Small-capacity collector drains, as illustrated in Figure 19.6, usually have the smallest practical bottom width of $b = 0.50 \text{ m}$. The excavated soil is spread over

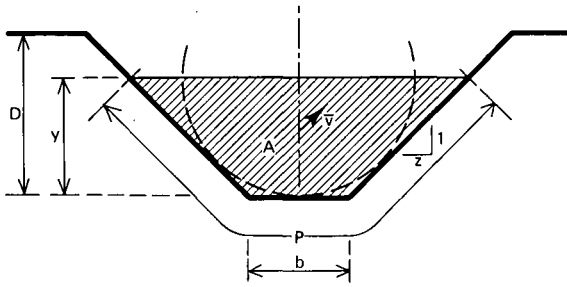

Figure 19.15 Best hydraulic section

the adjacent fields or removed, so that a simple trapezoidal cross section is commonly used for such collector drains.

The large-capacity main drains, or interceptor drains, often have a spoil bank and berms, which are also used as maintenance tracks (Figure 19.16A). Interceptor drains always have an asymmetrical cross section. The uphill side slope is relatively flat. On the downhill side of the drain there is a maintenance berm and spoil bank (Figure 19.16B).

From the above, it will be clear that it is not practical to give simple design criteria for a b/D ratio. The matter becomes even more complicated if the canal is excavated in a layered soil, or if it is used for navigation, dry season irrigation, and so forth. To minimize the cost of excavation, land expropriation, and maintenance, modern earthen canals tend to be as narrow as possible. In practice, however, it is recommended to exceed the b/D ratios given in Figure 19.17.

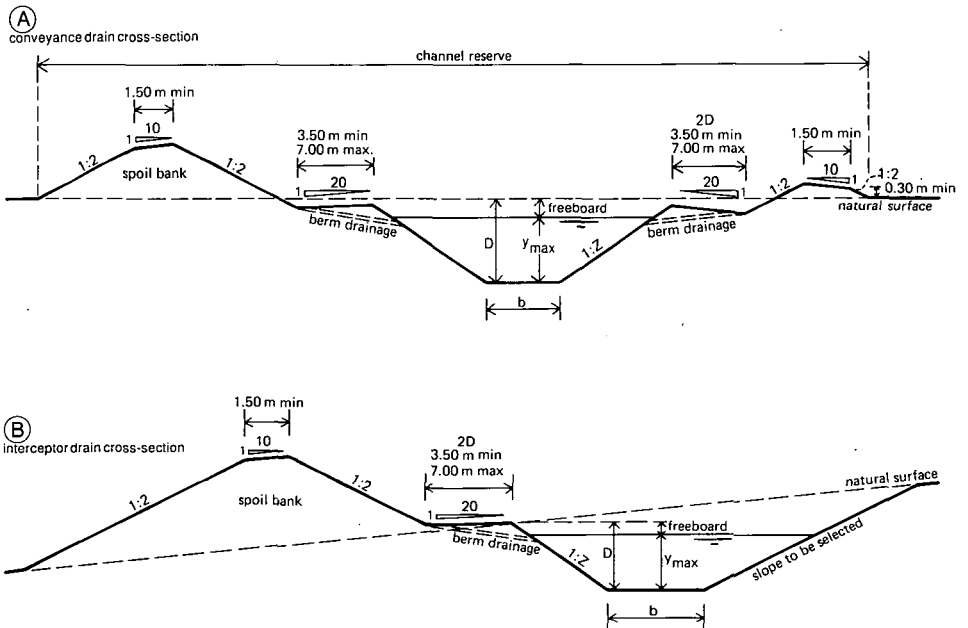

Figure 19.16 Examples of cross sections over drains

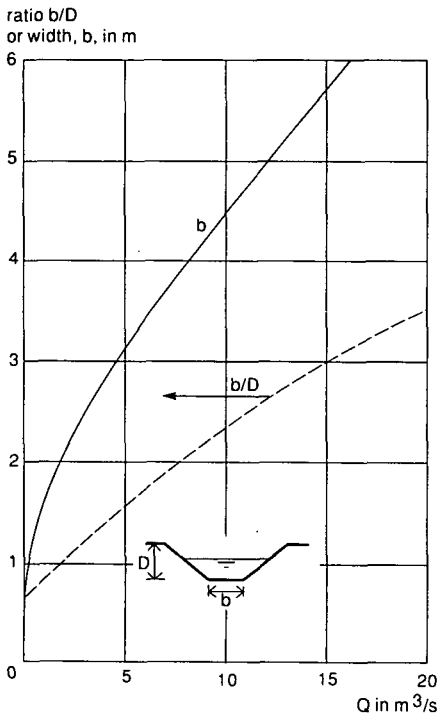

Figure 19.17 Minimum recommended values for earthen canal dimensions (after Bos, Replogle, and Clemmens 1984)

19.3.6 Canal Curvature

The alignment of a drainage canal consists of straight and curved reaches. The radius of curvature at changes of alignment is a function of the canal capacity as shown in Table 19.5. If the required radius cannot be achieved, it can be reduced to as low as 3 times the canal's bottom width, if lining for the outer curve or the entire canal is installed (Photo 19.4). This minimized radius, however, should be adopted only in exceptional circumstances.

Table 19.5 Radius of curvature of earthen canals

Canal capacity in m^3/s	Minimum radius*
up to 5	$3 \times$ bottom width (5 m min)
5 to 7.5	4
7.5 to 10	5
10 to 15	6
15 and over	7

* Round up to next highest metre



Photo 19.4 Local failure of side slope upon construction (courtesy, L Molenaar).

19.3.7 Canal Profiles

Following the field check of the canal center line on the photo mosaic, the selection of the alignment should be based on all the cross sections, and geologic and environmental data.

In addition to the survey data collected and mapped, the following design data should be included in the report on the drainage system:

- 1) Profiles of canals, showing alignment with bearings or an azimuth for each tangent. Length of canal reaches and radii of curves should be given;
- 2) Proposed hydraulic gradient, including elevation of canal bottom;
- 3) Typical cross sections, showing existing and proposed sections; one cross section for each type or size of the proposed section should be included on each sheet of corresponding canal reach. Average flow velocities should be given for normal (base) flow and for (high) design flow;
- 4) If structures are proposed for a canal reach, a drawing of a typical structure showing full dimensions should be included. Head loss over the structures at design (high) flow must be given;
- 5) Canal reaches through or along valuable landscapes must be illustrated with drawings, sketches or photo montages showing how the canal and structures will look in the surrounding landscape.

An example of a longitudinal profile is shown in Figure 19.18.

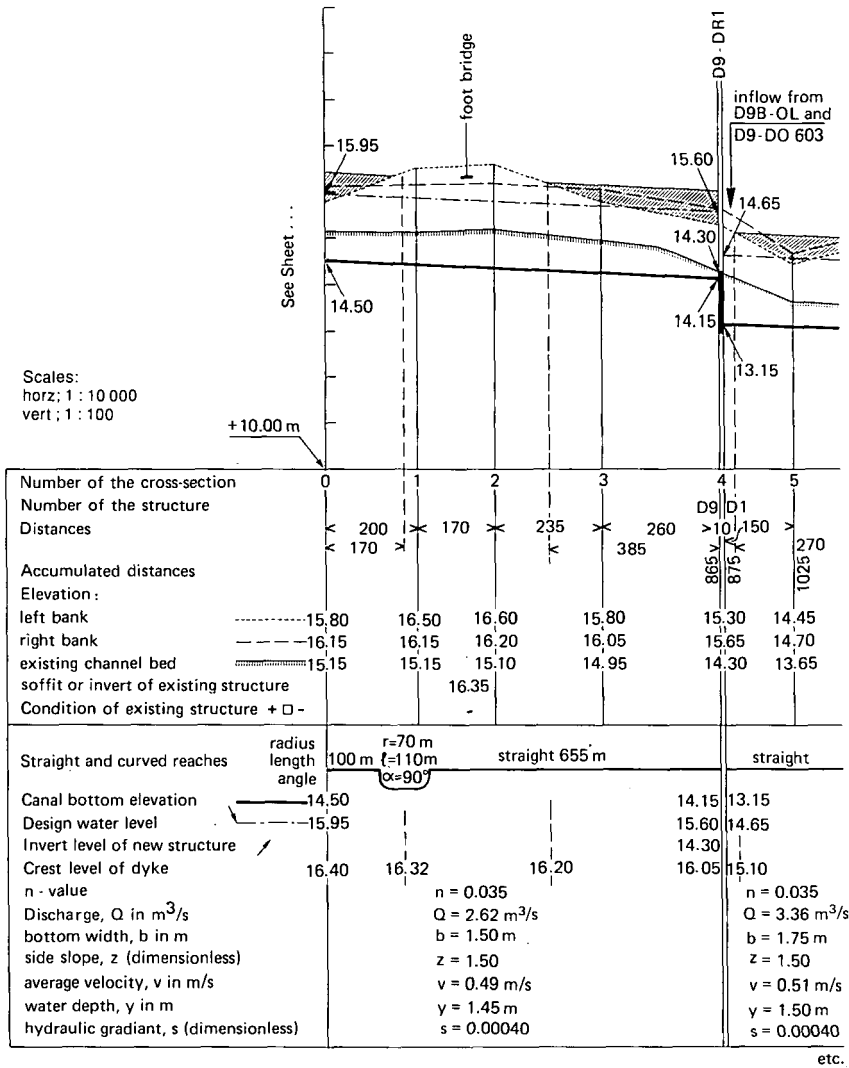

Figure 19.18 Example of a longitudinal profile

19.4 Uniform Flow Calculations

19.4.1 State and Type of Flow

The flow in the canals forming the main drainage system is very complicated because it changes as the discharge from the field drainage system changes. Moreover, the cross section of the canals is not the same along its entire length, and it contains structures that influence the flow. To simplify the computation of flow, the drainage canal system is divided into reaches between structures and canal junctions. In each

reach, the discharge is considered a constant design value. This is a fair assumption in areas where the transformation of precipitation into surface runoff is slow. The computation is therefore made for the design discharge at a certain moment, the flow being uniform for this discharge. Uniform flow means that in every section of a canal reach, the discharge, area of flow, average velocity, and water depth are constant. Consequently, the energy line and the water surface will be parallel to the channel bottom (Figure 19.19). This assumption is valid except for immediately upstream of structures, where a backwater effect may occur.

In contrast with groundwater flow, flow through open channels and pipelines is nearly always turbulent. Only rarely will laminar flow appear as, for example, sheet flow over flat lands. As a criterion for the condition of flow, we use the Reynolds number, which is defined here as

$$Re = \frac{vR\rho}{\eta} \quad (19.4)$$

where

ρ = mass density of water (kg/m^3)

η = dynamic viscosity (kg/m s)

For values of ρ and η see Table 7.1 of Chapter 7.

When Re is less than about 500, the flow is laminar; and when Re is larger than about 2000, the flow is turbulent. If Re ranges between 500 and 2000, flow is transitional, and may either be turbulent or laminar depending on the direction from which this transitional range is entered (Chow 1959).

The flow of water through open channels is affected by viscosity and by gravity. The effect of gravity can best be explained by the concept of energy. As stated in Section 7.2.4, water has three interchangeable types of energy per unit of volume:

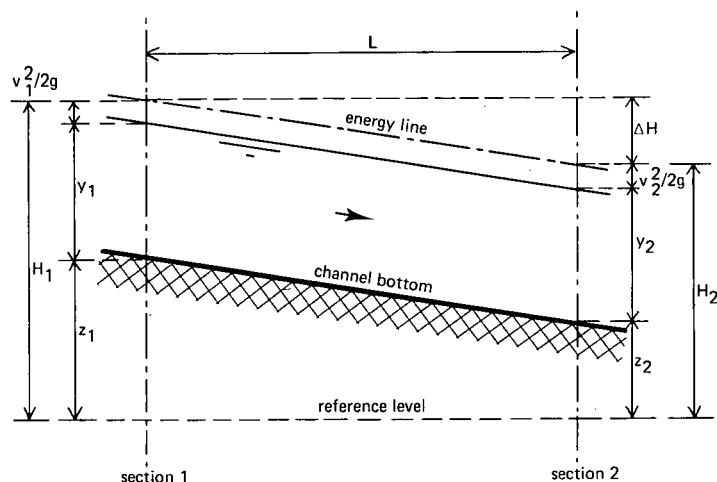

Figure 19.19 Types of energy in a channel with uniform flow

kinetic, potential, and pressure. For Section 1 of Figure 19.19 we thus may write

$$H_1 = \frac{v_1^2}{2g} + \frac{p_1}{\rho g} + z_1 \quad (19.5)$$

where

- H = total energy head (m)
- g = acceleration due to gravity (m/s^2)
- p = hydrostatic pressure (Pa)
- z = elevation head (m)

For uniform flow the pressure under water increases linearly with depth, so the pressure head, $p_1/\rho g$, can be replaced by y_1 . We can therefore write Equation 19.5 as

$$H_1 = \frac{v_1^2}{2g} + y_1 + z_1 \quad (19.6)$$

If we express the total energy head relative to the channel bottom ($z_1 = 0$) and substitute the continuity equation

$$Q = v_1 A_1 = v A \quad (19.7)$$

into Equation 19.6, we can write

$$H_1 = y_1 + \frac{Q^2}{2gA_1^2} \quad (19.8)$$

where A_1 , the cross-sectional area of flow, can also be expressed in terms of y_1 . From Equation 19.8 we see that for a given shape of the canal cross section and a constant discharge, Q , there are two alternate depths of flow, y_1 , for each energy head, H_1 (Figure 19.20). For the greater depth, y_{sub} , the flow velocity is low and flow is called subcritical; for the lesser depth, y_{super} , the flow velocity is high and flow is called supercritical. Equation 19.8 also can be presented as a family of curves, with the channel-bottom-referenced energy head and the water depth as coordinates. This is shown for one constant Q in Figure 19.21. The water depths y_{sub} and y_{super} and the related velocity heads are illustrated in Figure 19.20.

The total energy head as measured with respect to the channel bottom can be lower than that used in Figure 19.20. With a decreasing H value, the difference between y_{sub} and y_{super} becomes smaller until they coincide at the minimum possible value of

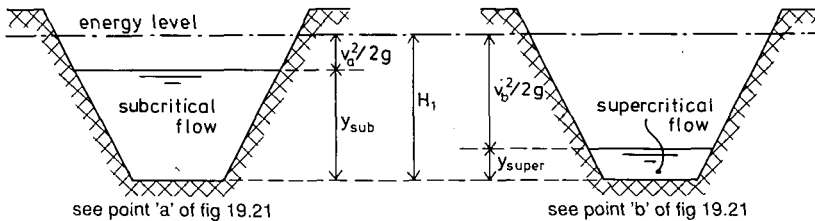

Figure 19.20 With, Q_1 and H_1 , two alternate depths of flow are possible

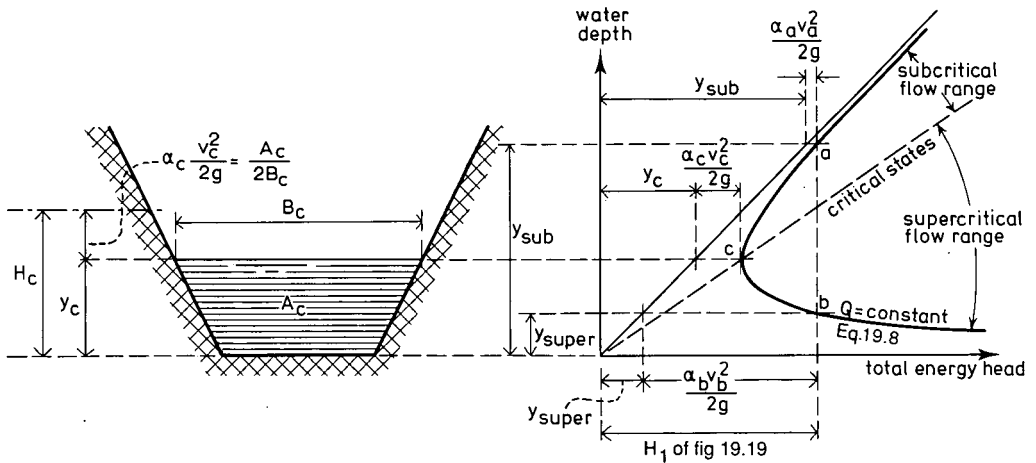

Figure 19.21 Relation between energy head and state of flow

H at which the constant discharge, Q , can be transported through the canal. When this happens, we have reached point C on the curve in Figure 19.21. The depth of flow at point C is known as 'critical depth', y_c .

When there is a rapid change in flow depth from y_{sub} to y_{super} , a steep depression called a hydraulic drop, will occur in the water surface. The water surface in the drop remains rather smooth, and energy losses over it are usually less than $0.1v_b^2/2g$. On the other hand, if there is a rapid change of flow from y_{super} to y_{sub} , the water surface will rise abruptly, creating what is called a 'hydraulic jump', or 'standing wave'. The hydraulic jump is highly turbulent, which may cause as much as $1.2v_b^2/2g$ of the total (hydraulic) energy to be lost to heat and noise.

From Figure 19.21 we see that if the flow is critical the channel bottom-referenced total energy head is a minimum for the constant discharge, Q . This minimum occurs if $dH/dy = 0$; thus if

$$\frac{dH}{dy} = 1 - \frac{Q^2}{gA^3} \frac{dA}{dy} = 0$$

Since $dA = B dy$, with $B =$ width of the water surface in the canal, this equation becomes

$$\frac{v^2 B}{gA} = 1 \tag{19.9}$$

The square root of the left-hand term of Equation 19.9 is the 'well-known 'Froude number'

$$Fr = \frac{v}{\sqrt{g \frac{A}{B}}} \tag{19.10}$$

From the above we see that if $Fr = 1.0$, flow is critical; if $Fr > 1.0$, flow is supercritical,

and if $Fr < 1.0$, flow is sub-critical. In earthen canals the flow velocity usually is so low that the Froude number is below 0.2. If the canal has a (pervious) lining, the flow velocity can increase without causing erosion. However, to avoid an uncontrolled hydraulic jump in a channel because of variations in v , B , or A , open channels usually are designed to flow at $Fr \leq 0.45$.

19.4.2 Manning's Equation

The most widely used equation for calculating uniform flow in open channels is Manning's equation. It was published in 1889, and later modified to read (in metric units)

$$v = \frac{1}{n} R^{2/3} s^{1/2} \quad (19.11)$$

Because of the assumption that the resistance coefficient is dimensionless, the factor 1 of Equation 19.11 measures $m^{1/3}/s$, which is partly due to the incorporated \sqrt{g} (g = acceleration due to gravity). Therefore, Equation 19.11 reads in English units

$$v = \frac{1.49}{n} R^{2/3} s^{1/2} \quad (19.12)$$

In combination with the continuity equation

$$Q = vA \quad (19.13)$$

Equation 19.11 reads

$$Q = \frac{1}{n} A R^{2/3} s^{1/2} \quad (19.14)$$

or

$$AR^{2/3} = \frac{n Q}{s^{1/2}} \quad (19.15)$$

Because we calculate the hydraulic radius from the canal dimensions to equal

$$R = \frac{A}{P} = \frac{(b + zy) y}{b + 2y\sqrt{1 + z^2}} \quad (19.16)$$

We can also write the left-hand term of Equation 19.15 as

$$AR^{2/3} = \frac{[(b + zy) y]^{5/3}}{[b + 2y\sqrt{1 + z^2}]^{2/3}} \quad (19.17)$$

To use these equations in canal design is complicated because only the tentative canal alignment and the design discharge are known. The canal alignment and Section 19.3.1 should be used to determine the available hydraulic gradient, s . The design discharge yields the Q value. The procedure to determine the remaining design parameter is as follows:

- 1) Use the anticipated canal depth (Table 19.2), and the collected soil mechanical information (Table 19.3) to select a side slope ratio, z ;
- 2) Read the criterion of Section 19.3.5 on the b/y ratio. Note that for the b/y ratio, y approaches D for bank-full flow at the design capacity. Use Figure 19.17 to select a b/y value;
- 3) Substitute the selected values of z and b/y into Equation 19.17. This equation then reduces to

$$A R^{2/3} = K_b b^{8/3} \quad (19.18)$$

where K_b has a constant value for each given combination of z and b/y ;

- 4) Use Section 19.4.3 to determine a n -value for the design discharge. For vegetated channels a tentative average flow velocity must be assumed to calculate the Reynolds number. Note that the n -value generally decreases with increasing water depth because in deep channels most water flows further away from the channel bottom and sides. Hence, a higher n -value should be used for the normal (base) flow Q_n in the same canal;
- 5) Use the topographical map, and the canal alignment (read Section 19.3.1), to determine the available hydraulic gradient. The gradient that can be used for canal flow often will be less than this available gradient because; head loss is needed for flow through structures; the flow velocity may be too high with the available gradient;
- 6) Calculate the value of $AR^{2/3}$ with Equation 19.15. This value now can be substituted into Equation 19.18 to calculate the bottom width, b . Round off this b -value to, for example, the nearest 0.10 m;
- 7) With the z value of Step 1, and the b/y ratio of Step 2, determine the canal cross section. From this cross section the wetted area $A = (b + zy)y$ can be calculated;
- 8) Calculate the average flow velocity with $v = Q/A$.

At this stage of the calculations, the designer must check whether the calculated average velocity is permissible (see Section 19.5). If the velocity is too high, he should repeat Step 5 to 8 with a flatter hydraulic gradient.

- 9) Use the above canal dimensions, and the n value for Q_n , to calculate the flow depth at normal flow. If the flow depth at this normal (base) flow is very shallow, water tends to concentrate and local erosion may occur on the (wide) canal bottom. Two solutions are available; narrow the canal bottom, or design a compound canal whereby the normal flow is concentrated in a narrow (lined) part of the cross section.

19.4.3 Manning's Resistance Coefficient

The value of n depends on a number of factors: roughness of the channel bed and side slopes, thickness and stem length of vegetation, irregularity of alignment, and hydraulic radius of the channel. The U.S. Bureau of Reclamation (1957) published a good description of channels, with their suitable n value, based on the work of Scobey. As shown below, this description gives good information if n remains below about 0.030.

$n = 0.012$

For surfaced, untreated lumber flumes in excellent condition; for short, straight, smooth flumes of unpainted metal; for hand-poured concrete of the highest grade of workmanship with surfaces as smooth as a troweled sidewalk with masked expansion joints; practically no moss, larvae, or gravel ravelings; alignment straight, tangents connected with long radius curves; field conditions seldom make this value applicable.

$n = 0.013$

Minimum conservative value of n for the design of long flumes of all materials of quality described under $n = 0.012$; provides for mild curvature or some sand; treated wood stave flumes; covered flumes built of surfaced lumber, with battens included in hydraulic computations and of high-class workmanship; metal flumes painted and with dead smooth interiors; concrete flumes with oiled forms, fins rubbed down with troweled bottom; shot concrete if steel troweled; conduits to be this class should probably attain $n = 0.012$ initially.

$n = 0.014$

Excellent value for conservatively designed structures of wood, painted metal, or concrete under usual conditions; cares for alignment about equal in curve and tangent length; conforms to surfaces as left by smooth-jointed forms or well-broomed shot concrete; will care for slight algae growth or slight deposits of silt or slight deterioration.

$n = 0.015$

Rough, plank flumes of unsurfaced lumber with curves made by short length, angular shifts; for metal flumes with shallow compression member projecting into section but otherwise of class $n = 0.013$; for construction with first-class sides but roughly troweled bottom or for class $n = 0.014$ construction with noticeable silt or gravel deposits; value suitable for use with muddy gravel deposits; value suitable for use with muddy water for either poured or shot concrete; smooth concrete that is seasonally roughened by larvae or algae growths take value of $n = 0.015$ or higher; lowest value for highest class rubble and concrete combination.

$n = 0.016$

For lining made with rough board forms conveying clear water with small amount of debris; class $n = 0.014$ linings with reasonably heavy algae; or maximum larvae growth; or large amounts of cobble detritus; or old linings repaired with thin coat of cement mortar; or heavy lime encrustations; earth channels in best possible conditions, with slick deposit of silt, free of moss and nearly straight alignment; true to grade and section; not to be used for design of earth channels.

$n = 0.017$

For clear water on first-class bottom and excellent rubble sides or smooth rock bottom and wooden plank sides; roughly coated, poured lining with uneven expansion joints; basic value for shot concrete against smoothly trimmed earth base; such a surface is distinctly rough and will scratch hand; undulations of the order of 0.025 m.

$n = 0.018$

About the upper limit for concrete construction in any workable condition; very rough concrete with sharp curves and deposits of gravel and moss; minimum design value for uniform rubble; or concrete sides and natural channel bed; for volcanic ash soils with no vegetation; minimum value for large high-class canals in very fine silt.

$n = 0.020$

For tuberculated iron; ruined masonry; well-constructed canals in firm earth or fine packed gravel where velocities are such that the silt may fill the interstices in the gravel; alignment straight, banks clean; large canals of classes $n = 0.0225$.

$n = 0.0225$

For corrugated pipe with hydraulic functions computed from minimum internal diameter; average; well-constructed canal in material which will eventually have a medium smooth bottom with graded gravel, grass on the edges, and average alignment with silt deposits at both sides of the bed and a few scattered stones in the middle; hardpan in good condition; clay and lava-ash soil. For the largest of canals of this type a value of $n = 0.020$ will be originally applicable.

$n = 0.025$

For canals where moss, dense grass near edges, or scattered cobbles are noticeable. Earth channels with neglected maintenance have this value and up; a good value for small head ditches serving a couple of farms; for canals wholly in-cut and thus subject to rolling debris; minimum value for rock-cut smoothed up with shot concrete.

$n = 0.0275$

Cobble-bottom canals, typically occurring near mouths of canyons; value only applicable where cobbles are graded and well packed; can reach 0.040 for large boulders and heavy sand.

$n = 0.030$

Canals with heavy growth of moss, banks irregular and overhanging with dense rootlets; bottom covered with large fragments of rock or bed badly pitted by erosion.

$n = 0.035$

For medium large canals about 50 percent choked with moss growth and in bad order and regimen; small channels with considerable variation in wetted cross section and biennial maintenance; for flood channels not continuously maintained; for untouched rock cuts and tunnels based on 'paper' cross section.

$n = 0.040$

For canals badly choked with moss, or heavy growth; large canals in which large cobbles and boulders collect, approaching a stream bed in character.

$n = 0.050 - 0.060$

Floodways poorly maintained; canals two-thirds choked with vegetation.

$$n = 0.060 - 0.240$$

Floodways without channels through timber and underbrush, hydraulic gradient 0.20 to 0.40 m per 1000 m.

Manning's resistance coefficient is reasonably reliable under the above conditions if the value of n does not exceed 0.030. Channels with vegetation often have higher n values. To determine the value for such channels we can split the n value into three components (Cowan 1956)

$$n = n_t + n_o + n_v \quad (19.19)$$

where

- n_t = grain roughness component (-)
- n_o = surface irregularity component (-)
- n_v = vegetal drag component (-)

The grain roughness component, n_t , has a lower limit, which accounts for the 'smooth boundary' condition. Its value is

$$n_t = 0.015 d_m^{1/6} \quad (19.20)$$

where

$d_m = d_{50}$, which is the particle-diameter (mm) at which 50% (by mass) of the material is larger than that particle-diameter.

The d_{50} value can be used provided that $d_{50} \geq 0.05$ mm. If $d_{50} < 0.05$ mm, a minimum value of 0.05 mm is used in Equation 19.20.

We can determine the surface irregularity component, n_o , with Table 19.6. For the analysis of channel stability, it is not advisable to use a n_o value higher than 0.005

Table 19.6 Surface irregularity component n_o (from U.S. Dept. of Agriculture 1954)

Degree of irregularity	Surfaces comparable to:	Surface irregularity component, n_o
Smooth	The best obtainable for the materials involved.	0.000
Minor	Good dredged channels; slightly eroded or scoured side slopes of canals or drainage channels.	0.005
Moderate	Fair to poor dredged channels; moderately sloughed or eroded side slopes of canals or drainage channels.	0.010
Severe	Badly sloughed banks of natural channels; badly eroded or sloughed sides of canals or drainage channels; unshaped, jagged and irregular surfaces of channels excavated in rock.	0.020

unless the increased form roughness is expected to be permanent. This because a greater n value implies less stress at the soil-water interface.

When the channel bed and bank are thickly covered with vegetation, part of the water flows through the vegetation at low velocities. The thickness and stem length of the vegetation influence the extent of this 'low velocity' zone, while the velocities themselves are influenced by the Reynolds number (Equation 19.4). The vegetal drag component, n_v , is an analytic expression for the test reported by Ree and Palmer (1949). Temple (1979) expressed it as

$$n_v = n_R - 0.016 \quad (19.21)$$

where

0.016 = reference soil resistance value ($n_i \approx 0.016$) for a smoothly graded, bare earth channel

n_R = retardance coefficient component (-)

Within the limits of application, Figure 19.22 gives the values of n_R as a function of vegetal retardance and the Reynolds number

$$Re_g = \frac{vR_g}{\eta} \quad (19.22)$$

with

$R_g = A_g/P_g$

P_g = grassed, wetted perimeter (m)

A_g = flow area working on P_g (m^2)

C_1 = retardance curve index (see Figure 19.22)

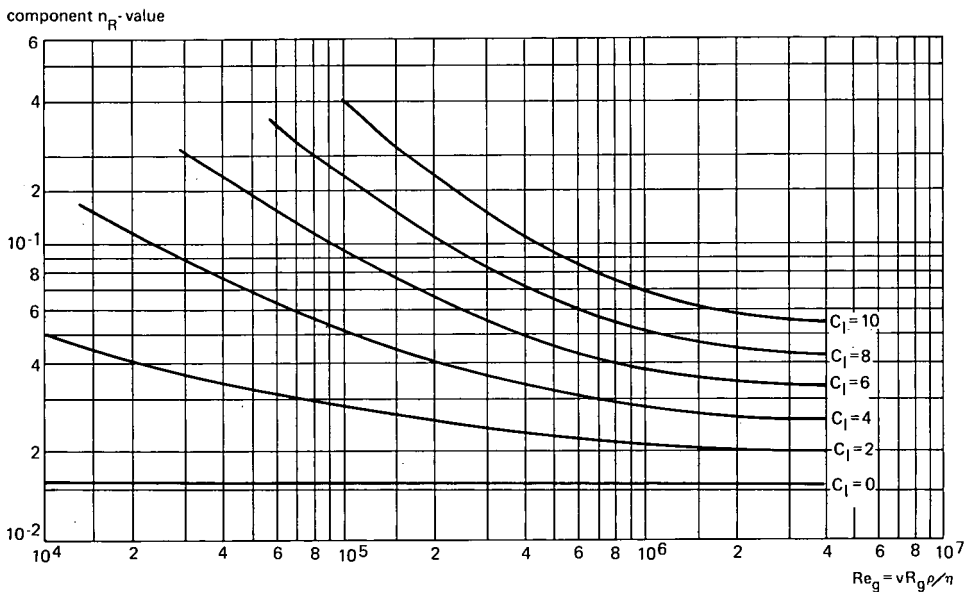

Figure 19.22 Vegetal retardance curves (Ree and Palmer 1949)

For design purposes, an engineer can take the C_1 value from Table 19.7. He can also base C_1 on field data by using the following equation

$$C_1 = 1.63 G_1^{0.29} G_{SC}^{0.12} \quad (19.23)$$

where

G_1 = average stem length (m)

G_{SC} = average number of stems per m^2 (the usual count is in a square of 0.3 \times 0.3 m)

Table 19.7 Classification of vegetal covers as to degree of retardance*

10.0	Weeping lovegrass	Excellent stand, tall (average 0.75 m)
	Yellow bluestem <i>Ischaemum</i>	Excellent stand, tall (average 0.90 m)
	Kudzu	Very dense growth, uncut
	Bermuda grass	Good stand, tall (average 0.30 m)
7.6	Native grass mixture (little bluestem, blue grama, and other long and short midwest grasses)	Good stand, unmowed
	Weeping lovegrass	Good stand, tall (average 0.60 m)
	<i>Lespedeza sericea</i>	Good stand, not woody, tall (average 0.50 m)
	Alfalfa	Good stand, uncut (average 0.25 m)
	Weeping lovegrass	Good stand, mowed (average 0.30 m)
	Kudzu	Dense growth, uncut
	Blue grama	Good stand, uncut (average 0.30 m)
5.6	Crabgrass	Fair stand, uncut (0.25 to 1.20 m)
	Bermuda grass	Good stand, mowed (average 0.15 m)
	Common lespedeza	Good stand, uncut (average 0.25 m)
	Grass-legume mixture-summer (orchard grass, redtop, Italian rye grass, and common lespedeza)	Good stand, uncut (0.15 to 0.20 m)
	Centipede grass	Very dense cover (average 0.15 m)
	Kentucky blue grass	(Good stand, headed (0.15 to 0.30)
	Bermuda grass	Good stand, cut to 0.07 m height
	Common lespedeza	Excellent stand, uncut (average 0.10 m)
	Buffalo grass	Good stand, uncut (0.07 to 0.15 m)
4.4	Grass-legume mixture-fall, spring (orchard grass, redtop, Italian rye grass, and common lespedeza)	Good stand, uncut (average 0.10 m)
	<i>Lespedeza sericea</i>	Cut to 0.05 m height. Very good stand before cutting.
	Bermuda grass	
2.9	Bermuda grass	Good stand, cut to 0.04 m height
		Burned stubble.

Note: Covers classified were tested in experimental channels. Covers were green and generally uniform

* Reproduced from U.S. Department of Agriculture, Soil Conservation Service (1954), with a column added for curve index values. For Latin names of grasses, see Table 19.8

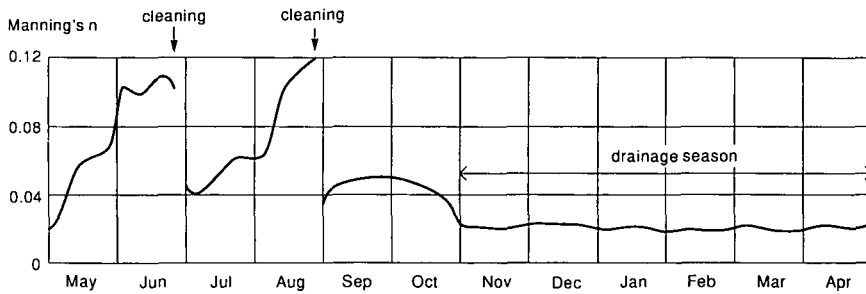

Figure 19.23 Influence of maintenance on the n value

19.4.4 Influence of Maintenance on the n Value

Equation 19.24 and Figure 19.22 show that the n value of a channel with vegetation increases as stem length increases through the growing season. Equation 19.14 shows that the discharge capacity of a channel decreases by $1/n$, so that the designer has to answer the neither clear nor simple question of which n value should be used in the channel design. Fortunately, the n value of a channel with vegetation can be kept within certain reasonable limits by regular maintenance. Figure 19.23 shows how cleaning out grasses affects the n value of a drainage canal in The Netherlands. Of course, one need not base the final design on the highest probable n value. In the Dutch example of Figure 19.23, the drain discharge is highest in winter, when grasses do not grow and the n value is relatively low. The influence of maintenance is further illustrated by Photos 19.5 and 19.6.



Photo 19.5 1980 Sept. 02 No maintenance since 1979
n = 0,340



Photo 19.6 1980 Dec. 18 Some time after maintenance
 $n = 0.040$ (Courtesy University of
 Agriculture, Wageningen)

19.4.5 Channels with Compound Sections

The cross-section of a channel may consist of several subsections, each subsection having a different roughness. For example, a main drain with a dry-season base flow and wet-season floods may have a compound cross-section like the one in Figure 19.24A. The shallow parts of the channel are usually rougher than the deeper central part. In such a case, it is a good idea to apply Manning's equation separately to each sub-area (A_1 , A_2 , and A_3). The total discharge capacity of the channel then equals the sum of the discharge capacities of the sub-areas.

The same can be said about trapezoidal canals, like the one in Figure 19.24B, that have thick vegetation on the banks while the earthen bottom remains clear. The flow through the areas marked A_z should then be calculated using a higher n value than the one used to calculate the flow through the area marked A_b . We can use the following relations

$$2A_z = (zy^2) + 0.2(by) \quad (19.24)$$

$$P_z = 2y\sqrt{z^2 + 1} \quad (19.25)$$

$$R_z = \frac{2A_z}{P_z} \quad (19.26)$$

$$A_b = A - 2A_z \quad (19.27)$$

$$P_b = b \quad (19.28)$$

$$R_b = \frac{A_b}{P_b} \quad (19.29)$$

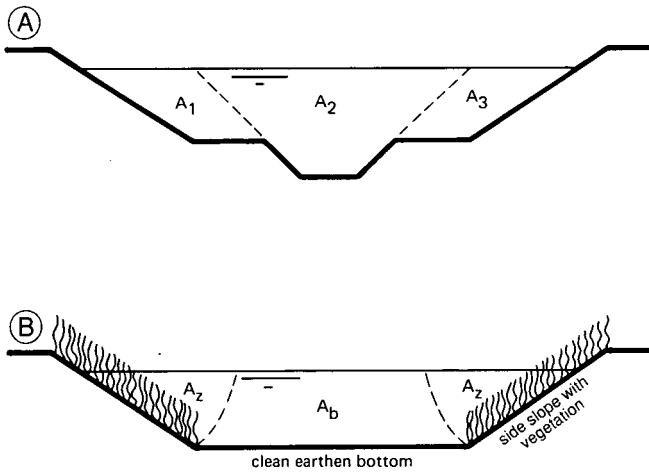

Figure 19.24 Compound canal sections

Calculate the discharge through areas $2A_z$ and A_b and add the results to find the discharge capacity of the canal. This is an iteration process, in which the water depths must be balanced.

19.5 Maximum Permissible Velocities

19.5.1 Introduction

The stability analysis of earthen channels and those with vegetation is important to the design of a drainage canal system. To evaluate such a system, an engineer needs to know the relationships between flowing water and the earthen materials forming the boundary of the channel. He also needs to understand the expected flow response when lining, vegetation, or other features are imposed. These relationships may be the determining factors for channel alignment, hydraulic gradient, and dimensions of the cross-section.

To analyze the stability of earthen channels, an engineer uses two fundamental approaches. In the first, he assumes that the bed and banks of the channel are mobile; in the second, that they are rigid. The conditions for these assumptions are described below.

Mobile Boundary

Stability of a channel with mobile bed and banks is attained when the rate at which sediment enters a channel reach from upstream is equal to the sediment transport capacity of that reach. Stability in such channels may be determined with the sediment transport equations in Section 19.5.2.

Rigid Boundary

Stability of a channel with rigid bed and banks is attained when the erosive forces

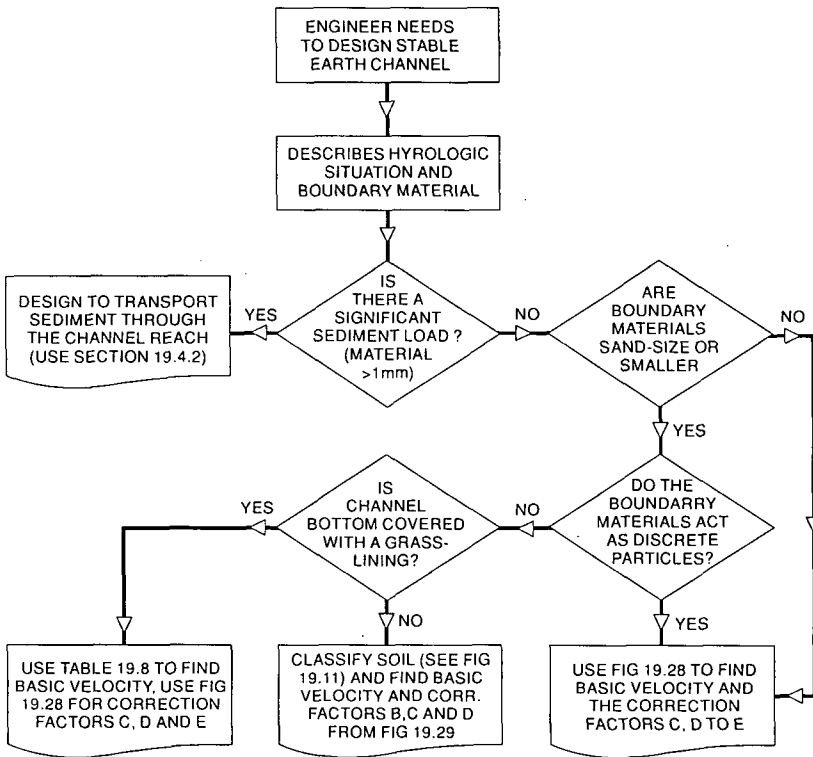

Figure 19.25 Procedural guide to find the maximum permissible velocity

of the flowing water are effectively resisted by the soil material forming the channel boundary. Properly designed channels of this type have a cross-section that remains essentially unchanged during all stages of flow. The stability of the channel boundaries can be evaluated with either the allowable velocity approach or the tractive stress approach.

Both approaches are appropriate for the design of drainage canals. A procedural guide is presented in Figure 19.25 to assist the designer in determining the maximum permissible velocity.

19.5.2 The Sediment Transport Approach

To consider the tractive force exerted by flowing water on a channel bed and bottom, we study a unit length of channel section like the one in Figure 19.26. For uniform flow to occur, the acceleration of flow must be zero, so that according to Newton's second law of motion, $F = ma$, the resultant of all forces acting on the water in the considered channel section should be zero. As the net hydraulic thrust in that section is zero, the net force in the flow direction is zero if

$$\tau = \rho g A \sin \alpha \tag{19.30}$$

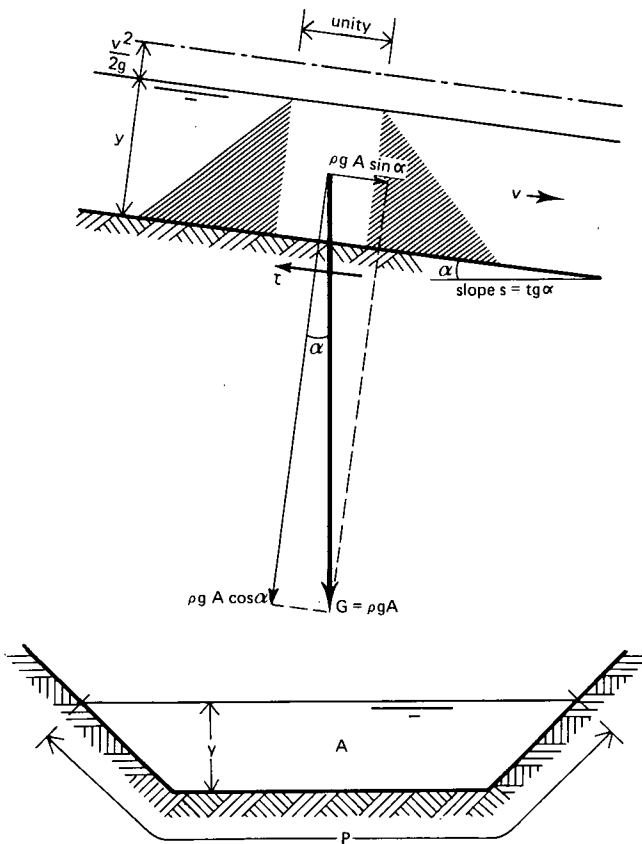

Figure 19.26 Definition sketch for the tractive stress equation

where

τ = tractive force (N)

α = canal slope angle (degrees)

If we assume that the canal slope is slight, we can write

$$\sin \alpha \approx \text{tg } \alpha = s$$

so that per unit length of canal the total tractive force, τ , may be expressed as

$$\tau = \rho g A s \quad (19.31)$$

Hence, the average tractive force per unit of the wetted perimeter P , known as tractive stress, equals

$$\tau_0 = \rho g R s \quad (19.32)$$

This stress acts on the discrete soil grains on the channel bed together with the gravity force, G per unit area.

For the two-dimensional example in Figure 19.27, the discrete grain will be in

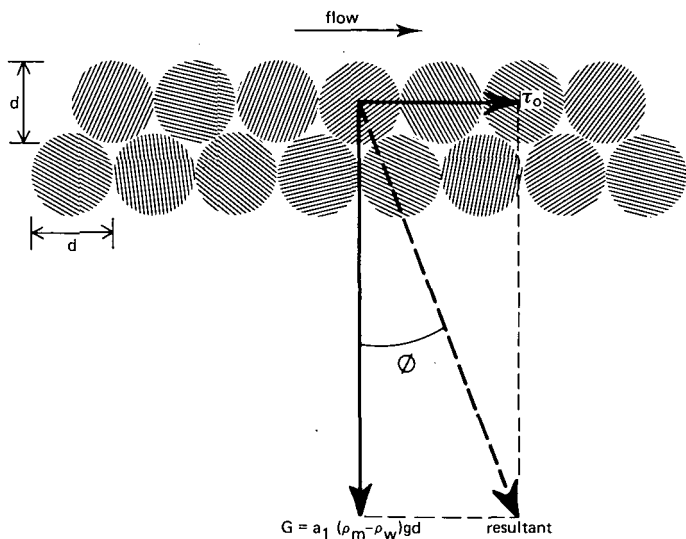

Figure 19.27 Forces acting on discrete channel bed material (two-dimensional)

equilibrium if

$$\frac{\tau_o}{G} = \frac{\rho_w g R_s}{a_1 (\rho_m - \rho_w) g d} \leq \text{tg } \phi \quad (19.33)$$

or

$$\frac{R_s}{\rho_r d} \leq \text{tg } \phi \quad (19.34)$$

where, in addition to the terms defined earlier

G = gravity force acting on the bed material per unit area (Pa)

ρ_m = mass density of the bed material (kg/m^3)

a_1 = percentage of solid material in a layer of thickness d_{50}

d = d_{50} = median grain diameter (m)

ϕ = angle of internal repose of the bed material (degrees)

$\rho_r = (\rho_m - \rho_w) / \rho_w$

A considerable amount of research has been done on this subject, providing that the bed material of a channel will not move if

$$Y = \frac{\mu R_s}{\rho_r d_{50}} \leq 0.047 \quad (19.35)$$

where

Y = flow parameter (-)

μ = so-called ripple factor, which is a factor of ignorance, used to obtain agreement between calculated and measured values of bed-load transport. It varies between 0.5 for slightly rough beds, to 1.0 for smoother bed forms

If the flow parameter, Y , exceeds 0.047, the sediment particles on the channel bed start to slide, roll or jump over and near the bed, generally in the form of moving bed shapes such as dunes and ripples. This is called bed-load transport, and it can be calculated with the equation of Meyer-Peter and Müller (1948), which reads

$$X = A_1 (Y - 0.047)^{3/2} \quad (19.36)$$

where

A_1 = a factor with an average value of 8
 X = the transport parameter (dimensionless), which is

$$X = \frac{T}{\sqrt{\rho_t g d_{50}^3}} \quad (19.37)$$

where

T = transport of soil material expressed in solid volume per second for one unit width of channel

The bed material load over the full width of the channel, expressed in m^3/s soils, equals

$$Q_m = T b \quad (19.38)$$

Equation 19.38 does not hold for the suspended load, i.e. the bed material being transported, because the gravity force is counterbalanced by the upward forces from turbulence. This means that while the grains make large or small jumps, they return eventually to the channel bed. A strict division between bed load and suspended load is not possible; in fact, the mechanics behind the two are related. It is therefore not surprising that the equation for the bed material load (bed load plus suspended load) is based on the above flow and transport parameters (Engelund and Hansen 1967)

$$X = 0.05 Y^{5/2} \quad (19.39)$$

Sediment transport also can be expressed in parts per million (ppm) by mass

$$\text{ppm} = \frac{Q_m \rho_m}{Q \rho_w} \times 10^6 \quad (19.40)$$

If the suspended sediment concentration equals or exceeds 20 000 ppm by mass, the flow is termed 'sediment-laden'. If the concentration is 1000 ppm or less by mass the flow is 'sediment-free'.

The calculation of flow rate and sediment transport through a channel with an essentially mobile bed and banks, is complex. Technical assistance from a qualified hydraulics laboratory is recommended for the design of important channels.

19.5.3 The Allowable Velocity Approach

This method of evaluating the erosion resistance of the rigid bed and banks of an earthen channel is based on data collected by Fortier and Scobey (1926), Lane (1952), by investigators in the U.S. Soil Conservation Service (1977), Eastgate (1969), Ree (1977), and others.

The maximum allowable velocity is determined in two steps; (i) find the basic allowable velocity for a straight channel with a water depth of 1 m, and (ii) determine some correction factors. Basic velocities are presented below for channels with bottom and sides of discrete earth materials, of coherent earth materials, and for grassed channels. Subsequently, we will treat five correction factors: (A) for the void ratio, (B) for the frequency of design flow, (C) for the design water depth, (D) for channel curvature, and (E) for the side slope of the channel bank.

Basic Allowable Velocity, v_b

The allowable velocity is strongly influenced by the concentration of fine material carried in suspension. There are two distinct types of flow with respect to sediment concentration:

- 1) Sediment-free flow; which is when material is carried in suspension at concentrations of 1000 ppm or less by mass. If sediment-free water flows with increasing velocity, its sediment transport capacity can only be reached if the water erodes material from the channel bed and banks;
- 2) Sediment-laden flow; which is when the water carries 20 000 ppm or more by mass of soil material. This high concentration will increase boundary stability, either through replacement of eroded material, or through formation of a protective cover because of settling. As a result, sediment-laden water has a significantly higher allowable flow velocity than sediment-free water.

Discrete Earthen Materials

Figure 19.28 gives the basic allowable velocities for channels with a boundary of discrete earthen materials. We can make a linear interpolation between the two curves for water with suspended sediment concentrations between 1000 ppm and 20 000 ppm. We can best estimate the sediment concentration by sampling channels in the area to be drained. If we cannot measure the concentration, we can calculate it with Equations 19.38 to 19.40 of Section 19.5.2. The basic velocity for discrete earthen materials should be corrected with the factors C, D and E.

Coherent Earthen Materials

In coherent earthen materials, the individual grains are cemented together so that the allowable velocity is greater than when the soil grain diameter alone is the determining factor. It is advisable to use the 'Unified Soil Classification System' as given in Section 19.3.4 to name the soil and determine the basic allowable velocity. Figure 19.29 gives the basic allowable velocity as a function of the plasticity index PI for each classification name (code). The basic velocity for coherent earthen materials should be corrected with factors A through D.

Grassed Channels

In Table 19.8, we can find the basic allowable velocities for channels where a grass lining was established on the bottom and side slopes upon construction, to act as a stabilizer. These velocities apply to average, uniform stands of each type of vegetal cover. Basic allowable velocities must be less than 1.5 m/s if there is no proper maintenance. The basic allowable velocities require correction with factors C, D, and E.

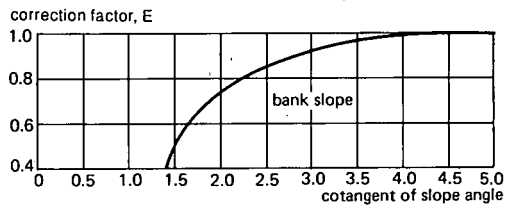
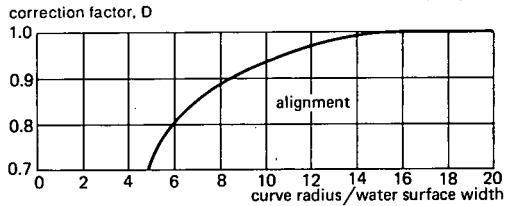
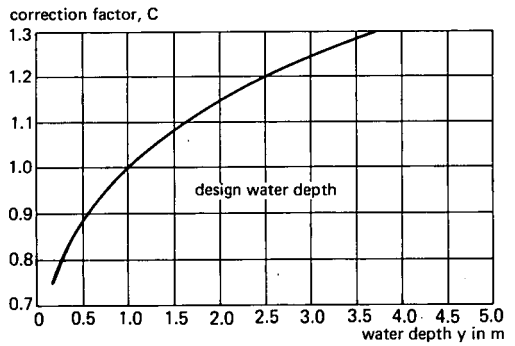
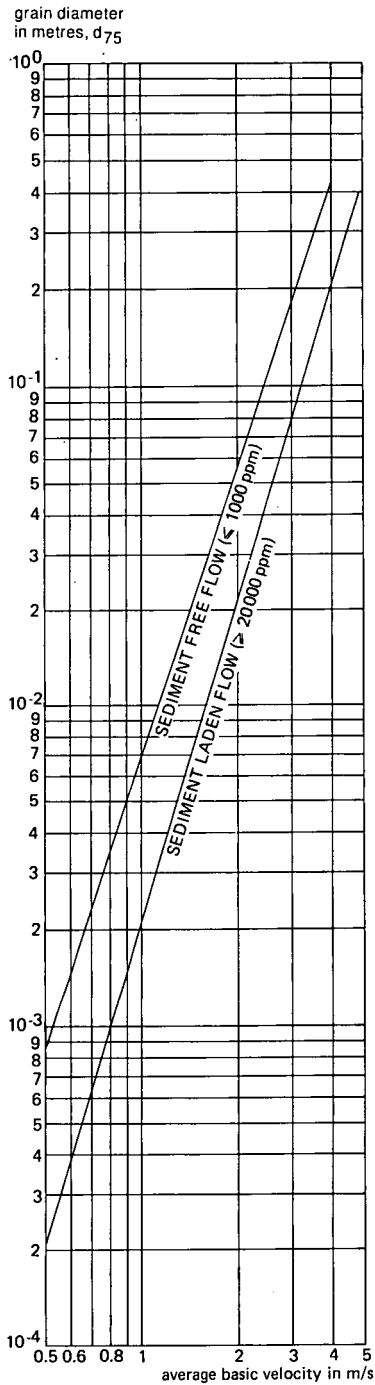

Figure 19.28 Basic allowable velocity, v_b , for discrete earthen materials and related correction factors C through E (adapted from USDA 1977)

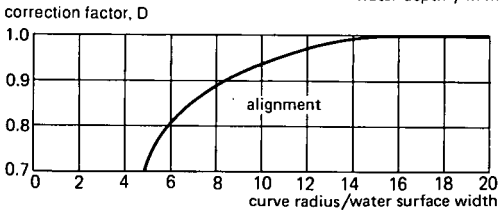
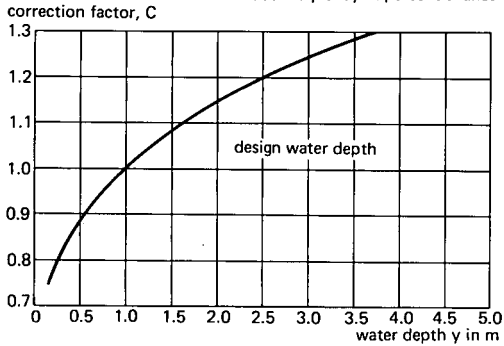
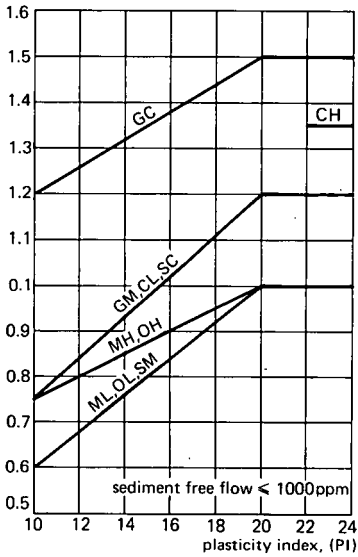
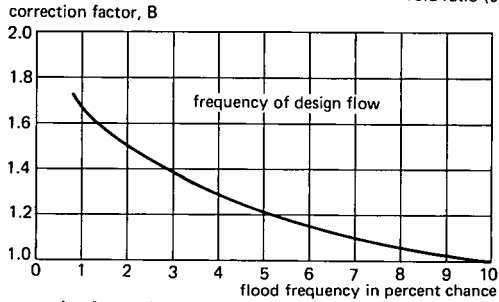
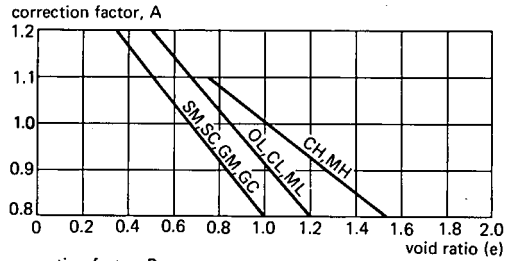
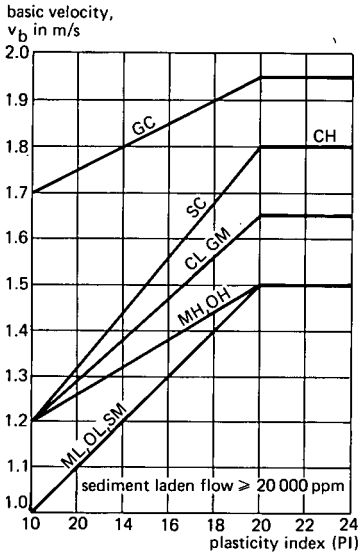

Figure 19.29 Basic allowable velocity, v_b , for coherent earthen materials, and related correction factors A through D (adapted from USDA 1977)

The 'erosion resistant soils' are probably clay loams or better, while the 'easily eroded soils' are probably as erosion resistant as a sandy loam soil.

The following conditions must be met before we can rely on grass lining as a stabilizer (Theuer 1979):

- The climate must be conducive to establishing and supporting a grass cover that will provide year-round protection;
- The soils in the channel boundary must be capable of supporting permanent vegetation;

Table 19.8 Basic allowable velocities for grass-lined channels (adapted from U.S. Dept. of Agriculture 1977, and Eastgate 1969)

Cover	Slope Range (s in %)	Basic allowable velocity (m/s)	
		Erosion resistant soils	Easily eroded soils
Kikuyu (<i>Pennisetum clandestinum</i>), Bermuda grass or African star grass (<i>Cynodon dactylon</i>)	0 - 5	2.40	1.80
	5 - 10	2.10	1.50
	> 10	1.80	1.20
Buffalo grass (<i>Buchloe dactyloides</i>), Kentucky bluegrass (<i>Poa pratensis</i>) Smooth brome (<i>Bromus inermis</i>) Blue grama (<i>Bouteloua gracilis</i>) Rhodes grass (<i>Chloris gayana</i>)	0 - 5	2.10	1.50
	5 - 10	1.80	1.20
	> 10	1.50	0.90
	Grass mixture	0 - 5	1.50
	5 - 10	1.20	0.90
	Do not use on slopes steeper than 10%		
<i>Lespedeza sericea</i> , Weeping love grass (<i>Eragrostis curvula</i>), Kudzu (<i>Pueraria thunbergiana</i>), Queensland Bluegrass (<i>Dichanthium sericeum</i>), Alfalfa (<i>Medicago sativa</i>), Crabgrass (<i>Digitaria sanguinalis</i>)	0 - 5	1.00	0.75
	Do not use on slopes steeper than 5%, except for side-slopes in a combination channel		
Annuals - used on mild slopes or as temporary protection until permanent covers are established: Common Lespedeza (<i>Lespedeza striata</i>), Sudan grass (<i>Sorghum sudanense</i>)	0 - 5	1.00	0.75
	Use on slopes steeper than 5% is not recommended		

- The bed of the channel and that portion of the side-slope under base flow must be stable. Armouring or rip-rap may be needed to stabilize these parts of the channel boundary; or flow must be intermittent enough to allow vegetation to be established;
- Design flows in the channel must not cause scouring. Vegetation should never be intended as a stabilizer for sloughing banks or banks undermined by seepage.

Adjustments in the basic allowable velocity, v_b , to reflect the modifying effects of the void ratio, frequency of design flow, design water depth, curvature in alignment, and channel bank slope, should be made with the correction factors A through E of Figures 19.28 and 19.29. They are:

- A) The void ratio correction factor, which applies to coherent earthen materials only, and corrects for the compactness of the soil. The void ratio (e) in Figure 19.29 is the ratio of (i) the volume of void space to (ii) the volume of solid particles in a given soil mass. This factor decreases with the increase of void space;
- B) The frequency correction factor, which applies to coherent earthen materials only,

and is based on the assumption that an infrequent discharge causes little erosion damage in channels with coherent boundaries. Channels designed for flood discharges of less than 10% frequency, however, should be checked for stability at the 10% chance frequency discharge and related water depth;

- C) The water depth correction factor, which is needed because the initial basic velocities are valid only for channels with a depth of 1 m ($y = 1.0$ m). A greater water depth ($y > 1$ m) causes lower velocities along the channel boundary than shallow depth ($y < 1$ m) if the average velocity, $v = Q/A$, is the same. This factor applies to channels in all soils;
- D) The channel curvature correction factor, which applies to all channels in all soils. It is necessary because the spiral flow in curves tends to erode the outer channel embankment. For sharp curves, it can be a good solution to armour the outer embankment instead of lowering the average velocity (see Photo 19.4);
- E) The bank slope correction factor, which applies to channels whose banks are constructed in earth with discrete particles. Because of the lack of cohesion, these particles tend to roll down the bank slope.

The maximum allowable velocity, v_{max} , is found by multiplying the basic allowable velocity, v_b , by the relevant correction factors.

For discrete earthen materials and grassed channels (Figure 19.29 and Table 19.8)

$$v_{max, discr.} = v_b \times CDE \quad (19.41)$$

For coherent earthen materials (Figure 19.29)

$$v_{max, coh.} = v_b \times ABCD \quad (19.42)$$

19.6 Protection Against Scouring

19.6.1 Field of Application

Equation 19.35 illustrates that the discrete earthen material on the bed of a channel starts to move if the flow parameter, Y , exceeds 0.047. The designer can reduce the numerical value of $Y = \mu R s / \rho_r d_{50}$ in three ways:

- By selecting a high b/y ratio for the channel so that the hydraulic radius, R , is relatively low (see Section 19.3.5);
- By selecting a flatter hydraulic gradient, s , for the channel and using a drop structure to dissipate the remainder of the hydraulic energy (see Section 19.7.1);
- By armouring the channel bed and banks with a material having a discrete particle diameter large enough to remain stable.

The remainder of Section 19.6 will deal with the latter possibility.

19.6.2 Determining Stone Size of Protective Lining

Channel with Uniform Flow

We can determine the size of the discrete particles (called rip-rap) of the protective

lining of a channel with uniform flow by using the v_b versus d_{75} relationship of Figure 19.28 and the correction factors C, D, and E.

For example: a trapezoidal channel with a design water depth, $y = 1.50$ m, a curve radius/water surface width ratio of 12, and a cotangent of the side slope angle, $z = 2.0$, transports sediment-free water at an average velocity, $v = 2.00$ m/s. What is the diameter, d_{75} , required for the rip-rap stones of the protective lining?

Step 1

Find the correction factors C, D, and E of Figure 19.28:

For $y = 1.50$ m,	$C = 1.08$
If radius/width is 12,	$D = 0.96$
For $z = 2.0$,	$E = 0.71$

Step 2

Working in the reverse order of Section 19.5.3, divide the actual average velocity by the correction factors to find the basic allowable velocity v_b

$$v_b = \frac{v}{CDE} \quad (19.43)$$

Hence, the basic allowable velocity is

$$v_b = 2.00 / (1.08 \times 0.96 \times 0.71) = 2.72 \text{ m/s}$$

Step 3

Enter Figure 19.28 with the calculated value of v_b and find $d_{75} = 0.14$ m.

Downstream of a Structure

A protective lining may also be needed for the channel bed and banks immediately downstream of a structure. The erosive currents leaving the downstream end of a weir, flume, culvert, and so on, often damage the earthen channel. This can be prevented by increasing the diameter of the rip-rap stones (discrete particle size) over a short channel reach. The length of this reach is affected by several factors. As a rule of thumb, do not choose a length of rip-rap that is (i) less than 4 times the (maximum) anticipated water depth in the channel downstream of the structure, (ii) less than the length of the earthen transition between structure and channel, (iii) or less than 1.50 m.

Flow leaving a structure is characterized by a variable combination of factors such as local velocity, flow direction, turbulence, and waves. Because of the unpredictable combination of these factors, the velocity at which water will strike the rip-rap is difficult to predict, but it will certainly be higher than that along the boundary of a channel with uniform flow. As a result, the size of the rip-rap stones downstream of a structure is significantly larger than that in a channel with uniform flow.

For practical purposes, we can find the grain/stone diameter needed downstream of a structure from Figure 19.30. Calculate the average velocity above the end sill of the structure by dividing the discharge by the cross-sectional area of flow above this

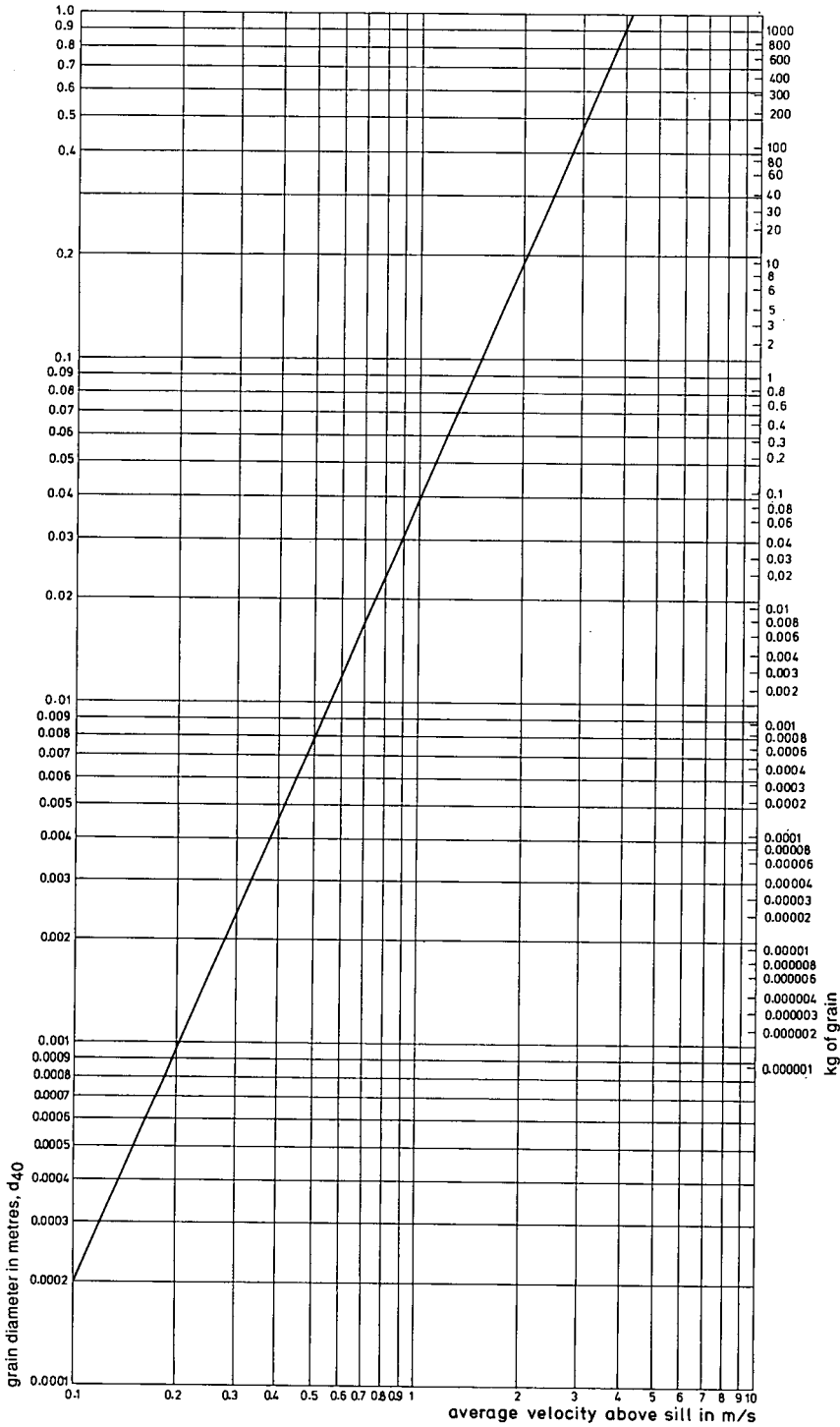

Figure 19.30 Relation between the average velocity above the end sill of a structure and stable grain size (Bos 1989)

sill. Figure 19.30 gives the d_{40} of the rip-rap mixture, which means that more than 60% should consist of stones that are as nearly alike as practicable in length, width, and thickness, and of curve size or larger; or they should be of curve weight or heavier, and not flat slabs.

19.6.3 Filter Material Placed Beneath Rip-Rap

If the rip-rap stones of a protective lining are laid immediately on top of the fine material (subgrade) in which the canal is excavated, grains of this subgrade will wash through the openings between the stones. This process is due partly to the turbulent flow of canal water in and out of the voids between the stones, and partly to the inflow of water that leaks around the structures or flows into the drain.

To avoid damage to the rip-rap from washing of the subgrade, there must be a filter between the two (Figure 19.31). The protective construction as a whole and each separate layer must be sufficiently permeable to water entering the canal through its bed or banks. Further, fine material from an underlying filter layer or the subgrade must not be washed into the voids of a covering layer.

Permeability to Water

To maintain sufficient permeability of the protective construction shown in Figure 19.31, the following d_{15}/d_{15} ratios should have a value of between 5 and 40 (U.S. Bureau of Reclamation 1973, Bertram 1940)

$$\frac{d_{15} \text{ layer 3}}{d_{15} \text{ layer 2}} \text{ and } \frac{d_{15} \text{ layer 2}}{d_{15} \text{ layer 1}} \text{ and } \frac{d_{15} \text{ layer 1}}{d_{15} \text{ subgrade}} = 5 \text{ to } 40 \quad (19.44)$$

where d_{15} equals the diameter of the sieve opening, through which 15% of the total sample weight passes. Depending on the shape and gradation of the grains in each layer, we can narrow the range of the ratios as follows:

- Homogeneous round grains (gravel) 5 - 10
- Homogeneous angular grains (broken gravel, rubble) 6 - 20
- Well-graded grains 12 - 40

To prevent the filter from clogging, it is also advisable that in each layer

$$d_5 \geq 0.75 \text{ mm} \quad (19.45)$$

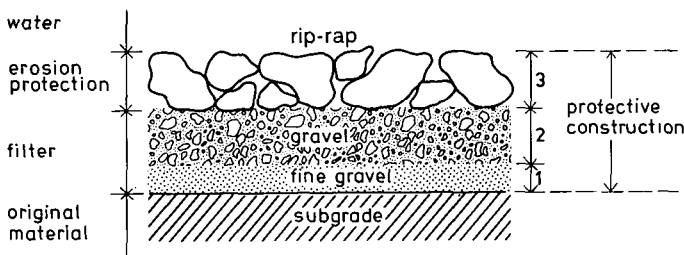

Figure 19.31 Example of filter between riprap and original material (subgrade) in which canal is excavated

Stability of each Layer

To prevent the loss of fine material from an underlying filter layer or the subgrade through the openings in a covering layer, two requirements must be met:

1) The following d_{15}/d_{85} ratios should not exceed 5 (Bertram 1940)

$$\frac{d_{15} \text{ layer 3}}{d_{85} \text{ layer 2}} \text{ and } \frac{d_{15} \text{ layer 2}}{d_{85} \text{ layer 1}} \text{ and } \frac{d_{15} \text{ layer 1}}{d_{85} \text{ subgrade}} \leq 5 \quad (19.46)$$

2) And the d_{50}/d_{50} ratios should range between 5 and 60 (U.S. Army Corps of Engineers 1955)

$$\frac{d_{50} \text{ layer 3}}{d_{50} \text{ layer 2}} \text{ and } \frac{d_{50} \text{ layer 2}}{d_{50} \text{ layer 1}} \text{ and } \frac{d_{50} \text{ layer 1}}{d_{50} \text{ subgrade}} = 5 \text{ to } 60 \quad (19.47)$$

As before, the ratio in Equation 19.47 depends on the shape and gradation of the grains:

- Homogeneous round grains (gravel) 5 - 10
- Homogeneous angular grains (broken gravel, rubble) 10 - 30
- Well-graded grains 12 - 60

The above requirements describe the sieve curves of the successive filter layers. If we know the sieve curve of the rip-rap and the subgrade, we can plot other layers. Figure 19.32 shows the sieve curves of a construction consisting of rip-rap and two underlying filter layers.

19.6.4 Fitting of Sieve Curves

The procedure for dimensioning a protective construction in a channel with uniform flow is similar to that for dimensioning such a construction immediately downstream of a structure. The only difference is that, for a channel with uniform flow, we must

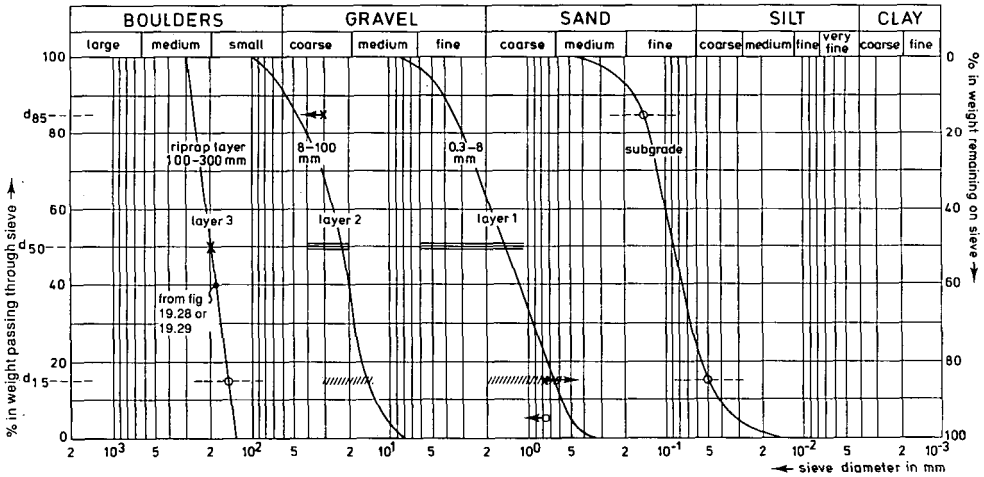

Figure 19.32 Sieve curves of a protective construction

use Figures 19.28 and 19.29 to find the size of the rip-rap stones, while for downstream of a structure, we must use Figure 19.30. In the following steps, we shall assume that the protective construction is downstream of a structure.

- 1) Determine and plot the sieve curve of the subgrade. For the example of Figure 19.32 we read that:

$$d_{15} = 0.05 \text{ mm}$$

$$d_{50} = 0.09 \text{ mm}$$

$$d_{85} = 0.15 \text{ mm}$$

Note that the subgrade is well-graded.

- 2) Use Figure 19.30 to determine the minimum d_{40} of the rip-rap layer. For example, if the velocity over the end sill is 1.8 m/s, then $d_{40} > 0.17 \text{ m}$ or 170 mm. Check which material is – or can be made available and plot its sieve curve in Figure 19.32 (rip-rap layer 100 to 300 mm). The curve of the selected material shows that the diameter of the rounded rip-rap mixture is rather homogeneous:

$$d_{15} = 150 \text{ mm}$$

$$d_{40} = 180 \text{ mm}$$

$$d_{50} = 200 \text{ mm}$$

$$d_{85} = 270 \text{ mm}$$

- 3) Use the first part of Equation 19.44 to determine a range for the d_{15} of layer 2 by

$$\frac{d_{15} \text{ layer 3}}{d_{15} \text{ layer 2}} = \frac{150 \text{ mm}}{d_{15} \text{ layer 2}} = 5 \text{ to } 10 \text{ (homogeneous rounded grains)}$$

or

$$15 \text{ mm} < d_{15} \text{ layer 2} < 30 \text{ mm}$$

Plot this range into Figure 19.32. (////).

- 4) Use the last part of Equation 19.46 to determine a range for the d_{15} of layer 1 by

$$\frac{d_{15} \text{ layer 1}}{d_{15} \text{ subgrade}} = \frac{d_{15} \text{ later 1}}{0.05 \text{ mm}} = 12 \text{ to } 40 \text{ (well-graded)}$$

or

$$0.6 \text{ mm} < d_{15} \text{ layer 1} < 2.0 \text{ mm}$$

Plot this range into Figure 19.32. (////).

- 5) Use the first part of Equation 19.46 to find and plot

$$d_{85} \text{ layer 2} > 30 \text{ mm} (\leftarrow x)$$

- 6) Use the last part of Equation 19.46 to find and plot

$$d_{15} \text{ layer 1} \leq 0.75 \text{ mm} (x \rightarrow)$$

When we have plotted this, we shall see that the range has narrowed to 0.6 to 0.75 mm. From Equation 19.45 we find

$$d_5 \text{ layer 1} \geq 0.75 \text{ mm} (\leftarrow o)$$

These two criteria are difficult (if not impossible) to attain and must be relaxed slightly.

- 7) Following a procedure similar to Steps 3 and 4, use Equation 19.47 to find and plot

$$20 \text{ mm} \leq d_{50} \text{ layer 2} \leq 40 \text{ mm}$$

and

$$1.1 \text{ mm} \leq d_{50} \text{ layer 1} \leq 5.4 \text{ mm}$$

- 8) Find locally available materials that have a grain size distribution within the ranges summarized in Figure 19.32. To provide a stable and effective filter, the sieve curves of the subgrade and filter layers should run about parallel for the small-diameter grains.
- 9) Determine the d_{15} , d_{50} , and d_{85} of the tentatively selected mixtures in filter layers 1 and 2. Repeat Steps 3 through 7 to check if these limitations hold for the selected mixtures. If not, shift the sieve curves slightly or add an additional filter layer.

19.6.5 Filter Construction

To obtain a fair grain size distribution throughout a filter layer, each layer should be sufficiently thick. The following thicknesses must be regarded as a minimum for filters constructed under dry conditions:

- Sand, fine gravel 0.05 to 0.10 m;
- Gravel 0.10 to 0.20 m;
- Stones 1.5 to 2 times the largest stone diameter.

For filters constructed under water, these thicknesses have to be increased considerably to compensate for irregularities in the subgrade and because it is more difficult to apply an even layer.

There are many variations on the basic filter construction. One or more of the layers often are replaced with other materials. With some protective linings, only the rip-rap layer is maintained, while the underlying filter layers are replaced by one single layer, e.g.:

- Concrete blocks on a nylon filter;
- Stones on braided hardwood strips on a plastic filter;
- Gabions on fine gravel;
- Nylon-sand mattresses.

The usual difficulty with these variants is their perviousness to the underlying material. As a rule, the openings in such a layer should not be greater than $0.5 \times d_{85}$ of the underlying material. If the openings are greater, one should not replace all the underlying layers, but maintain as many (usually one) as are needed to prevent the subgrade from being washed through the combined layer. Many manufacturers produce so called geo-textiles, which are very suitable as filter layer. The related documentation should give the above product properties. Such documentation commonly gives various design examples.

The protective construction is most subject to damage at structure-to-filter and filter-to-unprotected-channel 'joints'. This is because the filter layer is likely to subside even though the structure itself is well founded. Underlying material (subgrade) may be washed out at these joints if no special measures are taken. It is recommended

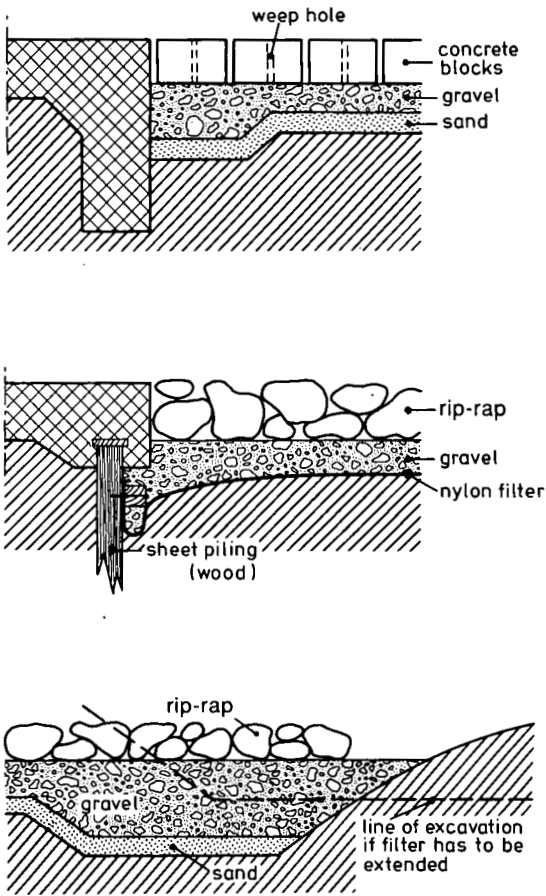

Figure 19.33 Filter construction details (after Van Bendegom 1969)

that the thickness of the filter construction be increased at these places. Some examples of common constructional details are shown in Figure 19.33.

19.7 Energy Dissipators

19.7.1 Introduction

As we saw in Section 19.6.1, channels with a hydraulic gradient flatter than the land slope require structures that dissipate surplus energy. Such a structure can be divided into four parts:

- 1) The part upstream of the (control) section, where flow is accelerated to critical flow;
- 2) The part in which water is conveyed to the anticipated lower elevation;
- 3) The part immediately downstream of section U (Figure 19.34), where energy is dissipated;
- 4) The channel reach that requires a construction to protect it against erosion.

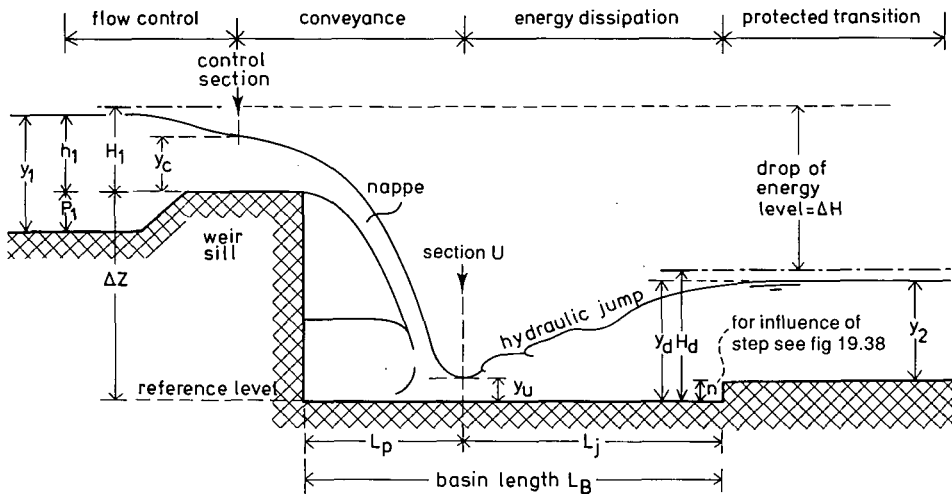

Figure 19.34 Illustration of terminology for a straight drop structure

In the upstream part of the structure, the flow over the sill is controlled. The head, h_1 , versus discharge, Q , relationship of this control is a function of the sill height, p_1 , the longitudinal profile of the weir crest, the shape of the control section perpendicular to the flow, and the width of this control section, b . Each combination of these four properties yields one out of an infinite number of combinations of h_1 and Q (Bos 1989).

Further, the channel upstream of the structure has a discharge capacity that can be characterized by the water depth, y_1 , versus discharge, Q , relationship, written as

$$Q = K_1 y_1^u \quad (19.48)$$

where

K_1 = a factor which varies with the shape and hydraulic properties of the channel

u = the exponent to y_1 , varying between 1.7 for trapezoidal channel with wide bottom, to 2.3 for a narrow-bottomed channel

To avoid sedimentation upstream of the structure, the control should be dimensioned so that the head-discharge curve of the structure coincides with the y_1 versus Q curve of the channel throughout the flow range with sediment transport (see Figure 19.35).

For a broad-crested weir sill with a rectangular control section perpendicular to the flow (Figure 19.34), the head-discharge relationship reads

$$Q = C_d C_v \frac{2}{3} \sqrt{\frac{2}{3}} g b_c h_1^{1.5}$$

where

C_d = discharge coefficient (-)

C_v = approach velocity coefficient (-)

b_c = width of control section (m)

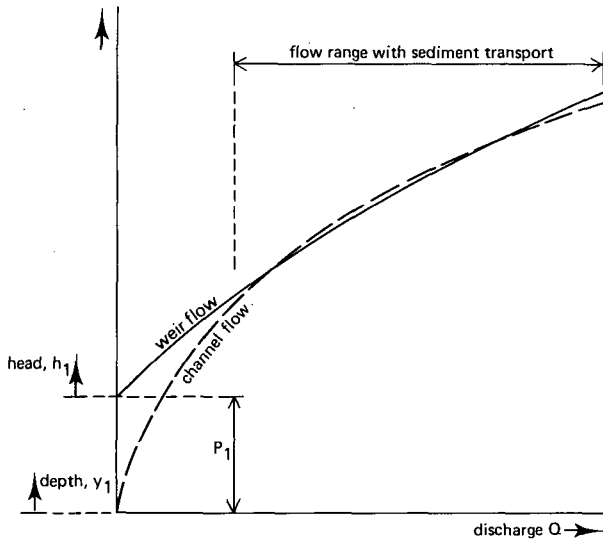

Figure 19.35 Matching of $Q-y_1$ and $Q-h_1$ curves for a structure with sediment transport

The product of the discharge- and the approach velocity coefficients may, for general design purposes, be taken as $C_d C_v \approx 1.0$.

For detailed information on the head-discharge relationship of control structures, consult Bos 1989; and Bos, Replogle, and Clemmens 1984.

We can dimension the conveyance and energy dissipation parts of the structure in relation to the following variables (Figure 19.34):

- H_1 = upstream sill-referenced energy head (m)
- ΔH = change in energy head across structure (m)
- H_d = downstream energy head (m)
- q = discharge per unit width of sill (m^2/s)
- g = acceleration due to gravity, being $9.81 m/s^2$
- n = step height (m)
- y_u = flow depth at section U (m)
- y_d = downstream flow depth relative to basin floor (m)
- y_2 = flow depth in downstream channel (m)

These variables can be combined to calculate H_1 and H_d , after which we can make a first estimate of the drop height

$$\Delta Z = (\Delta H + H_d) - H_1 \quad (19.50)$$

Subsequently, we can estimate the flow velocity and depth at section U with

$$v_u = \sqrt{2g\Delta Z} \quad (19.51)$$

and with the continuity equation, we calculate

$$y_u = \frac{q}{v_u} \quad (19.52)$$

The flow at section U can best be characterized by the dimensionless Froude number

$$Fr_u = \frac{v_u}{\sqrt{gy_u}} \tag{19.53}$$

This Froude number classifies the flow phenomena at the downstream side of the structure and enables the selection of a satisfactory alternative of this part of the structure. From a practical viewpoint, we can state:

- 1) If $Fr_u \leq 2.5$, no baffles or special devices are required, but the downstream channel should be sufficiently protected against scouring over a length as specified in Section 19.6.2 (Gebler 1991);
- 2) If Fr_u ranges between 2.5 and 4.5, the hydraulic jump is not well stabilized. The entering jet oscillates from bottom to surface and creates waves with irregular period in the downstream channel. It is therefore advisable to dissipate energy through increased turbulence and not to rely on the jump;
- 3) If $Fr_u \geq 4.5$, a stable jump will be formed, which can dissipate energy effectively.

For a known discharge per unit width, q , and an estimated drop height, ΔZ , Figure 19.36 gives an indication of which structure is appropriate. A more detailed hydraulic design will give a better ΔZ value, which may lead to another structure.

Construction of a complex energy dissipator for a low discharge and drop but high

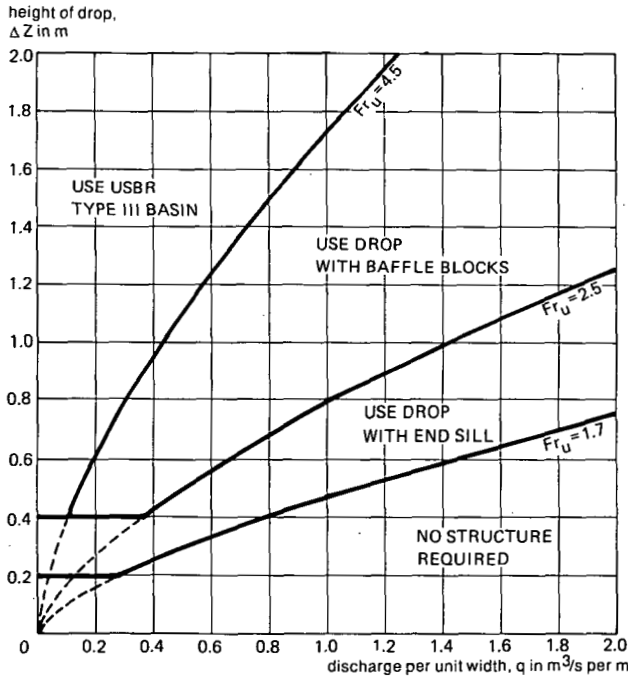

Figure 19.36 Diagram for estimating the type of structure to be used prior to a detailed design, (Bos, Replogle, and Clemmens 1984)

Froude number is impractical, because the energy to be dissipated is low. Thus, we have placed limits on the minimum drop height for these structures at 0.2 and 0.4 m, as shown in Figure 19.36. Moreover, large straight drops often require massive structures that may be overly expensive and hydraulically unreliable. So, it is better not to use straight drops of more than 1.5 m, except under special circumstances. These limits on drop height, energy drop, and Froude number, are not absolute, but give the designer practical limits for quick decision-making.

The energy dissipators described in this Section may not be suitable for every project, and they certainly do not exhaust the possibilities open to the designer. For further information on straight drops, end sills, baffle blocks, and tapered sidewalls, to name but a few, see Peterka (1964), Aisenbrey et al. (1974), Brakensiek et al. (1979) and U.S. Bureau of Reclamation (1973).

19.7.2 Straight Drop

The free-falling nappe strikes the basin floor and turns downstream at section U (Figure 19.34). Because of the impact of the nappe and the turbulent circulation in the pool beneath it, some energy is dissipated. Further energy is dissipated in the hydraulic jump downstream of section U. The remaining downstream energy head, H_d , does not vary greatly with the ratio $\Delta Z/H_1$, and is equal to about $1.67H_1$ (adapted from Henderson 1966). This value provides a satisfactory estimate for the level of the basin floor below the energy level of the downstream canal. The hydraulic dimensions of a straight drop can be related to the Froude number at section U. The Froude number can be related directly to the straight drop geometry with the length ratios $y_d/\Delta Z$ and $L_p/\Delta Z$ (Figure 19.37).

We can calculate the length of the undisturbed hydraulic jump, L_j , downstream of Section U with the following (Henderson 1966)

$$L_j = 6.9 (y_d - y_u) \quad (19.54)$$

It is important to realize that the downstream water depths, y_d and y_2 , are caused not by the drop structure, but by the flow characteristics of the downstream canal. If these characteristics produce the required depth, y_d , a jump will form; otherwise it will not form, and not enough energy will be dissipated within the basin. Additional steps, such as lowering the basin floor and adding an end sill, must be taken to assure adequate energy dissipation.

Because of seasonal changes in the hydraulic resistance of the downstream canal, however, the flow velocity as calculated by Manning's equation changes with the water depth, y_d . The jump thus tends to drift up and down the canal. This unstable behaviour is often undesirable, and can be suppressed by increasing the flow resistance with an abrupt step at the end of the basin. Usually, this step is constructed at a distance of

$$L_n = 5 (n + y_2) \quad (19.57)$$

downstream of section U. For design purposes, Figure 19.38 can be used to determine the largest required value of n , if $Fr_u = v_u/\sqrt{gy_u}$, y_u , and y_2 are known.

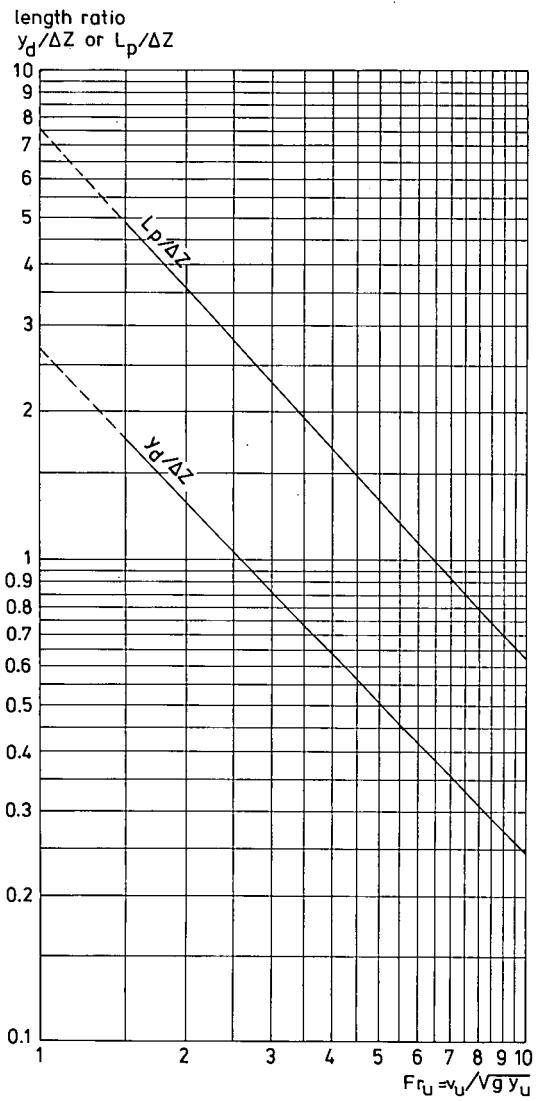

Figure 19.37 Dimensionless plot of straight drop geometry (from Bos, Replogle, and Clemmens 1984)

If the above structure discharges into a relatively wide canal or if the downstream water depth, y_2 , is not determined by the flow over the structure but by a downstream control, the step height, n , must also be determined for lower flow rates and the expected value of y_2 . The largest n value must be used for the design.

The total basin length, L_B , of the structure is greatly influenced by the length, L_n . As we have seen, the hydraulic jump can be stabilized and shortened by increasing the flow resistance downstream of section U. To shorten the basin downstream of section U, the hydraulic resistance can be further increased by placing baffle blocks on the basin floor.

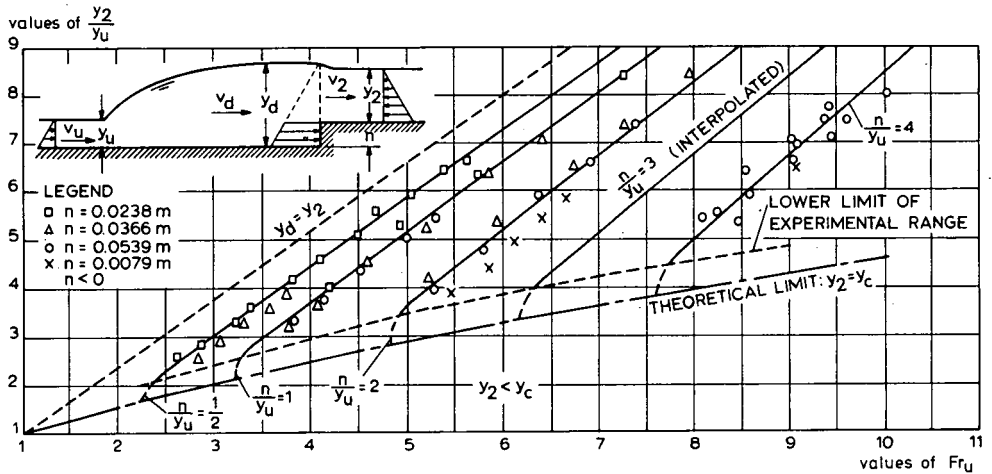

Figure 19.38 Experimental relations between Fr_u , y_2/y_u , and n/y_u for an abrupt step (Forster and Skrinde 1950)

19.7.3 Baffle Block Type Basin

As mentioned above, the basin length of the energy dissipator can be shortened by adding baffle blocks to the basin floor. Although this is a significant advantage, the baffle blocks have one major drawback: they collect all types of floating and suspended debris, which may lead to overtopping of the basin and damaging of the baffle blocks. To function properly therefore these basins require regular cleaning.

The baffle block type basin was developed for low drops in the energy level, and it dissipates energy reasonably well for a wide range of downstream water depths. Energy is dissipated principally by turbulence induced by the impingement of the incoming flow upon the baffle blocks. The required downstream water depth therefore can be slightly less than for a straight drop, but can vary independently of the drop height, ΔZ . To function properly, the downstream water depth, y_d must not be less than $1.45H_1$ while at Q_{max} the Froude number, Fr_u , should not exceed 4.5.

Upstream of section U, we can determine the length, L_p , with Figure 19.37. The linear proportions of the basin downstream from section U as a function of H_1 are shown in Figure 19.39.

19.7.4 Inclined Drop

Downstream of the control of a drop structure, a sloping face, guiding the overfalling nappe, is a common design feature, especially if the energy drop exceeds 1.5 m. In drop structures, the slope of the downstream face is often as steep as possible. If a sharp-edged, broken plane transition is used between the control and the downstream face, it is advisable to use a slope no steeper than 2 to 1 (see Figure 19.40). This will prevent flow separation at the sharp edge. If a steeper slope (1 to 1) is required, the

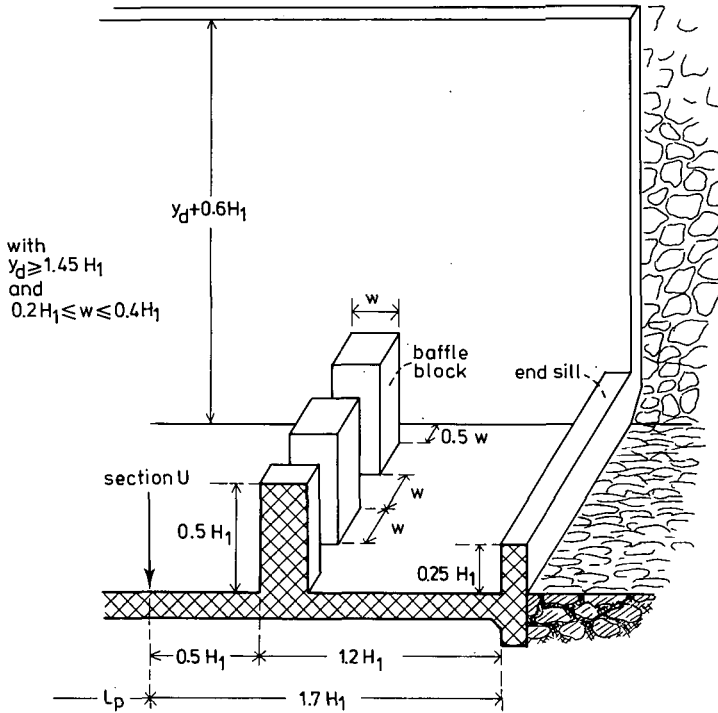

Figure 19.39 Section over center line of the baffle block type basin downstream from section U (Donnelly and Blaisdell 1954)

sharp edge should be replaced by a transitional curve with a radius of $r \approx 0.5 H_1$ (Figure 19.40).

Values of y_u and H_d that are suitable for the basin downstream of Section U can be determined from Table 19.9. In this context, note that the energy level, H_u , of the nappe entering the basin at Section U has a much higher value if there is a sloping downstream face than if the nappe were free-falling, with the straight drop. This is because with a straight drop, energy is dissipated by the impact of the nappe on the basin floor and the turbulent circulation of water in the pool beneath the nappe. With the inclined drop there is only some dissipation due to friction and turbulent flow over the sloping face.

19.7.5 USBR Type III Basin

In selecting a basin lay-out, note that the basin with baffle blocks in Figure 19.39 was designed to dissipate energy by turbulence. Such a basin is satisfactory if the Froude number at maximum anticipated flow, Fr_u , does not exceed 4.5 (see Figure 19.36). For higher Froude numbers, use the USBR Type III basin shown in Figure 19.41.

Table 19.9 Dimensionless ratios for hydraulic jumps (from Bos, Replgle and Clemmens 1984)

$\Delta H/H_1$	y_d/y_u	y_u/H_1	$v_u^2/2gH_1$	H_u/H_1	y_d/H_1	$v_d^2/2gH_1$	H_d/H_1
0.2446	3.00	0.3669	1.1006	1.4675	1.1006	0.1223	1.2229
0.2688	3.10	0.3599	1.1436	1.5035	1.1157	0.1190	1.2347
0.2939	3.20	0.3533	1.1870	1.5403	1.1305	0.1159	1.2464
0.3198	3.30	0.3469	1.2308	1.5777	1.1449	0.1130	1.2579
0.3465	3.40	0.3409	1.2749	1.6158	1.1590	0.1103	1.2693
0.3740	3.50	0.3351	1.3194	1.6545	1.1728	0.1077	1.2805
0.4022	3.60	0.3295	1.3643	1.6938	1.1863	0.1053	1.2916
0.4312	3.70	0.3242	1.4095	1.7337	1.1995	0.1030	1.3025
0.4609	3.80	0.3191	1.4551	1.7742	1.2125	0.1008	1.3133
0.4912	3.90	0.3142	1.5009	1.8151	1.2253	0.0987	1.3239
0.5222	4.00	0.3094	1.5472	1.8566	1.2378	0.0967	1.3345
0.5861	4.20	0.3005	1.6407	1.9412	1.2621	0.0930	1.3551
0.6525	4.40	0.2922	1.7355	2.0276	1.2855	0.0896	1.3752
0.7211	4.60	0.2844	1.8315	2.1159	1.3083	0.0866	1.3948
0.7920	4.80	0.2771	1.9289	2.2060	1.3303	0.0837	1.4140
0.8651	5.00	0.2703	2.0274	2.2977	1.3516	0.0811	1.4327
0.9400	5.20	0.2639	2.1271	2.3910	1.3723	0.0787	1.4510
1.0169	5.40	0.2579	2.2279	2.4858	1.3925	0.0764	1.4689
1.0957	5.60	0.2521	2.3299	2.5821	1.4121	0.0743	1.4864
1.1763	5.80	0.2467	2.4331	2.6798	1.4312	0.0723	1.5035
1.2585	6.00	0.2417	2.5372	2.7789	1.4499	0.0705	1.5203
1.3429	6.20	0.2367	2.6429	2.8796	1.4679	0.0687	1.5367
1.4280	6.40	0.2321	2.7488	2.9809	1.4858	0.0671	1.5529
1.5150	6.60	0.2277	2.8560	3.0837	1.5032	0.0655	1.5687
1.6035	6.80	0.2235	2.9643	3.1878	1.5202	0.0641	1.5843
1.6937	7.00	0.2195	3.0737	3.2932	1.5368	0.0627	1.5995
1.7851	7.20	0.2157	3.1839	3.3996	1.5531	0.0614	1.6145
1.8778	7.40	0.2121	3.2950	3.5071	1.5691	0.0602	1.6293
1.9720	7.60	0.2085	3.4072	3.6157	1.5847	0.0590	1.6437
2.0674	7.80	0.2051	3.4723	3.7254	1.6001	0.0579	1.6580
2.1641	8.00	3.6343	3.6343	3.8361	1.6152	0.0568	1.6720
2.2620	8.20	3.7490	3.7490	3.9478	1.6301	0.0557	1.6858
2.3613	8.40	3.8649	3.8649	4.0607	1.6446	0.0548	1.6994
2.4615	8.60	3.9814	3.9814	4.1743	1.6589	0.0538	1.7127
2.5630	8.80	4.0988	4.0988	4.2889	1.6730	0.0529	1.7259
2.6656	9.00	4.2171	4.2171	4.4045	1.6869	0.0521	1.7389
2.7694	9.20	4.3363	4.3363	4.5211	1.7005	0.0512	1.7517
2.8741	9.40	4.4561	4.4561	4.6385	1.7139	0.0504	1.7643
2.9801	9.60	4.5770	4.5770	4.7569	1.7271	0.0497	1.7768
3.0869	9.80	4.6985	4.6985	4.8760	1.7402	0.0489	1.7891
3.1949	10.00	4.8208	4.8208	4.9961	1.7530	0.0482	1.8012
3.4691	10.50	5.1300	5.1300	5.2999	1.7843	0.0465	1.8309
3.7491	11.00	5.4437	5.4437	5.6087	1.8146	0.0450	1.8594
4.0351	11.50	5.7623	5.7623	5.9227	1.8439	0.0436	1.8875
4.3267	12.00	6.0853	6.0853	6.2413	1.8723	0.0423	1.9146
4.6233	12.50	6.4124	6.4124	6.5644	1.9000	0.0411	1.9411
4.9252	13.00	6.7437	6.7437	6.8919	1.9268	0.0399	1.9667
5.2323	13.50	7.0794	7.0794	7.2241	1.9529	0.0389	1.9917
5.5424	14.00	7.4189	7.4189	7.5602	1.9799	0.0379	2.0178
5.8605	14.50	7.7625	7.7625	7.9006	1.0032	0.0369	2.0401
6.1813	15.00	8.1096	8.1096	8.2447	2.0274	0.0361	2.0635
6.5066	15.50	8.4605	8.4605	8.5929	2.0511	0.0352	2.0863
6.8363	16.00	8.8153	8.8153	8.9450	2.0742	0.0345	2.1087
7.1702	16.50	9.1736	9.1736	9.3007	2.0968	0.0337	2.1305
7.5081	17.00	9.5354	9.5354	9.6601	2.1190	0.0330	2.1520
7.8498	17.50	9.9005	9.9005	10.0229	2.1407	0.0323	2.1731
8.1958	18.00	10.2693	10.2693	10.3894	2.1619	0.0317	2.1936
8.5438	18.50	10.6395	10.6395	10.7575	2.1830	0.0311	2.2141
8.8985	19.00	11.0164	11.0164	11.1290	2.2033	0.0305	2.2339
9.2557	19.50	11.3951	11.3951	11.5091	2.2234	0.0300	2.2534
9.6160	20.00	11.7765	11.7765	11.8887	2.2432	0.0295	2.2727

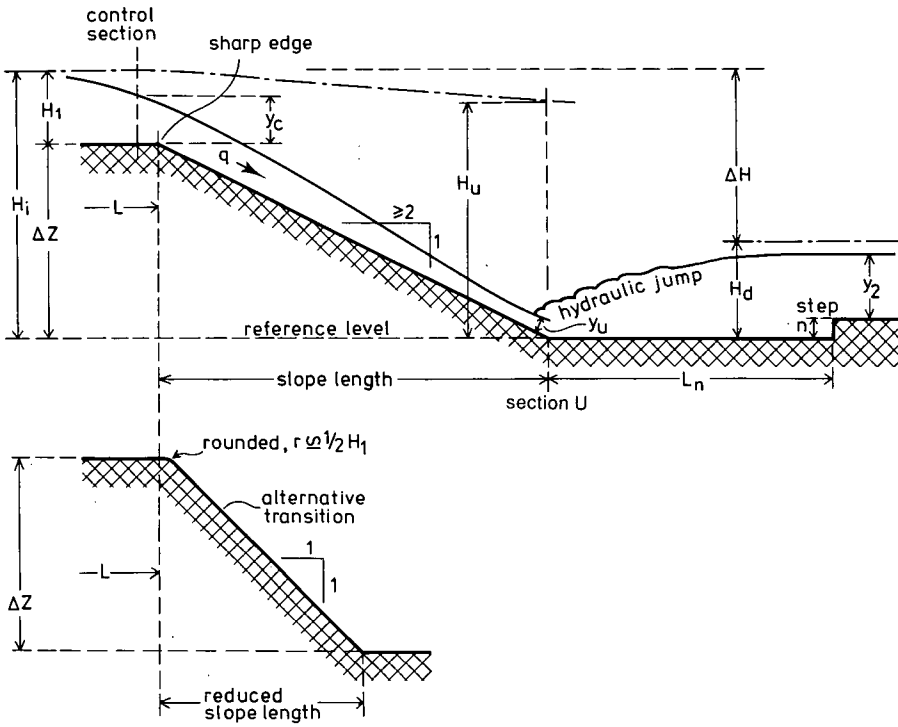

Figure 19.40 Definition sketch to Table 19.9 (from Bos, Replige and Clemmens 1984)

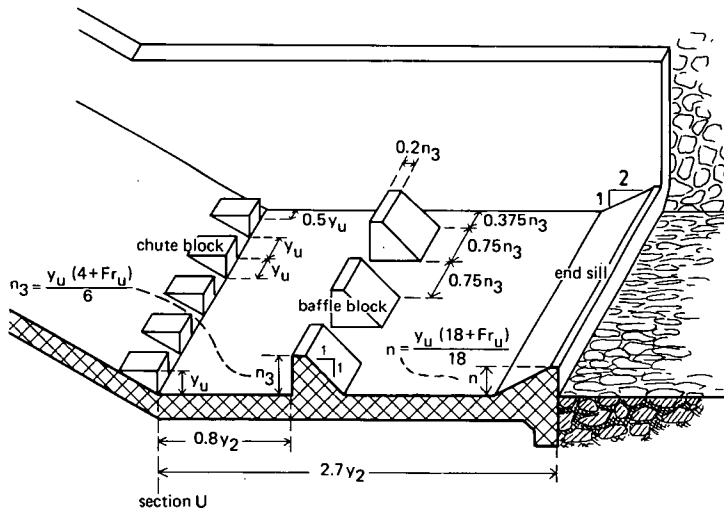

Figure 19.41 Stilling basin characteristics for use with Froude numbers above 4.5; USBR Type III basin (Bradley and Peterka 1957)

19.8 Culverts

19.8.1 General

A culvert can be defined as a reduction in the channel's wetted area, and as a change in its slope, or in the direction of flow. In culverts, flow usually remains subcritical. Nearly all culverts of interest to the drainage engineer are structures that are short in comparison to the remaining channel. Yet the culverts affect the flow far upstream if their discharge capacity is too low in comparison with that of the open drain.

The possibility of this occurring is very real, as the discharge characteristics of a culvert change in a transitional zone from 'free water surface flow' to 'pipe flow' if the upstream drain water level exceeds the elevation of the internal culvert crest (see Figure 19.42). If the water level in the culvert is below the crest, this free flow can be expressed in an equation similar to Equation 19.48

$$Q = K y^u \quad (19.58)$$

where

K = a factor dependent on the shape, size, and hydraulic properties of the culvert

u = an exponent to the water depth in the culvert, y , which varies between 1.6 and 2.0 for commonly used culverts where there is a free water surface. If, however, the culvert pipe flows full, u approaches 0.5 (see Figure 19.42)

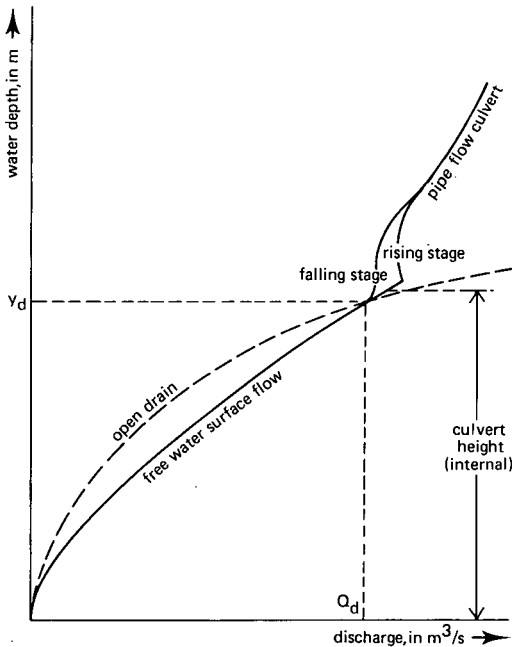

Figure 19.42 Discharge characteristics of a culvert versus those of an open drain

A comparison of the discharge characteristics of a culvert and a (trapezoidal) channel shows a great difference between their discharge capacities as soon as the culvert pipe flows full. Especially in drainage channels, where the design discharge, Q_d , is statistically determined, a culvert with full pipe flow will seriously obstruct discharges greater than Q_d . To avoid such an obstruction, it is recommended to over-dimension drainage culverts to the capacity of the bank-full-flow of the upstream channel ($y = D$), except when that channel must function as storage for discharges greater than Q_d .

A culvert whose pipe commonly flows full is called a 'siphon'. Because of their hydraulic characteristics, they are more popular for irrigation channels than drainage channels.

19.8.2 Energy Losses

The energy losses over a culvert are due to:

- The conversion of potential energy into kinetic energy at the entrance transition, and vice versa at the downstream transition;
- Turbulence and flow separation in bends or elbows;
- Friction losses over the length of the entrance transition, the downstream transition, and the culvert pipe.

The total loss of energy over the structure has to be reconciled with the available fall. Consequently, culverts have been designed with either discontinuous boundaries and sharp breaks in the wall alignment, resulting in extensive separation zones and local eddying whenever economy of construction was more important than the loss of energy head, or with careful streamlining with gradual transitions when the fall over a structure was limited by the available head.

Transition Losses

For transitions in open channels where the Froude number of the accelerated flow does not exceed 0.5, it is common to express the loss of energy over the inlet and outlet of the culvert, ΔH_{in} or ΔH_{out} , by a simple equation, valid for closed conduits

$$\Delta H_{in} = \xi_{in} \frac{(v_a - v)^2}{2g} \quad (19.57)$$

or

$$\Delta H_{out} = \xi_{out} \frac{(v_a - v)^2}{2g} \quad (19.58)$$

where

- $\xi_{in, out}$ = an energy loss factor dependent on the hydraulic shape of the transition and on whether it is an inlet or outlet transition (–)
- v_a = accelerated average flow velocity in the culvert pipe (m/s)
- v = average flow velocity in either the upstream or downstream channel (m/s)

<p>(A) culvert pipe terminates in channel side slope transition</p>		<p>equation 19.59/19.60</p> <p>ξ_{in} ξ_{out}</p> <p>0.50 1.00</p>
<p>(B) culvert pipe terminates in headwall across channel</p>		<p>0.30 1.10</p>
<p>(C) broken-back transition with flare angle of 1:1 or 1:2</p>		<p>0.10 0.80</p>
<p>(D) headwall with rounded transition of which the radius exceeds 0.1y</p>		<p>0.05 1.00</p>
<p>(E) broken back transition with flare angle of about 1:5</p>		<p>0.05 0.30</p>
<p>(F) gradual transition between trapezoidal and rectangular cross sections</p>		<p>0.05 0.20</p>

Figure 19.43 Head loss coefficients for trapezoidal to rectangular transitions with a free water surface and vice versa (after Bos and Reinink 1981, and Idel'cik 1969)

If v is small with respect to v_a , we can reduce the above equations to

$$\Delta H_{in} = \xi_{in} \frac{v_a^2}{2g} \quad (19.59)$$

and

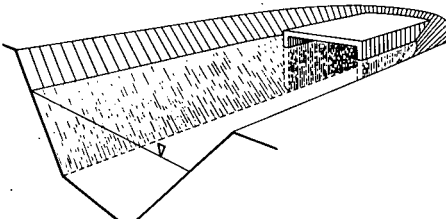
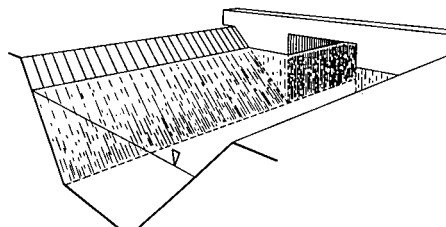
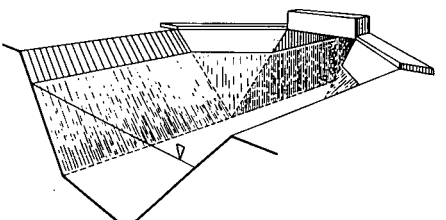
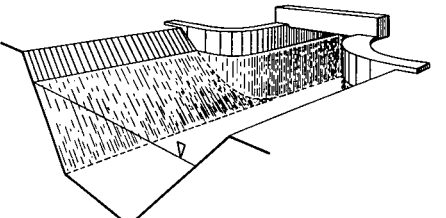
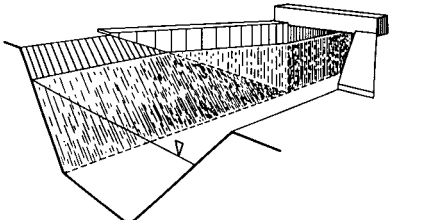
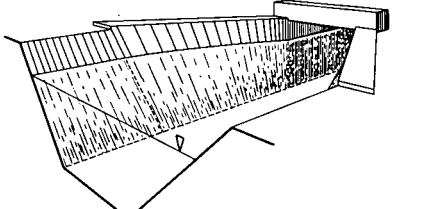
$$\Delta H_{out} = \xi_{out} \frac{v_a^2}{2g} \quad (19.60)$$

These equations have the same structure as the head-loss equations for bends, elbows, trash-racks, valves, and so forth.

Figure 19.43 illustrates some designs for transitions for culverts with a free water surface, and Figure 19.44 illustrates some designs for culverts with a full flowing pipe.

<p>(A)</p> <p>pipeline terminates in channel side slope transition</p>		<p>equation 19.59 19.60</p> <hr/> <p>ξ_{in} ξ_{out} 0.65 1.00</p>
<p>(B)</p> <p>barrel of pipeline connects directly to headwall across channel</p>		<p>0.55 1.10</p>
<p>(C)</p> <p>barrel of pipeline connected to conventional broken-back transition with 1:4 flare angle</p>		<p>0.50 0.65</p>
<p>(D)</p> <p>6D-long pipe transition connects pipeline to headwall across channel (round to rectangular)</p>		<p>0.40 0.10</p>

Figure 19.44 Head loss coefficients for transitions from trapezoidal channel to pipe and vice versa (after Simmons 1964, and Idel'cik 1969)

The figures yield the following general conclusions:

- If energy losses need to be reduced, it is better to invest in an outlet transition than in an inlet transition;
- The construction of a head wall in which the pipe terminates directly is expensive in relation to the reduction in head loss;
- Rounded or very gradual transitions (Figure 19.43D and E) are costly and relatively ineffective.

Energy Losses in Elbows and Bends

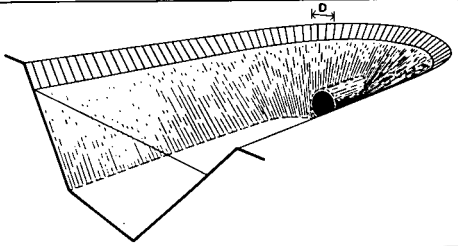
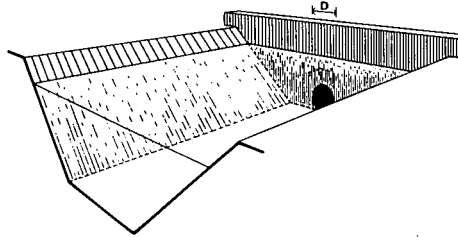
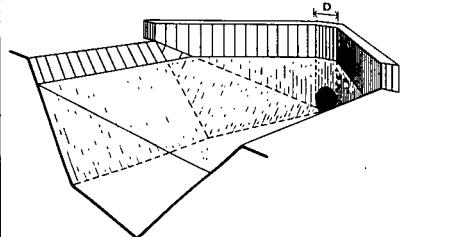
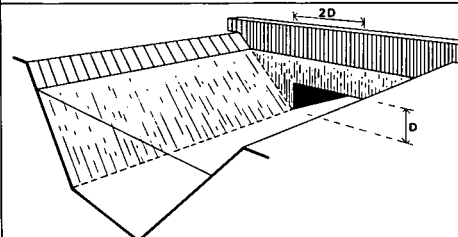
Elbows and bends in pipes cause a change in the direction of flow and consequently, a change in the general velocity distribution. Owing to this change in velocity distribution, there is an increase of piezometric pressure at the outside of the bend and a decrease at the inside of the bend. This decrease in pressure may be so high that the flow separates from the solid boundary, and thus causes additional energy losses due to turbulence. Losses in elbows and bends in excess of those due to friction have been studied by various investigators, and may be expressed by an equation similar to Equation 19.56

$$\Delta H_b = \xi_b \frac{v_a^2}{2g} \tag{19.61}$$

The approximate value of the head loss coefficient, ξ_b , for an elbow is given in Table 19.10. ξ_b values for the square profile are somewhat higher than for the circular profile due to the less favourable velocity distribution and some consequent additional turbulence (Figure 19.45).

Table 19.10 ξ_b values for elbows

δ	5°	10°	15°	22.5°	30°	45°	60°	75°	90°
ξ_b value									
(○-profile)	0.02	0.03	0.04	0.05	0.11	0.24	0.47	0.80	1.1
ξ_b profile									
(□-profile)	0.02	0.04	0.05	0.06	0.14	0.3	0.6	1.0	1.4

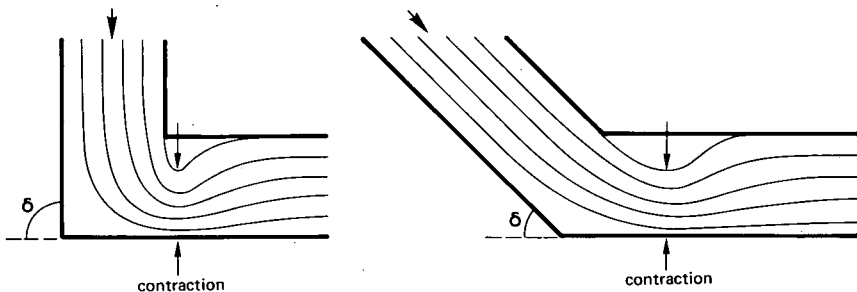

Figure 19.45 Flow separation in an elbow

Bend losses in closed conduits, in addition to those losses due to friction, can be expressed as a function of the ratio R_b/D , where R_b is the radius of the conduit centre line and D is the diameter of a circular conduit or the height of the conduit cross-section in the plane of the bend for rectangular conduits.

Figure 19.46 shows a curve giving suitable ξ_b values for large-diameter conduits as a function of R_b/D . As we can see, a ratio of R_b/D greater than 4 does not make savings in energy head commensurate with the extra expense, so this value is advisable as a maximum for conduits with subcritical flow. For bends of other than 90° , a correction factor should be applied to the values given in Figure 19.46. Values of this factor as a function of the angle, δ , of the bend are given in Figure 19.47.

Friction Losses

In culvert pipes with a free water surface, and in inlet and outlet transitions, the energy losses due to friction can be calculated with Manning's equation (Equation 19.12). With this equation, we can also calculate the slope, s , of the energy gradient, if we know the average velocity and the hydraulic radius. For this purpose we may use the average velocity, $(v_a + v)/2$, and the related hydraulic radius over an inlet or outlet transition.

We can find the summed head loss due to friction with

$$\Delta H_f = \Delta H_{f,in} + \Delta H_{f,pipe} + \Delta H_{f,out} \quad (19.62)$$

where each ΔH is the product of the slope of the hydraulic gradient and the length of the considered channel reach, $s \times L$.

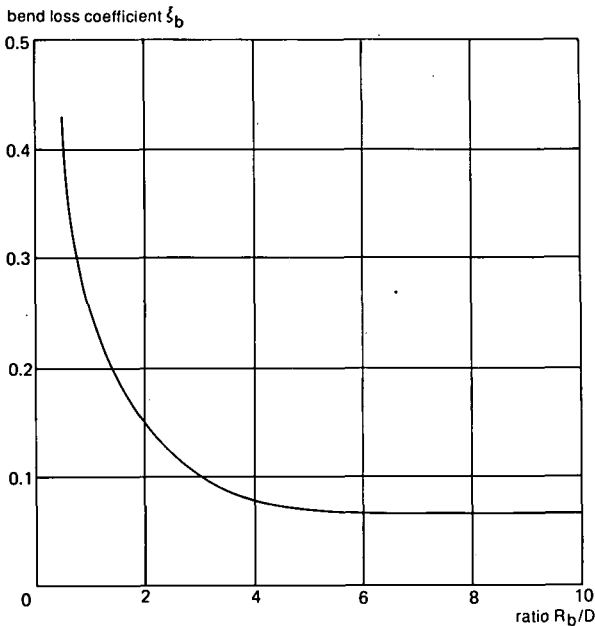

Figure 19.46 Suitable ξ_b values for large-diameter conduits (after U.S. Bureau of Reclamation 1967)

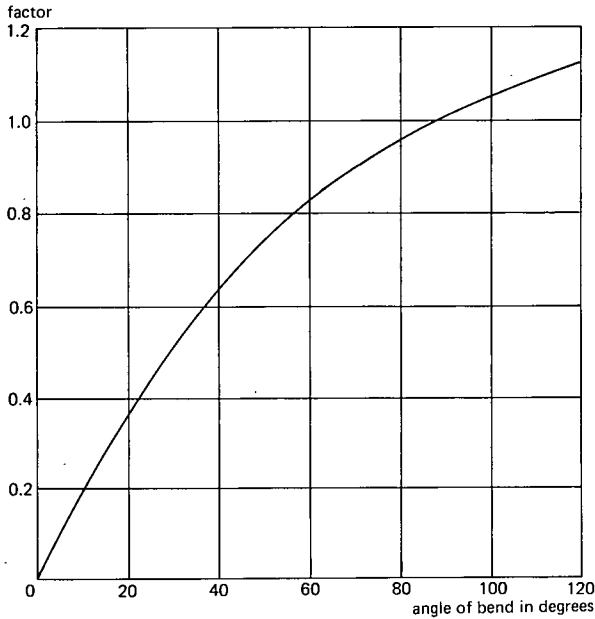

Figure 19.47 Reduction factor for bend loss coefficients in conduits

For full flowing pipes, use the Weisbach-Darcy equation to calculate the energy loss due to friction

$$\Delta H_{f,pipe} = n_t \frac{L}{D} \times \frac{v_a^2}{2g} \quad (19.63)$$

where

n_t = component resistance coefficient. For conservative culvert designs, use $n_t = 0.020$ (-)

D = average pipe diameter (m)

Use Equations 19.57 through 19.63 to calculate the total energy loss over a culvert or siphon. As this loss is linearly proportional to $v_a^2/2g$, we can calculate ΔH_{total} if we know the size and shape of the structure

$$\Delta H_{total} = \Delta H_{in} + \Delta H_f + \Delta H_b + \Delta H_{out} = \Sigma \text{coeff.} \frac{v_a^2}{2g} \quad (19.64)$$

If the total head loss is limited by an available value, use Equation 19.64 to calculate the velocity, v_a , and then select the shape and size of the component parts of the culvert to enable Q_d .

References

Aisenbrey, A.J., R.B. Hayes, H.J. Warren, D.L. Winsett and R.B. Young 1974. Design of small canal structures. U.S. Department of the Interior, Bureau of Reclamation, Denver, 435 p.

- Bertram, G.E. 1940. An experimental investigation of protective filters, Publications of the Graduate School of Engineering, Harvard University.
- Bos, M.G. 1989. Discharge Measurement Structures, 3rd ed. ILRI Publication 20, Wageningen, 401 p.
- Bos, M.G. and Y. Reinink 1981. Required head loss over long throated flumes. Journal of the Irrigation and Drainage Division ASCE, 107, IR 1, pp. 87-102.
- Bos, M.G., J.A. Replogle and A.J. Clemmens 1984. Flow measuring flumes for open channel systems. Wiley, New York, 340 p.
- Bradley, J.N. and A.J. Peterka 1957. The hydraulic design of stilling basins. Journal of the Hydraulics Division ASCE, 83, HY 5, pp. 1401-1406.
- Brakensiek, D.L., H.B. Osborn and W.J. Rawls 1979. Field manual for research in agricultural hydrology. Agriculture Handbook No. 224, USDA Washington, 547 p.
- Cowan, W.L. 1956. Estimating hydraulic roughness coefficients, Agricultural Engineering, 37, 7, pp. 473-475.
- Chow, V.T. 1959. Open channel hydraulics. McGraw-Hill, New York. 680 p.
- Donnelly, C.A. and F.W. Blaisdell 1954. Straight drop spillway stilling basin. University of Minnesota, Saint Anthony Falls Hydraulic Laboratory, Technical Paper 15, Series B.
- Eastgate, W. 1969. Vegetated stabilization of grassed waterways and dam bywashes. Bulletin Water Resources Foundation of Australia, 16, Kingsford. 33 p.
- Engelund, F. and E. Hansen 1967. A monograph on sediment transport in alluvial streams. Teknisk Forlag, Copenhagen, 62 p.
- Forster, J.W. and R.A. Skrinde 1950. Control of the hydraulic jump by sills. Trans. of the Am. Soc. of Civil Engin., 115, pp. 973-987.
- Fortier, S. and F.C. Scobey 1926. Permissible canal velocities, Trans. of the Am. Soc. of Civil Engin., 89, pp. 940-984.
- Gebler, R.J. 1991. Naturgemasse Bauweisen von Sohlenbauwerken und Fischeaufstiegen zur Vernetzung der Fliessgewasser. Institut für Wasserbau und Kulturtechnik, Karlsruhe, 145 p.
- Henderson, F.M. 1966. Open channel flow. MacMillan, New York, 522 p.
- Idel'cik, I.E. 1969. Memento des pertes de charge. Eyrolles, Paris, 494 p.
- Lane, E.W. 1952. Progress report on results of studies on design of stable channels. U.S. Bureau of Reclamation, Hydraulic Laboratory Report Hyd-352.
- Meyer-Peter, E. and R. Müller 1948. Formulas for bed-load transport. Proc. of the Int. Ass. Hydraulic Research, at Stockholm, Vol 2, No. 2.
- PWD 1967. ORD Irrigation Project, Design Manual 1967. Public Works Department of Western Australia, Perth.
- Peterka, A.J. 1964. Hydraulic design of stilling basins and energy dissipators. U.S. Dept. of the Interior, Bureau of Reclamation, Engineering Monograph 25, Denver, 223 p.
- Ree, W.O. and V.J. Palmer 1949. Flow of water in channels protected by vegetative linings. U.S. Dept. of Agric. Tech. Bulletin 967. 115 p.
- Ree, W.O. 1977. Friction factors for vegetated waterways of small slope. U.S. Dept. of Agric., ARS-S-151, 56 p.
- Simmons, W.P. 1964. Hydraulic design of transitions for small canals, U.S. Dept. of the Interior, Bureau of Reclamation, Engineering Monograph 33, Denver, 39 p.
- Storsbergen, C. and M.G. Bos 1981. Drainage of a coastal plain on Java. Proc. of the 11th ICID Congress at Grenoble, France, New Dehli, pp. 521-532.
- Temple, D.M. 1979. Tractive force design of vegetated channels. Am. Soc. of Agric. Eng. Paper No. 79-2068, 20 p.
- Theurer, F. 1979. Ohio channel stability study, final report. Vol. 1, Soil Conservation Service, Washington.
- U.S. Army Corps of Engineers 1955. Drainage and erosion control-subsurface drainage facilities for airfields. Part XIII, Chapter 2, Engineering Manual, Military Construction, Washington, 15 p.
- U.S. Bureau of Reclamation 1957. Hydraulic and excavation tables, 11th ed. U.S. Gov. Printing Office, Washington, p. 350.
- U.S. Bureau of Reclamation 1973. Design of small dams. 2nd ed. U.S. Government Printing Officer, Washington, 816 p.
- U.S. Bureau of Reclamation 1967. Canals and related structures. U.S. Government Printing Office, Washington, 350 p.
- U.S. Dept. of Agriculture 1954. Handbook of channel design for soil and water conservation. Soil Conservation service, SCS-TP-G1, Washington, 33 p.

- U.S. Dept. of Agriculture 1977. Design of Open Channels. Soil Conservation Service, Technical Release No. 25, Washington, 260 p.
- U.S. Dept. of the Army 1952. Geology and its military applications. Technical Manual TM 5-545, pp. 3-32.
- USSR 1936. Standards for permissible non-eroding velocities. Bureau of the Methodology of the Hydro-Energy Plan; Gidrotekhnicheskoye Stroitel'stvo, Obedinnennoye Nauchno-Tekhnicheskoye Ispytatel'stvo, Moskov.
- Van Bendegom, L. 1969. Principles governing the design and construction of economic revetments for protecting the banks of rivers and canals for ocean and inland navigation. 20th Intern. Navigation Congress, Paris, 43 p.

20 Surface Drainage Systems

R.J. Sevenhuijsen¹

20.1 Introduction

Surface drainage, the oldest drainage practice, was defined in Chapter 1 as:

‘The diversion or orderly removal of excess water from the surface of land by means of improved natural or constructed channels, supplemented when necessary by shaping and grading of the land surface to such channels.’ (ICID 1982).

Surface drainage has long been regarded as a farmer’s practice. With the introduction of subsurface drainage and farm mechanization – and their related high investment costs – surface drainage became the subject of scientific and engineering research.

Surface drainage is applied primarily on flat lands where slow infiltration, low permeability, or restricting layers in the profile prevent the ready absorption of high-intensity rainfall. The drainage system is therefore intended to eliminate ponding and prevent prolonged saturation by accelerating flow to an outlet without causing siltation or soil erosion.

Developments in surface drainage bear a strong relation to developments in irrigation and erosion control because these activities deal in many ways with the same boundary conditions, be it to attain different goals.

Criteria for the design of a surface drainage system should be based on agricultural constraints (e.g. the sensitivity of crops to ponded water and saturated soils; Chapter 17) as well as engineering considerations of flow through channels and structures (Chapter 19). As surface drainage is aimed at the orderly removal of excess water from the land surface, it has by its nature an effect on the environment of the area (Chapter 25).

This chapter will discuss methods of surface drainage and their application, treating surface drainage components such as land forming and field drainage systems (Section 20.2), both for flat lands (Section 20.3) and for sloping areas (Section 20.6). It will also give attention to the design, construction, and maintenance of surface drainage systems.

20.2 Surface Drainage Systems and Components

The negative effects of poor surface drainage on agricultural productivity can be summarized as:

- Inundation of crops, resulting in deficient growth;
- Lack of oxygen in the rootzone, hampering germination and the uptake of nutrients;
- Insufficient accessibility of the land for mechanized farming operations;
- Low soil temperatures in spring time (temperate regions).

¹ Wageningen Agricultural University, formerly of ILRI

To improve the growing conditions of crops at field level by ensuring the timely and orderly removal of excess water, the land surface should be smooth and should have a continuous slope to allow the overland flow of water to a collector point. From this collector point, water should flow to the area's natural or constructed main drainage system of field and collector drains. The design of a surface drainage system therefore has two components:

- The shaping of the surface by land forming, which ICID (1982) defines as changing the micro-topography of the land to meet the requirements of surface drainage or irrigation;
- The construction of open drains to the main outlet.

20.2.1 Bedding, the Traditional Land-Forming System

The bedding system is one of the oldest surface drainage practices. Under this system, the soil is formed into beds by manual labour, animal traction, or farm tractors. The beds are separated by parallel dead furrows oriented in the direction of the greatest land slope. The water drains from the beds into the dead furrows, which discharge into a field drain constructed at the lower end of the field and perpendicular to the dead furrows (Figure 20.1).

In modern farming, bedding is not considered an acceptable drainage practice for row crops, because rows adjacent to the dead furrows will not drain satisfactorily.

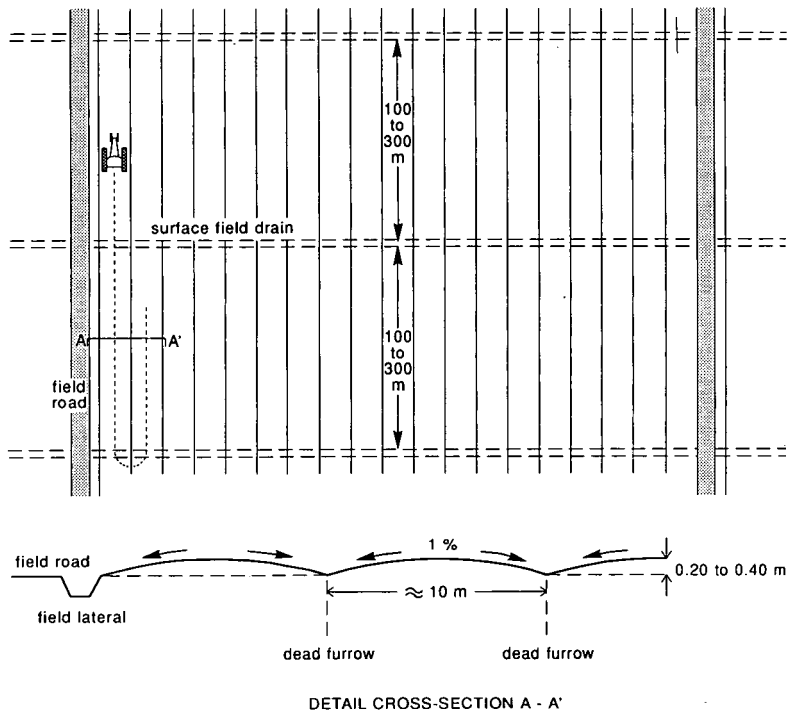

Figure 20.1 The bedding system

It is acceptable for grassland in some areas, although there will be some crop loss in and adjacent to the dead furrows.

The typical drainage characteristics of a well-developed bed are shown in Figure 20.2. Because of the construction and land preparation, the top soil of the bed has better hydraulic properties than the underlying 'impermeable' soil. A large part of the excess rainfall will therefore flow over the 'impermeable' layer by interflow and overland flow towards the dead furrow.

In many areas where high groundwater levels occur (e.g. in rice-growing areas), the bedding system is applied to grow vegetables, tree crops, and staple crops like maize and cassava. Most of these beds are made manually.

Design and Construction

The development of a bedding system is illustrated in Figure 20.3. It often takes several years of ploughing to obtain an adequate bedding system.

During the first ploughing, care should be taken to make beds of uniform width throughout the field and to have the dead furrows running in the direction of the greatest slope. One of the major problems of the bedding system is adequate drainage of the dead furrows into a field drain, but with the excess rainfall concentrated in the furrows, the available head difference should start a flow towards the field drain. Any obstructions or low points in the dead furrows should be eliminated because they will cause standing water and loss of crops. The field drain should be laid out in the direction of the lesser field slope, but should be properly graded towards the field lateral.

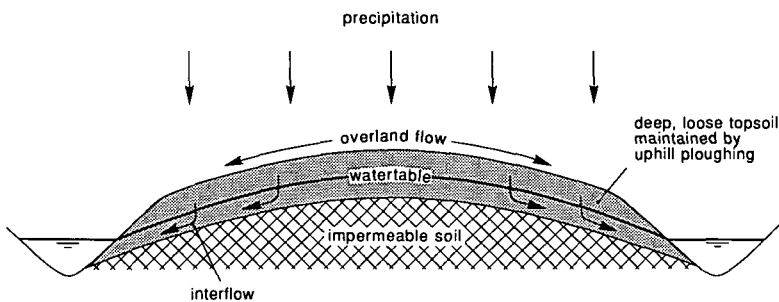

Figure 20.2 Drainage by overland flow and perched groundwater flow (interflow) in a bedding system (after Smedema and Rycroft 1983)

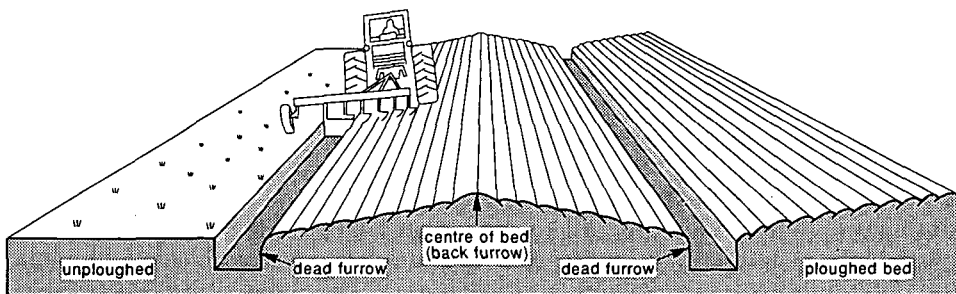

Figure 20.3 Development of a bedding system (after Beauchamp 1952)

To ensure good drainage in a bedding system, the bed width should not be more than 10 m. Further, the width of the beds is governed by the following:

- Kind of crops to be grown: Permanent pasture or hay crops do not require beds as narrow as field crops do. It is usually unprofitable to grow row crops in dead furrows. The bed width should therefore be adjusted to the row spacing;
- Farming operations on beds: Ploughing, planting, and cultivating should fit the width of a bed. Bed width should be a multiple of the effective width of farm equipment.
- Soil characteristics: Soils with low infiltration and low permeability require narrower beds than soils with better characteristics.

Some disadvantages of the traditional bedding system are:

- The top soil is moved from the sides of the bed to the middle, which may cause a reduction of yields at the sides;
- The system restricts mechanized farming;
- The slope of the dead furrows is often insufficient, resulting in ponded areas;
- The dead furrows require regular maintenance to prevent weed growth.

Land Crowning, an Improved Bedding System

Land crowning is basically an improved bedding system in which earthmoving machinery is used to make wider beds of 20 to 30 m. These are often referred to as cambered beds.

Crowning is the process of forming the surface of land into a series of broad low beds separated by parallel field laterals. Crowning requires more maintenance than most of the other systems, except for the traditional bedding. The large number of field laterals takes land out of production, and they are a source of sedimentation and erosion, as well as weed and grass infestation. Crowning with crossable field drains provides excellent drainage for pasture crops (ICID 1982). With the wider spacing of the dead furrows, some of the disadvantages of the traditional bedding system are overcome.

Contemporary Bedding Activities

Some examples of bedding in different countries are the following:

- The Netherlands: Eastern Flevoland. In the recently reclaimed Flevo Polder (flat topography, typical fluvaquent soils), permanent pasture land for cattle suffered from compaction of the top layer. To overcome standing water, which resulted in sod deterioration and the occurrence of weeds, a bedding system was applied. The beds are 12 m wide with a side slope of 2% (Zelhorst 1969);
- India: International Crop Research Institute for Semi-Arid Tropics/ICRISAT. A bed-and-furrow system was developed on deep vertisols for the drainage of row crops. The system consists of a flat bed 0.9 m wide and a small furrow 0.6 m wide. It resembles a furrow irrigation system, but with shallower furrows. Row crops are planted on the shoulder of the beds;
- Mediterranean area: Morocco, Algeria, etc. For the cultivation of cereals on vertisols (rainfall excess of 180 mm per day), an improved bedding system (crowning), with beds 30 m wide, 200 m long, and a slope of 3%, proved satisfactory;
- Indonesia: Java, Kalimantan. In the tidal lowlands in some parts of Indonesia, rice

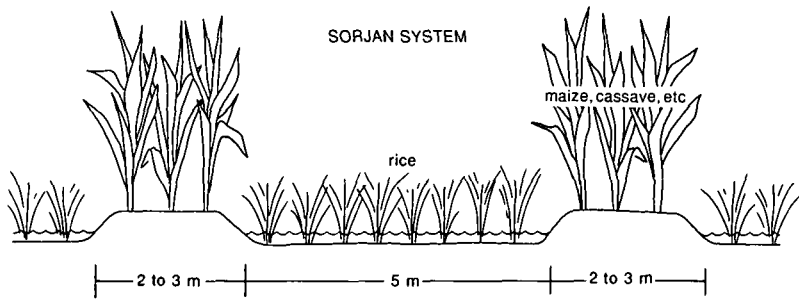

Figure 20.4 'Sorjan' bedding system (South Kalimantan, Indonesia)

is grown in combination with upland crops (vegetables) and tree crops in a raised bedding system known as Sorjan. The width of the rice plots is about the same as that of the raised beds (3 to 5 m), which have an elevation of 0.2 to 0.35 m above the rice plots (Sahat Matondang et al. 1986). Sorjan is illustrated in Figure 20.4.

20.2.2 Land Grading and Land Planing

To overcome the disadvantages of the bedding system, two other methods of land forming have been developed: land grading and land planing (ICID 1982).

Land grading is the process of forming the surface of land to predetermined grades, so that each row or surface slopes to a (field) drain. Land grading for surface drainage consists of forming the landscape by cutting, filling, and smoothing it to planned continuous surfaces. It is a one-time operation, involving the transport of earth according to specified cuts and fills based on the predetermined grades. Land grading for surface drainage differs from land levelling for irrigation in that, for drainage, no uniform grade is required. The grades can be varied as much as is necessary to provide drainage with the least amount of earthmoving. Scarification may be required after land grading to break up the soil which has become compacted by the construction machinery.

Land grading was first applied at the beginning of the fifties to enable the irrigation of row crops in the southern part of the U.S.A., but also proved highly beneficial for surface drainage in humid areas. Land grading promotes the orderly movement of water over the surface and the efficient use of machinery. It eliminates field drains, thus reducing the need for weed control and maintenance, and enables better land utilization.

Land planing is the process of smoothing the land surface with a land plane to eliminate minor depressions and irregularities without changing the general topography. It is frequently applied in conjunction with land grading. The effect of land grading and planing is illustrated in Figure 20.5. In Field A, these activities have eliminated the micro-topography present in the surrounding fields. Irregular micro-topography in a flat landscape in combination with heavy soils can cause substantial crop losses.

Land forming on a scale such as shown in Figure 20.5 can only be realized with heavy earthmoving machinery. As in land levelling for irrigation, specialized contractors are usually employed to do the work.

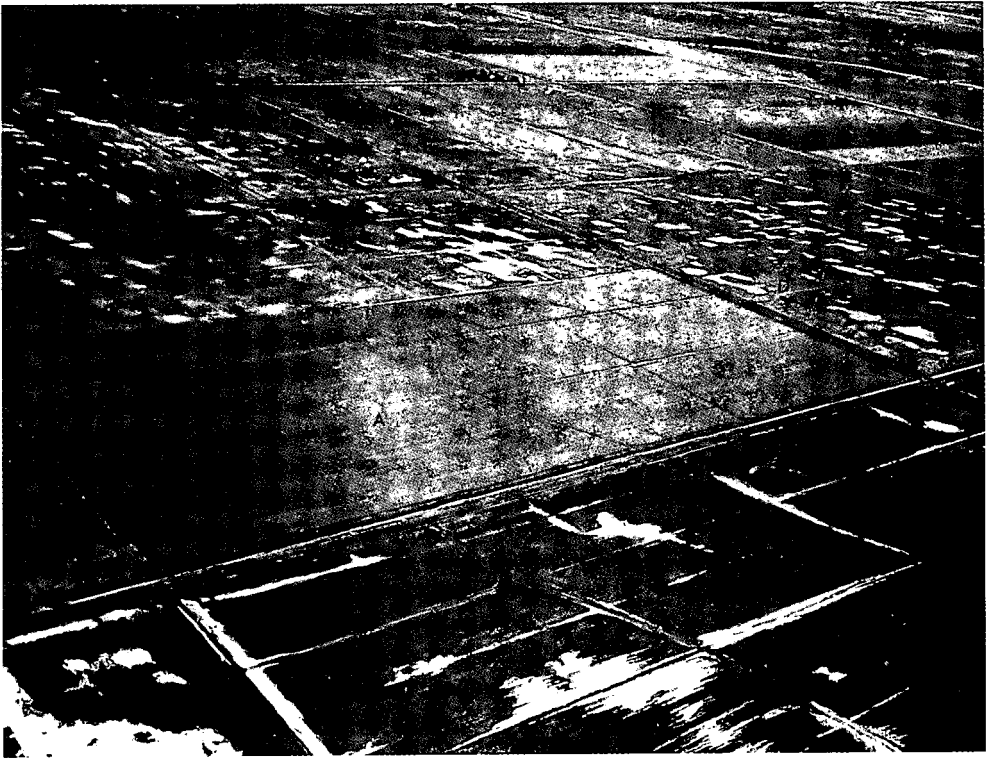

Figure 20.5 The effect of land grading in an area with an irregular micro-topography is clearly shown in Field A (Bligh 1963)

Design

In the design of land grading for surface drainage, it is not required to realize a uniform slope as for irrigation. A continuous slope is adequate.

The design should further take into consideration the type of crops that will be grown. Three main situations can be distinguished:

- a) Crops will be planted in rows and the field surface is shaped into small furrows (for corn, potatoes, sugarcane, etc.);
- b) Crops will be planted by broadcast sowing or in rows, but on an even surface (for small grains, hay crops, etc.);
- c) Crops will be planted in basins designed for controlled inundation (for wet-land rice, basin irrigation).

Re a): For row crops, the length and slopes of the field to be graded should be selected in such a way that erosion and overtopping of the small furrows is avoided. Table 20.1 lists recommended row lengths and slopes for some soil types.

To prevent erosion, flow velocities in furrows should not exceed 0.5 m/s. In highly erodible soils, the row length should be limited to about 150 m. Slightly erodible soils allow longer rows, up to 300 m. In these long furrows, adequate head should be available to ensure that the water flows towards the field drains. Figure 20.6 gives

Table 20.1 Row grades and row lengths for land grading (after Coote and Zwerman 1970)

Soil type	Grade (%)	Row length (m)	
Coarse-textured soil (sandy)	0.1 - 0.3	300	
Fine-textured soil (clayey)	0.05 - 0.25	200	
Fine-textured soil (clayey) with high organic-matter content	0.1 - 0.5	200 400	(flat) (gently sloping)
Medium-textured soil (loamy)	0.05 - 0.25	300	
Medium-textured soil (silty loam) with impervious hard-pan at depth	0.5	150	
Medium-textured soil (silty loam) with shallow impervious clay B horizon	≥ 0.2	60	
Moderately coarse-textured soils (sandy loam) with structured clay B horizon at depth	≥ 0.15	200	

an indication of acceptable row lengths and grades in relation to erodibility.

The direction of rows (and related small furrows) is not necessarily perpendicular to the slope, but can be selected in a way that meets the above recommendations.

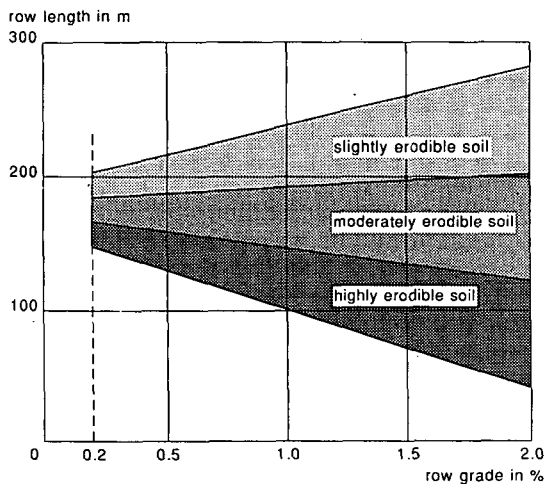

Figure 20.6 Recommended row length in relation to slope and erodibility of soils (after Smedema and Rycroft 1983)

Re b): Where crops are planted on an even land surface (no furrows), the surface drainage takes place by sheet flow. The sheet flow is always in the direction of maximum slope. In this situation, flow resistance is much higher than in small furrows and the flow velocity with the same land slope is less. However, even after careful land grading and smoothing, sheet flow always has a tendency to concentrate in shallow depressions, and gullies are easily formed. An indication of velocities and slopes for sheet flow under different soil covers is given in Figure 20.7.

From the point of view of transport duration for low flow velocities, it is recommended to limit the field length in the flow direction to 200 m or less.

The amount of water that drains from graded fields as described under a) and b) can be calculated with the Curve Number method (Chapter 4).

Re c): In basins for irrigation or for water conservation, the surface is levelled by earthmoving machinery (large basins) or with simple farm implements (small basins in traditional rice farming). Levelled fields are surrounded by field bunds. Any excess water from basins is usually drained through an overflow in the field bunds that spills the water directly into a field drain. In large rice fields (in Surinam up to 6 ha), under fully mechanized farming, the overflow is replaced by a gated culvert with a diameter of up to 0.6 m. In this situation, bunds are made by earthmoving machinery and are often used as farm roads.

Considerations on the dimensioning of overflow systems for basins are presented in Chapter 19.

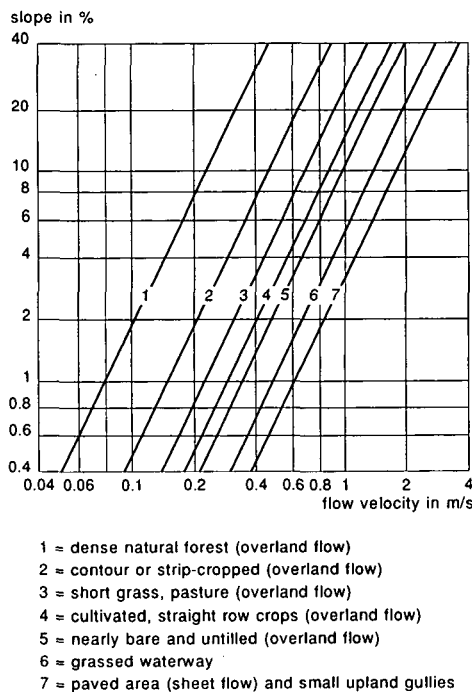

Figure 20.7 Relation between slope and flow velocity (after SCS 1971)

Construction and Maintenance

In general, land grading is done with a combination of conventional earthmoving equipment and specially designed machinery (Haynes 1966). Normal farm equipment, even if mechanized, can only handle small-scale grading operations or the maintenance of already established grades.

Grading operations involve a number of steps:

- Site preparation: On cleared land, this can be done with regular farm equipment. It mainly involves removing or destroying vegetative matter and other obstacles. Ridges or rows are levelled. The surface should be dry, firm, and well-pulverized to enable the earthmoving equipment to operate efficiently. The field is surveyed after preparation;
- Rough grading: This can be done with several types of equipment. The choice will be dictated by a number of factors (e.g. soil conditions, hauling distances, amount of earthwork, available time and equipment, size of the fields to be graded as one unit, and the experience of the operator). Dozers and motor graders are adapted to move earth over short distances. Scrapers, which come in many types and sizes, are used for hauling soil over long distances. The exact limit as to distance is not definable;
- Finished grading: This is most efficiently done with a land plane (a bottomless scraper) pulled by a farm tractor. Several passes are usually made at angles to one another. The plane should be as long as is feasible under the existing circumstances. Drags, harrows, and floats can be used on smaller fields and for final smoothing. These implements can be pulled by a farm tractor or animal traction.

When extensive grading is done with heavy equipment, it is likely to cause soil compaction. This compaction should be relieved in order to eliminate differences in soil productivity. Various sub tillage tools can be used for this purpose (e.g. subsoilers, chisels, scarifiers, and rippers).

The benefits derived from land grading will often depend on good maintenance in the subsequent years. The land should be smoothed each time a field has been ploughed. This will ensure settlement in fill areas and will erase dead furrows and back furrows. A small leveller or plane powered by a farm tractor can be used for this purpose.

20.3 Land Grading and Levelling Calculations

A land-grading design comprises estimating, from a topographic and soil survey, the best slope of the field, taking into account plans for the irrigation and drainage systems and the field roads. The area should be cleared of vegetation and the surface prepared for the operation.

Land grading is an intensive practice and much expense can be saved if the area is carefully divided into sub-areas that have about the same slope and soil conditions. This will require a topographic survey, preferably a grid survey because it permits staking the field according to the grid and marking the cuts and fills on the stakes. The size of the grids is not critical, but for drainage 9 grid points/ha are usual and for irrigation 16 grid points/ha. Calculations will be simpler if the first line of grid

points in each direction is started at half the grid spacing from the boundary. The origin of the grid system is thus situated half a grid spacing outside two boundaries of the area, and each grid point becomes the centre of a square.

Of the several methods of calculating the cuts and fills, the plane method and the profile method will be discussed here. Specialized land-grading companies often use their own computer programs based on these methods and related to their own means of executing the earthmoving work.

20.3.1 The Plane Method

The plane method is so called because the resulting land surface has a uniform downfield slope and a uniform cross slope. The plane method, also called the 'method of least squares', makes it possible to calculate, for regular as well as for irregular fields, a balanced cut-and-fill.

The procedure is as follows:

- Complete the design and construction survey;
- Determine the initial elevation at each grid point (E_i);
- Subdivide the area into sub-areas, each of which can be levelled to a plane surface;
- Locate the centroid of the sub-area (x_c, y_c).

To give equal cut and fill, the plane must pass through the centroid. The centroid of a rectangular field is located at the intersection of its diagonals. The centroid of a triangular field is located at the intersection of lines drawn from its corners to the midpoints of the opposite sides.

The centroid coordinates of an irregular field are given by the following equations

$$x_c = \frac{\sum m_x x}{n} \quad \text{and} \quad y_c = \frac{\sum m_y y}{n} \quad (20.1)$$

where

- x_c, y_c = coordinates of the centroid of the sub-area (m)
- x, y = coordinates of the grid lines (m)
- m_x = number of grid points on grid line in x direction (-)
- m_y = number of grid points on grid line in y direction (-)
- n = total number of grid points ($\sum m_x = \sum m_y = n$) (-)

Calculate the average elevation of the sub-area at the centroid

$$E_c = \frac{\sum E_i}{n} \quad (20.2)$$

where

- E_c = average elevation of the sub-area at the centroid (m)
- E_i = initial elevation of grid point (m)
- n = total number of grid points (-)

With the desired s_x and s_y slopes, in x and y direction respectively, and the average elevation E_c (E_c usually has to be lowered 1 or 2 cm to satisfy the desired cut/fill ratio), the new elevations of the grid points can now be calculated. The new plane passes through the centroid and therefore the elevation of the origin, E_o , will be

$$E_o = E_c - s_x x_c - s_y y_c \quad (20.3)$$

The new elevations of the grid points will be

$$E_n = E_o + s_x x + s_y y \quad (20.4)$$

After being graded, soil will settle in the filled areas and expand, after being ploughed, in the cut areas. To take this into account, calculations for cuts and fills must be adjusted prior to grading (SCS 1983). Table 20.2 shows some recommended cut/fill ratios.

Using the plane method, we avoid unnecessary earthmoving and find the best-fitting plane for any area. If it is obvious from the topography that the best-fitting slope is outside the limits (e.g. imposed by erosion hazards; see Section 20.2.2), we omit the next calculation and apply the acceptable limit. For non-rectangular fields, the best-fitting slopes s_x and s_y can be found from

$$s_x (\Sigma x^2 - n x_c^2) + s_y [\Sigma xy - n x_c y_c] = \Sigma x E_i - n x_c E_c \quad (20.5)$$

$$s_y (\Sigma y^2 - n y_c^2) + s_x [\Sigma xy - n x_c y_c] = \Sigma y E_i - n y_c E_c \quad (20.5)$$

where

Σx^2 = sum of the square abscissa of each grid point (m^2)

Σy^2 = sum of the square ordinate of each grid point (m^2)

Σxy = sum of the products of the coordinates of each grid point (m^2)

$\Sigma x E_i$ = sum of the products of abscissa and elevation of each grid point (m^2)

$\Sigma y E_i$ = sum of the products of ordinate and elevation of each grid point (m^2)

n = total number of grid points (-)

For rectangular areas, the term $\Sigma xy - n x_c y_c$ becomes zero.

Calculate the earth-work volume.

Knowing the initial and new elevation, we can determine the cut and fill in each grid square and can calculate the total volume of soil to be moved.

$$V = \Sigma C \times A \quad (20.7)$$

Table 20.2 Cut/fill ratios for various soils (after Coote and Zwerman 1970)

Soils	Cut/Fill ratio
Coarse-textured soils (sandy)	1.1:1 to 1.2:1 or 110 to 120%
Medium-textured soils (clay-loam)	1.2:1 to 1.3:1 or 120 to 130%
Fine-textured soils (clayey)	1.3:1 to 1.4:1 or 130 to 140%
Organic soils	1.7:1 to 2.0:1 or 170 to 200%

where

- V = volume of soil to be moved (m³)
- ΣC = sum of all cuts (m) ($C = E_i - E_n > 0$)
- A = area of grid square (m²)

Example 20.1 Plane Method (after Coote and Zwerman 1970)

An irregular-shaped field has to be levelled. A topographic survey was made with the use of a 25 m grid, the grid lines being set out in the direction of the rows (direction of y-axis in Figure 20.8). In this figure, the elevations are indicated above at the left of the grid points.

The average row length is 225 m. We are dealing with a fine-textured (clayey) soil, so the row grade can vary between 0.05 and 0.25% (Table 20.1). The required cut/fill ratio is 1.40. The plane method is used to calculate the required cuts and fills. The calculations are as follows (see also Figure 20.8)

Equation 20.1: $x_c = 88.68$ m equal $y_c = 123.11$ m

Equation 20.2: $E_c = \Sigma E_i/n = 159.44/53 = 3.01$ m

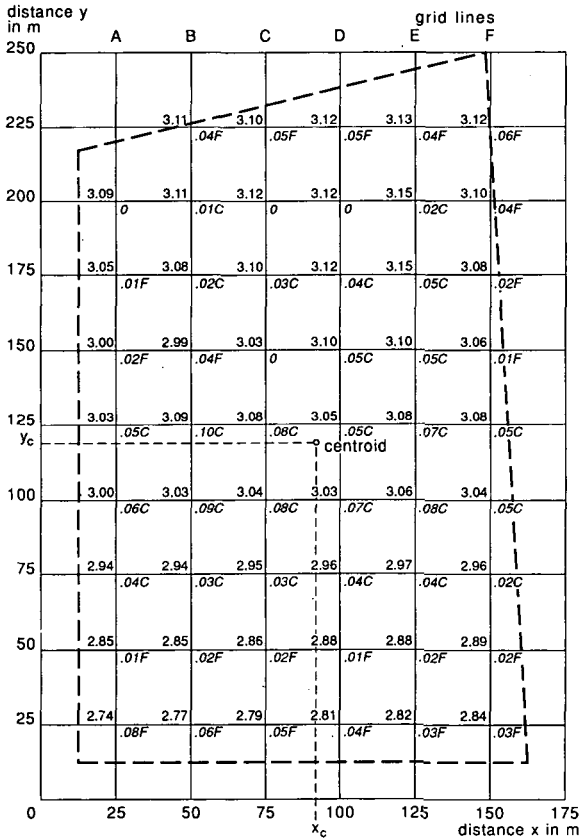

Figure 20.8 The plane method (after Coote and Zwerman 1970)

$$\begin{aligned}
 nx_c^2 &= 416\,792 & ny_c^2 &= 803\,314 & nx_c y_c &= 578\,632 \\
 nx_c E_c &= 14139 & ny_c E_c &= 19629 & & \\
 \Sigma x^2 &= 511\,250 & \Sigma y^2 &= 1\,018\,125 & \Sigma xy &= 585\,000 \\
 \Sigma x E_i &= 14183 & \Sigma y E_i &= 19967 & & \\
 \text{Equation 20.5:} & & s_x(511\,250 - 416\,792) + s_y(585\,000 - 578\,632) &= & & \\
 & & 14183 - 14139 & & & \\
 \text{Equation 20.6:} & & s_y(1\,018\,125 - 803\,314) + s_x(585\,000 - 578\,632) &= & & \\
 & & 19967 - 19629 & & & \\
 s_x &= 0.00036 \text{ m/m or } 0.036\% & & & & \\
 s_y &= 0.00158 \text{ m/m or } 0.158\% & & & & \\
 \text{Equation 20.3:} & & E_o = 3.01 - 0.00036 \times 88.68 - 0.00156 \times 123.11 &= & & \\
 & & 2.78 \text{ m} & & & \\
 \text{Equation 20.4:} & & E_n = 2.78 + 0.00036x + 0.00156y & & &
 \end{aligned}$$

By definition, the plane of best fit has equal cuts and fills:

Row No.	A	B	C	D	E	F	Σ
Cuts	0.12	0.19	0.18	0.18	0.25	0.09	1.01
Fills	0.17	0.19	0.17	0.13	0.13	0.22	1.02

To satisfy the required cut/fill ratio (1.40), the plane of best fit is lowered 0.01 m. The cut/fill ratio now becomes:

Row No.	A	B	C	D	E	F	Σ
Cuts	0.20	0.22	0.22	0.22	0.29	0.12	1.28
Fills	0.09	0.16	0.13	0.10	0.10	0.18	0.76

$$\text{Cut/fill ratio} = 1.28/0.76 = 1.68$$

This cut/fill ratio is higher than the required one. If this is not acceptable, the calculation can be repeated with a lowering of 0.005 m. In our case, we assume that the accuracy of levelling is around 0.01 m and we thus accept the cut/fill ratio of 1.68. This results in a total earth-work volume of

$$\text{Equation 20.7: } V = \Sigma C \times A = 1.28 \times 25^2 = 800 \text{ m}^3$$

For each grid point in Figure 20.8, the final cut or fill is indicated below on the right of the grid point.

20.3.2 The Profile Method

The profile method is particularly appropriate for land grading on comparatively flat lands. It is not as accurate as the plane method, but for surface drainage it should be adequate. The new grade of the field will not be uniform, but will be continuous to the field drains. With this method, ground profiles are plotted and a grade is

established that will provide an approximate balance between cuts and fills and will restrict haul distances to reasonable limits.

The procedure is as follows:

- Complete the design and construction survey;
- Plot the elevations of the grid points on each grid line in the direction of the greatest slope or the direction in which row drainage is desired;
- Draw a profile of the existing land surface along the grid line;
- Draw a new profile for each grid line by trial and error, knowing the allowable slope limits and the desired cut/fill ratio;
- Plot the cross profiles to check whether they exceed the limits. (These limits need not be the same as those chosen for the row grade.);
- Calculate the earth-work volume.

Example 20.2 Profile Method (after Coote and Zwerman 1970 and SCS 1983)

To illustrate the profile method, we shall take the same field as in Example 20.1 (Figure 20.9A). We use the grid points to plot the profiles in row-direction (Figure 20.9B). On the basis of the maximum (0.3%) and minimum (0.05%) grades and by trial-and-error, we establish the required grades (the dotted lines in Figure 20.9B). The difference

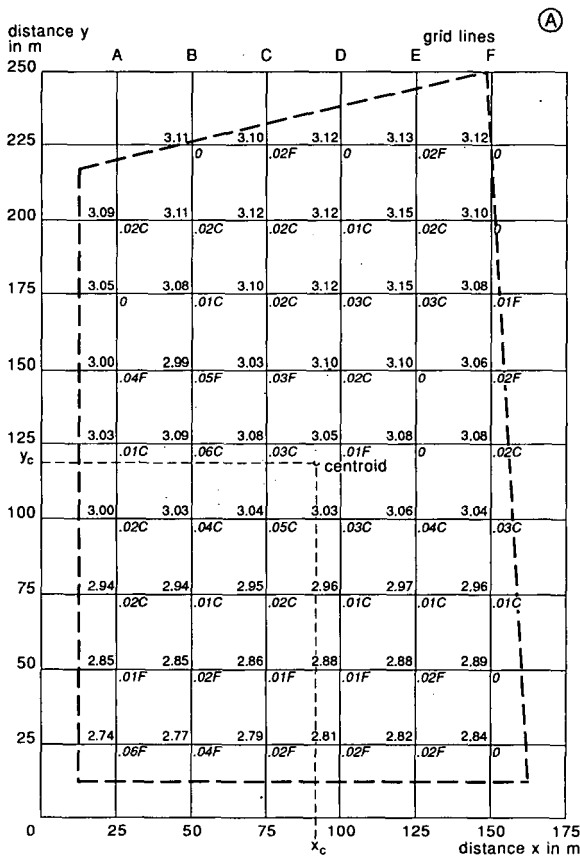

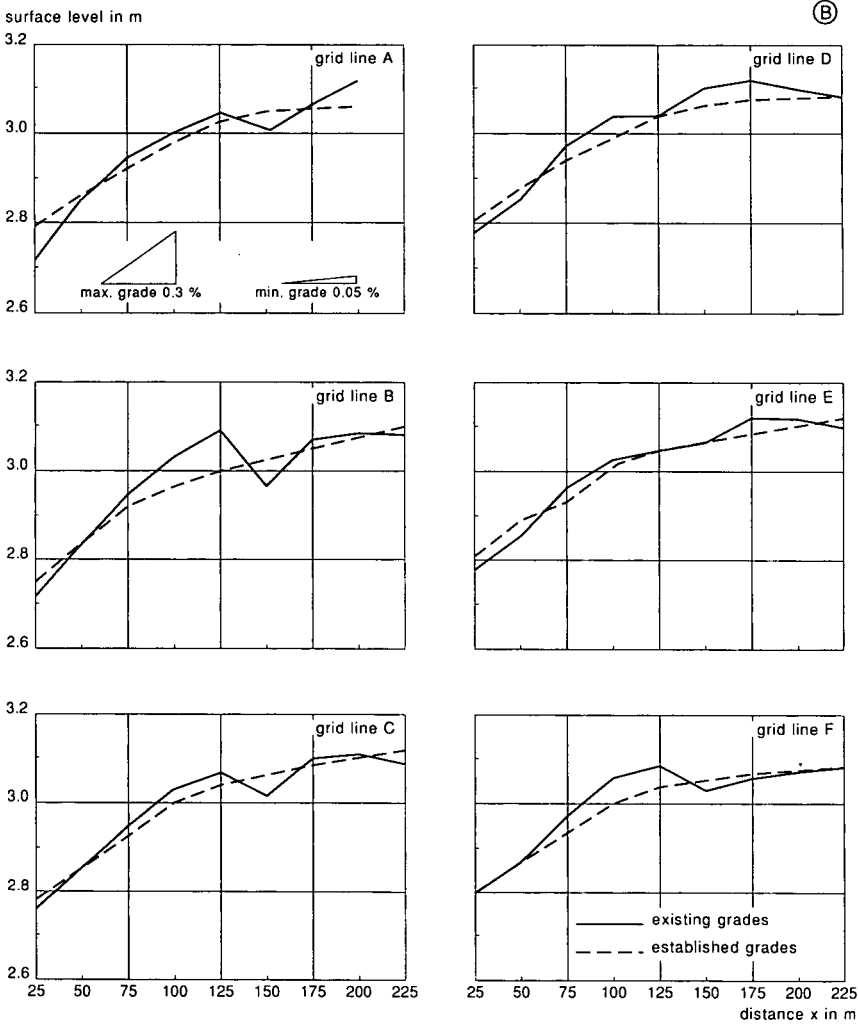

Figure 20.9 The profile method (after Coote and Zwerman 1970)
 A: Topographic survey sheet; B: Profiles in row direction

between the existing and established grades gives the cut or fill for each grid point (Figure 20.9A). We can now calculate the cut/fill ratio and the total earth-work volume.

Profile method

Row No.	A	B	C	D	E	F	Σ
Cuts	0.07	0.14	0.14	0.10	0.10	0.06	0.61
Fills	0.11	0.11	0.08	0.04	0.06	0.03	0.43

$$\text{Cut/fill ratio} = 0.61/0.43 = 1.42$$

$$\text{Earthwork volume } V = \Sigma C \times A = 0.61 \times 25^2 = 381 \text{ m}^3$$

On the basis of these earthmoving calculations, haul distances, and the location at which the operation of land grading and levelling is to take place, a contractor is able to prepare a cost estimate. For more detailed information, see Anderson et al. 1980.

20.4 Field Drains and Field Laterals

To prevent ponding in low spots, surface runoff from fields needs to be collected and transported through field drains and field laterals towards the drainage outlet of the area.

A field surface drain is a shallow graded channel, usually with a relatively flat slope, which collects water within a field (ICID 1982).

A field lateral is the principal ditch for field or farm areas adjacent to it. Field laterals receive water from row drains, field drains and, in some areas, from field surfaces (ICID 1982).

20.4.1 Field Drains

Field drains for a surface drainage system have a different shape from field drains for subsurface drainage. Those for surface drainage have to allow farm equipment to cross them and are easy to maintain with ordinary mowers. Surface runoff reaches the field drains by flow through row furrows or by sheet flow. In the transition zone between drain and field, flow velocities should not induce erosion.

Field drains are thus shallow and have flat side slopes. They can often be constructed with land planes as used in land forming. Simple field drains are V-shaped. The dimensions of V-shaped field drains are determined by the construction equipment, maintenance needs, and crossability for farm equipment. Side slopes should not be steeper than 6 to 1. Nevertheless, long field drains in conditions of high rainfall intensities, especially where field runoff from two sides accumulates in the drain, may require a higher transport capacity than provided by a simple V-shaped channel.

Without increasing the drain depth too much, the capacity can be enlarged by constructing a bottom width, creating a shallow trapezoidal shape. Recommended dimensions of V-shaped and trapezoidal drains are given in Figure 20.10. A variation is the so-called W-shaped field drain, which is applicable where a farm road is required between the drains (Figure 20.10C). These ditches are generally farmed through and their upper slopes may well be planted. They should be cleaned before the drainage season (e.g. with a shovel or a V-drag). A small furrow drain is often installed in the centre to ensure that the ditch is dry in sufficient time for tractors to pass through.

The dimensions for V-shaped drains also apply for the W-shaped drain. Care should be taken that the spoil from field drains does not block the inflow of runoff but is deposited on the correct side of the ditch or is spread evenly over the adjacent fields.

All field drains should be graded towards the lateral drain with grades between 0.1 and 0.3%.

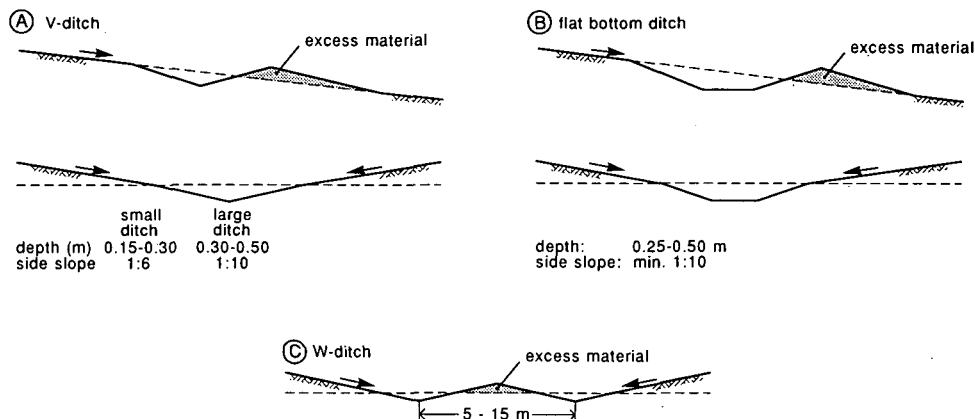

Figure 20.10 Types of passable field and collector ditches (after Smedema and Rycroft 1983)

20.4.2 Field Laterals

Field laterals collect water from field drains and transport it to the main drainage system. In contrast to the field drain, the cross-section of field laterals should be designed to meet the required discharge capacity (Chapter 19). Besides the discharge capacity, the design should take into consideration that in some cases surface runoff from adjacent fields also collects directly in the lateral, requiring a more gentle side slope.

Field laterals are usually constructed by different machinery than field drains (i.e. excavators instead of land planes). The recommended dimensions for field laterals are given in Table 20.3.

Field laterals less than 1 m deep are usually constructed with motor graders or dozers. The soil is placed near either side of the lateral. Scrapers are needed when the excavated soil is to be transported some distance away. Under wet conditions, excavators are used. Maintenance requirements should be considered during design; for example, if the field laterals are to be maintained by mowing, side slopes should not be steeper than 3 to 1.

Special attention should be given to the transition between field drains and laterals, because differences in depth might cause erosion at those places. For discharges below

Table 20.3 Recommended dimensions for field laterals (after ASAE 1980)

Type of drain	Depth (m)	Recommended side slope (horz:vert)	Maximum side slope (horz:vert)
V-shaped	0.3 to 0.6	6 : 1	3 : 1
V-shaped	> 0.6	4 : 1	3 : 1
Trapezoidal	0.3 to 1.0	4 : 1	2 : 1
Trapezoidal	> 1.0	1.5 : 1	1 : 1

0.03 m³/s, pipes are a suitable means of protecting those places. For higher discharges, open drop structures are recommended.

20.4.3 Lay-out of Field Drains and Laterals

Apart from the 'dead furrows' in the bedding system (Section 20.2.1), two typical systems of lay-out are applied in distinct situations:

- The random field drainage system;
- The parallel field drainage system.

Random Field Drainage System

This drainage system is applied where a number of depressions are distributed at random over a field. Often these depressions are large but shallow, and a complete land-forming operation is not (yet) considered economically feasible. The random field drainage system connects the depressions by means of a field drain and evacuates the stagnant water into a field lateral (Figure 20.11). To allow mechanized farming operations, the drains are shaped as described in the previous sub-sections.

The system is often applied in situations where farm operations are limited (e.g. on pasture land) or where mechanization is realized by means of small equipment.

It is important that the spoil from the field drains does not hamper the surface flow from the areas between the connected depressions. The spoil can be used to fill up low areas further away from the field drain.

In conditions where the permeability of the soil allows subsurface drainage, the random field drainage system can also be useful in improving the rootzone condition in low pockets that would otherwise require additional measures.

In general, a random field drainage system is not expensive and suits extensive land use. If intensive farming develops, however, the system needs to be replaced by a parallel field drainage system.

Parallel Field Drainage System

The parallel field drainage system, in combination with proper land forming, is the

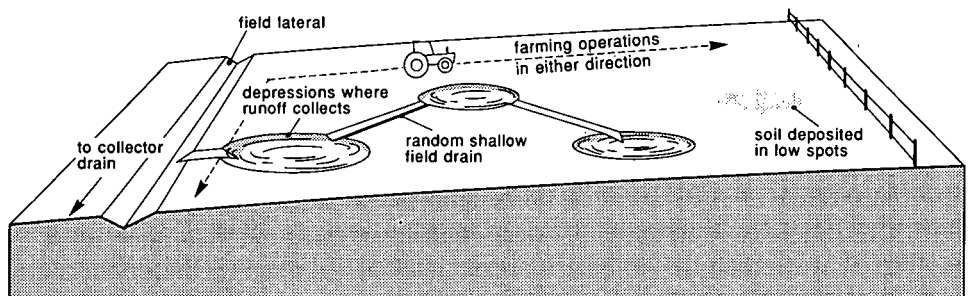

Field lateral should be 0.1 to 0.3 m deeper than the surface field drains. This will provide complete drainage for random field drains so they can be crossed with farm machinery.

Figure 20.11 The random field drainage system (after SCS 1971)

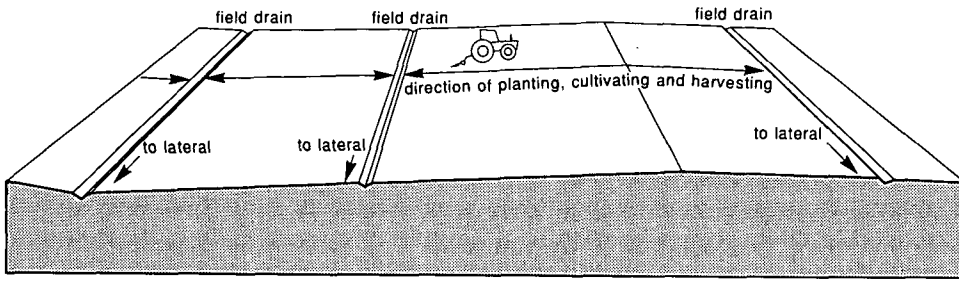

Figure 20.12 The parallel drainage system (after SCS 1971)

most effective method of surface drainage. Figure 20.12 shows a typical lay-out. The system is applicable in flat areas with an irregular micro-topography and where farm operations require regular shaped fields.

The parallel, but not necessarily equidistant, field drains collect the surface runoff and discharge it into the field lateral, through which the water flows towards the main drainage system. The spacing of the field drains depends on the size of lands that can be prepared and harvested economically, on the water tolerance of crops, and on the amount and the cost of land forming (Section 20.2.2).

Where subsurface drainage can be used in conjunction with surface drainage, the field drain spacing needs to be adjusted to the requirements of the subsurface drains. The combined system is referred to as 'Parallel Open Ditch System'. In this case, the ditches function as subsurface drains and are deeper (and steeper) than those of the 'Parallel Field Drainage System'. The ditches cannot be crossed by farm machinery and farming operations are to be done parallel to these ditches. To ensure good surface drainage, 'row drains' should be ploughed from field rows towards the field drain. The system of combined surface and subsurface drains is often applied in peat and muck soils.

20.5 Surface and Subsurface Drainage

20.5.1 Combination of Drainage Systems

The surface drainage measures discussed in the previous sections are aimed at the orderly removal of excess water from the surface. In the absence of these measures, the ponded water and saturated soil will eventually dry up by evapotranspiration and by percolation towards the groundwater. The recharge of the groundwater will induce a rise of the watertable. Consequently, if these lands are to be drained by subsurface drainage, the required capacity will be greater than when a surface drainage system is also available.

Research into this relationship has shown that in some cases benefits can be obtained by combining the two systems. Much depends on the combination of factors like the intensity and duration of rainfall, surface storage, soil physical characteristics (e.g. infiltration rate and hydraulic conductivity), and the groundwater condition (Skaggs 1987).

Schwab et al. (1974) have conducted many years of experiments on the combination of subsurface and surface drainage in heavy soils under different crops. Some of their findings are shown in Figure 20.13.

The yields of all treatments dropped considerably in 1969, which was very dry. In 1970 and 1971, yields in the plots with subsurface drainage (pipe drains) recovered, but the recovery was less in the surface drained plot. This effect was attributed to the progressive deterioration of the soil structure resulting from continuous monocropping and compaction by machinery. The subsurface drainage was apparently able to maintain a good physical soil structure whereas surface drainage was not.

Experiments on surface storage development with time (after land ploughing or harrowing) indicate that the surface condition is not constant throughout a cropping period (see Figure 20.14). As a consequence, the flow of surface runoff for a similar rainfall period at the start or at the end of a cropping season will be different, as will be the subsurface drainage flow.

Skaggs et al. (1982) investigated crop yield as related to surface storage after land grading for surface drainage and the spacing of subsurface drainage. An example of their findings is given in Figure 20.15. It shows that good surface drainage (i.e. low surface storage) leads to higher yields at the same drain spacing, or that wider drain spacings are possible to obtain the same yield.

Intermediate Solutions

Between surface drainage as described above and subsurface drainage by means of pipes, a number of intermediate solutions can be selected to improve the water conditions at the surface and in the rootzone.

For instance, if water conditions in the topsoil are poor because of the occurrence of a hard pan at shallow depth (0.2–0.4 m) in otherwise physically good soil, deep ploughing or scarifying can be an appropriate measure.

If the impermeable layer is at greater depth (0.4–0.8 m), mole drainage (Chapter 21) can reduce saturation of the top soil by enhancing shallow subsurface flow to the field drains.

For soils with surface layers that are susceptible to crusting (thus hampering

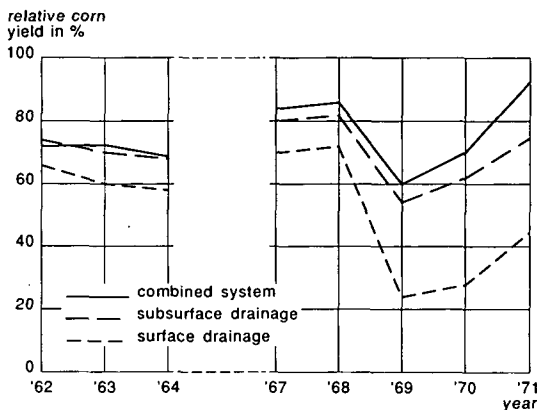

Figure 20.13 Yield development of corn under different drainage systems (after Schwab et al. 1974)

average depth of storage in mm

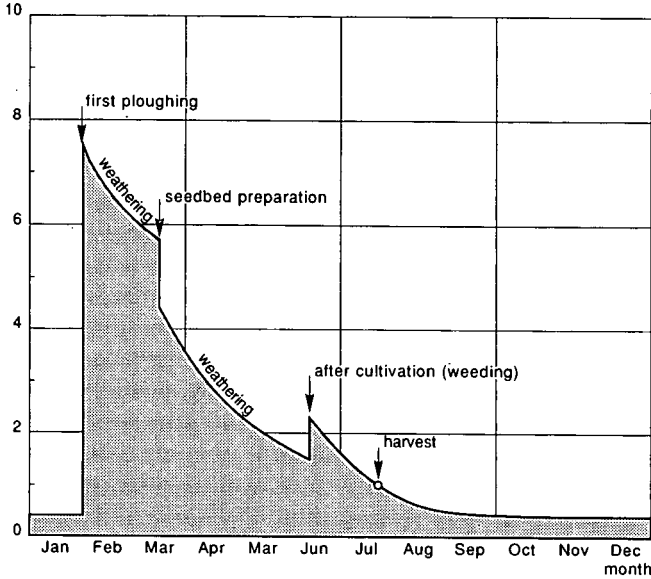

Figure 20.14 Annual variation in surface storage for a clay loam soil on row-crop land bedded for individual crops (after Gayle and Skaggs 1978)

relative yield

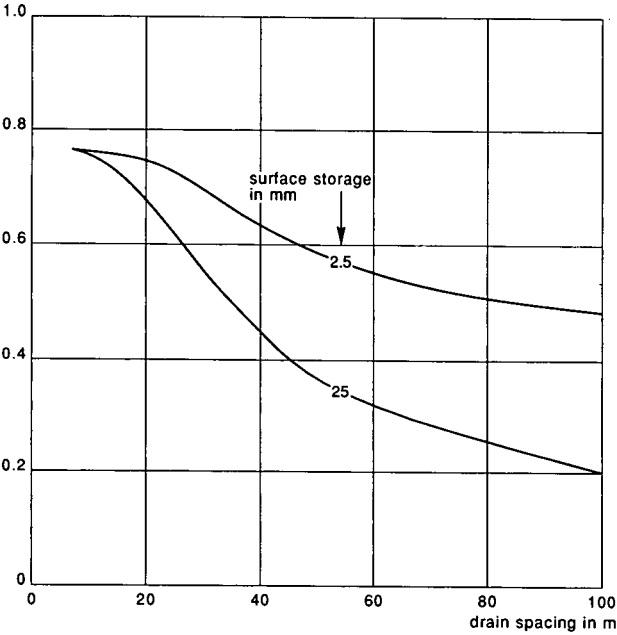

Figure 20.15 Relative yields for different tile drain spacings and quality of surface drainage (after Skaggs et al. 1982)

infiltration), mulching under permanent crops and repeated harrowing in annual crops can help to improve infiltration.

In some countries, trenches made for subsurface drainage are backfilled with gravelly material to enable surface drainage to flow directly into the subsurface drains.

Figure 20.16 shows how different solutions can be combined. Most of them are of a temporary nature and need to be repeated when symptoms of stagnant water reappear at the surface.

20.5.2 Land Forming and Farm Size

As land grading and planing are most effectively done by large machinery, the farm size in which they can be applied is usually also large. Figure 20.17 shows a farm of 230 ha in Australia where surface drainage and irrigation were improved by extensive land levelling. At the same time, the transformation of the fields enabled more rational (mechanized) farming operations.

In developing countries, where farm sizes are usually much smaller, land grading and planing within one farm can hardly be realized. The land units where these operations would be effective are far larger than a single farm.

To obtain good surface drainage by modern land forming, the operations could be done on the scale of blocks consisting of groups of farms. In newly reclaimed areas, the land could be allocated to farmers after land forming has been completed. In existing agricultural areas, however, this often implies a reallocation of lots under a land consolidation program.

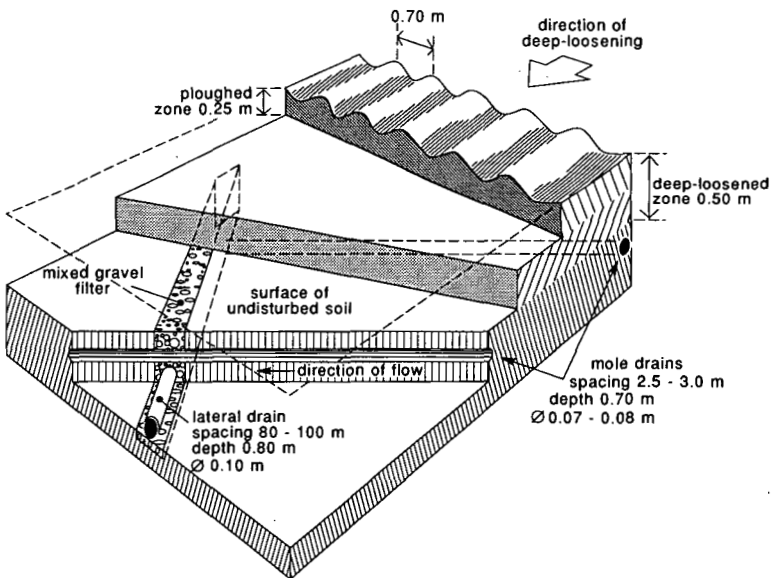

Figure 20.16 Intermediate drainage solutions

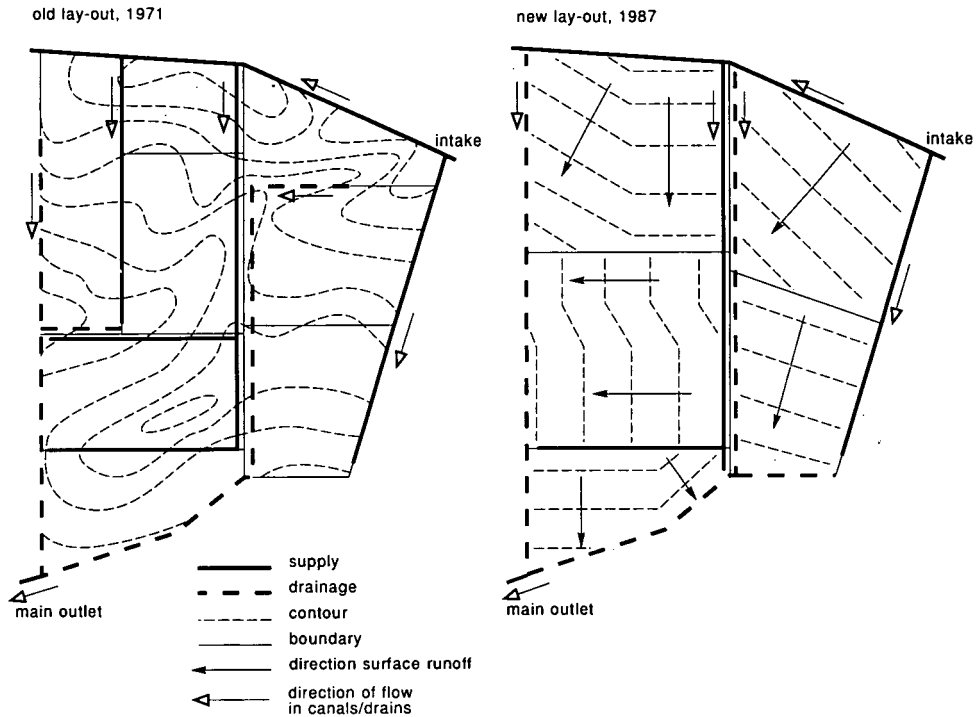

Figure 20.17 Example of land forming to improve surface drainage and irrigation performance and to rationalize farm operations (Australia)

In small-scale situations, the field drains collecting surface runoff from graded land should not belong to individual farmers, but rather to the drainage block, as in small-scale irrigation systems where tertiary canals belong to tertiary units (Figure 20.18).

20.6 Surface Drainage Systems for Sloping Areas

The surface drainage methods applied in sloping areas (slopes $> 2\%$) are closely related to those of erosion control. The methods comprise the creation of suitable conditions to regulate or intercept the overland flow before it becomes hazardous as an erosion force. This usually means some form of terracing.

Drainage and erosion control are not the only reasons why sloping lands are terraced. Sometimes the objective is water conservation. If so, bench-type or step-type terraces are constructed (Figure 20.19). The original slope of the land is altered to form a number of horizontal steps.

Terraces applied for drainage and erosion control are basically of two types:

- The cross-slope drainage system;
- The standard erosion-control terrace.

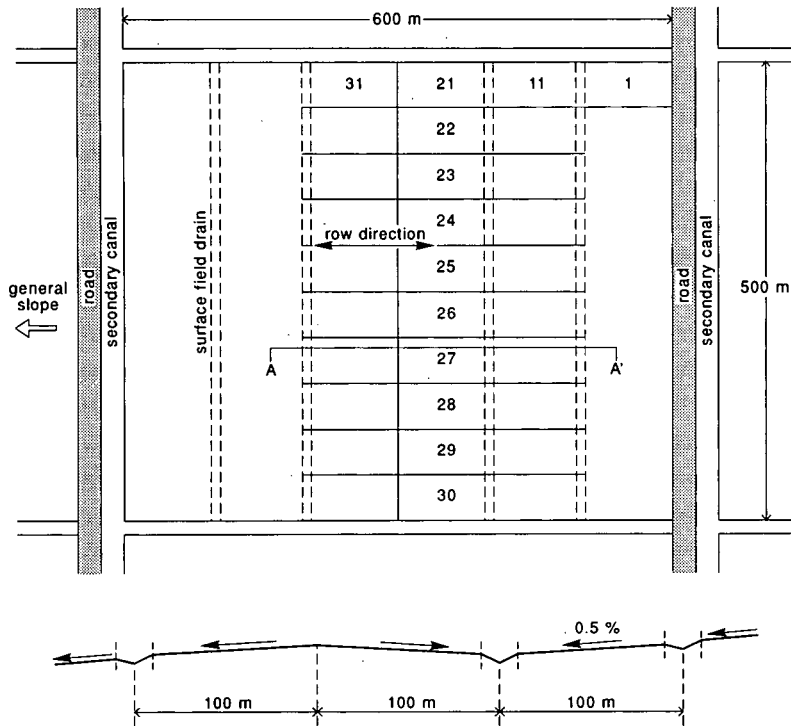

CROSS-SECTION A - A'

Figure 20.18 Small-scale farming in land-forming block (parallel field drainage block)

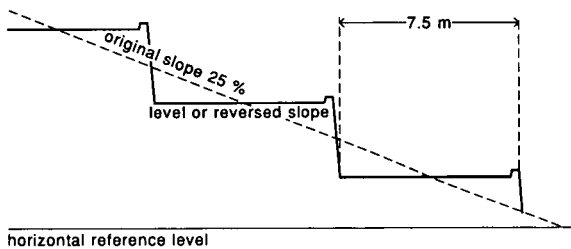

Figure 20.19 Cross-section of a bench terrace system

20.6.1 Cross-Slope Drainage System

The cross-slope drainage system (Figure 20.20) is a channel-type graded terrace, also called a Nichols terrace. It is used on lands with a slope of up to 4%, where flat-land systems would be impracticable in view of erosion hazards. The cross-slope system resembles the parallel field drainage system. It is effective on soils with poor drainage characteristics and where the overall slopes are rather regular but where many minor depressions occur.

The drains should run approximately parallel to the contours of the land, with a

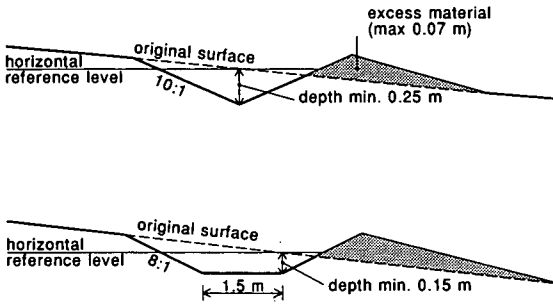

Figure 20.20 Cross-sections of cross-slope drains

uniform or variable grade of between 0.1 and 1% (or a mean of 0.5%), depending on the topography. The use of a variable grade often permits a better alignment of the terrace and a better fit of the terrace to the field. The soil surface between the drains must be smoothed (not graded) and all farming operations should be done parallel to the drains. Spoil from the drains can be used to fill up minor depressions or can be spread out to form a thin layer of not more than 0.07 m on the downslope side of the drains (Figure 20.20).

Cross-slope drains can have either a triangular or a trapezoidal shape, with side slopes ranging from 1:4 to 1:10. Their cross-sectional area can vary from 0.4 to 0.7 m². Depths will be between 0.15 and 0.25 m and the top width from 5 to 7 m. The maximum length of a drain is about 350 to 450 m. The distance between the drains depends on the slope, the rainfall intensity, the erodibility of the soil, and on the crops that will be grown, but are usually between 30 to 45 m.

With the cross-slope drainage system, between 80 and 100% of the water contained in the drain is below the original land surface, which reduces the harmful effects of a possible break in the downslope bank.

20.6.2 Standard Erosion-Control Terrace

The standard erosion-control terrace (Figure 20.21) is a ridge-type graded terrace, also called a Magnum terrace, and is used on lands that slope as much as 10%.

The difference between the cross-slope drain and the erosion-control terrace is that with the latter the spoil from the channels is used to build a relatively high ridge on the downslope side. In such channels, only 50% of the water is contained below the

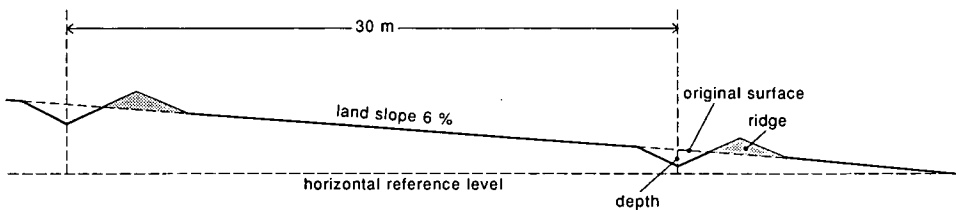

Figure 20.21 Standard erosion-control terrace

original land surface. Greater storages would require greater amounts of earthmoving and would increase the risk of the ridges rupturing.

Like the cross-slope drains, the channels of the erosion-control terraces should run approximately parallel to the contours of the land, with a uniform or variable grade of between 0.1 and 0.6%, depending on the topography. Natural impediments and sharp curves should be avoided.

The distance between the channels is governed by the same factors as the cross-slope drains.

The length of the terraces will usually depend on the location of a suitable disposal ditch. Terraces should not be so short that they impede farming operations, nor so long that the channels would require too great a cut. The maximum length of a terrace channel draining to one side only is about 350 or 450 m.

The flow velocity in the terrace should not exceed 0.6 m/s, although on sandy soils 0.45 m/s is more suitable and 0.3 m/s on pure sands.

20.6.3 Water Disposal in Sloping Areas

In sloping areas, where the field drains run approximately parallel to the contours, the water must be disposed of by a drainage channel which runs downslope. The slope is usually so steep that such channels will have to be lined or fitted with overflow or drop structures to prevent scouring (Chapter 19.7).

In certain circumstances, vegetated waterways can be used. The vegetational cover reduces the flow velocity of the water while at the same time allowing a comparatively high velocity. Permanent, dense, sod-forming grasses are the most suitable. The choice will depend on climate, soil, and available species.

Allowable velocities in erosion-resistant soil covered by dense grass vegetation are 2 m/s for slopes to 5% and 1.75 m/s for slopes of 5 to 10%. In easily erodible soils, the allowable velocities in densely grassed channels are 1.50 m/s with slopes to 5% and 1.25 m/s with slopes of 5 to 10%.

Vegetation other than grasses can be used on slopes of up to 5%. The allowable velocities are then 1 m/s on erosion-resistant soil and 0.50 m/s on easily erodible soil.

In the design of vegetated waterways, the roughness coefficient of the Manning's formula is taken as $n = 0.04$, a value corresponding with that for freshly cut grass. Where the maximum run-off occurs in periods when the vegetation has a higher retarding capacity than freshly cut grass, some 0.10 to 0.15 m should be added to the calculated design depth to ensure that no overtopping occurs. More details on the design of vegetated channels are presented in Chapter 19.5.3.

The waterway can be parabolic, triangular, or trapezoidal. Side slopes should not be steeper than 1:4 to allow the passage of farm machinery. Minimum bottom width is 2.5 m. When the discharge is known and the side slopes and allowable flow velocity have been chosen, the most suitable combination of bottom width, water depth, and grade can be calculated.

Other points to consider are that:

- A vegetated waterway should not be continuously wet; otherwise the vegetation cover will deteriorate. If groundwater is flowing into the waterway, it should be

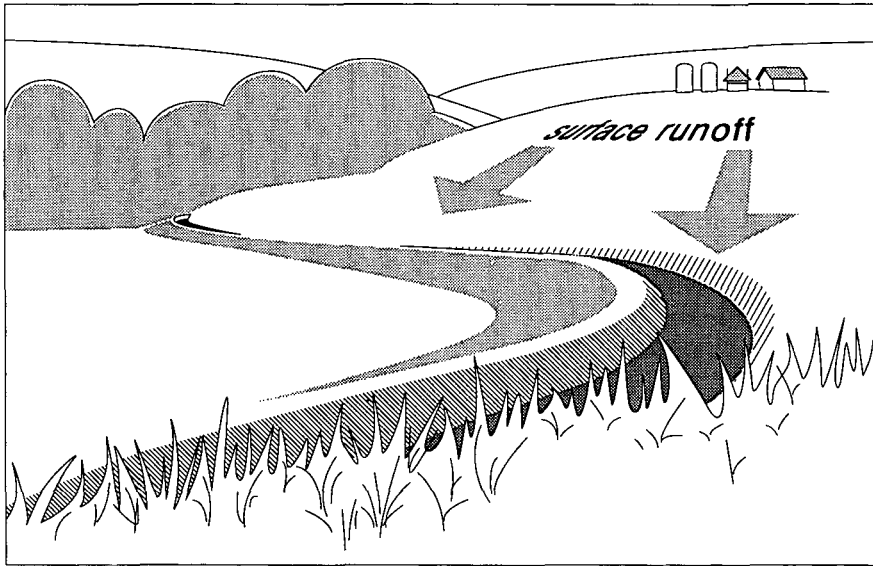

Figure 20.22 The diversion drain

intercepted by a pipe drain. Surface water can be carried off by a small concrete or asphalt trickle channel constructed at the bottom of the waterway;

- The fertility of the soil in the vegetated waterways should be maintained (manuring);
- Seeding mixtures should include quick-growing annuals and hardy perennials; sometimes sodding may be necessary;
- The vegetation should be properly maintained and the waterway should not be passed with farm machinery when it is still wet;
- Special attention should be paid to the terrace outlets; the vegetation cover may be extended over a small distance into the terrace channel;
- Geotextiles can be used to stabilize the soil surface during the establishment of grass seedlings (Schwab et al. 1981).

20.6.4 Diversion or Interceptor Drains

To protect flat areas from flooding by surface runoff from adjacent higher grounds, a diversion or interceptor drain can be constructed at the foot of these uplands (Figure 20.22). For areas not larger than 2 to 2.5 ha at the most, the diversion or interceptor drains can be constructed like terraces; for larger areas they should be constructed as grassed waterways.

To prevent diversion or interceptor drains from silting up, a filter strip can be constructed on the upslope side of the ditch. A depth of 0.45 m for the drain and a cross-sectional area of about 0.70 m² are considered minimum values.

References

- American Society of Agricultural Engineers 1980. Design and construction of surface drainage systems on farms in humid areas. ASAE Engineering Practice: ASAE EP 302-2. Agricultural Engineers Handbook 1980, pp. 453-460.
- Anderson, C.L., A.D. Halderman, H.A. Paul and E. Rapp 1980. Land shaping requirements. In: Jensen, M.E. (ed.), Design and operation of farm irrigation systems. ASAE Monograph, St. Joseph, U.S.A. pp. 281-314.
- Beauchamp, K.H. 1952. Surface drainage of light soils in the Midwest. *Agr. Eng.*, 33, 4, pp. 208-212
- Bligh, F.L. 1963. Land forming for irrigation, drainage, erosion control and efficient farm management. ICID, 5th Congress, Tokyo, Japan.
- Coote, D.R. and P.J. Zwerman 1970. Surface drainage of flat lands in the Eastern U.S. Cornell. Univ. Est. Bull. 1224, 48 p.
- Gayle, G.A. and R.W. Skaggs 1978. Surface storage on bedded cultivated lands. *Trans. ASAE* 21, 1, pp. 101-104, 109.
- Haynes, H.D. 1966. Machinery and methods for constructing and maintaining surface drainage on farm lands in humid areas. *Trans. ASAE*, 9, 2, pp. 185-189, 193.
- ICID Committee on Irrigation and Drainage Construction Techniques 1982. ICID standard 109, Construction of surface drains. *ICID Bulletin*, 31,1, pp. 47-57.
- Sahat Matondang, Dedi Kusnadi and Sutardjo 1986. Lowland for agricultural development: soil condition and water management. In: Symposium on Lowland Development in Indonesia. Research Papers IIRI, Wageningen. pp. 291-303.
- Schwab, G.O., N.R. Fausey and D.W. Michener 1974. Comparison of drainage methods in a heavy textured soil. *Trans. ASAE*, 17, 3, pp. 424, 425, 428.
- Schwab, G.O., R.K. Frevert, T.W. Edminster and K.K. Barnes 1981. Soil and water conservation engineering. 3rd ed. Wiley, New York, 525 p.
- Skaggs, R.W. 1987. Principles of drainage. In: G.A. Pavelis (ed.), Farm drainage in the United States : history, status and prospects. U.S. Dept. of Agr. 170 p.
- Skaggs, R.W., S. Hardjoamidjojo, E.H. Wisner and E.A. Hiler 1982. Simulation of crop response to surface and subsurface drainage systems. *Trans. ASAE*, 25, 6, pp. 1673-1678.
- Smedema, L.K. and D.W. Rycroft 1983. Land drainage: planning and design of agricultural drainage systems. Batsford, London, 376 p.
- Soil Conservation Service 1971. Chapter 3. Surface drainage. In: National engineering handbook, Section 16, Drainage of agricultural land. U.S. Dept. of Agric., Washington.
- Soil Conservation Service 1983. Chapter 12. Land leveling. In: National engineering handbook, Section 15, Irrigation. U.S. Dept. of Agric., Washington.
- Zelhorst, L. 1969. Verandering van het maaiveld door het ploegen met variabele diepten (het rondploegen van akkers). Rijksdienst voor de IJsselmeerpolders, Flevovericht 71, Lelystad, 15 p.

21 Subsurface Drainage Systems

J.C. Cavelaars¹, W.F. Vlotman² and G. Spoor³

21.1 Introduction

This chapter is about the implementation of subsurface drainage systems – an implementation that should result in a long-lasting system, functioning according to the design. This means that the subject matter is mainly of a practical nature.

Subsurface drainage aims at controlling the watertable – a control that can be achieved by tubewell drainage, open drains, or subsurface drains (pipe drains or mole drains). This chapter, after comparing open drains and pipe drains (Section 21.2), will focus on pipe drains, briefly discussing mole drains at the end (Section 21.9).

There are three main phases in the implementation of pipe drainage systems: its design, installation, and operation and maintenance. These three subjects form the core of this chapter; they will be treated in Sections 21.3, 21.4, and 21.5, respectively. The theory of subsurface flow to drains has been discussed in previous chapters (e.g. Chapters 7 and 8), but not the hydraulics of drainage pipes nor the flow conditions in the vicinity of a drain pipe. These two subjects will be treated in Sections 21.6 and 21.7. They deal with drain-line performance, as opposed to the more general concern for system performance in most drainage theory. A section on the testing of pipe drainage (Section 21.8) is included, and, as already stated, Section 21.9, on mole drainage, completes this chapter.

21.2 Types of Subsurface Drainage Systems

If one has decided to install a subsurface drainage system, one has to make a subsequent choice between tubewell drainage, or open, pipe, and mole drains. Tubewell drainage (Chapter 22) and mole drainage (Section 21.9) are applied only in very specific conditions. Moreover, mole drainage is mainly aimed at a rapid removal of excess surface water, rather than at controlling the watertable.

The usual choice is therefore between open drains and pipe drains. This choice has to be made at two levels: for field drains and for collectors. If the field drains are to be pipes, there are still two options for the collectors:

- Open drains, so that we have a ‘singular pipe-drain system’;
- Pipe drains, so that we have a ‘composite pipe-drain system’.

Open drains have the advantage that they can receive overland flow directly, but the disadvantages often outweigh the advantages. The main disadvantages are a loss of land, interference with the irrigation system, the splitting-up of the land into small

¹ Retired from Heidemaatschappij, Arnhem

² Co-author of Section 21.6, Hydraulics of drainage pipes,
International Institute for Land Reclamation and Improvement

³ Author of Section 21.9, Mole drainage. Silsoe College, England

parcels, which hampers (mechanized) farming operations, and a maintenance burden. Nevertheless, there are cases where open drains are used exclusively. Some examples are:

- As a temporary measure in unripened alluvial soils of newly reclaimed lake bottoms or coastal land:
Initially, these soils are virtually impermeable and the open drains initiate an aeration process which causes the development of soil structure and hence an increase in hydraulic conductivity (Chapter 13). After a few years, the open drains are replaced by pipe drains;
- In peat soils:
To avoid undue subsidence, only shallow watertables are desired, say about 0.5 m below the land surface. This can be maintained by a network of narrowly-spaced open drains. As far as is possible, oxidation of the top soil is then prevented. An approximately similar principle applies to acid sulphate soils to prevent the oxidation (and thus acidification) of deeper soil layers;
- In very saline land under a monoculture of rice:
A network of open drains provides the required surface drainage, and a limited additional subsurface drainage is needed for salinity control. This subsurface drainage component can often be achieved by giving the open drains some extra depth; to install pipe drains would be grossly overdone.

Combined Surface and Subsurface Drainage Systems

Combined systems of surface and subsurface drainage may be appropriate in particular situations, as was discussed in Chapter 20.5.1. A few examples are:

- A soil profile with a layer of low permeability below the rootzone, but good permeability at drain depth:
This is a profile that can be found in alluvial soils throughout the world. After heavy rain, a perched watertable forms in the rootzone, and cannot be lowered rapidly enough without some form of surface drainage. Subsurface drainage subsequently draws down the watertable to a normal depth. An alternative solution may be to break up the impeding layer by subsoiling, especially if the impeding layer is less than about 0.3 m thick;
- Areas with deep frost penetration and snow cover during winter:
When the snow melts and the topsoil thaws, but soil at some depth is still frozen, a perched watertable will form and will damage a crop of winter grain. The same measures as in the previous example are required here;
- Irrigated land in arid and semi-arid regions, where the cropping pattern includes rice in rotation with 'dry-foot' crops (e.g. as in the Nile Delta in Egypt):
Subsurface drainage is needed for salinity control of the dry-foot crops, whereas surface drainage is needed to evacuate the standing water from the rice fields (e.g. before harvest);
- Areas with occasional high-intensity rainfall that causes water ponding on the land surface, even if a subsurface drainage system is present:
The ponded water could be removed by the subsurface drainage, but this would either take too long or require very narrow drain spacings. In such circumstances, it would be more efficient to remove the ponded water by surface drainage.

21.3 Design of Pipe Drainage Systems

21.3.1 Detailed Project Design

Pipe drainage projects can vary widely in scope and size. A project may be a single farm, or it may cover many thousands of hectares. In this chapter, we shall assume a comprehensive large-scale project, because it offers a suitable setting to discuss all the relevant aspects. In Chapter 18, the train of events in such a comprehensive project was reviewed: from its first conception, through the final acceptance of works by the project authorities, to its operation, management, and maintenance.

The implementation of a drainage project draws heavily upon the post-authorization (or detailed design) study – the result of which is laid down in the tender documents in the form of maps, drawings, lists, tables, and written specifications. This is the stage when the technical design of the pipe drainage system is detailed. It may therefore be useful to list the main items that are to be specified in such a detailed design, and the documents that have to be prepared for it. These are:

- The layout of the drainage network, showing:
 - The alignment of all major drains (collectors and mains), indicated with a clear and consistent numbering system (Chapter 19);
 - Field drains are usually not indicated individually. Instead, in a given block, only the first and last drains are drawn; spacing and depth are indicated in writing;
- Open drains:
 - Dimensions (in cross-sections);
 - Bed level and slopes (elevations with respect to a well-defined benchmark): on longitudinal profiles, or, sometimes, in tables;
 - Water levels at design discharge: longitudinal profiles or tables;
- Pipe drains:
 - Spacing and depth of field drains, indicated on map;
 - Diameters and slopes, elevation of outlet;
 - For collectors: longitudinal profiles and/or tables;
- Materials and structures:
 - For pipe drains: pipes, envelope materials, connections between field drains and collectors, outlets;
 - For open drains: bridges, culverts.

The specifications relate to:

- Technical specifications: dimensions, elevations (drawings);
- Quality requirements;
- Construction specifications: for certain items, it might be necessary to specify working methods (as will be discussed in Section 21.4).

Against the above background, this section presents an overview of the materials and structures used in pipe drainage systems. It then goes on to discuss the design of field and collector drains, and the layout of drainage systems.

More details are given in e.g. Schultz (1990), Framji et al. (1987), and Smedema and Rycroft (1983).

21.3.2 Pipes

The materials used in the manufacture of drain pipes are clay, concrete, and plastics. Important criteria for pipe quality and for selecting the most suitable type of pipe are resistance to mechanical and chemical damage, longevity, and costs.

Mechanical damage and chemical deterioration may occur during transport and handling, or after the pipe has been installed. In addition, the lifetime of the pipes should not be unduly shortened by a deterioration in mechanical or chemical properties in the course of time. The costs are the total costs for purchase, transport, handling, and installation.

Clay Tiles

Clay tiles used to be the predominant type of drain pipes in Europe, from the first introduction of pipe drainage (before 1850), to about 1960-1970. These clay tiles had common diameters of 0.05 to 0.15 m, and came in lengths of 0.30 to 0.33 m. Their ends were either straight or had a collar, with a less-than-perfect fit so that the water could enter through the joints. The chemical stability and longevity of good-quality pipes are excellent (think of archaeological pottery finds!).

Criteria for testing the quality of clay pipes are: shape (they should be straight, with straight-cut ends), absence of fissures and cracks (which can be judged by the sound when the pipe is hit), and mechanical strength (breaking strength).

The manufacture of good-quality pipes requires considerable skill and a fairly large well-equipped production unit.

Concrete Pipes

Concrete pipes were used as field drains in various countries, until, like clay tiles, they virtually became obsolete with the introduction of plastic pipes. In larger diameters, concrete pipes are still commonly used as collectors. Concrete pipes can be manufactured in comparatively simple (mobile) production units that can easily be erected in the project area. There is practically no limit to their diameter, although for large diameters (i.e. over 0.4 m), the concrete must be reinforced. Pipe ends are either straight, have a collar, or a spigot-and-groove. Water entry is almost exclusively through the joints between pipe sections. For larger diameters, openings at the joints may become rather large, which is why some manufacturers supply rubber sealing rings.

Possible drawbacks of concrete pipes are their susceptibility to acidity and sulphate, which may be present in the soil. This susceptibility can be reduced to some extent with the use of sulphate-resistant cement, and by producing to a high manufacturing standard, so that high-density concrete is formed, which seals off the concrete from attack by soil chemicals.

Plastic Pipes

The introduction of plastic pipes for drainage started around 1960. Initially, straight-walled smooth pipes were used. Around 1970, corrugated pipes were introduced, which soon replaced the smooth pipes.

The major advantages of plastic over clay or concrete are the much lower weight per metre of pipe, and the greater length of pipe (at least several metres). This makes

transporting and handling the pipes a lot easier and cheaper, and it enables higher installation rates. A disadvantage is the pollution caused by the raw material (resin). Ex-factory prices of plastic pipes may be higher than for clay or concrete, but total costs may be lower because of a saving in the costs of transport, handling and installation.

The three predominant materials are polyvinyl chloride/PVC, high-density polyethylene/PE, and, to a minor extent, polypropylene/PP. When comparing PVC and PE, we find that the dark-coloured PE is more affected by high temperatures than the light-coloured PVC. Consequently, the risk of deformation of PE pipes is greater than for PVC pipes. On the other hand, PVC, being more sensitive to low temperatures, becomes brittle when exposed to temperatures below freezing point. In addition, PVC is more sensitive to ultra-violet radiation (sunshine), which may cause irreversible deterioration of mechanical properties (brittleness). PVC pipes should therefore not be stored in bright sunlight.

Plastic pipes, whether PVC, PE, or PP, are resistant to all chemicals that may occur in agricultural soils.

A comparison between corrugated and smooth plastic pipes may shed some light on the preference for corrugated pipes:

- Corrugated pipes have a greater resistance to outside pressure for the same amount of plastic material, or, conversely, a given strength can be achieved with less material. Since the cost of plastic pipe is approximately proportional to its weight, this means a lower cost;
- Corrugated pipes have a greater flexibility, so that they can be coiled and are easier to install. Corrugated pipe is virtually the only suitable type for trenchless drain installation;
- A small disadvantage of corrugated pipes, connected with the coiling, is that, after being unrolled on the drainage machine, the pipes have a tendency to 'spiral' in the trench (because of the 'plastic memory');
- Pipes with large corrugations (as a rule corresponding with larger diameters) have a comparatively high flow resistance and thus a reduced discharge capacity (Section 21.6). Certain special types are partly double-walled, so that they have a smooth inside wall (Figure 21.1). This provides considerable extra strength and, for equal diameter, a higher discharge capacity.

The outer diameter of corrugated plastic pipes ranges from 0.05 to 0.40 m. The height of the corrugations is between 5% of the pipe diameter (for small diameters) and 8% (for large diameters). Water enters through perforations in the bottom of the corrugations. These perforations are 0.6 to 2 mm long and 0.6 to 1 mm wide.

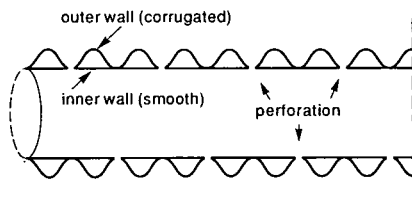

Figure 21.1 Double-walled corrugated plastic drain pipe

It should be noted that the inflow of water is not restricted by the total area of inlet openings, but by their distribution over the pipe circumference, as will be discussed in Section 21.7.

Quality Standards

Quality standards for drain pipes have been specified on a national basis and thus differ between countries, partly reflecting the different conditions under which the pipes are used. Items commonly specified in quality standards are: a general material test as an indication of the chemical properties, dimensions (with tolerances) of pipes and auxiliary materials such as couplings and end pipes, and the size, number, and pattern of perforations. Other specifications concern pipe stiffness, impact strength, possible 'creep' (i.e deformation with time under a given stress), and flexibility.

In The Netherlands, quality is controlled through a system of certification. Manufacturers whose products meet the quality standards may carry a hallmark under the authority of the certifying organization. That organization carries out random checks in the factories.

21.3.3 Envelopes

A variety of terms are used for envelopes, reflecting the purpose and method of application. Common terms are: filter, cover material, and permeable fill. Below, we shall discuss the function of envelopes, their materials, qualitative guidelines, and quantitative specifications.

Functions of Envelopes

An envelope is defined as the material placed around pipe drains to perform one or more of the following functions:

- Filter function: to prevent or restrict soil particles from entering the pipe where they may settle and eventually clog the pipe;
- Hydraulic function: to constitute a medium of good permeability around the pipe and thus reduce entrance resistance;
- Bedding function: to provide all-round support to the pipe in order to prevent damage due to the soil load. Note that large-diameter plastic pipe is embedded in gravel especially for this purpose.

The first two functions provide a safeguard against the two main hazards of poor drain-line performance: siltation and high flow resistance in the vicinity of the drain, as will be discussed in Section 21.7.

In view of its functions, the envelope should, ideally, be so designed that it prevents the entry of soil particles into the pipe, although a limited flow of clay particles will do little harm, because they mainly leave the pipe in suspension. The filtering effect, however, should not be such that the envelope, while keeping the pipe free of sediment, itself becomes clogged. If that happens, the hydraulic function is jeopardized.

Apart from these conflicting filtering and hydraulic functions, the formulation of functional criteria for envelopes is complicated by a dependence on soil characteristics (mainly soil texture) and installation conditions. Despite considerable research efforts

over the past 30 years, firm quantitative criteria are still far from established. Instead, to a large extent, drainage practice works with qualitative, empirical guidelines.

Envelope Materials

A wide variety of materials are used as envelopes for drain pipes, ranging from organic and mineral material, to synthetic material and mineral fibres.

Organic material is mostly fibrous, and includes peat – the classical material used in Western Europe – coconut fibre, and various organic waste products like straw, chaff, heather, and sawdust. Mineral materials are mostly used in a granular form; they may be gravel, slag of various kinds (industrial waste products), or fired clay granules. Synthetic materials may be in a granular form (e.g. polystyrene) or in a fibrous form (e.g. nylon, acryl, and polypropylene). Glass fibre, glass wool, and rock wool, which all are mineral fibres, are also used,

Envelope materials are applied in bulk, as thin sheets, or as more voluminous 'mats'. Bulk application is common for gravel, peat litter, various slags, and granules. The classical method is to spread the material after the pipe has been laid in the trench, so that the material will protect the top and the sides of the pipe. A complete surround (e.g. with gravel) is achieved by first spreading gravel on the trench bottom, then laying the pipe, and again spreading gravel.

Thin sheets are commonly used with corrugated plastic pipe as a pre-wrapped envelope. They may consist of glass fibre or synthetic fibres, which are also known as geotextiles. More voluminous mats of up to about 10 mm thick normally consist of fibrous materials, whether they be organic materials, synthetic fibres, or mineral fibres. These mats are often used as pre-wrapped envelopes with plastic pipes, but they can also be used in the form of strips. One such a strip may be placed only on top of the pipe, or another strip may be placed below the pipe, thereby making it suitable in combination with any type of pipe (clay, concrete, or plastic).

Envelope Requirements in Relation to Soil Characteristics

Qualitative guidelines for designing drain envelopes mainly consider soil texture. Straightforward rules can be given for fine- and coarse-textured soils. For soils in the intermediate texture classes, there is considerable uncertainty.

Fine-textured soils with a clay content of more than about 0.25 to 0.30 are characterized by a high structural stability, even if being worked under wet conditions. Thus, with trencher-installed pipe drains, no problems are to be expected and an envelope is not required. With trenchless drainage, however, one could easily work below the critical depth (Section 21.4.2), especially in wet conditions, resulting in a high entrance resistance. An envelope is not likely to be of any help. Clogging of the pipe is not to be expected.

Coarse-textured soils free of silt and clay, on the other hand, are permanently unstable, even if undisturbed. Thus, soil particles are likely to wash into the pipe, both from the trench backfill and from the undisturbed soil below the pipe. There is a need for a permanent envelope, completely surrounding the pipe, only as an effective filter, because there is no high entrance resistance. A thin geotextile envelope is probably the best solution here.

Soils of intermediate texture are less simple. In the finer-textured soils of this category (clay contents less than 0.25 to 0.30, but more than say 0.10 to 0.15), the

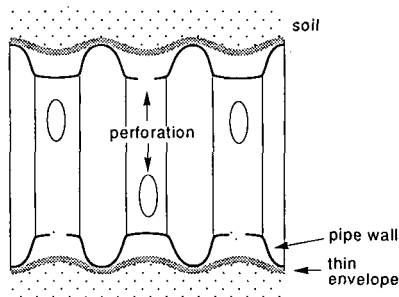

Figure 21.2 A corrugated drain pipe wrapped in a thin envelope

trench backfill will remain stable and of good permeability, provided that pipe installation is done under dry conditions and, in irrigated land, provided that the trench backfill was properly compacted. In those cases, even without an envelope, no problems will arise. If, however, the pipes were installed under wet conditions, both drain sedimentation and a high entrance resistance could follow. Hence an envelope would be needed. Most likely, only the trench backfill will create problems, because the undisturbed soil remains stable enough. As, assumedly, trench backfill stabilizes with time, an organic envelope, disintegrating in the course of a few years, would be adequate. A commonly applied guideline in The Netherlands is that the envelope should be 'voluminous' in order to fulfil its hydraulic function. Nevertheless, a thin filter sheet wrapped around a corrugated pipe will do the job equally well, because it ensures that water is conveyed towards the perforations (Figure 21.2).

At the coarse-textured side of the intermediate soils (soils with a clay content below 5% and a high silt content), the trench backfill is likely to be as unstable as the undisturbed soil below the pipe. In addition, the trench backfill may become poorly permeable through a re-arrangement of the soil particles. Therefore, an envelope which completely surrounds the drain, fulfilling both filter and hydraulic functions, is always needed in these soils.

Guidelines developed for The Netherlands are summarized in Table 21.1. It should be noted that an envelope, in spite of its general positive effect, is no guarantee against poor drain-line performance, particularly not if the pipes were installed under wet conditions.

Gravel Envelopes

The standard procedure for the design of gravel envelopes is to match the particle-size distribution of the soil with the particle-size distribution of the gravel. Several sets of design criteria to prevent base soil invasion into the envelope and the drain pipe have been developed (Table 21.2). Filter specifications were first developed by Terzaghi for hydraulic structures (Chapter 19). On the basis of Terzaghi's work, specifications for drain envelopes were developed by the British Road Research Laboratory (Spalding 1970), the USDA Soil Conservation Service (SCS 1988), and the U.S. Bureau of Reclamation (Winger and Ryan 1970). In these standards, the underlying requirements are that the envelope should fulfil both the filter and the hydraulic function, that particles from the envelope itself should not move through the perforations into the drain in significant amounts, and that the envelope should

Tabel 21.1 Recommendations on the use of the drain envelopes in The Netherlands based on soil type (after Van Zeijts 1992)

Soil				Envelopes*				
Type based on percentage clay and silt particles**	Geological formation	Remarks	Characteristics related to envelopes***	Function	Material			
					Gravel	Voluminous		Thin****
						Organic	Synthetic	
> 25% clay	Alluvial; marine/fluviatile	Ripe	Stable; high K	-	No envelope necessary			
		Unripe	Stable; low K	Hydraulic (temporary)	+	+	+	-
> 25% clay*****		Ripe	Unstable; high K	Filter	+	-	+	+
		Unripe	Unstable; low K	Filter and hydraulic	+	-	+	-
< 25% clay < 10% silt	Marine	d ₅₀ < 120	Unstable; high K	Filter	+	-	+	+
< 25% clay < 10% silt	Aeolian	d ₅₀ > 120	Initially unstable; high K	Filter (temporary)	+	+	+	+
< 25% clay > 10% silt	Aeolian, fluviatile or (fluvio) glacial		Initially unstable; low K	Filter (temporary) and hydraulic	+	+	+	-

* + = suitable; - = not suitable

** texture in soil profile above drain level, clay particles are < 2 μm and silt particles are 2-50 μm

*** high hydraulic conductivity: K ≥ 0.25 m/day, low K ≤ 0.05 m/day

**** only suitable if there is no risk for biochemical clogging

***** lighter layers (< 25% clay) in soil profile above drain level

not contain very coarse particles which could possibly damage the pipe during placement.

The application of the SCS and USBR criteria is illustrated in Figure 21.3, in which the grading limits for the required envelope are shown as a function of the grading curve of the soil. Some characteristic points on the particle-size-distribution curves of both soil and envelope are given in Table 21.3

As the example illustrates, the USBR criteria result in coarser-textured envelopes than the SCS criteria. This reflects the difference in background. The USBR operates in the mostly arid and semi-arid western states of the U.S.A., where pipe drainage for salinity control is applied on a large scale, with wide spacings, great depths, large-diameter pipes installed in wide trenches, and with large quantities of gravel envelope. Their emphasis is mainly on the hydraulic function of the envelope. The SCS operates in the humid eastern and central states of the U.S.A., where pipe drainage is comparatively small-scale, with narrower spacings, shallower depths, and smaller diameter pipes installed in narrower trenches. These conditions call for more emphasis on the filter function of the envelope.

Gravel is available in many countries and has proven to be a suitable envelope if properly installed. Nevertheless, although modern drainage machinery has facilities to install gravel automatically under and around the pipe, it remains a costly and difficult operation because of (Dierickx 1993):

- Uncertainties about gravel specifications and gravel shape (rounded or angular);

Table 21.2 Design criteria for gravel envelopes (after Vlotman et al. 1990)

A. USBR-CRITERIA

USBR filter design (Karpoff in Willardson 1974) for inverted filter with hydraulic structures

Uniform envelope (natural)	$D_{50}/d_{50} = 5-10$	
Graded envelope (natural)	$D_{50}/d_{50} = 12-58$	
	$D_{15}/d_{15} = 12-48$	
Graded envelope (crushed rock)	$D_{50}/d_{50} = 9-30$	
	$D_{15}/d_{15} = 6-18$	
General	$D_{100} \leq 80$ mm	to minimize segregation and bridging during placement
	$D_5 \geq 0.07$ mm	to prevent movement of fines
	$D_{\text{opening}} \leq 0.5 D_{85}$	opening of drain perforation to be adjusted to filter material used

USBR surround design (USBR 1978)

Base soil limits for	Lower limits (mm)						Upper limits (mm)					
	Percentage passing						Percentage passing					
	100	60	30	10	5	0	100	60	30	10	5	0
d_{60} (mm)												
0.020-0.050	9.52	2.0	0.81	0.33	0.3	0.074	38.1	10.0	8.7	2.5	-	0.59
0.050-0.100	9.52	3.0	1.07	0.38	0.3	0.074	38.1	12.0	10.0	3.0	-	0.59
0.100-0.250	9.52	4.0	1.30	0.40	0.3	0.074	38.1	15.0	13.1	3.8	-	0.59
0.250-1.000	9.52	5.0	1.45	0.42	0.3	0.074	38.1	20.0	17.3	5.0	-	0.59

B. SCS-CRITERIA (SCS 1988*)

SCS criteria for filter gradation

$D_{15} < 7 d_{85}$	but need not be smaller than 0.6 mm**
$D_{15} > 4 d_{15}$	
$D_5 > 0.074$ mm	% passing sieve No. 200*** less than 5%

SCS criteria for envelope (surround)

$D_{100} < 38.1$ mm	the whole sample should pass the sieve of 38 mm
$D_{30} > 0.25$ mm	% passing sieve No. 60 less than 30%
$D_5 > 0.074$ mm	% passing sieve No. 200 less than 5%
	minimum envelope thickness 76 mm

C. UNITED KINGDOM ROAD RESEARCH LABORATORY CRITERIA (Spalding in Boers and Van Someren 1979)

For filtration	$D_{15} \leq 5d_{85}$	for uniform soils ($C_u \leq 1.5$):	$D_{15} \leq 6d_{85}$
	$D_{15} \leq 20d_{15}$	for well-graded soils ($C_u \geq 4$):	$D_{15} \leq 40d_{15}$
	$D_{50} \leq 25d_{50}$		
For permeability	$D_{15} \geq 5d_{15}$		
	$D_{85} \geq \text{perforation width}/0.83$		

D. DESIGN CRITERIA FOR DOWNSTREAM PROTECTION OF HYDRAULIC STRUCTURES (Chapter 19, Section 19.6.3)

Permeability to water

Homogeneous round grains (gravel)	$D_{15}/d_{15} = 5-10$
Homogeneous angular grains (broken gravel, rubble)	$D_{15}/d_{15} = 6-20$
Well-graded grains	$D_{15}/d_{15} = 12-40$
To prevent clogging	$D_5 \geq 0.75$ mm

Stability (or prevention of loss of fines)

Uniform soil	$D_{15}/d_{85} \leq 5$
Homogeneous round grains (gravel)	$D_{50}/d_{50} = 5-10$
Homogeneous angular grains (broken gravel, rubble)	$D_{50}/d_{50} = 10-30$
Well-graded grains	$D_{50}/d_{50} = 12-60$

* Supersedes SCS standards 1971

** SCS concluded that $D_{15} < 0.6$ mm did not give additional benefit for filter working, Vlotman et al. 1992 suggest for drain envelopes $D_{15} \geq 0.3$ mm to maintain permeability

*** Sieve numbers refer to standard sieve set of the US

D_m sieve mesh (mm) through with m% of gravel material passes

d_m sieve mesh (mm) through with m% of bare soil material passes

C_u coefficient of uniformity ($= d_{60}/d_{10}$ or D_{60}/D_{10})

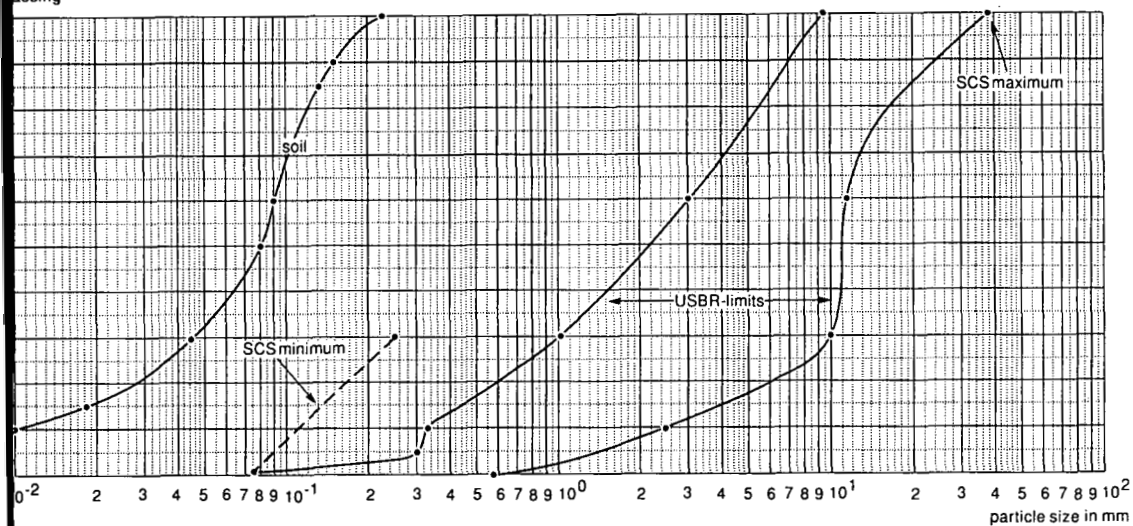

Figure 21.3 Example of the design of a gravel envelope using the SCS and the USBR criteria

- Lack of uniform quality and gradation of gravel;
- Segregation during transport and installation;
- 'Flowability' problems in the supply chute of the drainage machine;
- Unequal distribution around the drain pipe;
- High demand on logistics (see Section 21.4.4).

Synthetic Envelopes

Many of the drawbacks of gravel envelopes can be overcome with the use of synthetic envelopes. The wide variety in their materials, however, and in their characteristics

Table 21.3 Example of the design of a gravel envelope using the SCS and USBR criteria

d_m (mm)	Particle size (mm)				
	Soil	Envelope			
		Criteria SCS		Criteria USBR	
		Minimum	Maximum	Minimum	Maximum
d_0			0.074	0.59	
d_5	0.002	0.074	0.3		
d_{10}	0.010		0.38	3.0	
d_{15}	0.018				
d_{30}	0.044	0.25	1.07	10.0	
d_{50}	0.08				
d_{60}	0.09		3.0	12.0	
d_{85}	0.13				
d_{100}	0.23	38.1	9.5	38.1	

Table 21.4 Design criteria for synthetic and organic envelopes (after Dierickx 1993)

Reference	Geotextile	Soil	Criteria	Remarks
Calhoun (1972)	Woven	Cohesionless ($d_{50} \geq 74 \text{ mm}$) Cohesive ($d_{50} < 74 \text{ mm}$)	$O_{95}/d_{85} \leq 1$ $O_{90} \leq 200 \text{ }\mu\text{m}$	Dry sieving, glass bead fractions
Ogink (1975)	Woven Nonwoven	Sand Sand	$O_{90}/d_{90} \leq 1$ $O_{90}/d_{90} \leq 1.8$	Dry sieving, sand fractions
Zitscher (1975) in Rankilor (1981)	Woven	$C_u \leq 2$ $100 \text{ }\mu\text{m} \leq d_{50} \leq 300 \text{ }\mu\text{m}$	$O_{50}/d_{50} \leq 1.7\text{-}2.7$	
Sweedand (1977)	Nonwoven	$C_u = 1.5$ $C_u = 4.0$	$O_{15}/d_{85} \leq 1$ $O_{15}/d_{15} \leq 1$	
ICI Fibers (1978) in Rankilor (1981)	Nonwoven	$20 \text{ }\mu\text{m} \leq d_{25} \leq 250 \text{ }\mu\text{m}$ $d_{85} > 250 \text{ }\mu\text{m}$	$O_{50}/d_{85} \leq 1$ $O_{15}/d_{15} \geq 1$	
Schober and Teindl (1979)	Woven and thin nonwoven	Sand	$O_{90}/d_{50} \leq B_1 (C_u)$	Dry sieving, sand fractions B_1 and B_2 are factors depending on C_u : $B_1(C_u) = 2.5\text{-}4.5$ $B_2(C_u) = 4.5\text{-}7.5$
	Thick nonwoven	Sand	$O_{90}/d_{50} \leq B_2 (C_u)$	
Millar, Ho and Turnbull (1980)	Woven and Nonwoven		$O_{50}/d_{85} \leq 1$ $O_{50}/d_{15} \geq 1$	
Giroud (1982)	Needle-punched nonwoven	Cohesionless less dense $1 < C_u < 3$ $C_u > 3$	$O_{95}/d_{50} < C_u$ $O_{95}/d_{50} < 9/C_u$	
		moderate dense $1 < C_u < 3$ $C_u > 3$	$O_{95}/d_{50} < 1.5 C_u$ $O_{95}/d_{50} < 13.5/C_u$	
		dense $1 < C_u < 3$ $C_u > 3$	$O_{90}/d_{50} < 2 C_u$ $O_{95}/d_{50} < 13.5/C_u$	
		Woven and heat bonded nonwoven	$1 < C_u < 3$ $C_u > 3$	$O_{95}/d_{50} < C_u$ $O_{95}/d_{50} < 9/C_u$
Heerten (1983)	Woven and nonwoven	Cohesionless ($d_{50} \geq 60 \text{ }\mu\text{m}$) $C_u > 5$	$O_{90}/d_{50} < 10$ $O_{90}/d_{90} < 1.0$ $O_{90}/d_{50} < 2.5$	Wet sieving, graded soil
		$C_u < 5$	$O_{90}/d_{90} < 1$	
		cohesive ($d_{50} \leq 60 \text{ }\mu\text{m}$)	$O_{90}/d_{50} < 10$ $O_{90}/d_{90} < 1$ $O_{90} \leq 100 \text{ }\mu\text{m}$	
Carroll (1983)	Woven and nonwoven		$O_{95}/d_{85} \leq 2\text{-}3$	
Christopher and Holtz (1985)		Dependent on C_u	$O_{95}/d_{85} \leq 1\text{-}2$ $O_{95}/d_{15} \geq 3$	
CFGG (1986)	Woven and nonwoven		$O_{95}/d_{85} < C$ $C = C_1 C_2 C_3 C_4$	Hydrodynamic sieving, graded soil
		$C_u > 4$	$C_1 = 1$	
		$C_u < 4$	$C_1 = 0.8$	
		less dense	$C_2 = 0.8$	
		dense	$C_2 = 1.25$	
		$i < 5$	$C_3 = 1$	
		$5 < i < 20$	$C_3 = 0.8$	
		$20 < i < 40$	$C_3 = 0.6$	
		filter	$C_4 = 1$	
		filter and drainage	$C_4 = 0.3$	
cohesive	$O_{95} \geq 50 \text{ }\mu\text{m}$			

d_m Sieve mesh (mm) through with m% of the soil fraction passes
 O_m Average diameter of the soil particles in a fraction, of which m% is retained by the envelope
 C_u Coefficient of uniformity ($= d_{60}F/d_{10}F$)
 i Hydraulic gradient (-)

Table 21.5 Test result of synthetic fibrous mats for pipe envelopes, according to the standardized sieving test (NNI 1990)

Fraction	Lower fraction limit (mm)	Upper fraction limit (mm)	Average grain size (mm)	Quantity passed (g)	Quantity retained (g)	Percentage retained (%)
A	0.250	0.300	0.275	8.0	42.0	84
B	0.300	0.355	0.328	4.5	45.5	91
C	0.355	0.425	0.390	3.5	46.5	93

makes it extremely difficult to develop sound design criteria. Consequently, many criteria have been developed (Table 21.4), most of them based on the opening size of the envelope material.

Various methods of obtaining characteristic opening sizes of synthetic envelopes exist. According to Van der Sluys and Dierickx (1990), these methods give practically the same results for the same soil material. A standard developed in The Netherlands for the particle-retention capability of synthetic fibrous mats is the characteristic pore size of the envelope. This pore size is expressed as the 'O₉₀-value', which is defined as the average diameter of the soil particles in a fraction, 90% of which is retained by the envelope in a standardized sieving test (NNI 1990).

The testing procedure uses prepared sand fractions, of which the grain size limits correspond with subsequent mesh sizes of a standardized sieve set. The procedure is illustrated in Table 21.5, where three sand fractions (50 g each) with a different particle-size distribution have been used. The quantity of each fraction that is retained by the envelope was measured. Plotting the results, followed by interpolation, leads to the conclusion that 90% of an average grain size of 0.320 mm would be retained by the envelope. The O₉₀-value of the envelope thus equals 0.320 mm (Figure 21.4).

Organic Envelopes

Design specifications of organic envelopes are based on the same principles as those for synthetic envelopes (Table 21.4). The lifetime of organic envelopes, however, is limited because of their origin. The lifetime depends on micro-biological activity in

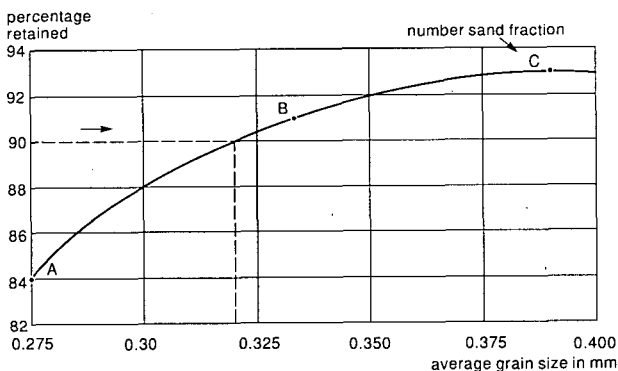

Figure 21.4 Example of standard test for envelopes using O₉₀-values

the soil, which is a function of temperature, soil chemical properties, and the presence of oxygen. Hence the rate of decomposition is slower in temperate climates under reduced (submerged) conditions. Consequently, organic envelopes are mainly used in Western Europe and are not recommended for arid or semi-arid regions.

21.3.4 Structures

The drainage system consists not only of pipes, but also of additional provisions for connection, protection, inspection, etc. We shall therefore briefly look at the most common structures: pipe outlets, pipe drain connections, closing devices, drain bridges, and surface water inlets.

Pipe Outlets

At the place where a subsurface pipe discharges into an open drain, the side slope of the drain is subject to erosion by the normal drain outflow, while additional water may also lead to local erosion of the backfilled trench. This additional water may stem from surface irrigation or from water that leaves the pipe through joints or perforations just before the outlet. The same spot is further vulnerable because small animals (frogs, rats) may enter the drain and block it.

For collector outlets (of which there are comparatively few, so that the costs do not count very heavily), it is common to build a concrete or masonry structure. To avoid problems with mechanical maintenance of the open drain, the outlet structure can be built in a recess (Figure 21.5).

Field drain outlets in a singular drainage system are many, and therefore must generally be inexpensive. An additional requirement is that the outlets should not obstruct the mechanical maintenance of the open drains. Two possible solutions are:

- A long outlet pipe – long enough for the pipe discharge not to fall on the side slope but on the water surface of the open drain – which can be temporarily removed to allow mechanical ditch cleaning;

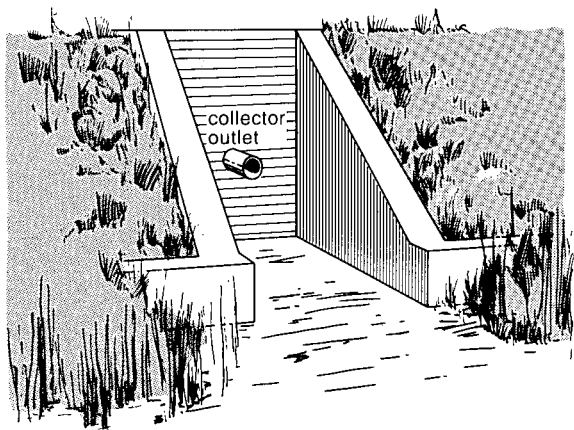

Figure 21.5 Collector outlet in recessed area (SCS 1971)

- A drain pipe that does not protrude from the side slope, the side slope being protected by a chute made of flexible material (e.g. plastic reinforced with glass fibre).

Cheap outlet structures, however, are easily damaged. Regular inspection and repair is therefore needed.

Other precautions for collector and field drain outlets are to provide a removable grating to prevent small animals from entering the pipe, especially for relatively large diameter pipes, and to prevent additional water flow at the end of the trench. For this purpose, the last section of the pipe should have neither perforations nor open joints; no envelope material (especially no gravel) should be applied near the outlet; and the last few metres of the trench backfill should be well compacted over the entire depth of the trench.

Pipe Connections

There are two main types of connections: blind junctions and manholes (or inspection chambers). Blind connections are direct connections between field drains and collectors by means of cross-joints or T-joints. It is recommended to have the field drain inflow at a somewhat higher level than the collector (a 'drop-in' of about 0.10 m). Blind connections can be provided with special arrangements so that the field drains can be cleaned by flushing without having to excavate and dismantle the connection (Figure 21.6).

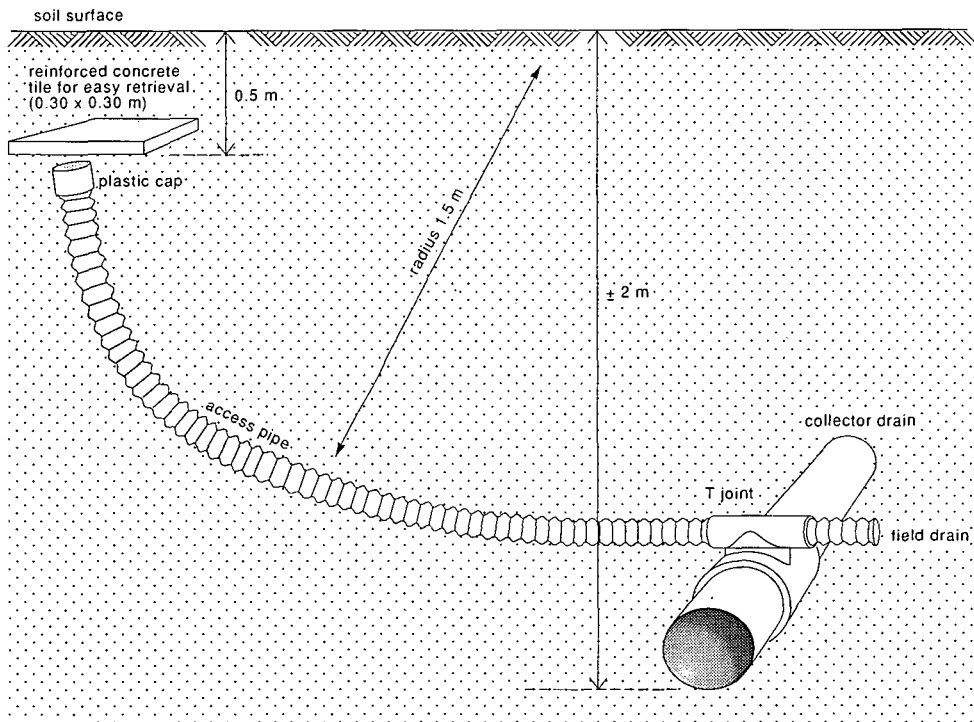

Figure 21.6 Connection of field drain to collector drain with access pipe to allow entry of jetting or rodding equipment

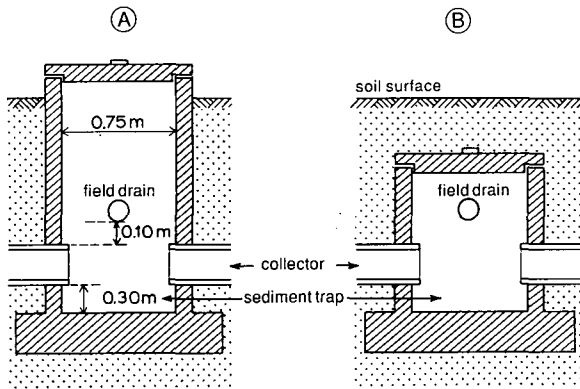

Figure 21.7 Manhole
 A: Cover above soil surface
 B: Buried cover

A manhole allows inspection and maintenance of the field drains and the collector. The lid may be either above or below the land surface (Figure 21.7), depending on the need for frequent inspection. A disadvantage of having the lid at the surface is that farmers tend to use the structure as an outlet for excess irrigation water, which will inevitably lead to extra sedimentation in the drain. If the lid is underground, the location should be well recorded for easy retrieval. A useful help is to cast some iron in the lid so that it can easily be found later with a metal detector.

Recommendations for the construction of manholes include the floor to be some 0.20-0.30 m below the collector invert, thus allowing for a 'silt trap', from which sediment can be easily removed. A drop between the field drain and the collector of about 0.10 m is recommended. To allow access by a man, the inside diameter of the manhole should be at least 0.75 m, and, if the structure is deep, a ladder of iron bars should be cast in the wall. The manhole can be made of pre-cast segments, of cast-in-place concrete, or of masonry.

Closing Devices and Outflow Regulators

There may be reasons to close or reduce pipe outflow temporarily (e.g. if the field is under rice). A device can be designed for installation in a sub-collector or in a field drain, either at its outflow into an open drain or at its outflow into a collector. Various types of closing devices and outflow reducers have been tested, but none seems to have progressed beyond the prototype stage. Figure 21.8 shows an example of a regulating device for subcollector flow, to be installed in a manhole. Even if working properly, a regulating device for each field drain means a very vulnerable system, which would require meticulous maintenance.

Drain Bridges

Where a pipe drain crosses an unstable strip of soil (e.g. a recently filled-in ditch), it may get out of line or become damaged as a result of the soil settling. As a precaution, the drain can be supported by a rigid bridge across the unstable strip. This bridge can be made of wood or consists of a steel pipe around the pipe drain.

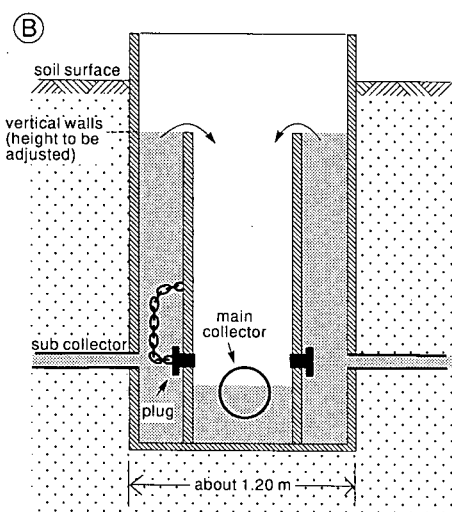
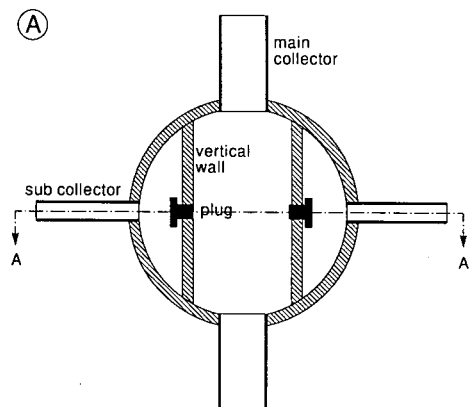

Figure 21.8 Prototype of a closing device in a manhole
 A: Top view
 B: Section A-A

Surface-Water Inlets

Surface-water inlets can be built into the drain in places where surface water is likely to accumulate. Two possible types are blind inlets and open inlets.

Blind inlets consist of a cover of stones and gravel extending from the ground surface to the drain pipe (Figure 21.9). These inlets are, by nature, susceptible to clogging by soil particles at the ground surface.

Open inlets (Figure 21.10) are positioned preferably at the upstream end of the drain pipe in order to reduce the chance of the pipe being blocked by sedimentation. These structures should always be provided with a silt trap. At the soil surface, they should be protected by some form of grating. The silt trap must be regularly checked and cleaned.

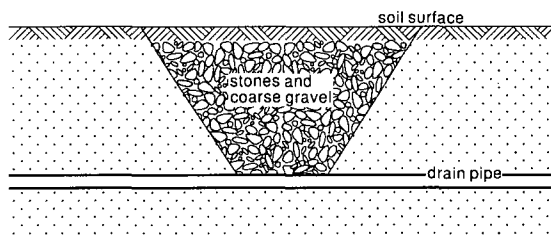

Figure 21.9 Blind inlet for surface water into pipe drain (SCS 1971)

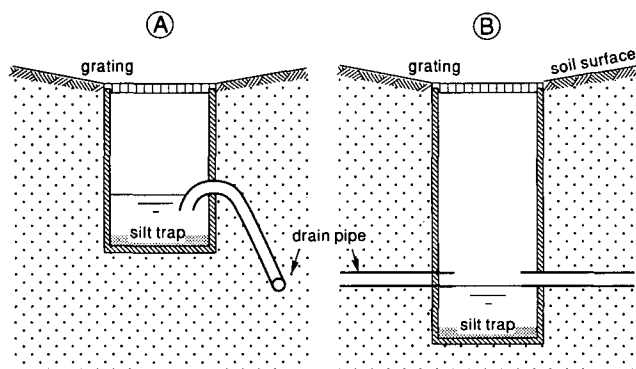

Figure 21.10 Open inlets for surface water

- A: Built beside the drain line
- B: Built in the drain line

In view of the sedimentation risk involved, surface water inlets are not very common. Surface water should preferably be evacuated through a network of open drains.

21.3.5 Depth and Spacing of Field Drains

Ideally, the depth and spacing of field drains are determined with the help of drainage equations (Chapter 8). Drainage criteria are formulated in terms of parameters that fit in these equations (Chapter 17). The parameters, characterizing soil hydraulic properties, are derived from field surveys (Chapters 11 and 12). The results of this approach are an infinite number of possible combinations of depth and spacing. In practice, however, depth can seldom be selected freely, thereby restricting the spacing options. Depth-limiting factors include the drainage base, the presence of unsuitable layers in the soil profile, and the available machinery (Section 21.4.2).

Drainage Base

The drainage base can be defined as the water level at the outlet. It determines the hydraulic head available for drainage flow. The outlet is different for different points of a drainage area. For the groundwater, the (field) drainage base is the water level or the hydraulic head in the field drains, whether they be pipes or open drains. For

the pipe drainage system (the focus of this chapter), the drainage base is the water level that can be maintained in the recipient main drains. And for a gravity-flow main drainage system, the drainage base consists of the water level prevailing in critical periods, below the main outlet structure (Chapter 24).

Limiting ourselves to pipe drains, we must ensure that they have a free outflow, meaning a pipe invert level at least about 0.10 m above the water level in the recipient drain. This holds for field drains discharging into a collector as well as for collectors discharging into an open main drain. Occasional submergence of short duration (say 1 to 2 days, 2 to 3 times per season) is, however, usually permissible (see also Chapters 17 and 19).

As ideal, flat, conditions are rare, the drainage base may be too high in parts of the area. It is then often a matter of professional judgement to find a compromise between insufficient drainage in a limited area and high costs for over-draining the majority of the area (e.g. by including pumping). In some cases, the local effect of insufficient drainage can be offset by other measures, such as adding extra nitrogen to compensate for insufficient soil aeration in the winter season in temperate regions (Chapter 17), or, in arid areas with saline seepage, by giving an extra leaching irrigation after the fallow period (Chapter 15).

Unsuitable Soil Layers

Certain soil textures are unsuitable for the installation of pipe drains. When a layer of such a texture occurs in the profile, the pipe drains should be installed above or below that layer. Examples of such risky layers are quick-sand layers and slowly-permeable clay layers. Quick-sand layers are sandy layers that develop sloughing when saturated, and they pose a great risk of rapid sedimentation and of misalignment of the pipe line. Clay layers of very low permeability would lead to very narrow spacings and, consequently, high costs.

A typical example is a three-layered profile that can be found in alluvial soils. It consists of a rootzone of good permeability, overlying a slowly-permeable clay horizon, followed by a permeable subsoil of coarse-textured soil or well-structured clay. If the permeable third layer is not too deep, the drains should preferably be installed in that layer. The pattern of groundwater flow will then be similar to that shown in Figure 21.50G (Section 21.8.6), with a short distance of vertical flow through the slowly-permeable second layer, and horizontal and radial flow in the permeable third layer. If the third layer consists of unstable sand, one should be aware of construction problems.

In the case of a two-layered profile, with a permeable top soil underlain by a deep slowly-permeable substratum, the drains should be installed in the upper layer (e.g. just above the second layer). If the upper soil layer is very shallow, pipe drainage is not likely to be appropriate at all. Mole drainage (Section 21.9) or surface drainage (Chapter 20) might then be better options.

Spacing

Calculated drain spacings for a project area are likely to show considerable variations due to a natural variation in hydraulic conductivity. If so, the area should be divided into sub-areas or 'blocks' of a convenient size, for each of which a uniform and representative drain spacing is selected. A convenient size, for example, would be the area served by one collector.

Having considered the depth of the drainage base and the presence of unsuitable soil layers, one normally arrives at a range of possible drain spacings. Within this range, a number of standard spacings should be selected beforehand, each standard differing from the next one by a factor of 1.25 to 1.5. It makes little sense to make the increments too small in view of the many inaccuracies and uncertainties in the entire process of determining the spacings.

As an example, suppose that the calculated spacings in a project area vary between 18 and 85 m, disregarding a few extreme values. Practical sets of standard spacings could then be: 20 – 25 – 30 – 40 – 50 – 60 – 80 m, or 20 – 30 – 45 – 60 – 80 m.

21.3.6 Pipe Diameters and Gradients

Equations to calculate pipe diameters and gradients will be discussed in Section 21.6. Below, we shall merely give a few comments on the drainage coefficient to be used and on the pipe slopes.

The hydraulic pipe design (i.e. the selection of slopes and diameters) requires a value of the drainage coefficient, q . This q -value is not always the same as the drainage coefficient used to calculate the drain spacing. The steady-state criterion for the calculation of the drain spacing, often expressed as the ratio q/h (i.e. the drainage coefficient divided by the hydraulic head midway between the drains), is generally based on average monthly or seasonal values and the design discharges for the hydraulics of drainage pipes on higher, less frequent, peak discharges as may occur during a shorter period, e.g. 10 days (see Chapter 17.3.5). Moreover, it is inherent in the steady-state approach that watertables may be incidentally higher than designed. This also means that drain discharges will be higher. In very general terms, one tries to avoid the design discharge being exceeded more than 'only a few times' during the main drainage season.

Theoretical and practical considerations on slopes in drainage pipe lines will be presented in Section 21.6.3. Nevertheless, especially in areas with a very uneven topography, the permissible maximum slope may be an additional matter of concern. This slope is dictated by the maximum permissible flow velocity, for which German standards give 1.5 m/s for concrete pipes.

Maximum slopes are of practical significance only for collectors. If the topography should call for steeper slopes, drop structures should be built into the pipe line. These are normally incorporated in manholes. Special caution is needed if a steep slope changes to a flatter slope: high pressures may develop at the transition point unless the flow velocity on the upstream side is properly controlled and the downstream (flatter) reach of the pipe line has a sufficient capacity.

21.3.7 Lay-Out of Pipe Drainage Systems

In this section, we shall discuss the most important considerations that lead to a designed spatial arrangement of a subsurface drainage system in the area (i.e. indicating all the items on a map). These considerations concern the choice between a singular and a composite system, the location and alignment of the drains, subsurface drainage in rice fields as a special case, and the use of multiple small pumping stations.

Singular or Composite System

In a singular pipe drainage system, each field pipe drain discharges into an open collector drain. In a composite system, the field pipe drains discharge into a pipe collector, which in turn discharges into an open main drain. The collector system itself may be composite with sub-collectors and a main collector.

The lay-out is called a 'random system' when only scattered wet spots of an area need to be drained, often as a composite system (Figure 21.11A). A regular pattern is installed if the drainage network must uniformly cover the project area. Such a regular pattern can either be a 'parallel grid system', in which the field drains join the collector at right angles (Figure 21.11B), or a 'herringbone system', in which they join at sharp angles (Figure 21.11C). Both regular patterns may occur as a singular or a composite system.

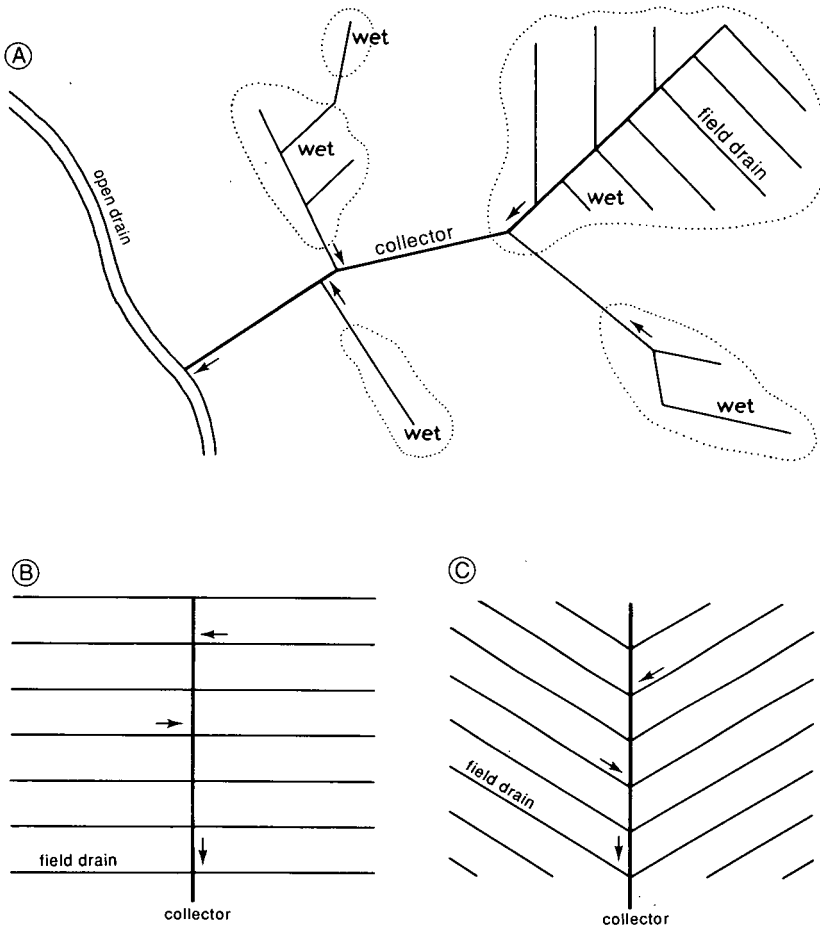

Figure 21.11 Different layout patterns for a composite pipe drainage system

- A: Random system
- B: Parallel grid system
- C: Herringbone system

The choice between a singular and a composite system must be based on a number of considerations (e.g. the desirability of open drains, head loss, and costs). We shall look at such considerations below.

A singular system implies a comparatively dense network of open collector drains (maximum spacing in the order of 500 m). These open drains have disadvantages that were discussed in Section 21.2, but they may be desirable for other reasons (e.g. to provide open water storage and additional surface drainage in high-rainfall areas). A composite pipe system, supplemented by an independent system of shallow surface drains could be another option.

A second consideration is that pipe collectors lead to a higher head loss than open collectors, their hydraulic gradients being around 0.0005, as opposed to 0.00015 for open collectors. This is illustrated in Figure 21.12. For the pipe collector, the head difference between A and B consists of 0.10 m drop-in for the field drain, plus 0.20 m for the diameter of the collector pipe, plus a fall over 1000 m at a slope of 0.0005 = 0.50 m, and, finally, a freeboard in the collector drain of 0.15 m, totalling 0.95 m. For the open collector, only the 0.10 m drop-in of field drain plus a fall of $1000 \times 0.00015 = 0.15$ m, totalling 0.25 m, is required between A' and B. Equal groundwater control throughout both areas would, in the pipe collector case, require much deeper water levels in the main drains. Especially in flat areas, where the drainage discharge often has to be pumped, such deeper water levels involve considerable extra costs. In areas with sufficient natural slope (0.001-0.002), the extra head losses in a composite system are rarely a concern.

In many flat areas in temperate climates, a natural network of open drains existed before the introduction of subsurface drainage systems. Turning such drains into open collectors may then be convenient, thereby deciding against a composite system. A singular system has many pipe outlets, which are vulnerable to damage. On the other hand, the maintenance of a singular system is easier (Section 21.5.3). Another major consideration is that, as a rule, the construction costs are higher for pipe collectors, but, against that, the long-term maintenance costs are much lower than for open collectors. In low-lying flat areas, the costs of the main drainage system and pumping station also have to be considered.

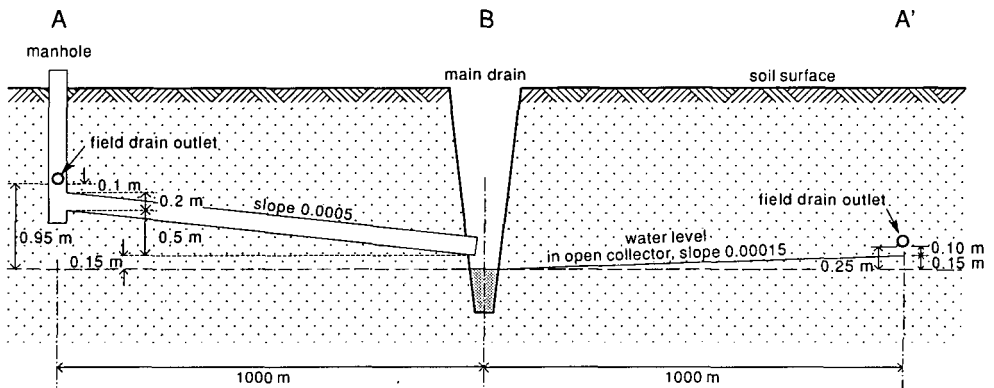

Figure 21.12 Head losses in pipe collector versus open collector

In irrigated lands with a rather complex infrastructure of roads, irrigation canals, and small farm plots (e.g. as in Egypt), composite systems are generally preferred. Open collector drains would interfere too much. Singular systems with open collector drains are feasible in areas where the infrastructure has been completely remodelled under a land consolidation scheme (e.g. as in Iraq), or in newly reclaimed areas. Such considerations have led to a general practice of installing singular systems in flat areas in temperate climates and, occasionally, in irrigated land in arid regions, whereas composite systems are chosen in sloping land and, commonly, in irrigated land in arid regions.

Location and Alignment of Drains

The problem is how to draw the drainage system – of which the main elements (drain spacings; type of system) have been determined – on the map. In many cases, there are a bewildering number of options open to the design engineer. Two main factors, however, should provide guidance: the topography and the existing infrastructure.

Optimum use should be made of the existing topography in order to achieve a depth-to-watertable as uniformly as possible throughout the area. In the case of uneven topography, the drains will, as much as possible, be situated in the depressions. Figure 21.13 shows an example of a flat area in a temperate climate, where, not uncommonly, fields have a regular pattern of shallow depressions, which are the remains of an old surface drainage system. Figure 21.13A shows how to install the field drains in these depressions, even if the spacing does not exactly correspond with the calculated spacing. Figure 21.13B shows how it should not be done. A second example (Figure 21.14) shows where the collector is to be installed in a ‘thalweg’, which is the line joining the lowest points along a valley.

In an area with a uniform land slope (i.e. with parallel equidistant contours), the collector is preferably installed in the direction of the main slope, while the field drains run approximately parallel to the contours (Figure 21.15A). To take advantage of the slope for the field drains also a herring-bone system can be applied. Other

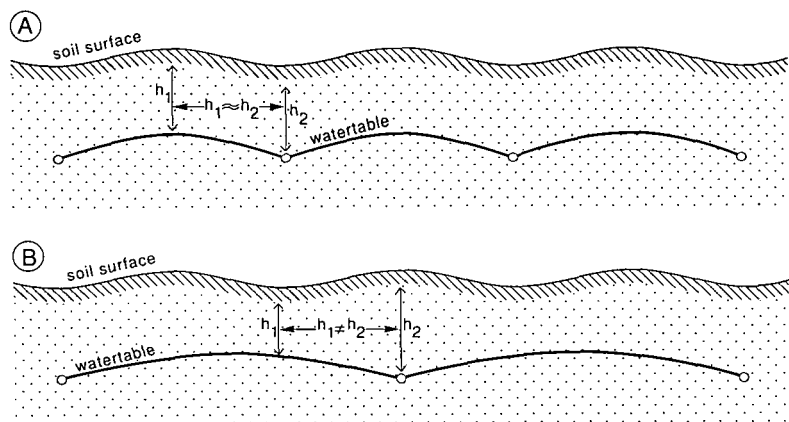

Figure 21.13 Location of field drains in relation to field topography

- A: Well-adapted
- B: Poorly adapted

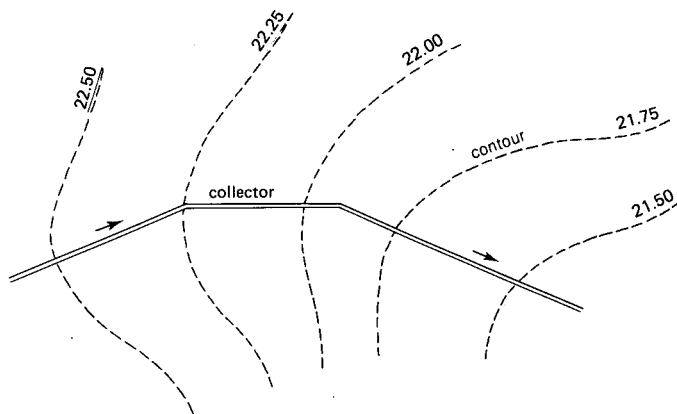

Figure 21.14 Location of collector adapted to contour lines

alternatives are collectors parallel to the contours, and the field drains down the slope (Figure 21.15B), and collectors and field drains both at an angle to the contours (Figure 21.15C). A major drawback of the latter two alternatives is that the field drains are only on one side of the collector. The inherent greater total collector length and the consequent higher costs make these solutions suitable only under special conditions.

When an infrastructure exists, it has almost certainly been designed without consideration being given to a pipe drainage system. Only when the area has originally been developed under a large-scale scheme or project is there a chance that pipe drainage can be introduced in a rational way. Where the infrastructure is very old and has developed gradually in the course of history, the pattern is normally far from regular, and allowances have to be made. To design a pipe drainage layout in such an area implies continuous compromises.

In the first place, it has to be verified whether boundaries between farm holdings have to be respected as limits for pipe drainage units. This may vary from country

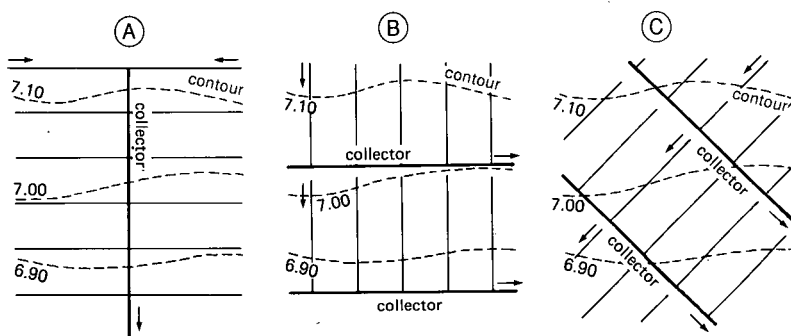

Figure 21.15 Pipe drainage layout adapted to a uniform slope of the land surface

- A: Collector in the direction of the slope
- B: Field drains in the direction of the slope
- C: Collector and field drains at an angle to the slope

to country and even from project to project. As an example, in The Netherlands and other Western European countries, pipe drains are as a rule installed on an individual farm basis. But in large-scale drainage schemes in Pakistan (Khairpur) and Egypt (the Nile Delta), one drainage unit (i.e. the area served by a collector) serves the area of several farm holdings, so that collectors, and even field drains, commonly cross holding limits.

Secondly, a general guideline is to keep crossings of pipe drains with channels and roads to a minimum. Especially if composite systems are installed, however, some crossings are unavoidable. The general rule is then to install the field drains parallel to the tertiary irrigation (and drainage) channels, and the collectors at right angles.

In new reclamation or land-consolidation schemes, the entire network of roads, irrigation canals, open drains, and pipe drains can be designed simultaneously, which logically offers the best possibility of an optimum layout. Figure 21.16 shows the two possible options for such a case: a composite system (Figure 21.16A) or a singular system (Figure 21.16B).

Subsurface Drainage of Rice Fields

The subsurface drainage of rice fields is becoming increasingly important in various places in the world. This has potentially far-reaching consequences for the technical design of subsurface drainage systems, and, especially, for their layout. The issue arises in areas where rice is grown in rotation with dry foot crops, like wheat or maize. The subsurface drainage is mainly intended for these dry foot crops, but problems may arise in a season when rice is grown instead.

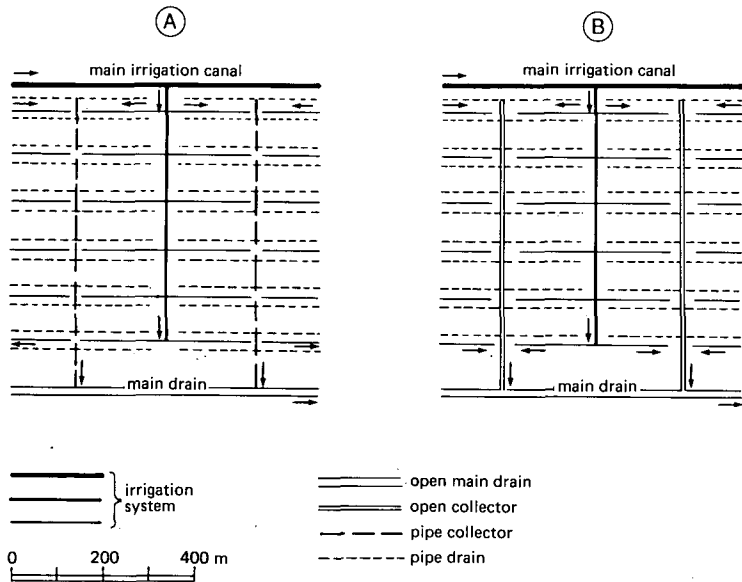

Figure 21.16 Irrigation and drainage layout in a new land consolidation area
 A: Composite drainage system with pipe collectors
 B: Singular drainage system with open collectors

During most of the rice-growing season, the field is kept submerged under a water layer of approximately 0.10 m. If no special precautions are taken, great amounts of irrigation water may be lost through the subsurface drainage system. Drain discharges from inundated rice fields in Egypt, for example, not uncommonly amount to some 10 mm/d. If the irrigation supply is not abundant, this may lead to irrigation water shortages. A logical remedy would be to prevent or reduce drain outflow by some sort of structure, and it is especially in this connection that the layout becomes important. Let us illustrate this by looking at two situations:

- Rice is grown as a summer crop in a 2- or 3-year rotation with dry crops such as cotton and maize (e.g. as in Egypt);
- The entire area is under rice in the summer season, whereas dry crops are grown only during the winter season (e.g. as in East Asia).

In the first case, problems may arise if fields with rice and dry-foot crops are served by the same collector, because they have conflicting requirements of water management. Closing the collector outlet to reduce water losses from the rice fields would lead to a backing up of the water in the subsurface drainage system. Cotton and maize crops would then suffer from high watertables. A solution consists of matching cropping units and drainage units, so that only one type of crop (e.g. rice) is grown per drainage unit. This unit can then be operated independently, which implies an adaptation of the cropping pattern to the drainage layout, or the reverse, or, most probably, both (El Atfy et al. 1991).

For many years now in Egypt, there has been a system of 'crop consolidation', by which the summer crops are concentrated in blocks of some 10 to 20 ha, each comprising the fields of several farmers. A given block is then alternately cultivated with rice, cotton, and maize. The second half of the job is now to design the drainage layout in such a way that each block has its own independently-operated drainage unit. Figure 21.17A shows a conventional lay-out (i.e. without regard for the cropping units). To reduce water losses, farmers are likely to block the collector downstream of the rice unit, thereby affecting the drainage of the entire area upstream of that point. An alternative is shown in Figure 21.17B, where sub-collectors, each serving a cropping unit, discharge into a collector in a manhole in which devices are installed to regulate the sub-collector outflows. The flow in the collector is not affected, so that the cotton and maize blocks can drain normally.

In the second case (East Asia), the problem is smaller in place and in time, only occurring when there are rice nurseries (which require a water layer) adjacent to fields with winter crops in the ripening stage (which require a dry rootzone). One possible solution would be to close those field drains that serve the nursery plots, and to keep the nurseries together. Alternatively, the high nursery percolation could be accepted, because it concerns a comparatively small area.

The general conclusion for other parts in the world is: if the introduction of pipe drainage is contemplated in an area where rice is expected to be grown simultaneously with other crops (the Egypt case), timely arrangements have to be made to ensure that 'cropping layout' and drainage layout will match.

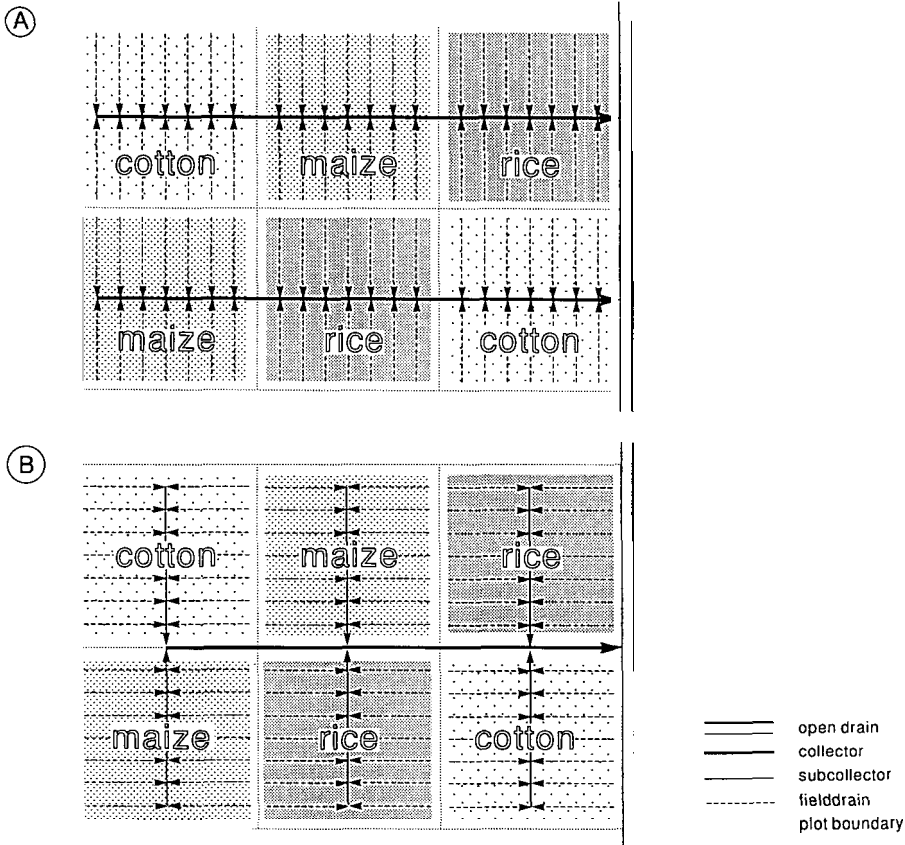

Figure 21.17 Blocks of rice and other crops in a pipe-drained area in Egypt
 A: Conventional layout, not adapted to the cropping units
 B: Modified layout, adapted to the cropping units

Multiple Small Pumping Stations

Where deep pipe drains are needed and the soil profile contains layers of low stability, it may be extremely difficult to construct and maintain open main drains of sufficient depth to permit the pipe drainage effluent to evacuate by gravity. In areas with seepage inflow, deep drainage (about 2 m for the field drains, and 3 m for the collector) may be needed to restrict capillary salinization during the fallow season. The seepage conditions will contribute to the instability of the soil (sloughing conditions). Areas with this type of problem occur on a large scale in the Indus Valley in Pakistan and throughout Northern China, and on a smaller scale in various arid and semi-arid regions elsewhere in the world.

A solution that avoids the problems connected with deep open main drains is to install small pumping stations at collector outlets. The pipe collector discharges into a sump (a concrete basin with a capacity of a few cubic metres), from where the effluent is pumped into a shallow open main drain. Most convenient are electric pumps, which switch on and off automatically at predetermined water levels in the sump.

21.4 Installation of Pipe Drains

The classical method of pipe installation comprises marking the alignments and levels, excavating the trenches, placing the pipes and envelope material, and backfilling the trenches. Field drains nowadays are installed by drainage machines, either by trenchers or by trenchless machines, whereas concrete collectors are often installed with excavators. In addition to the mechanics of installation, the work planning, the working conditions, and supervision and inspection are important.

21.4.1 Alignments and Levels

The classical method of marking alignments and levels is by placing stakes in the soil at both ends of a drain line, with the top of the stakes at a fixed height above the future trench bed. The slope of the drain line is thereby implicitly indicated. A row of boning rods is placed in line (both vertically and horizontally) between the stakes, with an extension at the upstream end of the drain line, where the run of the drainage machine ends (Figure 21.18). The boning rods are thus in a line parallel to the trench bed, and

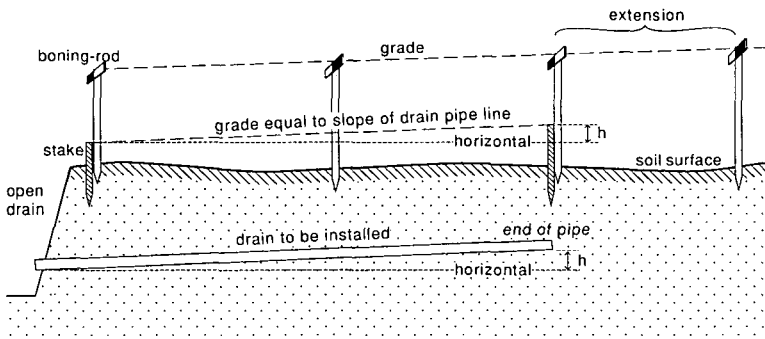

Figure 21.18 Staking out for grade control of drain pipe line

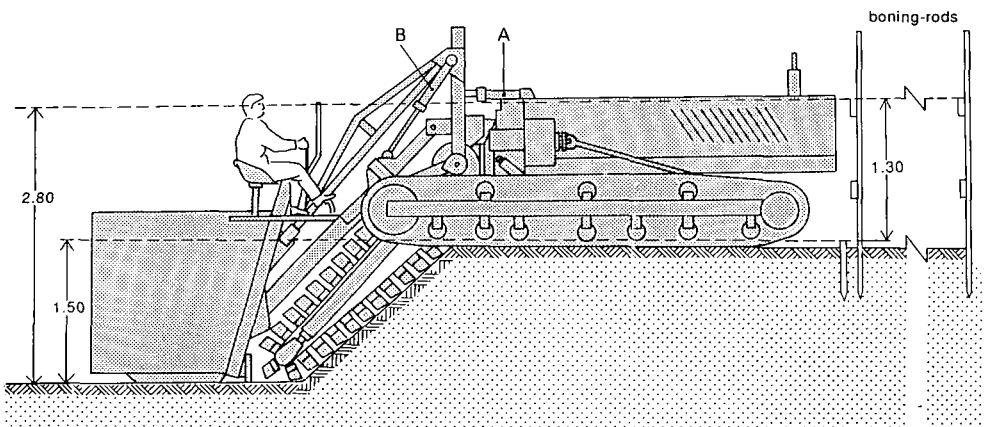

Figure 21.19 Grade control by the operator

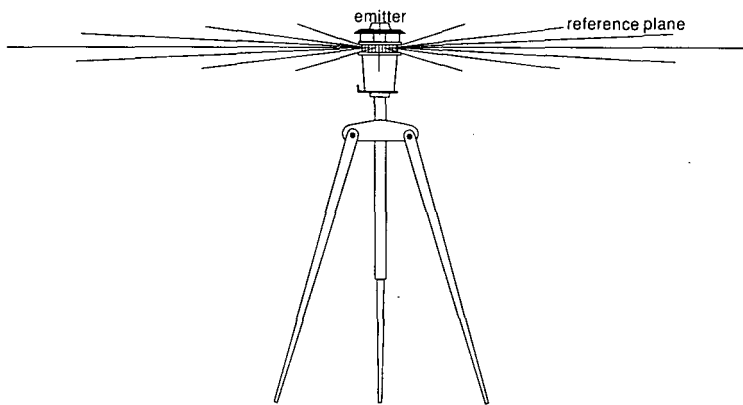

Figure 21.20 Laser emitter establishes a reference plane

grade control can be achieved through sighting by the driver of the drainage machine (Figure 21.19). The same principle can be applied when drains are installed manually.

Nowadays, most drainage machines have grade control by laser. An emitter, placed on a tripod near the edge of the field, establishes an adjustable reference plane over the field by means of a rotating laser beam (Figure 21.20). A receiver, mounted on the digging part of the drainage machine, picks up the signal (Figure 21.21). The control system of the machine continuously keeps a fixed mark in the laser plane. One position of the emitter can serve the installation of a fairly large number of drains.

21.4.2 Machinery

The most common types of machines for installing field drains fall into two main categories: trenchers and trenchless machines.

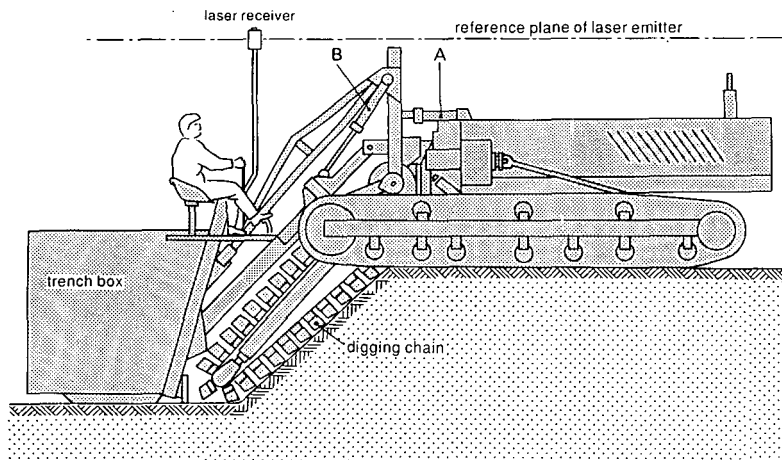

Figure 21.21 Trencher equipped with laser-grade control

Trenchers

Trench-excavating drainage machines vary from attachments to a wheel tractor, suitable for installation depths of up to 1 m, to heavy-duty machines, suitable for installing large-diameter collector pipes to a depth of about 3.5 m.

Most machines move on tracks, but especially the lighter ones may have rubber tyres. The digging implement is commonly a continuous chain with knives (Figure 21.19 and 21.21). The excavation depth and trench width of a machine can be varied through interchanging digging attachments. The maximum depth of a trencher is somewhere between 1 and 3.5 m. The trench width varies roughly between 0.12 and 0.65 m, a standard width for field drains being 0.20 to 0.25 m. The engine power ranges from 75 to 300 kW (100 to 400 HP), and one machine weighs between 10 and 50 tons. The grade-control system is optional for most machines: either by the driver or by laser.

The corrugated plastic pipe for small-diameter field drains is carried on the machine on a reel and is fed into the trench. Larger-diameter corrugated pipes (e.g. for collectors) are usually laid out and coupled in the field beforehand. The continuous tube is subsequently picked up by the machine as it moves along. Clay tiles and concrete pipes move down a chute behind the digging chain.

Synthetic and organic envelopes are usually pre-wrapped around the corrugated pipe. For gravel envelopes, a hopper can be fitted into which the gravel is fed from a trailer moving alongside the drainage machine. For a complete gravel surround, two gravel hoppers can be installed: one before and one after the point where the pipe is fed in.

Special trencher-machine attachments are a water tank with a spraying nozzle to wet the chain (in sticky clay), and a scratcher at the back of the machine for blinding the pipe with soil from a pre-selected layer (mostly well-structured top soil).

In view of the wide variety of machine types and working conditions, it is difficult to give meaningful data on the output rate. A typical average output for a 160 kW trencher installing field drains at 1.5 m depth would be approximately 500 m per hour.

Trenchless Drainage Machines

Trenchless drainage machines have been used since about 1965, after flexible corrugated plastic pipe appeared on the market. Two main types of trenchless devices are the vertical plough (Figure 21.22) and the 'V-plough' (Figure 21.23).

The vertical plough acts as a subsoiler: the soil is lifted and large fissures and cracks are formed. If these extend down to the drain depth, the increased permeability leads to a low entrance resistance and an enhanced inflow of water into the pipe. Beyond a certain critical depth, however, the soil is pushed aside by the plough blade, instead of being lifted and fissured. This results in smearing, compaction, and a destruction of macropores, so that the permeability is reduced and the entrance resistance is increased. The critical depth depends mainly on the soil texture and on the water content during pipe installation.

The V-plough, which lifts a triangular 'beam' of soil while the drain pipe is being installed, has a hazard of deforming the corrugated pipe under the weight of the soil beam. This problem was found to occur in heavy alluvial clay soils in The Netherlands, but it can be solved by simple adjustments to the plough.

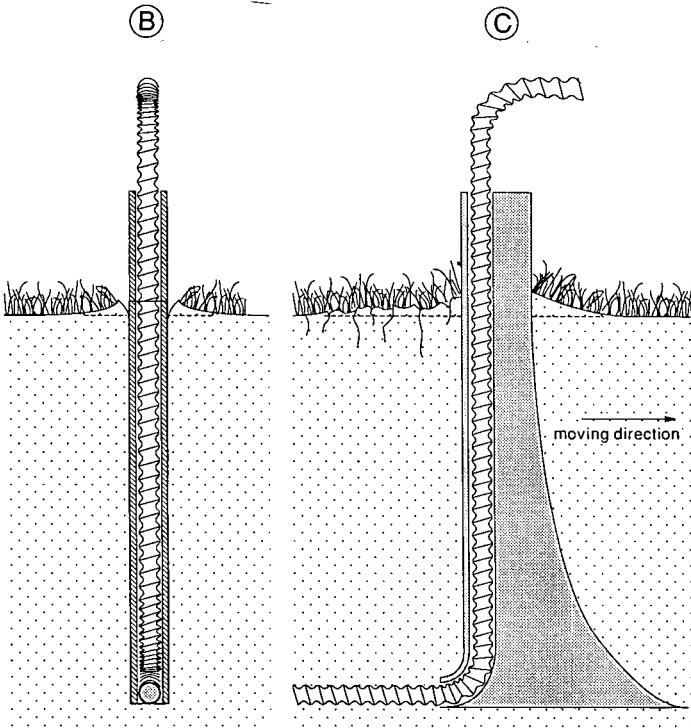
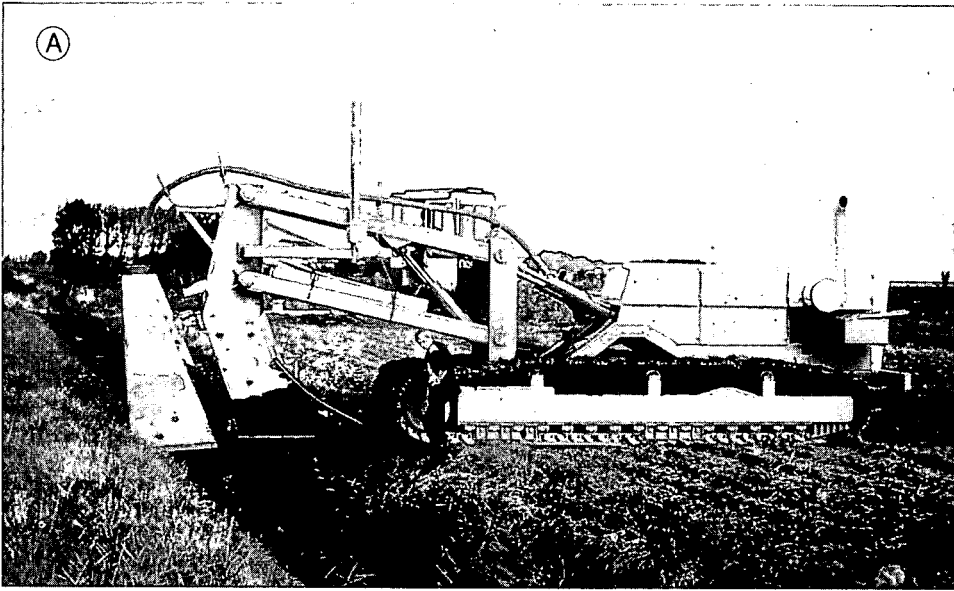

Figure 21.22 Trenchless pipe drain installation
 A: Machine equipped with a vertical plough
 B: Rear view
 C: Side view

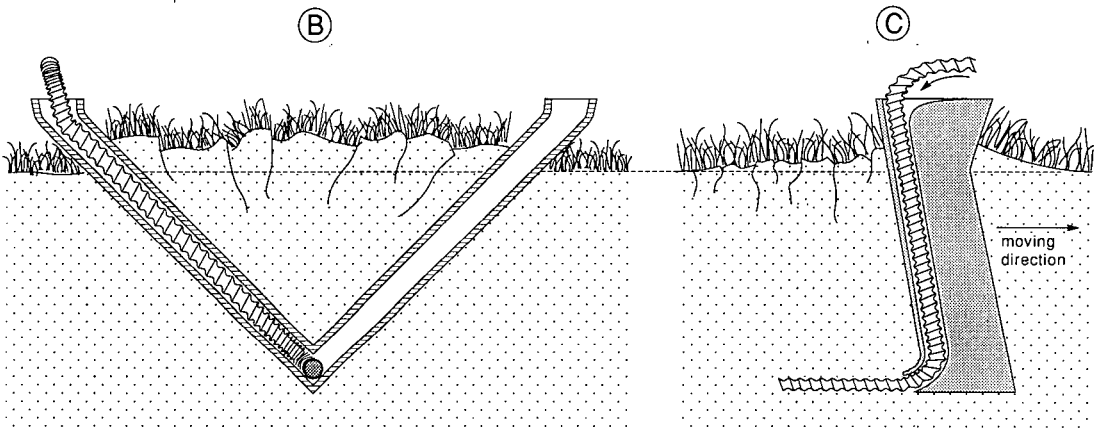

Figure 21.23 Trenchless pipe drain installation
 A: Machine equipped with a V-shaped plough
 B: Rear view
 C: Side view

Corrugated plastic pipes are the only feasible pipes for trenchless machines. The V-plough can handle a maximum outside pipe diameter, including the envelope, of 0.10 – 0.125 m. The vertical plough can handle much larger diameters. Although gravel envelopes would be possible with trenchless drainage, it is not recommended because of the risk of a clogged funnel and because of the difficulty of supplying gravel to a comparatively fast-moving machine. The only practical option is to use pre-wrapped envelopes.

Table 21.6 Example of the capacity (m/h) of a trencher (160 kW) and a trenchless machine with a V-shaped plough (200 kW) for the installation of field drains in singular systems in The Netherlands (after Van Zeijts and Naarding 1990)

Soil type	Drain depth (m)	Capacity (m/h)		Ratio Trenchless/Trencher
		Trencher	Trenchless	
Sand	1.00	700	840	1.2
	1.30	600	600	1.0
	1.60	520	430	0.8
	1.90	475	-	-
Clay loam and clay	1.00	620	1150	1.9
	1.30	540	1050	1.9
	1.60	470	800	1.7
	1.90	420	-	-

Because of the high speeds, depth regulation by laser is the only practical method for trenchless machines. Moreover, because of the absence of an open trench, visual inspection is impossible.

Comparison of Trencher and Trenchless Installation

Experience in Western Europe and North America has shown that, for drain depths up to some 1.3 to 1.4 m, the cost of trenchless drain installation is lower than trencher installation, mainly because of a higher speed. In The Netherlands, with drain depths of mostly 1.0 to 1.2 m and pipe diameters of up to 0.08 m, the difference is 15 to 25%. The advantage of trenchless installation decreases rapidly with greater drain depth and with higher soil resistance (Figure 21.24). Soil resistance is higher in fine-textured soils than in coarse-textured ones, as illustrated in Table 21.6.

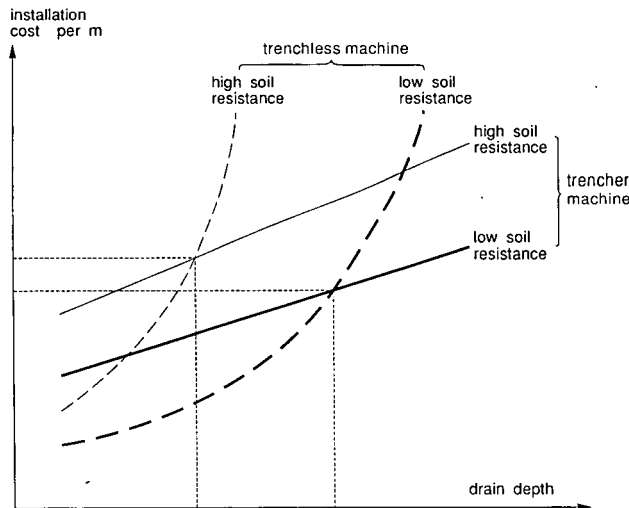

Figure 21.24 Cost comparison between a trenchless machine and a trencher machine (Van Zeijts and Naarding 1990)

Trenchers mainly use energy for digging and only a small portion for traction. Power requirements increase approximately linearly with depth, (i.e. proportional to the amount of excavated soil). Trenchless machines use energy almost exclusively for traction, and power requirements increase with the square of the installation depth. Because of the higher draught requirements, the grip of the tracks on the land surface is more critical for trenchless machines. The grip decreases rapidly with increasing water content of the top soil, especially in fine-textured soils. Trenchless machines therefore need to be heavy and require large tracks. They are also sooner unable to work under wet soil conditions caused by rain or untimely irrigation.

The trencher usually causes more disturbance to the crops and to the land surface than the V-shaped plough, but less than the vertical plough. The disturbance of the vertical plough can partly be redressed by running one track of the machine over the drain line on its way back.

21.4.3 Collector Installation

Concrete pipes are installed either by trencher or by hydraulic excavator (backhoe). As a safeguard against siltation, the collector is commonly constructed as a closed conduit. Thus, the joints between pipe sections are sealed with either mortar or close-fitting rubber rings.

The larger corrugated plastic pipes (> 0.20 m diameter) need to be embedded in gravel as a protection against deformation, and are comparatively expensive, although their use is increasing. They are the only alternative if a de-watering collector is needed. The installation of such a collector is commonly done by a trencher. The gravel bed also has a hydraulic and a filter function.

Installing a deep collector in an unstable soil well below the watertable is a difficult job, because of the sloughing conditions during pipe installation. Installing concrete pipes is then only possible after the soil has been de-watered (i.e. by lowering the watertable to below the installation depth of the collector). This can be achieved by the classical well-pointing technique or, alternatively, by horizontal de-watering.

Horizontal de-watering was originally developed to de-water the installation sites of oil and gas pipelines, as a lower-cost alternative to vertical well-pointing. It consists of installing a pre-wrapped perforated corrugated pipe, well below the future excavation depth, and connecting it to a pump (Figure 21.25). The pipe is installed by a machine that resembles a trencher, but with a vertical digging chain and no trench box. Installation depths of over 6 m are possible. The trench usually collapses immediately behind the machine.

A different approach to dealing with sloughing conditions is to install a de-watering collector, which will lower the watertable above it. Corrugated pipe and gravel should be installed in one and the same run of a trencher machine. In very unstable soil, it is essential that the entire collector line be installed in one continuous run, otherwise the machine will get stuck. The advantage of a de-watering collector is that, by lowering the watertable, it facilitates field drain installation later on.

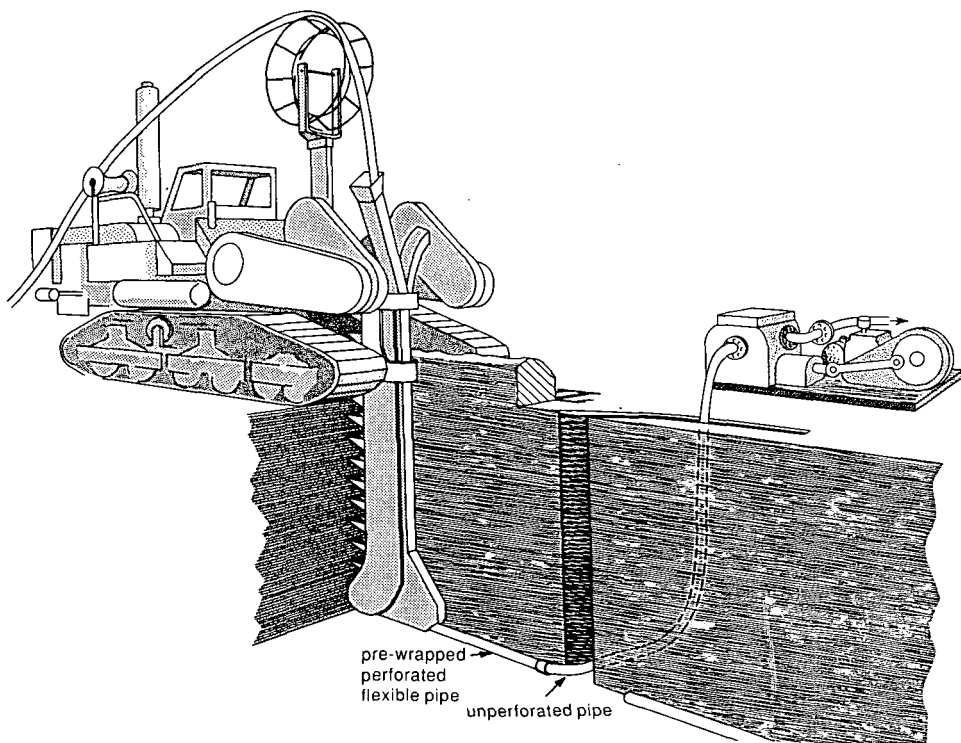

Figure 21.25 Principle of horizontal de-watering to lower the watertable for collector installation

21.4.4 Logistics, Auxiliary Work, and Equipment

The bottleneck for the speed of pipe installation is usually not the capacity of the drainage machine, but the organization and logistics connected with keeping the machine going. The preparation of the site (e.g. setting out, removing obstacles) is important, as is the operation and maintenance of the drainage machine (fuel supply, spare parts). In addition, the supply of pipe and envelope material needs to be properly organized.

A gravel envelope requires a considerable fleet of extra equipment to ensure a continuous supply to the machine (e.g. lorries, front loaders, and tractors with trailers). The latter move alongside the drainage machine and unload the gravel into the hopper(s) on the machine. Field drains require roughly 1 m^3 of gravel per 25 m of drain. A machine output of 3 km per day thus needs 120 m^3 (i.e. 180 tons) of gravel per day.

A hydraulic excavator (backhoe) is often needed as a standby for digging pits in which to connect collector and field drain, or for removing boulders in stony soil.

Trenches are preferably back-filled the same day as they are dug to avoid a possible destabilization of soil under wet conditions (irrigation, rain, high watertable). Only in unripened soil is it recommendable to leave the trenches open for some time to initiate ripening. In irrigated land, the upper part of the trench backfill should be

compacted to avoid piping, which is internal erosion of trench backfill by water flowing from the soil surface directly into the trench. Trench backfilling is usually done with a tractor equipped with a dozer blade. Running a tractor wheel over the backfilled trench, filling it up, and running over it again will take care of the required compaction. This procedure ensures that only the top part of the trench backfill is compacted, and that the deeper part of the backfill retains a good permeability and a low entrance resistance.

In the case of trenchless drain installation with the vertical plough, compaction of the upper part of the disturbed soil is equally important. A common procedure is that one track of the drainage machine runs over the drain line on its way back. In dry clay soil, this compaction may not be sufficient.

21.4.5 Special Considerations

A variety of adverse field conditions may jeopardize the pipe drainage system if no special precautions are taken. Most of these hazardous conditions can be grouped as wet conditions. Examples are a high watertable, a high water level in the open main drain, a waterlogged top soil due to recent irrigation or rainfall, and a pipe drain crossing an irrigation canal. Sometimes, an appropriate choice of season may overcome many of these problems. The hazards of wet conditions include:

- The internal erosion of soil resulting in siltation of the pipe;
- The formation of a puddled soil around the pipe, with a low permeability and a high entrance resistance;
- The dislocation of pipe and envelope material in the case of sloughing conditions.

A general principle of drain installation is to start at the downstream end, so that any free water can drain away immediately. Thus a good drainage base should be secured, which implies that the collector should be in place and should be functioning before the start of the field drain installation. Also, the water level in the open drain should be below the pipe outlets, and the connection with the collector should be made before a field drain is installed.

When the land surface is waterlogged, pipe installation should be avoided, especially in medium-textured soils. The dry season should be selected, if possible, and it should be arranged that the land is not irrigated shortly before installation. Trenches need to be backfilled and compacted before the land is irrigated again.

When open canals have to be crossed, these should be dry during pipe installation. Temporary dams should be made on either side of the crossing, and water should be pumped out, after the necessary arrangements have been made with the farmers and the responsible authorities. Especially at these crossings, it is important to compact the trench backfill and to seal the bed of the canal in order to avoid piping. If necessary, a closed pipe section should be installed at the crossing.

At the outlet of a pipe drain into an open drain, there is an extra risk of erosion of the trench backfill. As a precaution, the last few metres of the drain before the outlet should consist of unperforated pipe without envelope material, while over the same distance the trench backfill should be compacted over its entire depth.

Wherever trees or shrubs are growing in the vicinity of drainage pipe lines, there

is a risk of roots penetrating into the pipes (Section 21.7.4). Recommended precautions are to keep drain lines away from trees wherever possible (while even considering the probability of future tree planting), and to use unperforated pipe where strips of trees or shrubs must be crossed.

Subsurface obstacles may be stones, tree stumps, and solid rock. The vertical plough is the best in dealing with loose stones and tree stumps, as long as they are not too big. If obstacles are too big, they will have to be removed with a hydraulic excavator. Solid rock can, under certain conditions (not too hard; shallow penetration), be dealt with by a special type of trencher.

21.4.6 Supervision and Inspection

Inspection and supervision of drain installation are required for several reasons:

- To ensure that design specifications are complied with;
- To handle unforeseen conditions during installation;
- To check the quality of the materials used (pipes, envelope), which includes certification and a site-check on possible damage during transport and handling;
- To ensure good workmanship, including the proper alignment of pipe lines, which should be straight and according to the design slope, within an accepted tolerance (e.g. half the inside pipe diameter for field drains), and with proper joints;
- To see that the trenches are properly backfilled and compacted;
- To assess the need for any extra work or modifications, which implies that the supervisor should be a well-qualified person.

Inspection Methods

When clay or concrete pipes are installed with a trencher, supervision is comparatively simple and straightforward because it can be done visually. Checking the gradient can be done with a levelling instrument and a staff gauge in the open trench behind the machine. With the introduction of pre-wrapped corrugated pipe, however, and the consequent trenchless pipe installation, visual inspection and levelling have been made virtually impossible. One must therefore resort to other checking methods such as rodding and level recording.

Rodding is done by pushing a rigid steel rod through the pipe outlet into the drain pipe over its entire length (Van Zeijts and Zijlstra 1990). The steel rod has a torpedo-shaped tip, and a glass fibre rod to assist in the pushing (Figure 21.26). If the drain

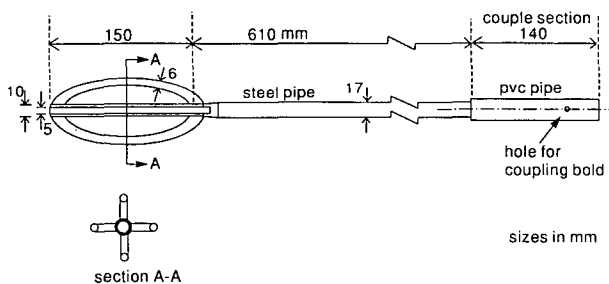

Figure 21.26 Drawing of the rodding head

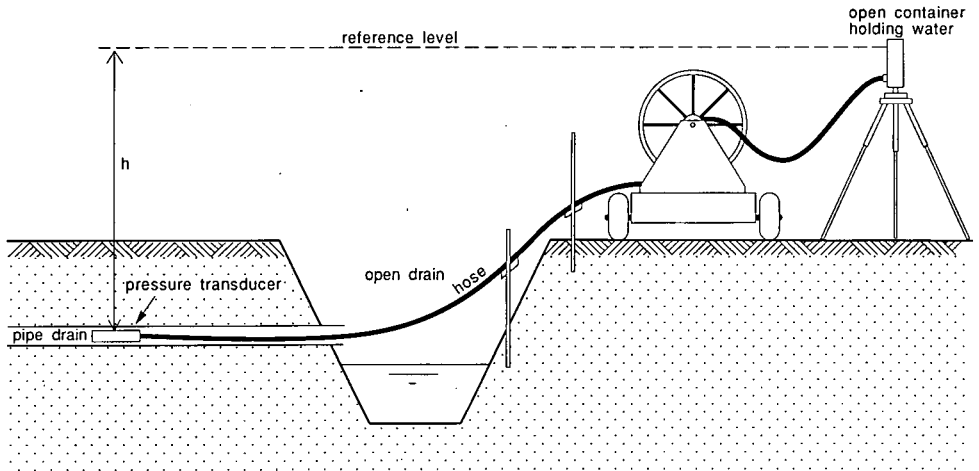

Figure 21.27 Level recording instrument for continuous depth recording (Van Zeijts 1987)

has been correctly installed, the rod can pass unhindered. The required pushing force increases slightly with the length of the drain. If the drain spirals, however, the required pushing force increases with the length of the drain. The required force should not exceed a pre-set limit. If the rod cannot pass a particular point in the drain, there is a fault in the installation, and the drain has to be excavated at this point. Rodding is also a useful way to make sure that the drain will be accessible for flushing (Section 21.5.3).

Another method is to use a level recording instrument, based on the ancient water-level gauge (Van Zeijts 1987). One end of a hose is connected to a special open container, the water surface of which serves as a reference level (Figure 21.27). A pressure transducer, fitted to the other end of the hose, slides into the drain. This

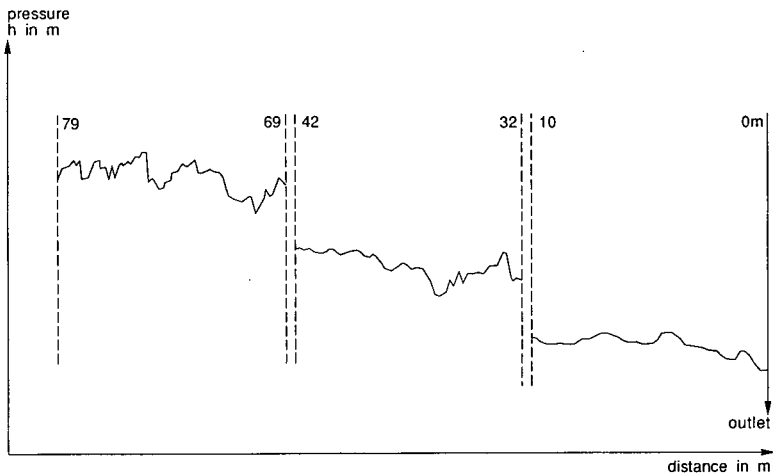

Figure 21.28 Graph representing drain depth as recorded during retraction of the transducer (Van Zeijts 1987)

transducer transforms the hydrostatic pressure into an electric signal, which is proportional to the hydrostatic pressure over the reference level. The transducer can be inserted into the drain to a maximum length of 200 m. Measuring takes place while the hose is being withdrawn from the pipe. The hydrostatic pressure can be measured with an accuracy of less than 2 mm. The data can be recorded in digital form and plotted graphically (Figure 21.28). This method is quite costly: under Dutch conditions, the cost per metre amounts to about 50% of the total costs of pipe drainage. A routine check of all installed drains is thus too expensive, and a system of random checking and certification has to be adopted.

Continuous level recording by the drainage machine is a method currently being developed. It consists of a device on the drainage machine which continuously measures the elevation of the drain pipe as it leaves the machine. The measuring data are fed into a portable computer, which is also mounted on the machine. The output can be a graph showing the pipe elevation compared with the prescribed gradient.

21.5 Operation and Maintenance

Once a drainage system has been installed, we have to ensure that it will function properly for a long time. Technically, this requires that a good drainage base is maintained, that the system is inspected regularly, and that repairs and cleaning are done when necessary. Administratively, responsibilities for operation and maintenance must be well-defined, and an adequate budget must be available. In large projects, it is common that, upon completion of the drainage works, the responsibility for the system is transferred from a construction agency to an operation/maintenance agency.

21.5.1 'As-Built' Data of Drainage Works

The agency responsible for operation and maintenance should have available the 'as-built' data on the drainage works. These should include an accurate map of all main components (e.g. field drains, collectors, connections, and outlet structures). In addition, the agency should know the elevations of collector points (outlet, inflow and outflow levels in manholes, longitudinal sections), of field drain outlets, and of reference points on major structures like manholes. For future flushing operations, it also needs to know the exact location of blind junctions between field drains and collectors.

Most of the required data will be included in the design specifications, but they should be duly updated, because the actual construction may have deviated from the design.

21.5.2 Monitoring

There are three kinds of checks to be made of pipe drain systems: a post-construction check, routine checks, and thorough checking.

A post-construction check is done to ascertain whether the construction was done to an acceptable standard, and whether the drainage works have been delivered in good functional order. This check is mainly covered under the field supervision discussed in Section 21.4.6.

Routine inspections are simple operation-and-maintenance checks to verify whether the system is functioning properly, and to see whether there is any need for repair or cleaning. Some items covered by this type of inspection will be listed below.

A thorough check of the functioning of the system may follow after routine inspection has revealed significant problems. Such a check may also be intended as a monitoring program, aimed at improving the empirical basis for future drainage projects in the region. Principles and methods of thorough checking will be dealt with in Section 21.8.

Simple routine inspections can be done according to a locally suitable checklist. Generally important points to include in such a list are:

- Check the drainage base (i.e. check whether the pipes have free outflow, especially in a period when drainage is most needed; note, however, that an occasional, very brief submergence of the outlets is normally accepted). A good drainage base is the first and foremost condition for a pipe system to function satisfactorily. If the drainage base is found to be unsatisfactory, the main drainage system should be maintained or improved;
- Check that pipes are discharging during and shortly after rain or irrigation;
- Monitor water levels in manholes. High water levels in an individual manhole indicate an obstruction in the collector. When high water levels are found, the water levels in all manholes along a collector should be compared, which may give a clue as to where the problem is;
- Check whether sediments or other pollutants have accumulated in the silt traps of manholes;
- Look at the land surface for wet spots, as signs of waterlogging, a few days after rain or irrigation;
- Check the depth of the watertable, especially where wet conditions are found;
- Look for any damage to pipe outlets and manholes.

Note that the observations on pipe outflow, water levels, and wet field spots should, of course, concern the same drainage event and the same drain pipe.

A suitable time schedule for the above routine inspections would be to start with a first inspection shortly after the system has been installed, during the first or second drainage event when the drains should be running. Further inspections could follow about once a year, a frequency which, after a few years without problems, could possibly be reduced to once every two years.

21.5.3 Cleaning Pipe Drains with Flushing Machines

The Functions of Flushing

The flushing of drain pipes has three main functions:

- To open up any blocking and to loosen any deposits inside the pipe;

- To clean and open up any blocked perforations;
- To carry any pollutants in suspension out of the drain.

For the two unclogging functions, powerful jets that develop sufficient pressure are required. The transport function requires an adequate flow velocity, which is realized through a sufficient pump discharge, but does not necessarily need high pressure.

The Flushing Method

Flushing is done from the downstream end of a pipe drain. Water is pumped into the drain through a hose, which is entered into the drain from the outlet. The nozzle produces one forward jet and several backward jets. Sediments in the pipe are loosened, and are then evacuated from the drain by the water flow.

The standard equipment comprises a pump with a hose, mounted on a reel. The pump is driven by the power take-off of a tractor. The unit may either be built on a two-wheel trailer or be directly mounted on the tractor (Figure 21.29).

When a singular drainage system is flushed, the required water is usually pumped from the open drain. Flushing a composite system, where distances to an open drain are long, water may have to be brought to the site in a water tank. Alternatively, a long hose with a booster pump may be used. Access to the field drain in a composite system is through a manhole or through a flushing structure like the one that was shown in Figure 21.6.

Technical Characteristics

Flushing units are commonly categorized according to the pressure developed by the pump (Bons and Van Zeijts 1991):

- Low pressure: up to some 2000 kPa (= 20 bar);
- Medium pressure: 2000 to 5000 kPa;
- High pressure: over 5000 kPa, up to about 10 000 kPa.

Owing to friction losses in the hose, the pressure at the nozzle is about 50% of the

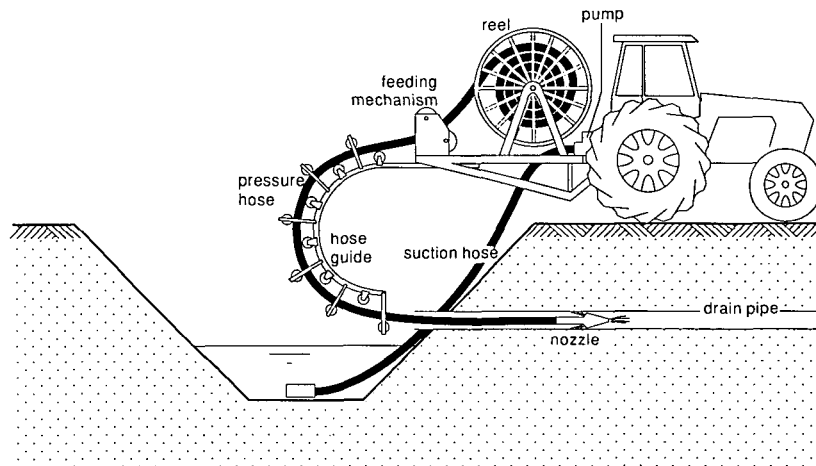

Figure 21.29 Flushing machine

pressure at the pump. The maximum discharge of the various pumps does not vary as much as the pressure. Common discharges range from 0.003 to 0.004 m³/s. There are two types of hose: reinforced rubber and Polyethylene (PE). Reinforced rubber is flexible and can withstand pressures of up to about 10 000 kPa, and is thus used in high-pressure pumps. PE tolerates pressures up to 3500 and to 5000 kPa, and is thus used with low- and medium-pressure pumps. The maximum hose length of current flushing units is approximately 300 m, but lengths of up to 700 m are possible, albeit at the expense of a considerable pressure loss and a reduced flow rate. The backward jets of the nozzle of a high-pressure flushing unit produce sufficient reaction force to pull the hose into the drain. With low- or medium-pressure machines, the hose needs to be pushed. This is only possible if it has sufficient stiffness, which is another reason why PE has to be used. The pushing is usually done by a feeding mechanism mounted on an adjustable hose guide (see Figure 21.29).

The Effect of Flushing

Using high pressure involves the risk of destabilizing the soil surrounding the pipe, which may lead to a higher rate of sedimentation after the flushing operation. This risk is especially prominent in sandy soils, so that low- or medium-pressure pumps are recommended for them.

The flushing method is satisfactory for removing clay, silt, and iron (ochre) deposits. Once loosened, these materials are carried away by the water, even at low flow velocities. Sand, however, is difficult to remove, because comparatively high flow velocities are required. This point is clearly illustrated in Figure 21.30. The most likely effect of trying to flush a localized sand deposit with low velocities is to spread it over a few metres only, but even that may help temporarily. An effective, though time-consuming, way to tackle sand deposits in a drain is to push and withdraw the nozzle repeatedly, each time advancing a few metres.

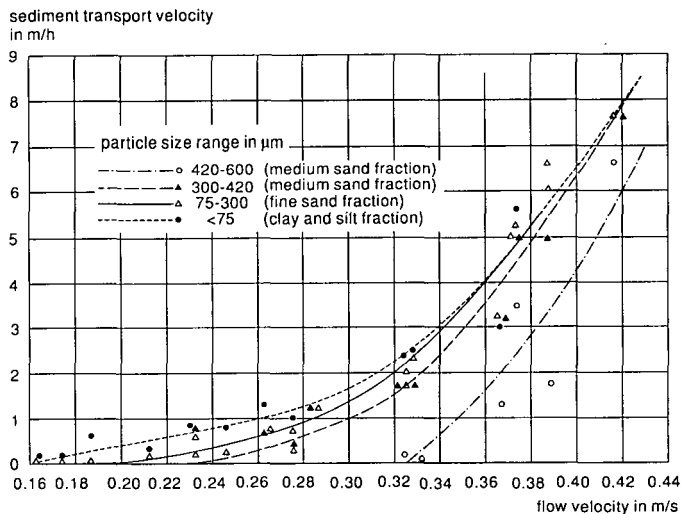

Figure 21.30 Relation between flow velocity and transport of sediments in smooth lined concrete drain pipes (after Bons and Van Zeijts 1991)

While a drain is being flushed, a large portion of the water may disappear through the perforations of the drain into the soil, thus considerably reducing the flow in the pipe towards the outlet. Flushing when the watertable is above drain level helps to avoid this problem.

The current types of flushing machines do a good job for field drains with internal diameters in the range of 0.05 to 0.09 m. For much larger pipe diameters (e.g. collectors), their flow velocities are too low. It is a common misunderstanding that the cleaning of large-diameter pipes requires high-pressure pumps. For collectors, it is better to introduce a large influx of water with another pump, directly at the upstream end of a given pipe section (e.g. through a manhole). Estimated flow rates, velocities, and hydraulic heads for the selection of a suitable pump can be obtained through hydraulic calculations (Section 21.6).

21.6 Hydraulics of Drainage Pipes

In this section, we consider the capacity and length of the drain pipes for various diameters and slopes, and determine the maximum area drained by field drains and collectors. We then use this, in combination with the drain spacing calculations (Chapter 8), to determine the layout of the pipe drainage system (Section 21.3.7).

The amount of water to be conveyed by a pipe drain follows from the design drainage coefficient and the area served by the pipe. This pipe design discharge, Q , is thus

$$Q = q A = q W B \quad (21.1)$$

where

Q = pipe discharge (m^3/d)

q = drainage coefficient (m/d)

A = area to be drained (m^2)

W = width of area to be drained by the pipe line (m). For field drains, W is usually equal to the drain spacing L

B = length of pipe line (m)

For the hydraulic design, the following have to be considered:

- The equations to be applied;
- The hydraulic gradient and the slope of the pipe line (which are not necessarily identical);
- How to take into account the wall roughness of the type of pipe that will be used;
- A safety coefficient to take into account any reduction in discharge capacity due to construction limitations, sedimentation, root intrusion, and any other flow-restricting factors.

Drain pipes are designed for full flow. The maximum capacity of a pipe actually occurs just before the pipe starts flowing full (Chow 1973). Sometimes, the designer will wish to check on the actual flow depth that might occur in certain situations. When the pipe is not flowing full, it is not possible to solve the Manning Equation explicitly;

hence, we present a numerical approximation method, suitable for use with spreadsheets, computers, and programmable calculators.

21.6.1 Solving Manning's Equation for Pipe Flow

The Manning Equation can be written as

$$Q = \frac{1}{n} AR^{\frac{2}{3}} s^{\frac{1}{2}} \quad (21.2)$$

in which

- Q = flow rate (m³/s)
- n = Manning's roughness coefficient
- A = cross-sectional area (m²)
- s = hydraulic gradient (-)
- R = hydraulic radius (m)
- P = wetted perimeter (m)

For full-flowing pipes

$$R = \frac{A}{P} = \frac{0.25 \pi d^2}{\pi d} = \frac{d}{4} \quad (21.3)$$

so that Equation 21.2 becomes

$$Q = 0.312 \frac{1}{n} d^{2.67} s^{\frac{1}{2}} \quad (21.4)$$

When the pipes are flowing full, various parameters of interest can be solved explicitly with this equation.

Inside diameter, d

$$d = \left(\frac{nQ}{0.312 s^{\frac{1}{2}}} \right)^{\frac{1}{2.67}} = 1.548 (nQ)^{0.375} s^{-0.188} \quad (21.5)$$

Hydraulic gradient, s (equal to average pipe slope)

$$s = 10.3 n^2 Q^2 d^{-5.33} \quad (21.6)$$

After setting the Q's of Equations 21.4 and 21.1 equal to each other, we find the maximum drain length, B_{max}, to be

$$B_{\max} = \frac{0.312 d^{2.67} s^{\frac{1}{2}}}{n q w} \quad (21.7)$$

Similarly, (by combining Equations 21.7 and 21.1), we find the maximum area drained with the selected pipe diameter and slope from

$$A_{\max} = B_{\max} W \quad (21.8)$$

When the pipe is not flowing full, or if the approximation formula for Manning's n is used (Equation 21.25), we cannot explicitly solve the depth, d , or the water level, y , in the pipe. Instead, we use a method that approximates finding tangents and does not require us to determine the differential forms of the Manning Equation. This method is called the Synthetic Newton-Raphson Method and is derived from the Newton-Raphson Method (O'Neil 1983). To use this method, the wetted area and perimeter need to be determined, while for calculations of discharge with sediment in the pipe, the top width B also needs to be calculated.

$$P = \frac{1}{2} \phi d \quad (21.9)$$

$$A = \frac{1}{8} (\phi - \sin \phi) d^2 \quad (21.10)$$

$$\phi = 2 \arccos \left(1 - \frac{2y}{d} \right) \quad (21.11)$$

where

ϕ = angle between the radius to the water surface (Figure 21.31)

d = inside pipe diameter

The top width is calculated from

$$B = \left(\sin \frac{1}{2} \phi \right) d = 2\sqrt{y(d-y)} \quad (21.12)$$

where

B = top width (m)

First, we set a starting value of the unknown parameter in the Manning Equation, in our case d . We then determine, by iteration, successive values of d , using

$$x_{n+1} = x_n - \left[\frac{pc_{n-1} f(x_n)}{f(x_{n-1})} - f(x_n) \right] \quad (21.13)$$

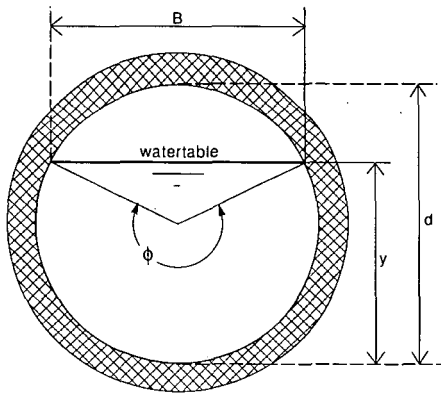

Figure 21.31 Nomenclature for circular drain pipe

where

x = the unknown, d when solving for the diameter, but it can be any parameter in the equation

n = 1, 2,

$f(x)$ = the function to be solved in the form $f(x_n) = 0$

pc = the previous correction, which is initially assumed to be $0.5x_1$, and for subsequent iteration calculated from

$$pc_n = \frac{pc_{n-1} f(x_n)}{f(x_{n-1}) - f(x_n)} \quad (21.14)$$

Note that, the first time through, $f(x_{n-1})$ will be zero.

To solve for the diameter, Manning's Equation needs to be written in the form

$$f(x_n) = Q - \frac{1}{n} AR^{\frac{2}{3}} s^{\frac{1}{2}} = 0 \quad (21.15)$$

When $|f(x_n)| < 0.00001 \text{ m}^3/\text{s}$ or $|x_n - x_{n-1}| < 0.001$, the solution has been found. Care should be taken to select the right accuracy, otherwise the solution will not converge, i.e. for discharge 0.01 l/s and for diameter and depth 1 mm are recommended. The initial values for the unknown, $f(x_{n-1})$, and the previous correction, pc_{n-1} , should be less than the expected diameter of the pipe and in the appropriate unit.

21.6.2 Adapting the Manning Equation (Uniform Flow) to Perforated Pipes (Non-Uniform Flow)

In the basic flow equation for full-flowing circular pipes (Equation 21.4), it is assumed that the discharge, Q , is constant over the length of the pipe, or in other words that the pipe has no openings through which water could enter or leave on its way to the outlet. This is true for closed conduits or transport pipes with a constant flow velocity (steady uniform flow; Figure 21.32A), but a drain pipe is perforated and is meant to receive water along its path. The flow rate increases gradually in the direction of flow, from zero at the upstream end, to Q_d at the outlet (Figure 21.32B). This is accompanied by a hydraulic gradient which changes from zero at the upper end to a high value near the outlet (spatially varied flow).

For the same discharge to occur at the outlet, the hydraulic gradient of Figure 21.32A is the tangent to the curved hydraulic gradient line of Figure 21.32B at the outlet point (Figure 21.32C).

For the gradually increasing flow (Figure 21.32B), the discharge of a field drain (Q_d) at a distance x from the upper end equals

$$Q_d = Q_x = q W x \quad (21.16)$$

The hydraulic gradient at any x is

$$s = \frac{dh}{dx} \quad (21.17)$$

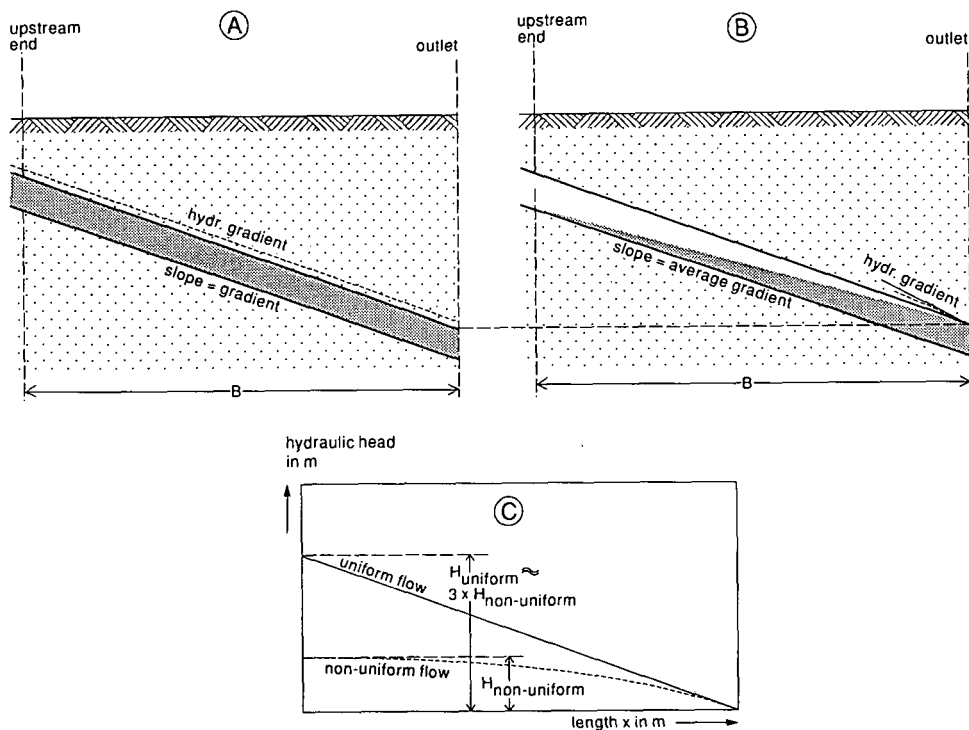

Figure 21.32 Hydraulic gradients for uniform and non-uniform flow:

- A: Constant flow;
- B: Non-uniform flow (pipe flow increases in downstream direction);
- C: $Q_{\text{uniform}} = Q_{\text{non-uniform}}$;

Substituting Equations 21.16 and 21.17 into Equation 21.6, we find the friction loss per unit length to be

$$s = \frac{dh}{dx} = 10.3 n^2 d^{-5.33} (qWx)^2 = F q^2 W^2 x^2 \quad (21.18)$$

where

x = distance along the pipe line from the upper end (m)

$F = 10.3 n^2 d^{-5.33}$, a constant

Integrating Equation 21.18 between the limits $h = 0$ at $x = 0$, and $h = h_B$ at $x = B$ gives

$$h_B = \frac{1}{3} F q^2 W^2 B^2 \quad (21.19)$$

Calculating the average hydraulic gradient over the length of the drain pipe (s_{dr}) gives

$$s_{dr} = \frac{h_B}{B} = \frac{1}{3} F (qWB)^2 = \frac{10.3}{3} n^2 d^{-5.33} (qWB)^2 \quad (21.20)$$

If we assume that the hydraulic gradient of the uniform flow is equal to that of the non-uniform flow, it follows from Equations 21.6 and 21.20 that

$$s_{tr} = \frac{1}{3} s_{dr} \quad (21.21)$$

Equation 21.21 shows that, the outflow Q being equal, the head loss in a draining pipe line is $1/3$ of that in a transport pipe line (Figure 21.32C). Since Q is a function of $(s)^{1/2}$ (Equation 21.4), it follows that, for equal s (i.e. for equal $h = h_B$) and for a field drain flowing full at the outlet, we can write

$$Q_{dr} = Q_{tr} \sqrt{3} = \frac{0.540}{n} d^{2.67} s^{\frac{1}{2}} \quad (21.22)$$

With equal total head loss, the allowable maximum discharge of a non-uniform drain pipe is higher, by a factor of $\sqrt{3}$, than for a uniformly flowing transport pipe, provided that the uniformly flowing pipe is flowing full over its entire length. This is explained by the extra friction losses that need to be overcome in a uniformly flowing pipe.

Note: If a perforated field drain is designed with the Manning Equation, assuming full flow, a safety margin of $1/\sqrt{3}$, or approximately 58%, is included (see also Section 21.6.5).

21.6.3 Hydraulic Gradient and Slope

A drain pipe line need not necessarily be sloping. A horizontal drain, or even one with a counter-slope, will still be able to fulfil its function. The hydraulic gradient, which is needed for the flow, will establish itself automatically as an overpressure in the pipe (Figure 21.33A). This can be verified by placing a piezometer in the pipe.

Nevertheless, it is common practice to install drains with a certain slope, for which there are several practical reasons, such as:

- Less risk of water remaining stagnant in some parts of the pipe line, which would increase the risk of the sedimentation of suspended clay particles;
- Less risk of counterslopes in some parts of the pipe line, which would cause the development of air pockets that would restrict the flow (Section 21.7.5);
- To follow the slope of the land and keep the depth of the drain below the land surface more or less the same along the drain. In practice, this also means that drains can be longer.

In hydraulic design, the hydraulic gradient is considered to be parallel to the slope at which the drain has been installed. The implicit requirement is that, at normal design discharge, no overpressure will occur at the upstream end of the drain (Figure 21.33B).

If we assume the drain discharge equal (Figures 21.33A and 21.33B), both cases are hydraulically the same and so, too, is the watertable in between the drains. When drains run full, the discharge is determined by the hydraulic gradient and not by the pipe slope.

A higher gradient (in practice: a steeper slope) allows us to economize on pipe

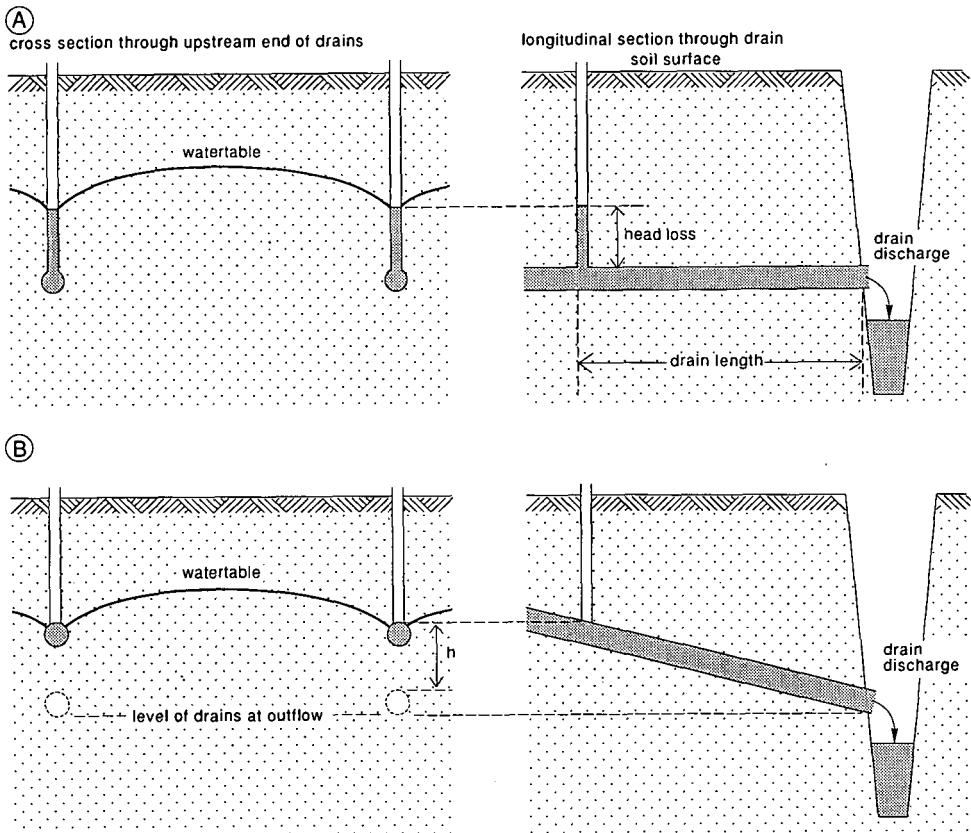

Figure 21.33 Hydraulics of flow through (A) a horizontal drain and (B) a sloping drain. The discharge is the same in both cases.

diameter. Nevertheless, the possibilities of applying steep slopes are usually limited because the watertable depth at the upper end is fixed by agricultural criteria, and at the lower end by the water levels in the collector (open drain or collector pipe). When steeper slopes are used, the flow velocity should not exceed certain limits (Section 21.3.6). Common drain slopes in flat areas are 0.001 for field drains and 0.0003 to 0.001 for collectors.

21.6.4 Pipe Roughness Coefficient

To take pipe roughness or friction into account, there are two common variables to express the roughness or friction: the friction factor in Darcy-Weisbach's Formula and Manning's Coefficient, n . Practical values for Manning's n are given by Chow (1973). Those appropriate for subsurface pipe drainage have been reproduced in Table 21.7, complemented with some other values found in literature. Generally, the roughness coefficient for clay and concrete tiles depends on the placement whereas,

Table 21.7 Values for Manning's coefficient 'n'

	Minimum	Normal	Maximum
Pipes flowing partly full			
Metal (Chow 1973)			
corrugated metal, subdrain	0.017	0.019	0.021
corrugated metal, storm drain	0.021	0.024	0.030
Non-metal (Chow 1973)			
concrete, straight and free of debris	0.010	0.011	0.013
concrete, bends, connections, some debris	0.011	0.013	0.014
concrete, finished	0.011	0.012	0.014
concrete, steel form	0.012	0.013	0.014
concrete, smooth wood form	0.012	0.014	0.016
concrete, rough wood form	0.015	0.017	0.020
clay common drainage tile	0.011	0.013	0.017
Corrugated PVC, d = 105 mm (Zeigler et al. 1977)			
flow at 0.25 d	0.0170	-	0.0185
flow at 0.50 d	0.0150	-	0.0160
flow at 0.75 d	0.0153	-	0.0170
Pipes flowing full			
Drain tiles d = 50-150 mm (Johnson 1971)	0.0110	0.0140	0.0170
Clay tiles (Wesseling and Homma 1967)	0.0130	-	0.0200
Clay tiles (Irwin and Tsang 1972)		0.0110	
Cement pipe d = 150 mm (Wahid El-Din et al. 1990)		0.0129	
Corr. plastic pipes d = 40, 50 mm (Wesseling and Homma 1967)		0.0140	
Corrugated PE recommended (Broughton et al. 1992)			
d = 38 mm	0.0180		0.0200
d = 50 mm		0.0160	
d = 75 mm		0.0160	

d inside diameter of the drain pipe (mm)

for corrugated plastic pipes, it depends on the shape of the corrugations. The most elaborate, and probably most complete, description of the behaviour of the roughness coefficient in circular pipes is given by Chow (1973). Manning's n varies with the depth of flow in the pipe, but considering some of the other uncertainties in the design of subsurface drainage systems (Section 21.3.5), Manning's n is usually taken as a constant for all flow depths.

The head loss due to friction in a circular full-flowing pipe can be calculated from (Darcy-Weisbach)

$$h_f = f \frac{L}{d} \frac{v^2}{2g} \quad (21.23)$$

where

h_f = hydraulic head loss over pipe length L (m)

L = pipe length (m)

f = dimensionless friction factor (often λ in other publications)

d = inside pipe diameter (m)

g = acceleration due to gravity (m/s^2)

v = average flow velocity (m/s)

The coefficient, f , is a function of the Reynolds' number, Re , the relative pipe roughness or height of the corrugation, k , the distance between the corrugations, c , the clear distance between roughness elements, j , and the effective inside diameter (Irwin 1982). For small-diameter pipes (< 80 mm), the quality of the perforations was also found to have an effect (Wesseling and Homma 1967). The results of measurements of the roughness for corrugated pipes are given in Table 21.8, while Figure 21.34 shows the nomenclature used. It was found that if $Re > 10^5$, the friction factor f and Manning's n are more or less constant for higher Re -values, but with lower flows the friction tends to increase with the larger pipe diameters (Irwin and Tsang 1972; Irwin and Motcyka 1979). For $Re > 10^5$ and full flowing pipes, the following relationship between f and n can be derived from Equations 21.4 and 21.23

$$n = 0.090 d^{1/6} f^{1/2} \quad (21.24)$$

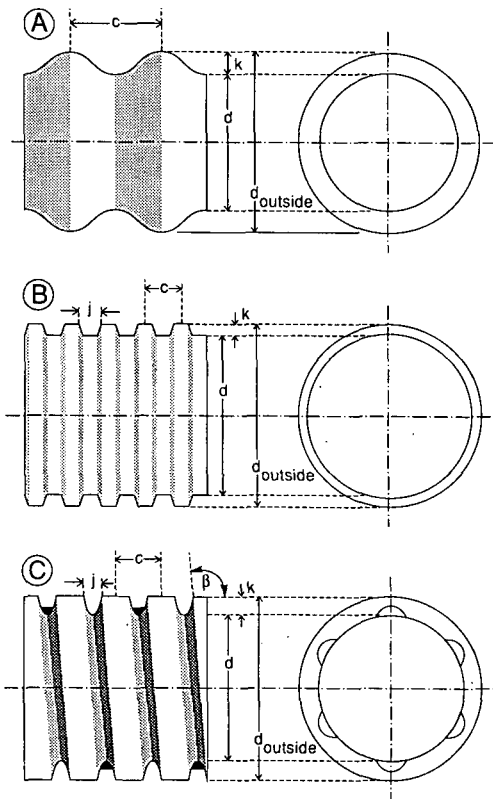

Figure 21.34 Nomenclature used with corrugated plastic drain pipes

- A: Sinusoidal corrugations
- B: Parallel or concentric corrugations
- C: Spiral corrugations

Table 21.8 Laboratory measured f and n -values for the full flowing corrugated plastic pipes

Location of testing and/or origin of pipe	Material	Diameter in mm		
		Nominal	Outside	Inside
The Netherlands (Heidemij 1972)	PVC	350	347	312
Canada (Irwin and Tsang 1972)	not given (plastic)	100	112	102
		100	116	102
		100	114	102
		100	116	102
Canada (Irwin and Motycka 1979)	not given (plastic)	100	117	102
		200	238	202
		250	292	251
		300	360	302
Egypt (Wahid El-Din et al. 1990)	HDPE	100	119	100
	HDPE	150	175	150
	PVC	72	80	72
	PVC	115	125	115
U.S.A. (Dinc et al. 1971) same diameters are of different manufacturers	PE	100	115	98
		100	116	100
		100	118	102
		125	147	127
		145	155	143
		150	166	156
		200	239	210
200	219	203		
U.S.A. (Ziegler et al. 1977)	not given (plastic)	100	121	105
Egypt/Canada (Broughton et al. 1990)	PE	75	93	77
		100	121	104
		150	179	151
		200	242	202
		250	303	250
		310	368	310
		400	476	402
		500	594	502
		610	718	614
750	867	754		
Canada (Broughton et al. 1992)	PE, Manuf. A	38	50	38
		50	60	52
		75	89	74
	PE, Manuf. B	38	48	39
		50	59	50
		75	84	73
	PE, Manuf. C	50	63	52

¹ Sharp edged corrugations caused higher friction factor f

² Spiral at angle of 93.5 deg. to the direction of flow

³ Calculated with Equation 21.24

⁴ Derived from discharge-gradient log-log plots in article using Equation 21.4

⁵ n -values from the same source reported by Abdel Dayem (1986) are 0.0189, 0.0182, 0.0140 and 0.0155

⁶ For double-wall pipes (Figure 21.1) $n = 0.0090$

Height of corrugations (mm)	Distance between corr. (mm)	Shape of corrugation (Figure 21.34)	Darcy-Weisbach friction f	Manning's n measured or derived
16.6	52.2	parallel	0.0602	0.0185 ³ 0.0175 ⁴
5.3	13.0	sinusoidal	0.067	0.0159 ³
7.0	13.0	parallel	0.054	0.0142 ³
6.0	13.0	parallel	0.077	0.0170 ³
7.0	13.0	double spiral ²	0.064	0.0155 ³
7.6	12.7	sinusoidal	0.070	0.0162 ³
18.3	33.0	parallel ¹	0.082	0.0197 ³
20.5	33.0	parallel	0.068	0.0186 ³
29.2	50.8	parallel	0.095	0.0227 ³
4.0	6.0	not specified	-	0.0180 ^{4,5}
5.0	6.0	but sketch would	-	0.0198 ^{4,5}
4.5	17.0	suggest	-	0.0138 ^{4,5}
12.5	24.0	sinusoidal	-	0.0149 ^{4,5}
-	17.8	-	-	0.0162
-	12.7	not specified	-	0.0160
-	12.7	but sketch would	-	0.0150
-	17.8	suggest	-	0.0175
-	12.7	parallel	-	0.0153
-	12.7	-	-	0.0156
-	29.2	-	-	0.0131
-	12.7	-	-	0.0178
6.0	25.4	parallel	0.065	0.0156
6.9	15.2	parallel	-	0.0150
7.6	15.2	parallel	-	0.0160
12.2	21.8	parallel	-	0.0170
17.8	30.5	parallel	-	0.0180
21.9	38.1	parallel	-	0.0190
26.9	50.8	parallel	-	0.0200 ⁶
34.0	60.9	parallel	-	0.0200 ⁶
42.0	76.2	parallel	-	0.0210 ⁶
47.6	76.2	parallel	-	0.0210 ⁶
50.7	76.2	parallel	-	0.0210 ⁶
5.6	8.5	parallel	-	0.0203
3.7	8.5	parallel	-	0.0142
6.7	12.8	parallel	-	0.0157
3.7	7.9	parallel	-	0.0163
3.8	10.4	parallel	-	0.0165
3.9	13.4	parallel	-	0.0154
5.0	10.0	parallel	-	0.0153

Nominal diameter - diameter that manufacturers use to identify the pipe, usually close to inside diameter

Inside diameter - smallest diameter measured inside the pipe between opposing corrugations

Outside diameter - outside diameter including wall thickness

where

d = inside diameter (m)

f = dimensionless friction factor as before

From those values of Table 21.8 that give adequate information on the dimensions of the corrugations, we can derive the following relationship to relate Manning's n directly to corrugated pipe dimensions (Figure 21.35E)

$$n = 0.015 + 0.02 d - 0.013 d^2 \quad (21.25)$$

where

d = inside diameter of the corrugated pipe (m)

Although some good relationships exist between the corrugation height, the corrugation distance (pitch), and the inside pipe diameter, no good relationship was found between the relative roughness, the relative distance, and Manning's coefficient (Figure 21.35A-D). The best fit between the inside diameter and Manning's coefficient had only a marginal regression coefficient of $r^2 = 0.51$. A slightly higher curve, starting at $n = 0.015$, is recommended for use in computer programs and spreadsheets (Equation 21.25 and Figure 21.35E). Equation 21.25 will cover most corrugated pipes, but in some cases Manning's coefficient can be higher when corrugations are relatively

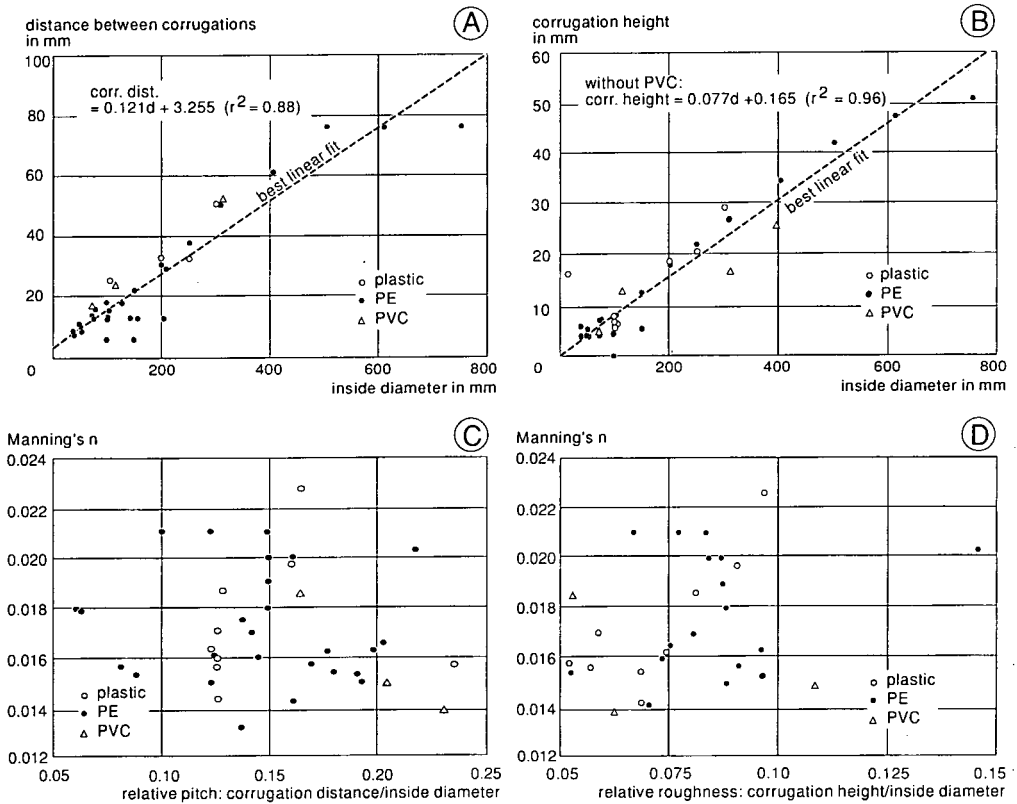

high, as was observed for the 38 mm pipe of Manufacturer A (Table 21.8, Broughton et al. 1992).

21.6.5 Safety Coefficient

In the course of time, it has to be expected that the actual flow capacity of pipe drains will decrease somewhat because of soil sedimentation, chemical deposits, or root intrusion. When the amount of sediments becomes excessive, the pipes need to be cleaned. A limited amount of obstruction of the flow in the pipe is acceptable. The degree of reduction in capacity is a matter of personal judgement by the designer. Figure 21.36 shows the effect of sedimentation on the discharge capacity of a full-flowing pipe.

Depending on the preference of the designer, there are various ways of incorporating safety factors to cover the reduction in pipe capacity. A traditional method is to reduce

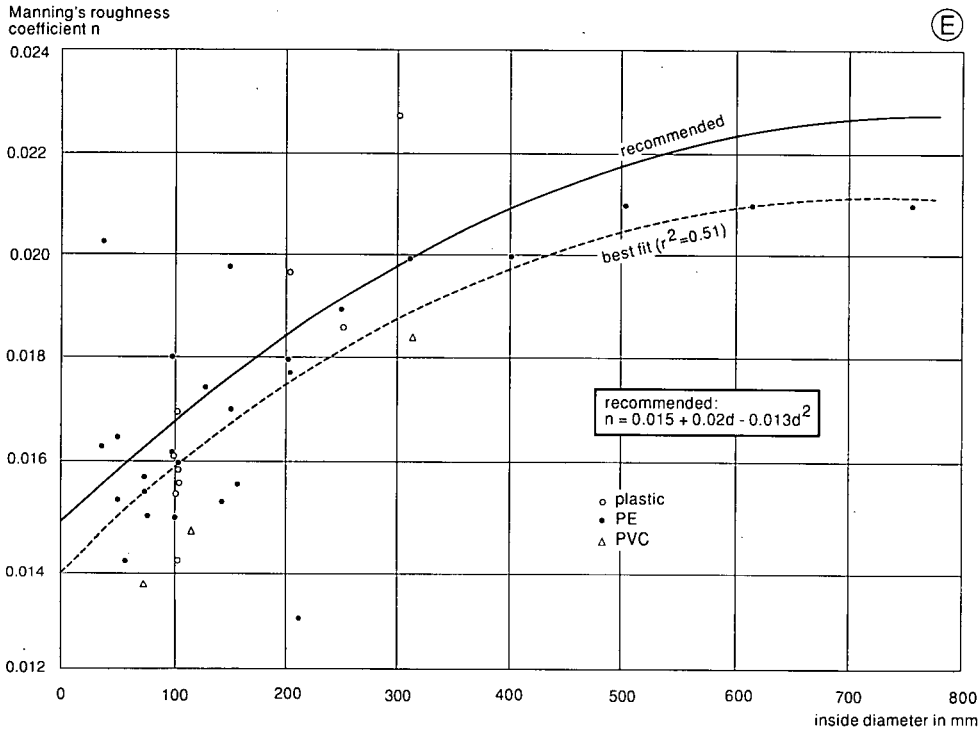

Figure 21.35 Relationship between some selected corrugated plastic pipe dimensions (based on data from Table 21.8)

- A: Corrugation distance and inside diameter
- B: Corrugation height and inside diameter
- C: Relative corrugation distance and Manning's roughness coefficient
- D: Relative corrugation height and Manning's roughness coefficient
- E: Inside diameter and Manning's roughness coefficient (recommended for calculations)

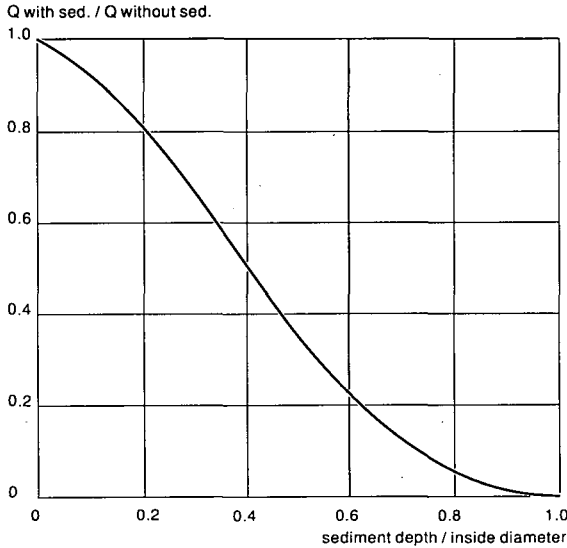

Figure 21.36 Reduction of discharge as a function of the sedimentation in the pipe

the pipe discharge by a reduction factor, R , in accordance with the following guidelines:

- For small diameters (in general, field drains: $d < 100$ mm), take 60% of the theoretical capacity ($R = 0.60$);
- For larger diameters (in general, collectors: $d > 100$ mm), take 75% of the theoretical capacity ($R = 0.75$).

The main reasons for distinguishing between small and large diameters are that:

- Field drains are more prone to sedimentation than collectors;
- In smaller diameter pipes, a given amount of sediment will occupy a larger portion of the cross-section of the pipe.

Reducing the pipe capacity rather than increasing it seems odd, but the method of determining pipe diameter and pipe length actually reduces the effective area drained by prescribing a shorter length of drain of a certain diameter. Equation 21.22, with $R = 0.60$, is generally used for field drains, whereas Equation 21.4, with $R = 0.75$, is used for collector drains.

Field measurements in Egypt (El Atfy et al. 1990) indicate that for concrete collectors, designed with $n = 0.014$, a reduction factor of $R = 0.50$ is more appropriate in view of construction methods, materials used, sedimentation, and irregularities in the alignment.

In the U.S.A. and Canada, it is more common to use Equation 21.4 for field drains. As Broughton (1984) also concluded, when he compared design procedures for a drainage project in Pakistan, Equations 21.4 and 21.22 differ by a factor $\sqrt{3}$, and the use of the straightforward Manning Equation (Equation 21.4 for a full-flowing pipe) will result in a reduction coefficient of $R = 1/\sqrt{3} = 0.58$. This is very close

to the $R = 0.60$, the value recommended above, so both methods result in essentially the same design for pipe diameter and/or length of the field drain.

For collectors, a safety factor between $R = 0.50$ and $R = 0.75$ can be applied, depending on the expected field and construction conditions. Generally, the flow rate is increased by dividing by R before a pipe diameter is selected. Because large areas can drain into a subsurface collector, the USBR (1978) proposed an area reduction factor for collectors in irrigated areas if the area drained is more than 20 ha (Figure 21.37). Broughton (1984) compared the USBR reduction factors with those calculated for a drainage project in Pakistan and found that, in the actual design, slightly higher area reduction factors were used than those recommended by the USBR.

Yet another form of incorporating a safety factor is to use different design drainage coefficients for field drains and collectors. In Egypt, for instance, collectors are generally designed with a higher drainage coefficient than the field drains. This is because the collectors used in Egypt are more prone to sedimentation and alignment problems than field drains (Collectors are generally concrete pipes of increasing diameter, while the field drains are plastic pipes). The connections at manholes, as well as the connections between field drains and collectors, are potential trouble spots, so it is better to apply a conservative safety factor to collectors. If a collector becomes partially blocked, it affects a larger area than a partially or fully blocked field drain, which is another good reason for applying a larger safety factor for collectors. However, rather than increasing the drainage coefficient, q , it is better to apply a safety factor in the hydraulic design procedure. This enables a comparison of drainage coefficients of different projects and in different countries. The drainage coefficient should be strictly an estimate of the drainable surplus, without implied safety factors.

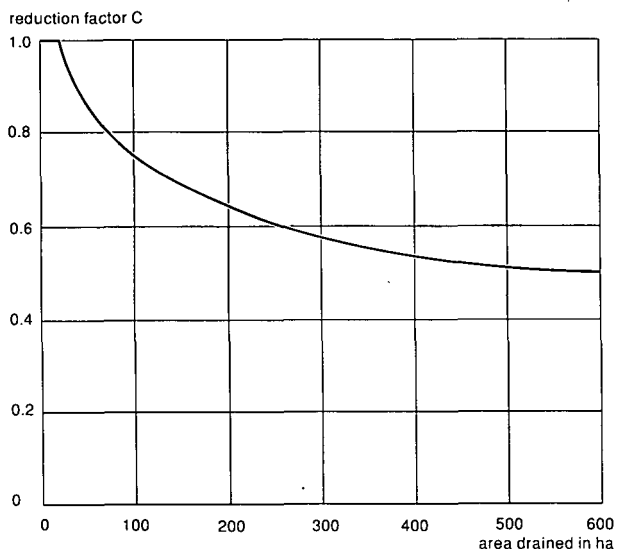

Figure 21.37 Area reduction factor for collector drains (USBR 1978)

In résumé, it is clear that, for full-flowing field drains, we can use either the non-uniform flow (Equation 21.22) with a reduction factor of $R = 0.60$, or the uniform flow equation (Equation 21.4), without a reduction factor, and achieve the same safety margin.

It is recommended that Manning's Equation (Equation 21.4) be used (uniform flow) to avoid mistakes with different constants in the formulas and to simplify the iterative method of solving Manning's Equation (Section 21.6.1); only one equation has to be solved for both field drains and collectors.

No safety factor is necessary for field drains. The use of Manning's Equation for a full-flowing pipe automatically incorporates a safety factor of $R = 0.58$ for a drain pipe that is actually not flowing full over its entire length.

For collectors, the design discharge should be divided by a factor $R = 0.50$ to 0.75 , and Manning's Equation for full-flowing pipes should be used. It is assumed that the collector pipes are not perforated. The effect of inflow through perforations on the roughness coefficient was found to be negligible (Wesseling and Homma 1967). If collectors are perforated, the expected flow in the design discharge at the upstream end of the section should be included.

21.6.6 Maximum Area Drained, Maximum Pipe Length

In determining the layout, it is handy to know what the maximum drainable area is, and the maximum length of a field drain for a particular diameter. For single diameter drains, a simple table can be produced by hand or in a spreadsheet program for a rapid check of the area that can be drained. This should be kept handy when the drain spacings are being determined (Chapter 8, Section 8.2.4, drain radius r_0). At this stage, the following are known, or should have been decided:

- Drainage coefficient $q = 1 \text{ mm/d}$;
- Drain slope $s = 0.001$;
- Drain spacing $L = 65 \text{ m}$;
- Manning's roughness coefficient n , calculated using Equation 21.25 or a pre-determined value.

The question then remains whether to use Equation 21.4 for uniform flow, or to use Equation 21.22 with a safety factor. Both methods are shown in Table 21.9. An extra column shows n as calculated. The pipe diameters in Table 21.9 are assumed to be the commercially available pipe diameters.

Note that the key parameters are shown in the heading of the table. The calculations with both the non-uniform flow equation and the uniform flow equation are shown. For ease of comparison, the R -value is taken as $1/\sqrt{3} = 0.58$.

21.6.7 Design Procedure for Field Drains

Figure 21.38 shows an example of a possible field layout. Note that, because of local features, not all field drains have exactly the same length. For single diameter field

Table 21.9 Calculation of the maximum drain length and drainable area for a field drain with a single diameter pipe for non-uniform (Eq. 21.22) and uniform (Eq. 41.4) flow

Non-uniform flow					
Drainage coefficient: 1 mm/d Drain spacing: 65 m			Safety factor R = 0.58 Drain slope: 0.0010		
Commercial pipe diameters		Manning's roughness (Eq. 21.25)	Q _{max} (l/s)	Max. drained area (ha)	Max. length field drain (m)
Nominal (mm)	Inside (mm)				
50	45	0.016	0.16	1.38	212
80	72	0.016	0.54	4.69	721
100	98	0.017	1.20	10.37	1595
150	151	0.018	3.61	31.20	4800

Uniform flow					
Drainage coefficient = 1 mm/d Drain spacing: 65 m			Safety factor R = 1.00 Drain slope: 0.0010		
Commercial pipe diameters		Manning's roughness (Eq. 21.25)	Q _{max} (l/s)	Max. drained area (ha)	Max. length field drain (m)
Nominal (mm)	Inside (mm)				
50	45	0.016	0.16	1.37	211
80	72	0.016	0.54	4.67	718
100	98	0.017	1.20	10.33	1589
150	151	0.018	3.60	31.08	4781

drains, however, this difference can be ignored as long as the maximum length that can be found in Table 21.9 is not exceeded.

Example 21.1 Field Drain with Single Diameter Pipe

Data:

- $q = 1 \text{ mm/d} = 0.001 \text{ m/d}$;
- Drain spacing 65 m;
- The uniform flow equation that incorporates a safety margin of $R = 0.58$ will be used;
- Drain length 150 m.

Which diameter of drain is to be used?

Solution:

From Table 21.9, it can be seen that a drain pipe with a nominal diameter of 50 mm suffices.

Example 21.2 Field Drain with Multiple Diameter Pipes

Data:

- $q = 7 \text{ mm/d} = 0.007 \text{ m/d}$;

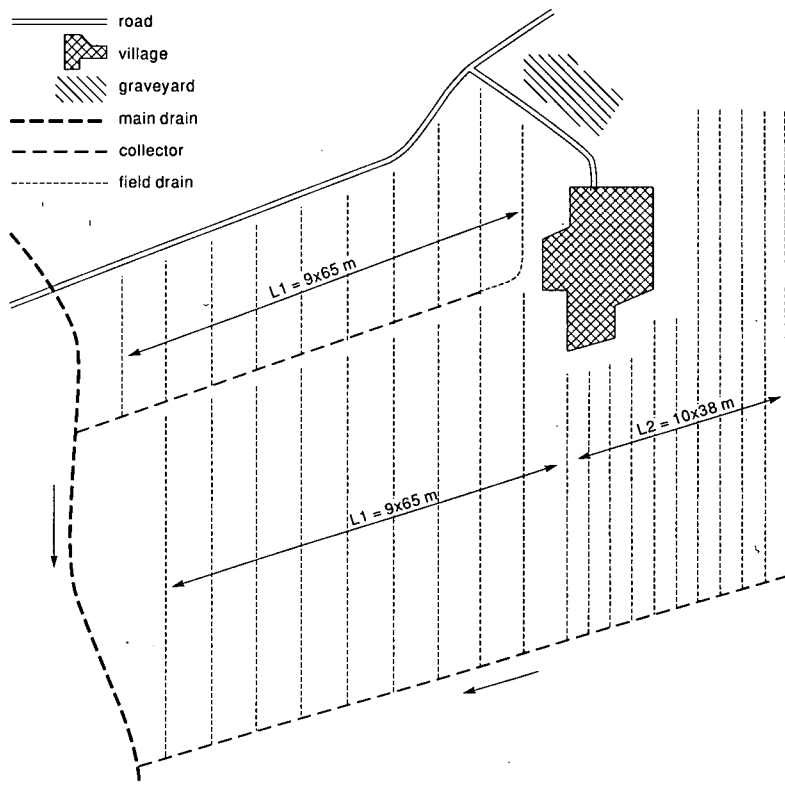

Figure 21.38 Example 21.1: Layout of drainage system

- Drain spacing $L_2 = 38 \text{ m}$ (Figure 21.38);
- The uniform flow equation that incorporates a safety margin of $R = 0.58$ will be used;
- Drain length $L = 180 \text{ m}$.

Which diameter of drain is to be used?

Solution:

Table 21.10 shows the maximum drain length and appropriate diameters. If we take the lengths of the field drain sections according to this table, we obtain:

- 0 - 52 m: nominal diameter of 50 mm;
- 52 - 175 m: nominal diameter of 80 mm;
- 175 - 388 m: nominal diameter of 100 mm;
- 388 - 1168 m: nominal diameter of 150 mm.

For the pipe diameters in Table 21.10, it is assumed that the full length will be one particular diameter. Cavelaars (1979) showed that this underestimates the friction losses, because we have smaller pipe diameters upstream. To compensate, he recommends that, for the maximum length, 0.85 of the calculated length be taken

Table 21.10 Maximum drain length and drainable area for multiple diameter pipe drains for uniform flow (Eq. 21.4)

Drainage coefficient: 7 mm/d Drain spacing: 38 m		Safety factor R = 1.00 Drain slope: 0.0010			
Commercial pipe diameters		Manning's roughness	Q _{max} (l/s)	Max. drained area (ha)	Max. length field drain (m)
Nominal (mm)	Inside (mm)				
50	45	0.016	0.16	0.20	52
80	72	0.016	0.54	0.67	175
100	98	0.017	1.20	1.48	388
150	151	0.018	3.60	4.44	1168

if a two-diameter pipe drain is used, and 0.75 for each section if there are three or more diameters. Therefore, for our field drain of 180 m, we would determine the lengths as follows:

- 50 mm nominal diameter: 0 – 44 m (85% of 52 m);
- 80 mm nominal diameter: 44 – 180 m (44 m + 85% of 175 m exceeds 180 m).

If we needed a field drain of, say, 1000 m, the following would result (more than three diameters):

- 50 mm nominal diameter: 0 – 39 m (75% of 52 m);
- 80 mm nominal diameter: 39 – 170 m (= 39 m + 75% of 175 m);
- 100 mm nominal diameter: 170 – 461 m (= 170 + 75% of 388 m);
- 150 mm nominal diameter: 461 – 1000 m (461 m + 75% of 1168 m exceeds 1000 m).

21.6.8 Design Procedure for Collector Drains

Figure 21.39 shows another possible field layout. This layout is more affected by local features such as small villages, graveyards, roads, and secondary irrigation canals. The layout has several drainage units, each with a collector discharging into an open drain. Unit B has two sub-collectors which come together in a third collector (B3).

Example 21.3 Non-Perforated Collector Drain with Multiple Diameter Pipes

Data:

- Drainage coefficient $q = 1 \text{ mm/d} = 0.001 \text{ m/d}$;
- Drain spacing $L = 65 \text{ m}$;
- The uniform flow equation will be used;
- Field drain length varies;
- Collector pipes are not perforated;
- Collector pipes will discharge into an open disposal drain.

On the basis of experience with similar projects in the area, the designer decides upon a safety factor of $R = 0.58$.

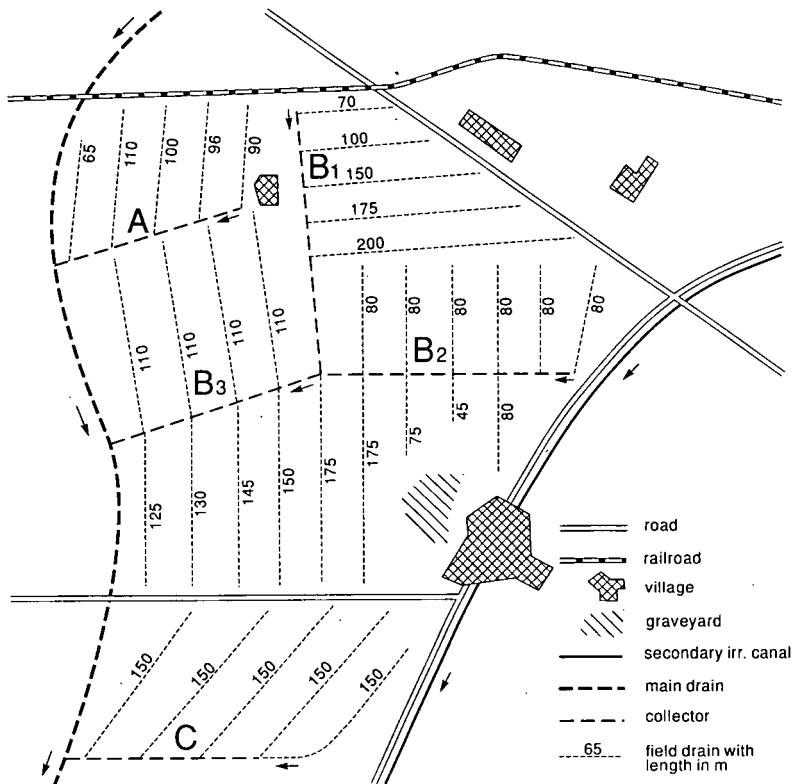

Figure 21.39 Example 21.3: Layout of drainage system

Which diameters of collector pipes are to be used?

Solution:

Because the system has variable field drain lengths and sub-collectors in Unit B, a spreadsheet is used. Discharges for each drain are determined and added as appropriate (Figure 21.39 and Table 21.11). Column (6) shows the actual diameter needed. Column (8) shows the next available commercial size, based on the sizes indicated in Table 21.9, which will actually be used. Because Manning's n is determined with Equation 21.25, the value used is shown in Column (7). It was also decided to use the area reduction factor (Figure 21.37). To accommodate easy incorporation into the spreadsheet, the curve of Figure 21.37 was built into the formula of Column (5).

Example 21.4 Non-Perforated Collector Drain with Multiple Diameter Pipes at Actual Flows

Data:

- Drainage coefficient $q = 1 \text{ mm/d} = 0.001 \text{ m/d}$;
- Drain spacing 65 m;
- System as designed in Example 21.3.

Table 21.11 Calculation of a non-perforated collector drain with multiple diameter pipes (Example 21.3)

1	2	3	4	5	6	7	8
Drainage coefficient: 1 mm/d Perforated field drains				Collector safety factor R = 0.58 Non-perforated collectors			
Lateral length	Collector length	Collector slope	Cum. area drained	Cumulative discharge collector	Required minimum diam.	Manning's roughness coefficient	Next avail. nominal diameter
(m)	(m)	(-)	(ha)	(l/s)	(mm)		(mm)
Collector A							
90	65	0.0010	0.59	0.12	40	0.0158	50
90	65	0.0010	1.17	0.23	52	0.0160	80
100	65	0.0015	1.82	0.36	57	0.0161	80
110	65	0.0015	2.54	0.51	65	0.0162	80
65	65	0.0015	2.96	0.59	69	0.0163	80
Collector B1							
70	65	0.0010	0.46	0.09	36	0.0157	50
100	65	0.0010	1.11	0.22	51	0.0160	80
150	65	0.0010	2.08	0.42	65	0.0162	80
175	65	0.0010	3.22	0.64	77	0.0165	100
200	65	0.0010	4.52	0.90	88	0.0167	100
Collector B2							
80	65	0.0020	0.52	0.10	34	0.0157	50
80	65	0.0020	1.04	0.21	44	0.0159	50
160	65	0.0020	2.08	0.42	57	0.0161	80
125	65	0.0020	2.89	0.58	65	0.0162	80
155	65	0.0020	3.90	0.78	73	0.0164	100
255	65	0.0020	5.56	1.11	83	0.0166	100
Collector B3 (B1 + B2)							
				2.01			
175	65	0.0013	1.14	2.24	120	0.0172	150
260	65	0.0013	2.83	2.57	126	0.0173	150
265	65	0.0013	4.55	2.92	133	0.0174	150
240	65	0.0013	6.11	3.23	138	0.0175	150
235	65	0.0013	7.64	3.53	143	0.0176	150
Collector C							
150	65	0.0014	0.98	0.19	46	0.0159	80
150	65	0.0014	1.95	0.39	60	0.0161	80
150	65	0.0014	2.93	0.58	70	0.0163	80
150	65	0.0014	3.90	0.78	78	0.0165	100
150	65	0.0014	4.88	0.97	85	0.0166	100

What are the flow depths in the various sections at design flow and at flow rates of 50% of the design flow?

Solution:

A table similar to Table 21.11 is compiled, except that the pipe diameters are known. Via a macro, the Synthetic Newton-Raphson Method is used to solve for the flow depth in the drain (Table 21.12).

Note the effect of selecting the next available pipe diameter; at full design discharge,

Table 21.12 Hydraulic calculation for full and 50% of the design discharge

1	2	3	4	5	6	7	8	9	10
Drainage coefficient: 1 mm/d				Collector safety factor R = 0.58					
Perforated field drains			Non-perforated collectors						
Lateral length	Collector length	Collector slope	Cum. area drained	Cum. Q collector	Nominal diameter	Inside diameter	Manning's roughness coefficient	Flow depth	Flow depth at 50% Q
(m)	(m)	(-)	(ha)	(l/s)	(mm)	(mm)		(mm)	(mm)
Collector A									
90	65	0.0010	0.59	0.07	50	45	0.0159	21	15
90	65	0.0010	1.17	0.14	80	72	0.0164	25	18
100	65	0.0015	1.82	0.21	80	72	0.0164	28	20
110	65	0.0015	2.54	0.29	80	72	0.0164	34	23
65	65	0.0015	2.96	0.34	80	72	0.0164	37	25
Collector B1									
70	65	0.0010	0.46	0.05	50	45	0.0159	18	14
100	65	0.0010	1.11	0.13	80	72	0.0164	24	18
150	65	0.0010	2.08	0.24	80	72	0.0164	34	23
175	65	0.0010	3.22	0.37	100	98	0.0168	38	27
200	65	0.0010	4.52	0.52	100	98	0.0168	45	31
Collector B2									
80	65	0.0020	0.52	0.06	50	45	0.0159	16	13
80	65	0.0020	1.04	0.12	50	45	0.0159	23	16
160	65	0.0020	2.08	0.24	80	72	0.0164	28	20
125	65	0.0020	2.89	0.33	80	72	0.0164	33	23
155	65	0.0020	3.90	0.45	100	98	0.0168	35	24
255	65	0.0020	5.56	0.64	100	98	0.0168	42	29
Collector B3 (B1 + B2)				1.17					
175	65	0.0013	1.14	1.30	150	151	0.0177	58	41
260	65	0.0013	2.83	1.49	150	151	0.0177	63	44
265	65	0.0013	4.55	1.69	150	151	0.0177	68	47
240	65	0.0013	6.11	1.87	150	151	0.0177	72	49
235	65	0.0013	7.64	2.05	150	151	0.0177	76	52
Collector C									
150	65	0.0014	0.98	0.11	80	72	0.0164	21	15
150	65	0.0014	1.95	0.23	80	72	0.0164	30	21
150	65	0.0014	2.93	0.34	80	72	0.0164	37	26
150	65	0.0014	3.90	0.45	100	98	0.0168	38	27
150	65	0.0014	4.88	0.56	100	98	0.0168	43	30

most pipes are not flowing full! At 50% of the discharge, water levels are considerably below the maximum possible depth. Although not shown here, it is rather easy to expand Table 21.12 with flow velocities and calculate the actual friction losses. These can then be used to determine the hydraulic gradients, and when the downstream pipe elevations with respect to a datum are known, it can be checked whether there is a danger of backwater.

21.7 Drain Line Performance

When we are implementing a pipe drainage system, we are concerned with various aspects of achieving proper system performance (i.e. how well the drainage water flows into the pipe drains and is subsequently evacuated through the pipe system). The flow

through the pipe system is achieved by an appropriate hydraulic design, as was discussed in the previous section. Even with a proper hydraulic design, however, the performance can still be hampered by a high entrance resistance or by an obstructed pipe flow as a result of pipe damage or clogging by soil sediments, chemical deposits, or roots. For both hazards, the condition of the soil in the immediate vicinity of the drain pipe is crucial.

21.7.1 Flow Conditions in the Immediate Vicinity of a Pipe Drain

Equations for subsurface water flow to pipe drains use the following assumptions to describe the flow in the immediate vicinity of the drain (Chapter 8):

- The drain functions like an ideal drain. This implies that the flow boundary is an equipotential line, coinciding with the pipe circumference, or with the wall of the drain trench;
- The parameter K , describing the hydraulic conductivity of the soil profile, is valid up to that boundary line. A discontinuity, caused by trench excavation and backfilling, or by the application of an envelope, is not considered.

These assumptions give a schematized flow pattern as depicted in Figure 21.40A. The actual conditions, however, are different. First of all, the pipe circumference is not the real flow boundary, and it is not an equipotential line because it consists of an impermeable wall with a pattern of relatively small inflow openings. Figure 21.40B represents the flow pattern towards two longitudinal perforations in a pipe drain. The contraction of the streamlines causes a considerable head loss, and an additional resistance, called contraction resistance. The contraction resistance is part of the entrance resistance, which is defined as the total resistance along the flow path through the drain trench and the envelope (if present) into the drain (Stage 3 of Figure 21.45).

Secondly, the hydraulic conductivity in the vicinity of the drain will often deviate from the hydraulic conductivity of the surrounding undisturbed soil, and may vary over short distances. If the K -value near the drain is higher than the K -value of the undisturbed soil, the corresponding reduction in flow resistance may compensate for

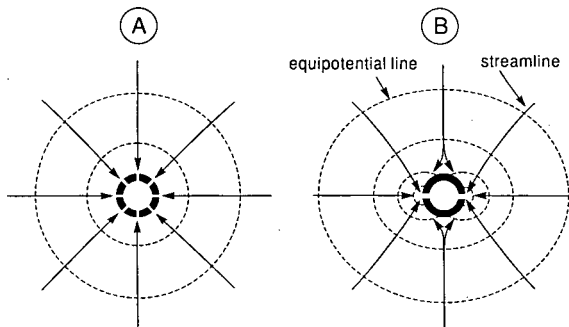

Figure 21.40 Flow pattern in the vicinity of a drain pipe
 A: Ideal drain with the pipe circumference as an equipotential
 B: Perforated pipe with contraction of streamlines

the high contraction resistance. This would justify the assumptions of an ideal drain and a homogeneous flow medium. If, for some reason, we cannot count on an increase in the hydraulic conductivity of the drain trench, an envelope would have the same effect. In some drainage equations, the flow resistance in the back-filled trench is completely ignored, and the trench is considered to be a drainage ditch.

At a certain distance from the drain, in the undisturbed soil, we can assume a medium of homogeneous hydraulic conductivity to be present, in which the equipotential lines are approximate circles. The flow pattern in the zone between such a circular equipotential line and the drain pipe is rather complex. We shall discuss the flow conditions in this zone for three different cases: an ideal drain in a homogeneous soil, a real drain pipe with inflow openings in a homogeneous soil, and a real drain pipe in a heterogeneous soil.

Ideal Drain in a Homogeneous Soil

The flow pattern in the vicinity of an ideal drain in a homogeneous soil (Figure 21.40A) results in a head loss due to radial flow, which can be described by the following basic equation

$$h_r = q w_r \quad (21.26)$$

where

h_r = head loss due to radial flow (m)

q = the drainage coefficient (m/d)

w_r = radial resistance (d)

The radial resistance of a full-flowing ideal drain is

$$w_r = \frac{L}{2\pi K_r} \ln \frac{R}{r_o} \quad (21.27)$$

where

L = drain spacing (m)

K_r = radial hydraulic conductivity (m/d)

R = radius of influence of radial flow (m)

r_o = drain radius (m)

Note that in the standard situation, with half-full drains, w_r is twice as large. Further, writing $D_r = \pi R$, we find the Ernst equation for radial flow (Chapter 8: Equation 8.42) for a homogeneous profile (i.e. geometry factor $a = 1$).

For a non-submerged drain, the factor 2π in Equation 21.27 should be reduced according to the wet perimeter, to reach π for half-full drains. The streamlines will be more contracted, the flow velocity will be higher, and h_r and w_r will be higher as well. To take this partly-filled drain pipe into account, we could write

$$w_r = \frac{L}{K_r u} \ln \frac{R}{r_o} \quad (21.28)$$

where

u = wet perimeter of the pipe drain (m)

Non-Ideal Drain in a Homogeneous Soil

The contraction of the streamlines towards a non-ideal drain results in an additional head loss corresponding with the contraction resistance. It is expressed by

$$h_c = q w_c \quad (21.29)$$

where

h_c = contraction head (m)

w_c = contraction resistance (d)

The contraction resistance of a drain pipe is characterized by the contraction constant, a_c , which appears in the expression of the contraction resistance

$$w_c = \frac{L}{K_r} a_c \quad (21.30)$$

where

a_c = contraction constant (-)

which is valid for full-flowing drain pipes. In analogy with Equation 21.28, we can introduce an adjustment for non-full pipes

$$w_c = \frac{L}{K_r} \frac{2\pi r_o}{u} a_c \quad (21.31)$$

The value of a_c is determined by the characteristics of the pipe perforations and their arrangement in the wall of the drain pipe. Analytical solutions have been given by various authors: Kirkham (1951); Englund (1953); Cavelaars (1967); Widmoser (1966); Dierickx (1980). Its value ranges approximately from 0.3 to 1.5. The lower values apply to corrugated perforated plastic pipes. High values apply to concrete and clay pipe drains, where the water enters through the joints.

For non-ideal drains in a homogeneous soil, the total entrance head loss, h_e , thus consists of a radial component and a contraction component, which are additive: $h_e = h_r + h_c$. The total entrance resistance, w_e , similarly follows from adding w_r and w_c .

Example 21.5

Assume a pipe drainage system with drain spacing $L = 16$ m in a homogeneous soil with hydraulic conductivity $K = K_r = 0.2$ m/d. The drain functions like an ideal drain. The depth of the impermeable layer $D = 2$ m below drain level, the drain radius $r_o = 0.05$ m, and the discharge coefficient $q = 0.007$ m/d.

We can use the Hooghoudt Equation (Chapter 8, Section 8.2.1) to determine the elevation of the watertable midway between the drains. That is the total head available for flow towards the drain. We find $h = 0.74$ m. Now we estimate the head loss due to radial flow in the vicinity of the drain, say in the zone extending to 0.20 m from the drain centre. If we use Equation 21.28, we find that a value for the wet perimeter, u , is missing. To determine the value of u , we look at Figure 21.41, which shows a flow net drawn to determine the curved shape of the watertable between the drains. The left-hand side of the figure represents the situation with an ideal drain (no entrance resistance) and the right-hand side a non-ideal drain with a contraction constant of

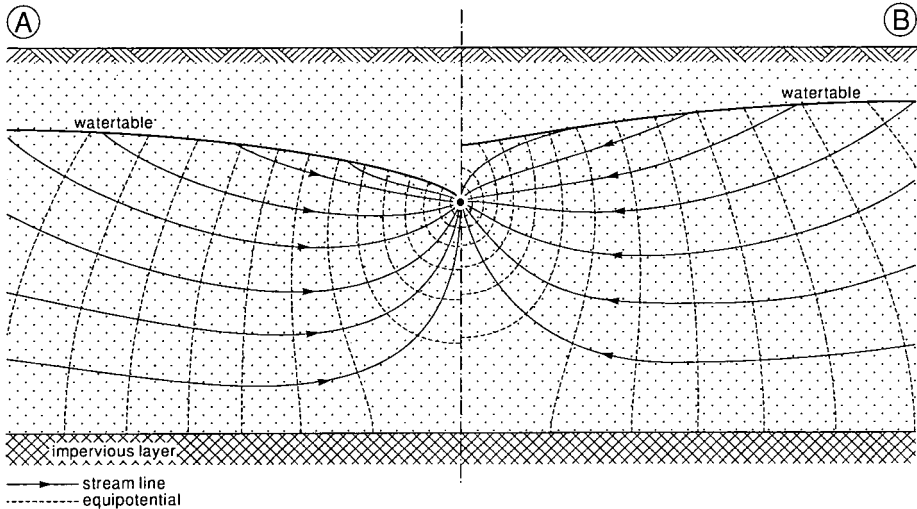

Figure 21.41 Example 21.5: Flow net showing streamlines and equipotential lines
 A: Ideal drain
 B: Non-ideal drain with $a_c = 0.75$

0.75. The drain circumference is taken as the zero equipotential, and the other boundaries of the flow region are the watertable, the impervious layer, and the vertical plane through the drain line. The flow net was drawn with the trial-and-error procedure explained in Chapter 7. The increment between two equipotentials is determined by the ratio of h to the number of equipotential lines: $\Delta h = 0.74 / 14 = 0.05$ m. Hence, the value of the hydraulic head is known at 14 equipotential lines, and the ultimate flow net determines the position of an equal number of intersections with the watertable.

With this flow net, we estimate the wet perimeter of the drain, $u = 1.5\pi r_0$ m, so that the radial resistance per metre drain length equals (Equation 21.28)

$$w_r = \frac{16}{0.2} \frac{0.05}{1.5 \times \pi \times 0.05} \ln \frac{0.20}{0.05} = 23.5 \text{ d}$$

and the corresponding head loss (Equation 21.26)

$$h_r = 0.007 \times 23.5 = 0.16 \text{ m}$$

Let us consider the same drainage system, but now having a non-ideal drain with an contraction constant $a_c = 0.75$ (Figure 21.41B). Because of the contraction resistance, the drain is submerged, so that $u = 2\pi r_0$. According to Equation 21.30, the contraction resistance equals

$$w_c = \frac{16}{0.2} 0.75 = 60.0 \text{ d}$$

and the corresponding contraction head (Equation 21.29)

$$h_c = 0.007 \times 60.0 = 0.42 \text{ m}$$

The radial resistance and the corresponding head loss are now also calculated for a full-circular flow pattern (Equation 21.27)

$$w_r = \frac{16}{2 \times \pi \times 0.2} \ln \frac{0.20}{0.05} = 17.7 \text{ d}$$

and the radial head loss (Equation 21.26)

$$h_r = 0.007 \times 17.7 = 0.12 \text{ m}$$

The total entrance resistance, w_e , is thus $60.0 + 17.7 \approx 78$ days, and the corresponding head loss, h_e , equals $h_r + h_c = 0.12 + 0.42 = 0.54$ m.

Note that the entrance resistance is dominated by the contraction resistance of the drain.

Non-Ideal Drain in a Heterogeneous Soil

The hydraulic conductivity in the vicinity of the drain may increase through cracks, or it may decrease through smearing and clogging, depending on the installation method and the wetness of the soil during installation. In any case, the hydraulic conductivity of the back-filled soil will vary considerably over short distances. As a result, the flow conditions are heterogeneous and are difficult to predict. A theoretical formulation of the flow pattern is hampered by the fact that equipotential lines do not show a regular pattern.

An increase in the hydraulic conductivity in the vicinity of the drain can reduce the radial head loss, but does not have to counterbalance the contraction head completely. In such cases, a drain envelope is indispensable.

21.7.2 Soil Physical Conditions in the Immediate Vicinity of a Pipe Drain

Pipe drain installation involves a drastic interference in the soil conditions adjacent to the pipe, with far-reaching consequences for the functioning of the drainage system.

Basic Mechanisms

Immediately after pipe installation, we find:

- For trencher-installed pipes:
 - A highly disturbed soil in the trench backfill;
 - Possible compaction, smearing, or disruption of macropore systems in the seemingly undisturbed soil profile along the wall of the trench;
 - Caving-in of the trench under certain conditions.
- For trenchless pipe installation:
 - If the pipes were installed above the critical depth (Section 21.4.2), the soil has been lifted up so that the pipe environment consists of loosened soil;
 - If the pipes were installed below the critical depth, the surrounding soil has been compressed.

The situation, however, is not static; further physical processes will take place, some of them beneficial, others harmful.

In the first place, the loose soil will settle in the course of time, implying a decrease in pore volume, which would normally lead to a decrease in permeability. On the other hand, the soil may increase in permeability during the stabilization process through the development of macropore systems.

In the second place, the water flow to the drain may dislocate soil particles. At

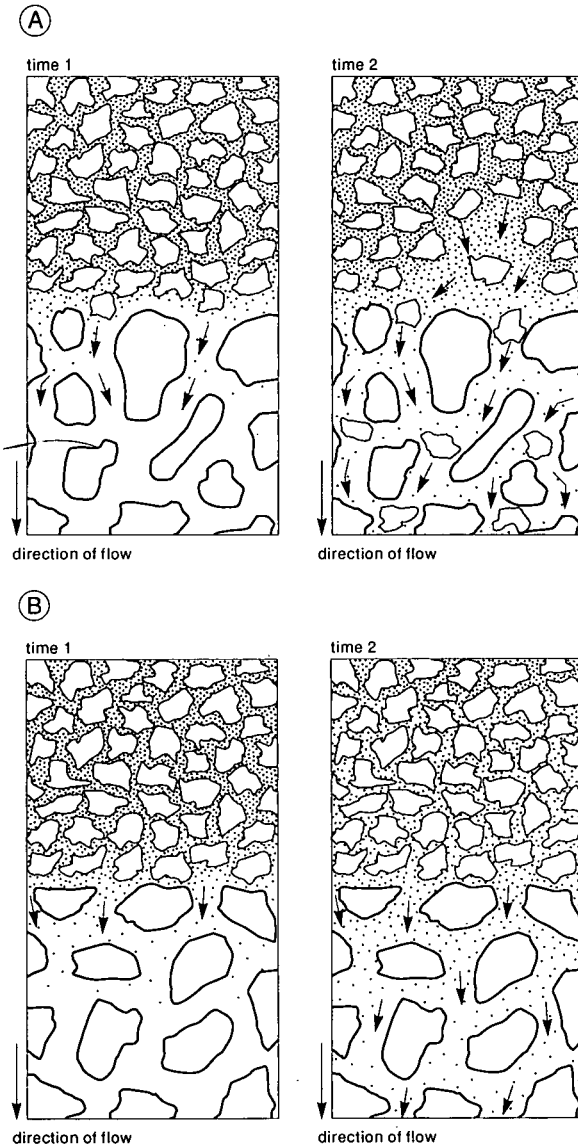

Figure 21.42 Soil particle movement in the vicinity of a pipe drain
A: Movement of particles of all sizes (contact erosion)
B: Movement of fine soil particles only (natural filter build-up)

the interface of two media (e.g. soil/envelope or soil/inlet-opening of a drain pipe), two mechanisms of particle movement are possible (Stuyt 1992):

- Contact erosion: Particles of all sizes are washed out locally because of soil failure or disintegration, resulting in a modification of the soil skeleton (Figure 21.42A);
- Natural filter build-up: Only the fine particles are washed out, leaving the large particles behind and thus leaving the soil skeleton intact. Eventually the skeleton may be weakened, which may lead to contact erosion in a later stage (Figure 21.42B).

The movement of soil particles is the result of two opposing factors:

- The hydraulic gradient of the water flow, providing the drag force of the water;
- The (structural) stability of the soil, representing the ability of the soil to resist structural disintegration.

The stability of a soil at a given place and time depends on many factors, some of which are:

- Soil texture: Problem soils are especially those high in silt and fine sand and low in clay content. A soil having a cumulative particle-size distribution that lies mainly in the shaded area of Figure 21.43 is likely to be a problem soil. Such soils have insufficient clay particles to be cohesive and thus to maintain stable structural elements; on the other hand, the particles are not big enough to form a stable skeleton over the inlet openings of the pipe or over the voids of the envelope material. Moreover, in a structureless condition, the soil will have a very low permeability, leading to high inflow resistance;
- Working of the soil: Excavating and backfilling the trenches reduces stability;

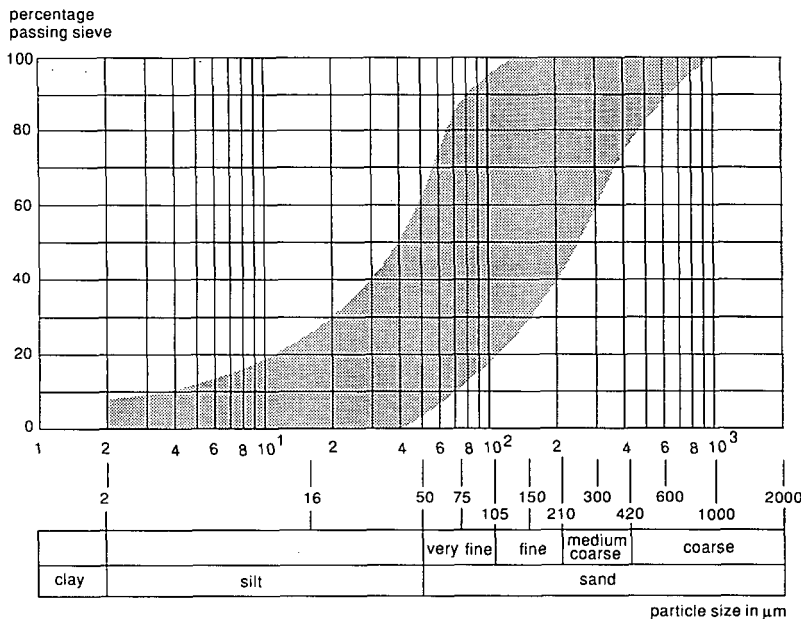

Figure 21.43 Particle size distribution envelope of problem soils for subsurface drainage

- Moisture conditions: Working the soil at a high water content has a strong negative effect on stability;
- Sodidity: A high content of exchangeable sodium (high ESP) in combination with a low salt content (low EC_e) reduces soil stability (i.e. the soil has a tendency to disperse; Chapter 15);
- Time: If, after a reduction in stability, the soil is allowed to dry, its stability will be regained in the course of time.

Effects on Drainage Functioning

Dislocated soil particles may:

- Settle elsewhere in the vicinity of the pipe, either in the soil mass or inside the envelope material; the result is a redistribution of soil particles. In the worst case, all structural elements disintegrate and the soil will gain a structureless condition without macropores. When only textural pores (between the single soil grains) remain, the hydraulic conductivity will be very low and a high entrance resistance will result. Large pores of the envelope material may become clogged with soil particles. In practice, the resulting soil conditions are likely to be quite heterogeneous, as found by Stuyt (1992): structureless conditions throughout most of the soil volume, interspersed with continuous macropore systems leading to the inlet openings of the pipe, with the macropore systems conveying the greater part of the drainage flow;
- Wash into the pipe. With low soil stability and large flow gradients, a high rate of soil movement into the pipe may occur. The situation may become dramatic if large quantities of water can move directly through the yet unstable trench backfill from the land surface into the pipe. This phenomenon is often referred to as piping (Section 21.4.4). Once inside the pipe, the coarser particles will soon settle, whereas the finest particles (clay) will remain suspended for some time, so that much of them may be discharged out of the pipe system. The settled particles are unlikely to be removed by later drain discharge and will contribute to the build-up of sediment in the pipe.

Depending on texture, the trench backfill will irreversibly regain stability if it dries out. The rate of sedimentation will decrease accordingly. This is in line with the often-reported phenomena of primary and secondary sedimentation:

- Primary sedimentation occurs shortly after installation, when the trench backfill is still unstable and comparatively large quantities of soil may move into the drain;
- Secondary sedimentation is a long-term process with a comparatively low rate, occurring after the soil around the drain has settled.

The phenomena of primary and secondary sedimentation are reflected in the deposition in the pipe, which may be observed if the pipe is excavated for examination some years after installation. Typically, a layer of sediment can be found consisting of a bottom layer, containing a mix of particles corresponding with the texture of the surrounding soil and on top, a great number of extremely thin clay/silt layers, each representing a discharge period in which fine particles have been washed into the pipe.

21.7.3 Chemical and Biochemical Deposits

Even without any movement of soil particles, clogging of the pipe, the inflow openings, and/or of the surrounding soil and envelope, may occur through (bio)chemical deposits. The general mechanism of (bio)chemical deposition is that soluble chemicals are carried with the groundwater to the drains, where insoluble combinations are formed under the influence of oxygen, and possibly under the influence of bacterial activity.

The formation of iron ochre is most widely known. Soluble Fe^{2+} occurs in groundwater under conditions of low redox potential (reduced conditions) and low pH. When carried to a drain, it meets conditions favourable for the formation of Fe^{3+} , which is insoluble and may precipitate in different combinations (oxides and hydroxides) under the influence of bacterial activity. Ochre formation is a temporary phenomenon if drains are installed in a hitherto reduced soil layer. As a result of the drainage, the soil will oxidize, and dissolved Fe^{2+} will oxidize and become immobilized through precipitation. A permanent ochre problem is constituted if the drain is drawing seepage water from an Fe-rich aquifer, where reduced conditions will persist so that the supply of dissolved Fe^{2+} continues.

Other, less systematically investigated chemical deposits are:

- Sulphur, sometimes found in drains in organic soils;
- Gypsum (CaSO_4), which has been observed in excavated drain pipes in arid regions;
- The deposition of lime (CaCO_3), commonly referred to as 'encrustation', is a much-feared hazard for tubewells (Chapter 22). To the author's knowledge, however, it has not been documented for horizontal pipe drains.

21.7.4 Root Growth

Roots of perennial vegetation (trees and shrubs) may grow into a drain pipe. They enter the pipe through the inlet openings, and cases are known in which they subsequently fill the entire drain pipe over a considerable length and thus seriously obstruct water flow. There is little, if any, systematic and quantitative data available (in terms of tree or plant species; depth at which root penetration may occur). Scattered available information includes:

- In The Netherlands, clogging by roots was found in pipes at depths of 1.0 to 1.2 m under belts of bushes bordering sports fields and under shelter belts around orchards. Especially troublesome was *Populus canadensis*, whereas the fruit trees themselves (apples, pears) did not cause problems. Also reported is the growth of rape-seed roots into drain pipes (depth around 1.0 to 1.2 m).
- In Peru, sugarcane roots were found to grow into drain pipes at a depth of 1.50 m, whereas pipes at 1.75 m remained free of roots;
- In Egypt, roots of Eucalyptus trees were found to block collector drains completely at places where the collectors crossed lines of trees at a depth of about 2.50 m.

Root growth of comparatively short-lived plants is not so disastrous, because they will die before the drain has become seriously obstructed.

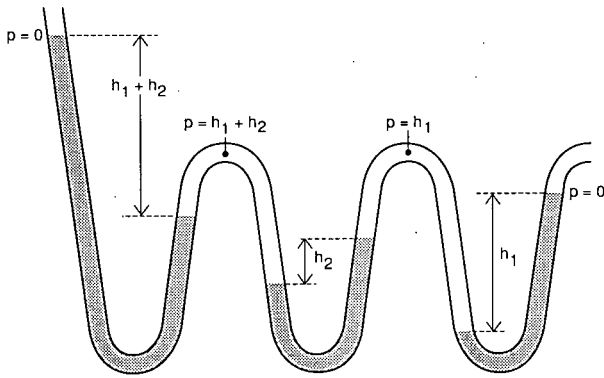

Figure 21.44 Buildup of overpressure in a drain due to air entrapment

To prevent the entry of roots, unperforated pipe should be used wherever strips of trees or bushes are to be crossed.

21.7.5 Air Entrapment

If a drain has not been installed in a straight line at a constant slope, but instead has some upward curves, air may be entrapped in these curves. If there is an overpressure at the upstream side, the air in the curves will initially be compressed. A considerable overpressure is necessary to push the water 'over the hump'. If there are more curves, their effects will accumulate into high overpressures upstream (Figure 21.44).

21.8 Pipe Drainage Testing

This section provides guidelines on how to test a subsurface drainage system in its function of controlling the watertable. The applications can be grouped into two categories:

- 1) In preconceived field experiments with certain specific objectives, such as:
 - To test the suitability of envelope materials under field conditions;
 - To test the effect of alternative drainage methods (e.g. mole drainage, trenchless pipe installation);
 - To verify the validity of design criteria.
- 2) To test a drainage system after installation. The reasons for undertaking such a test may be:
 - To check whether the actual functioning of the drainage system is in accordance with the design and, if not, to detect the bottlenecks. This is what is often called monitoring of the drainage system. Such monitoring may yield clues for the adaptation of design criteria, material specifications, or installation methods;
 - To find the cause of an unsatisfactory performance of a drainage system. There are a great variety of possible causes of failure, such as:
 - Drain spacing too wide;

- Drain depth too shallow;
- Unsuitable envelope materials;
- Blocking of field drains or collector by soil sediments, chemical deposits, and damaged or dislocated pipes;
- Pipe diameter of field drains or collector insufficient;
- Large amount of seepage to be dealt with (more than had been assumed in the design);
- Perched water tables due to layers of low permeability at shallow depth (e.g. a plough pan);
- Pipe installation under wet conditions;
- Trenchless pipe installation resulting in compaction of soil around the pipe (installation technique not sufficiently adapted to soil conditions).

It is not uncommon that, in a given case, more than one of these causes seem likely. What is needed is a method to indicate the exact cause.

21.8.1 Principles of Testing

Let us consider the flow path of water on its way from the soil surface through the soil profile and the pipe system till it discharges into the open drain. We divide this water flow into four stages (Figure 21.45A):

- Stage 1: Vertical flow which may, in principle, comprise both unsaturated and saturated flow;
- Stage 2: Saturated flow through the undisturbed soil profile to the drain trench;
- Stage 3: Flow through the disturbed soil of the drain trench and, if applied, through the envelope into the pipe;
- Stage 4: Flow through the pipe system (field drain and collector pipe).

Note: The division into stages follows the same principle that underlies the Ernst

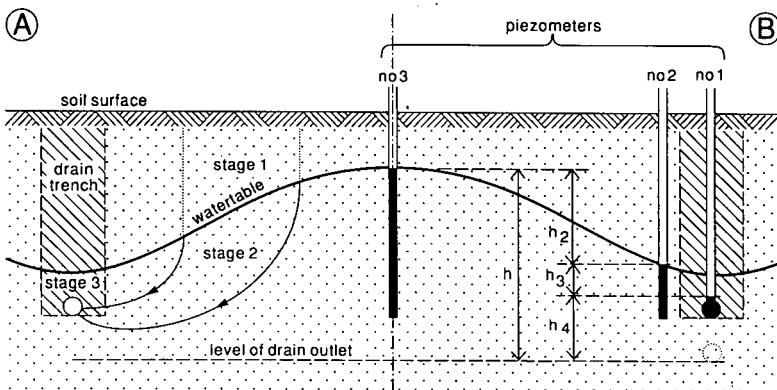

Figure 21.45 Principles of drainage testing

- A: Four stages of water flow towards and inside the drain
 B: Head losses in the four stages

Equation (Chapter 8): In view of our specific purpose, however, the division between Stages 2 and 3 deviates from the division between the horizontal and radial flow components as defined by Ernst.

Hydraulic heads are measured by means of piezometers at the transitions between these stages. Thus the head loss in each stage can be determined (Figure 21.45B). This, in combination with the drain discharge, yields the flow resistance in each stage. Each stage can be subdivided into sub-stages if need be; the head loss in each sub-stage can, for example, be determined by installing additional piezometers. Such a subdivision is often useful for:

Stage 1: (vertical flow): If there is a considerable head loss due to a high resistance to vertical flow, the layer that is responsible for the malfunctioning of the drainage system can be found (Cases E, F, and G in Section 21.8.6);

Stage 4: (flow in the pipe system): In a composite drainage system, the field drains and collectors can be considered separately. Further, the collector can be divided into sections between the manholes (Figure 21.48 in Section 21.8.2).

Measurements according to the principle outlined will yield a good picture of the flow pattern, indicating the distribution of the head losses over the total path the water has to follow. There are two main categories of application:

- To study the flow in a specific stage: for example, the head loss in Stage 3 (entrance resistance) in relation to the envelope material applied;
- As the first step in the diagnosis of a failing drainage system. This first step is to localize the excessive flow resistance. The next step would then be to find out the cause of the failure.

21.8.2 Field Measurements

General

Field measurements can be divided into two categories: the measurement of the drain discharge and the measurement of the watertable and the hydraulic head. For both categories, there are sophisticated recording devices. The methods presented in this section are limited to comparatively simple manual techniques.

Drain Discharges

Pipe discharges can very conveniently be measured with a calibrated vessel and a stopwatch; even with a normal watch, quite satisfactory accuracies can be achieved.

Hydraulic Head and Watertable

We are mostly interested in the head at a certain depth, which will be measured with piezometers. If we are interested in the depth of the watertable (e.g. midway between two parallel drains), we can use observation wells. The installation of piezometers and observation wells was described in Chapter 2. Some additional guidelines are given below.

To avoid erroneous readings, it is important that no water can flow directly from the surface into the piezometers or observation wells. Thus, if they consist of a pipe

placed in an augerhole, the top part of the augerhole should be filled up with impervious or very low-permeable material (e.g. bentonite or clay). A practical way is to apply these materials in thin layers, most suitably in the form of dry powder; each layer is then slightly wetted and tamped with a stick.

Piezometers and observation wells should be checked from time to time to verify whether they are functioning properly (i.e. whether they respond to changes in the watertable or hydraulic head). Problems may be due, for example, to the blocking of the well screen. Practical experience has shown that especially piezometers run the risk of malfunctioning. The checking is done in the following way:

- Take a reading of the water level;
- Fill the piezometer or observation well with water;
- Take readings again at certain time intervals (length of intervals depending on the rate of drop). The original water level should be re-established within about an hour (in permeable soil) to about a day (in low-permeable soil).

Piezometers to Measure (Over) Pressure in Drain Pipes

Overpressure in a drain pipe can be measured with a piezometer installed inside the drain pipe (No.1 in Figure 21.45B). Installing such a piezometer long after installation might seem an impossible task; yet, with some skill and perseverance, it can be done quite well. The installation proceeds as follows:

- The drain pipe has to be located with a probe rod (Figure 21.46A);
- An augerhole is made to the drain pipe; the augerhole is then made free of soil and mud by means of a small diameter plastic pipe (about 30 mm), which is used like a laboratory pipette;
- A circular hole is drilled into the wall of the drain pipe. The drill is kept in place by a properly shaped casing pipe (Figure 21.46B);
- The piezometer, which is a PVC-pipe with a diameter matching the diameter of the drill (about 20 mm) and provided with a rim to prevent it from penetrating too deeply, is placed in the hole;

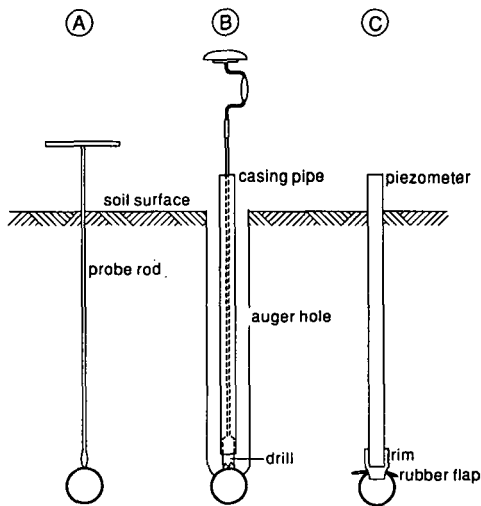

Figure 21.46 Installing a piezometer inside a drain pipe

- A rubber flap (cut from a lorry tube) is pushed down around the piezometer to the drain pipe (Figure 21.46C). The flap will seal the hole in the drain pipe if the piezometer is removed later on;
- The augerhole is filled up with soil.

Checking whether the piezometer indicates the water pressure inside the drain pipe is done in the same way as indicated above for piezometers in the soil. In this case, the original water level should be re-established instantly (the water flowing away through the drain pipe), which implies that it will be impossible to fill the piezometer, whatever quantity of water is poured into it.

In practice, it is often considered too cumbersome or too risky to install piezometers to measure overpressures, the risk being that, if anything goes wrong, an obstruction is created in the drain pipe. These piezometers are therefore often not installed, under the assumption that there is hardly any reason to expect an obstruction in the drain. This, however, leaves a certain degree of uncertainty about the interpretation of the results, as is illustrated in Case C and D in Section 21.8.6: the watertable near the drain, as indicated by Piezometer/Observation Well No. 2, is identical in Cases C and D; the real reason for the poor drain performance can only be found by installing Piezometer No. 1.

A workable compromise is as follows: Initially Piezometer No.1 is left out. Only if Piezometer No. 2 shows an abnormally high water level is an additional piezometer placed inside the drain pipe.

An alternative procedure is as follows: Excavate the upstream end of the drain and connect it to the field surface with a plastic connection piece at an angle of 90°. Any overpressure can now be observed in the extension piece. If, at high drain discharge, no overpressure develops at the upstream end, it can be concluded that the entire drain line is free from obstruction.

Note: The elevation of the drain should, of course, be taken into consideration.

Simple Observation Methods

It is often possible to obtain valuable and reliable information by comparatively simple methods; this information is particularly useful in obtaining a first impression in a reconnaissance type of survey or a simple routine inspection as was discussed in Section 21.5.2. Examples are:

- Open augerholes usually give a reliable indication of the watertable in homogeneous soils. Errors due to the inflow of water from the land surface can successfully be prevented by pressing a cylinder (e.g. a piece of PVC pipe) of sufficient diameter into the topsoil. The augerhole is then made inside the cylinder (Figure 21.47). In this way, it is also possible to detect a perched watertable caused by an impeding layer. Even in a submerged rice field, such auger holes can be made very satisfactorily;
- In collectors, overpressure can often be easily detected by observing water levels in manholes. The head loss in any section is equal to the difference in water levels in the manholes on either side (Figure 21.48). For a quick comparison of water levels in manholes, it is useful to have suitable reference levels (e.g. a marked point at the top of each manhole). These reference levels, with respect to a universal benchmark, form an element of the 'as-built' data, to be recorded after completion of the drainage works (Section 21.5.1).

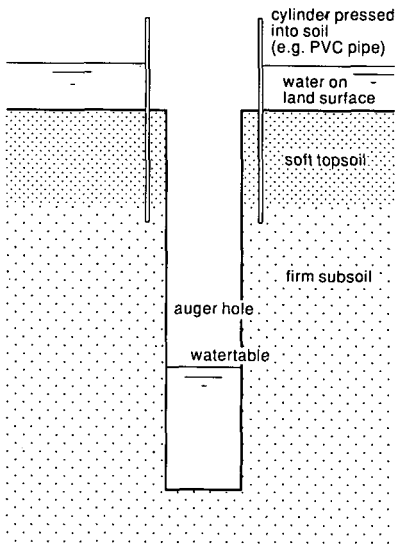

Figure 21.47 Augerhole with cylinder used to measure the groundwater levels in an inundated field

21.8.3 Lay-out of the Observation Network

The exact number and location of piezometers depends on the specific objectives of the investigation, on the degree of accuracy and representation aimed at, and on the time, manpower, and resources available; in other words, in each case it is a compromise. It is good practice to start with a given set of piezometers and to install additional ones as found necessary on the basis of the first measurements.

A basic network would consist of (see Figure 21.45B):

- A piezometer inside the drain pipe (No. 1);
- A piezometer in the undisturbed soil, just outside the drain trench (No. 2);
- A piezometer midway between the drains (No. 3).

Additional piezometers can also be installed:

- Piezometers at $1/8$ spacing from the drain;
- A piezometer inside the trench, on top of, but not inside, the drain pipe;
- Piezometers at intermediate depths, to be placed just next to the 'standard' ones.

This is of interest in case of a (suspected) large vertical gradient, as will be discussed in Section 21.8.6.

A row between two drains would thus consist of at least five piezometers. It is advisable, however, to have a row extending over at least two drain spacings, thus including three drains, of which the middle one can be taken as being representative.

In a given field test, the minimum is one row of piezometers perpendicular to the drains. For better representation, it is recommended that two or three rows be installed at different distances from the drain outlet. In view of the variability of soil conditions,

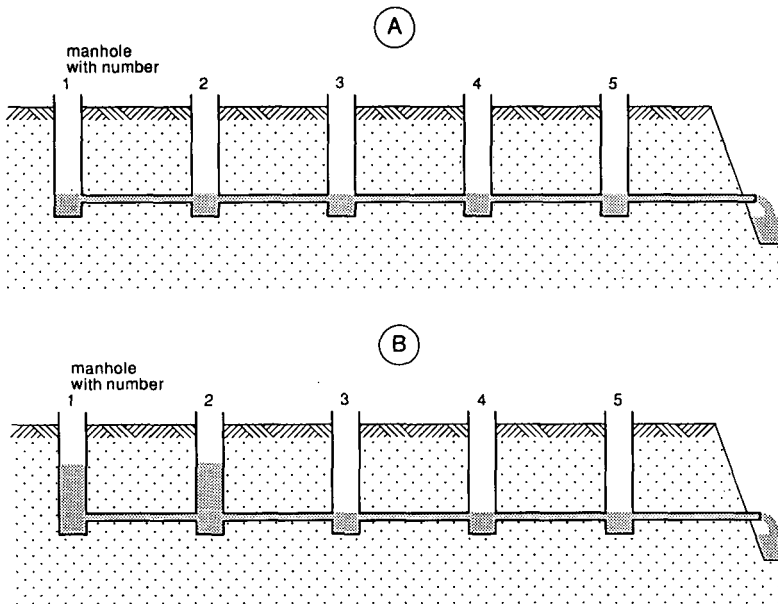

Figure 21.48 Testing the performance of a collector drain by comparing the water levels in the manholes:
 A: Collector is functioning according to the design (= no overpressure)
 B: Overpressure in Manholes 1 and 2 indicates obstruction between Manholes 2 and 3

especially in the drain trench, the readings in corresponding piezometers in different rows along the same drain may show a considerable variation.

21.8.4 Collection of Basic Data

All piezometer readings and water level observations (e.g. in open drains, in manholes, in augerholes, standing water on the soil surface) have to be processed in such a way that they can be quickly compared with each other, with the drain elevation (at the outlet and at the location of piezometers), and with the soil surface. To this end, the following basic data need to be recorded:

- A map, showing the selected field and collector drains with exact locations of piezometers. All relevant items (drains, piezometers, manholes, etc.) should be given a reference number according to a clear and consistent system;
- Elevations (with respect to a common benchmark) of:
 - Tops of piezometers (it is advisable to cut the tops of all piezometers in a field to the same absolute level in order to reduce the risk of conversion errors and to permit a quick and easy comparison of water levels);
 - Soil surface near each piezometer;
 - A reference point near each open augerhole (e.g. a wooden peg);
 - Field drain at the outlet and at the locations of piezometers;
 - Collectors: invert of outlet pipe; invert of pipe in each manhole;
 - Manholes: a well-marked reference point at the top of each manhole;

- Recipient open drain: a marked reference point (e.g. at a nearby bridge or a staff gauge) for measuring water levels;
- Inside depth of piezometer to verify whether the piezometer is near-empty. In such a case, the reading is unreliable: some water might have remained in the piezometer while the groundwater potential has dropped below the bottom of the piezometer.

21.8.5 Measurements and Observations

The following measurements and observations should be taken:

- Drain discharges from field and collector drains;
- Water levels in observation wells, piezometers and auger holes;
- Water level (if any) on the field surface near the piezometers;
- Water levels in manholes and in the open drain (especially if the drain outlets are submerged);
- Moisture conditions of field;
- Recent rainfall or irrigation.

The date and hour of the measurements have to be recorded. The measurements of piezometric levels and drain outflows should be done simultaneously as far as possible. For processing and evaluating data, it is convenient to work with pre-printed sheets. More detailed recommendations are given by Dieleman and Trafford (1976).

Frequency of Observations and Length of Observation Period

In most cases, it is not recommended to apply a fixed observation schedule (e.g. every week or once in two weeks). It is better to do frequent measurements during a few drainage events. Such a drainage event starts just before heavy rainfall or an irrigation application, and covers a period of initially rising water levels and discharges up to a maximum, followed by a recession until the original situation is approximately re-established. The drainage event may last between some three days and two weeks. During this event, it is advisable to measure at high frequency (once a day) especially when watertables (and discharges) are high during the initial phase of the watertable recession. In most cases, it is sufficient to cover two or three drainage events during the main drainage season. In case of irrigation, the planning is easy, but in rain-fed areas one has to be continuously alert to be ready whenever heavy rainfall arrives.

21.8.6 Cases of Drainage Failure

Various cases of drainage failure, their diagnoses, causes, improvement, and prevention will be discussed on the basis of a field drainage system with the following characteristics (Figure 21.49):

- Drain radius 0.05 m;
- Drain spacing 7.5 m;
- Drain depth 1 m below soil surface;
- Length of the drains 200 m;
- Slope of the drains 0.002 m/m;

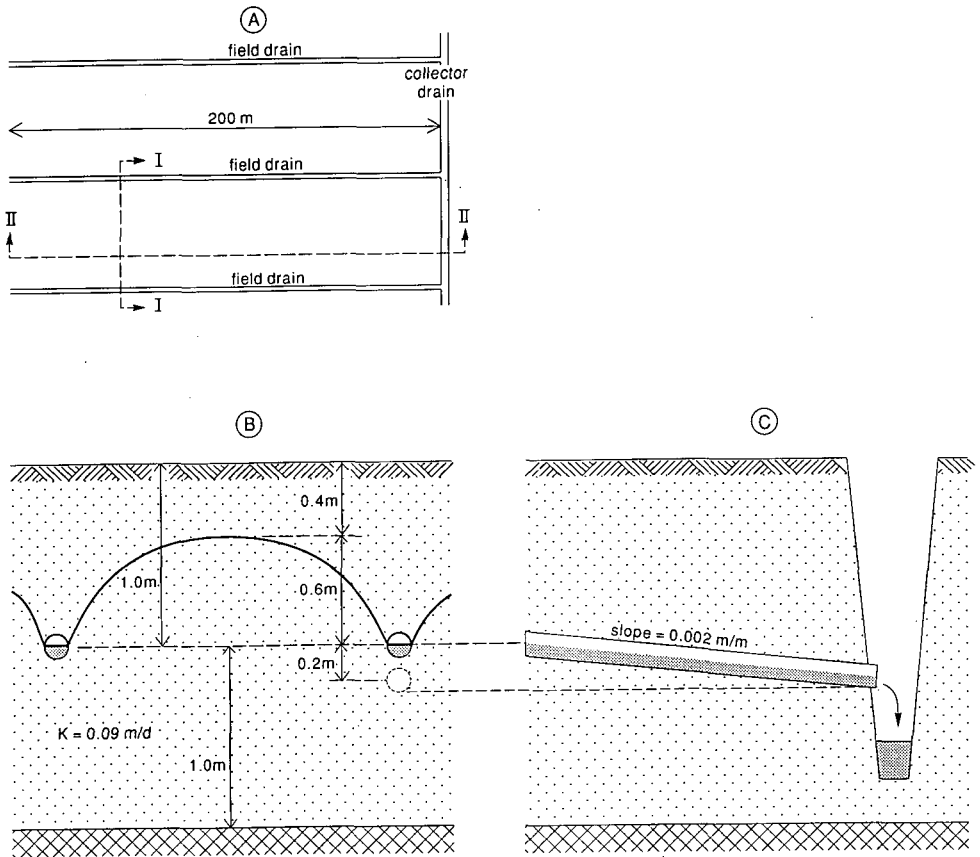

Figure 21.49 Example of subsurface drainage system used to describe malfunctioning of the system

- A: Plan
- B: Cross-section I-I
- C: Longitudinal section II-II

- Hydraulic conductivity 0.09 m/d;
- Depth to impermeable base layer 1.0 m below drain level;
- Drain discharge 0.007 m/d;
- Depth of the watertable midway between the drain 0.4 m below soil surface.

It may be observed that the drain spacing of 7.5 m is very narrow. This spacing, however, was selected in order to draw flow nets of streamlines and equipotentials at a convenient scale.

Figures 21.50A to 21.50H show flow nets for the drainage system characterized above; the corresponding drainage cases will be discussed below.

In Figure 21.50A, the system is functioning according to the design. In all the other cases, the drainage of the land is insufficient, although for different reasons. In all of the cases shown, the soil surface is waterlogged and, in a superficial field observation, the situation would look very similar. The drain discharge is the same

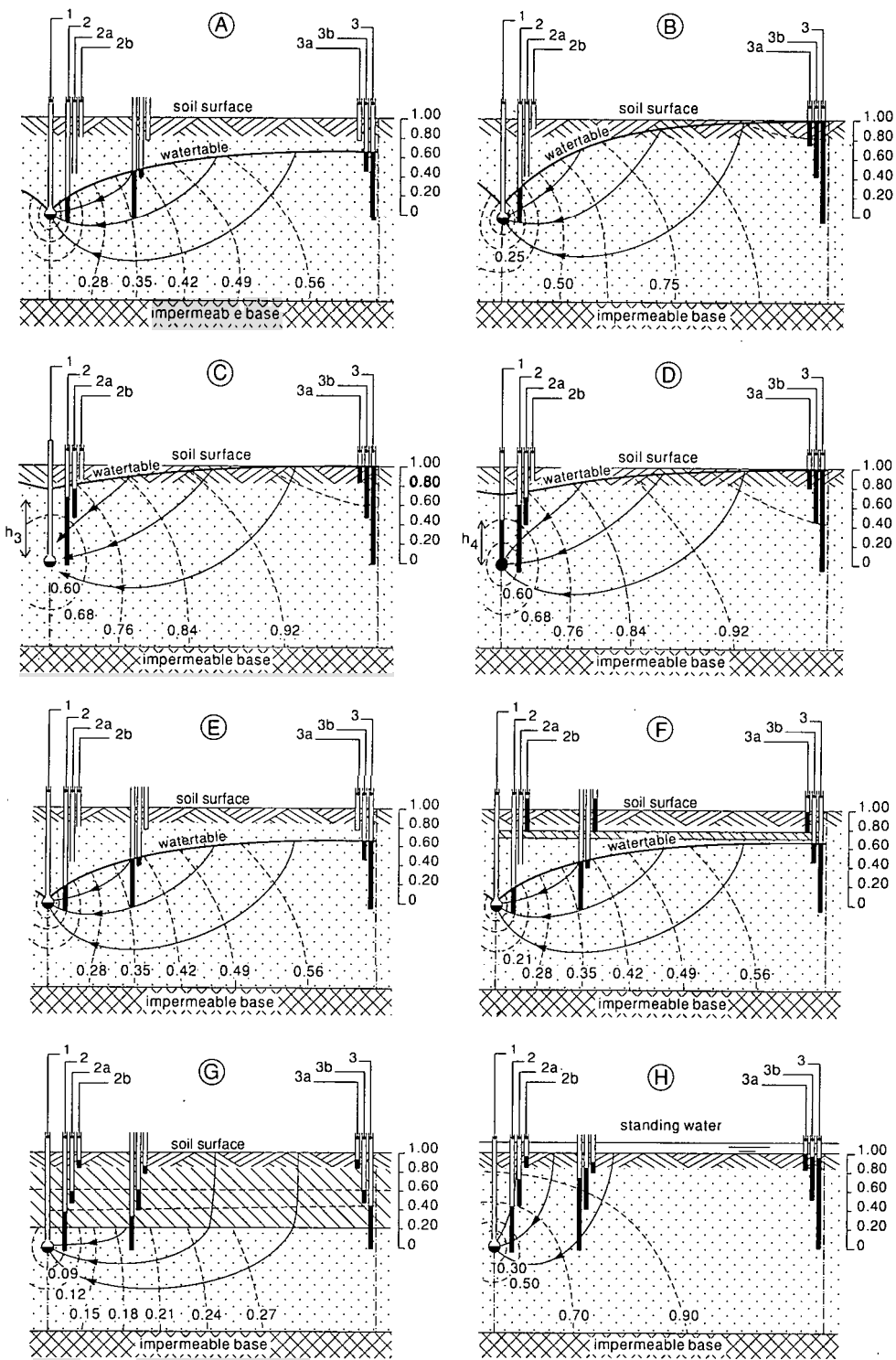

Figure 21.50 Examples of a malfunctioning subsurface drainage system (solid lines are streamlines, dotted lines are equipotential lines)

in all cases, but the flow conditions are quite different. For each case, piezometer readings are shown, from which we can deduce where too high head losses occur, and consequently too high flow resistances.

The hydraulic head is expressed in metres above drain level. In order to determine vertical components in the hydraulic gradient, multi-piezometer wells have been installed. All cases will be discussed with reference to the four flow stages defined in Section 21.8.1 (see Figure 21.45A):

Stage 1: Vertical flow, head difference between Piezometers Nos. 3a and 3 (h_1);

Stage 2: Flow through the undisturbed soil, head difference between Piezometers Nos. 3 and 2: (h_2);

Stage 3: Flow through the disturbed soil, head difference between Piezometers Nos. 2 and 1: (h_3);

Stage 4: Flow in the pipe system (h_4).

Case A – Design Situation

In Case A, the drainage system is functioning according to the design (Figure 21.50A): practically no head loss in Stage 1, no overpressure in the pipe system (Stage 4), and a head loss in Stages 2 and 3 of, respectively, 0.45 and 0.15 m.

Case B – Failure in Stage 2

An excessive head loss occurs in Stage 2 (Figure 21.50B), being 0.75 m, as against 0.45 m in Case A. The drain spacing is apparently too wide in relation to the hydraulic conductivity. In practice, it is rare that too wide spacings are the cause of serious drainage failures.

Case C – High Entrance Resistance

Failure occurs in Stage 3 (Figure 21.50C), the head loss in this stage being 0.60 m, as against 0.15 m in Case A. Apparently, there is an excessive entrance resistance. Theoretical backgrounds to this phenomenon were given in Section 21.7.1. High entrance resistance is often the result of installation under wet conditions in soils with a low clay content, a high silt content, and a low structural stability. As a result, the trench backfill consists of puddled soil with a very low hydraulic conductivity, which may even block the pores of the envelope material. Judging whether entrance resistances are excessive can be done in two ways (see also Dieleman and Trafford 1976; and Cavelaars 1966, 1967):

1) Determine the entrance resistance according to

$$w_3 = \frac{h_3}{q} = h_3 \frac{BL}{Q} \quad (21.32)$$

in which

w_3 = entrance resistance (d)

h_3 = head loss over Stage 3 (m)

q = drain discharge (m/d)

L = drain distance (m)

B = drain length (m)

Q = total drain discharge (m³/d)

If we measure Q and h_3 , and we know L and B , we find a value for w_3 , which can be compared with

$$w_3 \approx \frac{0.4}{K} L \quad (21.33)$$

in which K is the hydraulic conductivity of the surrounding undisturbed soil. If w_3 is found to be considerably higher than $0.4L/K$, the actual functioning of the drainage system does not correspond with the basic assumptions: in other words, the actual entrance resistance is too high. The entrance resistance is considered excessive if w_3 is more than $1.5L/K$;

- 2) A simpler method, by which the pipe outflow does not need to be measured, is to consider the ratio $h_3/(h_2 + h_3)$. If the assumptions of ideal drain plus homogeneous medium are valid, the value of this ratio varies between 0.15 and 0.35, but in the great majority of cases it varies between 0.2 and 0.3, depending mainly upon the drain spacing (lower values for wider spacings) and to a lesser extent also upon the depth to the impermeable layer and the elevation of the watertable.

Table 21.13 summarizes the criteria that can be applied in evaluating field measurements of the flow in Stage 3.

Case D – Overpressure in the Pipe System

Failure in Stage 4 (Figure 21.50D), the overpressure in the drain pipe being 0.45 m, compared with no overpressure in Case A. The drainage effect, the watertable, and all piezometer readings except Piezometer No. 1, are identical with Case C. Only from the reading of Piezometer No. 1 can it be seen that the cause of the problem is quite different: in the drain, there is an overpressure of 0.45 m. In Stages 2 and 3, the head losses are normal: the functioning of the drain corresponds with the assumption of ideal drain plus homogeneous medium.

Possible causes of overpressure in a pipe drain are:

- a) High water level in the open drain (pipe outlet submerged);
- b) Insufficient pipe diameter (e.g. wrong design criteria; Section 21.6);
- c) Damage to the pipeline (e.g. a broken or collapsed pipe);
- d) Air entrapment in upward curves of the pipe (Section 21.7.5);
- e) Clogging of the pipe by soil sedimentation, chemical deposits (Section 21.7.3) or plant roots (Section 21.7.4).

Table 21.13 Parameters to evaluate entrance resistance

Evaluation parameters		Entrance resistance	Drain performance
$\frac{Kw_3}{L}$	$\frac{h_3}{h_2 + h_3}$		
(-)	(-)		
< 0.4	< 0.2 - 0.3	normal	good
0.4 - 1.5	0.3 - 0.6	high	moderate to poor
> 1.5	> 0.6	excessive	very poor

Cases E, F, and G – Stagnant Water at the Soil Surface

Cases E, F, and G indicate waterlogging at the land surface, while the hydraulic head, measured at some depth in the soil profile, is well below the land surface (Figure 21.50E, F, and G). Apparently, there is a high resistance to the downward flow of water from the surface due to an impeding layer: hence, failure in Stage 1. Installing multi-piezometer wells can help to reveal the exact cause of failure, namely:

- Thickness of the impeding layer: In Cases E and F, the impeding layer is thin (0.1 to 0.2 m thick), whereas in Case G, the soil profile to a depth of some 0.8 m has a very low permeability, and is underlain by soil of good permeability. This is a situation often found in alluvial clay soils;
- Depth of impeding layers: In certain cases, the impeding layer may be right at the soil surface (Case E). This may occur in rice fields as a result of puddling, but also in any other fields as a result of structure damage due, for instance, to traffic on wet fields. Surface crust formation may occur during rainfall on saline sodic soils. The impeding layer may also be present at some depth in the soil profile (Case F). It may be natural (a hardpan) or man-made (e.g. a plough pan or a traffic pan). If the impeding layer is at the land surface, it is usually a temporary phenomenon: as a result of drying and possible tillage, the soil will regain its permeability. The deeper the impeding layer lies, the lower will be the probability that it will improve by natural processes, so subsoiling may be needed;
- Conditions below the impeding layers: Below the impeding layer, there may be an unsaturated zone, so that two watertables can be observed: a perched watertable and the actual watertable. This is the situation in Cases E and F. In Case F, there is only a very thin unsaturated zone; if the actual watertable rises a little, the entire profile will be saturated. The other possibility is that only one watertable can be observed, below which the entire profile is saturated, as in Case G.

By installing multi-piezometer wells, one can determine the exact depth and thickness of the impeding layer. The flow pattern in Cases E, F, and G corresponds with a uniform infiltration of the surface water. This may be expected, even if there is a standing water layer, under the condition that the horizontal hydraulic conductivity is many times higher than the vertical hydraulic conductivity.

Case H – The Ponded Water Case

A situation often found in rice fields is presented in Case H, where we have ponded water on the soil surface. If the hydraulic conductivity is more or less homogeneous, and there is a standing water layer, a flow pattern as shown in Figure 21.50H will develop. By far the greater part of the infiltration takes place in the immediate vicinity of the drain. This case is known as 'the ponded water case', which has been analyzed and described by Kirkham (1957).

Note: It is quite commonly assumed that puddling the topsoil in rice fields produces the effect of greatly reducing water infiltration, so that a flow pattern as in Figure 21.50E prevails. Nevertheless, field observations in rice fields with subsurface drains have shown that in a great proportion of cases the 'puddling effect' is very limited and the flow pattern is rather like that in Figure 21.50H, with correspondingly very high drain discharges.

Whether or not the flow conditions correspond to the 'ponded water case' can be found from the piezometer readings.

21.9 Mole Drainage

Heavy soils of low hydraulic conductivity (less than 0.01 m/day) often require very closely spaced drainage systems (2-4 m spacings) for satisfactory water control. With conventional pipes, the cost of such systems is usually uneconomic and hence alternative techniques are required. Surface drainage is one possibility; the other is mole drainage.

Mole drains are unlined circular soil channels which function like pipe drains. Their major advantage is their low cost, and hence they can be installed economically at very close spacings. Their disadvantage is their restricted life, but, providing benefit-cost ratios are favourable, a short life can be acceptable.

The success of a mole drainage system is dependent upon satisfactory water entry into the mole channel and upon the mole channel itself remaining stable and open for an acceptable period. Currently, mole drainage systems are most commonly used for surface water control in perched watertable situations. These systems, as applied in the United Kingdom and in New Zealand, have been comprehensively reviewed by Nicholson (1942) for the U.K., and by Hudson, et al. (1962) and Bowler (1980) for New Zealand.

Mole drains are also used in some groundwater problem areas and in paddy fields (Soong and Wei 1985). Their use as a temporary subsurface drainage system for the reclamation of saline and saline sodic soils has been successful in field experiments (Sommerfeldt and Chang 1986; Spoor et al. 1990).

21.9.1 Mole Drain Formation

Mole drains are formed with a mole plough (Figure 21.51), which comprises a cylindrical foot attached to a narrow leg, followed by a slightly larger diameter cylindrical expander. The foot and expander form the drainage channel and the leg generates a slot with associated soil fissures which extend from the surface down into the channel. The leg fissures are vertical and are formed at an angle of approximately 45° to the direction of travel (Godwin et al. 1981). Mole plough dimensions, as commonly used in the United Kingdom and New Zealand, are given in Table 21.14.

Table 21.14 Common mole plough dimensions

	Foot diameter (mm)	Expander diameter (mm)	Leg thickness (mm)	Side length of leg (mm)
United Kingdom	75	85 – 100	25	200
New Zealand	50	75	16	200

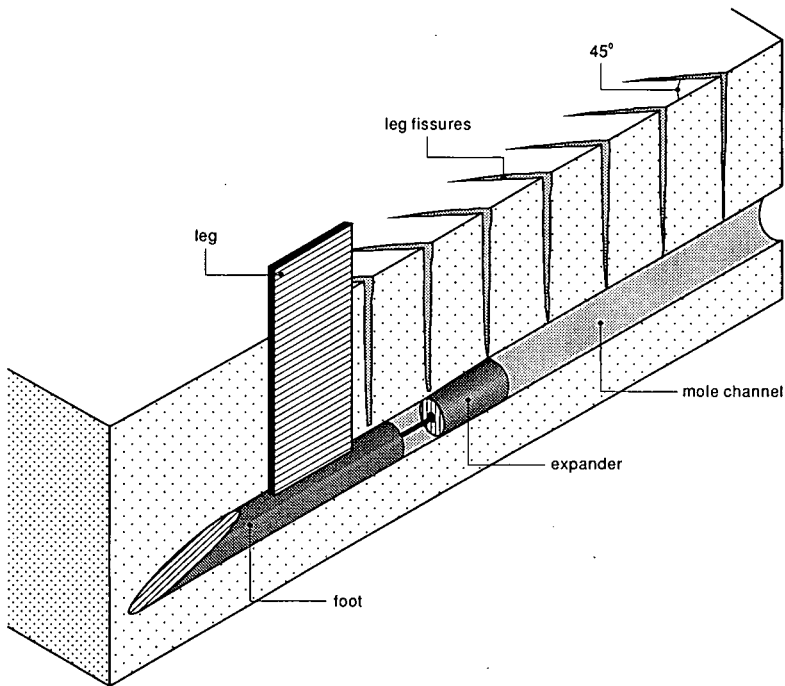

Figure 21.51 Mole plough and resulting soil disturbance

The number and size of the leg fissures produced with a given mole plough are dependent upon soil conditions. A smaller number of wide fissures tend to form under drier conditions, but as the soil-water conditions become increasingly plastic, the fissures become narrower and more numerous. These changes continue until fissure development ceases under very plastic conditions.

Mole channel walls become smoother as soil-water contents increase, the following expander increasing the smoothing effect. At high water contents in low density soils, the expander tends to seal off the connection between the leg slot and the mole channel.

The success of a mole drainage system is dependent upon satisfying two requirements: achieving the desired water flow path for the particular drainage situation, and installing stable mole channels. The installation technique adopted must meet these requirements.

21.9.2 Water Flow Path Requirements

The specific type of water flow path required depends upon the particular drainage problem or moling application. The desired water flow routes to the mole channel vary from almost 100% localized flow through the leg slot and fissures, to the situation where flow is largely through the soil mass between the mole drains, with little flow through the fissures. The requirements for different situations will be considered below.

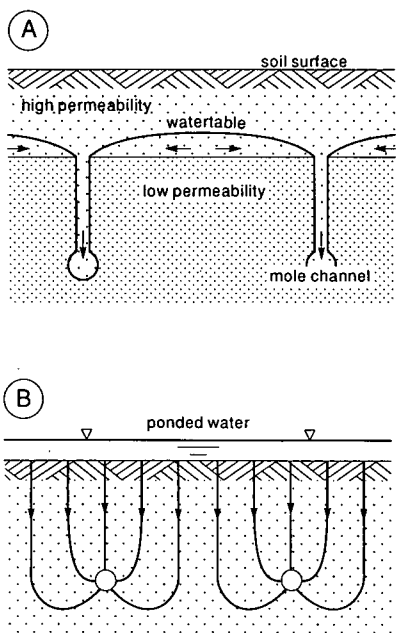

Figure 21.52 Optimum water flow paths to mole drains
 A: Perched watertable situation
 B: Reclamation situation

Perched Watertable Situations

The prime requirement in perched watertable situations is for a rapid discharge of water from the more permeable upper soil layers into the drain, thus de-watering the saturated surface horizons quickly. This can best be achieved by having well-developed leg slot and leg fissure connections between the surface layers and the mole channel (Leeds-Harrison et al. 1982). The importance of achieving this slot/fissure/mole-channel connection increases as the hydraulic conductivity of the subsoil decreases.

Figure 21.52A shows the desired water flow route to the drains, and Figure 21.53 illustrates the higher discharge rates achieved with well-developed leg fissures.

Reclamation Situations

For uniform salt leaching, water should flow uniformly through the whole soil profile as shown in Figure 21.52B. Leg-fissure and leg-slot flow are therefore undesirable and hence their development should be minimized at installation. Figure 21.54 shows the improvement in salt removal due to a sealing off of the leg fissures, during the leaching of a saline sodic soil (Spoor et al. 1990). The rapid decline in the salt concentration of the drainage water in the unsealed leg fissure plot is due to localized water flow through fissures.

In some situations, particularly in unstable structured soils, it may be necessary

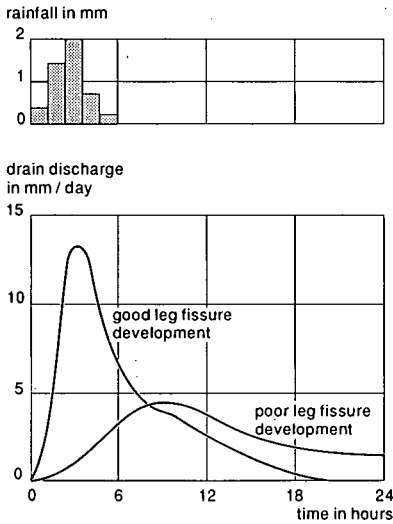

Figure 21.53 Influence of leg fissure development on mole drain discharge

to seal off the leg-slot/mole-channel connection completely. This is necessary to prevent the surface-applied, good-quality, low-electrolyte concentration leaching water from moving directly into the drain and causing soil dispersion and mole channel collapse. With this connection closed, the water entering the mole channel now flows from the general soil mass and, because of salt abstraction, has a higher salt concentration, inducing stability in dispersive soils. In very unstable soils, leg fissure closure at the soil surface after installation may also sometimes be needed.

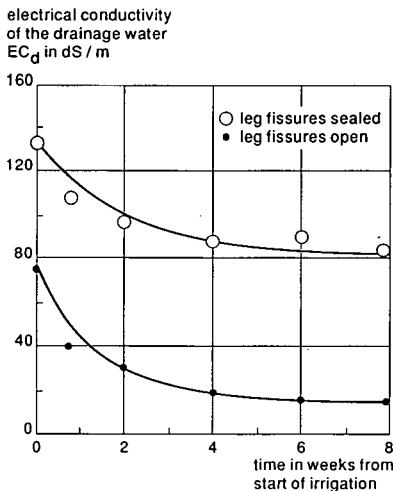

Figure 21.54 Influence of leg fissure development on leaching uniformity: A slow decline in the electrical conductivity of the drainage water (EC_d) indicates uniform leaching; a sharp decline of the EC_d indicates low leaching uniformity

Flood Irrigation Situations

A direct fissure/leg-slot connection between the soil surface and the mole channel in flood irrigation situations is highly undesirable, since it will result in the direct loss of irrigation water to the drain, and will increase the risk of high velocity water flow through the fissures and drains causing soil erosion. Throttled or sealed connections are therefore required in these situations.

Groundwater Control Situations

In groundwater control situations, the presence or absence of leg fissures has little influence on the flow of water into the mole channel. The type of fissure development in the surface layers at installation is therefore not particularly critical.

Paddy Field Situations

Drainage is only required in paddy fields at certain growth stages of the rice crop, the discharge from the mole drains being blocked at other times. The mole drains will function either with or without fissure development, although discharge rates will differ accordingly, in a similar manner to the situation illustrated in Figure 21.53. Providing there is good mole channel stability, good fissure/leg-slot/mole-channel connections are desirable to allow the rapid drawdown of water from the paddy above.

21.9.3 Achievement of Desired Water Flow Paths

The desired water flow path can be achieved by modifying, as necessary, the extent of leg fissure development and the effectiveness of the connection between the leg slot and the mole channel itself. Fissure development can be modified by moling under different moisture conditions as described in Section 21.9.1, or by adjusting the geometry of the mole plough leg (Spoor et al. 1989).

The number and size of the leg fissures generated in any given soil condition depends upon the sliding resistance between the soil and the side of the leg. The greater this resistance, the fewer the number but the wider and more well-developed the fissures become. Within limits, this resistance, and hence crack development, can be increased by increasing leg thickness, leg roughness, or side area, and vice versa. Crack development is most sensitive to leg thickness and roughness when soil adhesion is low, and to side area when adhesion is high. It is also greater in soils with high air-filled porosities.

In situations where the direct access of surface water into the mole channel is undesirable (e.g. in flood irrigation or reclamation situations), the leg slot and fissures in the soil surface layers can be disrupted and subsequently closed with the wedge shown in Figure 21.55, followed by soil compaction. The wedge destroys the vertical continuity of the slot and fissures, leaving the surface soil in a more favourable condition for compaction by wheels or heavy rolls. When the wedge is being used, it is essential that its leading edge be behind the rear of the expander (Figure 21.55), otherwise the expander will not perform satisfactorily.

The fissure connection controlling water flow between the leg slot and the mole channel can be throttled or sealed by increasing the diameter of the expander relative to the foot diameter, or vice versa. Sealing can be more readily achieved at higher soil-water contents.

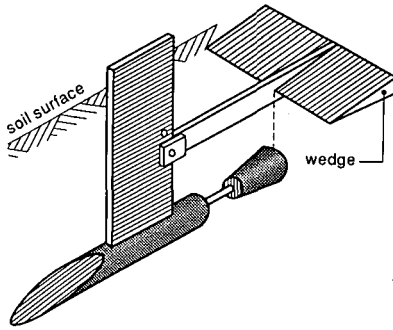

Figure 21.55 Mole plough wedge for disrupting leg slot and fissures

The timing of installation and/or the installation technique are therefore critical to ensure that the necessary water flow paths are achieved.

21.9.4 Mole Channel Stability

The life of mole channels can vary widely from ten minutes to ten years or more, depending upon soil type, soil conditions at moling, installation technique and equipment, and the subsequent weather patterns. In areas where moling is regularly practised, the working life of the channel usually varies from three to five years or more. The required life in other situations will, however, depend upon benefit-cost ratios and the ability to re-mole an area at an appropriate time after collapse.

Channel life is very dependent on the magnitude of the cohesive bonds that develop in the channel-wall area following installation, and on the disruptive stresses, usually due to soil swelling, which may ensue. The stronger the bonds and the weaker the disruptive stresses, the longer the channel life. Mole channels collapse in numerous ways depending upon the circumstances prevailing.

The more common types of channel failure encountered and described more fully in Spoor and Ford (1986) are as follows:

- a) Roof collapse/expander failure: roof collapse due to inadequate cohesion between soil structural units, or resulting from soil disturbance caused by the expander at installation; it is common in smectitic clay soils and on all soils under conditions where soil-water contents at moling depth tend to be rather low (near or below the soil plastic limit) at installation;
- b) Cyclical swell/shrink failure: collapse of channel roof and walls after a period of time, as a result of numerous wetting and drying cycles causing repeated swelling and shrinkage; it is common in swelling clays in areas where significant drying regularly occurs;
- c) Unconfined swelling failure: here the channel diameter steadily decreases with time through soil swelling; it is common in micaceous clay soils in wetter areas, and under conditions where little drying and hence little shrinkage occurs at channel depth;
- d) Subsoiler failure: downward settlement of the mole channel roof, producing a flattened channel; due to moling at too shallow a depth.

- e) Slurry failure: here the channel rapidly fills with slurried soil; it is common in the less stable structured soils and in all soils where significant water inflow occurs soon after installation;
- f) Infill failure: soil falling into the mole channel from the surface layers through open leg fissures and leg slot; it is common following surface cultivation during dry periods with open leg slots;
- g) Erosion failure: soil eroded from channel floor and walls; it is most common in weakly structured soils and when large channel gradients induce high flow velocities.

Adjustments to the mole-foot and expander geometry and to the installation technique can assist, in certain situations, in maximizing channel resistance to collapse through specific failure mechanisms. Identifying the failure mechanisms most likely to be active allows the selection of the most appropriate equipment and installation techniques to maximize mole channel life. The soil, timing, equipment, and installation factors influencing mole channel stability and the requirements for extensive channel life will now be discussed.

21.9.5 Requirements for Long-Term Mole Channel Stability

Numerous factors, detailed below, influence the success of a moling scheme, and the more closely the soil and installation conditions approach them, the more successful the operation is likely to be.

Clay Content

Soil clay content is particularly important because of its influence on the magnitude of the cohesive forces which are necessary for channel stability. Some of the best moling soils have clay contents in excess of 45%, whereas soils with less than 30% clay are rarely good molers. Uniform soils are most satisfactory. Mole channels in soils containing sand or silt pockets are more prone to collapse.

Clay Mineralogy

The major influence of clay mineralogy is on the nature of mole channel deterioration. Smectitic clays are more likely to collapse through expander and cyclical swell/shrink failures, and micaceous clays through unconfined swelling.

Structural Stability on Wetting

Soil structural stability on wetting is a crucial factor influencing channel life. The more resistant the soil structural units are to collapse on wetting, the more stable the mole channels are likely to be (Rycroft and Alcock 1974). The Childs and Emerson Stability Tests (Childs 1942; Emerson 1967) are frequently used to assess soil structural stability for moling purposes. The Emerson Test, based on visual assessments of the slaking and dispersion properties of soils, is quick and useful for identifying very weakly structured soils. The Childs Test is more time-consuming but is appropriate for the complete range of soils. Structural stability is assessed on a basis of differences between the water-release characteristics of initially air-dry samples, wetted very rapidly by flooding, and slowly through capillarity.

Weakly structured and dispersive soils are unsuitable for moling, unless the electrolyte or salt concentration of the drainage water entering the mole channel can be increased to improve stability. This can be achieved in saline soils by preventing the direct access of surface water of low electrolyte concentration through the leg fissures and leg slot. The introduction of soil-amending materials such as gypsum into the neighbourhood of the channel also assists an increasing electrolyte concentration.

Soil Packing State

Soil aggregate density itself cannot be changed during the moling operation because the aggregates at moling depth are usually saturated. There are some indications, however, that mole channels in soils with a high bulk density tend to be more stable than those in low density ones, because of slower swelling rates.

Timing of Moling Operation

Significant water inflow into the mole channel soon after formation reduces channel life considerably and induces slurry failure. If the channel can age or mature for a number of weeks (2 to 3 minimum) before being wetted, it will be much more resistant to collapse. Moling during a drying period is therefore most desirable. An extended drying period after moling in smectitic clay soils may, however, cause excessive and undesirable shrinkage in the leg slot area, leading to considerable channel in-fill with surface soil. Where moling has to be done in the presence of a perched watertable or of free water at moling depth with immediate water entry, this moling should be regarded as a de-watering operation and the operation should be repeated later under drier conditions.

Soil at moling depth needs to be in a state of plastic consistency to enable the formation of the most stable, firm, smooth-walled mole channel. The smooth wall is preferably fissured at intervals along its length, the fissures acting as focal points for water entry.

Moling Depth

Mole channels are commonly installed at depths between 0.4 and 0.7 m, although there is no restriction to deeper installation. Wherever possible, installation should always be in the most suitable and structurally stable soil layer. Moles should be installed deeper in situations where deep soil drying and cracking are likely to occur; this reduces the risks of cyclical swell/shrink failures.

For any mole-foot/expander combination, there is a critical minimum moling depth for stable channel formation. Working shallower than this critical depth loosens the soil and induces a rapid subsoiler failure. This loosening failure can be readily identified by excessive soil heave at the surface and through the absence of the leg fissures, angled at 45° to the direction of travel (see Figure 21.51). The herringbone pattern of leg fissures along the mole run is usually very obvious at the soil surface when the moles are being installed correctly, below the critical minimum depth. Reducing the diameters of the mole plough foot and expander brings the critical minimum moling depth closer to the surface, hence allowing shallower moling.

Mole Drain Spacing

Because of the semi-permanent nature of mole drains and the risks of collapse, spacings

closer than those required to meet the drainage design criteria are usually adopted. This ensures that drainage performance is not seriously impaired if some of the mole drains collapse. These closer spacings have minimal implications on cost, because mole drains are very cheap to install. Common mole drain spacings range between 2.0 and 3.5 m.

Length of Mole Run

The length of the mole run between outfalls is dependent upon the estimated chances of moling success. The greater the risk of channel failure, the shorter the length of run adopted, to minimize the effect of local collapse on overall drainage efficiency. Factors such as the moling qualities of the soil, surface irregularities and gradients, possible reverse gradients, and the presence of sand and silt pockets are usually considered when deciding upon run length. Common lengths of run vary from approximately 20 to 100 m. The length may have to be reduced on steep gradients to avoid channel erosion.

Mole Foot and Expander Diameter

The most commonly used diameters for mole foot and expander were indicated in Table 21.14. The choice is dependent upon the most probable type of mole channel failure, soil conditions at installation, depth requirements, and the power available.

Where unconfined swelling failures are expected, larger diameter mole channels should be installed to extend their working life. Soils prone to roof collapse and expander failure, on the other hand, benefit from smaller diameter channels. Expander failure is very common following installation under marginally dry conditions (soil at or very close to its plastic limit). In these circumstances, the expander diameter should be only slightly larger than the foot diameter, its function being only to smooth out the channel walls rather than induce further deformation.

In situations where it is necessary to seal off the mole channel from the leg slot above, this can be achieved by increasing the expander diameter relative to the foot diameter. Conversely, in circumstances where a good open connection is required between leg slot and channel and the leg slot and fissures are only weakly formed, removing the expander completely will help keep the connection open. This latter situation is common when moling under softer, very plastic soil conditions.

In all cases when foot and expander diameters are being manipulated, care is required to ensure that the changes do not cause a subsoiler failure through installation above the critical minimum depth. When power is limited, smaller diameter channels are installed at shallower depths.

Mole Channel Outlets

A good stable outfall for the mole channel is essential for successful moling. Outfalls into open ditches must be stabilized with short lengths of pipe (0.8 to 1.0 m long) at the outlet. Severe channel wall drying from an open ditch outfall during very dry periods can cause premature collapse, particularly in smectitic clay soils. Closing the outfalls at the beginning of a dry period will help to avoid this problem, otherwise a longer length of stabilizing pipe should be inserted into the channel to protect and support the most vulnerable section near the open ditch.

Very satisfactory, although more expensive, outfalls can be achieved by drawing

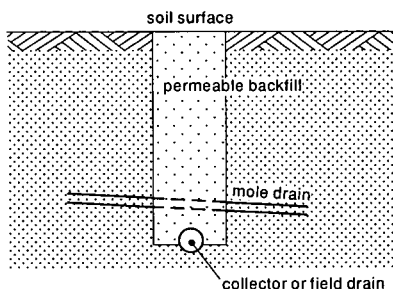

Figure 21.56 Mole drain outlet (permeable backfill type)

the mole channels through a previously installed, stable, permeable backfill zone above a permanent pipe drain (Figure 21.56). Water is discharged directly from the mole channel into the permeable backfill and then flows downwards into the pipe system below. Gravel, crushed stone, or strong clinker are commonly used as the permeable backfill material. Their size grading usually lies between 20 and 40 mm diameter and they should be free from fines. The permeable backfill should extend to a minimum height of 50 mm above the top of the mole drain.

In certain situations (wetter soils) with narrow bands of permeable backfill, the mole plough and expander may draw soil into the backfill, tending to seal off the connection between the mole and the backfill. Attaching a narrow tine behind the expander to work approximately 10 mm deeper (Figure 21.57) overcomes this problem by disrupting the soil layer and remaking the connection (Castle et al. 1992).

Mole drains themselves can be used as collector outfalls and these are frequently known as major moles or moled mains. The moled mains should be installed first, in pairs about 1 to 2 m apart, in the required outfall position. The field moles are then drawn above and across the moled mains, with the field mole channel invert within approximately 50 mm of the top of the moled main. In some field situations (wet, soft, or poorly structured soil conditions), it is advisable to make a positive connection between the two channels, to ensure water discharge from the field mole into the main. This can be achieved by forcing a spear, 5 to 10 mm in diameter, between the two channels.

Mole Channel Grade

Grade has two major influences on mole channel stability, namely on water ponding and on erosion. Extended water ponding within the channel, particularly to depths greater than half the channel diameter, rapidly increases the rate of channel collapse. Reverse gradients, a major cause of ponding, therefore have to be avoided.

Excessive channel grade may cause an erosion failure and, on sloping areas, grades

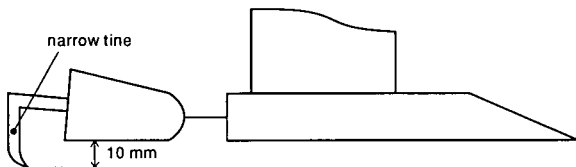

Figure 21.57 Tine attached to expander to restore connection between mole channel and permeable backfill

between 1 in 40 and 1 in 60 are often considered optimum. Lower grades are satisfactory, providing local reverse grades can be avoided.

The risk of local reverse grades developing increases as local variations in surface elevation increase. In certain situations, it may be advantageous to grade the mole channel positively, to a gradient different from that of the general soil surface.

Under certain conditions, with relatively large channel gradients and higher flow velocities, a local channel blockage can disrupt water flow, causing water to 'blow-out' to the surface, creating a wet area. This problem can be minimized by reducing channel gradients.

Grade Control at Installation

The gradient of the installed mole channel is usually similar to the average gradient of the soil surface. No direct grade-control measures (e.g. the use of rotating lasers) are normally employed at installation. The channel gradient is controlled either by the mole plough itself, or through its hitching arrangement to the tractor. Critical requirements are to avoid reverse gradients and sudden changes in channel grade. Reverse gradients encourage water ponding, and sudden grade changes induce subsoiler failures in the channel; both cause rapid collapse.

The prime grading requirement during mole drain installation is that the mole foot should run at the required depth, parallel to the average grade of the soil surface. Local surface undulations should not cause the mole channel to deviate significantly from this average grade. The potential for achieving this is dependent upon the type of mole plough, its adjustment, and the site conditions.

Four basic types of mole plough are available (Figure 21.58):

- A) Fully mounted: the plough is attached directly to the 3-point linkage of the tractor;
- B) Long-beam scrubbing mole plough: here a long beam (3 to 4 m long), carrying the mole plough leg and foot, moves along in contact with the soil surface;
- C) Long-beam mole plough with front skids: the beam runs clear of the ground, but it is supported on front skids; the depth is controlled by angling the leg and foot assembly relative to the beam;
- D) Long-beam floating mole plough: the complete beam rides clear of the soil surface; this plough is usually attached to the tractor through a smoother device to reduce the effects of tractor pitching on mole foot movement.

The first three types of plough have been described in detail by Hudson et al. (1962) and the fourth by Spoor et al. (1987).

The best results with the mounted mole plough are achieved when it is used with the tractor linkage operating in 'free float', rather than in draught control mode. The depth of operation and hence channel gradient in draught control can vary greatly, even on smooth surfaces, because of changes in soil conditions. Mounted mole ploughs are only satisfactory on smooth field surfaces. Once local surface irregularities become significant, performance is poor. It is also essential to ensure that the tractor can generate adequate traction for the operation, without having to be operated in draught control.

The long-beam scrubbing and front-skid mole ploughs are more satisfactory than the mounted types when local surface undulations are more significant. The scrubbing

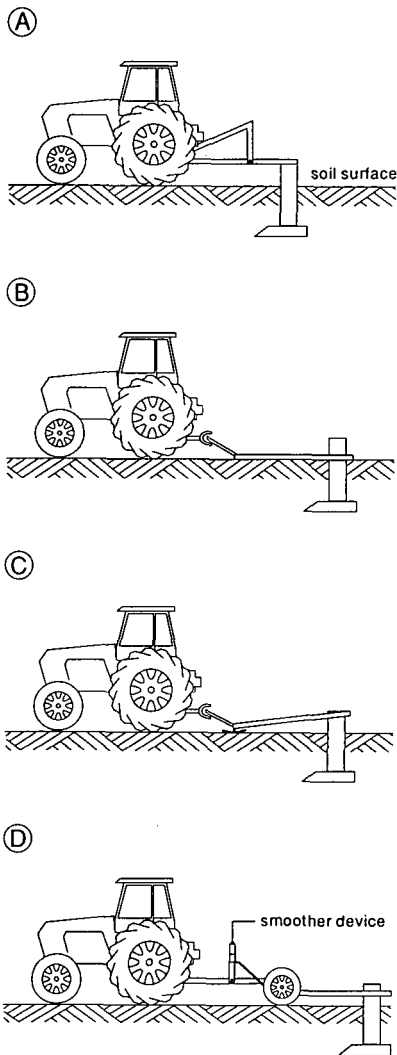

Figure 21.58 Types of mole plough

- A: Fully mounted plough
- B: Long-beam scrubbing plough
- C: Long-beam plough with front skid
- D: Long-beam floating plough

long beam tends to bridge over the irregularities, minimizing movements at the foot, particularly when passing through local depressions. This scrubbing plough suffers, however, from having a higher pull, due to the sliding forces generated at the beam/soil interface. The forward tilt of the mole foot should be adjusted so that the downward force generated is just sufficient to keep the beam in contact with the surface. Any further tilt simply increases draught without improving performance and the increase can be as high as 100% with a poorly adjusted plough (Godwin et al. 1981). The

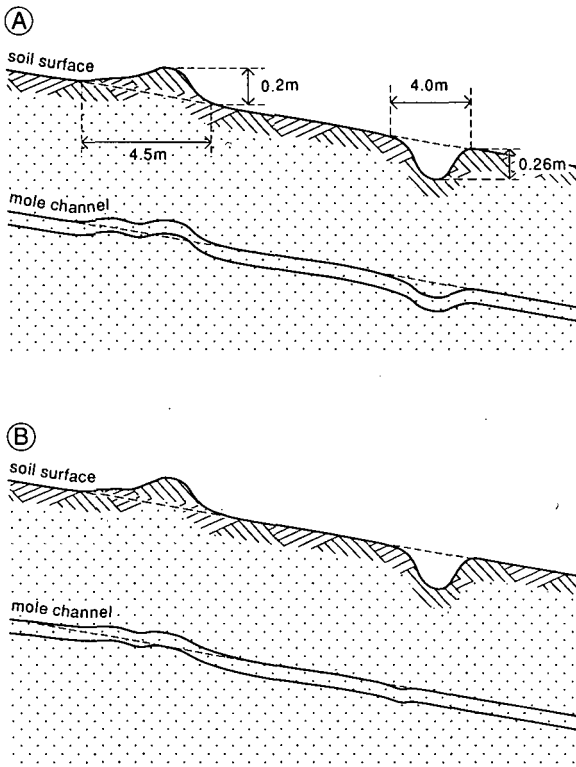

Figure 21.59 Mole channel grade variation (Note: exaggerated vertical scale)
 A: Long-beam scrubbing mole plough
 B: Floating mole plough

additional draught penalty is considerably less with the front skid plough, which should be adjusted so that the skids are just in contact with the soil surface.

The long-beam floating plough always operates with minimum draught, and the foot position, and hence the mole channel itself, is least affected by surface irregularities and soil variations. This plough also allows the mole channel to be graded independently of the average surface level, without the need for sophisticated grading equipment. Grading is achieved by raising or lowering the height of the mole plough hitch at the smoother whilst moling is in progress. Rotating lasers can, if necessary, be fitted to this plough.

The improved performance of the floating plough as compared with the scrubbing plough, in terms of reduced grade variation when moving across surface undulations, is clearly shown in Figure 21.59. The hollow influence is almost eliminated with the floating plough and the rate of change in grade as the floating plough passes through the rise, is considerably less than with the scrubbing beam implement. This reduced rate of change significantly lowers the risk of channel failure at those points.

21.9.6 Gravel Moles

In situations where mole channels collapse quickly, through causes other than complete soil structural instability, their life can be increased considerably by in-filling them with stone or gravel (Mulqueen 1985). The installation equipment comprises a hollow leg approximately 75 mm wide, with a gravel hopper above. The gravel is inserted into the channel through the hollow leg, and the thickness of the gravel zone in the channel is controlled by an adjustable gate at the rear of the leg. The size range of gravel used is between 5 and 15 mm diameter, to ensure free flow without bridging during installation. The large side area of the leg produces leg fissures similar to conventional mole plough leg fissures. These fissures provide direct access for water from the surface layers into the gravel filled channel.

21.9.7 Mole Drainage Investigations

The performance of mole drainage systems, and the identification of changes in installation and equipment that may be advantageous for the future, can be determined by direct observation and through measurements of the discharge characteristics of the system.

Leg-fissure development, and the extent of any sealing of leg-slot/channel connections at the time of installation, can be most readily determined by excavating along one side of the leg slot and channel to expose the section shown in Figure 21.51. The extent of mole channel deterioration or failure with time can be determined by taking gypsum or plastic foam castes of the channel itself or by observation through an endoscope (Leeds-Harrison et al. 1983). The caste method is a destructive one, whereas regular observations can be made through the endoscope without causing any channel damage. The endoscope offers many advantages for identifying the nature of channel deterioration. For endoscope observation, an access tube is either inserted into the top of the mole channel at installation, or augered in later. A 10 mm diameter plastic pipe is commonly used for this purpose.

The efficiency of the mole drainage system can best be assessed on the basis of the shape of the discharge hydrograph (Figure 21.53; Leeds-Harrison et al. 1982). With a satisfactory mole channel, a peaked hydrograph indicates good leg-fissure development, and a flat one, poor development. Deterioration in the channel itself will reduce the peak of the hydrograph. The desired shape of hydrograph will depend on the type of mole system and the water flow path required.

21.9.8 Introducing Mole Drainage into New Areas

The successful introduction of mole drainage into new areas is unlikely to be achieved without careful consideration of the water flow regime required and the type of equipment and technique needed to achieve the desired flow regime and stable mole channels under the prevailing and subsequent soil-water and weather conditions. Endoscope observations and discharge characteristics enable the existing problems to be quickly identified and provide the necessary information for making

improvements to the installation method. Detailed information is provided in Spoor (1994) on the possibilities and the development techniques required for extending mole drainage into new areas.

References

- Abdel-Dayem, M.S. 1986. A comparative study on the use of PVC and PE in manufacturing corrugated drainage tubing. Ministry of Irrigation, Water Research Center, Drainage Research Institute, Technical Report 53. Giza, Egypt, 24 p.
- Boers, T.M. and C.L. van Someren 1979. Design of gravel envelope for silty and fine sandy soils in Pakistan. In: J. Wesseling (ed.), Proceedings of the International Drainage Workshop. ILRI, Wageningen, pp. 713-731.
- Bons, A. and T. van Zeijts 1991. Jet flushing, a method for cleaning subsurface drainage systems. Govt. Service for Land and Water Use, Information Paper 28, Utrecht.
- Bowler, D.G. 1980. The drainage of wet soils. Publ. Hodder & Stoughton.
- Broughton, R.S. (ed.) 1984. Mardan SCARP subsurface drainage design analyses. Canadian Drainage Team, MARDAN SCARP, WAPDA, Lahore, Pakistan, 224 p.
- Broughton, R.S., M.A. Makhlof and J. Metzger 1990. Features of large diameter corrugated polyethylene pipes manufactured at Aga, Egypt. Proceedings of Symposium on Land Drainage for Salinity Control in Arid and Semi-arid Regions, Vol. 3. Cairo, Egypt, pp. 142-151.
- Broughton, R.S., B.W. Fuller and R.B. Bonnell 1992. Water conveyance capacity of corrugated plastic drain pipe with internal diameters between 38 and 75 mm. Proceedings of the 6th International Drainage Symposium. Nashville Tennessee, American Society of Agricultural Engineers (ASAE), St. Joseph, pp. 288-296.
- Calhoun, C. 1972. Development of design criteria and acceptance specifications for plastic filter cloths. Technical report 5-72-7 USWES, Vicksburg.
- Carroll, R.G. 1983. Geotextile Filter Criteria. Transportation Research Record 916, pp. 46-53.
- Castle, D.A., G. Spoor, E.O. Onasanya and A.K. Ormandy 1992. Mole plough and soil factors influencing the hydraulic connection between mole channels and the permeable backfill placed over pipe drains. Journal of Agricultural Engineering Research 51, pp. 217-235.
- Cavelaars, J.C. 1966. Hydrological aspects of the application of plastic drain pipes and filter materials. Symposium on Hydrological and Technical Problems of Land Drainage, October 1965, Prague.
- Cavelaars, J.C. 1967. Problems of water entry into plastic and other drain tubes. Agricultural Engineering Symposium at the National College of Agric. Engineering. Silsoe, 5/E/46, 13 p.
- Cavelaars, J.C. 1979. Composing a drainage pipe line of sections of different diameters. Proceedings International Drainage Workshop at Wageningen. ILRI Publication 25, pp. 402-413.
- Comité Français des Géotextiles et Géomembranes 1986. Recommendations pour l'emploi des géotextiles dans les systèmes de drainage et de la filtration. Boulogne-Billancourt.
- Childs, E.C. 1942. Stability of clay soils. Soil Science 53, pp. 79-72
- Chow, V.T. 1973. Open channel hydraulics, International edition. McGraw-Hill Book Co., Singapore, pp. 89-150.
- Christopher, B.R. and R.D. Holtz 1985. Geotextile Engineering Manual. U.S. Federal Highway Administration, Report FHWA-TS-86/203.
- Dieleman, P.J. and B.V. Trafford 1976. Drainage Testing. Irrigation and Drainage Paper 28, FAO, Rome.
- Dierickx, W. 1980. Electrolytic analogue study of the effect of openings and surrounds of various permeability on the performance of field drainage pipes. Rijksstation voor Landbouwtechniek, Publication 77, Merelbeke.
- Dierickx, W. 1993. Research and developments in selecting drainage materials, Irrigation and Drainage Systems, Vol. 6, No. 4, pp. 291-310
- Dinc, G., G.E. Merva and E.H. Kidder 1971. Proceedings National Drainage Symposium, Chicago. ASAE, St. Joseph, pp. 11-14.
- El Atfy, H., O. Wahid El-Din, H. El-Gamaal and H.P. Ritzema 1990. Hydraulic performance of subsurface collector drains in Egypt. Symposium on Land Drainage for Salinity Control in Arid and Semi-arid Regions. Drainage Research Institute, Cairo, Vol. 3, pp. 393-404.

- El Atfy, H.E., M.Q. Abdel-Alim and H.P. Ritzema 1991. A modified layout of the subsurface drainage system for rice areas in the Nile Delta, Egypt. *Agricultural Water Management* 19, pp. 289-302.
- Emerson, W.W. 1967. A classification of soil aggregates based on their coherence in water. *Australian Journal of Soil Science* 5, pp. 47-58.
- Engelund, F. 1953. On the laminar and turbulent flow of groundwater through homogeneous sands. *Trans. Danish Academy of Techn. Science*, No. 3.
- Framji, K.K., B.C. Garg and S.P. Kauthish (eds.) 1987. Design practices for covered drains in an agricultural land drainage system. *International Commission on Irrigation and Drainage*, New Delhi, 438 p.
- Giroud, J.P. 1982. Filter criteria for geotextiles. In: *Proceedings of the Second International Conference on Geotextiles*. Vol. 1. Las Vegas, pp. 103-108.
- Godwin, R.J., G. Spoor, P.B. Leeds-Harrison 1981. An experimental investigation into the force mechanics and resulting soil disturbance of mole ploughs. *Journal of Agricultural Engineering Research* 26, pp. 477-479.
- Heerten, G. 1983. *Filtreigenschaften von Geotextilen für den Erd- und Wasserbau*. *Wasser und Boden*, pp. 348-353.
- Heidemij 1972. Onderzoek naar de wrijvingsweerstand in een geribbelde plastic buis. N.V. Heidemaatschappij Beheer, Arnhem, 14 p.
- Hudson, A.W., H.G. Hopewell, D.G. Bowler and M.W. Cross 1962. The drainage of farm lands. *Bulletin No. 18*, Massey College, Palmerston North.
- Huisman, L. 1969. Stromingsweerstand in leidingen. *Mededeling nr. 14*, KIWA, Rijswijk.
- Irwin, R.H. 1982. Hydraulic roughness of corrugated plastic tubing. *Proceedings Second International Drainage Workshop*, Washington, pp. 52-62.
- Irwin, R.W. and G. Tsang 1972. Hydraulic roughness of corrugated plastic tubing. *ASAE, St. Joseph*, pp. 290-291, 295 p.
- Irwin, R.W. and J. Motcyka 1979. Friction factors for corrugated plastic drainage pipe. *Journal of the Irrigation and Drainage Division*, Vol. 105, IR1. pp. 29-36.
- Johnson, H.P. 1971. Hydraulic roughness in drain tile. *National Drainage Symposium*. *ASAE, St. Joseph*, pp. 15-19.
- Kirkham, D. 1951. The effect of circular perforations of flow into subsurface drain tubes. Part II. Experiments and results. *Agricultural Engineering* 32, 5, pp. 210-224.
- Kirkham, D. 1957. The ponded water case. In: J.N. Luthin (ed.), *Drainage of agricultural lands*. *American Society of Agronomy*, Madison, pp. 139-180.
- Leeds-Harrison, P.B., G. Spoor, R.J. Godwin 1982. Water flow to mole drains. *Journal of Agricultural Engineering Research* 27, pp. 81-91.
- Leeds-Harrison, P.B., R.K. Fry, C.J. Cronin and J.E. Gregory 1983. A technique for the non-destructive monitoring of subsurface drains. *Journal of Agricultural Engineering Research*, 28, pp. 479-484.
- Millar, P.J., K.W. Ho and H.R. Turnbull 1980. A study of filter fabrics for geotechnical applications in New Zealand. *Ministry of Works and Development*, *Central Laboratories Report no. 2-80/5*.
- Mulqueen, J. 1985. The development of gravel mole drainage. *Journal of Agricultural Engineering Research*, 32, pp. 143-151.
- Nederlands Normalisatie-Instituut 1990. NEN 5168: Geotextielen-Bepaling van de karakteristieke poriegrootte in droge toestand. NNI, Delft.
- Nicholson, H.H. 1942. *The principles of field drainage*. Cambridge, University Press.
- Ogink, H.J.M. 1975. Investigations on the hydraulic characteristics of synthetic fabrics. *Delft Hydraulics Laboratory*, Publication 146.
- O'Neil, P.V. 1983. *Advanced Engineering Mathematics*. Wadsworth Publishing Co., Belmont, pp. 1049-1052.
- Rankilor, P.R. 1981. *Membranes in ground engineering*. Wiley.
- Rycroft, D.W. and M. Alcock 1974. The assessment of suitability of soils for moling. *Technical Bulletin 75/5*. *Field Drainage Experimental Unit*, Cambridge.
- Schober, W. and H. Teindl 1979. Filter criteria for geotextiles. In: *Proceedings of the Seventh European Conference on Soil Mechanics and Foundation Engineering*. Vol. 2. Brighton, pp. 121-129.
- Schultz, B. 1990. Guidelines in the construction of horizontal subsurface drainage systems. *International Commission on Irrigation and Drainage*, New Delhi, 236 p.
- Smedema, L.K. and D.W. Rycroft 1983. *Land drainage: planning and design of agricultural drainage systems*. Batsford, London, 376 p.
- Soil Conservation Service 1971. *National Engineering Handbook 16. Drainage of Agricultural Land*. U.S. Department of Agriculture, Washington.

- Soil Conservation Service 1988. Standard on Subsurface Drains. USDA-SCS, Washington D.C., pp. 606/1-606/7.
- Sommerfeldt, J.G. and C. Chang 1986. Desalinization of an irrigated, mole-drained saline clay loam soil. *Canadian Journal of Soil Science*, 67, pp. 263-269.
- Soong, Si-Fu and Zhang Wei 1985. Subsurface drainage in lowland rice fields in China. In *Soil Physics and Rice*, IIRRI, Los Banos, pp. 351-366.
- Spalding, R. 1970. Selection of materials for subsurface drains. RRL Report LR 346, Road Research Laboratory, Crowthorne.
- Spoor, G. 1994. Application of mole drainage in the solution of subsoil management problems. In: N.S. Jayawardene and B.A. Stewart (eds.), *Innovative management of subsoils. Advances in Soil Science*. Springer-Verlag. New York. In press.
- Spoor, G. and R.A. Ford 1986. Mechanics of mole drainage channel deterioration. *Journal of Soil Science*, 38, pp. 369-382.
- Spoor, G., R.J. Godwin and S.M. Miller 1987. Mole plough grade control. *Journal of Agricultural Engineering Research*, 38, pp. 145-166.
- Spoor, G., M.J. Hann and A.S. Centeno 1989. Influence of mole plough leg and expander geometry on soil disturbance. *Proceedings 11th Congress on Agricultural Engineering, CIGR, Dublin*.
- Spoor, G., C.J. Cronin and P.B. Leeds-Harrison 1990. Mole drain installation for leaching purposes. *Proceedings of Symposium on Land Drainage for Salinity Control in Arid and Semi Arid Areas*. Cairo, Section 3, pp. 47-54.
- Stuyt, L.C.P.M. 1992. The water acceptance of wrapped subsurface drains. Ph.D. Thesis Agricultural University, Wageningen, 305 p.
- Sweetland, D.B. 1977. The performance on non woven fabrics as drainage screens in subdrains. Master of Science Thesis, University of Strathclyde.
- U.S. Bureau of Reclamation 1978. *Drainage Manual*. U.S. Govt. Printing Office, Washington, 286 p.
- Van der Sluys, L. and W. Dierickx 1990. Comparative study of different porometry determination methods for geotextiles. *Geotextile and Geomembrane* 9, pp. 183-198.
- Van Zeijts, T.E.J. 1987. Quality control of subsurface drainage works in The Netherlands. In: *Installation of pipe drains*. Govt. Service for Land and Water Use, Information Paper 21, Utrecht, pp. 23-32.
- Van Zeijts, T.E.J. 1992. Recommendations on the use of envelopes based on experience in The Netherlands. In: *Proceedings 5th International Drainage Workshop, Lahore, Volume 3, IWASRI, Lahore, 5:88-97*.
- Van Zeijts, T.E.J. and W.H. Naarding 1990. Possibilities and limitations of trenchless pipe drain installation in irrigated areas. In: *Installation of pipe drains*. Govt. Service for Land and Water Use, Information Paper 21, Utrecht, pp. 10-22.
- Van Zeijts, T.E.J. and G. Zijlstra 1990. Rodding, a simple method for checking mistakes in drain installation. In: *Symposium on Land Drainage for Salinity Control in Arid and Semi-Arid Regions, Cairo, Volume 3, Drainage Research Institute, Cairo, pp. 84-93*.
- Vlotman, W.F., F.A. Zuberi and M. Alikhan 1990. Gravel envelope selection, design and installation. In: W.F. Vlotman (ed.), *Drain envelope testing, design and research*. Workshop Proceedings. IWASRI Publication 10, pp. 3-31.
- Vlotman, W.F., Shafiq-ur-Rehman and M.N. Bhutta 1992. Drain envelope design and review. *ASAE 1992 Winter Meeting, Paper 922649, 25 p.*
- Wahid El-Din, O., S. Abdel Dayem and M.H. Amer 1990. Hydraulic characteristics of some drain pipes used in Egypt. *Proceedings of Symposium on Land Drainage for Salinity Control in Arid and Semi-arid Regions, Vol. 2. Cairo, pp. 225-236*.
- Wesseling, J. and F. Homma 1967. Hydraulic resistance of drain pipes. *Netherlands Journal of Agricultural Sciences*, 15, pp. 183-197.
- Widmoser, P. 1966. Potentialströmungen zu geschützten Rohren. *Schweizerische Bauzeitung* 84, no. 52.
- Willardson, L.S. 1974. Envelope materials. In: J. van Schilfgarde (ed.), *Drainage for Agriculture*. Agronomy 17. American Society of Agronomy, Madison, pp. 179-202.
- Winger, R.J. and W.F. Ryan 1970. Gravel envelopes for pipe drains design. *Trans. ASAE* 14(3). American Society of Agricultural Engineers, St. Joseph, pp. 471-479.
- Zeigler, E.R., R.J. Winger and L.S. Willardson 1977. Friction, grade and alignment studies for corrugated plastic drain tubing. *Proceedings Irrigation and Drainage Specialty Conference. Water Management for Irrigation and Drainage, ASCE, Reno, pp. 146-161*.

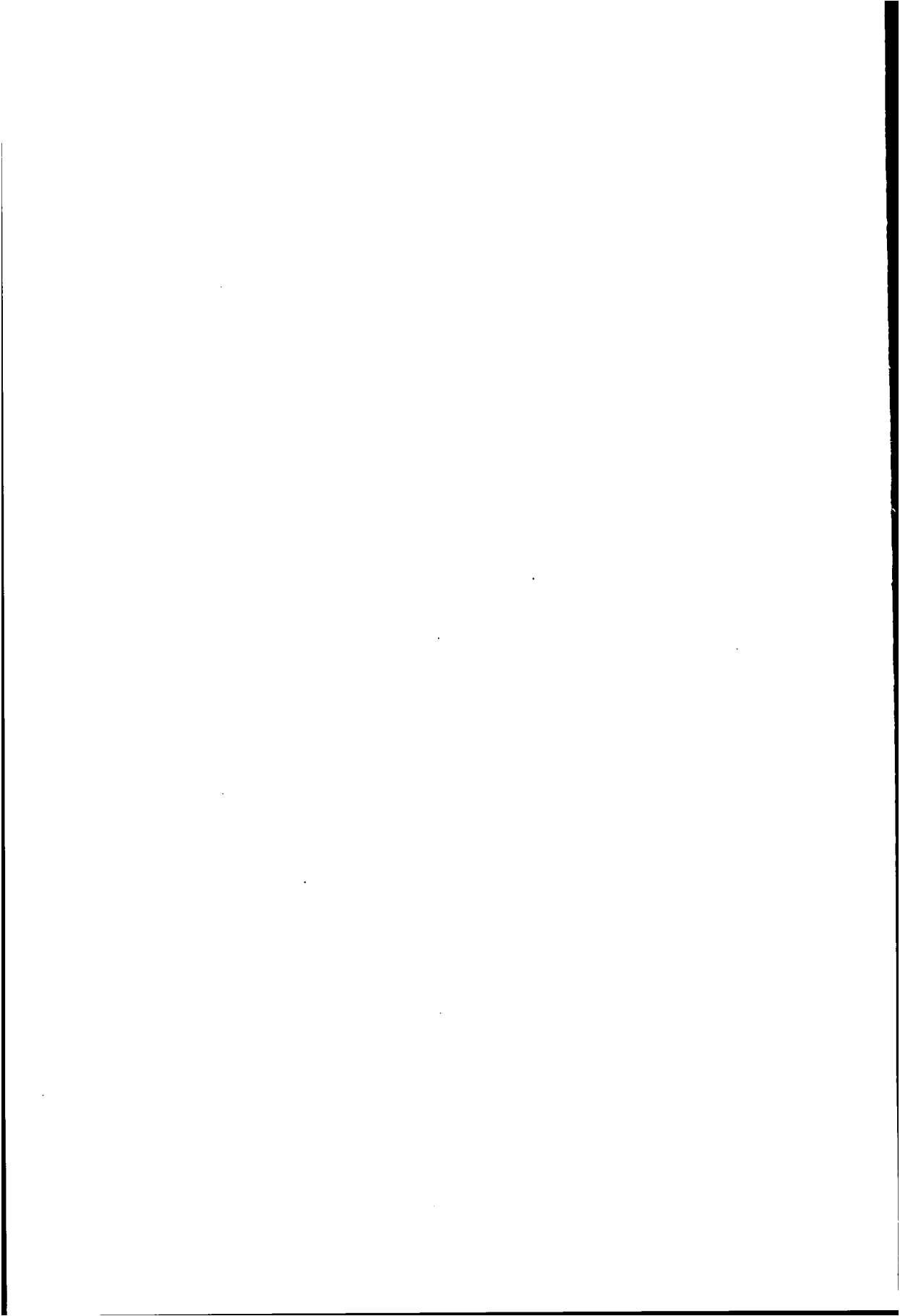

22 Tubewell Drainage Systems

W.K. Boehmer¹ and J. Boonstra²

22.1 Introduction

Tubewell drainage is a technique of controlling the watertable and salinity in agricultural areas. It consists of pumping, from a series of wells, an amount of groundwater equal to the drainable surplus.

Tubewell drainage is not new, but it has not been widely used. Early attempts to use series of pumped wells for land drainage and salinity control were made in the U.S.A. and the former U.S.S.R. more than half a century ago.

The Indus Plain in Pakistan is a notable example of using tubewells for land drainage, salinity control, and the supply of irrigation water. There, over the last 25 years, thousands of public tubewells have been constructed as part of Salinity Control and Reclamation Projects (SCARPs; The White house 1964; Demster and Stoner 1969; Calvert and Stoner 1975; and Nespak-ILACO 1983, 1985).

A review of studies and experiences with tubewell drainage in various countries shows that this technique cannot simply be regarded as a substitute for the conventional technique of subsurface drainage. The success of tubewell drainage depends on many factors, including the hydrogeological conditions of the area, the physical properties of the aquifer to be pumped, and those of the overlying fine-textured layers.

Enough water has to be removed from the aquifer to produce the required drop in hydraulic head, and, for vertical downward flow, the hydraulic conductivity of the overlying layers must be such that the watertable in these layers responds sufficiently quickly to the reduced head in the pumped aquifer.

Another important factor, of course, is that skilled personnel are needed to operate and maintain the tubewells, and to monitor watertables and the quality of the pumped water.

This chapter will discuss the principal aspects of tubewell drainage. First, we explain its various advantages and disadvantages over other subsurface drainage systems. We then go on to examine the factors determining the feasibility of a tubewell drainage system. Before presenting a design procedure for tubewell drainage, we include a section on basic equations pertaining to the subject. The reason for this is that Chapter 10 only presented equations that dealt with the flow to single wells pumping extensive aquifers without recharge. The next section of this chapter is devoted to the actual design procedures, including various design considerations and design optimization. Finally, we discuss maintenance of the system.

¹ Euroconsult, Arnhem

² International Institute for Land Reclamation and Improvement

22.2 Tubewell Drainage Versus Other Subsurface Drainage Systems

The difference between tubewell drainage and other subsurface drainage systems is primarily the way excess water is removed from the underground.

Tubewell drainage removes excess water by pumping from a series of wells drilled into the aquifer to a depth of several tens of metres. The pumped water is then discharged into open surface drains.

Subsurface drainage removes excess water entirely by gravity through open ditches or pipes installed underground at depths varying from 1 to 3 m. With pipes, the water flows either into collector drains with a free outfall into surface drains, or into collector drains that end in sumps. The water is then pumped from these sumps into open surface drains.

A comparison between tubewell drainage and other subsurface drainage systems reveals that both systems have certain advantages and disadvantages. The advantages of tubewell drainage are:

- The total length of open surface drains is considerably less with tubewell drainage than with the other subsurface drainage systems;
- On undulating land with local depressions that have no natural outlets, the pumped water is generally disposed of through pipelines connecting the various wells. Excessive earth-moving is thus avoided, because no deep canals or ditches need to be dug through topographic ridges. Moreover, the absence of such canals and ditches allows more efficient farming operations;
- Such a pipeline system may cost considerably less to maintain than open drains and transport canals;
- Tubewell drainage enables the watertable to be lowered to a much greater depth than do the other subsurface drainage systems. This means that a greater portion of excess water can be stored before it has to be removed, whilst in arid and semi-arid regions a deeper watertable reduces salinization of the soil;
- The deeper layers, or substrata, may be much more pervious than the layers near the surface. Pumping from these layers may reduce the artesian pressure that is often present, creating instead a vertical downward flow through the upper layers. If the pervious substrata are found at a depth of 5 m or more, it is only with tubewell drainage that full benefit can be derived from these favourable hydrogeological conditions;
- If the water in the pumped aquifer is of good quality, it can be used for irrigation. The drainage water then has an economic value, which may contribute considerably to the economic feasibility of the venture.

Tubewell drainage also has certain disadvantages. To mention a few:

- A pumped well is more difficult and costly to maintain and operate than a pipe drain;
- The energy required to operate a multiple-well system has to be purchased as electricity or fuel;
- Legal regulations sometimes forbid the use of pumped wells for land drainage; pumping from wells can reduce the pressure in aquifers to such an extent that existing domestic wells cease to flow;

- Unlike the other subsurface drainage systems, tubewell drainage is not economically feasible in small areas because too much of the water drained out of the area then consists of 'foreign' water (i.e. groundwater flowing in from surrounding areas);
- If, during the growing season, the watertable rises to the land surface (because, for instance, of a heavy rainstorm after irrigation), it has to be lowered rapidly because most crops have only a limited tolerance to waterlogging. This implies a high drainage rate (i.e. a dense network of wells). Of course, the high investment costs of installing a dense network of wells can be reduced by spacing the wells farther apart and pumping them continuously, but this in turn will raise the cost of operating and maintaining the wells;
- Tubewell drainage can only be successfully applied if the hydraulic characteristics are favourable (i.e. if the transmissivity of the aquifer is fairly high); only then can the wells be widely spaced. If the aquifer is semi-confined (Chapter 2), an additional criterion is the value of the hydraulic resistance of the upper clay layer (the aquitard). This value must be low enough to ensure an adequate percolation rate. Hence, a decision in favour of tubewell drainage should only be taken after a careful hydrogeological investigation has proved that its application is practicable;
- Tubewell drainage may not be technically and economically feasible in areas where the artesian pressure in the aquifer is too high or where seepage is excessive;
- The salt content of the drainage water can be considerably higher with tubewell drainage because the streamlines towards the well occur deeper in the aquifer than those towards pipe drains or ditches.

The decision to use one drainage system or the other has to be based on a comparison of their respective advantages and disadvantages, and of their costs and benefits. If the systems are designed and operated properly (i.e. if they meet the agricultural criteria), the tangible benefits of either system ought to be more or less equal. The choice then depends mainly on their costs, leaving aside the imponderabilia.

22.3 Physical and Economic Feasibility

Whether tubewell drainage is physically and economically justified depends primarily on the hydrogeological conditions of the area. For tubewells to be effective in draining agricultural land, a continuous aquifer capable of transmitting water towards the pumped wells needs to underlie the whole area. For unconfined aquifers, this means that both the hydraulic conductivity and the thickness of the aquifer (whose product is the aquifer's transmissivity, KH) must be high enough to ensure an economic spacing and yield of the wells.

For semi-confined aquifers, a further condition is that the hydraulic resistance of the overlying aquitard should not be too high. Finally, the quality of the groundwater can play an important role in the economics of tubewell drainage.

The drainage effluent of a tubewell drainage system in areas with saline groundwater is more saline, and more saline over a longer period, than the drainage effluent of other subsurface drainage systems. With the other subsurface systems, the upper layer of saline water is skimmed off, after which the groundwater is replaced by fresher

groundwater. After a few years of drainage, this results in a better quality effluent. This replacement period is much longer in tubewell drainage, where pumping affects a much deeper layer of groundwater.

The above three factors will be discussed below in more detail. Other factors to be considered in the selection procedure are the availability and cost of energy and the timely replacement of pumps and engines after their economic lifetime.

22.3.1 Hydraulic Conductivity and Thickness of the Aquifer

Hydraulic conductivity varies from one aquifer to another, and even within a single aquifer, appreciable variations can occur, both horizontally and vertically. Also the thickness of an aquifer can vary. The economics of tubewell drainage becomes questionable for poorly transmissive aquifers (i.e. aquifers whose transmissivity is less than approximately 600 m²/d). For a given mean hydraulic conductivity, a minimum thickness of the aquifer is therefore required (Table 22.1).

A comprehensive program of exploratory work and aquifer testing needs to be executed to determine these aquifer properties.

22.3.2 Hydraulic Resistance of the Aquitard

If a low-permeable layer, or a system of such layers, overlies the aquifer, the hydraulic resistance, $c = D'/K'$, plays a crucial role in determining the physical feasibility of tubewell drainage. Even though the aquifer's transmissivity may be very high, thereby allowing widely-spaced, high-capacity wells to be installed, this resistance can be so high that the shallow watertable in the aquitard does not respond, or responds too slowly, to the drawdown in the aquifer. The question thus arises whether the hydraulic resistance has a maximum value that makes tubewell drainage questionable or not feasible at all.

Consider the situation shown in Figure 22.1. It is assumed that there is a steady recharge from excess rain or irrigation water. This implies that the recharge rate towards the aquifer, R , equals the rate of downward flow through the aquitard. This

Table 22.1 Minimum required aquifer thickness (after McCready 1978)

Mean hydraulic conductivity (m/d)	Minimum required aquifer thickness (m)	Transmissivity (m ² /d)
43	14	602
26	25	650
17	40	680
13	60	780

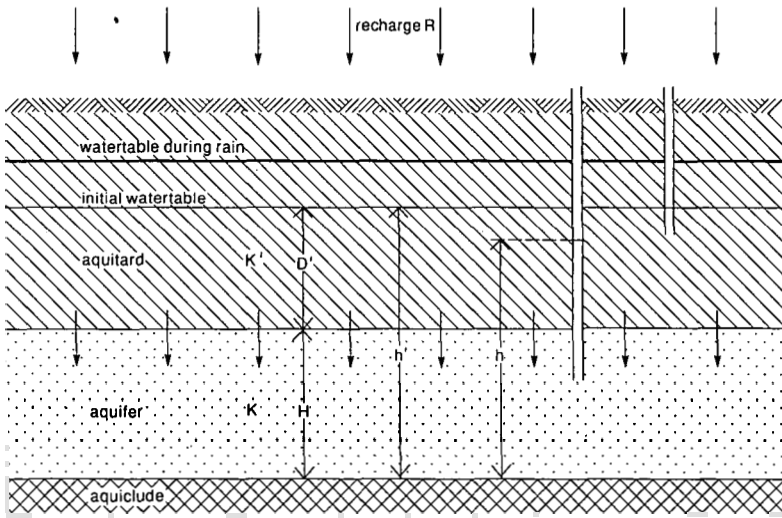

Figure 22.1 Semi-confined aquifer uniformly recharged by infiltrating rain or irrigation water

rate towards the aquifer is governed by Darcy's equation (Chapter 7), which is written as

$$v_z = \frac{K'(h' - h)}{D'} = \frac{h' - h}{c} \quad (22.1)$$

where

- v_z = rate of downward flow through the aquitard (m/d)
- h' = watertable elevation in the aquitard (m)
- h = hydraulic head in the aquifer (m)
- c = hydraulic resistance of the aquitard (d)
- K' = hydraulic conductivity of the aquitard for vertical flow (m/d)
- D' = saturated thickness of the aquitard (m)

The rate of downward flow through the aquitard is proportional to the head difference and inversely proportional to the hydraulic resistance. The watertable in the aquitard is usually shallow, say between 0.5 m and 2 or 3 m below the surface. The piezometric surface of the aquifer may lie above or below the watertable, depending on the local hydrogeological conditions. Head differences ($h' - h$) of the order of a few centimetres to 1 or 2 m are fairly common, and differences of many metres are unrealistic, except in areas with high artesian pressure. Head differences of a few centimetres to, say, 0.1 m are so small that they can be neglected.

Assuming therefore an average head difference, $h' - h = 1$ m, and taking two extreme values for the recharge, say $R = 1$ mm/d and $R = 10$ mm/d, we then find from Equation 22.1 that the hydraulic resistance, c , varies between 100 and 1000 days. Note that, during peak-irrigation periods, the average drainage rate in a peak month may vary from 2 to 5 mm/d, depending on the type of crop.

A value of the hydraulic resistance twice as high (i.e. $c = 2000$ days) would require a head difference twice as high than was assumed, so as to maintain the same

downward flow rate. For a downward flow of 10 mm/d, this would result in a head difference of 20 m, which is impossible.

These tentative calculations clearly show that, when tubewell drainage in semi-confined aquifers is under consideration as an alternative to other subsurface drainage systems, particular attention has to be given to the upper limit of the hydraulic resistance of the aquitard. For values of c much larger than 1000 days, tubewell drainage will not be feasible.

22.3.3 Groundwater Quality

A third factor to be considered with tubewell drainage is the quality of the groundwater. If the pumped groundwater is fresh, it can serve a dual purpose: it can control the watertable and salinity, and can supply water for irrigation. The pumped water then has an economic value, which may largely offset the pumping costs. In semi-arid regions, where surface water is usually scarce, the availability of tubewell water of good to fair quality makes it possible to irrigate more land. This alone makes the technique promising for such regions.

When water is pumped from the aquifer and used for irrigation over a long period of time, a crucial question arises: How will the salt concentration of the tubewell water applied to the crops change with time, or, if well water is mixed with fresh river water, how will the salt concentration of the tubewell water vary with time? When the salt build-up in the aquifer is being calculated, all flow components of the system (Figure 22.2) and their salt concentrations must be considered and evaluated. The salt balance of an area was discussed in Chapter 16.

There are a number of factors to be considered when the salt build-up in this type of combined tubewell drainage and irrigation projects is being investigated:

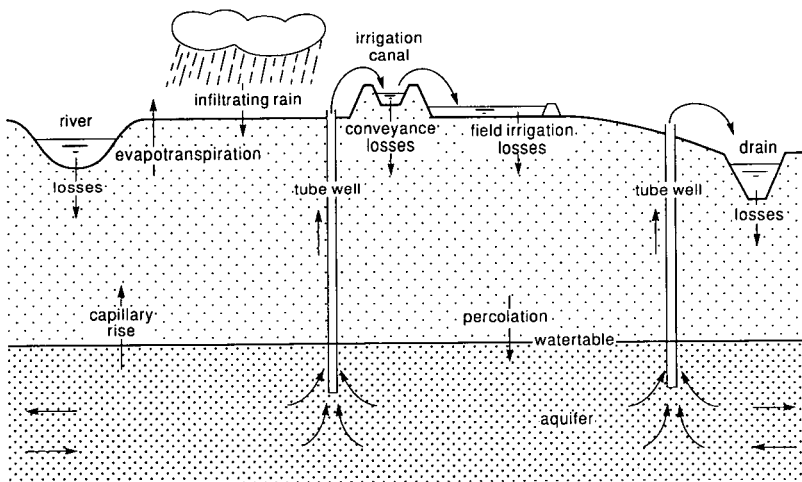

Figure 22.2 Flow components for an area where tubewells are used both for irrigation and drainage purposes

- The concentration of salt in the groundwater;
- The concentration of salt in the soil layers above the watertable (i.e. in the unsaturated zone);
- The spacing and depth of the wells;
- The pumping rate of the wells;
- The percentage of tubewell water removed from the project area via surface drains.

The first two of these factors are determined by the natural conditions and the past use of the project area. The remaining factors are engineering-choice variables (i.e. they can be adjusted to control the salt build-up in the pumped aquifer).

A common practice in this type of study is to assess not only the project area's total water balance (Chapter 16), but also the area's salt balance for different designs of the tubewell system and/or other subsurface drainage systems.

22.4 Basic Equations

Chapter 10 described the flow to single wells pumping extensive aquifers. It was assumed that the aquifer was not replenished by percolating rain or irrigation water. In this section, we assume that the aquifer is replenished at a constant rate, R , expressed as a volume per unit surface per unit of time ($\text{m}^3/\text{m}^2\text{d} = \text{m}/\text{d}$). The well-flow equations that will be presented are based on a steady-state situation. The flow is said to be in a steady state as soon as the recharge and the discharge balance each other. In such a situation, beyond a certain distance from the well, there will be no drawdown induced by pumping. This distance is called the radius of influence of the well, r_e .

If more wells are used to drain an area, the pattern and spacing of the individual wells will determine the water level in the well field and the drawdown of the water level in the individual wells. Wells should be placed in such a way that the water level is lowered sufficiently everywhere in the area.

Drainage equations are presented for tubewells placed in two regular patterns:

- A triangular pattern. This is hydraulically the most favourable well-field configuration, with a maximum area to be drained by one well and with no extra drawdown induced by neighbouring wells. The disadvantage of a triangular configuration is that more length of collector drains is required to transport the water to the main collectors (see Section 22.5.2);
- A rectangular pattern, in which the wells are placed along parallel collector drains. For this well-field configuration, a minimum length of collector drains is required (see Section 22.5.2). The disadvantage of a rectangular configuration is that interference from neighbouring wells will cause extra drawdown to occur in the wells, leading to somewhat higher pumping costs.

22.4.1 Well Field in a Triangular Pattern

When the wells in a well field are placed in a triangular pattern, their individual radii of influence hardly overlap, as can be seen from Figure 22.3. The simplifying

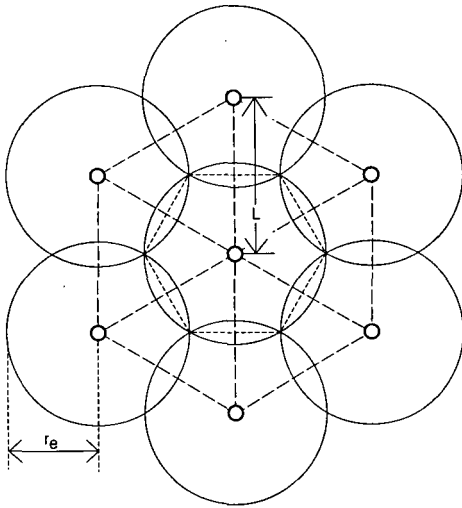

Figure 22.3 Wells located in a pattern of equilateral triangles (well spacing $L = r_e \sqrt{3}$)

assumption is then made that the discharge and the drawdown of each well will not be affected by those of neighbouring wells. In other words, the theory of a single well can be used.

In a drainage well field, there is a direct relationship between the discharge rate of the well, the recharge rate of the aquifer by percolation, and the area affected by pumping. The decline of the water level due to pumping is determined by the discharge rate of the well and the permeability and thickness of the aquifer. The discharge rate and the drawdown in the well are important factors in calculating the pumping costs of well drainage.

In an unconfined aquifer, the steady-state flow through an arbitrary cylinder at a distance r from the well is given by

$$Q_r = \pi (r_e^2 - r^2) R \quad (22.2)$$

where

r_e = radius of influence of the well (m)

R = recharge rate of the aquifer per unit surface area (m/d)

According to Darcy's law (Chapter 7), Q_r equals the algebraic product of the cylindrical area of flow and the flow velocity. Hence, the discharge at distance r from the well can also be expressed by

$$Q_r = 2 \pi r h K \frac{\delta h}{\delta r} \quad (22.3)$$

where

K = hydraulic conductivity of the aquifer (m/d)

$\delta h / \delta r$ = hydraulic gradient in the aquifer at distance r (-)

Since, in steady state, the discharge of the well, Q , equals the vertical recharge of

the area within the radius of influence, the following relationship can be used

$$Q = \pi r_c^2 R \quad (22.4)$$

Combining Equations 22.2 and 22.4 yields

$$Q_r = Q - \pi r^2 R \quad (22.5)$$

or, combining Equations 22.3 and 22.5 and separating r and h

$$\left(\frac{Q}{r} - \pi r R\right) \delta r = 2 \pi K h \delta h \quad (22.6)$$

Integration between the limits $r = r_w, h = h_w$, and $r = r_c, h = h_c$ yields

$$Q \ln\left(\frac{r_c}{r_w}\right) - \frac{1}{2} \pi R (r_c^2 - r_w^2) = \pi K (h_c^2 - h_w^2) \quad (22.7)$$

The quantity $1/2 \pi R r_w^2$ is very small in comparison with $1/2 \pi R r_c^2$ and can be neglected. If, moreover, the drawdown in the well is small in comparison with the original hydraulic head, the right-hand side of Equation 22.7 can be expressed as (Peterson et al. 1952)

$$\pi K (h_c + h_w) (h_c - h_w) \approx \pi K 2 H (h_c - h_w) = 2 \pi K H \Delta h_r \quad (22.8)$$

where

H = saturated thickness of the aquifer before pumping (m)

Δh_r = drawdown due to radial flow towards the pumped well (m)

Since, according to Equation 22.4,

$$r_c^2 = \frac{Q}{\pi R} \quad (22.9)$$

Equation 22.7 can be written as

$$\Delta h_r = \frac{Q}{2 \pi K H} \left[2.3 \log\left(\frac{r_c}{r_w}\right) - \frac{1}{2} \right] \quad (22.10)$$

If $r_c / r_w > 100$, and if we accept an error of 10%, the term $-1/2$ can be neglected and Equation 22.10 reduces to

$$\Delta h_r = \frac{2.3 Q}{2 \pi K H} \log \frac{r_c}{r_w} \quad (22.11)$$

Equation 22.11 can be used to calculate the drawdown in a well field when the wells are placed in a triangular pattern. From Figure 22.3, it can be seen that the distance L between the wells is then equal to $r_c \sqrt{3}$.

Example 22.1

In an irrigated area, it has been estimated that the average deep percolation losses resulting from excess irrigation water amount to 2 mm per day.

The hydraulic conductivity of the aquifer is $K = 25$ m/d; the thickness of the water-bearing layer is $H = 25$ m. The radius of each well is $r_w = 0.1$ m.

Suppose the wells are to be placed in a triangular pattern, 1000 m apart. What

will be the required pumping rate of each well and what will be the drawdown in each well?

According to Figure 22.3, the radius of influence will be

$$r_e = 1000 / 1.73 = 578 \text{ m}$$

The discharge rate of each well is given by Equation 22.4

$$Q = 3.14 \times 578^2 \times 0.002 = 2098 \text{ m}^3/\text{d}$$

Substituting this value into Equation 22.11 gives

$$\Delta h_r = \frac{2.3 \times 2098}{2 \times 3.14 \times 25 \times 25} \log \frac{578}{0.1} = 4.6 \text{ m}$$

The drawdown in each well is thus 4.6 m.

22.4.2 Well Field in a Rectangular Pattern

The formulas discussed so far apply only to wells forming triangular patterns. They are not applicable to wells sited in parallel lines at a distance B apart. The spacing of the wells along the lines is L , where L is considerably smaller than B (Figure 22.4).

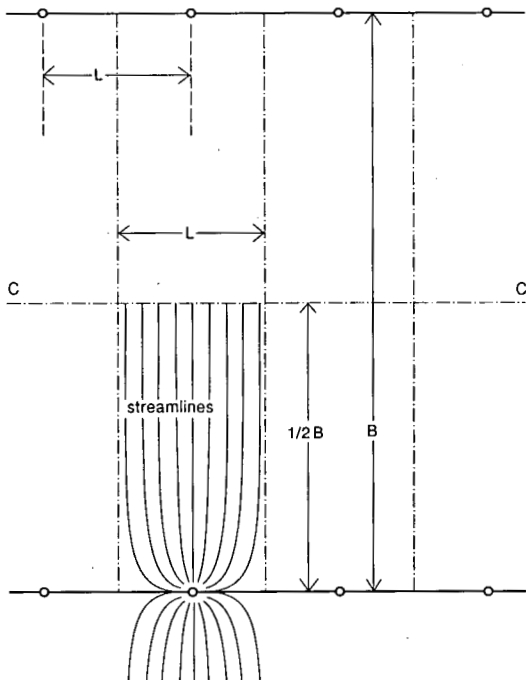

Figure 22.4 Wells in parallel series a distance B apart. Well spacing within the series is L with $L < B$ (after Edelman 1972)

In such a situation, if the recharge on the land surface from rain or irrigation water is uniform, and if the flow towards the wells has attained a steady state, the discharge of each well can be written

$$Q = R B L \quad (22.12)$$

where Q is the discharge rate of each well in m^3/d .

As parallel lines of wells show a certain analogy with parallel ditches or canals, Edelman (1972) derived an approximate solution for the drawdown at the face of each well. In both cases, the watertable is lowered along a line, which is the axis of either the line of wells or the ditch or canal. Hence the lines of wells can be replaced by ditches or canals from which a quantity q_0 (m^2/d) is extracted per unit length, so that

$$q_0 = R B \quad (22.13)$$

The maximum watertable height occurs in the symmetry axis, $C-C'$. The difference in hydraulic head (i.e. the difference between the maximum watertable elevation midway between the ditches or canals and the water level in them, also called available head) is given by (analogous to Equation 8.6 in Chapter 8)

$$\Delta h_h = \frac{R B^2}{8 K H} \quad (22.14)$$

In reality, of course, the extraction does not take place from canals or ditches, but from parallel lines of wells. As a consequence, the hydraulic head midway between the lines of wells (in the symmetry line $C-C'$) is not constant. Deviations from the average value of the head can be neglected, however, because it was assumed that the distance B between the lines is much greater than the well spacing L along the lines. As can be seen in Figure 22.4, the streamlines cross the line of symmetry, $C-C'$, almost at right angles. Hence the head midway between the lines of wells can be considered a constant, h_c . In addition, the hydraulic head in a well, h_w , is lower than the head in the canal. The energy losses are concentrated in the vicinity of the well, where the flow is radial.

For radial flow, the drawdown can be expressed as

$$\Delta h_r = \frac{2.3 Q}{2 \pi K H} \log \frac{r_c}{r_w} \quad (22.15)$$

The method of superposition can be applied to find the difference between the head at the well face and that midway between the lines of wells. Combining Equations 22.14 and 22.15 gives

$$\Delta h = \frac{R B^2}{8 K H} + \frac{2.3 Q}{2 \pi K H} \log \frac{r_c}{r_w} \quad (22.16)$$

Taking for r_c such a value that the circumference of a circle with radius r_c is equal to the length of the section through which the water flows from both sides towards the well

$$2 \pi r_c = 2 L$$

we can rewrite Equation 22.16 as

$$\Delta h = \frac{R B^2}{8 K H} + \frac{2.3 Q}{2 \pi K H} \log \frac{L}{\pi r_w} \quad (22.17)$$

Equation 22.17 can be used to calculate the head loss in a well field when the wells form a rectangular pattern. Such a pattern is recommended when surface drains in parallel lines already exist in the drainage area.

Example 22.2

Suppose that, in the same area as described in Example 22.1, the surface drains are situated 2000 m apart. Assuming the same pumping rate, what will be the distance between the wells and what will be the drawdown in each well?

According to Equation 22.12, the distance between the wells is

$$L = \frac{2098}{0.002 \times 2000} = 525 \text{ m}$$

Substituting the appropriate values into Equation 22.17 gives

$$\begin{aligned} \Delta h &= \frac{0.002 \times 2000^2}{8 \times 25 \times 25} + \frac{2.3 \times 2098}{2 \times 3.14 \times 25 \times 25} \log \frac{525}{3.14 \times 0.1} = \\ &= 1.6 + 4.0 = 5.6 \text{ m} \end{aligned}$$

The drawdown in each well is thus 5.6 m.

22.4.3 Partial Penetration

The equations presented in the previous two sections were derived under the assumption that the wells fully penetrate the pumped aquifer. Some aquifers are so thick, however, that installing a fully-penetrating well would not be justified. In these cases, the aquifer has to be pumped by a series of partially-penetrating wells.

Partial penetration causes the flow velocity in the immediate vicinity of the well to be higher than it would otherwise be, leading to an extra loss of head. According to Hantush (1964), the effect of partial penetration in an unconfined aquifer is similar to that in a confined aquifer (Chapter 2), provided the drawdown is small in relation to the saturated thickness of the aquifer, H .

Under these conditions, the formula developed for confined aquifers can also be applied to unconfined aquifers, provided the calculated additional head loss is corrected according to Jacob (see Chapter 10, Equation 10.6). In many cases, this correction would result in differences of some millimetres only and can therefore be ignored.

In view of the above, the formula for calculating the effect of partial penetration (Hantush 1964) reads

$$\Delta h_p = \frac{Q}{4 \pi K H} F \quad (22.18)$$

in which

$$F = 2 \frac{H}{p} \left[\left(1 - \frac{p}{H} \right) \ln \left(\frac{2p}{r_w} \sqrt{\frac{K_h}{K_v}} \right) - \frac{p}{H} \ln \frac{2H}{p} - 0.423 \frac{p}{H} + \ln \frac{2H + p}{2H - p} \right] \quad (22.19)$$

where

p = penetration depth of the well into the aquifer (m), assuming screening over the full depth of the well

K_h = horizontal hydraulic conductivity (m/d)

K_v = vertical hydraulic conductivity (m/d)

and the other symbols as previously defined.

So, when the wells in the proposed well field only partially penetrate the aquifer, the additional head loss calculated from Equation 22.18 should be added to the drawdowns calculated by Equations 22.11 or 22.17, depending on the actual configuration of the well field.

Example 22.3

The additional head loss due to partial penetration will only have a substantial value if the penetration ratio is relatively low. The penetration ratio is defined as the ratio of penetration depth of the well into the aquifer and the thickness of the aquifer. For that reason, the aquifer thickness is not taken as 25 m as in Example 22.1, but as 300 m.

Assuming that the wells are still 25 m deep and that the K_h/K_v ratio is 25, what will be the additional head loss due to partial penetration?

According to Equation 22.19, the factor F will be

$$F = \frac{2 \times 300}{25} \left[\left(1 - \frac{25}{300} \right) \ln \left(\frac{2 \times 25}{0.1} \sqrt{\frac{25}{1}} \right) - \frac{25}{300} \ln \frac{2 \times 300}{25} - 0.423 \frac{25}{300} + \ln \frac{2 \times 300 + 25}{2 \times 300 - 25} \right] = 24 \times 6.955 = 167$$

Substituting this factor into Equation 22.18, together with the other values, then yields

$$\Delta h_p = \frac{2098}{4 \times 3.14 \times 25 \times 300} \times 167 = 3.72 \text{ m}$$

Using Equation 22.11 with $H = 300$ m and the other parameters as given in Example 22.1, we obtain

$$\Delta h_r = \frac{2.3 \times 2098}{2 \times 3.14 \times 25 \times 300} \log \frac{578}{0.1} = 0.39 \text{ m}$$

The actual drawdown is thus $0.39 + 3.72 = 4.1$ m.

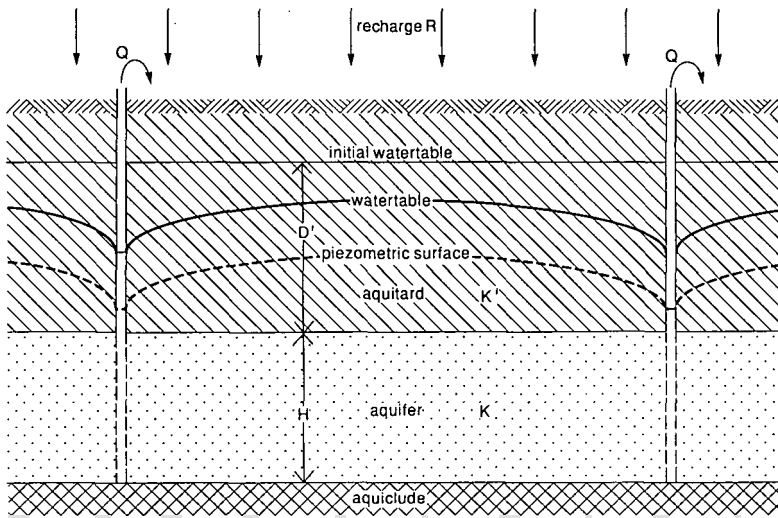

Figure 22.5 Wells in a semi-confined aquifer

22.4.4 Semi-Confined Aquifers

Figure 22.5 shows a semi-confined aquifer whose overlying layer, the aquitard, is replenished by percolating rain or excess irrigation water at a rate R . Depending on the recharge rate and the hydraulic resistance of the aquitard, a difference in head between the free watertable in the aquitard and the piezometric level of the aquifer will develop, as was described by Equation 22.1.

Under steady-state conditions, the same recharge rate will replenish the underlying aquifer. So, Equations 22.11 and 22.17 can also be used to calculate the head loss in a well field when the pumped aquifer is semi-confined.

It should be noted that, with semi-confined aquifers, Equations 22.11 and 22.17 describe the drawdown in the well with respect to the piezometric level of the aquifer. In the calculation of the total water-level depth inside the well (see Section 22.5.2), the difference between this piezometric level of the aquifer and the free watertable in the aquitard should also be considered.

22.5 Design Procedure

The design of a tubewell drainage system depends on a number of physical, technical, practical, and economic parameters. In the design procedure, the following elements can be distinguished: design considerations, well-field design, well design, and design optimization. These elements are described in the following sub-sections.

22.5.1 Design Considerations

Important design considerations are the design discharge of the tubewells, the tubewell

operating factor, the annual drainable surplus, and the peak drainage requirement. When applicable, a distinction will be made between autonomous and design factors.

Tubewell Design Discharge

The design discharge rate depends on the autonomous and design factors summarized below.

Autonomous factors are:

- The design should be based on the most economic pump capacity. If larger pumps are installed, fewer pumps will be required, which generally results in lower investment costs. On the other hand, larger capacity pumps result in higher drawdowns and thus higher energy costs. Determining pump capacities on a purely economic basis could lead to very high pumping rates. There are, however, several practical constraints to these high pump capacities;
- The selection of pumps and engines should be based on their availability on the local market; spare parts, especially, should be locally available;
- A policy of reducing the number of different pump sizes may be another major constraint on the choice of the pump capacity;
- A well with a very high pump capacity may serve a very large area that exceeds the spacing determined by other factors. If such a well were to be out of order for a prolonged period, the neighbouring wells would be overburdened, and proper drainage of the area would be impossible;
- If the water is also used for irrigation, pump capacities are often limited by the requirements of the farmers.

Design factors are:

- The annual drainable surplus and the peak requirements. The maximum tubewell capacity will influence the distance between the wells or the maximum spacing in the well field. Hence, for a given operating factor, the drainable surplus would be the determining factor for the discharge rate of the well;
- The horizontal and vertical hydraulic conductivity and the thickness of the aquifer, and the vertical resistance of the aquitard, determine the drawdown for a given discharge rate and the expansion of the cone of depression;
- Screen and casing specifications, together with the discharge rate, determine the entrance velocity of water flowing through the screen, which has a maximum value in order to ensure a maximum lifetime for the well.

Tubewell Operating Factor

The tubewell operating factor is the number of actual operating hours of the well per 24 hours, expressed as a fraction. The tubewell operating factor largely depends on autonomous factors, but also on a design factor like the peak drainage requirement, which will be described below. It will not be possible to operate all wells continuously over an extended period. Time will be lost during maintenance, inspection, and repairs, stoppage due to power failures, etc. Social factors like the presence or absence of a pump operator will also influence the possible operating factor of the wells.

Annual Drainable Surplus

The annual drainable surplus of an area is the annual discharge, in mm/day, required to maintain the design water-level criteria. It is an important design factor in well drainage. It depends on many factors, which are described elsewhere in this publication. Not all these factors apply to tubewell drainage. One such factor is the depth at which the watertable is to be controlled. This design watertable depth depends on:

- The quality of the groundwater;
- The capillary-rise potential of the soil;
- The type of cultivation;
- The type of drainage system.

From a practical point of view, too, the type of drainage system will affect the groundwater-depth criterion. In a pipe drainage project, for instance, a deeper future watertable will have a significantly greater impact on project costs than tubewells will have. Consequently, the drainage criteria and drainable surplus of a pipe drainage project are mainly based on the requirements for cultivated land. For cultivated land and bare soils, watertable depths of 1.0 to 1.5 m below the surface are widely applied, although a deeper watertable might be preferable in view of a better control of salinity and waterlogging. In fallow land, any extra capillary rise of salt is counteracted by applying extra irrigation water for leaching before the start of the seasonal cultivation of the land.

Under tubewell drainage, the requirements for the depth of the watertable are more demanding for fallow lands than for cultivated lands. When fields are cultivated, unavoidable field losses percolating through the soil profile wash the salts downward, whereas, in fallow lands, the capillary rise causes the salts to move upward, which may impair the cultivation of the next crop. As the area drained by a tubewell is relatively large (up to some 500 ha), each tubewell nearly always serves fallow as well as cultivated land. The watertable-depth criterion for drainage by tubewells should therefore be based on the requirement for fallow land.

To avoid re-salinization of the soil under fallow conditions, the groundwater should be drained to a deeper level, say 1.8 m to 2 m, depending on the type of soil (see Chapter 11), thereby increasing the drainage requirements. In principle, the same drainage depth should also be taken for pipe drainage, but the extra investment costs would make this prohibitive, so a shallower depth is applied. The deeper level is also required to offset any irregularities in the topography of the area served by the tubewell. This means that, in the field, the deeper level may be exceeded in some areas, while in others it will never be reached.

Peak Drainage Requirement

The recharge to the aquifer in an irrigation area will vary throughout the year, depending on the water supplies to the area. For an area with an annual average recharge of 1 mm/d, the minimum and maximum recharges may, for example, be 0.5 and 1.5 mm/d respectively. Other seasonal fluctuations may be due to different irrigation requirements for perennial and seasonal crops. In areas with tubewell drainage, the resulting differences in recharge cause the actual watertable depth to vary through the year. In areas where groundwater is pumped purely for drainage purposes, the seasonal fluctuations may be of the order of 0.5 m.

The peak drainage requirement is the maximum discharge, in mm/d, required for a specified drainage area. The quantification of this design factor was discussed in Chapter 17. The peak drainage rate in an area under pipe drainage may be considerably higher than the mean daily drainage rate because the diameter of drain pipes may allow a peak flow that exceeds, by several times, the annual average flow.

To maintain a stabilized watertable in tubewell drainage, the system ought to be based on the maximum expected recharge. This, however, would result in excessive investment costs. If the system were to be based on a continuous discharge to drain the annual drainable surplus at a constant rate, the watertable would fluctuate throughout the year. This variation can be reduced by adjusting the monthly tubewell operating factor (see Equation 22.20). This means higher operating factors during the periods with higher recharges and lower operating factors during the periods with lower recharges.

In areas with fresh groundwater, where the pumped water is also used for irrigation, seasonal fluctuations may be much greater, namely of the order of 1 to 3 m. If the seasonal water-level fluctuations are no impediment to agriculture and the aquifer is large enough to store the peaks in recharge by infiltrating irrigation water, the peak drainage requirements can be excluded from the design considerations.

22.5.2 Well-Field Design

The distance between the wells in the different well-field configurations can be calculated on the basis of the factors discussed in the previous section.

Well-Distance Calculation Procedure

In a tubewell field, the spacing between the wells and the well-field configuration depend on various differing design considerations, which will be discussed below.

The operating factor and the discharge rate determine how much water will be pumped by one tubewell. In combination with the drainable surplus, they determine the drainage area per tubewell and thus also the number of tubewells required for the total drainage area. This can be expressed in the following equation

$$A_w = \frac{0.1 Q t_w}{q} \quad (22.20)$$

where

- A_w = drainage area per well (ha)
- Q = discharge rate of the well (m^3/d)
- q = drainable surplus (mm/d)
- t_w = tubewell operating factor (—)

The total number of wells required can be found by dividing the total drainage area by the drainage area per tubewell. Equation 22.20 shows that the discharge rate of a well is directly related to the area that can be drained by one well, and thus determines the total number of wells required. Peak drainage requirements occurring over shorter

periods can be met by temporarily longer pumping and thus a temporarily higher tubewell operating factor.

Well-Field Configuration

Section 22.4 presented equations for different well-field configurations. For a triangular well-field configuration, the distance between the wells for a selected discharge rate can be calculated by

$$L = 100 \sqrt{\frac{3 A_w}{\pi}} \quad (22.21)$$

and for a rectangular well-field configuration with wells placed along the parallel main drains by

$$L = 10\,000 \frac{A_w}{B} \quad (22.22)$$

where

L = the distance between the wells (m)

B = the distance between the lines of wells (m). (B represents the main drains and is specified by the engineer.)

From a drainage point of view, the ideal well-field layout is the triangular grid system shown in Figure 22.6. In this system, the area of influence of a single well is a hexagon, roughly resembling a circle of the same area with an effective radius, r_e , equal to $1/\sqrt{3}$ times the distance between the wells. This configuration, however, has the following disadvantages:

- The tubewells have to be connected to the main drainage system by means of field drains, as shown in Figure 22.6. For a triangular grid, the required total length of these drains considerably exceeds that for wells placed in a rectangular grid along open main drains as shown in Figure 22.7;
- The cost of electrifying a triangular grid of tubewells is higher than for a line layout parallel to the drains;
- Additional tracks have to be constructed to the tubewells to permit the easy access needed for proper tubewell maintenance.

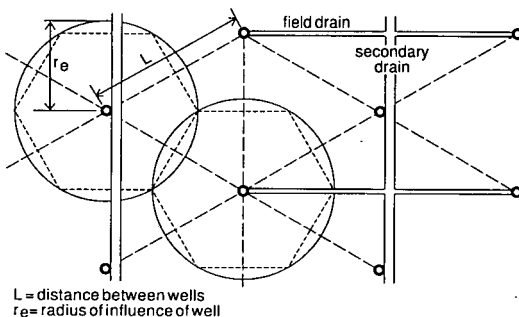

Figure 22.6 Wells in a triangular configuration with the required lay-out of field drains and main drains for the discharge of drainage water

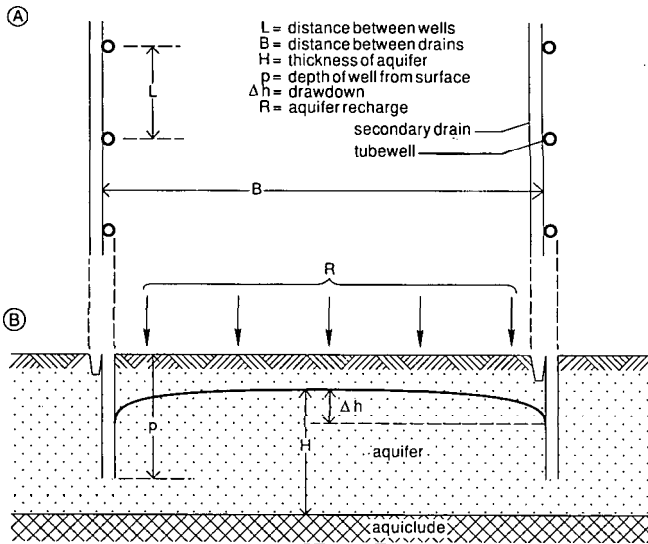

Figure 22.7 Wells in a rectangular configuration with the required lay-out of main drains for the discharge of drainage water
 A: plan view
 B: cross-section

Example 22.4

An irrigated area of 2500 ha has an annual drainage requirement of 480 mm. The drainable surplus is thus 1.5 mm/d. The maximum running hours of the pump per day are taken to be 15 hours, thus the tubewell operating factor, t_w , equals 0.63.

Suppose that, given the availability of pumps and spare parts, and a policy of reducing the number of different pump sizes, it has been decided to use three different pump capacities: 100, 200, and 300 m³/h.

According to Equation 22.20, the area drained per well for a discharge rate of 200 m³/hr is then

$$A_w = \frac{0.1 \times 200 \times 24 \times 0.63}{1.5} = 200 \text{ ha}$$

Substituting this value of A_w into Equation 22.21 gives the spacing of tubewells in a triangular well-field configuration

$$L = 100 \sqrt{\frac{3 \times 200}{3.14}} = 1382 \text{ m}$$

Substituting the value of A_w into Equation 22.22 gives the spacing of tubewells in a rectangular well-field configuration. (Assume the spacing between the main drains to be 5000 m.)

$$L = 10\,000 \frac{200}{5000} = 400 \text{ m}$$

Table 22.2 Well spacings for different pump capacities and well-field configurations

Pump capacities (m ³ /h)	Area per well (ha)	Well spacing	
		Triangular (m)	Rectangular (m)
100	100	977	200 × 5000
200	200	1382	400 × 5000
300	300	1693	600 × 5000

Table 22.2 lists the drainage area per well and the distances between the wells for both well-field configurations and for the above-mentioned three pump capacities.

22.5.3 Well Design

Knowing the discharge rate of the well and having data on lithology and aquifer characteristics (plus the dimensions and properties of available screens and casings), we can design a well.

The principle objectives of a properly designed tubewell are:

- Pumping of water at the lowest cost;
- Pumping of water that is free of sand;
- Minimum operation and maintenance costs;
- A long and economic lifetime.

A good well design depends on many factors, some of which are discussed below. More detailed information on technical well design and construction methods can be found in reference books such as those of Driscoll (1986) and Huisman (1975). Figure 22.8 shows a typical tubewell design.

Considerations on Well Depth

The total depth of a tubewell is determined by the lengths of the pump housing, production casing, screen section, and sand trap (Figure 22.8). The following points should be considered:

- The length of the pump housing should be chosen so that the pump remains below the water level in the well, for the selected discharge rate, under all conditions, and over the total lifetime of the well;
- The length of the production casing (i.e. the section of blind pipe between the bottom of the pump housing and the top of the aquifer) depends on the actual thickness of the aquitard overlying the aquifer. The production casing is not required in unconfined aquifers at shallow depth where the pump housing penetrates deep enough into the top section of the aquifer;
- The length of the screen section depends on the required total screen length and the total length of sections of blind pipe to case off unproductive layers in the aquifer;
- The length of the sand trap (i.e. the section of blind pipe at the bottom of the screen section) is usually of the order of a few metres.

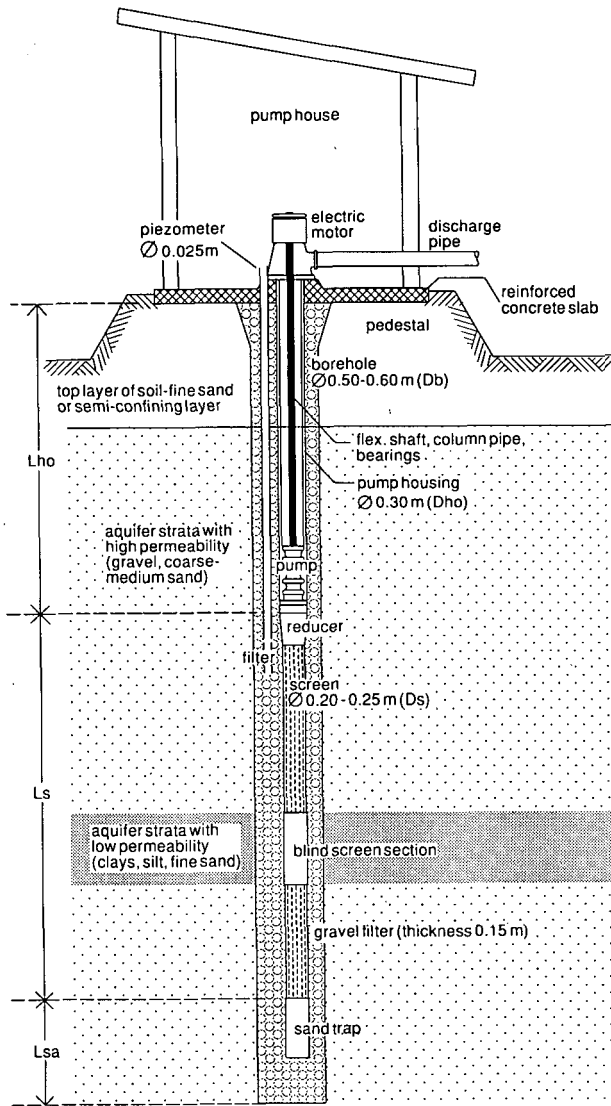

Figure 22.8 Typical design of a tubewell

Considerations on Well Diameter

The diameter of the well depends on the following:

- In the upper section, on the diameter of the pump housing and some angular space, say 25 mm, all around the casing;
- Below the pump-housing, on the diameter of the production casing, if required;
- In the screen section, on the diameter of the screen. Twice the thickness of the gravel pack should be added to this value. For reasons of construction, the minimum thickness of the gravel pack should be 75 mm;
- The diameter of the sand trap is usually the same as that of the screen section.

The purpose and design of these well sections, and their position in the well, will be discussed below.

Pump Housing

The pump housing is the upper section of blind casing that supports the well against collapse, and in which the pump is installed. The length and diameter of the pump housing should be such that it can accommodate the pump at the required depth throughout the lifetime of the well. A pump housing is always required when submersible pumps are used. No special pump housing is required in the case of a shallow watertable with little drawdown where suction pumps can be used; both pump and engine are installed at the surface beside the tubewell.

The actual length of the pump housing is primarily determined by the required depth of the pump. The location of the pump depends on the expected depth to which the water level inside the well will drop for the selected design discharge rate. This water-level depth inside the pumped well depends on the following factors:

- The required design depth to the watertable for the selected discharge rate (see Chapter 17);
- The difference in head between the watertable in the overlying aquitard and the piezometric head in the pumped aquifer when the aquifer is semi-confined;
- The formation losses;
- The well losses;
- The seasonal fluctuations of the watertable, especially when the groundwater is used for irrigation;
- A safety margin.

The difference in head between the free watertable in the overlying aquitard and the piezometric head of the pumped aquifer is determined by the hydraulic resistance of the aquitard. Depending on the actual recharge rate (= drainable surplus), Equation 22.1 can be used to estimate this head loss. It will be clear that this component is not present in unconfined aquifers.

The formation losses are the head losses due to the laminar flow of water to the well, and are determined by the hydraulic conductivity and thickness of the aquifer. Depending on the actual well-field configuration, Equations 22.11 and 22.17 can be used to estimate these losses. With partially-penetrating tubewells, the additional head loss according to Equation 22.18 should be added to the formation losses.

The well losses are the head losses due to turbulent flow in and around the pumped well, and due to a reduced hydraulic conductivity of the aquifer in a zone immediately surrounding the well. This zone is called 'skin' or 'zone of damage'. It is created by the invasion of drilling fluids, the dispersion of clays, the presence of a mud cake, partial penetration, or the clogging of screens. The total well losses consist of head losses in the gravel pack, head losses due to the partial perforation of the screen, and friction losses inside the well. Their calculation is rather complicated; Huisman (1975) presented methods to estimate these expected well losses.

It should be noted that, in principle, the well losses can also be determined from a special type of well test, 'the step-drawdown test', which has been described by Kruseman and De Ridder (1990), among others. This method cannot be used here, however, because the wells to be designed for the well field will usually be different

in design from the already existing ones for which the step-drawdown tests were made.

The depth of the pump is determined by the maximum depth of the water level during pumping over the total lifetime of the well, plus the length of the pump and the engine, plus a safety margin of several metres.

The diameter of the pump housing should be large enough to accommodate the pump with clearance of approximately 25 mm all around the pump for its installation and efficient operation. The diameter of the pump depends on the selected discharge rate and the pump type.

Production Casing

The production casing is the section of blind pipe between the bottom of the pump housing and the top of the aquifer. The production casing is not required in unconfined aquifers at shallow depth where the pump housing reaches sufficiently deep into the top section of the aquifer, which is usually the case in drainage projects. The length of the production casing depends on the thickness of the aquitard overlying the pumped aquifer. The diameter of the production casing:

- Is smaller than the diameter of the pump housing;
- Is larger or equal to the diameter of the underlying screen section;
- Must be sufficient to ensure that the upward velocity of pumped water in the casing is less than 1.5 m/s.

Screen Section

A screen has to perform the following functions in a well. It should:

- Support the wall of the well against collapse;
- Prevent sand and fine material from entering the well during pumping;
- Secure a low head loss of water flowing through the slot openings and through the screen;
- Provide resistance to chemical and physical corrosion by the pumped water.

To achieve the above, the screen should have the following properties:

- A large percentage of open area to minimize the head loss and entrance velocity;
- Sufficient column strength to prevent collapse;
- Non-clogging slots;
- Be resistant to corrosion;
- A minimum encrusting tendency.

It is not always possible to combine all these properties. For example:

- An increase in the open area of a screen weakens its column strength;
- PVC and fibreglass screens are lighter and more resistant to corrosion by chemically aggressive water, but have a lower collapse strength than steel screens and casings. In practice, PVC and fibreglass-reinforced screens and casings will be technically and economically attractive in drainage wells in alluvial aquifers, where wells are placed at moderate depths of up to 400 m. Steel screens are required in deep wells drilled in hardrock aquifers. Stainless steel screens combine both strength and resistance to corrosion and chemically aggressive water, but are more expensive;
- The open area of conventional slotted screens should not exceed approximately

10% so as not to weaken the column strength. More expensive continuous slot screens of stainless steel or modern PVC screens have an open area of 30 to 50%, thereby reducing the length of screen required for the minimum entrance velocity. This property is especially important in thin aquifers with a high hydraulic conductivity. If a screen with a relatively low open area is applied in such aquifers, the productivity of the aquifer will ensure a high yield, but the required entrance velocity may limit the maximum allowable pump capacity.

The selection of the screen slot size depends on the type of aquifer and the use of a gravel pack. The screen slot size must be selected so as to ensure that most of the finer materials in the formation around the borehole are transported to the screen and removed from the well by bailing and pumping during the well-development period immediately after the borehole has been constructed and the screen and casing have been installed.

In wells without an artificial gravel pack, well development creates a zone of graded formation materials extending about 0.5 m outward from the screen. Driscoll (1986) and Huisman (1975), among others, give detailed procedures for selecting the correct slot size. They report that with good quality water and the correct slot opening, 60% of the material will pass through the screen and 40% will be retained. With corrosive water the 50%-retained size should be chosen, because even a small enlargement of the slot openings due to corrosion could cause sand to be pumped.

The screen length should be chosen so as to ensure that the actual screen entrance velocity is in accordance with the prescribed entrance velocities as listed in Table 22.3 for the different hydraulic conductivity values of the aquifer.

From these screen entrance velocities, the minimum length of the well screen can be calculated with

$$Q = 86400 v_e l_{\min} A_0 \quad (22.23)$$

where

- Q = discharge rate of the well (m³/d)
- v_e = screen entrance velocity (m/s)
- l_{min} = minimum screen length (m)
- A₀ = effective open area per metre screen length (m²/m)

Table 22.3 Recommended screen entrance velocities (U.S. EPA 1976)

Hydraulic conductivity of aquifer (m/d)	Screen entrance velocities (m/s)
> 250	> 0.03
250 - 120	0.03
120 - 100	0.025
100 - 40	0.02
40 - 20	0.015
< 20	< 0.01

In determining the effective open area per metre screen length, it is assumed that 50% of the actual open area is clogged by gravel particles (Huisman 1975). The actual open area per metre screen length depends on the type and diameter of the selected screen type (Example 22.5). The minimum total length of the well screen is one of the most important criteria in well design.

The optimum length of the screen may differ from its minimum length. Determining the optimum screen length is rather complex. It depends on:

- All the cost factors that determine the costs of pumping 1000 m³ or draining 1 ha;
- The total thickness of the aquifer. In very thick aquifers, the deeper penetration of the well results in a smaller drawdown, which reduces the pumping costs but increases the investment costs in the borehole;
- The selected pumping rate and the system's other design and operating factors.

Finally, the total length of the required screen section is found by adding to the actual screen length, as determined above, the total length of sections of blind pipe used to case off unproductive layers in the aquifer. The total length of blind pipe depends on the distribution of hydraulic conductivity in the aquifer (i.e. the distribution of layers of higher and lower hydraulic conductivity). This stratification can be determined from the driller's log, geophysical logs, and sieve analysis.

The diameter of the screen, like the length and open area of the screen, depends on the pumping rate and the permissible entrance velocity, and, in shallow aquifers, on the thickness of the aquifer. The diameter of the blind pipes in the screen section is usually the same as that of the screen diameter.

Example 22.5

To determine the total depth of a tubewell, we shall use the data of Example 22.2.

The length of the pump housing is based on the requirement that the pump remains below the water level inside the well. Suppose that the required design depth to the watertable is taken to be 2 m. The formation losses are added to this value. If the seasonal and long-term fluctuations of the watertable are estimated at 4 m and an additional length of 5 m is added for safety, the length of the pump housing becomes

$$2 + 5.6 + 4 + 5 = 17 \text{ m}$$

The screen length is primarily determined by the maximum screen entrance velocities. With a hydraulic conductivity of 25 m/d, this value, according to Table 22.3, is 0.015 m/s.

Suppose that a well screen is selected with an open area of 20% and a diameter of 0.25 m, we would then find the effective open area per metre screen length, bearing in mind a clogging percentage of 50%, to be

$$A_0 = 3.14 \times 0.25 \times 0.5 \times 0.20 = 0.08 \text{ m}^2/\text{m}$$

Substituting the above values into Equation 22.23 for a pumping capacity of 200 m³/h = 4800 m³/d yields

$$l_{\min} = \frac{4800}{86400 \times 0.015 \times 0.08} = 47 \text{ m}$$

Assuming that the percentage of blind pipe to screen off unproductive layers of clay, silt, and very fine sand can be taken as 25%, the total length of the screen section becomes $47 \times 1.25 = 59$ m.

The total depth of the tubewell, together with a sand trap of 5 m, then becomes $17 + 59 + 5 = 81$ m.

Table 22.4 shows the minimum length of screen (section) and the total tubewell depth for screen diameters of 0.15, 0.20, and 0.25 m, and for different types of screens:

- Cheap well screens with an open area of 10%;
- Medium-priced well screens with an open area of 20%;
- Expensive, modern, continuously slotted well screens with an open area of up to 40%.

The total well depth in Column 6 consists of the pump house length (17 m), the screen length as calculated in Column 5, and the sand trap length (5 m).

Table 22.4 shows that tubewells with cheap screens (low percentages of open area) should be placed considerably deeper than tubewells with expensive screens (high percentages of open area). Taking into consideration the costs of drilling boreholes, it will be clear that wells with cheap screens are not necessarily cheaper to construct than wells with expensive screens.

The situation is more complicated with partially-penetrating tubewells. The deeper the well, the larger the penetration ratio, and the less the partial-penetration effect in the total drawdown inside the well will be.

In making the cost comparison, one should consider not only the construction, but also the costs of lifting the water to the land surface (i.e. the actual depths of the water level inside the well).

The last point to note is that Table 22.4 refers to a pump capacity of 200 m³/h. Similar calculations should be made for the other two pump capacities (i.e. 100 and 300 m³/h).

Table 22.4 Minimum screen lengths and total well depths for different types of screens (see Example 22.5)

Diameter (m)	Open area		Screen section Eq. 22.23 + 25 %		Total well depth (m)
	(%)	(m ² /m)	(m)	(m)	
(1)	(2)	(3)	(4)	(5)	(6)
0.15	10	0.024	157	197	219
0.15	20	0.047	79	98	120
0.15	40	0.094	39	49	71
0.20	10	0.031	118	147	169
0.20	20	0.063	59	74	96
0.20	40	0.126	29	37	59
0.25	10	0.039	94	118	140
0.25	20	0.079	47	59	81
0.25	40	0.157	24	30	51

Gravel Pack

The application of a gravel pack is recommended in the following formations:

- Fine sandy alluvium and aeolian sand aquifers;
- Alternating formations of fine, medium, and coarse sediment;
- Poorly cemented sandstone continuously losing fine material during pumping and giving no support to the screen because the formation does not fill up the angular space between the screen and the borehole wall supporting the screen immediately after the screen has been installed.

The selection of grading and grain size of the gravel pack depends on the sieve analysis of the finest layer included in the screen section in the productive part of the aquifer. Even finer portions of the aquifer are cased off with a blank pipe.

The rules for the proper design of the gravel pack, and for when to use single or double layers of different grading as gravel pack, will not be discussed here, but can be found in literature (e.g. in Huisman 1975 and Driscoll 1986).

Sand Trap

The sand trap is the section of blind pipe at the bottom of the screen section. Its function is to store sand and silt entering the well during pumping; this will occur even if the tubewell has been properly developed. The length of the sand trap is usually of the order of a few metres (2 – 6 m). The diameter of the sand trap is usually the same as that of the screen section.

Pump

The following factors determine the selection of the pump:

- The required discharge rate;
- The required head to be delivered by the pump. This head is made up of three parts:
 - The difference between the elevation of the discharge pipe into the drain and the natural surface level;
 - The water-level depth inside the pumped well, as discussed in Section 22.5.3;
 - Head losses due to friction and turbulence in the discharge pipelines between the pump and the drain;
- The efficiency of the pump;
- Pump durability. To keep maintenance and replacement costs to a minimum, the pump should be resistant to wear and to the corrosive action of the drainage water that will be pumped;
- In wells where the maximum water-level depth below the pump during pumping does not exceed 5 – 7 m, a suction pump, generally a centrifugal type of pump, can be used (Chapter 23). With deeper water levels during pumping, deep-well submersible pumps are required.

As will be discussed in Chapter 23, Section 23.2.2, the power requirement at the pump shaft is defined by

$$P_s = \frac{\rho g Q H}{\eta} \quad (22.24)$$

where

P_s = power to be delivered to the shaft of the pump (W)

Q = pump discharge (m^3/s)

H = head delivered by the pump (m)

ρ = density of water (kg/m^3)

g = acceleration due to gravity (m/s^2)

η = pump efficiency (—)

Operating conditions being equal, the more efficient the pump, the lower the power requirements for pumping, and hence, the lower the pumping costs. Pump efficiency therefore becomes an important consideration when a pump is being selected because pumping costs usually play an important role in the economic viability of tubewell drainage.

Pump efficiency depends on the head-discharge relation and varies from one type of pump to another, and sometimes from manufacturer to manufacturer.

22.5.4 Design Optimization

The choice of the drainage method and the design of the drainage system are based on minimizing the cost of drainage. For tubewell drainage, this means properly selecting the well-field configuration and optimizing the borehole design so as to bring the groundwater to the land surface in the most economic way. Some optimizing options are:

- Water can be brought to the land surface by a well with a short screen or a long screen. A short screen involves low investment costs and high energy costs because of greater drawdowns in the wells, while a long screen entails relatively higher investment costs but lower energy costs (see Figure 22.9).
- The well can also have either a small-diameter screen (lower investment costs, high energy costs) or a large-diameter screen (high investment costs, low energy costs).

The optimization procedure involves examining the different well configurations that satisfy the design criteria, and, for each of these, calculating the investment costs and the annual costs of operation and maintenance. The present value of these costs is determined by applying an annual rate for discounting costs and an interest rate. The configuration that yields the lowest present value is then selected.

The steps to calculate the investments costs for a well with a pre-fixed pumping capacity and located in a given well-field lay-out can be summarized as follows:

- The well spacing and area of influence of each well is determined on the basis of the drainable surplus of the area in question, the discharge rate, and the maximum pumping hours per day;
- The minimum screen length is determined for the smallest screen diameter available and cheapest screen type, so consequently the lowest percentage of open area, in accordance with the criteria in Section 22.5.3;
- The pumping head, including drawdowns caused by the different factors discussed in Section 22.4.3, is calculated;

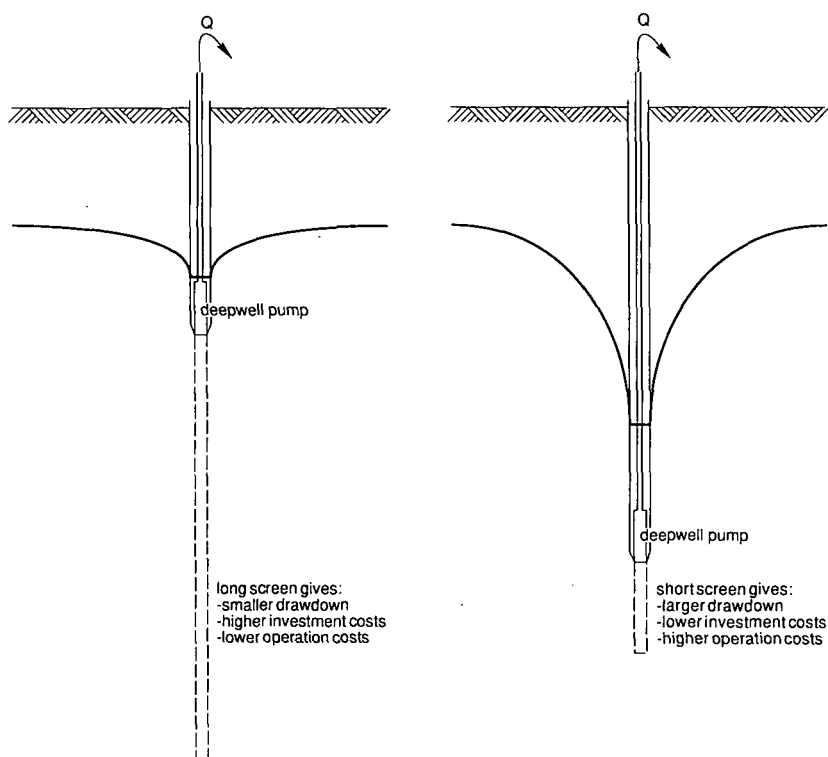

Figure 22.9 Alternative well designs regarding screen length

- The diameter and length of the pump housing, pump setting, and length of casings are selected according to pre-determined criteria;
- Drilling diameters are selected according to pre-determined criteria, and the volume of filter gravel is determined;
- The minimum motor capacity is determined and the smallest motor that exceeds this minimum capacity is selected;
- The investments costs (supply and installation) are calculated with unit rates;
- Other cost components, such as motor house, operator's quarters, costs of power distribution or fuel, and required water courses, are added to the investment costs;
- Annual pumping costs are calculated by totalling all annual costs, including investments, re-investments, energy, and the maintenance and operation of the well pump and engine and of the drainage system;
- Total costs are discounted and the present value is assessed by totalling the annual discounted costs. This value is converted into an annuity and an even cash flow. Finally, the annuity is divided by the quantity of water abstracted per annum, which results in the cost per m^3 drainage water or the costs to drain 1 ha;
- This procedure is repeated for longer screens, larger screen diameters, and other available energy types until the cheapest configuration is found.

Optimization means finding the tubewell design that drains the farmer's fields at the

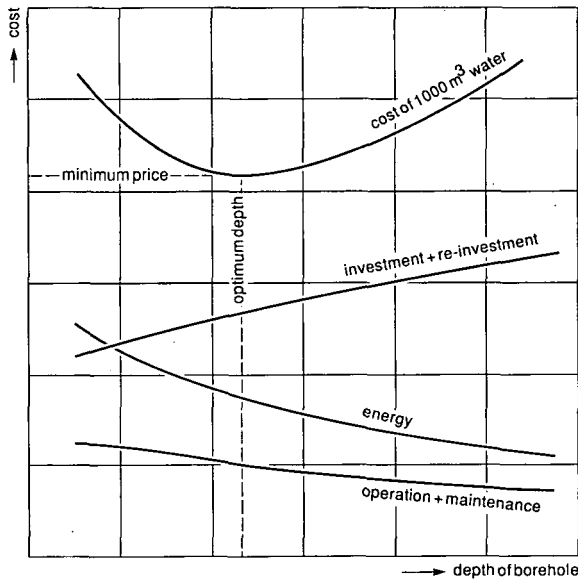

Figure 22.10 Costs of 1000 m³ water as a function of borehole depth

lowest price. With increasing screen lengths, investment costs rise but the drawdown and the pumping costs fall. The cost per m³ of water first decreases, owing to the decreasing head losses caused by the decreasing partial penetration of the aquifer, and consequently leads to lower pumping costs. Having reached a minimum, the price of water rises because the decreasing energy costs in the borehole no longer compensate for the higher investment costs. The calculations are repeated for different screen diameters, screen types, pump engine, and types of energy. Figure 22.10 shows the relation between the cost of water, investment and re-investment costs, energy costs, and operation and maintenance costs.

Finally, the design with the lowest costs per m³ drainage water is selected. Obviously, the more types of screens, engines, pumps, and energy available, the better the results of the optimization procedure will be. The number of calculations required to arrive at a final result is large and complex and can best be handled by an optimum well-field-design computer program.

22.6 Maintenance

22.6.1 Borehole

The performance of a well usually declines after some years of operation, resulting in higher drawdowns and higher pumping costs. The well is in need of rehabilitation when the specific capacity of the well (i.e. the yield of the well per metre drawdown) becomes so small that the pumping costs increase or the discharge rate of the well can no longer be maintained. Before that time, the well needs to be rehabilitated.

A detailed description of the causes of well deterioration and measures for well rehabilitation will not be presented here, but can be found in literature (e.g. Driscoll 1986).

An effective well-maintenance program begins with good records being kept of the well's construction, including good records of the geological conditions, the position and types of aquifers and aquicludes, water quality, and the specific capacity of the well, determined during well testing. In an irrigation-drainage project, storage of these data in the operating agency's computer data bank is a highly recommended investment.

Every type of well requires its own maintenance program. To evaluate the performance of a well, Driscoll (1986) gives the following checklist:

- What is the static water level in the well?
- After a specified period of pumping, what is the pumping rate and the water level expressed as specific capacity, and what is the ratio of the pumping rate and the drawdown?
- What is the sand content of the pumped water?
- What is the total depth of the well?
- What was the original specific capacity of the well?

A significant decrease in specific capacity or an increase in the pumping of sand indicates that the well needs rehabilitation or restoration to its original performance. In general, rehabilitation measures are most successful when the well performance has not deteriorated too badly, or the specific capacity has not decreased too much. If the specific capacity of the well has declined by 25%, it is time to carry out a rehabilitation program.

In order to determine the right moment for well rehabilitation, periodic monitoring of well performance should be done in the term of short standard tests. Complete well records can be kept at relatively minor expense, and these are indispensable in determining the causes of well failure and selecting the maintenance and rehabilitation program.

The major causes of a reduction in well performance are:

- A reduced well yield due to chemical encrustation or clogging of the screen due to bacteriological activity;
- Plugging of the formation around the well screen by fine particles of clay and sand in the pores;
- Pumping of sand due to poor well design or corrosion of the well screen;
- Collapse of the well screen due to chemical or electrolyte corrosion of metal well screens.

Chemical and biological encrustation are major causes of well failure. Water quality and flow velocity through the screen openings determine the occurrence of encrustation. Chemical encrustation is caused by the precipitation of carbonates, mainly calcium carbonate, or iron hydroxides, which block the screen openings. Carbonate precipitation is caused by the release of carbon dioxide from the water owing to a pressure decline in the water caused by the drawdown in the well.

Iron dissolved in groundwater may precipitate from the water on the well screen because oxygen is introduced into the water when the well is pumped. Another reason for the precipitation of iron may be the presence of iron bacteria in the water.

The complete prevention of encrustation of well screens is impossible. The process can be retarded by low flow entrance velocities through the well screen openings (see Table 22.3), lower pumping rates, and longer pumping times per day.

Chemical encrustation can best be removed by treating the well with a strong acid solution that chemically dissolves the encrusting materials so that they can be removed from the well by pumping. Hydrochloric acid and sulphuric acid can be used.

Chlorine, a strong oxidizing agent, inhibits the growth of iron bacteria. The use of hypochlorite is a relatively safe and convenient alternative to chlorine gas. The occurrence of iron bacteria in wells can be prevented by disinfecting the well and the pump immediately after installation.

Physical plugging by clay and silt particles can best be prevented by proper well development after the well screen has been installed. The removal of fine particles from the formation immediately around the screen can best be achieved by washing and brushing the screen with dispersing compounds such as sodium tripolyphosphate (STP) and other types of polyphosphates.

The corrosion of well screens can severely reduce the lifetime of a well. Chemical corrosion occurs especially when metal well screens are used in aggressive and saline water loaded with gasses like hydrogen sulphide, carbon dioxide, and oxygen. Corrosion can be prevented by applying non-metal screens or, when the water is not aggressive, only metal screens of stainless steel and low-carbon steel.

22.6.2 Pump and Engine

To pump water from a tubewell in the most economic way, the sound operation of pumps and engines is a prerequisite. For pumps to operate properly under less than ideal physical and chemical conditions, and especially when pumping brackish and saline drainage water, they must be properly maintained. Pump and engine manufacturers prescribe periodical maintenance of their products. A complete analysis of pump and engine maintenance is beyond the scope of this book, so readers are referred to the maintenance procedures specified by manufacturers. Maintenance procedures depend on the pump type. They include the adjustment and replacement of impellers, bearings, stuffing boxes, and bowl assemblies.

Decreases in discharge rates are caused by the wearing of parts in the pump and by leakage in the pipes bringing the water to the surface. Only a few problems relating to deficiencies in well design will be discussed in this section. Driscoll (1986) gives the following checklist to determine the condition of the pumping unit in vertical turbine and submersible pumps:

- Do the water pressure and the discharge rate of the well deviate from the original design curve of the pump?
- Is the motor over-heating?
- Is there an unusual sound like a higher bearing-noise level?
- Is the motor using more oil?
- Is there excessive vibration?

- Is there a change in the ampere or voltage load to the pump?
- Is there any cracking or uneven settling of the floor around the pump?
- Is there sand in the pumped water?

Sand pumping causes the abrasion of pump bowls, which leads to failure of the pump.

Sand pumping results from:

- Over-sized slots in screens;
- Over-sized filter pack;
- Corrosion of the well screen;
- Inadequate development of the well;
- Too high entrance velocities, causing the transport of sand from the formation towards the well.

One of the above conditions, or a combination of them, results in sand from the formation entering the well. Remedying this problem may be uneconomic. It may be better to drill a new well. The best alternative, if possible, is to replace the screen or to place an inner screen inside the original well screen.

Pumping bowls may be damaged by cavitation due to the occurrence of bubbles of water vapour in the water. This causes pitting of the impeller. To prevent the destruction of impeller vanes by cavitation, pumps should be run at flow rates close to their maximum efficiency.

The corrosion of pumps and column pipes or rising mains by chemically aggressive groundwater damages the pumps and causes pipes to leak. Choosing pumps built of materials resistant to the quality of the water they pump should prevent this corrosion problem. Other measures may be the use of galvanic cells between steel shafts and impellers.

Overload conditions that lead to over-heating of the motor and excessive vibration may be caused by poorly adjusted impellers. Bearing wear may be caused by misalignment and the improper installation of the shafts.

References

- Calvert, R.C. and R.F. Stoner 1975. Khairpur tubewell project. Pumping groundwater for irrigation and drainage. ICID, Ninth Congress Irrigation and Drainage, Moscow. Q.32, R.8, 32.2, pp. 107-134.
- Dempster, J.I.M. and R.F. Stoner 1969. Methods of operating tubewell projects. ICID, Seventh Congress Irrigation and Drainage, Mexico City. Q.25, R.11, p.25, pp. 136-149.
- Driscoll, F.G. 1986. Groundwater and wells. St. Paul, Johnson Division, Minnesota, 1089 p.
- Edelman, J.H. 1972. Groundwater hydraulics of extensive aquifers. ILRI Bulletin 13, Wageningen, 216 p.
- Hantush, M.S. 1964. Hydraulics of Wells. In: Advances in hydroscience, 1, pp. 281-432.
- Huisman, L. 1975. Groundwater recovery. 2nd ed. MacMillan, London, 336 p.
- Kruseman, G.P. and N.A. de Ridder 1990. Analysis and evaluation of pumping test data. ILRI Publication 47, Wageningen, 377 p.
- McCready, W. 1978. Drainage construction techniques for vertical tubewell drainage. ICID, New Delhi, 46 p.
- Nespak-ILACO 1983. Panjnad-Abbasia salinity control project. Pre-Feasibility Study on Tile and Tubewell Drainage for Unit V. Lahore.
- Nespak-ILACO 1985. Panjnad-Abbasia salinity control and reclamation project. Optimum well and well-field design report, Lahore.

- Peterson, D.F., O.W. Israelson and V.E. Hansen 1952. Hydraulics of wells. Bulletin 351. Utah Agricultural Experimental Station, 48 p.
- The White House 1964. Report on land and water development in the Indus Plain. The White House, Department of Interior, Panel on Waterlogging and Salinity in West-Pakistan, Washington D.C., 454 p.
- U.S. Environmental Protection Agency 1975. Manual of water well construction practices. EPA-570/9-75-001. Office of Water Supply, Washington D.C. 156 p.

23 Pumps and Pumping Stations

J. Wijdieks¹ and M.G. Bos²

23.1 General

Many agricultural areas are located along a river or in the vicinity of a lake or sea. Frequently, the required drainage water levels in these areas are lower than the water level of the river, lake, or sea. Under such circumstances water cannot be drained out of the area by gravity flow, but must be pumped out.

Thousands of years ago, the ancients had already developed water-lifting devices for use in irrigation. Men, beasts, and in some cases running water provided the driving force. With the water-powered types, lifts as high as 15 m were possible. Some of these devices, such as the water wheel and the Archimedean screw, are still in use today in their original form (see Figure 23.1).

For hundreds of years, the use of water-lifting devices was limited because they could not be connected to a pressure pipe. This limitation was overcome by the introduction of the impeller pump. The first known operational impeller pump was used in a Portuguese copper mine in the 15th century, it is now on exhibit in the Musée du Conservation National des Arts et Métiers in Paris.

The aim of this chapter is to provide the design engineer with basic information on pump performance characteristics; information that will enable him to make a

¹ Delft Hydraulics Laboratory

² International Institute for Land Reclamation and Improvement



Figure 23.1 The ancient Archimedean screw

first estimate of the number and the dimensions of the pumps he will need, and will provide him with a sound basis for choosing the right pump for the job.

23.2 Pump Types

Essentially, every pump consists of two parts: a rotating part called a runner or impeller, and a stationary part called a casing or housing. When power is applied to the shaft of the runner, water can be displaced (as with an Archimedean screw), or can be forced into a rotary motion and led away under pressure (as with an impeller pump). Rotating impeller pumps are classified by the direction in which the water flows through the impeller. The three possible types are: the radial-flow (or centrifugal) pump, the mixed-flow pump, and the axial-flow pump.

Each type of water-lifting device has specific characteristics which fit it for specific operating conditions.

23.2.1 Archimedean Screw

Description

The modern Archimedean screw (Figure 23.2) is based on the ancient device. It can lift large volumes of water against low heads, and so is popular for use in drainage systems in flat countries like The Netherlands.

Basically, the screw consists of an inclined shaft to which one or more helically wound blades are attached. This spiral is fitted into a semi-circular casing. When the screw is rotated, the water confined between two successive blades, the wall of the casing, and the shaft is lifted.

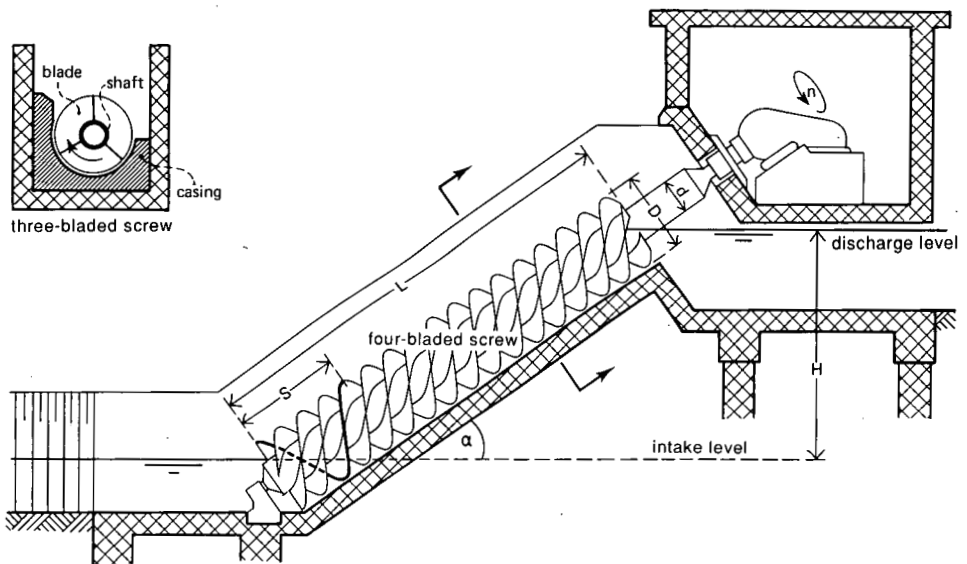

Figure 23.2 Archimedean screw, open type (from Hydro Delft 1972)

The screw has the following advantages over the impeller pump:

- The rotational speed of the screw is low, varying from 1/3 revolutions per second (rev/s) for large diameter screws to 2 rev/s for small diameter screws, hence wear is negligible and no cavitation will occur (see Section 23.4);
- The opening between two successive blades is relatively large, so the screw is able to handle relatively trash-laden water;
- The flow distribution on the suction side of the screw does not influence the hydraulic behaviour; hence simple suction basins are possible;
- Above a certain suction level (filling point), the discharge remains constant while efficiency remains favourable;
- Below a certain suction level, the discharge decreases while the efficiency remains favourable;
- The screw can turn continuously without risk of damage, even when the water supply stagnates;
- The screw has an open construction which makes it possible to inspect the entire lifting operation;
- In some instances the foundation of the screw need not be as deep as that of an impeller pump.

On the other hand, the screw has the following disadvantages compared with the impeller pump:

- The dimensions of the screw are larger than those of impeller pumps. This is necessary because the water pressure remains atmospheric during the lifting process;
- The screw's capabilities are restricted to pumping from one free surface 'reservoir' to another free surface 'reservoir'. Any connection to pressure piping is impossible;
- To operate with reasonable efficiency, the intake level should be above a certain value;
- Discharge levels must remain within a narrow range. Too high a level leads to backflow over the outer rim of the blades. Too low a level means that the water is lifted needlessly high;
- The whole structure must be rigid to keep the clearance between the rotating screw and the casing small, and thus prevent backflow;
- For reasons of safety the screw must be covered.

In general, the Archimedean screw is suitable as a water-lifting device provided that both the intake and discharge levels remain within narrow limits (Photo 23.1).

Discharge Characteristics

The discharge delivered by the screw is proportional to the quantity of water between two successive blades turned 360° , the number of blades on the screw (x), and the number of revolutions of the screw per unit of time (n). The quantity of water between two successive blades depends on the outer diameter of the screw (D), the diameter of the shaft (d), the pitch of the blades (S), and the angle of inclination of the shaft (α). This leads to the following basic formula for the discharge of a screw

$$Q = k \times n \times D^3 \quad (23.1)$$

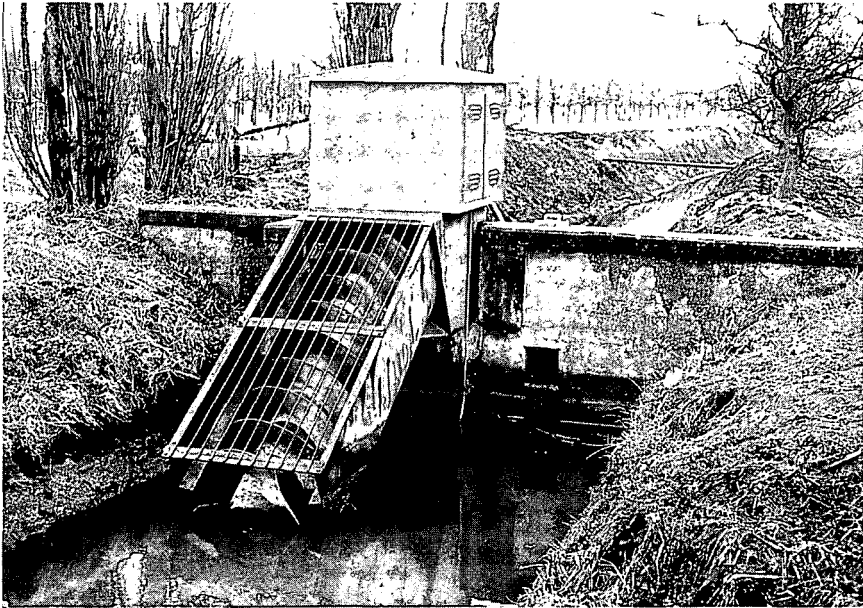

Photo 23.1 Small Archimedean screw in a drainage canal

in which

Q = discharge (m^3/s)

n = number of revolutions (rev/s)

D = outer diameter of the screw (m)

k = constant, which depends on the shape of the screw characterized by S/D , d/D , and the inclination of the screw characterized by α (dimensionless)

Values of k for screws with three or four blades are given in Table 23.1. Such multi-bladed screws can achieve capacities of up to $5 \text{ m}^3/\text{s}$. A head of 10 m is possible with a modern screw. To attain more head, intermediate bearings can be applied or structures with two screws in series can be used.

The hydraulic behaviour of a screw is described by the discharge versus intake-level characteristic and the hydraulic-efficiency versus intake-level characteristic (see Figure 23.3). Both refer to an optimal discharge level as indicated above.

Table 23.1 k values for three- and four-bladed screws

d/D	$\alpha = 22^\circ$		$\alpha = 26^\circ$			$\alpha = 30^\circ$	
	$S = 1.0D$	$1.2D$	$0.8D$	$1.0D$	$1.2D$	$0.8D$	$1.0D$
0.3	0.331	0.335	0.274	0.287	0.286	0.246	0.245
0.4	0.350	0.378	0.285	0.317	0.323	0.262	0.271
0.5	0.345	0.380	0.281	0.317	0.343	0.319	0.287
0.6	0.315	0.351	-	0.300	0.327	-	0.273

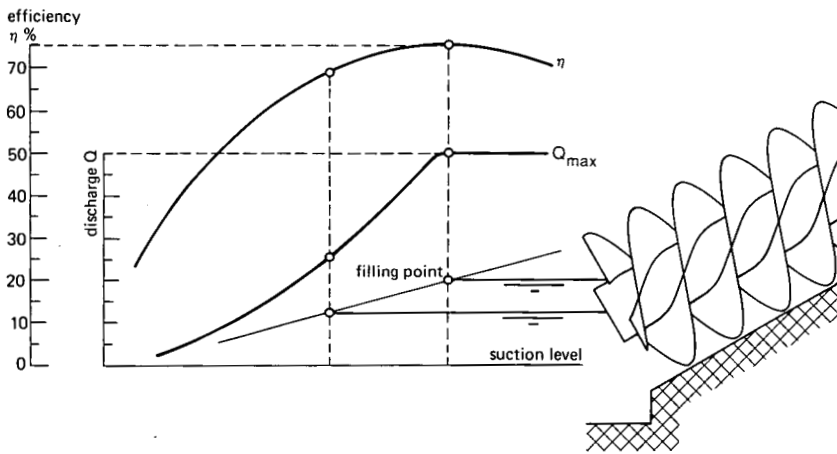

Figure 23.3 Discharge and efficiency versus intake level

The ratio between the hydraulic output power and the shaft mechanical input power is called the efficiency, which is hereby defined as

$$\eta = \frac{\rho g Q H}{N \cdot 2\pi n} \quad (23.2)$$

in which

' $\rho g Q H$ ' = hydraulic output power = transported mass per unit time \times gravity acceleration \times head (W)

ρ = density of the pumped water (about 1000 kg/m³)

g = acceleration due to gravity (9.81 m/s²)

Q = discharge (m³/s)

H = head delivered by the pump (m)

' $N \cdot 2\pi n$ ' = shaft input power = torque on the shaft \times angular speed of the shaft (W)

N = torque on the shaft (J)

n = speed of the shaft (rev/s)

Because the water velocities in a screw are low, the conversion of static suction energy via kinetic energy into static pressure energy can occur with low losses.

Efficiencies of 0.65 can be achieved for small diameter screws and of up to 0.75 for large diameter screws.

Tentative Dimensioning

For a required discharge and head, a tentative estimate of the screw dimensions can be made with the following four design formulas

$$D = \sqrt[3]{\frac{Q}{kn}} \quad (23.3)$$

$$n = \frac{0.85}{\sqrt[3]{D^2}} \quad (23.4)$$

$$L = \frac{H}{\sin \alpha} \quad (23.5)$$

$$d = \frac{L}{20} \quad (23.6)$$

in which

- Q = discharge (m³/s)
- H = static head (m)
- n = number of revolutions (rev/s)
- k = constant (-)
- D = diameter of the screw (m)
- L = length of the screw (m)
- α = inclination of the screw (degrees)
- d = diameter of the shaft (m)

For three or four bladed screws with $22^\circ < \alpha < 30^\circ$, k values can be taken from Table 23.1. For definitive dimensioning screw manufacturers' specifications should be consulted.

23.2.2 Impeller Pumps

Description

Impeller pumps were developed from the need for one compact device to incorporate various lifting capabilities (combinations of discharge and head) as well as from the need to connect a pressure pipe to the outlet of the pump.

The hydraulic part of an impeller pump (see Figure 23.4) consists of an impeller, equipped with vanes, which forces the liquid into a relatively fast rotary motion, and a casing which directs the liquid from a suction opening to the impeller eye, and then leads it away from the outlet of the impeller to the pressure opening. Both openings can be connected to different devices: suction bells, steel piping, or concrete canals. The impeller is mounted on a shaft which is supported by bearings, and rotated by an engine through a flexible or rigid coupling. The impeller vanes and impeller side walls (shrouds) form the impeller canals. The pump casing has several functions: it encompasses the suction and discharge openings, supports the bearings, and houses the impeller assembly. The casing is sealed off around the shaft to prevent external leakage. Closely fitted rings (wearing rings) are mounted on the impeller and fitted in the casing to restrict leakage of high-pressure liquid from the impeller outlet to the impeller inlet.

As illustrated in Figure 23.5, different types of impeller and casing are possible. The three main types are: (i) the centrifugal pump with axial inflow, and a radial and a tangential outflow component; (ii) the mixed flow pump with axial inflow and axial,

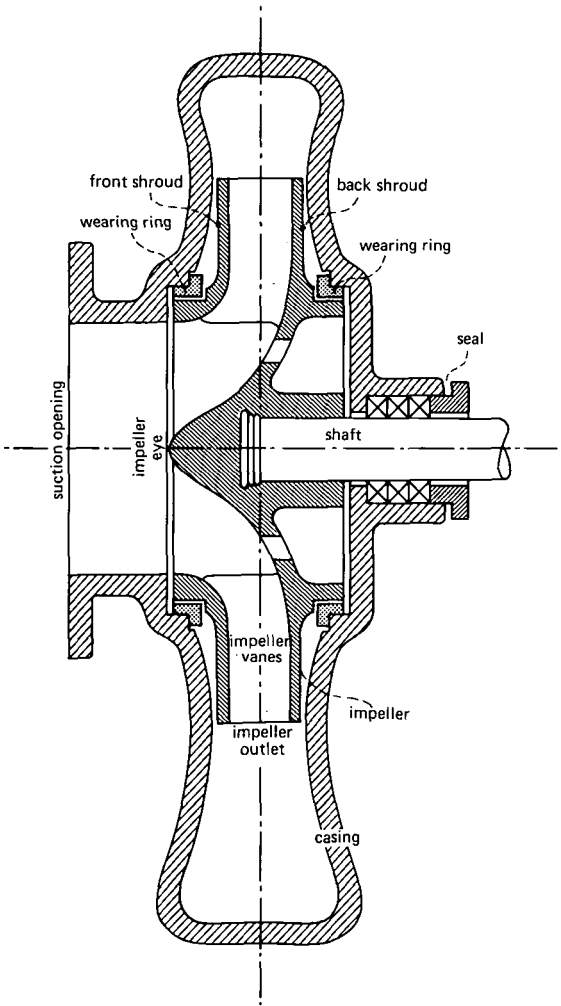

Figure 23.4 Section of a centrifugal pump (from Stepanoff 1957)

radial, and tangential outflow components; and (iii) the axial flow pump with axial inflow and axial and tangential outflow components.

Impeller pumps can be equipped with a vertical, inclined, or horizontal shaft, depending on the application, type of driver, or other requirements. Modern drivers are high-speed electric motors, internal-combustion engines, and steam turbines.

Hydraulic Behaviour of Impeller Pumps

The theory of lifting water by centrifugal force was first suggested by Leonardo da Vinci (1452-1519). The pump, as it is used today, is based on the invention of the French physicist Denis Papin (1647-1714). Both men noted that the pressure (head)

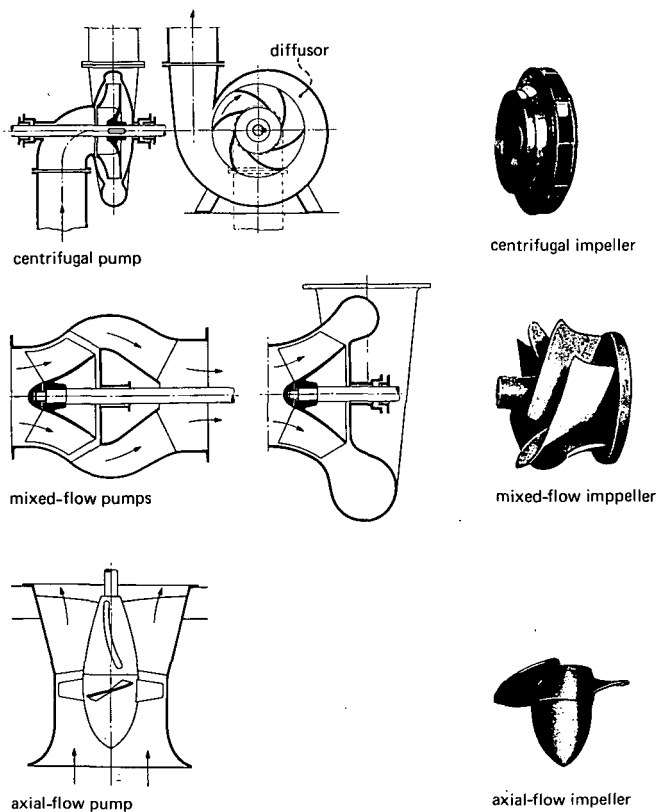

Figure 23.5 Examples of impeller pumps and impeller shapes (after Lazarkiewics and Trokolanski 1965)

of a pumped liquid could be raised if the liquid's momentum was increased by means of a rotating impeller as it flowed through the impeller canals.

Appropriately shaped impeller vanes cause both a reduction in pressure at the impeller eye and a rise in pressure at the impeller outlet. This, in turn, causes liquid to be drawn from the suction opening into the impeller canals and to be delivered from them, via an outlet element (volute or diffusor), to the pressure opening. Because the liquid flowing through the impeller is accelerated during this process, the kinetic energy of the liquid is raised. This kinetic energy is mainly transferred into pressure energy in the outlet element of the pump. As the liquid passes through the impeller and the outlet element, both friction losses and eddy losses occur. These form the major part of the power losses as the input power of the driver is transformed into the hydraulic power of the pump (see Figure 23.6).

For a given impeller pump running at a constant speed, there is only one combination of head and discharge at which the sum of the friction and eddy losses is minimal. In other words, there is only one point at which the given impeller pump can work with maximum efficiency.

The hydraulic behaviour of an impeller pump is described by the discharge versus head characteristic, the discharge versus shaft-power characteristic, and the discharge

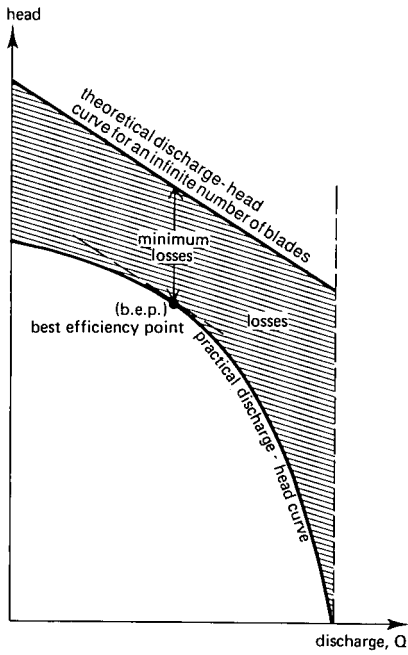

Figure 23.6 Theoretical and practical discharge-head curves for an impeller pump

versus hydraulic-efficiency characteristic (see Figure 23.7). The last-mentioned follows directly from the first two.

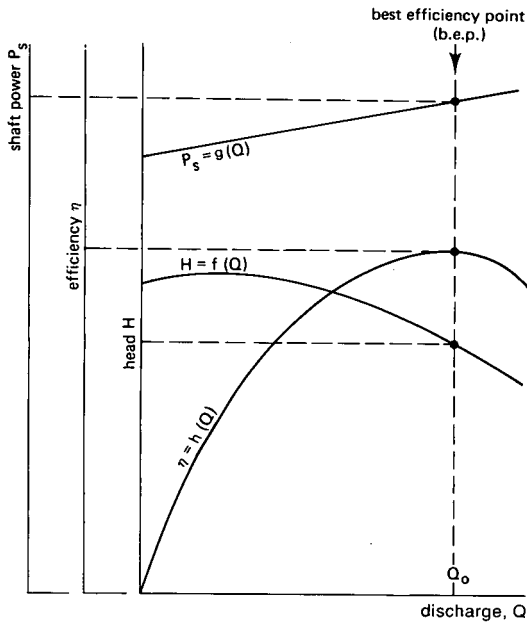

Figure 23.7 Hydraulic characteristics of an impeller pump

The efficiency, η , is hereby similar to that defined in Equation 23.2, i.e.

$$\eta = \frac{\rho g Q H}{N \times 2\pi n} \quad (23.7)$$

The power supply to the pump shaft is defined by

$$P_s = \frac{\rho g Q H}{\eta} \quad (23.8)$$

in which

P_s = power to be delivered to the shaft of the pump (Watt)

This power requirement should be determined on the basis of the least favourable hydraulic conditions under which the pump must run, i.e. under conditions that require the highest power consumption.

Each pump's particular characteristics suit it to a particular task. Under conditions of falling discharge, axial flow pumps show rather steeply rising discharge-head and discharge-power curves. An axial-flow pump is the logical choice for pumping high discharges at relatively low heads (see Figure 23.8). Under the same conditions of falling discharge, centrifugal pumps, on the other hand, show only a slight rise in head and a slight fall in power. Such pumps are suitable for pumping low discharges at relatively high heads. Mixed flow pumps, as their name indicates, are intermediate types. The typical operating range of the various pumps is illustrated in Figure 23.9 (Addison 1966; De Kovats and Desmur 1968).

Specific Speed

Since eddy losses and friction losses greatly influence the attainable efficiency, it is clear that a pump's best possible efficiency is governed by its shape, and thus by its type. The pump type can be characterized by the 'specific speed' related to the discharge and head at the best efficiency point. Presentation in dimensionless shape leads to

$$n_s = \frac{\omega \sqrt{Q_o}}{(gH_o)^{0.75}} \quad (23.9)$$

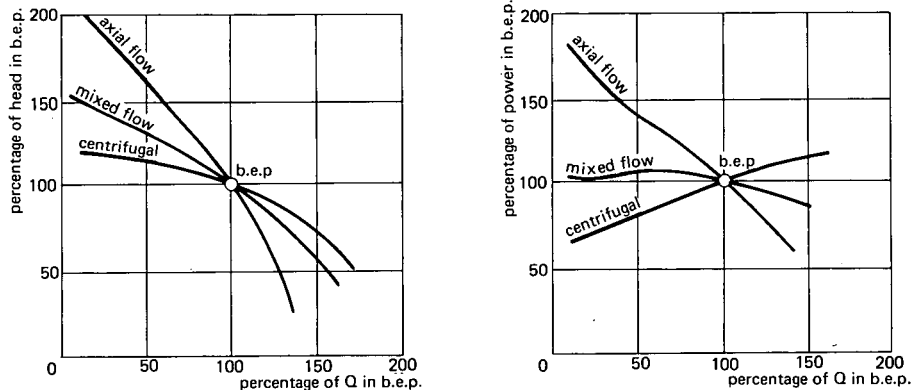

Figure 23.8 Characteristics of impeller pumps in terms of the percentage of discharge, head, and power at the best efficiency point (b.e.p.)

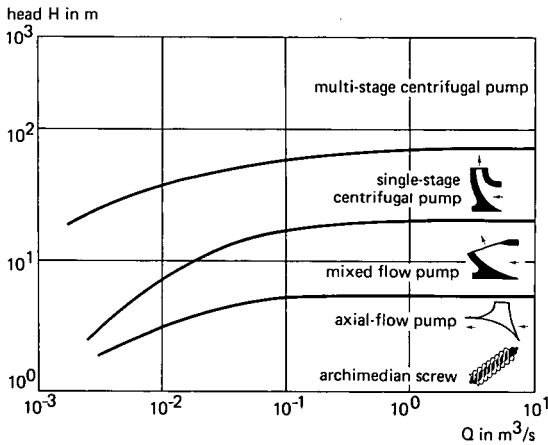

Figure 23.9 Approximate operating range of pumps (upper limits are shown!)

in which

n_s = specific speed (-)

ω = speed of the impeller (rad/s) ($\omega = 2\pi n$ with n in rev/s)

Q_o = discharge at the best efficiency point (m^3/s)

g = acceleration due to gravity (m/s^2)

H_o = head delivered by the pump at the best efficiency point (m)

($H = p/\rho g$ in which p is pressure rise of the water between suction and pressure opening in N/m^2)

Unfortunately, many dimensional definitions of the specific speed are applied in practice, including the much-used n_{sq}

$$n_{sq} = \frac{n\sqrt{Q_o}}{H_o^{3/4}} \quad (23.10)$$

in which

n_{sq} = specific speed ($m^{0.75}/min s^{0.50}$)

n = speed of the impeller in revolutions per minute (rev/min)

Q_o = discharge at the best efficiency point (m^3/s)

H_o = head delivered by pump at the best efficiency point (m)

For different pump types defined by their specific speed, n_{sq} , Figure 23.10 shows typical discharge-head and discharge-power characteristics which refer to the discharge, head, and power at the best efficiency point.

Shown in Figure 23.11 are half sections of typical impeller shapes and the height of their attainable efficiency (best efficiency points) as a function of the specific speed, n_{sq} . It is clear that the highest efficiencies are possible with pumps in the specific speed range of 40 to 120 $m^{0.75}/min s^{0.50}$.

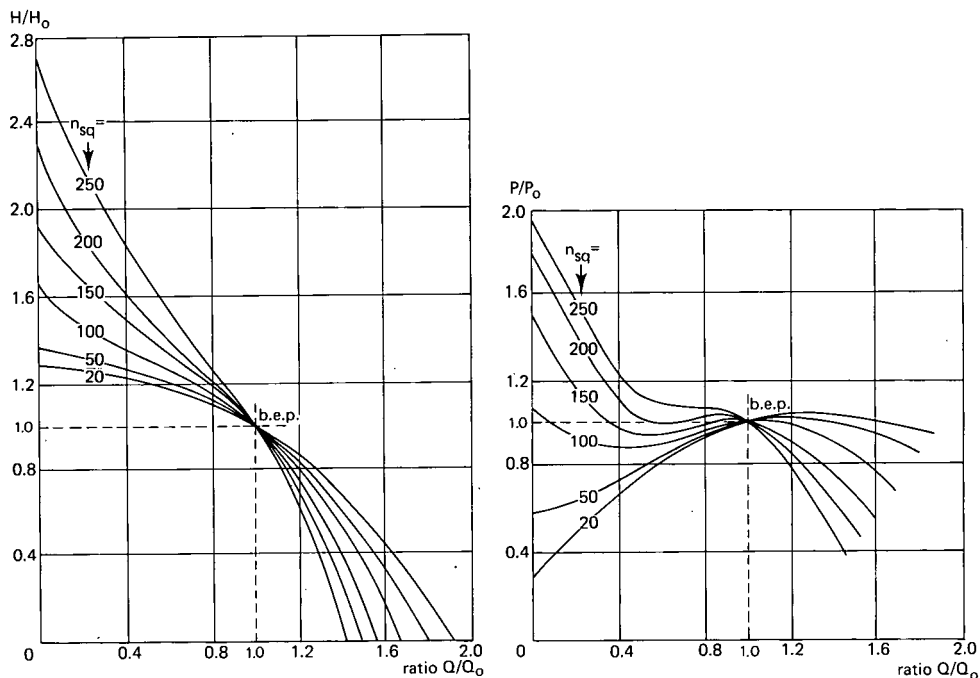

Figure 23.10 Discharge-head and discharge-power characteristics of impeller pumps (n_{sq} in metric units)

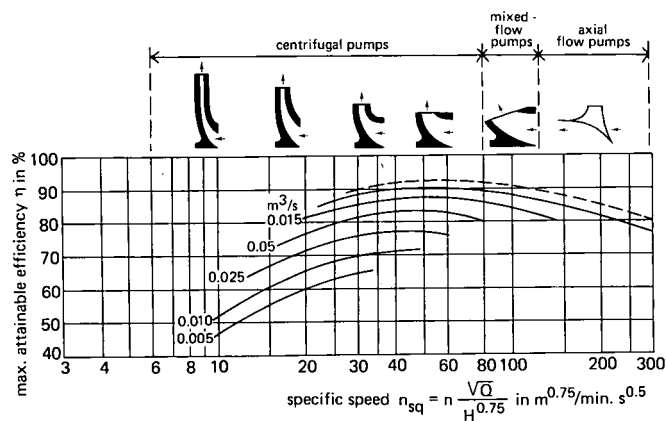

Figure 23.11 Maximum attainable pump efficiency as a function of n_{sq} (from Lazarkiewics and Troskolanski 1965)

23.3 Affinity Laws of Impeller Pumps

The hydraulic characteristics of two pumps of identical design and shape (conformable pumps), but of different size and with impellers that run at different revolutions per

unit of time, are coupled through affinity laws. If one knows the discharge-head characteristic and the discharge-power characteristic of an 'existing' pump (a real or model pump as tested by the manufacturer or an independent laboratory), it is possible to estimate similar characteristics for a conformable pump of different dimensions and running at a different speed (see Figure 23.12).

The three dimensionless affinity laws are (Karassik et al. 1976; Schulz 1977)

$$\frac{Q_e}{Q_c} = \left(\frac{D_e}{D_c}\right)^3 \frac{n_e}{n_c} \quad (23.11)$$

$$\frac{H_e}{H_c} = \left(\frac{D_e}{D_c}\right)^2 \left(\frac{n_e}{n_c}\right)^2 \quad (23.12)$$

$$\frac{P_e}{P_c} = \left(\frac{D_e}{D_c}\right)^5 \left(\frac{n_e}{n_c}\right)^3 \quad (23.13)$$

in which

- Q_e = discharge of the existing pump
- Q_c = discharge of the conformable pump
- D_e = the outlet diameter of the impeller of the existing pump
- D_c = the outlet diameter of the impeller of the conformable pump
- n_e = speed of the existing pump
- n_c = speed of the conformable pump
- H_e = head of the existing pump
- H_c = head of the conformable pump
- P_e = power consumption of the existing pump
- P_c = power consumption of the conformable pump

These affinity laws hold for conformable working conditions in both pumps, or in

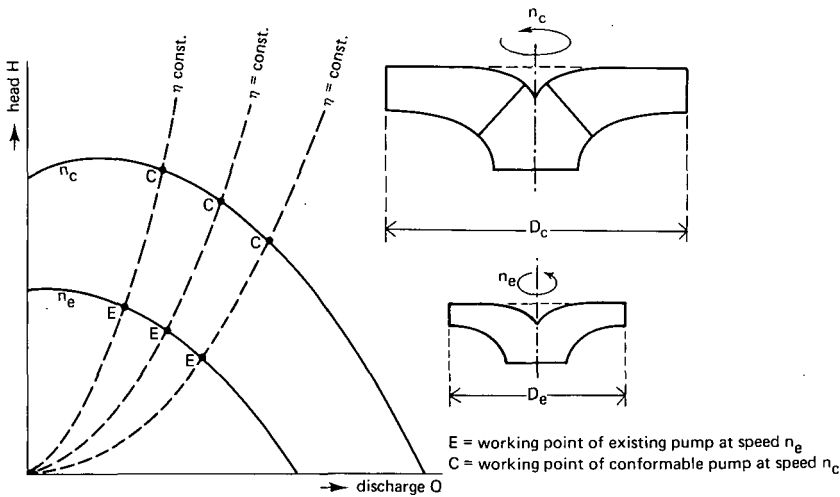

Figure 23.12 Discharge-head curves of an 'existing' and a conformable impeller pump

other words, for conformable flow patterns in both pumps. Because viscosity effects are neglected in these equations, both the existing and the conformable pump will operate at equal efficiencies ($\eta_c = \eta_e$).

If the pump dimensions differ, but the speed of the existing and conformable impeller are the same ($n_e/n_c = 1$). Equations 23.11 to 23.13 can be used to derive the hydraulic characteristics for the conformable impeller diameter, D_c .

From the affinity laws, a set of simplified rules can be derived to determine the hydraulic characteristics when the pump dimensions remain constant and only the impeller speed is changed.

They read

$$\frac{Q_e}{Q_c} = \frac{n_e}{n_c} \quad (23.14)$$

$$\frac{H_e}{H_c} = \left(\frac{n_e}{n_c}\right)^2 \quad (23.15)$$

$$\frac{P_e}{P_c} = \left(\frac{n_e}{n_c}\right)^3 \quad (23.16)$$

$$\eta_c = \eta_e \quad (23.17)$$

23.4 Cavitation

23.4.1 Description and Occurrence

As mentioned when the hydraulic behaviour of impeller pumps was being discussed, low pressures will occur at the impeller inlet. Generally, these low pressures are physically restricted to the vapour pressure of the pumped liquid at the prevailing temperature.

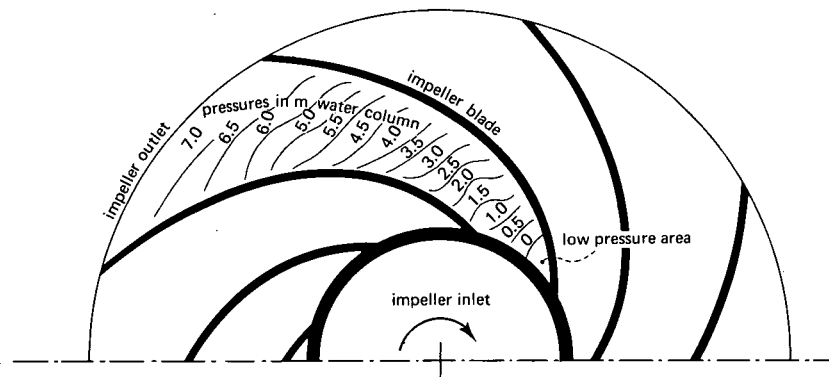

Figure 23.13 Pressure distribution between two blades of a centrifugal impeller with atmospheric pressure as reference level (after Stepanoff 1957)

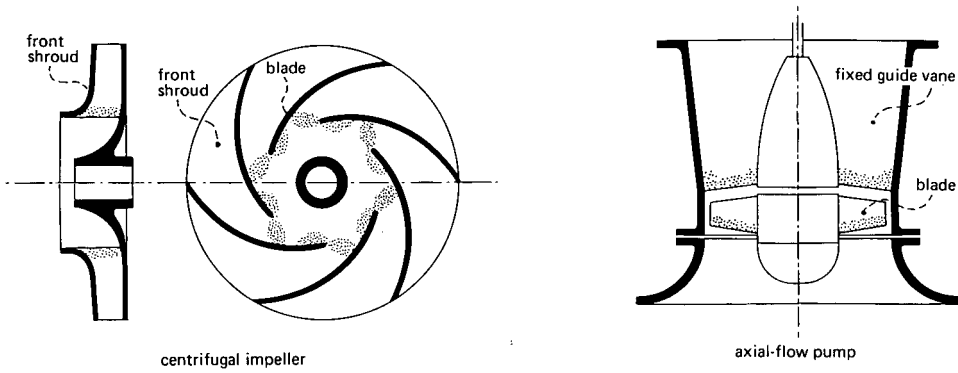

Figure 23.14 Pitting due to cavitation in impeller pumps (after Lazarkiewicz and Troskolanski 1965)

An example of such pressure distribution is shown in Figure 23.13. Upon reaching the vapour pressure, the liquid starts to boil and forms bubbles which are then carried away with the liquid. When the bubbles reach areas of higher pressures, they collapse. This phenomenon, known as cavitation, is accompanied by typical noises. In small pumps, light vibrations due to light cavitation sound like 'the frying of bacon'; in large pumps heavy vibrations due to heavy cavitation sound like 'the pumping of boulders'.

Cavitation may lead to a change in the pump's hydraulic behaviour and to heavy wear on its structural parts, thus reducing its life. Simply put, cavitation batters the material. As early as 1933, pressure pulses up to 300 bar and with a frequency of 25 000 Hz were observed in experiments conducted by Haller. Figure 23.14 shows the points in impeller pumps where pitting due to cavitation is most likely to occur.

A cavitation attack will damage pumps of different materials at greatly different rates (see Figure 23.15). This damage is further influenced by the properties of the pumped water, e.g. vapour pressure, dissolved gas content, and free gas content.

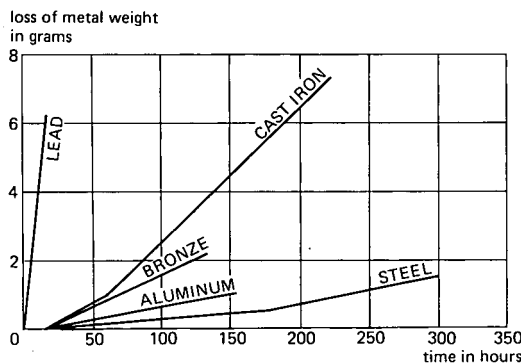

Figure 23.15 Rate of cavitation damage for various construction materials (from Stepanoff 1957)

23.4.2 Net Positive Suction Head (NPSH)

The cavitation behaviour in an impeller pump is described by the discharge-NPSH curve, an example of which is shown in Figure 23.16. NPSH stands for Net Positive Suction Head. It is defined as the margin between the absolute energy head (absolute static pressure head + velocity head) in the suction opening of the pump and the vapour pressure head of the pumped liquid at the prevailing temperature. Both of these heads refer to the centre of the pump's suction opening.

As illustrated in Figure 23.17, the NPSH thus equals

$$\text{NPSH} = H_A + h_o - h_v \quad (23.18)$$

in which

- NPSH = Net Positive Suction Head (m)
- $H_A + h_o$ = absolute energy head in the suction opening of the pump (m)
- H_A = energy head in the suction opening of the pump with atmospheric pressure as reference level (m) (see Figure 23.19)
- h_o = absolute air pressure head above the suction reservoir (m)
- h_v = vapour pressure head of the pumped liquid (m)

Absolute air pressure at sea level is about 10 m (1 bar = 100 kPa). The vapour pressure head of fresh water at temperatures of 15°C to 30°C is 0.4 m (0.04 bar = 4 kPa).

Besides the NPSH value, it is common practice to use the dimensionless Thoma number σ (see Figure 23.16)

$$\sigma = \frac{\text{NPSH}}{H} \quad (23.19)$$

The discharge-NPSH curve in Figure 23.16 gives an indication of the pressure head that is required in the pump's suction opening to keep pressures inside the pump above

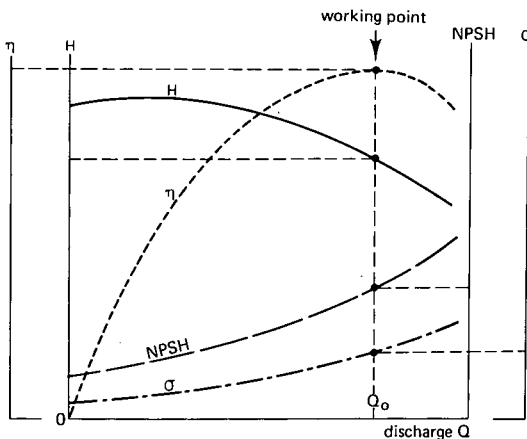

Figure 23.16 Illustration of discharge-NPSH curve and discharge-Thoma-number curve for an impeller pump

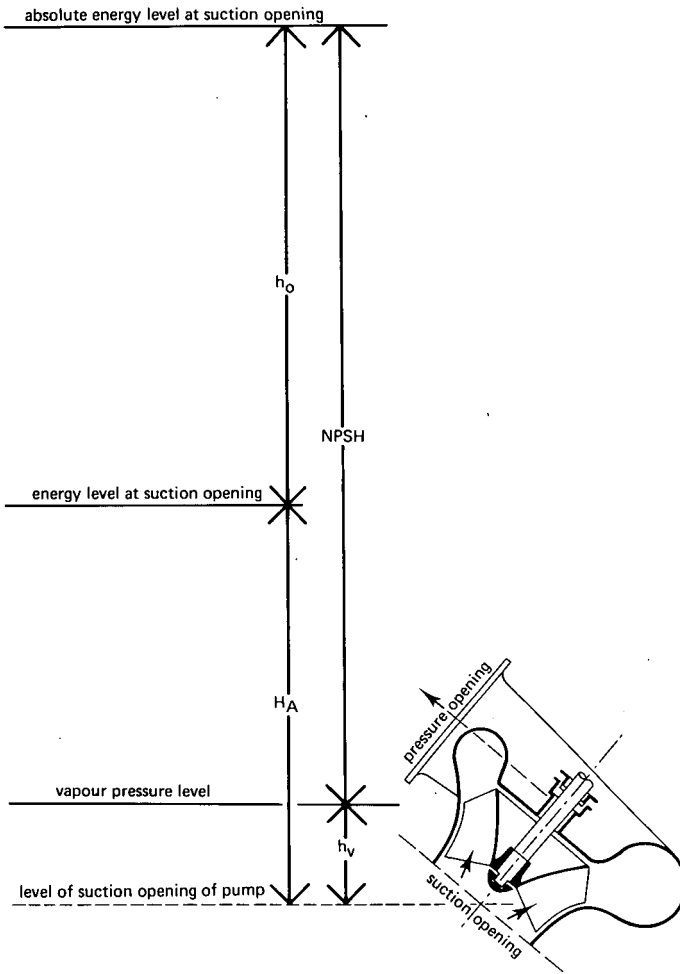

Figure 23.17 Illustration of Net Positive Suction Head (NPSH)

a particular level, and thus prevent what could be referred to as a 'certain amount of cavitation'. This 'certain amount of cavitation' may be defined as no cavitation at all, a certain level of vibrations and noise, a fall in pump head as compared with cavitation-free pumping (0.1 to 0.2% or 1 to 2%), or some erosion.

The amount of cavitation that can be tolerated is a question of economics. For example, the criterion of no cavitation at all leads to a high, required NPSH value. And, since the h_o and h_v values in Equation 23.18 cannot be altered, the criterion leads to a high H_A value (deep submergence of the pump, see also Figure 23.19A), or to a large noiseless pump, running at a low speed over a long life. Using the criterion of a 1 to 2% fall in pump head, on the other hand, would indicate a noisy, heavily cavitating pump with a relatively short life because of cavitation erosion.

Figure 23.18 is based on the results of numerous cavitation tests on various types of pumps. It shows a useful relation between the different pumps, characterized by

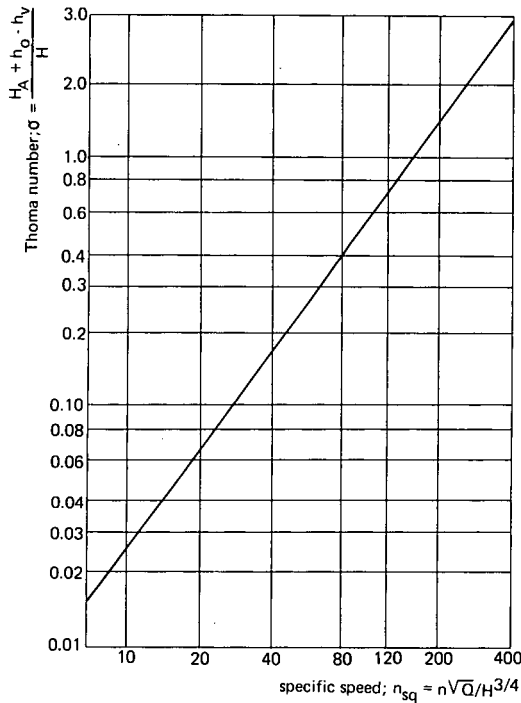

Figure 23.18 Relation between the minimum required Thoma number and the specific speed (from Stepanoff 1957)

the specific speed, n_{sq} , at their best efficiency points, and the minimum σ value at which proper performance of the relevant pump is still guaranteed. The graph is based on a small drop in head of 0.1 to 0.2% due to cavitation as compared with cavitation-free pumping.

To prevent the 'certain amount of cavitation' described above, it is important that the available NPSH for each pump and its pump system be higher than the NPSH required by the manufacturer for that typical criterion. In the preliminary stage of a project, required values of σ , and so for NPSH, can be taken from Figure 23.18.

23.5 Fitting the Pump to the System

23.5.1 Energy Losses in the System

Irrespective of the elevation of the pump, it must deliver a pump head, which actually consists of three heads (see Figure 23.19)

$$H = H_{st} + \Delta H_s + \Delta H_{pr} \quad (23.20)$$

in which

$$H = \text{manometric or total head to be delivered by the pump (m)}$$

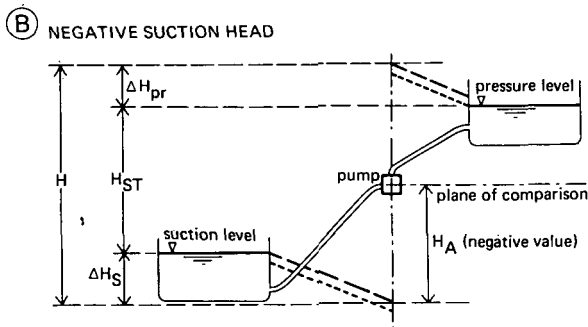
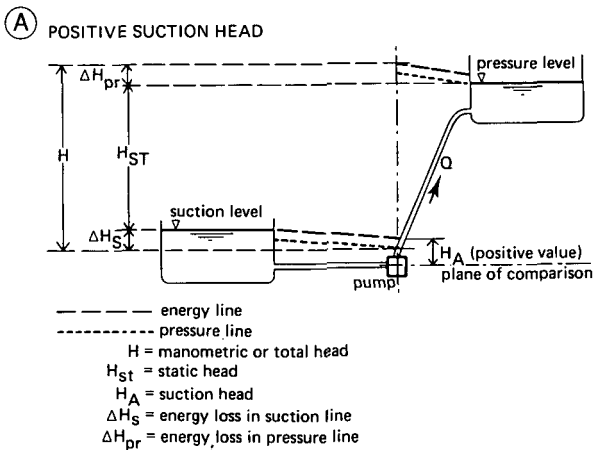

Figure 23.19 Schematic presentation of a pump in a simple system (after Wijdiéks 1972)

H_{st} = static head, or the difference between the suction reservoir and the pressure reservoir (m)

ΔH_s = hydraulic loss on the suction side of the pump (m)

ΔH_{pr} = hydraulic loss on the pressure side of the pump (m)

In the above equation, ΔH_s and ΔH_{pr} can be expressed as

$$\Delta H_s = k_s \frac{v_s^2}{2g} + f_s \frac{L_s}{D_s} \frac{v_s^2}{2g} \quad (23.21)$$

and

$$\Delta H_{pr} = k_{pr} \frac{v_{pr}^2}{2g} + f_{pr} \frac{L_{pr}}{D_{pr}} \frac{v_{pr}^2}{2g} \quad (23.22)$$

in which

k_s = loss coefficient of the trash rack, suction piping, bends etc. (-)

v_s = reference velocity in the suction pipeline, if any (m/s)

g = acceleration due to gravity (m/s^2)

f_s = friction factor of the suction pipe, if any (-)

- L_s = length of the suction pipe, if any (m)
- D_s = diameter of the suction pipe, if any (m)
- k_{pr} = loss coefficient of the pressure piping, bends, valves etc. (-)
- v_{pr} = reference velocity in the pressure piping (m/s)
- f_{pr} = friction factor of the pressure piping (-)
- L_{pr} = length of the pressure piping (m)
- D_{pr} = diameter of the pressure piping (m)

Equation 23.20 can also be expressed in terms of pump head, H , and pump discharge, Q , leading to the following hydraulic characteristic for the system

$$H = H_{st} + CQ^2 \quad (23.23)$$

in which

$$C = \text{constant, which depends on hydraulic losses in the system following from Equations 23.21 and 23.22 (s}^2/\text{m}^5\text{)}$$

The static head, H_{st} , is equal to the difference in the water level between the pressure and suction side of the pumping station, and is entirely independent of the head losses in the system and the discharge delivered by the pump. The static head changes only if the suction level or pressure level changes. The term CQ^2 in Equation 23.23 can be calculated for several values of Q , enabling the head, H , to be plotted against the pumped discharge, as illustrated in Figure 23.20A.

23.5.2 Fitting the System Losses to the Pump Characteristics

As was shown in Figure 23.7, the hydraulic characteristics of a pump are given by two independent functions and one derived function. They are

$$H = f(Q) \quad (23.24)$$

$$P_s = g(Q) \quad (23.25)$$

$$\eta = h(Q) \quad (23.26)$$

These three functions and Equation 23.23 are plotted in Figures 23.20A, B and C. A further study of Figure 23.20A shows a point of intersection between the head-discharge curve of the system (Equation 23.23) and the head-discharge curve of the pump (Equation 23.24). This point is called the working point. If a pump running at a constant speed, with characteristic $H = f(Q)$, is placed in the system, that pump will deliver a discharge, Q , at the related head, H , defined by the working point.

The required power of the driver, P_b , the pump efficiency, η , and the required NPSH can be read immediately from Figure 23.20B, C, and D, respectively.

23.5.3 Post-Adjustment of Pump and System

Because the hydraulic losses in the system, as calculated by Equations 23.21 and 23.22, are subject to errors in the estimate of coefficients and factors, the real energy losses

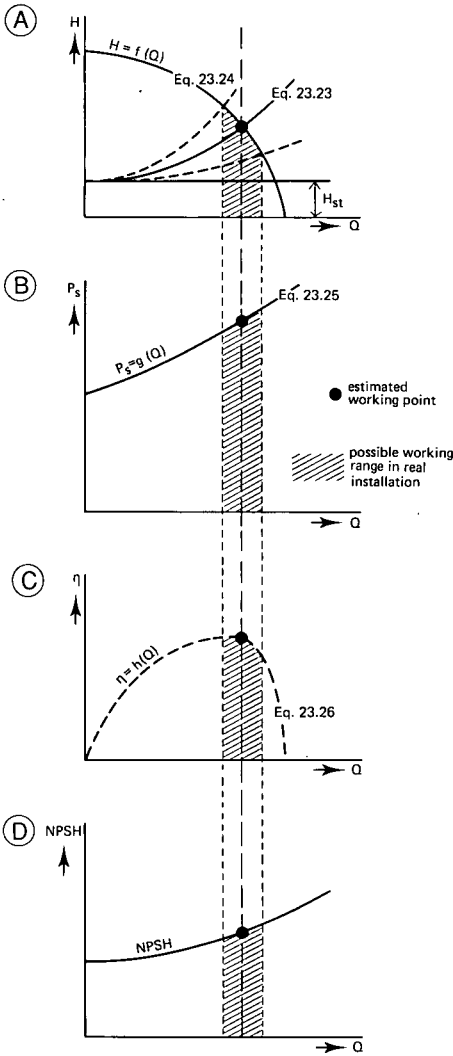

Figure 23.20 Combination of pump and pumping system

may be either lower or higher. As Figure 23.20A illustrates, the characteristic (Equation 23.23) of the real system intersects the pump characteristics at another operating point. This leads to a higher or lower pumped discharge, a different power consumption, and a lower efficiency than expected. Also, unexpected cavitation may occur because of higher required NPSH values (see Figure 23.20D) at an unplanned operating point in the pumping station.

Post-adjustment of the hydraulic characteristic of either the system or the pump may be needed. Obviously, the point of intersection of the two curves in Figure 23.20A will shift with a change in either curve. The shape of the system's curve can be changed

only by making adjustments in its hydraulic design, which means that the energy loss coefficient will change as well.

The pump characteristic, $H = f(Q)$ can be changed either by some cutting at the outlet end of the impeller vanes, or by replacing the whole impeller by a more suitable one. If cutting is done, the hydraulic characteristics after cutting can be estimated with the following three empirical equations

$$Q_{\text{cut}} = \left(\frac{D_{\text{cut}}}{D_{\text{org}}}\right)^2 \times Q_{\text{org}} \quad (23.27)$$

$$H_{\text{cut}} = \left(\frac{D_{\text{cut}}}{D_{\text{org}}}\right)^2 \times H_{\text{org}} \quad (23.28)$$

$$P_{\text{cut}} = \left(\frac{D_{\text{cut}}}{D_{\text{org}}}\right)^4 \times P_{\text{org}} \quad (23.29)$$

in which

- Q_{cut} = discharge after cutting (m^3/s)
- Q_{org} = original discharge (m^3/s)
- D_{cut} = diameter of the impeller after cutting (m)
- D_{org} = original diameter of the impeller (m)
- H_{cut} = head after cutting (m)
- H_{org} = original head (m)
- P_{cut} = power consumption after cutting (W)
- P_{org} = original power consumption (W)

These equations are only applicable to centrifugal pumps with $n_{\text{sq}} \leq 40 \text{ m}^{0.75}/\text{min s}^{0.50}$ and a cut of not more than 20%. The efficiency curve decreases somewhat because impeller and pump house are then no longer optimally matched.

23.6 Determining the Dimensions of the Pumping Station

23.6.1 General Design Rules

For a pumping station (pump in a system) to operate as planned, or as calculated by the pump manufacturer, the following general design rules should always be used:

- The NPSH available in the pumping station should either be better than the NPSH required by the manufacturer, or be better than the tentative value derived from Figure 23.18. This will prevent cavitation effects as described in Section 23.4;
- Flow velocity towards the pump suction opening should either remain constant or accelerate, but should never decelerate. This will ensure an even velocity distribution in the impeller eye of the pump;
- Hydraulic losses at the suction side of the pump (ΔH_s in Figure 23.19) should be as small as possible. This usually means using short suction pipes (if needed) without sharp corners or bends;
- Suction pipes with bends that traverse different planes should be avoided at all costs. They would introduce strong rotational flow in the suction opening of the pump. This rule is especially important for high specific-speed pumps;

- The suction opening should be sufficiently below the suction level to avoid air entrainment vortices (see Section 23.6.2);
- Pumps should operate at or near their best efficiency point.

Rotations and vortices disturb the uniformity of the flow pattern in the suction opening of the pump. Flow rotations moving in the same direction as the impeller rotation lead to a lower discharge and head than would be expected from the pump characteristics. Flow rotations moving against the impeller rotation lead to a higher discharge and head, and may also lead to overloading of the driver. Air entrainment can cause a low head and a low discharge, rough running, or even complete depriving of the pump. Moreover, air may concentrate in the pressure pipe, resulting in higher energy losses and a lower discharge.

23.6.2 Sump Dimensions

When one impeller pump is used, a simple rectangular sump as shown in Figure 23.21 suffices. The sump dimensions are given in terms of the bell-mouth diameter, D_b .

Most pump manufacturers use the following ratio of bell-mouth diameter to pump suction opening D_1

$$\frac{D_b}{D_1} = 1.5 \text{ to } 1.8 \quad (23.30)$$

The dimensions shown in Figure 23.21 can be used, provided that there is a steady, uniform flow through the approach channel section about $3D_b$ upstream of the bell-mouth centre line (Figure 23.21A).

Assuming a mean velocity of 4.0 m/s in the pump suction opening, bell-mouth entry velocity can reach 1.2 to 1.8 m/s and approach channel velocities about 0.25 to 0.35 m/s, depending on the ratio suction opening diameter over bell-mouth entry diameter of 1.5 to 1.8.

When several pumps are used in one wide approach channel, the design principle shown in Figure 23.22 is a good one. But any deviation from these basic design rules, for whatever reason, requires that sump model tests be performed (Wijdiëks 1985). Such deviations often occur when water is delivered to the sump through a relatively narrow suction channel. This results in decelerating flow and related vortices and eddies in the sump. Special provisions are then needed to correct the flow pattern. Model testing should be entrusted only to skilled laboratories since scale effects can influence the results.

23.6.3 Parallel Pumping

The dimensions of a pumping installation depend greatly on the dimensions of the pump, particularly that of its suction opening. The first step in designing a pumping installation should therefore always be to estimate the number of pumps to be installed

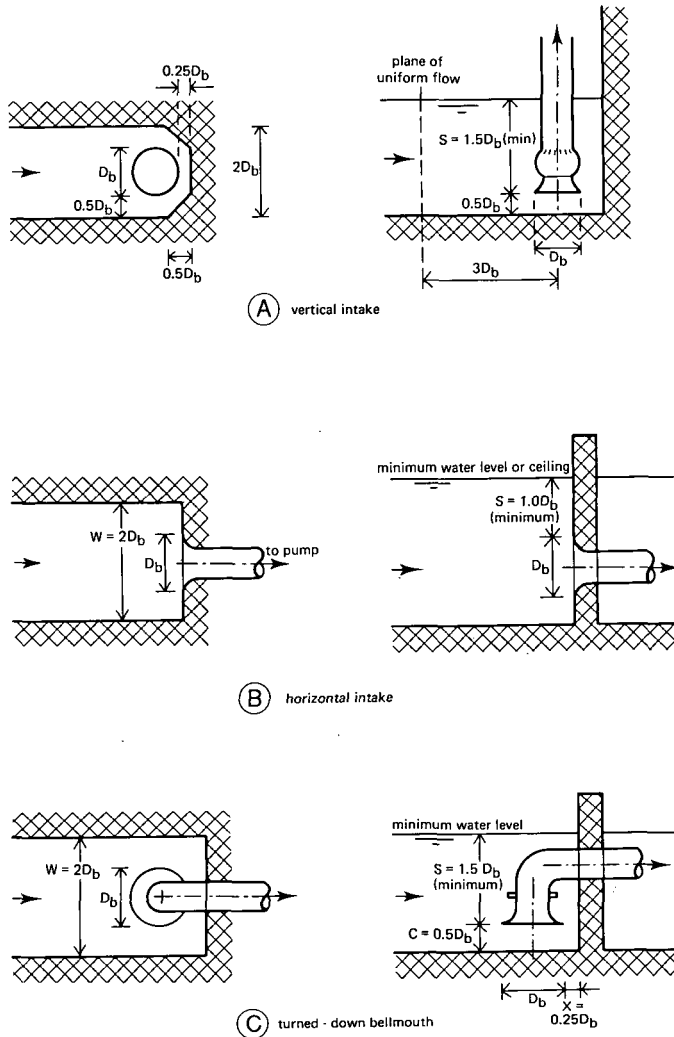

Figure 23.21 Single-pump sumps (after Prosser 1977)

and to characterize their dimensions by their suction opening, D_1 .

Economically, it may seem wise to install a single pump unit instead of two, three, or more units which, together, have the same pumping capacity. However, the breakdown of a single unit leads to the complete cessation of pumping. To avoid this risk, and also to avoid inefficient pumping when the discharge is low, it is a good idea to spread the capacity of major pumping stations over several units. And, by choosing units of the same size, it is possible to keep the number of spare parts in stock to a minimum. When efficiency is the main consideration, as it so often is nowadays, several pumps with impellers that can run at variable speeds often are the best choice.

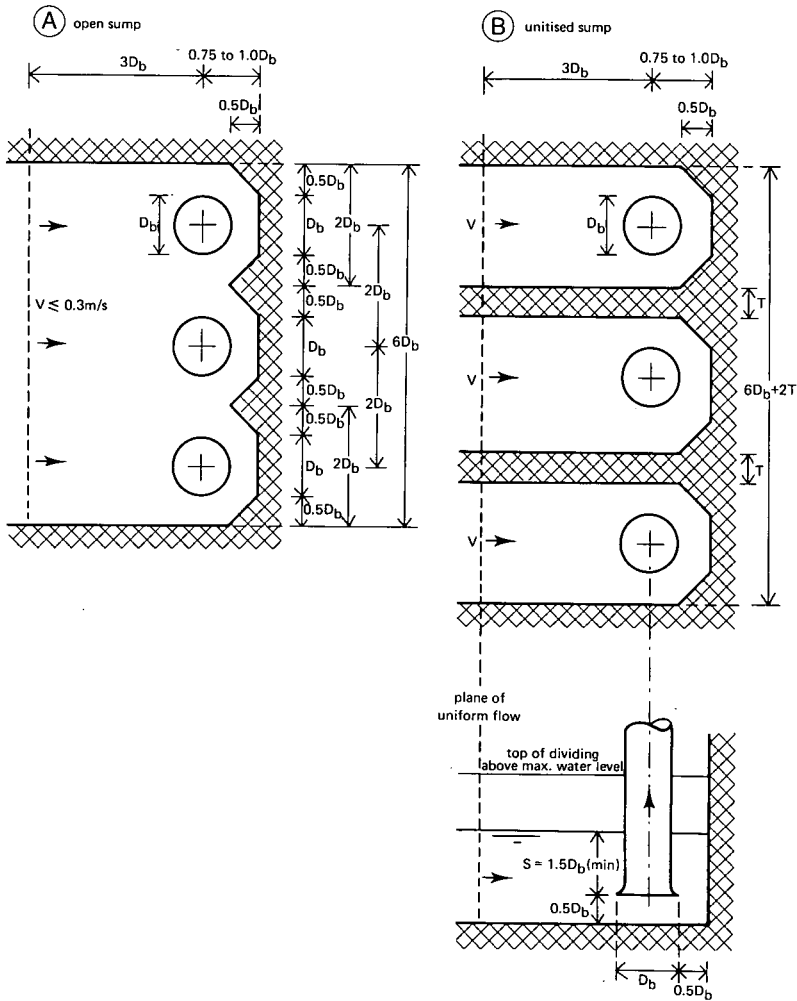

Figure 23.22 Basic sump dimensions for multiple pumps (after Prosser 1977)

Another advantage of spreading the pumping capacity over several units is that this will prevent large drawdowns in the main supply drain through which water flows to the pumping station. As it takes some time before a hydraulic energy gradient develops in the drain, any temporary shortage of water may cause such a drawdown that the stability of the earthen embankment is endangered. Shutting down a pumping station that is operating at full capacity will also constitute a serious attack on the canal embankments: the kinetic energy of the water flowing in the main drainage canal will generate a transition wave.

The total capacity of a pumping station can be made up of several units, each of them pumping through separate suction and pressure pipes, and each of them operating independently of the other. An alternative method is to have several pumps

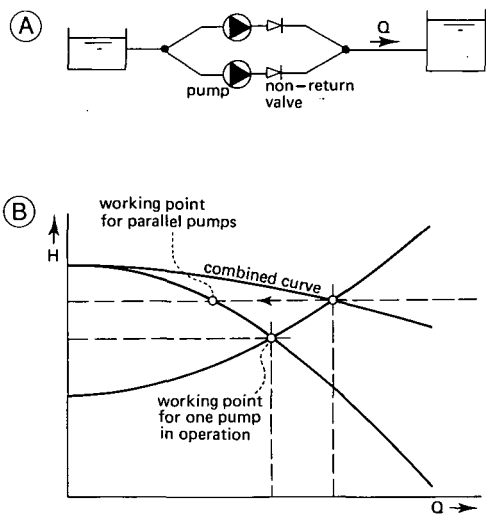

Figure 23.23 Parallel operating pumps; A: Schematic presentation; B: Determination of the working point(s) of parallel installed pumps

discharging simultaneously into a common pipe system; this is referred to as a parallel operation (see Figure 23.23).

The Q - H characteristic of the two parallel operating pumps of Figure 23.23 can be obtained by adding the two Q values for each point of the individual characteristics, while the head value remains constant.

To prevent water backflow through the pump units, each of them should have an automatic, non-return valve in its pressure conduit.

23.6.4 Pump Selection and Sump Design

Selecting the proper pump for a pumping station and designing a system around one or more pumps can be divided into a number of steps. Depending on the experience of the designer and the documentation available to him, these steps may have to be repeated one or more times to balance each part of the projected pumping station. The steps are:

- 1 Decide the number of pump units required to attain the total discharge capacity, basing this decision on the duration curve of the discharge to be pumped and on the considerations presented in Section 23.6.3;
- 2 Calculate the discharge, Q_o , of each unit at its best efficiency point;
- 3 Next, considering the practical restrictions imposed by the lowest suction level, pressure level, trash rack (Section 23.6.6), valves, bends, and so forth, make a first estimate of the total head, H_o , to be pumped at the best efficiency point. Use the flow velocities given in Section 23.6.2 to make the necessary calculations;
- 4 With both Q_o and H_o known for each pump unit, draw Line 1 in Figure 23.24. This step represents a period of reflection. The combination of discharge and head can be delivered either by a big slow-running pump (Line a of Figure 23.24) or

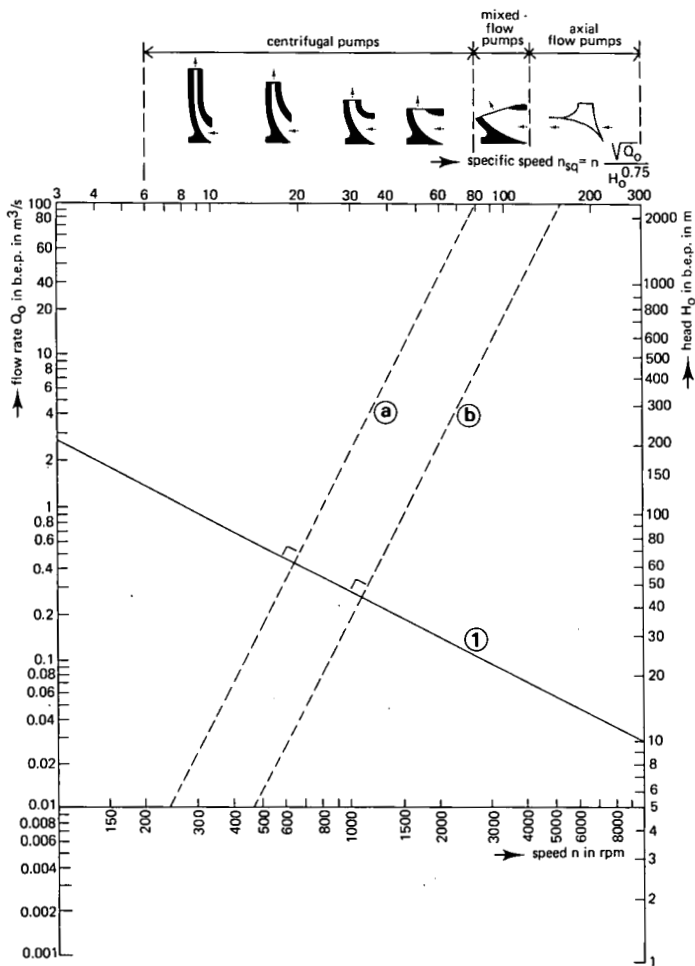

Figure 23.24 Relation diagram of Q_0 , H_0 and pump speeds (after De Gruyter 1971)

by a smaller faster-running pump (Line b of that Figure), while the position of these lines depends on the speed of the intended impeller. Hence, different specific speeds, and related pump types, are possible. Furthermore, the investment cost for a pumping station with small fast-running pumps is usually less than that for a comparable station with large slow-running pumps. On the other hand, the different pumps have different attainable maximum efficiencies, and also different NPSH and σ values. As follows from Figure 23.11, the pump on Line a has about 5% higher efficiency than the pump on Line b, and thus consumes 5% less energy. But, according to Figure 23.18, the pump on Line a has a σ value of 0.4 whereas the pump on Line b has a σ value of 0.8. This means that the foundation for the smaller pumps requires a deeper excavation than that for the larger pump. So, before Line 1 in Figure 23.24 can be drawn, the designer has to find a balance between the investment cost and the operating cost of the pumping station;

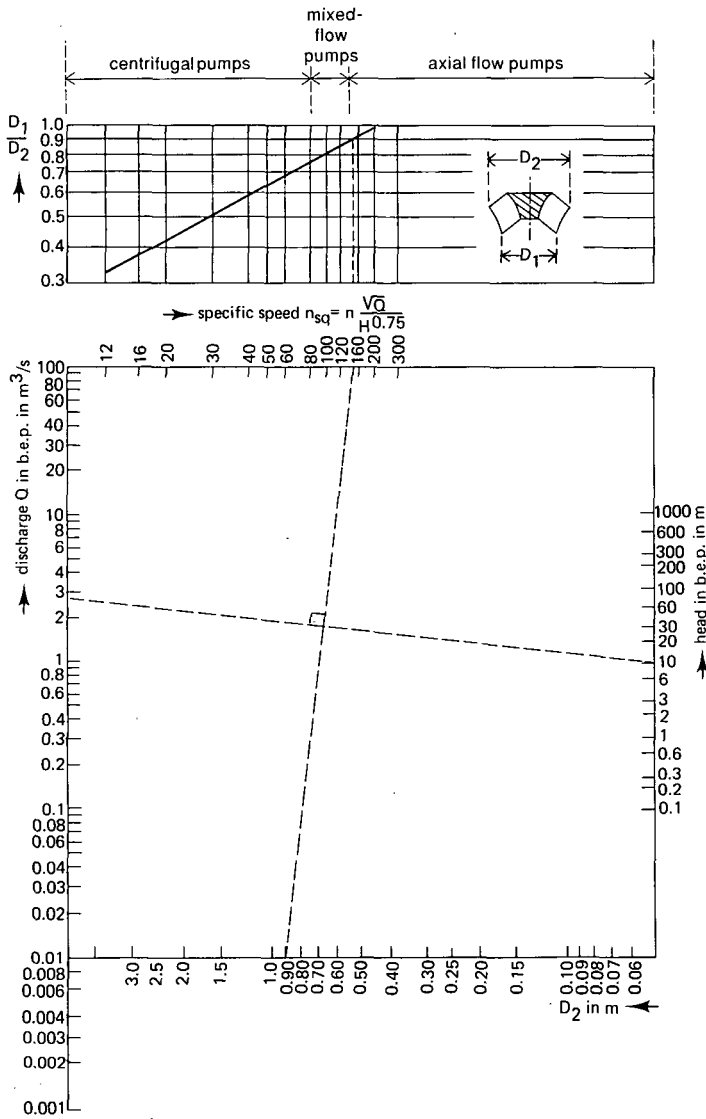

Figure 23.25 Nomograph to determine the impeller sizes, D_1 and D_2 (after De Gruyter 1971).

- 5 As was explained in Section 23.4, cavitation will influence a pump's allowable specific speed, n_{sq} , and cannot be disregarded. So, using Figure 23.18, calculate the tentative required NPSH and H_A values. On the basis of the practical and economic possibilities governing the minimum suction level, the cost of excavation, and the cost of the foundation, decide whether to choose a lower pump elevation or a lower specific speed;
- 6 Repeat steps 1 to 5 until one suitable n_{sq} value is found. Note that low n_{sq} values correspond to centrifugal pumps with low ratio D_1/D_2 and high n_{sq} values correspond with axial flow pumps with $D_1/D_2 = 1$;

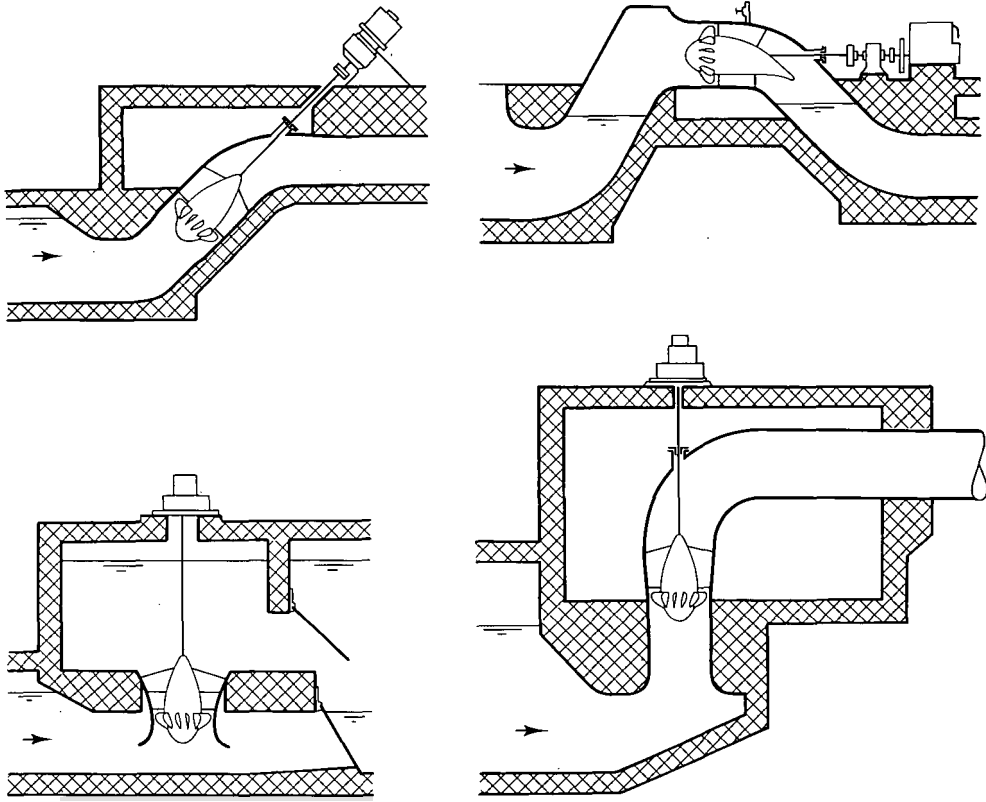

Figure 23.26 Sections of pumping stations with an axial-flow pump

- 7 From the lower part of the nomograph in Figure 23.25 first estimate the outlet diameter D_2 , then from the upper part of it estimate the ratio D_1/D_2 , which finally leads to an estimate of the suction opening D_1 (\approx inlet diameter of impeller) and the bell-mouth opening D_b (\approx 1.5 to 1.8 times D_1);
- 8 From Section 23.6.2 (Figures 23.21 and 23.22), determine the proper sump dimensions. This may mean that the tentative design of Step 3 has to be changed slightly. If so, repeat Steps 4 to 8.

The steps above should be followed until a satisfactory design is obtained. The shape of the resulting pumping station can vary greatly, as can be seen from Figures 23.26, 23.27, and 23.28.

23.6.5 Power to Drive a Pump

As was explained in Section 23.2.2 (Equation 23.8), the power to be delivered to the pump shaft is

$$P_s = \frac{\rho g Q H}{\eta} \quad (23.31)$$

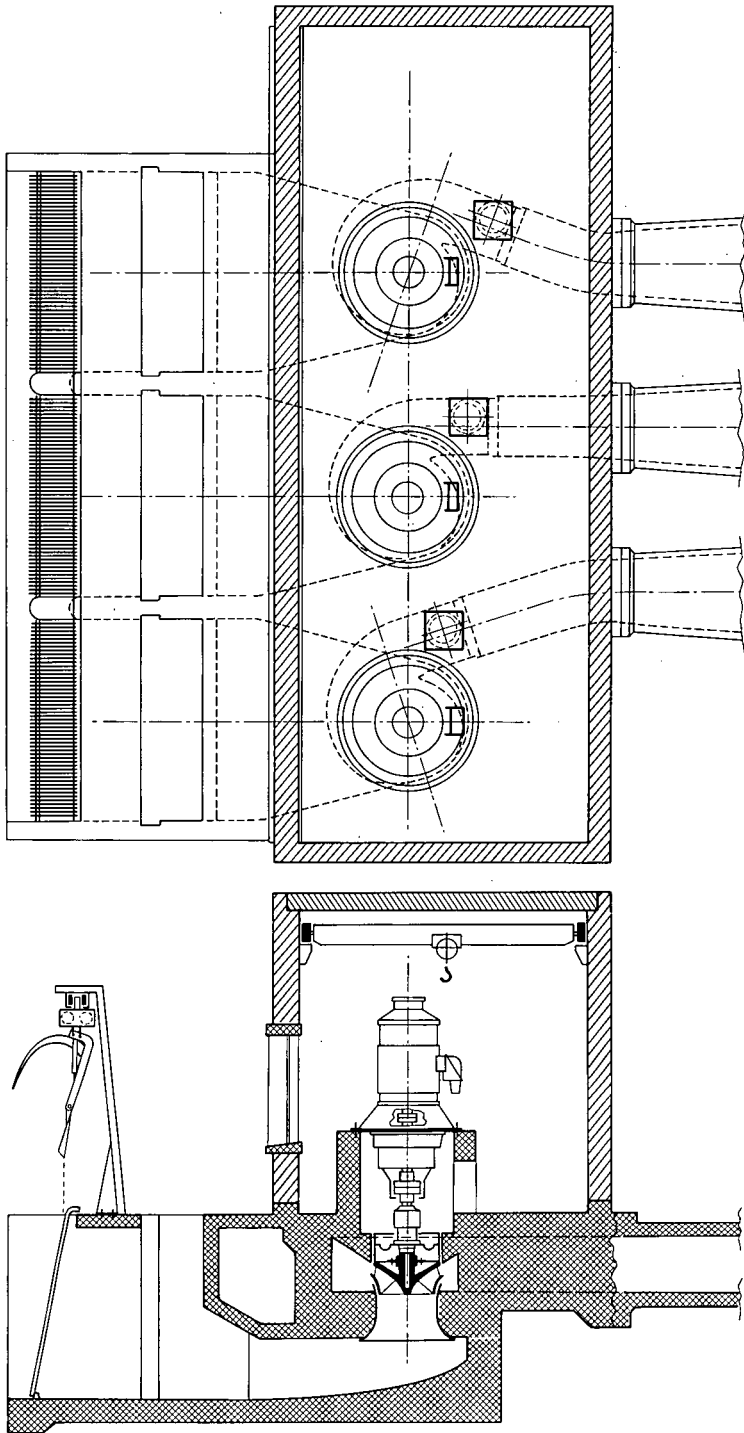

Figure 23.27 Example of assembly and drive for a pumping station with three mixed-flow pumps with concrete housing (Courtesy Stork)

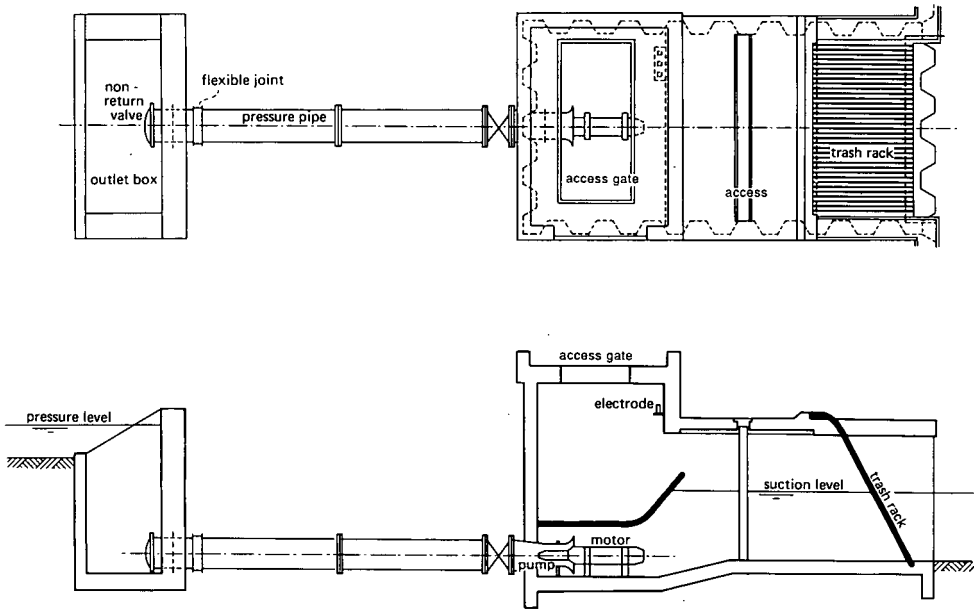

Figure 23.28 Section of a pumping station with underwater axial-flow pump

Any device that can produce a driving torque on the pump shaft can be used as a driver. The most common drivers are the electric motor and the internal combustion (diesel) engine. The choice of driver should be made on the basis of technical and economic considerations as well as on reliability. Some of these considerations are

- Is electric energy available? The construction of power lines can be costly.
- Is the energy supply reliable? Is it prone to failure? Is the transport of diesel fuel costly or uncertain? Are there any import restrictions on fuel?

Table 23.2 Percentage power reduction for an internal combustion engine

Altitude (m)	Temperature (°C)						
	20	25	30	35	40	45	50
100	1	2	4	6	8	10	11
500	6	8	9	11	13	15	17
1000	12	14	16	18	20	21	23
1500	19	21	23	24	26	28	30
2000	26	27	29	31	33	35	36
2500	32	34	36	37	39	41	43
3000	39	40	42	44	46	48	49
3500	45	47	49	51	52	54	56
4000	52	54	55	57	59	61	63
4500	58	60	62	64	66	67	69
5000	65	67	68	70	72	74	76

- What is the cost of energy? Is it possible to use off-peak electric power? Must energy be paid in local or foreign currency?
- Are electric motors or diesel engines produced locally? Are maintenance and repair services available?

The driver's power requirement should be calculated on the basis of the least favourable conditions. The actual efficiency of the pump will then usually be less than the maximum attainable values given in Figure 23.11. One should also realize that power losses in the driver can be caused by the use of a gear box (transmission) and by climatic factors. The power of internal combustion engines will decline as altitude and temperatures increase and as humidity decreases. The extent of the power decline must be specified by the manufacturer. To illustrate how significant a power reduction can be, Table 23.2 shows the effect of temperature and altitude on an internal combustion engine.

The driver should not operate continuously at its maximum capacity, but at an 85 to 90% load. The power of the driver can be calculated from

$$P_d = \frac{\rho g Q H}{\eta \eta_d \eta_t} \times \frac{100 + ac}{100} \times f_r \quad (23.23)$$

where, in addition to earlier defined terms

P_d = required power supply (W)

η = expected efficiency of the pump (-)

η_d = efficiency of the driver (electric motors) (-)

η_t = efficiency of the transmission (0.96 to 0.98) (-)

ac = percentage of power reduction due to altitude and climate (-)

f_r = factor to prevent the driver from running continuously at maximum capacity (internal combustion engines) (1.1 to 1.2)

23.6.6 Trash Rack

To prevent damage to the blades of an Archimedean screw or the impeller of a pump, as well as to avoid blockage of a pump's suction opening, a pumping station should be equipped with a trash rack. The spacing of the trash rack's bars varies according to the type and size of the water-lifting device. Pump and trash rack manufacturers can advise on the proper spacing.

Head losses over a clean trash rack are a function of the flow velocity and the shape and spacing of the bars. Head losses over various types of bars are given in Figure 23.29.

It is obvious that these head losses increase rapidly as trash collects against the rack. To avoid excessive head losses or clogging, the rack must be cleaned with a hand rake. Larger pumping stations are usually equipped with an installation like the one in Figure 23.30. Such cleaning equipment can be operated either manually or automatically. Cleaning should begin when the head loss over the trash rack exceeds a predetermined value.

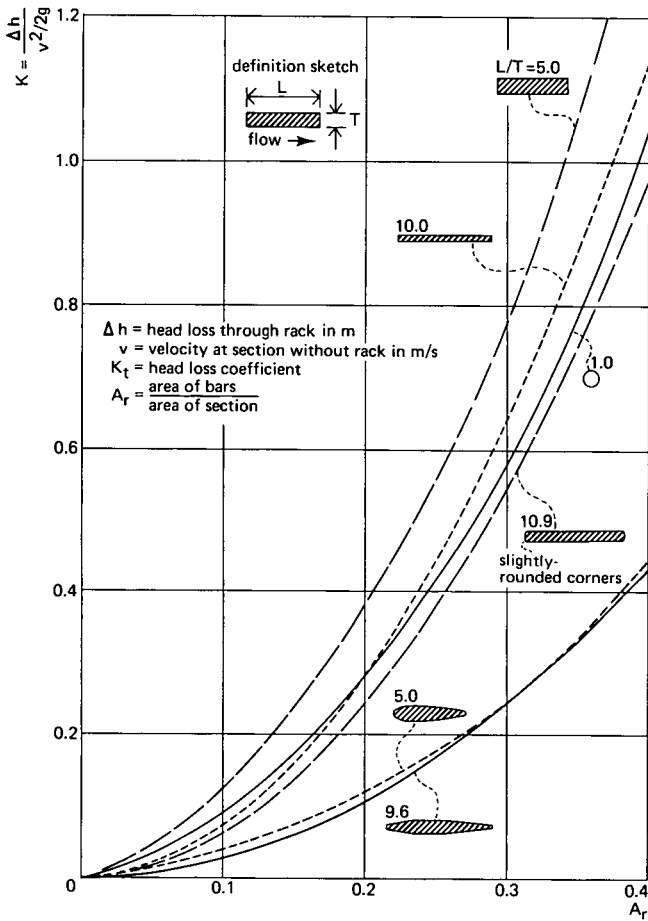

Figure 23.29 Trash rack losses for various types of bars (from Fellenius 1929 and Kirschmer 1926)

23.6.7 The Location of a Pumping Station

When the site for a pumping station is being selected, the following factors should be kept in mind:

- Drainage pumping stations almost always have to be located at the lowest point in the area. Soil conditions at such a site are usually poor. A foundation resting on different levels is not recommended because the bearing capacities of the soil may differ from one level to another;
- Groundwater levels will change after the canals and the pumping station become operational. It may be necessary to take measures to prevent excessive groundwater flow under the station;
- Pumping stations must be easily accessible. It must be possible to transport fuel by road or water, or to provide an easy link-up with the electric network;

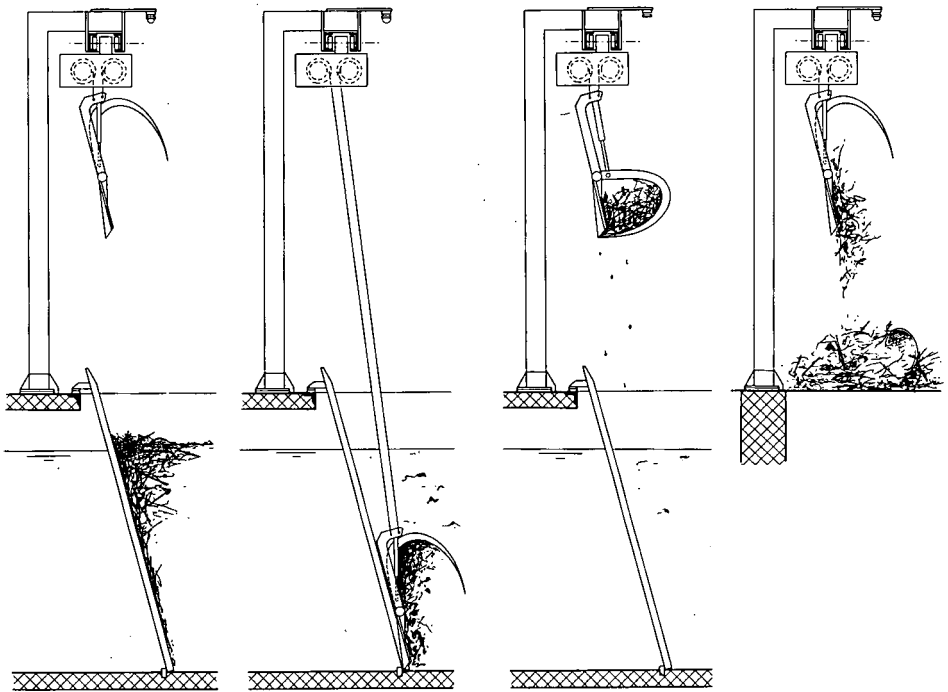

Figure 23.30 Cleaning the trash rack (courtesy Landustrie, Sneek)

- Pumping stations should never be placed on or close to dikes that contain layers of high permeability (e.g. sand); nor should they be built on old dikes;
- New dikes and newly drained lands are subject to varying degrees of subsidence, which are difficult to predict with accuracy. Pipe lines and concrete structures on or through new dikes should therefore be flexible;
- Trash and debris must be easily removable from the screens; a site must be available to deposit trash awaiting disposal.

References

- Addison, H. 1966. Centrifugal and other rotodynamic pumps. Chapman and Hall, London, 565 p.
- De Gruyter, P.J. 1971. Pumping stations. Lecture notes of Int. Courses in Hydraulic and Sanitary Eng., Delft, 58 p.
- De Kovats, A. and G. Desmur 1968. Pumpen, Ventilatoren, Kompressoren radialer und axialer Bauweise. Verlag G. Braun, Karlsruhe, 395 p.
- Fellenius, W. 1929. Experiments on the head loss caused by protecting racks at water-power plants. Vattenbyggnadsinstitutionen, Vid Kungl. Tekniska Hogskolan, Meddelande 5, Stockholm. Summary and pertinent data also published in Hydraulic Laboratory Practice, ASME, 1929. 533 p.
- Hydro Delft 1972. The Archimedean-type screw pump. Quarterly J. of Delft Hydraulics Lab. 27/28, Delft, 15 p.
- Karassik, I.J., W.C. Krutzsch, W.H. Fraser and J.P. Messina 1976. Pump Handbook. McGraw Hill, New York, 1208 p.
- Kirschmer, O. 1926. Investigation regarding the determination of head loss. Mitteilungen des Hydraulischen Inst. der Technischen Hochschule München, Heft 1, 21 p.

- Lazarkiewics, S. and A.T. Troskolanski 1965. *Impeller Pumps*. Pergamon, Press London, 648 p.
- Nouwen, A. 1989. *Pompen*, 3e dr. Educaboek, Culemborg.
- Prosser, M.J. 1977. The hydraulic design of pump sumps and intakes. British Hydromechanics Research Association Publ., Cranfield, Bedford, 48 p.
- Schulz, H. 1977. *Die Pumpen-Arbeitsweise, Berechnung, Konstruktion*. Springer Verlag, Berlin/Heidelberg, New York, 505 p.
- Stepanoff, A.J. 1957. *Centrifugal and axial flow pumps – theory, design and application*. Wiley, New York, 462 p.
- Wijdieks, J. 1972. Hydraulic aspects of the design of pump installations. Delft Hydraulics Lab., Publ. 43, Delft, 7 p.
- Wijdieks, J. 1985. Practice and criteria of pump sump model investigation. Delft Hydraulics Lab., Publ. 324, Delft, 10 p.

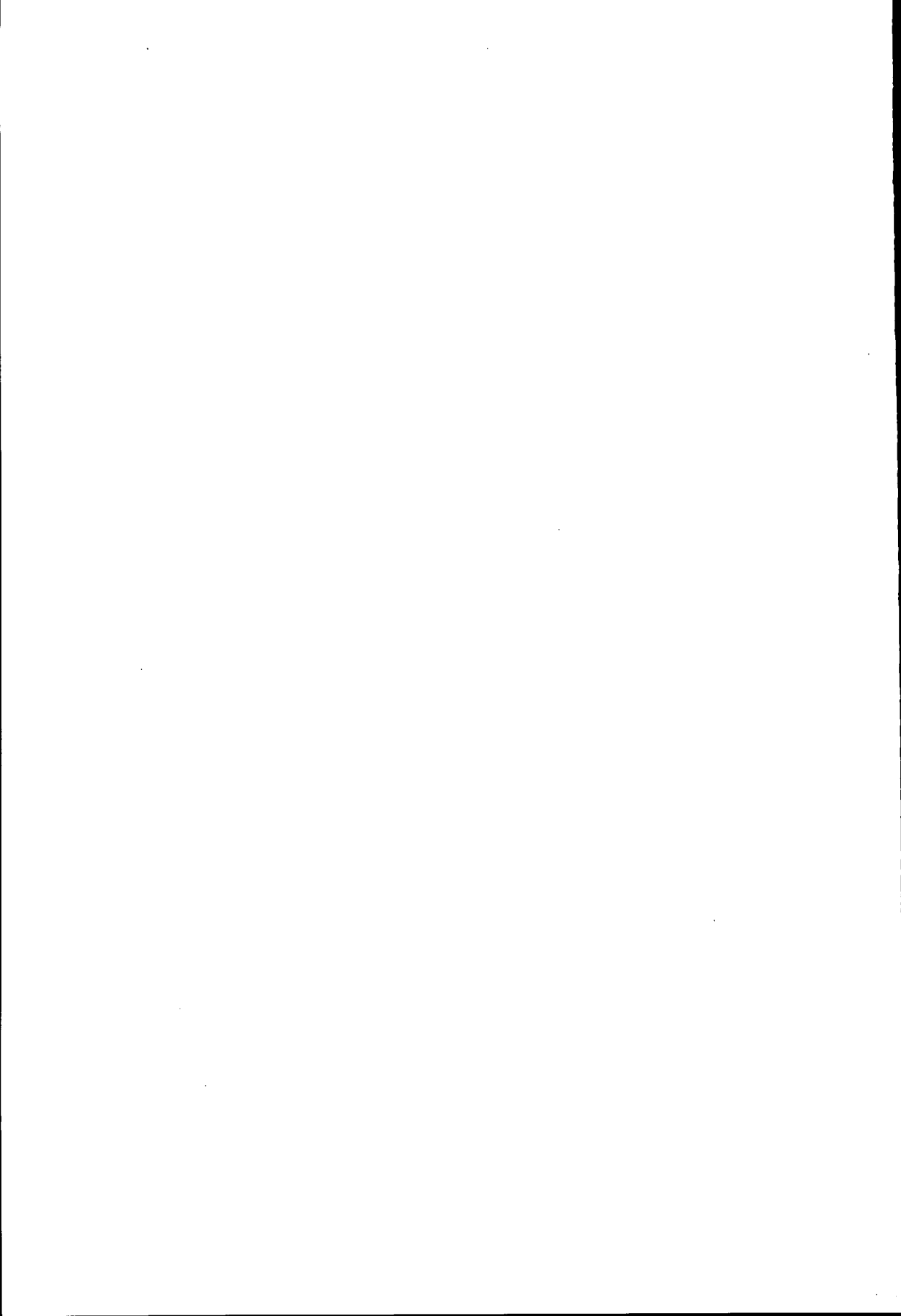

24 Gravity outlet structures

W.S. de Vries and E.J. Huyskens¹

24.1 Introduction

When agricultural lands are located along rivers, lakes, estuaries, or coastal areas, dikes can protect them from being flooded. To enable the drainage of excess water from the protected area, the dikes are provided with outlet structures. These can be sluices with doors, gated culverts, siphons, and/or pumping stations. The water levels of the canals, rivers, lakes, or seas that receive this water may vary, because of tides, for instance. When the outer water levels are high, drainage might be temporarily restricted. This means that the drainage water accumulating inside the protected area has to be stored – in the soil, in ditches, in canals, and/or in ponding areas.

This chapter focuses on gravity outlet structures (i.e. drainage sluices and gated culverts) and their design. Section 24.2 concerns the boundary conditions for the design of these structures, in particular the water levels of the receiving water ('outer water') and the water level of the area to be drained ('inner water'). As salt intrusion might be of importance for the location of the gated structure and for the elevation of its crest, Section 24.2.3 deals briefly with this topic.

Hydraulic aspects relevant to the design of a gravity outlet structure are presented in Section 24.3, which also elaborates on other design-related aspects.

24.2 Boundary Conditions

A gravity outlet forms the boundary between two bodies of water: the inner water, which is inside the drained area, and the receiving or outer water.

We can distinguish three types of drainage:

- A. Tidal drainage: The areas to be drained are situated near seas, bays, estuaries, or along tidal rivers. Drainage can take place during periods of low water (ebb tide);
 - B. Drainage to non-tidal parts of rivers: Here, because of the occurrence of high river levels, especially during rainy seasons, drainage might be restricted for relatively long periods;
 - C. Drainage to lakes or inner seas: Drainage might be hampered when water levels have risen because of wind forces; this is known as 'wind set-up' and 'storm surge'.
- A combination of A and C often occurs.

24.2.1 Problem Description

When the outer water levels are lower than the inner water levels, excess drainage water can be discharged through gravity outlet structures (Figure 24.1A). When the

¹ International Institute for Infrastructural, Hydraulic and Environmental Engineering, Delft

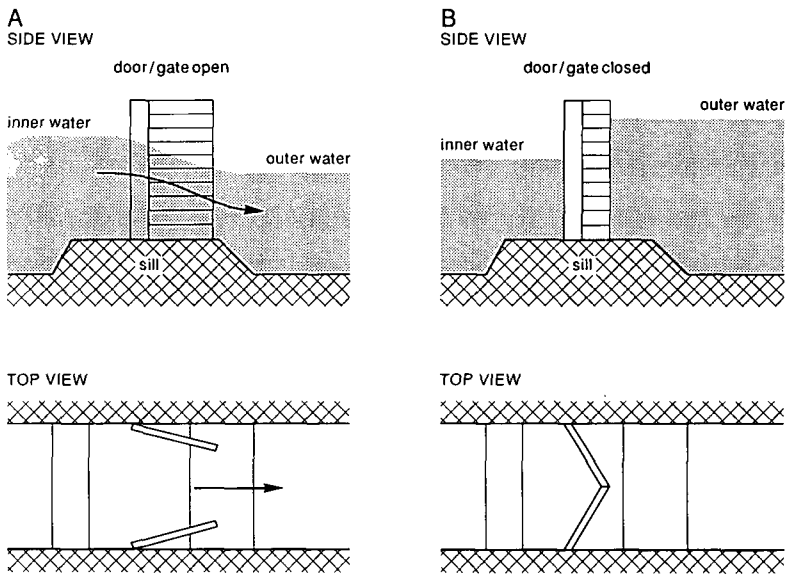

Figure 24.1 Functioning of a gravity outlet structure; A: Drainage when the outer water level is lower than the inner water level; B: No drainage when the outer water level is higher than the inner water level

outer water levels are higher, the doors or gates of the gravity outlet should be closed to prevent the intrusion of outer water and an unwanted rise in inner water levels (Figure 24.1B). During these periods of hampered drainage, the excess drainage water needs to be stored within the protected area. This storage can take place in the soil, in ditches, in canals, and/or in ponding areas. If the storage capacity in the protected area is not sufficient, drainage by pumps (in combination with gravity outlet structures) should be considered.

Figure 24.2 shows the change in the inner water level when drainage is taking place through a gravity outlet. The outer water level is under the influence of the tide. The periods when drainage takes place are called the drainage periods. During these periods, the inner water level falls. When the outlet is closed, the inner water level will rise again, because the discharge from the agricultural land continues. During these periods, the water will have to be stored in the area; these are the storage periods.

The success of a gravity outlet structure depends on the volume of storage available in the area. The storage volume should be sufficiently large to store the accumulating excess drainage water when the outlet structure is closed. When storage in soils is neglected, the available storage volume is the product of the wet surface area at a certain water level (in ditches, canals, and ponding areas) and the permissible rise of the inner water level. Of primary importance is the maximum allowable storage level.

The water levels in Figure 24.2 will be discussed in Section 24.2.4.

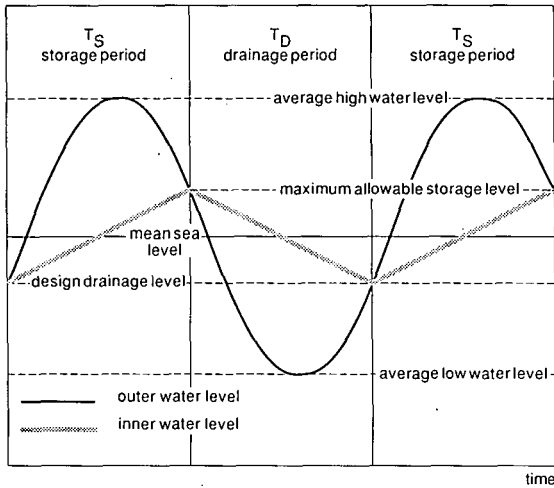

Figure 24.2 Water levels on both sides of the outlet structure

24.2.2 Outer Water Levels

Outer water levels may be under the influence of tides, river floods, density currents, waves, wind set-up, and storm surges. Possible combinations of these phenomena occur in the downstream reaches of rivers.

Three different situations of inner and outer water levels can occur:

- 1) The outer water level is always higher than the inner water level. Here, the water always has to be pumped from the drained area (Chapter 23);
- 2) The outer water level is always lower than the inner water level. This allows continuous drainage by gravity;
- 3) The outer water level fluctuates between being higher and lower than the inner water. These water level fluctuations can be caused by tides, surges, and/or river floods. Here, 'gated structures' are required.

Tides

Tides are the daily or twice-daily rise and fall of the water level in oceans, seas, and lakes. Tides are related to the attraction forces between large celestial bodies, especially the Earth, the moon, and the sun. Figure 24.3 shows the solar system.

The movements within the solar system are:

- The Earth moves around the sun in 365.256 days;
- The moon moves around the Earth in 27.32 days;
- The Earth rotates on its axis in 24 hours.

As a result of the rotation of the Earth and the movement of the moon and the sun, long waves develop and travel around the Earth. (Long waves have a very small amplitude compared to their length.) They are altered by submarine and coastal

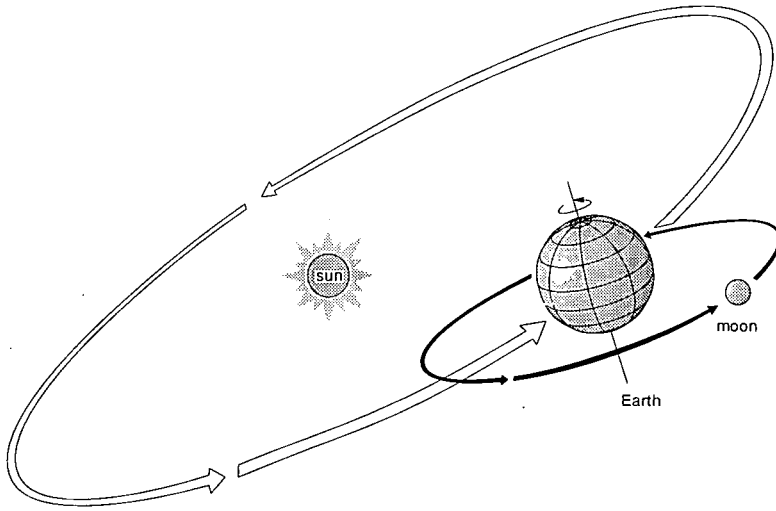

Figure 24.3 The solar system

topography, resonance in bays and estuaries, Coriolis forces, and other factors.

Tidal waves can be observed by measuring the water levels along coasts and near the mouths of rivers at regular time intervals (hours). Figure 24.4 gives an example of a tidal observation over a period of one lunar month.

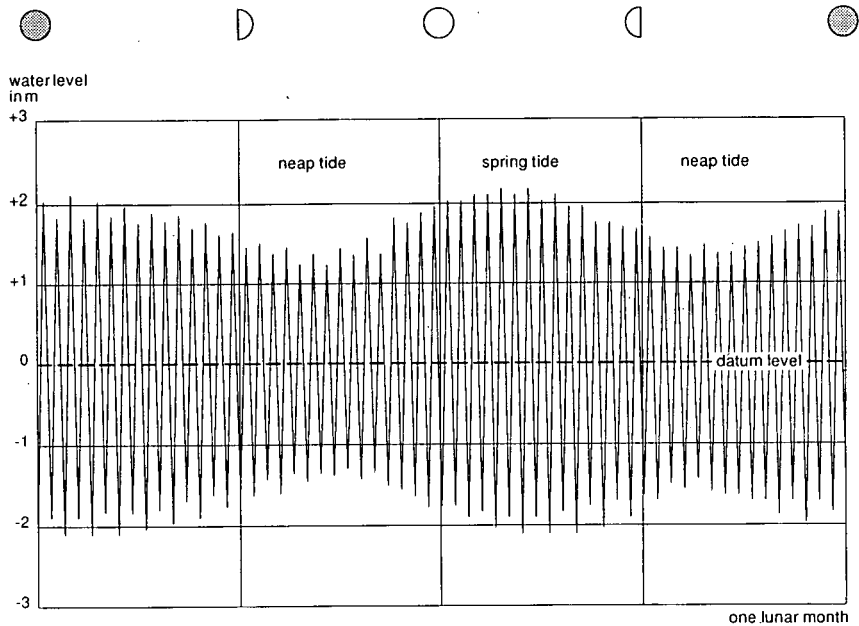

Figure 24.4 An example of the tidal fluctuations observed from new moon to new moon at Flushing, The Netherlands

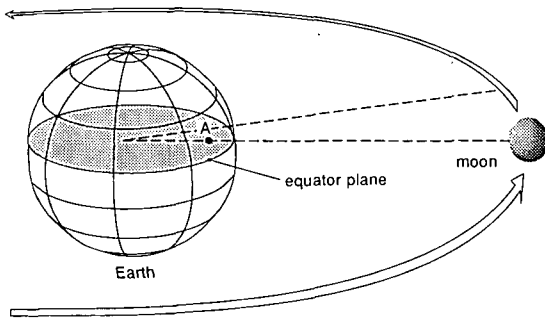

Figure 24.5 Simplified presentation of the Earth-moon system with the system's centre of gravity located at Point A

The System Earth-Moon: Lunar Tide

For an explanation of tidal phenomena, let us first consider the Earth-moon system. We simplify the system by assuming that the entire Earth is covered with a layer of water, that the moon is moving in the equator plane of the Earth, and that there is no Earth rotation.

The Earth-moon system has its centre of gravity at Point A (Figure 24.5), which means that the Earth-moon system rotates around that point. One system rotation lasts approximately 27.32 days. While rotating, the two bodies exert attraction, or gravitational forces, on each other. For the sake of equilibrium, these forces must be counterbalanced by centrifugal forces. Because of these two forces, the thickness of the water layer on Earth will increase on the side facing the moon and on the side opposite to that. In this way, some tidal deformation can already be observed (Figure 24.6).

In reality, however, the Earth rotates on its axis in 24 hours. This axis makes an angle with the Earth-moon plane, which varies between 18° and 29° : this is the moon's declination α (Figure 24.7).

If we follow the path of rotation of a certain location on Earth, we can see that two high water levels occur within a full rotation (360°). On the plane of the Earth-

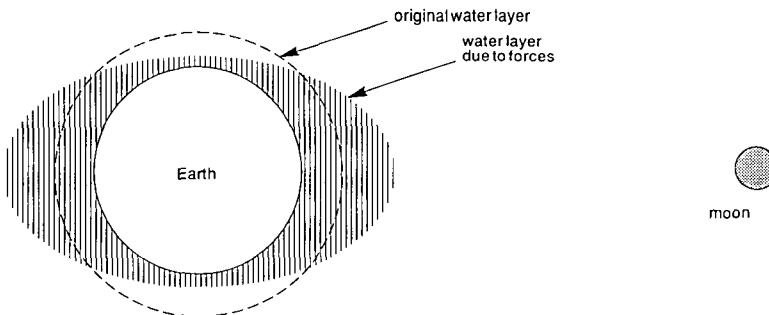

Figure 24.6 Cross-section of the Earth, indicating a deformation of the Earth's water layer by gravitational forces exerted by the moon, under the assumption that the entire Earth is covered with a layer of water

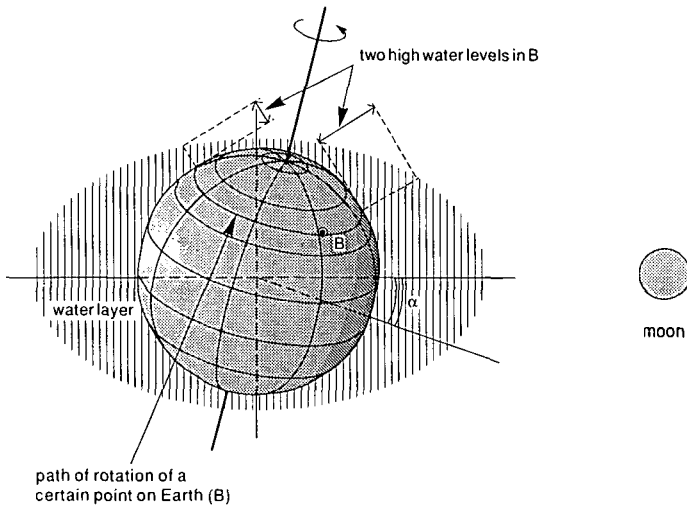

Figure 24.7 Side-view of the Earth-moon system, showing the rotation of the Earth on its axis at an angle α with the orbit of the moon (the moon's declination)

moon, the high water levels will be maximum, while, on the plane perpendicular to the Earth-moon, the high water levels will be minimum. As can be seen in Figure 24.7, the two high waters at Location B are not equal. This phenomenon is called the daily inequality (Figure 24.8), which is caused by the moon's declination. The daily inequality depends greatly on the degree of latitude.

The situation in which two high and two low waters occur in a period of about 24 hours is called a semi-diurnal tide. Considering the fact that both the Earth and the moon rotate explains the length of the period of the semi-diurnal tide. In 24 hours, the Earth makes one revolution on its axis. During that time, the moon will have

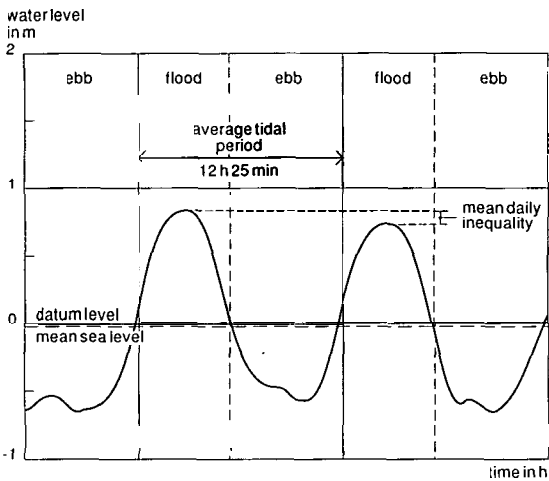

Figure 24.8 Daily inequality of tides

moved some 13° as well (being $360^\circ/27.3$ days). This implies that it takes another $(13^\circ/360^\circ) \times 24$ hours, or about 50 minutes, to arrive at the same situation as the day before. Thus a semi-diurnal tide period, being half of this time, is 12 hours and 25 minutes (= 12.42 hours).

The first assumption (i.e. that the entire earth is covered with water) still needs to be corrected. Actually, there is only a narrow strip of water all around the world, and this is located near the South Pole (63° to 64° Southern Latitude). In this channel, tidal waves are generated and from there they progress to the oceans up north. The oceanic water masses of the Earth respond in a complex manner to the tide-generating forces. The reasons for this response include:

- The effect of submarine and coastal topography, because the speed of tidal waves in oceans is a function of the depth;
- Resonance effects in bays and estuaries;
- Forces resulting from the rotation of the earth (e.g. Coriolis forces).

Because of these phenomena, the tidal form and tidal range (average difference between all high and low water levels) may differ quite substantially from one location to another. The largest tidal ranges are observed in bays, gulfs, and estuaries, where resonance occurs: e.g. 13 m in the Severn Estuary (U.K.) and 16 m in the Bay of Funda, Nova Scotia (Canada).

Influence of the Sun: Spring and Neap Tides

The sun is the other tide-generating force, although its force is only 46% of that of the moon. The period of this force is exactly 24 hours, being the rotation time of the Earth on its axis. It is because of the dominant lunar influence that tides occur fifty minutes later than on the previous day. Where the solar influence is dominant, however, (e.g. at Tahiti) tides occur at the same time each day.

During full and new moon, the forces acting on the Earth by the sun and the moon reinforce each other. Then, the attraction forces act in the same direction, which results in the largest tidal variation: spring tide. When the moon is in its first or third quarter, the gravitational forces of both celestial bodies act perpendicular to each other, resulting in the smallest variation: neap tide. Both phenomena are presented in Figure 24.9.

So, during a period of about 28 days, there will be two spring tides and two neap tides. The actual occurrence of spring and neap tide in the example of Figure 24.9 is some two days later than the occurrence of the face of the moon, because of the travel time from the South Pole areas to the place under consideration, and because of the effects of damping, reflection, and other local influences. This time difference is called the age of the tide.

Influence of Other Tidal Components

So far, we have assumed that the orbits of the moon around the Earth and of the Earth around the sun are circular. In reality, these orbits are elliptical, which implies that the distances moon-Earth and Earth-sun are not constant, but vary somewhat. For that reason, the magnitude of the tide-generating forces varies as well. Furthermore, the angle between the moon-Earth plane and the sun-Earth plane is

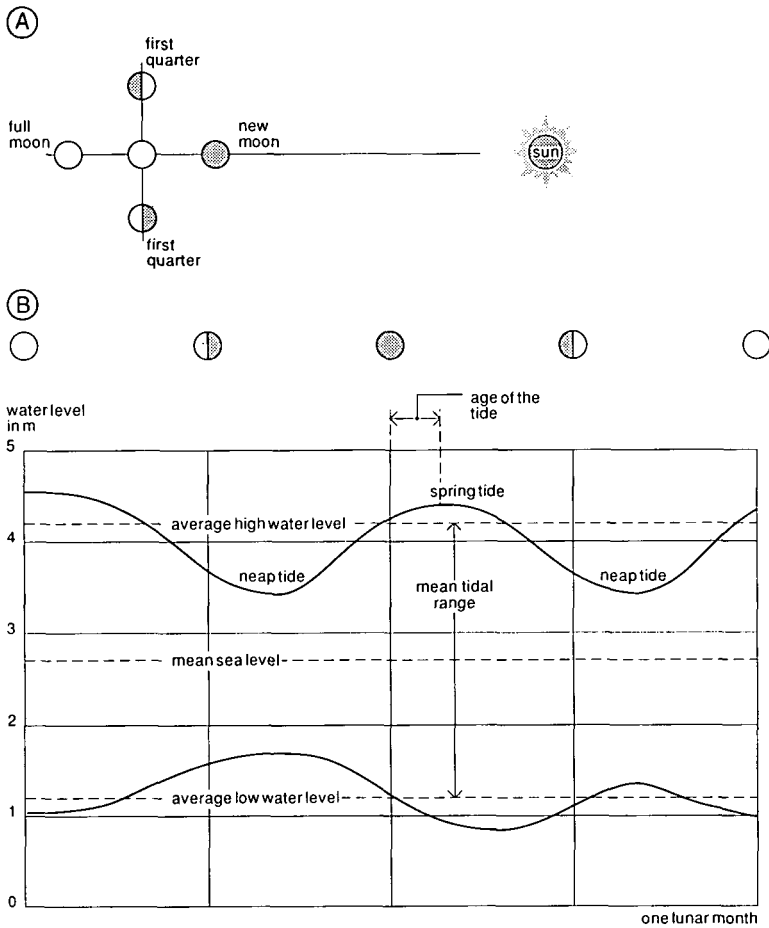

Figure 24.9 A: The lunar cycle; B: Envelopes of high and low water show the fluctuation of the tide during one lunar cycle (after Smedema and Rycroft 1983). Daily fluctuations are shown in Figure 24.4

not constant, which also has an effect on the generating forces. The above phenomena result in a complex of tidal components, of which elliptical tides are just one kind.

To explain the combined effect of all tidal phenomena satisfactorily, we shall use the Harmonic Analysis method.

Harmonic Analysis

The Harmonic Analysis is one of the methods of arriving at a mathematical description of the tide. It can be used to derive accurate tidal predictions (see also Pugh 1987, Kalkwijk 1984 and Schureman 1958). The vertical movement of the water is described as the linear superposition of tidal components, called constituents. In total, there are more than two hundred constituents with varying degrees of importance.

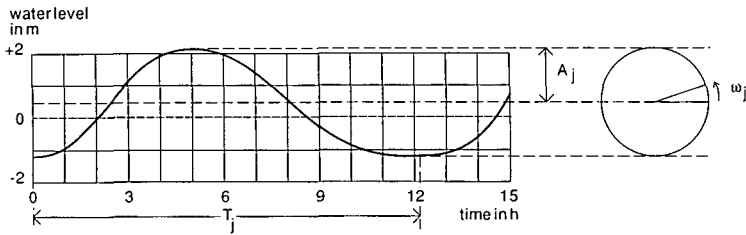

Figure 24.10 Sinusoidal curve describing the water level fluctuation due to a single constituent

Each constituent (with subscript j) can be characterized by three factors (Figure 24.10):

- Amplitude A_j : Vertical difference in height between the highest (or lowest) level and the average level in metres;
- Angular speed ω_j : Angular speed, expressed in degrees/hour: $\omega_j = 360^\circ/T_j$ (T : time in hours for a constituent to re-occur);
- Phase lag α_j : Phase lag, expressed in degrees, indicating the time difference between the passage of a celestial body through the meridian of the considered place and the real time of occurrence ('age of the tide').

The effect of an individual constituent, j , on the average sea water level follows a sinusoidal curve, which can be expressed by

$$h_j(t) = A_j \cos(\omega_j t - \alpha_j) \quad (24.1)$$

where

$h_j(t)$ = water level resulting from constituent j related to mean sea level/MSL (m)

A_j = amplitude (m)

ω_j = angular speed (degrees/h)

t = time considered (h)

α_j = phase lag (degrees)

The tidal level $h(t)$ (related to MSL), which is the combined effect of all constituents, is the result of the superposition of all these individual sinusoidal curves:

$$h(t) = h_{MSL} + \sum_{j=1}^n [A_j \cos(\omega_j t - \alpha_j)] \quad (24.2)$$

where

$h(t)$ = water level related to MSL at time t (m)

h_{MSL} = average water level (= mean sea level) (m)

For a first approximation of a tide, most of the tidal phenomena can be described quite effectively by a relatively small number of constituents.

Table 24.1 presents the characteristics of the four most important tidal constituents.

Table 24.1 Most important tidal components

Symbol	Description	ω_j (degrees/h)	T_j (h) (= $360^\circ/\omega_j$)
M_2	Main lunar tide	28.98410	12.42
S_2	Main solar tide	30.00000	12.00
K_1	Sun/moon declination tide	15.04107	23.93
O_1	Moon declination tide	13.94303	25.82

Types of Tides

Depending on the geographical location, the following types of tides can be distinguished (Figure 24.11):

- Diurnal tides: These tides have one high water and one low water each lunar day (24 hours, 50 minutes);

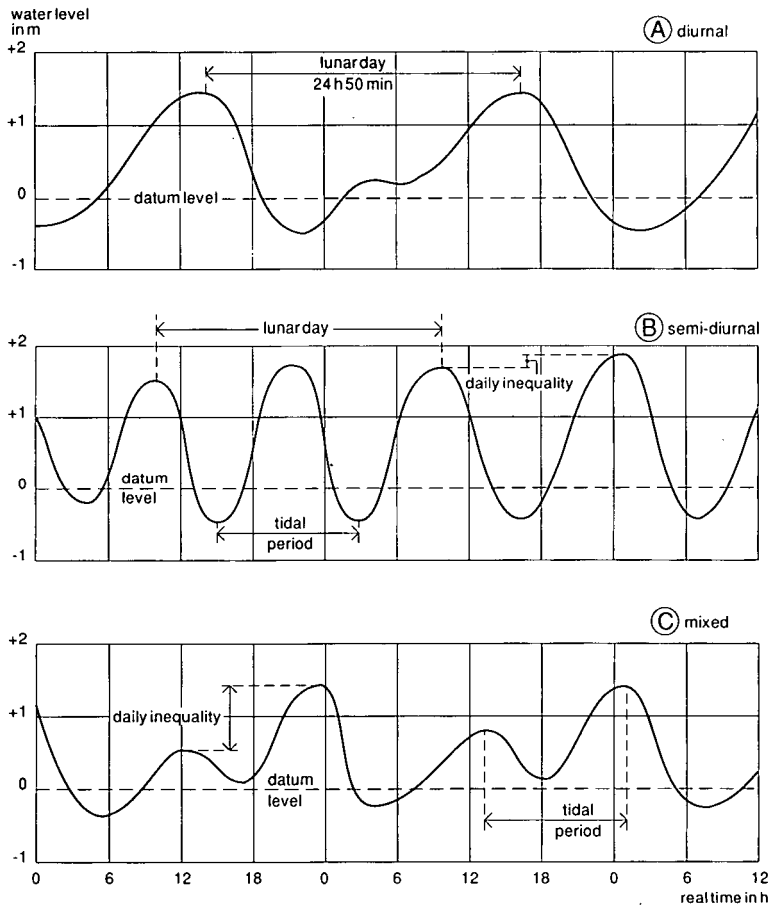

Figure 24.11 Types of tides; A: Diurnal tide; B: Semi-diurnal tide; C: Mixed tide

- Semi-diurnal tides: These are tides with two almost equal high waters and two almost equal low waters each lunar day. The differences between the two high waters and between the two low waters are so small that they can be represented by one value for the high waters and one value for the low waters per lunar day;
- Mixed tides: Mixed tides have different high waters, different low waters, or both, within one lunar day.

The type of tide (diurnal, semi-diurnal, or mixed) occurring in an area and the tidal range depend on a rather complex process of damping and amplifying.

Tidal Prediction

Tidal prediction is based on the principle of the Harmonic Analysis. The unknown characteristics of each constituent (phase and amplitude) at a given location can be obtained by analyzing measured tidal data. At the proposed site of a gravity outlet structure, the tidal data should be obtained with staff gauges or automatic gauges; an automatic gauge should always be complemented with a staff gauge to allow for periodic checking. The level of the gauge should be referenced to permanent and protected benchmarks. Wind effects can be eliminated from the observations through readings at more or less windless moments and/or by taking observations over longer periods.

To check the reliability of the measured data, they should be correlated with records from the nearest permanent tidal observation station, which can be found in ports and harbours (Correlation methods were discussed in Chapter 6, Section 6.6). In this way, an insight can be obtained into the local effects that influence the shape of the tidal curve. When it is possible to determine a correlation between the two locations (under the condition that the records of the permanent observation station cover a sufficiently long period), a prediction of tidal levels can be made.

To predict a tide in accordance with the Admiralty Method (Schureman 1958), continuous observations at hourly intervals over a minimum period of 29 days are required, so that phenomena like spring and neap tide are included. Longer observations are required to eliminate other effects (like wind set-up, storm surges, and variations in water levels due to changes in barometric pressure). If the area to be drained is on a tidal river, the measuring period should cover a wet and a dry season as well.

A third method of tidal analysis is the Method of Least Squares (Kalkwijk, 1984). The tidal characteristics can be determined through minimizing the difference between a measured tidal signal and a basic sinusoidal function in which the unknown constituents are included. With the help of regression techniques, a best fit can be obtained. A great advantage of this method is that gaps in a registration (incomplete sets of data because, for instance, of the improper functioning of instruments, which occurs very often in practice) are not disastrous.

Influence of Tides on Downstream River Levels

In the downstream reaches of rivers that discharge into a sea or an ocean, water levels are influenced by the tides. These river reaches are called tidal rivers. In accordance with the propagation of the astronomical tides, a river can be subdivided into the

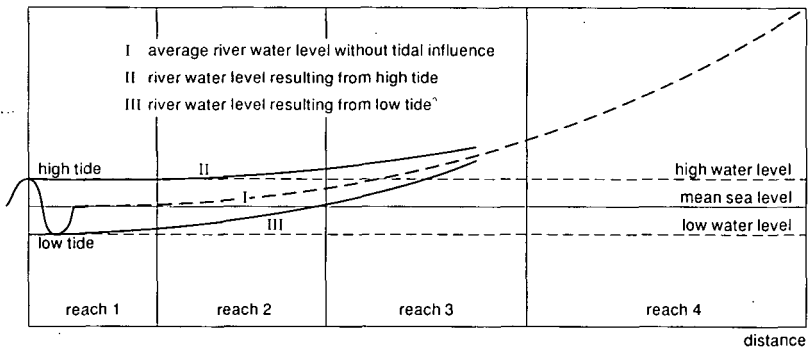

Figure 24.12 Subdivision of the deltaic reach of a river into four reaches according to the propagation of tides

following reaches (Figure 24.12):

- Reach 1: Where vertical tides occur with subsequent reversal of the current direction and where intrusion of saline water occurs;
- Reach 2: Where the river water is fresh, but otherwise the tidal phenomena are similar to those in Reach 1;
- Reach 3: Where the water levels are still affected by the tides, but where the current direction remains in downstream direction; the velocity, however, varies in accordance with the tide;
- Reach 4: Where the water levels and the flow depend upon the upstream discharges only.

In accordance with the propagation of high sea water levels, the river can be divided into three reaches (Figure 24.13):

- Reach a: Where the effect of sea levels predominates;
- Reach b: Where a combined effect of the sea and river floods occur (intermediate zone);
- Reach c: Where the effect of river floods predominates.

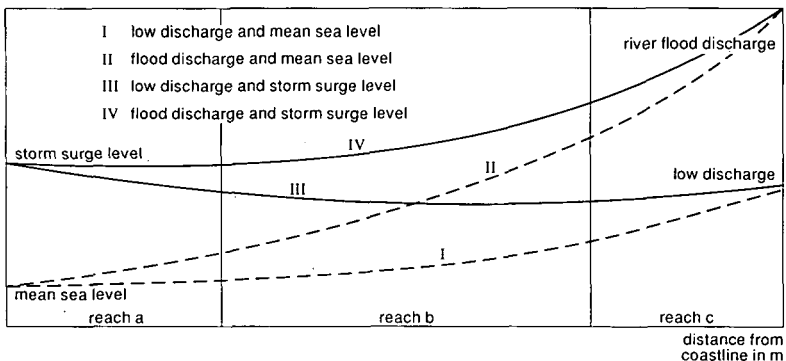

Figure 24.13 Subdivision of the deltaic reach of a river into three reaches according to the type of predominant floods

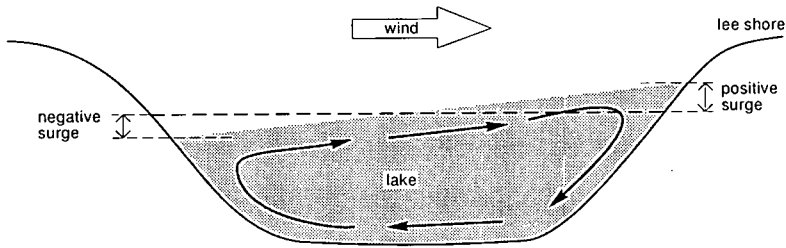

Figure 24.14 Effect of surges on the water level of an enclosed lake. The wind causes a current to the lee shore of the lake, which is compensated for by a return current on the bottom

The propagation of abnormally high sea levels, in combination with the effect of river floods, is an important factor in the design of outlet structures. To be able to determine the most unfavourable outer water level for the design of an outlet structure, one has to determine in which river reach the outlet will be located.

Tidal Currents

The vertical tidal movements, called vertical tides, are caused by the astronomical forces. In their turn, the vertical tides create tidal currents, which are called horizontal tides. These horizontal tides appear, for instance, at the entrance of a bay that is under tidal influence. They are a function of the tidal volume (i.e. the quantity of water passing between high and low water), because in each tidal cycle the tidal volume has to enter and leave through the entrance to the bay. The direction of the tidal current is into the bay when the water level is rising. At high water or slightly later, the current will be zero (= high water slack). With falling water, the current is directed out of the bay, reaching a maximum at mean sea level and decreasing to zero just after low water (= low water slack).

Storm Surges

Abnormal meteorological conditions can cause large deviations from the computed tidal levels. In this respect, the wind is the most important factor. Any variations that cause a rise (or a fall) of the water level above (or below) the computed level through the action of wind is called a storm surge. Gales may cause the outer water level to rise or fall by several metres in large waterbodies.

Figure 24.14 shows a wind surge in an enclosed lake. The current near the water surface, which is induced by the wind and results in a positive storm surge on the lee shore of the lake, is compensated for by a return current along the bottom. After some time, an equilibrium situation will develop.

Variations in barometric pressure may also cause deviations from the computed tide. This effect, however, is much smaller than that of the wind, being of the order of one centimetre per millibar.

The effect of a surge on expected tidal levels can be seen in Figure 24.15. It can be observed that the resulting water level is a linear superposition of expected levels and surge levels.

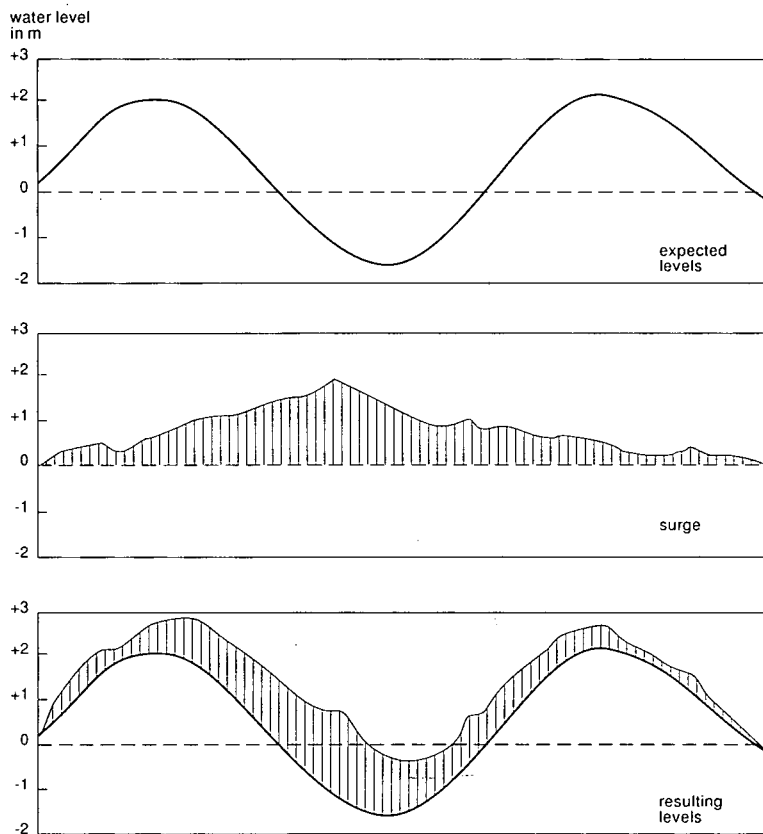

Figure 24.15 Effect of a surge on expected tidal levels

River Floods

River floods are caused by the discharge of extreme runoffs (originating from upstream catchment areas) or by local rainfall. The characteristics of the river basin and the catchment area determine the characteristics of the flood: i.e. its duration, peak, and shape.

Gentle floods occur in rivers with relatively large catchment areas and long travel times to the river mouths (e.g. the Chao-Phrya in Thailand with a catchment area of 160 000 km²).

Flash floods occur in steep areas with relatively short rivers (e.g. the Cho-Shui in China with a catchment area of 3150 km²; Figure 24.16).

For design purposes, representative floods are needed. These can be obtained by establishing the relationship between river water levels at the site of the proposed gravity outlet structure and their frequency of occurrence. Such a relationship should be based on records covering a sufficiently long period. On the basis of a selected return period (e.g. 5 or 25 years), the design flood can be found (see also Chapter 6 Frequency Analysis.)

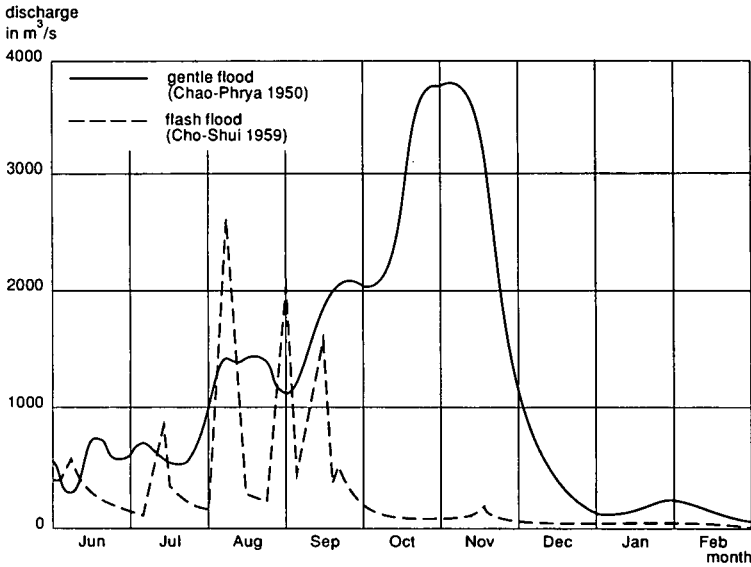

Figure 24.16 Typical hydrographs of gentle floods and flash floods

24.2.3 Salt Intrusion

Along coasts, estuaries, and tidal rivers, salt and brackish water pose a constant threat to agriculture. Salt water intrudes into estuaries in the upstream direction, because the density of the salt sea water is higher than that of the fresh river water ($\rho_s = 1028 \text{ kg/m}^3$, $\rho_f = 1000 \text{ kg/m}^3$). The rate of intrusion and the kind of mixing in the estuary depend on the river discharge, the tidal period, and the flood volume (i.e. the volume of water that enters the estuary in the period between low and high tide). It can be classified by the mixing parameter α .

$$\alpha = \frac{Q T}{A_o E} \tag{24.3}$$

where

- α = mixing parameter: the ratio between the river discharge and the flood volume (-)
- Q = river discharge (m^3/s)
- T = tidal period (s)
- A_o = cross-section at the estuary mouth (m^2)
- E = tidal excursion: the distance which a water particle travels along the estuary between low water slack and high water slack (m)

As can be seen in Figure 24.17, extreme intrusions occur in periods when the river discharge is low (i.e. the dry season).

To investigate whether the envisaged location of a gravity outlet structure is subject to salt intrusion or not, water samples should be taken along a stretch of some 10

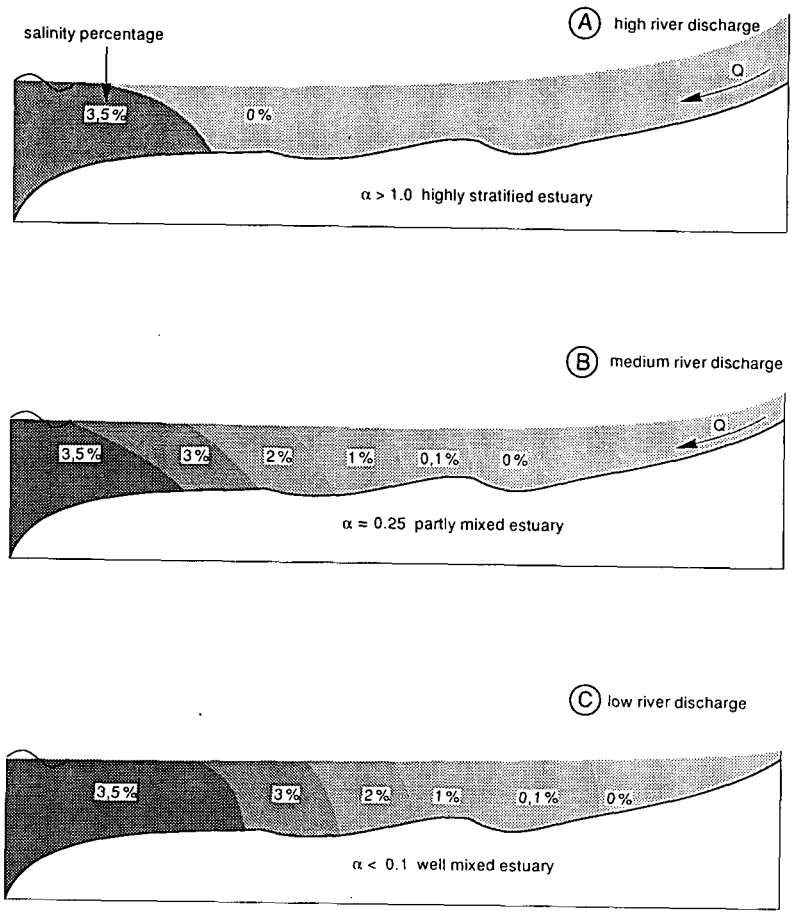

Figure 24.17 Various types of mixing in an estuary; A: Stratified estuary; B: Partially mixed estuary; C: Mixed estuary (Savenije 1992)

km upstream and some 10 km downstream of the location, at intervals of, say, 1 km. This sampling should be done at high water spring tide during the dry season (when the river discharge is low). In this way, one can obtain a longitudinal profile that shows the change in salt concentration as a function of the location of the envisaged gravity outlet.

To facilitate the choice of the sampling locations, two calculation methods will be presented.

The calculation method of Van Os and Abraham (1990) determines the minimum salt intrusion length, measured from the mouth of the estuary. For this determination, the 'estuary densimetric Froude number' Fr_o needs to be determined.

$$Fr_o = \frac{u^2}{\frac{\rho_s - \rho_f}{\rho} g h_o} \quad (24.4)$$

where

- Fr_o = estuary densimetric Froude number (-)
- u = maximum mean ebb flow velocity (profile averaged; m/s)
- ρ_s = density of sea water (kg/m^3)
- ρ_r = density of fresh river water (kg/m^3)
- ρ = density of either sea water or river water (kg/m^3)
- g = acceleration due to gravity (m/s^2)
- h_o = water depth at the mouth of the estuary (m)

The minimum salt intrusion length can then be determined by

$$L_{min} = 0.55 \frac{C^2 h_o}{Fr_o g \alpha} \quad (24.5)$$

where, in addition to the symbols already defined,

- L_{min} = minimum salt intrusion length (m)
- C = Chézy coefficient: for estuaries approximately 60-70 ($m^{1/2}/s$)

To find the maximum intrusion length, the tidal excursion length E should be added to L_{min} . The order of magnitude of E is about 10 km for a semi-diurnal tide and about 20 km for a diurnal tide.

A second method of determining salt intrusion in estuaries is the Savenije method (Savenije 1992). With this method, the maximum salt intrusion length can be determined directly

$$L_{max} = L_b \ln \left(\frac{220 u E h_o A_o}{K Q L_b^2} \sqrt{\frac{\alpha}{Fr_o} \frac{\rho}{\rho_s - \rho_r}} + 1 \right) \quad (24.6)$$

where

- L_{max} = maximum salt intrusion length (m)
- L_b = convergence length, which follows from the relation $A_x = A_o e^{-x/L_b}$ and can be determined by a regression of A_x on x (m)
- A_x = cross-section at distance x (m^2)
- x = distance from the estuary mouth (m)
- A_o = cross-section at the river mouth (m^2)
- K = Van de Burgh coefficient: $K = 0.075 \times h_o$ (-)

Both methods give a good indication of the order of magnitude of the salt intrusion length in tidal rivers and estuaries.

Example 24.1: Rotterdam Waterway

The following data are given:

- Q = 1550 m^3/s
- T = 12 hours 25 minutes = 44 700 s
- A_o = 6478 m^2
- E = 14.5×10^3 m
- u = 1.1 m/s

$$\begin{aligned}
\rho &= 1000 \text{ kg/m}^3 \\
\rho_s &= 1025 \text{ kg/m}^3 \\
g &= 9.8 \text{ m/s}^2 \\
h_o &= 15.8 \text{ m} \\
C &= 60 \text{ m}^2/\text{s} \\
L_b &= 1.0 \times 10^5 \text{ m} \\
H &= 1.7 \text{ m}
\end{aligned}$$

A Van Os and Abraham

To determine the minimum salt intrusion length, first the mixing parameter α and the densimetric Froude number are determined

$$\text{Equation 24.3: } \alpha = \frac{1550 \times 44700}{6478 \times 14.5 \times 10^3} = 0.74$$

$$\text{Equation 24.4: } Fr_o = \frac{1.1^2}{\frac{1025-1000}{1025} \times 9.8 \times 15.8} = 0.32$$

Now the minimum salt intrusion length can be determined

$$\text{Equation 24.5: } L_{\min} = 0.55 \frac{.60^2 \times 15.8}{0.32 \times 9.8 \times 0.74} = 13.5 \text{ km}$$

This length is almost the same as the observed one (16 km).
The maximum intrusion length becomes

$$L_{\max} = L_{\min} + E = 28 \text{ km}$$

Within the accuracy of the input data, the conclusion is that L_{\max} will be in the range of 21 to 35 km.

B Savenije

This method also uses the mixing parameter α ($= 0.74$). Furthermore, the Van de Burgh coefficient needs to be determined

$$K = 0.075 \times h_o = 0.075 \times 15.8 = 1.19$$

Now the maximum salt intrusion length can be calculated

$$\text{Equation 24.6: } L_{\max} = 10^5 \times \ln \left(\frac{220 \times 1.1 \times 14.5 \times 10^3 \times 15.8 \times 6478}{1.19 \times 1550 \times 10^{10}} \sqrt{\frac{0.75}{0.32} \times \frac{1025}{1025 - 1000}} + 1 \right) = 17 \text{ km}$$

Given the accuracy of the input data, L_{\max} will be in the range 12 to 22 km.
Combining the outcome of the two methods leads to the conclusion that L_{\max} will most probably be in the range of 16 to 29 km.

Example 24.2: Chao Phrya

The following data are given:

$$\begin{aligned}
Q &= 150 \text{ m}^3/\text{s} \\
T &= 44 \text{ 700 s}
\end{aligned}$$

$$\begin{aligned}
A_o &= 4250 \text{ m}^2 \\
E &= 22 \times 10^3 \text{ m} \\
u &= 1.5 \text{ m/s} \\
\rho &= 1000 \text{ kg/m}^3 \\
\rho_s &= 1025 \text{ kg/m}^3 \\
g &= 9.8 \text{ m/s}^2 \\
h_o &= 8 \text{ m} \\
C &= 60 \text{ m}^{1/2}/\text{s} \\
L_b &= 1.09 \times 10^5 \text{ m} \\
H &= 2.3 \text{ m}
\end{aligned}$$

A Van Os and Abraham

$$\text{Mixing parameter: } \alpha = \frac{150 \times 44700}{4250 \times 22 \times 10^3} = 0.07$$

$$\text{Densimetric Froude number: } Fr_o = \frac{1.5^2}{\frac{1025-1000}{1025} \times 9.8 \times 8} = 1.18$$

$$\text{Minimum salt intrusion length: } L_{\min} = 0.55 \frac{60^2 \times 8}{1.18 \times 9.8 \times 0.07} = 20 \text{ km}$$

In this case, a minimum salt intrusion length of 17 km was observed.

$$\text{Maximum salt intrusion length: } L_{\max} = L_{\min} + E = 42 \text{ km}$$

B Savenije

$$\text{Van de Burgh coefficient: } K = 0.075 \times 8 = 0.60$$

Maximum salt intrusion length:

$$\begin{aligned}
L_{\max} &= 1.09 \times 10^5 \times \ln \left(\frac{220 \times 1.5 \times 22 \times 10^3 \times 8 \times 4250}{0.60 \times 150 \times (1.09 \times 10^5)^2} \right. \\
&\quad \left. \sqrt{\frac{0.07}{1.18} \times \frac{1025}{1025-1000} + 1} \right) = 33 \text{ km}
\end{aligned}$$

For this case, the actual L_{\max} will most probably be in the range of 29 to 46 km.

24.2.4 Inner Water Levels

The drainage system will have to store the excess drainage water and convey it from the drained area in such a way that, on the basis of the desired groundwater levels in the field, the inner water levels remain in between the following two boundaries (see also Figure 24.2):

- Design Drainage Level/DDL: The DDL is the lower boundary. If the water drops below this level, damage may occur, e.g. crops may suffer from water stress due

- to too low a groundwater level, navigation may be hampered, and/or side slopes may become unstable.
- Maximum Allowable Storage Level/MASL: As the water level cannot be kept at DDL constantly (this would lead to economically unfeasible drainage systems), there is a need to define a highest boundary: the MASL. This boundary is equal to the DDL, plus the maximum tolerable rise of the water level in the system. The MASL is determined by the agricultural drainage criteria on which the design of the field drainage system is based (Chapter 17) and by the design criteria which apply to the main drainage system (Chapter 19). The determination of MASL is also based on economic considerations: it is the level at which the investments needed in the drainage system (enlarging storage capacity) outweigh the risk of economic losses (chance of exceeding MASL, multiplied by losses incurred by yield reduction or damage to canals, structures, housing, etc.).

Depending on the envisaged land use and on the operation and maintenance requirements of the drainage system, the DDL and the MASL may vary throughout the year. For the design of the outlet structure, the most unfavourable levels should be selected in combination with the highest outer water levels: usually this will be the lowest DDL and MASL and/or the smallest difference between MASL and DDL.

24.3 Design of Gravity Outlet Structures

This section reviews the various types of gravity outlet structures, presents the relationships between storage and the hydraulic design of gravity outlets, and formulates guidelines for selecting hydraulic dimensions.

24.3.1 Types of Gravity Outlet Structures

Gravity outlet structures can be a drainage sluice with doors, a gated culvert, or a siphon.

Drainage Sluice

A drainage sluice consists of a weir and a set of doors. Each of the two doors hinges around a vertical axis, and is positioned in such a way that inner water can flow freely to the outer water, whereas they prevent a flow in the opposite direction (Figure 24.18).

The doors will remain closed as long as the pressure from the outer water is greater or equal to the pressure from the inner water. In case of fresh water on both sides, an equilibrium situation occurs when the water levels on both sides are equal. When the outer waters are salty, or when they contain a considerably larger sediment load than the inner waters, the densities differ, so that an equilibrium situation will occur when the inner water level is higher and compensates for the (denser) outer water. In case of salt outer water, the inner water level must be around 1.012 times the outer water level to have equilibrium (Section 24.3.3).

A drainage sluice can be self-operating, manually operated, or automatically operated.

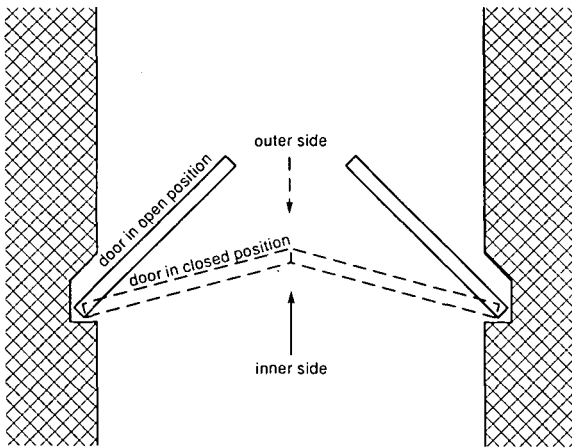

Figure 24.18 Plan view of an outlet sluice with vertical doors (Smedema and Rycroft 1983)

The principle of self-operation is based on differences in water pressure. As soon as the pressure exerted by the inner water against the doors exceeds the pressure of the outer water, the doors will open and water will flow out of the drained area. The doors close when the pressure from the outer water is higher than the inner. For this kind of operation, the sluice should be fitted with vertical doors, which should be constructed as indicated in Figure 24.18. In closed position, the doors should form a 'V' to counteract the outer pressure. In open position, the doors should not be allowed to open entirely to enable the outer water to exert the pressure that is needed to close the doors again. To facilitate and quicken the closing process, the doors must be balanced in such a way that only little overpressure is needed to close them in a very short time (seconds).

It should be noted that the overpressure needed to operate the doors is also needed to overcome friction forces.

Manual operation requires a watchman, who monitors the levels and operates the doors in accordance with a given strategy. In the case of automatic operation this process is automated.

Drainage sluices enable self-operation and offer possibilities for navigation during the drainage period, provided that the water velocities in the sluice are not too high. Other advantages are that, by applying two doors, larger single openings can be realized, that no energy supply is required, and that no personnel is needed to operate them. Therefore, drainage sluices can even be applied in remote areas. Nevertheless, there are certain circumstances where the operation of the drainage sluice should be either manual or automated: if there is an infrequent need to use the drainage sluice (e.g. where the outer water levels fluctuate with the season), when large waves play a role (so that the doors would be continuously opening and closing because of fluctuating outer water levels), and/or when quality control of inner or outer water is required. In these circumstances, the water levels on either side of the doors should

be monitored, either by man or by measuring equipment, and the doors should be opened when the outer water levels are sufficiently lower than the inner levels.

From a hydraulic point of view, the drainage sluice can be considered a broad-crested weir, which means that the streamlines over the weir are practically straight and parallel. To obtain this situation, the length (L) of the weir crest should be related to the total upstream energy head (H) as $0.07 \leq H/L \leq 0.50$. A smooth transition between the crest and the downstream slope reduces the head loss over the structure. The recommended slope of the downstream face of the weir equals 1:6 (Figure 24.19).

Assuming that the flow upstream of the weir is sub-critical, two different flows may occur over it, namely sub-critical and critical flow. These flow conditions have their own flow pattern and corresponding equations for calculating the discharge. Note that these equations can be applied for steady-state conditions only.

According to Chapter 7, Section 2.4, the total upstream energy level is defined as

$$H = h_u + \frac{v_u^2}{2g} \quad (24.7)$$

where

H = upstream energy level (m)

h_u = upstream water level (m)

v_u = upstream flow velocity (m/s)

g = acceleration due to gravity (m/s^2)

The energy levels are defined relative to the weir crest.

Subcritical Flow

Subcritical flow occurs when the weir is submerged, i.e. when $h_d \geq 2/3 H$ (Figure

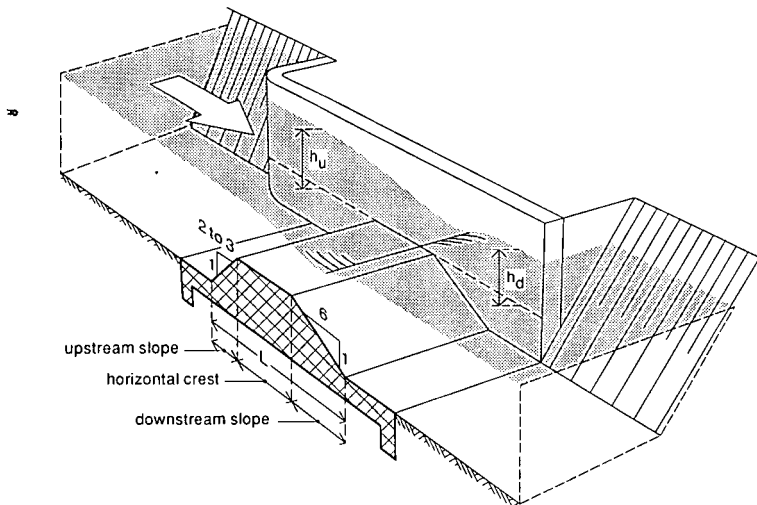

Figure 24.19 The broad-crested weir

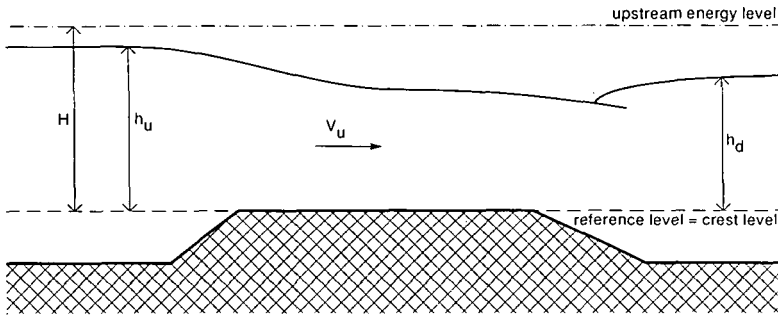

Figure 24.20 Subcritical flow over a weir

24.20). This means that the discharge depends on the upstream energy level and the downstream water level.

$$\text{for } h_d \geq \frac{2}{3} H: Q = \mu b h_d \sqrt{2g(H-h_d)}$$

When the upstream flow velocity remains low, the velocity head $v_u^2/2g$ is small and can be neglected. The upstream energy level H in the above equation can be replaced by the upstream water level h_u .

$$\text{for } h_d \geq \frac{2}{3} h_u: Q = \mu b h_d \sqrt{2g(h_u-h_d)} \quad (24.8)$$

where, in addition to the symbols already defined

Q = discharge (m^3/s)

b = width of the outlet (m)

h_d = downstream water level (m)

μ = discharge coefficient, which includes losses due to friction and contraction over the weir (-)

Thijsse (see De Vries et al. 1947-1951) gives some indicative values of μ , valid for subcritical flow conditions.

$\mu = 1.3$ for smooth surfaces, rounded crests, gentle downstream slope, small difference in head

$\mu = 1.1$ for average conditions

$\mu = 0.9$ for rough surfaces, sharp crests, steep downstream slope, large difference in head

Critical Flow

Flow is in a critical state when the inertial and gravitational forces are in equilibrium, which occurs when the Froude number equals 1. The Froude number can be determined by

$$Fr = \frac{v}{\sqrt{g R \cos s}} \quad (24.9)$$

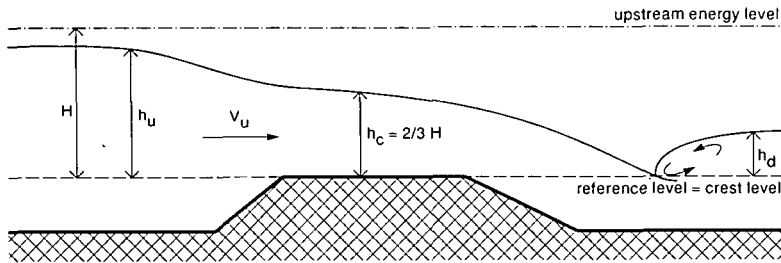

Figure 24.21 Critical flow over a weir

where

Fr = Froude number (-)

v = average flow velocity (m/s)

R = hydraulic radius, being the wetted area divided by the wet perimeter (m)

s = slope of the energy line (-)

For a constant upstream water level, maximum discharge occurs during critical flow, i.e. when the discharge is independent of the downstream water level ($h_d < 2/3 H$) (Figure 24.21)

$$\text{for } h_d < \frac{2}{3} H: \quad Q = C_d b \frac{2}{3} H \sqrt{2g \frac{1}{3} H}$$

or by neglecting the velocity head v_u

$$\text{for } h_d < \frac{2}{3} h_u: \quad Q = C_d b \frac{2}{3} h_u \sqrt{2g \frac{1}{3} h_u} \quad (24.10)$$

where

C_d = discharge coefficient (-)

Note that under critical flow conditions, the water level above the crest (critical depth h_c) depends on the upstream energy level as

$$h_c = \frac{2}{3} H \approx \frac{2}{3} h_u \text{ (m)}$$

The discharge coefficient C_d includes losses due to friction and contraction and depends on the shape of the weir and the upstream water level. The value of C_d can be determined as $C_d = 0.93 + 0.10 H/L$ for $0.10 \leq H/L \leq 0.70$ (Bos 1989).

Gated Culverts

Gated culverts are applied when the outlet structure does not have a navigation function. The cross-section of a culvert can be circular, square, or rectangular. An advantage of a culvert is that the top of the embankment (inspection road) will remain undisturbed.

To prevent the outer water from entering the drained area, the structure is fitted with a gate, which can be operated either by hydraulic forces or manually. The

operation principle is almost the same as for sluice doors, the main difference being that the gate usually rotates around a horizontal axis. In closed position (during high outer water levels), the door slants slightly outwards, which is preferred to the vertical position because it closes better (its own weight component helps keep it closed). In times of discharge, the gate will not open completely, thereby ensuring that it will close when the outer water level rises again. These gates are called 'flap gates' (Figure 24.22).

Compared with the drainage sluice, self-operating gated culverts will have extra head loss during discharge, because extra head is not only needed for the flow through the culvert and to open the door, but also to compensate for the weight of the gate. Nevertheless, by applying relatively light material, counterweights, and minimal friction in the hinges, flap gates with head losses of practically nil have been developed.

As manually and automatically operated gates can be fully removed from the flow, they will not disturb the flow, so that no extra head loss will occur with such gates.

To calculate the discharge through a culvert, basic formulae for culvert flows can be used (e.g. French 1986; Chow 1959; USBR 1983). For practical purposes, six types of culvert flow can be identified (Figure 24.23).

A culvert will have full flow when the downstream end is submerged (Type 1). If the downstream end is not submerged, the culvert will have full flow when the upstream water level is high (i.e. when $h_u > 1.5d$) and the culvert can be regarded as hydraulically long (Type 2). Whether a culvert is hydraulically long or short depends on factors such as the bottom slope, the ratio between the culvert length and height (L/d), the ratio between the entrance radius and the culvert height (r/d), and the water levels at both ends. When $h_u > 1.5d$ and the culvert is hydraulically short, the flow is of Type 3. When the upstream water level is less than $1.5d$, the downstream water level may be higher than the critical depth of the flow (Type 4). For lower downstream water levels, flow will be of Type 5 when the slope of the culvert bottom is subcritical, and of Type 6 when the slope is supercritical.

For Flow Types 4, 5, and 6, the entrance of the culvert acts like a weir and the discharge coefficient varies approximately between 0.75 and 0.95 (Chow 1959).

Note that, in the profiles shown in Figure 24.23, contraction due to the valve at the downstream side of the culvert is ignored. This is allowed only for manually operated gates.

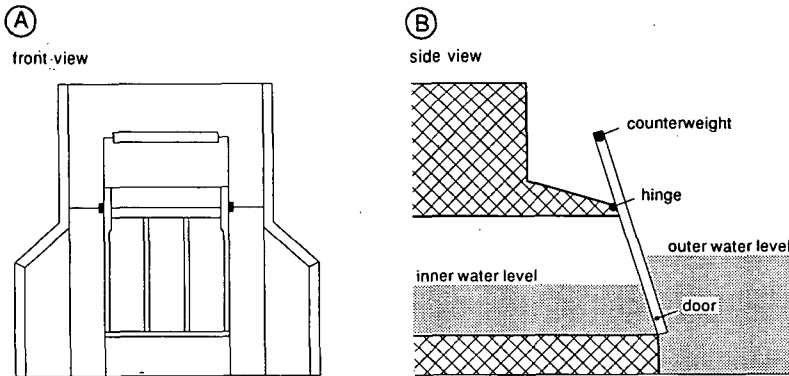

Figure 24.22 Flap gate: A: Front view; B: Side view

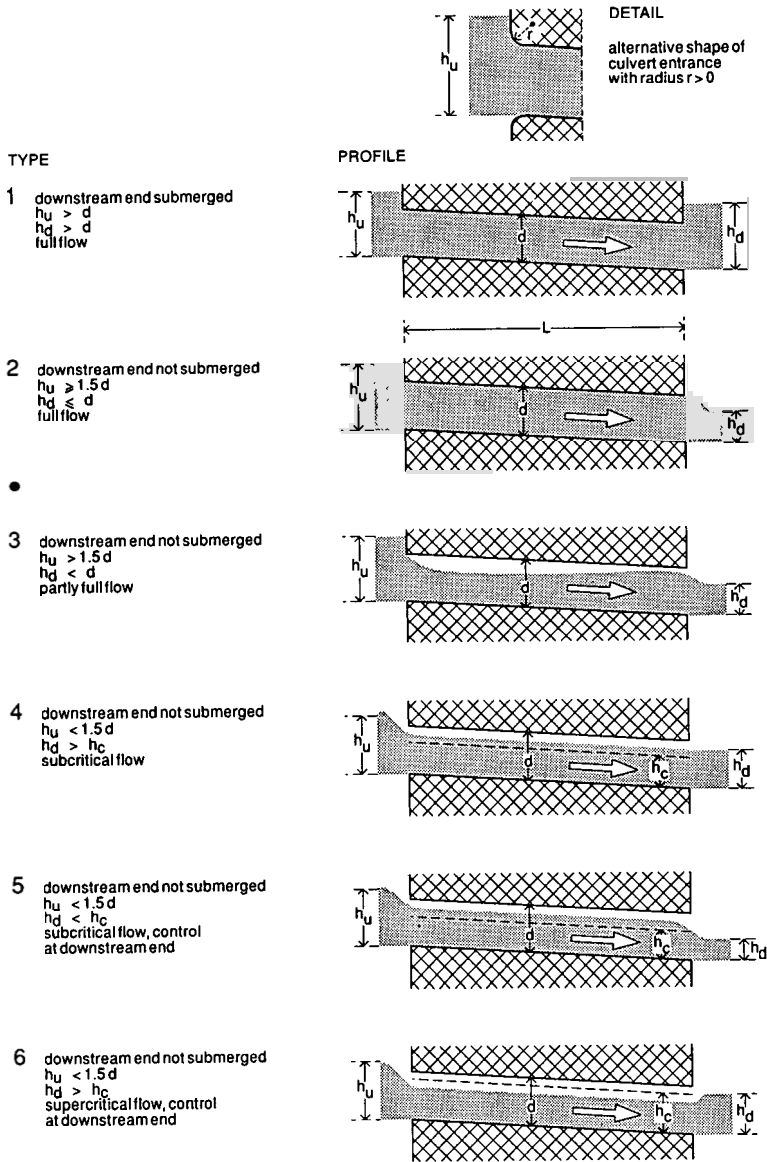

Figure 24.23 Classification of culvert flow

Siphons

A siphon consists of a closed conduit siphoning the water through an embankment that separates the drained area from the outer waters. Siphons are seldom applied as gravity outlets. The hydraulic calculation of flow through siphons is based on pipe-flow principles. Siphons will not be further discussed here. Reference is made to French (1986) and Chow (1964).

24.3.2 Location of Outlet Structures

The selection of the outlet location depends on hydrological considerations (tidal or non-tidal area), topographical considerations (lowest spot of the area to be drained), soil mechanical considerations (foundation possibilities), effects of wave attack, and sedimentation and scouring at the outer side of the outlet.

From a drainage point of view, the location of outlets in tidal areas is generally most favourable in those areas with the lowest low water levels. The site should preferably be selected near a natural gully, so that optimum use can be made of the natural drainage characteristics (Chapter 19). The outlet itself should not be constructed in the gully because this might pose foundation problems; instead, it should be placed just beside the gully and be connected to it by a short canal.

In a non-tidal river area, the outlet should be located at the lowest site in the drained area. Also in this case, use should be made of the existing natural drainage channels in the area. For drained areas with relatively long stretches along the river, it is advisable to apply two or even more outlets, because otherwise all the drainage water would have to be conveyed to the lowest part of the area before draining to the river, which would result in a relatively large storage area.

If the outer water levels cause a prolonged period of impeded drainage, additional measures (e.g. pumps) will be needed. Another alternative could be to construct a channel, parallel to the river, to a location further downstream. The slope of this channel should be less than the slope of the river bed, so that sufficient head can be obtained to allow gravity discharge.

The outlet structure should be protected from waves by an indent in the dike in a direction that depends on the predominant wave direction. Problems of sedimentation may then occur, however, for which additional measures are required (e.g. dredging and flushing; see Section 24.3.3).

If the outlet has to discharge to a meandering river or to rapidly changing tidal forelands, locations that might be subject to meandering and/or scouring should be avoided, because both processes may affect the proper functioning of the outlet.

24.3.3 Discharge Capacities of Tidal Drainage Outlets

To calculate the discharge capacity of tidal drainage outlets, one needs data on inner water levels (DDL and MASL), the volume of water to be drained (represented by the drainage coefficient), a representative tidal curve of the outer water, hydraulic characteristics of the planned structure and of the foreshore channel, and the characteristics of the storage area.

The actual inner water levels depend on the incoming water, the volume that can be stored, and the volume that can be discharged during one tidal cycle. The incoming water is represented by the drainage coefficient, being a desired depth of excess water during a certain maximum period of time. Its background has already been discussed in Chapter 17. The volume of water that can be stored in the drainage area is the product of the total wetted surface area (area of canals and of storage basins) and the maximum allowable rise (MASL-DDL). To determine the storage capacity of a drained area, sloping sides of canals and/or storage reservoirs should be averaged

between DDL and MASL, and the average area should be multiplied by the maximum allowable rise (MASL-DDL).

The stored water will have to be evacuated within the drainage period. The length of this period depends on the outer water levels, which are governed by the tidal fluctuation, in combination with river discharges.

From Figure 24.2, it could be observed that discharge starts when the water levels on both sides of the outlet are (more or less) equal. As was mentioned earlier, the design should take into account the head loss over the outlet structure and the higher density of outside waters. Discharge stops when the outside water level becomes higher than the level inside.

The volume to be evacuated through the outlet can be obtained by balancing the drainage volume with the available storage and keeping in mind that storage can be used only temporarily.

Computation of Outlet Width and Storage Capacity

To compute the outlet width and the corresponding required storage capacity in the drained area, the following procedure can be followed:

A. Outlet Width

Step 1: Select a design tidal range, which should reflect the most unfavourable outer water conditions for drainage. (In most cases, it equals the minimum tidal range.) The data should preferably cover a period of at least one lunar month, so that spring and neap tides are included.

Step 2: Determine the length of drainage periods T_D during the selected tidal cycle on the basis of the design drainage level and the maximum allowable storage level.

Step 3: Subdivide each drainage period into small periods Δt during which the conditions can be considered constant, so that the steady-state formulae for subcritical and critical flow conditions can be applied. The value of Δt can best be chosen in the range of 1500 to 3000 seconds.

Step 4: Choose a crest elevation and take it as reference level (see Section 24.3.4 for remarks on the best choice).

Step 5: For each time interval Δt , determine the flow situation and the corresponding values of h_v and h_d (Figure 24.24).

Water starts flowing through the drainage outlet when the water level inside exceeds the water level outside (provided that inside and outside waters have equal density). There will be subcritical flow as long as $h_d \geq 2/3 h_v$. By expressing Equation 24.8 per unit sluice width, we obtain

$$v_{\Delta t} = q_s \Delta t = \mu h_d \Delta t \sqrt{2g(h_v - h_d)} \quad (24.11)$$

where

$$v_{\Delta t} = \text{drained volume per metre sluice width during time step } \Delta t \text{ (m}^2\text{)}$$

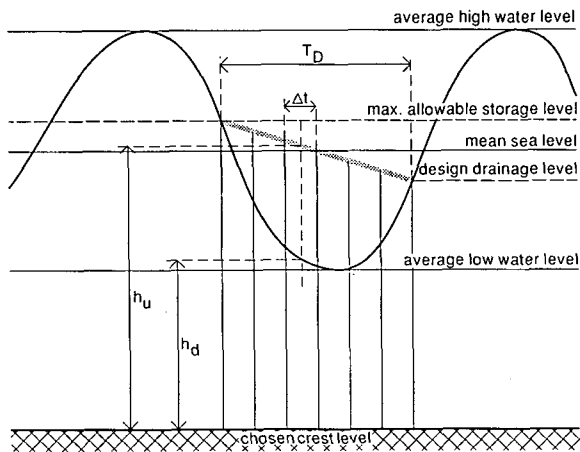

Figure 24.24 Determination of the water levels inside (h_u) and outside (h_d) at the middle of each time step during subcritical flow conditions

q_s = average drainage discharge per metre sluice width during time step Δt under subcritical flow conditions (m^2/s)

Δt = time step (s)

h_u = the average upstream water level, measured at the middle of time step Δt (m)

h_d = the average downstream water level, measured at the middle of time step Δt (m)

Select a value for the discharge coefficient μ .

Critical flow starts as soon as $h_d < 2/3 h_u$ (Point A in Figure 24.25) and continues until the downstream water level starts to rise and reaches the value $h_d = 2/3 h_u$ again (Point B in Figure 24.25). During the period AB, the discharge over the weir is controlled by the critical depth of flow above the weir; $h_c = 2/3 h_u$. Note that the values of h_u for these time steps can be determined by linear interpolation between A and B.

As long as critical flow conditions occur, $v_{\Delta t}$ can be calculated with Equation 24.10

$$v_{\Delta t} = q_c \Delta t = C_d \frac{2}{3} h_u \Delta t \sqrt{2g \frac{1}{3} h_u} \quad (24.12)$$

where

q_c = average drainage discharge per metre sluice width during time step Δt under critical flow conditions ($m^3/m.s$)

Select a value for the discharge coefficient C_d .

Step 6: Calculate the volume of drainage water that collects during a tidal day using

$$V = q T A_D \quad (24.13)$$

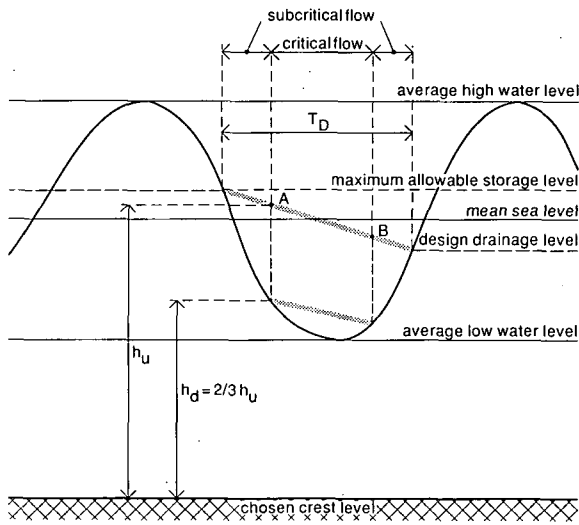

Figure 24.25 Determination of the duration of critical flow conditions

where

- V = the total volume of water to be discharged during the drainage period (m^3)
- q = the drainage coefficient (m/s)
- T = length of tidal period (s)
- A_D = the drainage area (m^2)

Note: Normally the drainage coefficient is expressed in mm/d. To convert it to m/s, multiply the coefficient by $10^{-3}/(24 \times 3600)$.

Step 7: Calculate the design outlet width using

$$b = \frac{V}{\sum v_{\Delta t}} \quad (24.14)$$

where $\sum v_{\Delta t}$ is the total potential discharge volume per unit outlet width during the tidal period considered.

B. Storage Capacity

During the storage periods T_s , the drainage water should be stored inside the drained area. The following procedure can be applied to determine the required storage capacity:

Step 8: Select from the design tidal range the longest period T_s during which no drainage is possible.

Step 9: Determine the drainage discharge Q by using

$$Q = q A_D \quad (24.15)$$

Step 10: Calculate the volume of water V_s that needs to be stored during the period T_s by multiplying the discharge with the period selected in Step 8 using

$$V_s = Q T_s \quad (24.16)$$

Step 11: Calculate the average storage area A_s , i.e. the average of the storage areas at maximum allowable storage level (MASL) and design drainage level (DDL), using

$$A_s = \frac{V_s}{\text{MASL} - \text{DDL}} \quad (24.17)$$

Step 12: If the calculation has been made for *average* tidal conditions, neglecting spring and neap tides, it is advisable to create a storage area of at least 1.5 times the dimensions calculated under Step 11.

Example 24.3

Given (Figure 24.26):

Average highest water level	AHWL = 4.38 m
Average lowest water level	ALWL = 2.62 m
Maximum allowable storage level	MASL = 3.90 m
Desired drainage level	DDL = 3.60 m
Drainage coefficient	$q = 50 \text{ mm/day}$
Drainage area	$A_D = 5000 \text{ ha}$
Discharge coefficients	$\mu = 1.2$
	$C_d = 0.9$
Acceleration of gravity	$g = 9.81 \text{ m/s}^2$

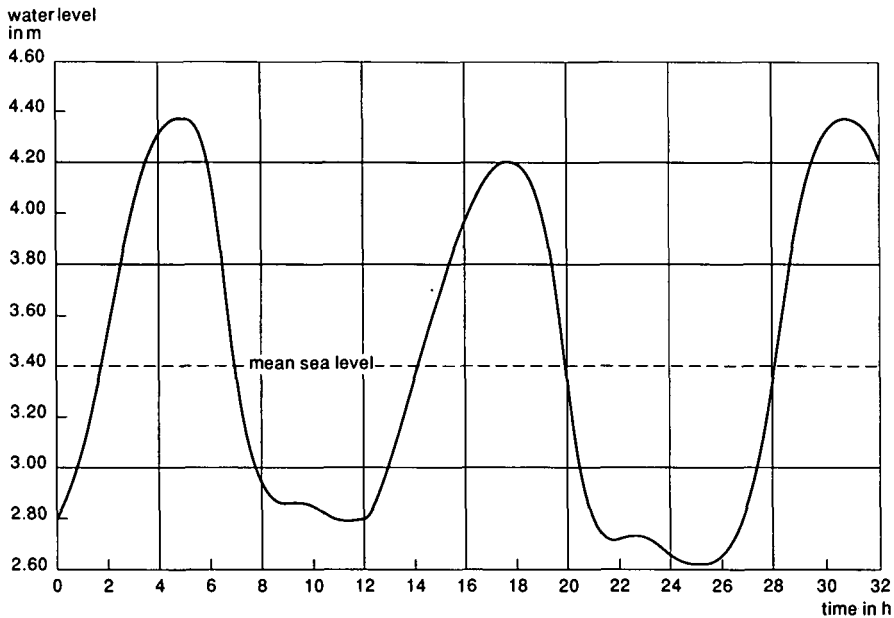

Figure 24.26 Average tidal levels used in Example 24.3

Asked:

A. Design width of the outlet structure;

B. Required storage area;

C. A check on the computations by a simple reservoir calculation.

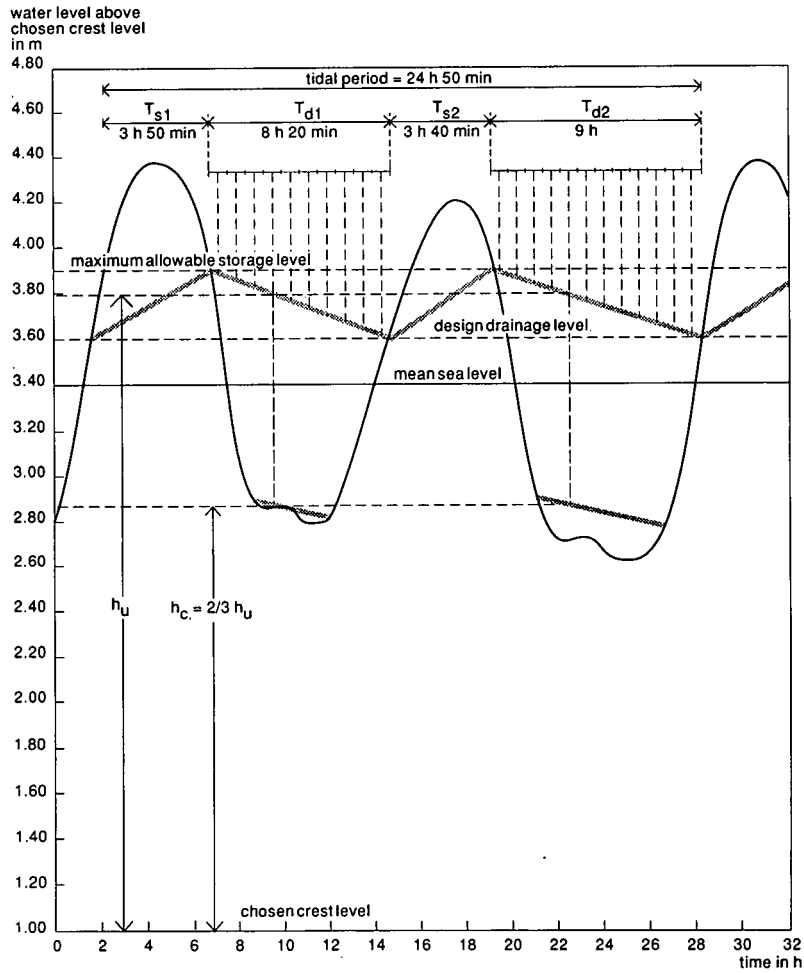

Figure 24.27 Determination of drainage and storage periods in Example 24.3

A. Design Width of the Drainage Outlet

Step 1: Representative tidal range: see Figure 24.26.

Step 2: Determine graphically the length of the drainage periods T_{D1} and T_{D2} . Using Figure 24.27, we find $T_{D1} = 30\ 000$ and $T_{D2} = 32\ 400$ s.

Step 3: Select appropriate time steps Δt for each drainage period, for example: $\Delta t_1 = 3000$ s, and $\Delta t_2 = 2700$ s, so that 10 and 12 discrete steps, respectively, can be obtained.

Step 4: In this calculation, the crest elevation is chosen at 1.00 m above datum level.

Step 5: For each time step Δt , read the values of h_u and h_d from the graph of Figure 24.27. Check which flow conditions exist during the drainage periods T_{D1} and T_{D2} (Tables 24.2, 24.3: Column 4). Calculate for each time step Δt the corresponding $v_{\Delta t}$, using the equation for subcritical or for critical flow (Equation 24.11 or 24.12).

Step 6: Using Equation 24.13, determine the total volume of water V that has to be drained during one tidal day

$$V = q T_D A_D = \frac{24 \times 60 + 50}{24 \times 60} \times 50 \times 10^{-3} \times 5000 \times 10^4 = 2.59 \times 10^6 \text{ m}^3$$

Table 24.2 Discharges during drainage period T_{D1}

Time step	h_u	h_d	$2/3 h_u$	C_d or μ	Δt	$v_{\Delta t}$	Critical flow
1	2.89	2.70	1.93	1.20	3000	18767	No
2	2.86	2.18	1.91	1.20	3000	28666	No
3	2.83	1.92	1.89	1.20	3000	29206	No
4	2.80	1.88	1.87	1.20	3000	28754	No
5	2.77	1.88	1.85	1.20	3000	28282	No
6	2.74	1.80	1.83	0.90	3000	20878	YES! $h_d < 2/3 h_u$ See Figure 24.27
7	2.71	1.81	1.81	1.20	3000	27381	No
8	2.68	1.95	1.79	1.20	3000	26567	No
9	2.65	2.20	1.77	1.20	3000	23533	No
10	2.62	2.48	1.75	1.20	3000	14797	No
$\Sigma v_{\Delta t} =$						246831	

Table 24.3 Discharges during drainage period T_{D2}

Time step	h_u	h_d	$2/3 h_u$	C_d or μ	Δt	$v_{\Delta t}$	Critical flow
1	2.89	2.81	1.93	1.20	2700	11406	No
2	2.87	2.37	1.91	1.20	2700	23970	No
3	2.84	1.95	1.90	1.20	2700	26451	No
4	2.82	1.75	1.88	0.90	2700	19619	Yes
5	2.80	1.72	1.86	0.90	2700	19376	Yes
6	2.77	1.74	1.85	0.90	2700	19134	Yes
7	2.75	1.67	1.83	0.90	2700	18893	Yes
8	2.73	1.63	1.82	0.90	2700	18653	Yes
9	2.70	1.64	1.80	0.90	2700	18414	Yes
10	2.68	1.71	1.79	0.90	2700	18176	Yes
11	2.65	1.91	1.77	1.20	2700	23580	No
12	2.61	2.30	1.74	1.20	2700	18378	No
$\Sigma v_{\Delta t} =$						236051	

Step 7: Calculate the width of the outlet using Equation 24.14

$$b = \frac{V}{\Sigma v_{\Delta t}} = \frac{2.59 \times 10^6}{(2.46 + 2.36) \times 10^5} = 5.36 \text{ m}$$

Thus an outlet with two gates of 3 m each could be sufficient.

Note: It is always preferred to apply an outlet with more than one opening for considerations of maintenance and repair.

B. Required Storage Capacity

Step 8: During periods T_{S1} and T_{S2} , water has to be stored because during those periods no drainage is possible. T_{S1} has the longest duration: 3h50min.

Step 9: Determine the drainage discharge Q , by using Equation 24.15

$$Q = q \times A_D = \frac{50 \times 10^{-3}}{24 \times 3600} \times 5000 \times 10^4 = 28.9 \text{ m}^3/\text{s}$$

Step 10: Using Equation 24.16, calculate the volume of water V_s that needs to be stored during the period T_s (being the longest period)

$$V_s = Q T_{S1} = 28.9 \times (3 \times 3600 + 50 \times 60) = 0.40 \times 10^6 \text{ m}^3$$

Table 24.4 Reservoir analysis for the storage area. The required storage (Column 7) equals the accumulated inflow (Column 4) minus the accumulated outflow (Column 6)

1	2	3	4	5	6	7
Period	Duration (s)	Inflow (Step 9) (m ³ × 10 ⁶)	Cumulative inflow (m ³ × 10 ⁶)	Outflow (Step 5, 7) (m ³ × 10 ⁶)	Cumulative outflow (m ³ × 10 ⁶)	Required storage (m ³ × 10 ⁶)
T _{S1}	13800	0.40	0.40	0.00	0.00	0.40
T _{D1}	30000	0.87	1.27	1.32	1.32	-0.05*
T _{S2}	13200	0.38	1.65	0.00	1.32	0.34
T _{D2}	32400	0.94	2.59	1.27	2.59	0.00

* A negative value means that no storage is required

Step 11: Using Equation 24.17, calculate the average storage area A_s

$$A_s = \frac{V_s}{\text{MASL} - \text{DDL}} = \frac{0.40 \times 10^6}{3.90 - 3.60} = 1.33 \times 10^6 \text{ m}^2 = 133 \text{ ha}$$

Step 12: Because this calculation has been made for average tidal conditions, the advisable storage area should be $133 \times 1.5 = 200 \text{ ha}$.

C. Checking the Calculations

We can check the calculations by making a simple reservoir analysis for the drained area as is presented in Table 24.4.

It appears from Table 24.4 that, at the end of a tidal day, the volume of inflow is the same as that of the outflow, and that therefore, as was mentioned, the minimum storage volume should be $0.40 \times 10^6 \text{ m}^3$.

Remarks on the Hydraulic Computation

The hydraulic computation method that has been presented can be used as a *first approximation* only, because the real situation has been simplified.

The first simplification was the value of the discharge coefficient μ . There are no proper formulae from which μ can be derived satisfactorily. Therefore, for large outlet structures, the discharge coefficient needs to be investigated by scale models or by simulation; for smaller structures reference is made to Bos (1989).

Generally, the more open the gates, the less the contraction will be. If the gates could open completely and no part of them were to protrude significantly, the discharge coefficient could have values of 1 (which means no contraction at the gates) or, under favourable conditions, of even more than 1.

Other aspects to be mentioned are hydraulic losses at the transitions between channel and structure and losses due to friction along the sides of the structure. Table 24.5 gives a first indication of the values for the coefficient which takes these losses into account.

Table 24.5 Head loss coefficients for hydraulic losses at the upstream and downstream transitions with the channel and for friction losses (Van der Kley and Zuidweg 1969)

Shape of side walls and crest	c_d
Crest elevation at channel bottom:	
- Sharp-cornered side walls	0.80
- Rounded cornered side walls	0.90
Crest elevation above channel bottom:	
- Sharp-cornered crest and side walls	0.72
- Rounded side walls:	
= Sharp-cornered crest	0.76
= Rounded crest	0.85

Other simplifications used were:

- A constant inflow rate equal to the drainage coefficient of the drained area;
- An average tidal curve for one tidal day.

Reality is of course different and more complex. In principle, it is possible to simulate the real situation rather satisfactorily by using hydraulic computer models in which the system 'inner water levels, storage, outlet structure, and outer water levels' can be schematized in one network as follows:

- Fluctuating inner water levels can be simulated on the basis of a design rainfall or a series of measured rainfall data;
- Fluctuating outer water levels can be simulated on the basis of the most important constituents that influence daily water levels (tidal area), on seasonal river water levels (non-tidal area), or on a combination of the two (tidal rivers);
- Various areas of the storage reservoir can be included in the network;
- The flow through the outlet as a result of the above-mentioned fluctuating water levels. Several outlet characteristics (including varying contraction coefficients) could be used as input.

In this way, we can simulate the functioning of an outlet for a relatively longer period (e.g. a month to include spring and neap tides, or a season to include extreme river flows), and to test the sensitivity of some parameters to obtain an insight into the design conditions. An example of such a simulation model is 'Drainage: Tidal Sluice Simulation' (Standa Vanacek 1990), which demonstrates the hydraulic functioning of the system 'drainage sluice, storage area, tidal outer water levels'. The model shows the sensitivity of design parameters (like storage area, crest width, and crest level) and the effect of numerical parameters (implicit versus explicit numerical solution methods, different time steps) on the design of a tidal drainage sluice.

A third element to be discussed is that the inner and outer waters have different densities (Figure 24.28). The doors of an outlet will remain closed as long as the forces acting upon them are in equilibrium.

Thus for equilibrium

$$\frac{1}{2} \rho_r g h_r^2 = \frac{1}{2} \rho_s g h_s^2 \quad (24.18)$$

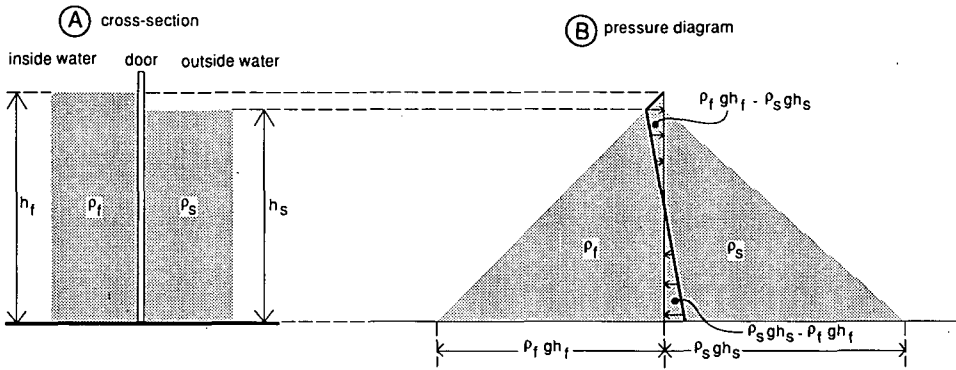

Figure 24.28 Hydrostatic pressure on a vertical interface between water bodies of different mass density; A: Cross section; B: Pressure diagram, showing the resultant pressure

where the subscripts *f* and *s* denote, respectively, fresh and salt water.

From Equation 24.18, it follows that

$$\frac{h_f}{h_s} = \sqrt{\frac{\rho_s}{\rho_f}} \quad (24.19)$$

For sea water ($\rho_s = 1025 \text{ kg/m}^3$), the ratio $h_f:h_s$ becomes 1.012:1.

So, generally, if the outer water has a higher density (e.g. salt water, river water containing high sediment rates), a higher inner water level is needed to open the doors. Consequently, the doors will close earlier than when the densities on both sides are equal. Figure 24.29 shows the inner and outer water levels and the corresponding discharge curve of a drainage outlet in a typical tidal environment. Figure 24.29 shows that, because of the density differences, the actual drainage period will be shorter than that used in Example 24.3.

24.3.4 Design, Construction, Operation, and Maintenance

Crest Level

The crest level of a tidal outlet can best be chosen at a depth varying between 0.5 and 2 m below the outer low water level. As a low crest level reduces the period in which critical flow takes place and thus increases the capacity of the outlet, it is preferred to lower the crest level rather than to increase the outlet width (keeping the wetted area the same). However, the construction costs may increase significantly with lower crest levels. The stability of the side walls might be another restricting factor if the height of the side walls becomes large in relation to the outlet width.

The bottom level of the drainage canal that leads to the outlet, and that of the canal from the outlet to the receiving waters, govern the crest elevation as well. In case of highly elevated foreshores, for instance, or outer areas subject to sedimentation and siltation, it is not possible to maintain a relatively deep outer drainage canal.

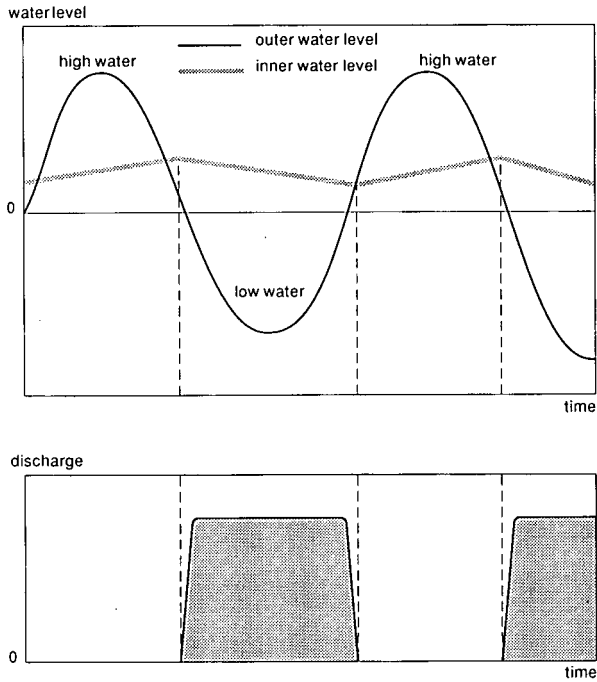

Figure 24.29 Water level fluctuations and discharge of an outlet structure under tidal conditions

The best solution then is to choose the crest level at the elevation of the foreshore. Relatively high crest elevations also occur in drained areas with a relatively high ground level and a corresponding high DDL. In such cases, the crest elevation might be chosen at, or even above, low water level.

When outlets are located upstream of the tidal reach of a river, the crest level must be chosen at 1.50 to 1.75 m below DDL (provided, of course, that the river water levels allow free drainage).

Doors and Gates

In tidal areas, either doors (with a vertical or horizontal axis) or sliding gates can be applied. In tidal areas, doors have the advantage of opening and closing by hydraulic forces only. Waves, however, may cause a repeated opening and closing, which not only allows outer water to intrude, but may also damage the doors and hinges. The gates should also be able to withstand the wave forces and should be able to pass these forces to their hinges.

The prevention of salt water intrusion via doors and gates can be realized by applying rubber profiles near the hinges and at the ends where they touch each other (or touch the side walls in case of only one door).

In non-tidal areas, sliding gates can better be applied, as they can still be opened when large differences between inner and outer water levels occur. Furthermore, it is possible to maintain higher inner water levels (when desired), which is not possible with outlet doors that open towards the outer water levels.

To prevent a hampered operation of the outlet and to protect the doors and gates from damage by floating debris, trash-racks should be applied at the inner side to collect the debris.

Doors and gates can be maintained and repaired by closing the outlet temporarily with stoplogs, for which slots in the sidewalls are required in which the logs can slide. These slots should be provided at both sides of the gate to cope with varying inner and outer water levels.

In case of a tidal outlet, a second set of doors might be constructed, in order to ensure extra safety of the drained area against high outer waters.

The height of the doors should, of course, be at the same elevation as the dike, to prevent flooding during extremely high outer water levels.

For gravity outlets that consist of more than one opening, it is advisable to have the same dimensions for all openings. This will allow a standard design for the doors/gates and for other mechanical items, and will make them exchangeable.

24.3.5 Other Aspects

As the tidal outlet is part of the protection system of an area, it should be constructed in such a way that it does not weaken this defence. This implies that seepage under the structure should be prevented, which can be realized by applying sheet piles. In case of relatively high outer water levels, it may even be necessary to apply sheet piles not only underneath the structure, but also next to both side walls.

High velocities through outlets should be avoided to prevent scouring and damage to banks and the structure itself (Chapter 19). This can be achieved by applying larger cross-sections for outlets and channels (resulting in lower velocities) and/or by lining the channel banks and protecting the outlet channel. On the other hand, sedimentation in the canals should be prevented by flushing the canals, for which certain minimum velocities are required.

Besides the problem of the intrusion of poor quality outer water, the quality of the drainage water is of increasing importance. As long as the quantity of polluted drainage water is small compared to the outer water, and the characteristics of the pollution allow for natural breakdown, no special measures need be taken. In areas where water of good quality is of importance, however, special measures might be needed, such as:

- Removing/diminishing the source of contamination;
- Restricting drainage from pollutive sources like industry, intensive agriculture;
- Purifying polluted drainage water before discharging it to outer waters, which is hardly feasible for drainage water that is polluted by agricultural practices;
- Discharging the drainage water in smaller quantities. This measure will not only require more storage, but is also related to the acceptability of storing polluted water in the drainage system;
- Discharging further downstream or at various locations.

(Chapter 25 elaborates on water quality in further detail.)

When the outer channel is subject to sedimentation and siltation (tidal foreshores, rivers with high sediment loads), regular flushing and/or dredging might be required. In tidal areas, flushing can be realized by constructing the required storage reservoir

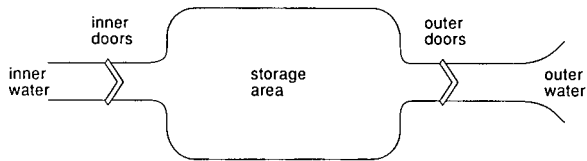

Figure 24.30 Plan view of a storage reservoir, which is also used to flush the outer channel

next to the outlet structure (the outer doors) on the inland side, followed by a second set of doors (inner doors), which separate the reservoir from the drained area (Figure 24.30).

During normal operation, the outer doors open and close to allow for drainage, while the inner doors are kept open constantly. When flushing of the outer channel is required, the outer doors are kept open and the inner doors will close when the outer water levels become higher than the inner water levels. This will cause the water level in the storage area to rise to high water level. During the following drainage period, much more hydraulic head will be available, so that the outer channel can be flushed successfully. This, however, requires embankments encircling the storage area to offer protection against high outer water levels (Van der Kley and Zuidweg 1969; Smedema and Rycroft 1983).

References

- Bos M.G. (ed.) 1989. Discharge measurement structures. ILRI Publication 20, Wageningen, 401 p.
- Chow V.T. 1959. Open-channel hydraulics. McGraw-Hill, New York, 680 p.
- Chow V.T. 1964. Handbook of applied hydrology. McGraw-Hill, London, 1418 p.
- De Vries, J.E., H. Lammers and A.P. Potma 1947-1951. De Technische Vraagbaak : Handboek in vijf delen voor de gehele techniek. 5th ed. Volume W, Weg- en waterbouwkunde, Deventer.
- French, R.H. 1986. Open channel hydraulics. McGraw-Hill, New York, 705 p.
- Kalkwijk, J.P.Th. 1984. Tides. International Institute for Hydraulic and Environmental Engineering, Delft.
- Pugh, D.T. 1987. Tides, surges, and mean sea level. Wiley, New York, 472 p.
- Savenije, H. 1992. Rapid assessment technique for salinity intrusion in alluvial estuaries. International Institute for Hydraulic and Environmental Engineering, Delft.
- Schureman, P. 1958. Manual of harmonic analysis and prediction of tides. Coast and Geodetic Survey, U.S. Department of Commerce, Special Publication No. 98, Washington, 317 p.
- Smedema, L.K. and D.W. Rycroft 1983. Land drainage : planning and design of agricultural drainage systems. Batsford, London, 376 p.
- Standa Vanecek 1990. Drainage : tidal sluice simulation. International Institute for Hydraulic and Environmental Engineering, Delft.
- U.S. Bureau of Reclamation 1983. Design of small dams. U.S. Bureau of Reclamation, Department of the Interior, Washington, 816 p.
- Van der Kley, J. and H.J. Zuidweg 1969. Polders en dijken. Agon Elsevier, Amsterdam, 342 p.
- Van Os, A.G. and G. Abraham 1990. Density currents and salt intrusion. International Institute for Hydraulic and Environmental Engineering, Delft.

25 Environmental Aspects of Drainage

H.P. Ritzema¹ and H.M.H. Braun¹

25.1 Introduction

Worldwide, the introduction of drainage systems has conserved or improved millions of hectares of land for agriculture or other purposes. The benefits of drainage (i.e. the gain in land, better quality land, or the sustainability of irrigated land use) are associated with certain disadvantages. Sometimes, the gain in one location (e.g. the creation of new agricultural land) is associated with a loss in the same area (e.g. the disappearance of an ecosystem). More commonly, however, the improvement or gain in one place leads to a burden in another place. Examples are the environmental problems created by the disposal of drainage effluent polluted with salts, nitrates, herbicides, pesticides, or harmful minor elements like selenium.

The purpose of this chapter is to assess the impact that drainage projects have on their surroundings (i.e. on the environment), and to introduce methods to assess these impacts.

This chapter, then, starts with a summary of the objectives of drainage (Section 25.2). Section 25.3 introduces three categories of environmental impacts. Sections 25.4 to 25.6 deal more extensively with the drawbacks, side-effects, or problems created by drainage inside the drained area, and upstream and downstream of it. There is growing realization that assessments of drainage needs, possibilities, and costs are incomplete if no consideration is given to the adverse effects. Section 25.7 discusses the various ways of assessing these effects through an environmental impact assessment.

25.2 Objectives of Drainage

The three main objectives of drainage in agricultural land are:

- Drainage to prevent or reduce waterlogging;
- Drainage to control salinity;
- Drainage to make new land available for agriculture.

The first two objectives are aimed at conserving or improving existing agricultural areas (vertical expansion), whereas the third objective brings new areas into cultivation (horizontal expansion).

The installation of a drainage system has two direct effects (Chapter 17):

- It reduces the amount of water stored on or in the soil;
- It introduces a flow of water through the drainage system.

¹ International Institute for Land Reclamation and Improvement

These two direct effects are usually not the main objectives of drainage. However, they trigger many indirect effects, and these are often the true reasons for drainage. The various objectives of drainage are:

- The removal of excess surface water or groundwater to achieve:
 - Better soil aeration leading to higher productivity of crop land or grassland through:
 - Deeper rooting of the crops;
 - Less restricted crop choice;
 - Fewer weeds;
 - Better use of fertilizer;
 - Less denitrification;
 - Better grass swards.
 - Drier soils leading to:
 - Better accessibility of the land;
 - Greater bearing capacity of the land;
 - Better soil workability and tilth;
 - Extension of the period in which tillage operations can take place;
 - Increased activity of micro-fauna (e.g. earthworms), which improves permeability;
 - Better soil structure, which also improves permeability;
 - Higher soil temperatures, which allows the earlier growth of crops, particularly horticultural crops, and grasses.
- Leaching for salinity control:
 - To prevent increases in soil salinity in the rootzone and thus make irrigated land use sustainable in the long term;
 - To remove salts for the introduction of salt-sensitive crops or to allow a wider range of crops;
 - To reclaim saline and/or sodic soils.
- Leaching for acidity control:
 - To prevent a build-up of acidity in the rootzone of potential acid sulphate soils;
 - To reclaim acid sulphate soils.

Besides these agricultural objectives, there may be other reasons for installing drainage systems. We could mention drainage for health, drainage to establish or improve recreational facilities, and, more rarely, to create areas for wildlife development (habitat construction). In this chapter, we shall be focusing mainly on the environmental side-effects of agricultural land drainage, mentioning the other aspects only occasionally. We also restrict ourselves to the technical issues, thereby giving no consideration to socio-economic issues.

25.3 Environmental Impacts

When we introduce a drainage system into an area, we are manipulating the environment. We can define 'the environment' as the totality of ecosystems on different scales – from local, to regional, to global. An 'ecosystem' (or natural system) is a dynamic arrangement of plants and animals with their non-living surroundings of

soil, air, water, nutrients, and energy. Lakes, mangrove forests, swamps, or grasslands are ecosystems. So, too, are rice fields, polders, fish ponds, pastures, and home gardens. The latter category are modified by human activities; they are therefore called 'managed ecosystems', which are simple in comparison with the diversity of life in 'undisturbed ecosystems'.

Successful development depends on the rational use of environmental resources and on minimizing or eliminating any adverse environmental impacts by improving the planning, design, and implementation of projects. We want the land use in the area to be sustainable, which means that we want to manipulate the environment in such a way that its productivity and its fertility do not diminish with time to the detriment of human welfare.

The Commission on Ecology and Development Cooperation (CEDC 1986) distinguishes three categories of environmental impacts:

- Disturbance and/or pollution of the environment;
- Depletion and/or over-exploitation of the natural resources;
- Destruction and/or impairment of the natural ecosystem.

Disturbance

A disturbed and/or polluted environment is the least severe category of damage resulting from human interventions in natural ecosystems. Careful planning can keep the impacts on the environment within acceptable limits. Drainage is, in principle, the regulation of the water-management system. Open drains are constructed, flows in natural streams are altered, and saline drainage effluent is discharged to rivers. All these activities have an effect on the environment. These effects are difficult to predict in full, but ecological studies may provide an insight into the main environmental consequences of the planned drainage systems. And, if these systems are carefully planned, the changes in the existing ecosystems can be kept as intended. Examples are the change in habitat as a result of the introduction of drainage (Section 25.4.2) and the effect of saline seepage from drainage canals on adjacent agricultural areas (Section 25.5.4).

Depletion

The depletion or over-exploitation of natural resources is often a gradual process, which in the beginning may not appear to be severe, but in the end can have major repercussions. Especially when we realize that what happens on a small scale at field level can also take place on a large regional scale. Examples are the erosion of fertile topsoil by overland flow (Section 25.4.8) and the leaching of nutrients and organic matter (Section 25.4.9).

Destruction

The destruction and/or the impairment of a natural ecosystem is the most severe category of environmental impacts. When changes in the ecosystems are irreversible, extreme care should be taken before any activities that will produce these consequences are undertaken. Examples are the reclamation of swamps, which will result in the irreversible shrinkage of the newly reclaimed soils, or the oxidation of peat soils after the watertable has been lowered (Section 25.4.4). Another example is the acidification of potential acid sulphate soils (Section 25.4.6).

To assess the environmental impacts of the two direct effects of drainage (i.e. a lower watertable and an increase in discharge; Section 25.2), they can be categorized in predictable and unpredictable, primary and secondary, upstream and downstream of the project area, and in the project area itself.

Impact predictability, in terms of intended and unintended effects, increases when appropriate investigations are conducted prior to project execution. But surprises, often awkward ones, cannot always be prevented, particularly in the drainage of irrigated arid lands. This is clear in the following quote from the Committee on Irrigation-Induced Water Quality Problems (1989: p. 96):

The irrigation of arid lands brings about major changes in land use and in the distribution and use of water. This in turn leads to a redistribution of salts, with unintended and sometimes unanticipated consequences. These impacts of redistribution are often minor initially, but they tend to become increasingly important over time.'

25.4 Side-Effects Inside the Project Area

25.4.1 Loss of Wetland

Wetlands are lands where saturation with water is the dominant factor determining the nature of soil development and the types of plant and animal communities living in the soil and on its surface. When wetlands are reclaimed, they lose their original function as lands harbouring particular plant and animal communities. In the past, the loss of 'useless wetlands' caused little concern. Fortunately, in recent years, people are beginning to realize that the disappearance of wetlands is not only of concern to bird-watchers and others interested in a 'natural' environment, but should be of concern to everybody.

Before drainage, the agricultural value of wetlands is generally very low. From an agricultural point of view, the loss of such poorly productive land is easily compensated for by the greater land productivity resulting from drainage. On the other hand, wetlands are usually of great value as wildlife habitats, flood-storage areas, groundwater-recharge areas, siltation basins, ecological filters, and ecological and recreational areas. The values of these functions are very difficult to estimate in monetary terms.

Whether the loss of wetland is acceptable will depend on the balance between the somewhat objectively assessable agricultural gains that result from drainage and on the subjective value which the wetland has as nature or recreation area. As the latter effects cannot be expressed in monetary terms, it is difficult to assess the costs of introducing drainage (Section 25.7). In many developing countries, which are striving to increase their agricultural production, the balance tips in favour of agricultural productivity, and in many developed countries, which can afford to treasure scarce nature areas, the balance tips towards the side of nature.

One can adopt the pragmatic attitude that, up to a certain limit, the loss of wetlands – often the only spaces not occupied by man – is acceptable provided that the reclaimed land is really productive, and if that production is necessary for food or employment

and cannot be achieved by cheaper means. These conditions are seldom met in tropical peat soils, planosols, and acid sulphate soils, which, for various reasons, are difficult to reclaim and are poor in productivity, so that the positive effects of reclamation are often overshadowed by the negative effects.

The reclamation of alluvial lowlands in river deltas, which are generally more fertile than the soil types mentioned above, shows more promise, but there, too, the possible gains and losses should be equated with each other. Over the past centuries in The Netherlands, vast areas have been reclaimed from the sea or lake bottoms to be brought under agricultural production (Example 25.1). At present, however, reclamation activities have come to a standstill as a result of a combination of factors in which environmental considerations, absence of the need for more agricultural land, and high costs play a major role.

Example 25.1

The Netherlands, with a total land area of 3 400 000 ha, has a long history of land reclamation and protection against water. At present, about one-third of the country is situated below mean sea level. The endiking and subsequent reclamation of coastal salt marshes started about 1000 years ago. Since that time, some 400 000 ha of salt marshes have been reclaimed. In roughly the same period, inland peat moors and swamp forest were reclaimed by drainage, resulting in the reclamation of another 400 000 ha. From the middle of the sixteenth century, windmills made it possible to drain inland lakes; about 315 000 ha of former lakes were reclaimed in this way (Schultz 1983). On the other hand, land has been lost over the centuries by the inundation of coastal areas after dike breaches (about 570 000 ha), while the mining of peat soils has resulted in new lakes being formed (about 100 000 ha).

Since the 1960's, opposition to the loss of wetlands has gradually mounted and the reclamation of new areas has come to a standstill. Instead, in some reclaimed areas, wetlands have been created by partial drainage and the associated control of the levels of surface water and groundwater. An example is the Oostvaarders Ponds, which, through good management of soil and water over the last two decades, have become one of the richest areas of waterfowl and shorebirds, both resident and migratory, in western Europe.

25.4.2 Change of the Habitat

Improving the drainage in land that is already used for crop production or grazing may appear environmentally less damaging than converting wetlands into crop land. But, in both humid and arid regions, improved drainage can still lead to a drastic change in habitat conditions. Consequently, plant and animal life can be considerably affected (Example 25.2).

Example 25.2

In Kalimantan, Indonesia, large parts of the coastal lowlands were brought under cultivation, resulting in the acidification of the soil (as will be explained in Example 25.6). The drainage of these acid sulphate soils inevitably increases the acidity of the drainage water, which can have environmental effects both within and downstream

Table 25.1 Effect of reclamation of coastal lowlands on the fish population (after Klepper et al. 1992)

Area	Conditions	No. of fish species
Sungai Negara	Not drained , not acidified	96
Pulau Petak	Drained, acidified	29
Tabunganen	Drained, not acidified	43

of the project area. As an illustration, the number of fish species after reclamation dropped from 96 species in an undisturbed area to only 29 species in a drained, acidified area (Table 25.1). Although the decrease probably cannot be completely attributed to the reclamation practices, it is a good illustration of how human activities can affect the fauna.

25.4.3 Lower Watertable

A direct effect of a drainage system is a lower average watertable. This systematic lowering of the watertable increases agricultural production, but can also have serious side-effects on the same agricultural production (Example 25.3), and on nature conservation, forestry, and the landscape (e.g. it can cause subsidence). One way to reduce these negative side-effects would be not to keep the drainage base at the same level throughout the year, but to accept higher levels in periods that are not critical for agriculture or periods with water shortages. For example, water levels in the open drainage systems in The Netherlands are generally allowed to be higher in summer (the period with a rainfall deficit) than in winter (the period with a rainfall surplus).

Example 25.3

In The Netherlands, the average watertable in areas of rural development projects has dropped 0.35 m over the last 30 years as a result of improved drainage (Rolf 1989). This has significantly increased agricultural production, but it also has its negative impacts on the same agricultural production. During summer, the lower average watertable has increased water shortages. As a consequence, in the period from 1976 to 1985, the use of sprinkler installations for supplementary irrigation increased from 12% of the total area to 17.5% (Arnold and de Lange 1990).

25.4.4 Subsidence

A well-known effect of drainage is the subsidence of the land surface (Chapter 13). Especially the irreversible subsidence of peat soils as a result of oxidation has major repercussions on the environment. The rate of oxidation is related to the depth of the watertable and the temperature: with a high watertable and a low temperature, the oxidation rate is low. Thus, to conserve a peat layer, a high watertable should be maintained. But a high watertable implies a low bearing capacity of the land. Peat soils are therefore unsuitable for arable crops, which require a relatively deep aerated layer and a good bearing capacity to allow the use of machinery, unless one accepts

a high subsidence rate and can pay for the ever-increasing pumping costs to keep the watertable deep enough.

Although most peat land was originally reclaimed to create crop land, arable agriculture on peat soils is rare nowadays in The Netherlands. Most of the peat soils are used for grassland and on a smaller scale for horticulture (flowers and vegetables). To increase the bearing capacity, farmers tend to lower the watertable, resulting in a more rapid subsidence (Example 25.4). Elsewhere (e.g. in Florida, U.S.A.), arable use, accompanied by subsidence of more than 5 cm a year, is not uncommon. In drier climates, there can be a subsequent danger of wind eroding the top of the peat soil.

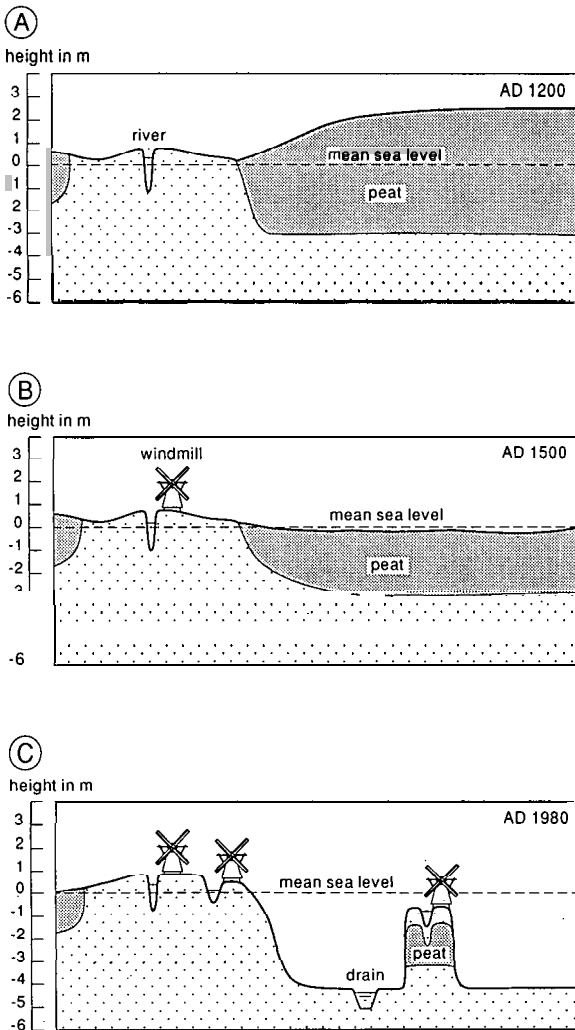

Figure 25.1 The subsidence of peat soils in the western part of The Netherlands (after De Bakker 1982):
 (A) Before reclamation;
 (B) After reclamation by drainage;
 (C) Present situation where peat layers have disappeared because of oxidation and excavation

It should be realized, moreover, that even when a high watertable is maintained, the peat will become oxidized and, in the end, will disappear altogether.

Example 25.4

In the western parts of The Netherlands, the reclamation of the peat areas started around 1000 A.D. (Van der Molen 1982). As the areas were elevated above the river levels, drainage by gravity was easy. The water levels, which were controlled by sluices, could be maintained at a depth that allowed arable crops to be cultivated. Because of the subsidence of the peat layers, however, the drainage deteriorated and, in the fifteenth century, arable cultivation was gradually replaced by grassland. Nevertheless, the land continued to subside, and new techniques were needed to drain the areas. From the sixteenth century onwards, windmills were widely used to pump out the drainage water, thereby maintaining a good drainage base, but consequently increasing subsidence. Subsequently, the drainage base has been lowered from time to time, and nowadays, instead of a few metres above mean sea level, these areas are now several metres below it (Figure 25.1).

25.4.5 Salinization

In irrigated agriculture, irrigation itself is the main source of salts (Chapter 14). About one-third of the gross area of irrigated land (270 million ha) is to some extent affected by salinity (Scott 1993). Even if the irrigation water is of good quality, it still brings in large amounts of salts (Example 25.5). In arid and semi-arid regions, irrigation can also cause secondary salinization through the capillary rise of saline groundwater. To prevent salinization, all these salts have to be removed by the drainage water. So drainage is the price one has to pay for sustainable agriculture in irrigated lands.

Sometimes, improved drainage can be an additional source of salts, as, for instance, when the lowered watertable induces saline seepage from outside the area (Section 25.4.7) or when the drainage flow brings back into solution salts from the deeper soil layers. Both effects increase the salinity of the drainage effluent, which can have environmental effects both within the project area and downstream of it.

Example 25.5

Agriculture in Egypt depends almost entirely on irrigation from the River Nile. With the year-round availability of water, two or three crops a year can be grown. Under the present cropping pattern, the quantity of irrigation water applied to a representative area in the southern part of the Nile Delta is about 1240 mm/year (Abdalla et al. 1990). Although the irrigation water is of good quality (0.3 dS/m), it brings salts into the soils at a rate of 8.0 ton/ha/year. To guarantee sustainable land use, this amount of salts has to be leached from the soil each year.

25.4.6 Acidification

Many rich coastal wetland environments are lost by the improper reclamation of soils that contain pyrite (acid sulphate soils; Chapter 3, Section 3.7.1). Subsoil layers

brought into contact with the air through drainage become oxidized, leading to the formation of sulphuric acid. Triggered by drainage, the acidification of the soil can be so pronounced, with pH values dropping to below 3, that plant and animal life are seriously affected (Example 25.6).

Careful water management, in combination with agronomic measures, can help to rehabilitate abandoned areas and enable a sustainable use of the remaining areas. To prevent the pyrite from oxidizing, a high watertable has to be maintained in all cases. Other measures that can help to reduce the acidity include liming and the disposal of the acid drainage effluent.

Beside the fact that drainage of acid sulphate soils for agriculture is difficult, it can also have major negative impacts on the environment (Dent 1986):

- Loss of habitat: Acid sulphate soils are often found in coastal lowlands, which are the base of the local food chain. So the ecological impact of land drainage is not confined to the drained area;
- Loss of amenity (e.g. landscape and recreational values);
- Changes in sedimentation and erosion: Reclamation reduces the buffer functions of the area (i.e. the temporary storage of flood water; sediment and silt trap);
- Change in water chemistry: The drainage of acid sulphate soils inevitably increases the acidity of the drainage water. This may change the fauna and fish populations both within the project area and downstream of it (Example 25.2) and may make the effluent unsuitable for irrigation downstream;
- Diseases: The change from a saline or brackish water environment to a fresh water environment can increase the hazards of vector-borne diseases.

As was said at the beginning of this chapter, it is a matter of careful comparison whether the advantages of reclamation and drainage outweigh the disadvantages.

Example 25.6

The soils of Pulau Petak, an island in the delta of the Barito River in South Kalimantan, Indonesia, are mainly acid sulphate soils (AARD and LAWOO 1992). Because of the high watertable, the soils were permanently reduced so that no oxidation and subsequent acidification took place; the soils were potential acid sulphate soils. The area was covered by mangrove forest along the coast and by tidal (fresh-water) swamp forest more inland. About 150 000 ha of the 220 000 ha have been systematically reclaimed since 1920. Of the originally reclaimed area, however, 75 000 ha have been abandoned again because of the acidification as a result of drainage; the soils have become actual acid sulphate soils.

25.4.7 Seepage

A lowered watertable inside the project area can increase the seepage into the area because of the increase in hydraulic head (Chapter 9). If the seepage water is fresh, the only effects are higher drainage rates and, in some cases, a lower watertable upstream of the project area (Section 25.6). If the seepage water is brackish or saline, however, salts are brought into the area, thereby increasing the hazard of salinization (Example 25.7), which, in its turn, can also have effects downstream of the project area (Section 25.5.1).

Example 25.7

The Fordwah Eastern Sadiqia Project in the southern part of the Punjab Province of Pakistan has a serious waterlogging-and-salinity problem (Mian and van Remmen 1991). To dispose of the poor-quality drainage water, a surface drain to the Sutlej River was proposed and was partially constructed. To reach the River the drain had to cross a fresh-water zone along the river. Contamination of the fresh-water aquifer through seepage from the surface drain was likely, and public pressure stopped the project. Rather than disposing of the water to the River a new drain has been planned to an evaporation pond that will be constructed in the Cholistan Desert.

25.4.8 Erosion

Drainage can either increase or decrease erosion. A lower watertable will result in a drier top soil, which, under certain conditions, can increase wind erosion (e.g. of peat soils). On the other hand, a subsurface drainage system can reduce surface runoff and subsequently decrease erosion (Example 25.8). In sloping areas (slopes > 2%), surface drainage is closely related to erosion control. (Methods of regulating or intercepting the overland flow before it becomes an erosion hazard were discussed in Chapter 20).

Example 25.8

In the Lower Mississippi Valley, annual precipitation exceeds evapotranspiration by 500 to 1000 mm, resulting in high watertables and surface runoff. From 1981 to 1986, a drainage-runoff-erosion study was conducted in an experimental area on an alluvial (clay loam) soil (Bengtson et al. 1988). The installation of a subsurface drainage system reduced the surface runoff by 34%, although the total drainage was increased by 35%. The change from surface runoff to subsurface outflow had the following positive effects: it reduced soil loss by 30%, nitrogen loss by 20%, and phosphorus loss by 36%. Thus the subsurface drainage system had positive effects, but on the other hand it increased the total drainage outflow.

25.4.9 Leaching of Nutrients, Pesticides, and Other Elements

One of the direct effects of drainage is that it introduces a discharge through the drainage system. In this respect, water can act as a vehicle for all kinds of soluble elements that are stored in the soil. These elements (e.g. nutrients, herbicides, pesticides, organic matter, salts, and toxic trace elements) can be leached from the soil and can pollute the drainage effluent. Sometimes this is done intentionally (e.g. to leach salts in irrigated areas; Chapter 15), but it is often an unintended side-effect (Example 25.15). The effect these elements have on the environment depends, among other things, on climatological conditions, on agricultural practices (quantity and quality of the fertilizers and pesticides used), and on the type of soil. Sometimes, the effect can be positive (i.e. when the losses of nutrients can be reduced; Example 25.8), sometimes negative (i.e. when fertilizer applications are excessive; Example 25.9). If the effects are negative, preventive measures to reduce the flow of drainage water are

often the only options because measures to treat this type of non-point pollution are extremely costly. An overview of the present state of knowledge about the effect of agriculture on the quality of the (ground)water is given by Bouwer and Bowman (1989).

Example 25.9

Nitrate losses through the subsurface drainage system on a farm near Bologna in northern Italy were monitored for three years (Rossi et al. 1991). A good correlation was found between the nitrate losses and the amount of water evacuated through the drainage system. The greatest nitrate losses were recorded during winter and early spring when drainage was at its highest (Figure 25.2).

The annual rate of nitrate losses of 214 kg NO₃/ha (50 kg N/ha) indicates a major contribution to the eutrophication (i.e. the chemical enrichment) of surface water. Because these losses were high compared with the amount of fertilizer applied (150 kg N/ha), reconsidering the farming practices (timing, rate, form, and placement of nitrogen fertilizer applications) could be a way to reduce the negative effects.

25.4.10 Health

The drainage of agricultural land can also have an effect on the living conditions in the area. Drainage for health was already practised by the ancient Greeks and Romans, who drained swamps and other stagnant water bodies to control malaria long before Ross's discovery in 1889 of the role of the mosquito in transmitting the disease. While drainage was practised with apparent success, the cause of the disease, the transmission mechanism, and the way drainage affected the transmission were not properly

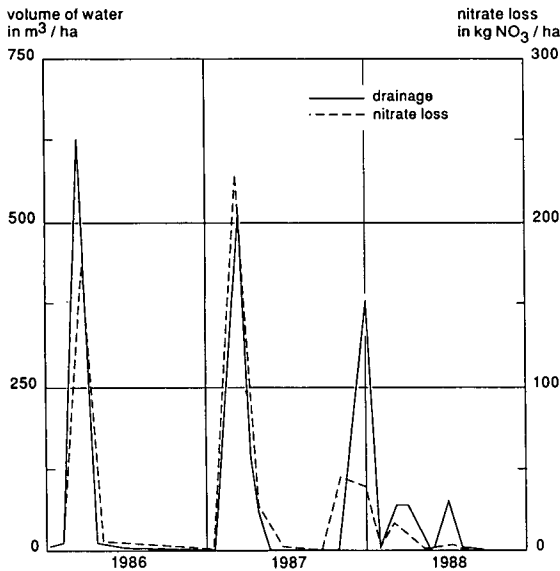

Figure 25.2 Seasonal pattern of subsurface drainage discharge and nitrate losses via subsurface drainage water (after Rossi et al. 1991)

understood: the Romans used the term *mal aria* (= bad air) to indicate a disease that they thought was caused by breathing the poisoned air from swamps and stagnant water bodies. It was only after the discovery of the role of the mosquito in the transmission of malaria that the control of this disease got a proper scientific base.

Water-related diseases are classified as follows (Birley 1989):

- a) Diseases prevented by washing and bathing (e.g. skin and eye diseases and diarrhoeal diseases);
- b) Diseases prevented by clean water supply and sanitation (e.g. typhoid, cholera, and hookworm);
- c) Diseases acquired by water contact (e.g. schistosomiasis or bilharzia);
- d) Diseases acquired from bites by water-related insects (e.g. malaria, yellow fever, and river blindness).

The diseases referred under a) and b) belong to the domain of water-supply and sanitation engineers and will not be discussed here. The activities of drainage engineers have a greater impact on the diseases listed under c) and d). These diseases are often called vector-borne diseases. The word vector refers to the organism that transmits the organism or substance which causes the disease.

Agricultural development projects, and especially irrigation projects, can have a negative impact on human health if they increase the size and number of vector habitats. Drainage can help to control vector-borne diseases by eliminating or reducing open water bodies that vectors live or breed in. In the first half of this century, colonial governments and commercial enterprises in the tropics spent a great deal of money on drainage works in an effort to prevent their administrators, labourers, and new settlers from falling victim to diseases that could signal the end of a town, rubber plantation, or an irrigation project (Snellen 1987).

Much of this experience has been lost in the second half of this century, through the sole reliance on chemical control. The increased resistance to drugs by the organisms that cause the disease, and to chemicals by the disease vectors, implies that a control strategy relying solely on chemicals cannot be sustained. Sustainable control of vector-borne diseases calls for a strategy that uses the potential of environmental measures to the full. A successful strategy incorporates three basic elements for the control of vector-borne diseases:

- Medical treatment;
- Reduction of vector-human contact;
- Reduction of vectors.

Drainage plays an important role in the last two strategies by incorporating disease-control measures into the design, construction, and operation of a drainage scheme (Example 25.10). Measures that involve drainage aim at (Oomen et al. 1990):

- Eliminating stagnant water by improving drainage, reducing seepage, etc.;
- Increasing water velocities in reservoirs, canals, and drains;
- Clearing vegetation from banks, canals, and drains.

The World Health Organization (WHO 1982) lists environmental-management measures that have proved useful in preventing and controlling malaria and schistosomiasis.

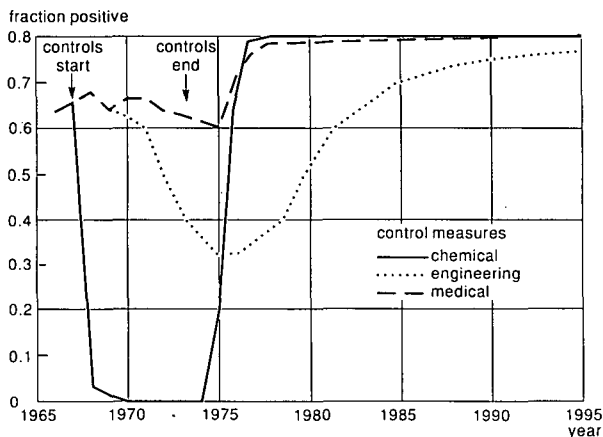

Figure 25.3 Predicted bilharzia prevalence in the Dez Irrigation Scheme, Iran (after Oomen et al. 1988)

Besides the positive impact that drainage has on public health, it can also have negative impacts (e.g. the leaching of high concentrations of toxic trace elements; Section 25.4.9). High concentrations of these elements can pollute the receiving water and be a health hazard. The maximum acceptable levels as recommended by the U.S. Environmental Protection Agency are given by Hornsby (1990).

Example 25.10

In the Dez Pilot Irrigation Project in Khuzestan Province, western Iran, irrigation in a 20 000 ha area started in 1965. Recognizing that any expansion in irrigation would also increase the prevalence of bilharzia, the authorities set up a bilharzia-control program in 1967 (Oomen et al. 1988). The program consisted of three types of measures: engineering, chemical, and medical. The engineering measures were to drain or fill borrow-pits, small ponds, and swampy areas around villages; the banks of canals were repaired; canals were dredged, and the land-levelling program was expanded. Chemicals were used to kill the snails. Finally, if the prevalence of bilharzia remained above 10%, drugs were used. Within eight years of the start of the control program, the prevalence of urinary bilharzia had been brought down to the 2% level. A stability analysis involving computer simulations showed that, if the control program were to be terminated, the impact of the engineering methods is superior to that of drugs and chemicals, particularly in the first decade (Figure 25.3).

25.5 Downstream Side-Effects

25.5.1 Disposal of Drainage Effluent

General

Drainage water has to be disposed of, either by gravity flow or by pumping, via a canal or directly into a river leading to the sea, or, more rarely, into an inland lake without an outlet, which generally consists of a specially created evaporation pond or series of ponds, or into an underground sink. On the way to its destination, the

drainage water can influence its surroundings in various ways. The problems associated with the disposal of drainage water are not the same everywhere. Here, we make a distinction between disposal in humid temperate areas, in humid tropical areas, and in arid or semi-arid areas.

Humid Temperate Areas

Technically speaking, drainage in many countries in the humid temperate zone is no longer a problem. The new, as yet unsolved, problem that has cropped up in the last 25 years is the pollution of surface water and groundwater as a result of the leaching of excessive amounts of fertilizers, liquid manure, pesticides, and herbicides. In principle, these problems are the result of intensified cropping practices and are not caused by drainage. When applied in quantities in excess of what is used by the crop or retained by the soil, fertilizers, manure, pesticides, and herbicides are partly leached out of the soil (Example 25.9). Subsequently, the leaching water either joins the groundwater or, if the land is drained, it appears as drainage effluent in the surface water. In both cases, considerable environmental problems can develop.

Nitrogen and phosphate that are leached out of intensively fertilized soils are major elements that cause the eutrophication of surface waters. Because more nutrients are available, the eutrophication leads to higher productivity that to some extent can be appreciated in a positive way. Nevertheless, the higher productivity includes excessive algae growth, and the subsequent turbidity causes many creatures to perish. Further, pesticides and herbicides leached from agricultural land and added to the drainage effluent can have toxic effects (Example 25.15).

Humid Tropical Areas

In the coastal plains of many countries in the humid tropics, large areas of peat and acid sulphate soils are found. If peat soils are drained, irreversible subsidence results, and if acid sulphate soils are reclaimed, the quality of the drainage water deteriorates as a result of the acidification. The negative effects often extend outside the reclaimed areas, because of the loss of functions and the change in the quality of the drainage effluent (Section 25.4.6).

Arid and Semi-Arid Areas

The main purpose of drainage in arid and semi-arid areas is salinity control (i.e. by leaching out the salts that would become harmful to irrigated production if they remained in the soil; Chapter 14). More often than not, the disposal of the effluent is a costly affair, and an appropriate disposal (i.e. without considerable environmental side-effects) can be prohibitively expensive. For reasons of costs, many irrigation schemes in arid and semi-arid areas have no drainage system at all, or, if they do, the saline drainage water is often disposed of (i.e. dumped) into a river whose water has to be used for irrigation or other purposes downstream. Because the drainage of irrigated lands is – with few exceptions – essential for sustainable irrigated production, the problem of a cost-effective and environmentally-safe disposal of drainage effluent is one of the most urgent items to be tackled. The challenge of solving this problem, even in rich countries, is enormous. If no action is taken, many irrigated areas will be ruined and lost forever through salinization and sodification.

Because of limited rainfall, most soils in arid and semi-arid regions contain large quantities of soluble material below the rootzone. When these soils are irrigated, harmful salt concentrations can develop in the rootzone because of the addition of the salts brought in with the irrigation water (which is transpired by the plants), and because of the upward movement of salts by capillary rise from below the rootzone (Chapter 11). By over-irrigating (for leaching), accompanied by drainage, these harmful salt concentrations in the rootzone will not develop (Chapter 15). The consequence of this process is that the drainage effluent contains a relatively high concentration of salts. The salt concentration, or the composition of the salt, can be such that the water is an environmental hazard, by being an unsuitable habitat for aquatic creatures, by being unsafe for drinking, and by being unsuitable for irrigation.

Reducing the problem either by using large quantities of water for leaching or by mixing the drainage effluent with water that has a low salt concentration to reduce the salinity of the drainage water to acceptable levels is generally impossible because the water is simply not available.

25.5.2 Disposal Options

Options to minimize the disposal problem can be either to reduce the quantity of drainage water by preventive measures or to solve or reduce the effects of the disposal of drainage water. Preventive measures should aim at improving irrigation and drainage efficiencies. Measures to reduce the downstream effects of the disposal of drainage effluent are:

- The re-use of the drainage water;
- Discharge to surface water;
- Evaporation ponds;
- Desalination;
- Deep-well injection.

The two preventive methods and the first three disposal options will be discussed in this section. The last two options, well-known treatments in the oil and gas industry, are at present not used to dispose of drainage water and will not be further elaborated, although reference is made to Tanji (1990).

Improving Irrigation Efficiency

The question of whether or not to increase irrigation efficiency was discussed in Chapter 14. Wolters (1992), in a study covering about 5% of the total irrigated area in the world, reported irrigation efficiencies varying between 10 and 80%. Sometimes, low efficiencies are acceptable or unavoidable, but in other circumstances it may be necessary to increase already high efficiencies. If irrigation efficiency can be increased, the amount of water percolating to the groundwater will be reduced, thereby increasing the drainage efficiency.

The technical measures to solve irrigation-induced water-disposal problems can seldom be considered on their own. They need to be underpinned by charges, subsidies, a legal framework, and other supporting measures.

Charges and subsidies are effective incentives to encourage people to perform certain activities, or to discourage them from doing so. Charges can be an effective tool to control water consumption or disposal. In many countries, actual water charges are far below the cost of water development, which means that there is little or no incentive to economize on irrigation water. By making water available to irrigators at cost price, which is usually much higher than the price charged, an incentive for water saving can be introduced.

Improving Drainage Efficiency

Sometimes, drainage efficiency can be improved by installing a shallower drainage system or maintaining a higher watertable during part of the year as was discussed in Section 25.4.3. This not only reduces water shortages but can also prevent the drainage of deeper saline aquifers, which can deteriorate the quality of the drainage water (Grismer 1989).

Waste water, which is often polluted in one way or another, cannot generally be disposed of free of charge. Urban councils, responsible for waste-water treatment, charge households and industrial customers under the banner of 'The polluter pays'. In many countries, agricultural waste water, including drainage water from irrigated lands, can be dumped free of any charge. By instituting a waste-water-disposal charge that is related to the quality and quantity of the released effluent, the agricultural polluters could pay for preventing or cleaning up the environmental damage they cause.

Re-Use

The re-use of drainage water is practised worldwide, mostly in arid or semi-arid regions where irrigation water is in short supply, but also in temperate regions, where re-use is practised during the dry summer months. Re-use can be practised at farm level, project level, and regional level. Drainage water can never be completely re-used, however, because the salts that are imported with the irrigation water have to be exported out of the area. It is therefore always necessary to make a water and salt balance to calculate the long-term effects of the re-use of drainage water on soil salinity (Chapters 15 and 16).

Re-use at farm level can be practised when the drainage water is of good quality. Farmers can pump irrigation water directly from the open drains (Example 25.11) or use shallow wells to pump groundwater.

Re-use at project and regional level is practised when drainage water is pumped back into the irrigation system (Example 25.12). With this type of re-use, the drainage water is automatically mixed with better-quality irrigation water. The quantity and quality of both the irrigation and drainage water determine how much drainage water can be re-used. Because this type of re-use requires high investment costs (i.e. the construction of pumping stations) and because the effects on soil salinity are difficult to predict, careful planning is a prerequisite. Computer simulations can help to predict future changes, as will be illustrated in Example 25.11.

Example 25.11

In the Nile Delta in Egypt, farmers re-use drainage water by pumping it for irrigation directly from the drains. On the basis of a measuring program and simulations with

the SIWARE integrated water-management model (Abdel Gawad et al. 1991), it is estimated that, in the eastern part of the Nile Delta, 15% of the crop water is supplied from groundwater and on-farm re-use. A major disadvantage of this type of re-use is that, because the salinity of the re-used water is often high, it contributes more than proportionally to the total salt supply to the crop. For the Eastern Nile Delta, the chloride contribution of the 15% re-used water is about 46% of the total crop chloride supply through irrigation.

Example 25.12

Since 1930, 21 pumping stations have been built in the Nile Delta in Egypt to pump part of the drainage water back into the irrigation system (El Quosy 1989). In the 1980's approximately 2.9×10^9 m³/year of drainage water with an average salinity of 1.45 dS/m was pumped back into the irrigation system, totalling approximately 15% of the crop water supply.

Discharge to Surface Waters

In general, drainage water is discharged to rivers or lakes. If this water is used again for irrigation in downstream reaches, it can also be regarded as re-use. The natural flow in the river, both quantitatively and qualitatively, determines how much drainage water can be discharged into it (Example 25.13). Models can be used to simulate the effect of the disposal of re-used water on the river regime (e.g. Smedema et al. 1992).

Example 25.13

Once more, Egypt serves as an example. Agriculture in Egypt depends almost entirely on irrigation from the Nile. Of the amount of water passing the Aswan High Dam (approximately 55×10^9 m³/year), part is used to irrigate the Nile Valley between Aswan and Cairo (approximately 0.9×10^6 ha). Because all the drainage water is discharged back into the River Nile, the salinity of the Nile water increases in downstream direction (Table 25.2). The increase in the total salt load between Cairo and the Mediterranean Sea is due to the leaching of deeper (saline) soil layers and the seepage of saline groundwater.

If the receiving water cannot cope with the amount of drainage water, a separate facility to a safe outlet, usually the sea, has to be constructed. Two of the best known outfall drains, especially created for the disposal of highly saline drainage water, are the Left Bank Outfall Drain in Pakistan (Example 25.14) and the Third River in Iraq.

Table 25.2 Discharge, salinity, and salt load in the River Nile (after El Quosy 1989)

Location	Discharge ($\times 10^9$ m ³ /yr)	Salinity (dS/m)	Total salts ($\times 10^9$ kg)
Aswan High Dam	55	0.31	11.0
Delta Barrage (Cairo)	35	0.47	10.5
Mediterranean Sea	14	3.59	32.0

The Third River, which was completed in 1993, acts as an outfall drain for the area between the Euphrates and the Tigris.

But even the disposal to such a 'safe' outlet (the sea) can have environmental effects. An example is the eutrophication of the North Sea caused by the leaching of minerals from agricultural land as a result of the excessive use of manure, fertilizers, and pesticides.

Example 25.14

The Left Bank Outfall Drain has been constructed to drain approximately 0.5 million ha in the Sind Province of Pakistan (McCready 1987). The disposal of the drainage effluent to the River Indus or one of its branches is unacceptable because of the high salinity levels: the effluent from subsurface drainage can vary from 4.7 to 15 dS/m and that from tubewells can be twice as saline. Disposal into the river would result in too high salinity levels and would make downstream use for irrigation impossible.

Evaporation Ponds

If there is no safe outlet available for the drainage effluent, evaporation ponds can be used. In such ponds, the drainage effluent evaporates from the open water surface, leaving the salts and other soluble trace elements behind. This results in large amounts of soluble salts and trace elements.

The size of an evaporation pond must satisfy the needs of the land area being drained, which means it must be based on the volume of drain water and the rate of evaporation for that region. Evaporation ponds can be natural depressions or artificial basins. Natural depressions have the advantage that the drainage effluent can be discharged by gravity flow, and the only construction work involved is to make earthen embankments and a spillway to regulate the water level in the pond. Artificial basins generally need pumping facilities to lift the drainage effluent.

The disadvantages of evaporation ponds are: loss of land, seepage, and the disposal of the remaining salts. Experience in California indicates that the area needed for evaporation ponds comes to 10 to 14% of the land area (Tanji 1990). Seepage from the pond to any underlying aquifer should be avoided because of the large quantities of soluble salts and trace elements involved. Especially in coarser soils, the ponds should be lined. Sometimes, evaporation ponds can be used to store salts during periods with low river flow, when the disposal of the drainage effluent would create unacceptable effects downstream. The ponds are then flushed during high river floods, discharging the salts safely to the sea. If no periodic flushing is possible, the removal of the salts is problematic, especially when the drainage water contains toxic trace elements.

To some extent, the environmental impact of dumping saline water in ponds is predictable. Nevertheless, the Kesterson experience in California, U.S.A., proves that there are unexpected and unpredictable dangers in evaporation ponds (Example 25.15).

Example 25.15

The San Joaquin River basin in California, U.S.A., has about 2 million hectares of irrigated agriculture. Salinity affects part of these lands and subsurface drainage was therefore installed. The quality of the drainage water was such that its disposal in

the San Joaquin River created problems for its downstream use for irrigation. A separate drainage canal, the San Luis Drain, was therefore planned to dispose of the drainage effluent in the San Francisco Bay. Because of environmental opposition and cost considerations, the San Luis Drain was only partly constructed. As a temporary solution awaiting the completion of the San Luis Drain, the drainage effluent was dumped into a series of evaporation ponds that became known as the Kesterson Reservoir (CIIWQP 1989).

The ponds, the only large water surfaces in the area, attracted great numbers of waterfowl and shorebirds, so that the area became known as the Kesterson Wildlife Refuge. Happiness about a newly created wildlife area was of short duration. Some years after the ponds began to be used, deformations in fish and birds appeared. A few years later, massive deaths occurred in birds as well as in fish. The cause of the mortality was found to be a too high concentration of the trace element, selenium, which occurs in various sediments that formed the soils of the San Joaquin Valley.

The environmental problems that gradually developed at the Kesterson Reservoir have received considerable attention and have resulted in an enormous number of publications (e.g. Summers and Anderson 1986; 1988; 1989). The events occurring at the Kesterson Reservoir appear to have been major instruments in making the U.S. aware of environmental problems associated with drainage (e.g. Summary, Highlights, and Future Trends and Prospects in: Pavelis 1987 and Tanji 1990).

25.5.3 Excess Surface Water

The installation of a subsurface drainage system can reduce surface runoff inside the project area (Example 25.8), but it can also lead to excessive surface water in downstream areas. On a small scale, this can happen when one farmer drains his land and evacuates his drainage water to the land of his downstream neighbour. On a large scale, downstream areas can suffer from excess water as a result of (surface) drainage upstream. The most common occurrence of this kind of problem is when infiltration is reduced upstream (e.g. by the felling/denudation of forests without the necessary precautions being taken to maintain the infiltration of intensive rainfall). This can cause enhanced runoff upstream and increased peak river flow and inundations in the downstream parts of river catchments. (How to calculate peak runoff rates was discussed in Chapter 4.)

25.5.4 Seepage from Drainage Canals

To reduce construction costs, main drains, which evacuate drainage effluent from upstream areas, often have water levels close to the soil surface in their downstream reach. Unless appropriate measures are taken, the productivity of land adjacent to drainage canals can be negatively affected by (saline) seepage (Example 25.16). As such seepage depends on the difference in hydraulic head and on permeability (Chapter 9), it can largely be prevented by (costly) lining or other methods which decrease embankment permeability. The magnitude of the seepage and eventual salinity resulting from it determines whether any preventive action needs to be taken.

Example 25.16

At the Fourth Drainage Project in Pakistan, a subsurface pipe drainage system disposes of the drainage effluent by pumping it into a surface drainage network for conveyance to the Ravi River (Vlotman et al. 1993). Subsurface PVC interceptor drains were constructed along some sections of the surface drains to stabilize the deeply cut side slopes. Generally, the water level in the surface drainage system is higher than the watertable in the field, so the interceptor drains also intercept saline seepage water from the surface drains. Up to 40% of the discharge of one of the pumps of the subsurface drainage system comprised water from the interceptor drains.

It is expected that the water quality in the surface drainage system will deteriorate with time when more subsurface drainage units become operational. To protect the adjacent agricultural lands, the seepage from these surface drains has to be intercepted.

25.6 Upstream Side-Effects

Lowering the watertable in the project area usually leads to more seepage into the area and also to a lowering of the watertable in the area upstream of the project. In non-irrigated areas, such a lowering of the watertable can negatively affect plant growth because the contact between the (non-saline) groundwater and the rootzone is broken and this will lead to a decrease in yield. To prevent a fall in groundwater in the areas upstream of the reclaimed polders in the IJsselmeer in The Netherlands, border lakes have been maintained as a buffer.

25.7 Environmental Impact Assessment

In the previous sections, it has been shown that drainage can have many environmental impacts and that its relationship with the agricultural options can be complex. An Environmental Impact Assessment (EIA) is used as a tool for identifying alternative options during the reconnaissance and/or feasibility phase of the project cycle and to assess the environmental impacts of each of these options. It is merely a prediction of what may happen once a project is implemented. It is not the actual development, but only a scenario, which can make the decision-making process more clear. In this section, we shall briefly discuss the principles of an EIA. (For more details, see ODA 1992; Meister 1990; World Bank 1989; Biswas and Geping 1987; or Winpenny 1991.)

The purpose of an EIA is to ensure that the development options under consideration are environmentally sound and sustainable, and that any environmental consequences are recognized early in the project cycle and are taken into account in the project design. The EIA is characterized by the following steps (Figure 25.4):

- Defining the objectives of the project and selecting the evaluation criteria;
- Formulating alternative development options;
- Assessing the environmental effects;
- Selecting the evaluation method;
- The evaluation;
- Results of the evaluation/conclusions.

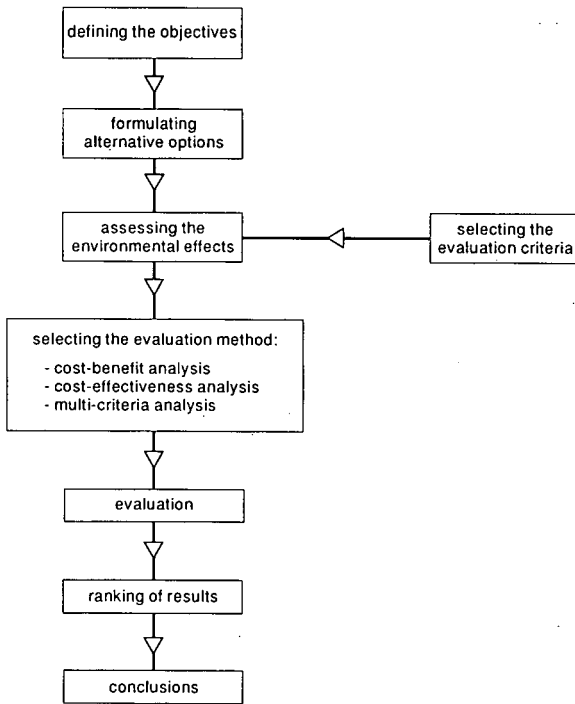

Figure 25.4 Steps in an Environmental Impact Assessment

Objectives and Criteria

In many countries, there is a legal obligation for an EIA before decisions can be made about the implementation of (major) projects. At this stage, it should be clear who is responsible for the EIA, what the scope of the study will be, how the results of the EIA will be presented, and who will use the results. It is important to realise that an EIA should focus on the main issues. Going into too much detail will make it extremely difficult to evaluate the alternative options. To make a good EIA, the objectives of the proposed project must be well defined, and the criteria, which will be used to compare the alternative options, must be clearly stated.

Alternative Options

Alternative options may include alternative sites, alternative technologies, or alternative phasing. It should be kept in mind that only the main issues are to be considered, so the selected options should not be too detailed. A difficult question is the number of options that should be considered. On the one hand, too many options make a comparison difficult, but, on the other hand, one should be careful not to exclude options that at first glance look unrealistic. Care should be also taken that the selected options are not biased. For example, an engineer, using his common 'technological' sense, tends to select the options that he favours, often excluding non-technical options. It is essential that the 'no project' option be included. The choice is rarely 'environment-versus-development', but rather a question of incorporating

sensible environmental protection measures into the earliest stages of development projects.

Assessment of Effects

At this stage, the environmental effects of the project should be identified and quantified. The parameters that are used to quantify these effects can be technical (e.g. groundwater salinity, subsidence), but also socio-economic (e.g. farm income, health). Some impacts that may be difficult to quantify can only be assessed in a qualitative form. Checklists of possible environmental impacts have been prepared by the International Commission on Irrigation and Drainage (Mock and Bolton 1993) and the Overseas Development Administration (1992).

Baseline data on these parameters have to be collected and the changes that will result from the project activities have to be assessed. One of the reasons for including the 'no-project' option is that, with this option, the autonomous developments can be made visible.

Evaluation Methods

To select the best option, the combined effects of each option have to be compared. In an economic evaluation, this is done by translating these effects into monetary terms. When impacts cannot be monetized, however, they have to be retained in the analysis in a qualitative manner. Three evaluation methods will be briefly discussed: the Cost-Benefit Analysis, the Cost-Effectiveness Analysis, and the Multi-Criteria Analysis.

The Cost-Benefit Analysis (CBA) is an economic evaluation method in which the project's monetized benefits and costs are compared to verify its economic feasibility. The CBA includes three steps:

- All negative and positive effects are quantified in monetary values;
- For each effect, the present value is calculated;
- The best option is selected, using the Net Present Value (NPV), the Benefit-Cost Ratio (BCR), or the Internal Rate of Return (IRR).

The NPV and BCR methods use a pre-selected interest rate, which is called the Opportunity Cost of Capital (OCC). The IRR does not require a pre-selected interest rate, but the same judgement is needed to determine whether the project is economically attractive. The World Bank, for example, uses the IRR method, but usually requires the IRR to attain 10 to 12% for all projects.

Advantages of the CBA are that all effects are expressed in the same (monetary) dimension, which makes a straightforward comparison of the alternative options possible.

Limitations of the CBA are that:

- Effects have to be monetized, so effects that cannot be monetized are left out;
- The distribution of benefits and costs over the various parties involved is not taken into consideration unless 'social prices' are used;
- The long-term effects that are valued according to the process of discounting reduces the future net benefits.

Especially when long-term effects on the environment are uncertain or irreversible, the economic concept of discounting is controversial. In practice, measuring and evaluating problems have often impeded a comprehensive treatment of environmental effects in a CBA. If a function/value table is included, it is possible to incorporate environmental costs and benefits in the CBA. Alternative methods to overcome these limitations have been presented by Dixon et al. (1988)

The Cost-Effectiveness Analysis (CEA) investigates the best or cheapest way of achieving a desired objective by comparing the costs of possible interventions. The benefits are not expressed in monetary terms but in only one representative criterion that quantifies the effects of the project. Advantages of the CEA are that non-monetary effects can be included. Nevertheless, it is difficult to attribute all effects to one criterion, and often side-effects are not taken into consideration. Furthermore, because the benefits are not expressed in monetary terms, it is not possible to include the factor time and thus to compare effects which occur at different time steps.

The Multi-Criteria Analysis (MCA) is an example of a non-monetary evaluation method in which alternative options are compared using criteria of different dimensions. To account for the relative importance of each criterion, a weight can be attributed to it. MCA methods have been developed to overcome the limitations of the economic evaluation methods that all effects have to be expressed in monetary terms. As it is difficult to judge the importance of each criterion, however, and thus to select the correct weighting factor, the results of a MCA are often ambiguous. (For examples of MCA, see the United Nations Environmental Programme 1988.)

Results of Evaluation

The evaluation should result in a priority ranking of the selected options and, based on this classification, an option has to be selected. At this stage, it is important to know the degree of confidence of the EIA, the need for further data collection, analysis, etc.

In general, it can be said that an Environmental Impact Assessment makes it possible to assess environmental impacts and to compare alternative options systematically. Furthermore, the method requires that objectives and selection criteria be clearly stated and that the results are presented in a classified way. A major drawback is that the method suggests objectivity, but in reality each step requires subjective choices (selection of criteria, selection of options, selection of parameters, etc.).

References

- Agency for Agricultural Research and Development and Land and Water Research Group 1992. Acid sulphate soils in the humid tropics : Water management and soil fertility. AARD, Jakarta, 283 p.
- Abdalla, M.A., M.S. Abdel Dayem and H.P. Ritzema 1990. Subsurface drainage rates and salt leaching for typical field crops in Egypt. In: Symposium on land drainage for salinity control in arid and semi-arid regions. Drainage Research Institute, Cairo, pp. 383-392.
- Abdel Gawad, S.T., M.A. Abdel Khalek, D. Boels, D.E. El Quosy, C.W.J. Roest, P.E. Rijtema and M.F.R. Smit 1991. Analysis of water management in the Eastern Nile Delta. Re-Use of Drainage Water Project Report 30. The Winand Staring Centre, Wageningen, 245 p.

- Arnold, G.E. and W.J. de Lange 1990. Waterhuishoudkundige maatregelen naast onttrekking een belangrijke oorzaak van verdroging. *Landinrichting*, 30, pp. 19-24.
- Bengtson, R.L., C.E. Carter, H.F. Morris and S.A. Bartkiewicz 1988. The influence of subsurface drainage practices on nitrogen and phosphorus losses in a warm, humid climate. *Transactions of the ASAE*, 31, 3, pp. 729-733.
- Birley, M.H. 1989. Guidelines for forecasting the vector-borne disease implications of water resources development. PEEM Guidelines, Series 2, Geneva, 71 p.
- Biswas, A.K. and Q. Geping (eds.) 1987. *Environmental impact assessment for developing countries*. Tycooly, London, 232 p.
- Bouwer, H. and R.S. Bowman (eds.) 1989. *Effects of agriculture on groundwater. Agriculture, Ecosystems, and Environment* 26, pp. 161-394.
- Commission on Ecology and Development Cooperation/CEDC 1986. *Report on environment and development cooperation*. Royal Tropical Institute, Amsterdam.
- Committee on Irrigation-Induced Water-Quality Problems 1989. *Irrigation-induced water quality problems: what can be learned from the San Joaquin Valley experience*. National Academy Press, Washington, 157 p.
- De Bakker, H. 1982. Soils and their geography. In: H. de Bakker and M.W. van den Berg (eds.), *Proceedings of the symposium on peat lands below sea level*. ILRI Publication 30, Wageningen, pp. 85-97.
- Dent, D. 1986. *Acid Sulphate Soils : A baseline for research and development*. ILRI Publication 39, Wageningen, 204 p.
- Dixon, J.A., R.A. Carpenter, L.A. Fallon, P.B. Sherman and S. Manopimoke 1988. *Economic analysis of the environmental impacts of development projects*. Earthscan, London, 134 p.
- El Quosy, D.E. 1989. Drainage water re-use projects in the Nile Delta : The past, the present, and the future. In: M.H. Amer and N.A. de Ridder (eds.), *Land drainage in Egypt*. Drainage Research Institute, Cairo, pp. 163-175.
- Grismer, M.E. 1989. Drainage efficiency and drain water quality. In: V.A. Dodd and P.M. Grace (eds.), *Agricultural engineering : Proceedings of the Eleventh International Congress*. Vol. 1. Balkema, Rotterdam, pp. 285-290.
- Hornsby, A.G. 1990. Pollution and public health problems related to irrigation. In: B.A. Stewart and D.R. Nielsen (eds.), *Irrigation of agricultural crops*. American Society of Agronomy, Madison, Agronomy 30, pp. 1173-1186.
- Klepper, O., Gt. Chairuddin and Gt. M. Hatta 1992. *Ecological aspects of the development of acid sulphate soils in the humid tropics*. Agency for Agricultural Research and Development, Jakarta, 100 p.
- McCready, W. 1987. Left Bank outfall drain in Pakistan. *ICID Bulletin* 36, 1, pp. 15-19.
- Meister, A.D. 1990. *Economic analysis of environmental impacts and issues : A survey of analytical techniques*. Discussion Paper in Natural Resource Economics 14. Department of Agricultural Economics and Business, Massey University, Palmerston North, 72 p.
- Mian, A.M. and T. van Remmen 1991. *Evaporation ponds for disposal of saline drainage effluent in Pakistan (Feasibility Study, Part I, Data Collection)*. International Waterlogging and Salinity Research Institute, Lahore, Pakistan. Publication 66, 52 p.
- Mock J.F. and P. Bolton. 1993. *The ICID environmental checklist. To identify environmental effects of irrigation, drainage, and flood control projects*. Hydraulic Research, Wallingford, 143 p.
- Oomen, J.M.V., J. de Wolf and W.R. Jobin 1988 and 1990. *Health and irrigation : Incorporation of disease-control measures in irrigation, a multi-faceted task in design, construction, operation*. Volumes 1 and 2. ILRI Publication 45, Wageningen, 304 p. and 119 p.
- Overseas Development Administration 1992. *Manual of environmental appraisal*. Rev. Ed. ODA, London, 146 p.
- Pavelis G.A. 1987. *Farm drainage in the United States : History, status, and prospects*. Miscellaneous Publication 1455. USDA, Washington, 170 p.
- Rolf, H.L.M. 1989. *Verlaging van de grondwaterstanden in Nederland : analyse periode 1950-1986*. Ministerie van Verkeer en Waterstaat, 's-Gravenhage, 65 p.
- Rossi, N., C. Ciavatta and L.V. Antisari 1991. Seasonal pattern of nitrate losses from cultivated soil with subsurface drainage. *Water, Air, and Soil Pollution*, 60, pp. 1-10.
- Schultz, E. 1983. *From natural to reclaimed land : Land and water management in the polders of The Netherlands*. Water International, 8, pp. 55-60.
- Scott, S.F. 1993. *Water and sustainable agricultural development*. In: *Ecologically-sound resources management in irrigation*. DVWK Bulletin 19, Parey, Hamburg, pp. 19-50.

- Smedema, L.K., W. Wolters and P.J. Hoogenboom 1992. Re-use simulation in irrigated river basin. *Journal of Irrigation and Drainage Engineering*, 118, 6, pp. 841-851.
- Snellen, W.B. 1987. Malaria control by engineering measures : Pre-World-War-II examples from Indonesia. ILRI Annual Report, Wageningen, pp. 8-21.
- Summers, J.B. and S.S. Anderson (eds.) 1986. Toxic substances in agricultural water supply and drainage: Defining the problem. Proceedings of the 1986 Regional Meetings. U.S. Committee on Irrigation and Drainage, Denver, 358 p.
- Summers, J.B. and S.S. Anderson (eds.) 1988. Toxic substances in agricultural water supply and drainage: Searching for solutions. Report of the 1987 Panel of experts and Papers from the 1987 National Meeting at Las Vegas. U.S. Committee on Irrigation and Drainage, Denver, 167 p.
- Summers, J.B. and S.S. Anderson (eds.) 1989. Toxic substances in agricultural water supply and drainage: An international environmental perspective. Papers from the Second Pan-American Regional Conference of the International Committee on Irrigation and Drainage in Canada. U.S. Committee on Irrigation and Drainage, Denver, 424 p.
- Tanji, K.K. (ed.) 1990. Agricultural salinity assessment and management. ASCE Manuals and Reports on Engineering Practice 71, New York, 619 p.
- United Nations Environmental Programme 1988. Assessment of multiple objective water resources projects: Approaches for developing countries. UNEP, New York, 125 p.
- Van der Molen, W.H. 1982. Water management in the Western Netherlands. In: H. de Bakker and M.W. van den Berg (eds.), Proceedings of the Symposium on peat lands below sea level. ILRI Publication 30, Wageningen, pp. 106- 121.
- Vlotman, W.F. Bhutta, M.N., Reymat Ali, S. and Bhatti, A.K. 1993. Fourth drainage project, Faisalabad, 1981 – 1992. International Waterlogging and Salinity Research Institute, Lahore, Pakistan. Publication No. 159, Jun. 93, (draft).
- Winpenny, J.T. 1991. Values for the environment : A guide to economic appraisal. Overseas Development Institute, London, 277 p.
- Wolters, W. 1992. Influences on the efficiency of irrigation water use. ILRI Publication 51, Wageningen, 150 p.
- World Bank 1989. World Bank environmental assessment guidelines. World Bank Operational Manual, Operative Directive 4.00, Annex A. Washington, 14 p.
- World Health Organization 1982. Manual on environmental management for mosquito control. Offset Publication 66. WHO, Geneva.

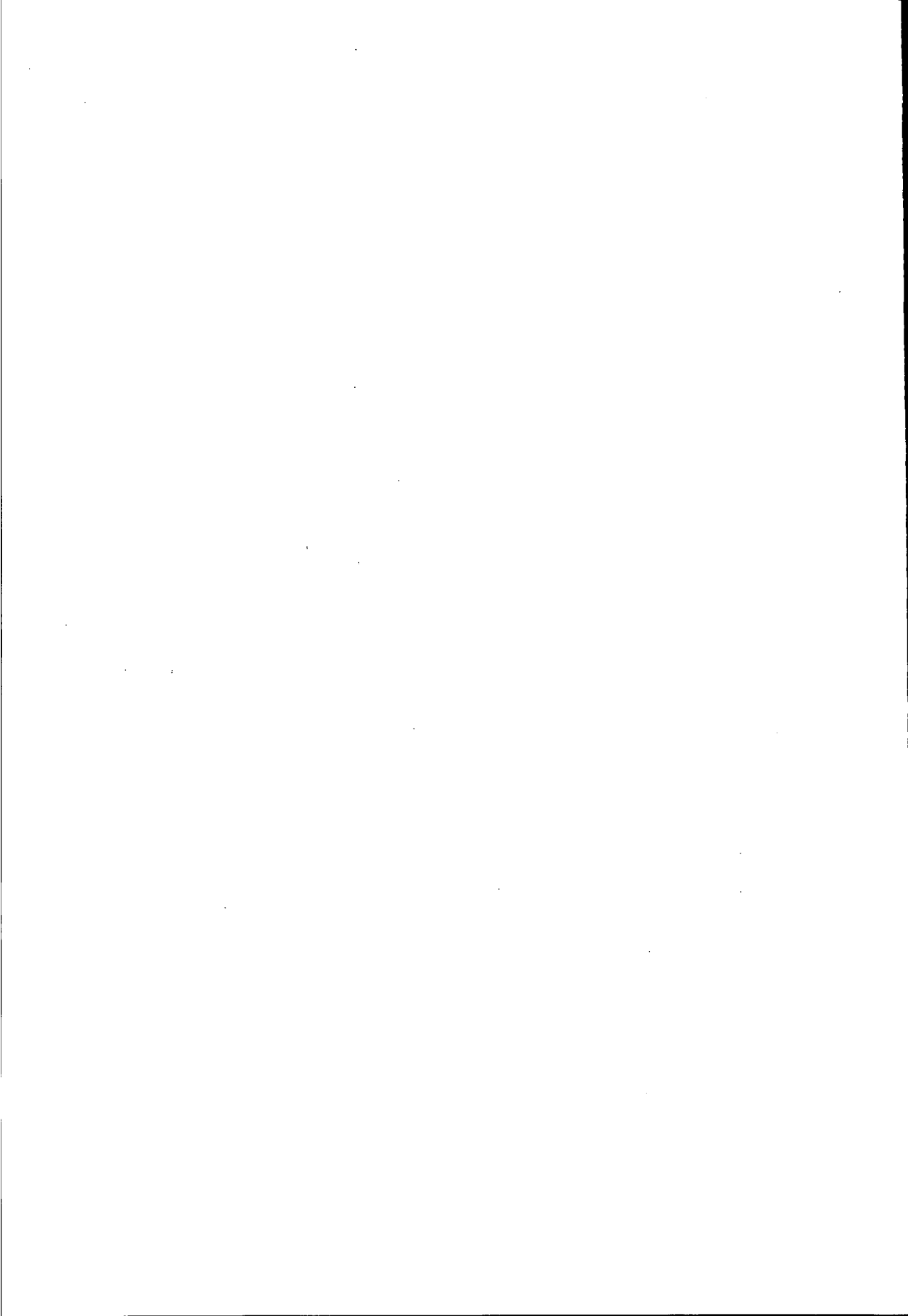

26 Land Drainage : Bibliography and Information Retrieval

G. Naber¹

26.1 Introduction

The worldwide acceleration of research is producing enormous amounts of publications. This is also occurring in land drainage. New developments, research results, and findings from field experience are being published in books, journal articles, and as papers in proceedings. Obviously, if a land drainage engineer is to keep up-to-date and avoid needless duplication of work already done by others, he must be aware of this new information. This chapter will tell him how to keep track of the most important publications, without having to read everything that is published.

26.2 Scientific Information

26.2.1 Structure

The flood of publications issued each year seems to be without any structure, but, after a closer look, a certain structure appears.

An idea, after research, either becomes a manuscript or it does not. Of those that do, there are roughly two types:

- Many manuscripts are multiplied by the author himself or by his institute. This type of publication will usually reach only a few colleagues or a few fellow-institutes; not many persons will read it. It becomes part of what is called the 'grey literature', which is difficult to trace, difficult to get, often of little value to others, and soon forgotten;
- A manuscript may be offered to the editor of a scientific journal and, after a review by a peer, becomes an article; or it may be presented at a congress and be included in the proceedings of that congress; or it may become a book published by a commercial publisher. This is called 'primary literature'. It becomes part of the international scientific literature, is announced worldwide, is far more easy to obtain, and is often of great value to others.

26.2.2 Regulatory Mechanisms that Control the Flow of Literature

Knowing the structure of scientific information will help a drainage engineer to be aware of what is published and to understand what is important and what is not.

¹ International Institute for Land Reclamation and Improvement

And yet, each year enormous amounts of information are produced. It will help the drainage engineer to realize that not all the literature produced is equally valuable. To keep informed of developments, he need not read everything that is published. Several regulatory mechanisms control the flow. These will be explained below.

Quality Selection

Of the manuscripts that become a publication, only a few finally remain as classical articles or books. After 15 years, more than 98% of publications on land drainage are entirely forgotten. This means that if an engineer is starting a new subject and needs published information about it, he need only read some recent articles and one or two review articles that tell him about the older literature.

Qualitative Concentration

Four precepts describe the processes of qualitative concentration:

- **The 'Star System':** A natural concentration of quality occurs among scientists. The leaders in the field, most of whom will be employed by well-known institutes or universities, attract others. Stars are also concentrated in well-known international organizations;
- **A Ranking Order of Journals:** Stars will usually have their work published in prestigious journals. Others will try to have their work published in the same journals. The editors of these journals, with greater numbers of manuscripts being submitted to them for publication, can afford to become ever more critical, selecting only the best articles. In this way, a journal spirals upwards in quality. It will be cited more frequently than others, will be more readily included in library collections, and more persons will subscribe to it;
- **Bradford's Law:** Bradford discovered that articles are scattered over various types of journals. Translated to the area of land drainage, his law shows that:
 - About 1/3 of the articles on land drainage are found in a small number of journals on drainage and irrigation;
 - About 1/3 of the articles on land drainage are found in a larger number of journals related to drainage (e.g. soil science, hydrology);
 - About 1/3 of the articles on land drainage appear in journals that cover a far broader field (e.g. agriculture);
- **The 80/20% Rule:** This rule applies to many things. Librarians, for instance, know that 80% of the requests they receive are for 20% of the literature on their shelves.

26.3 A Land Drainage Engineer as a User of Information

A land drainage engineer needs to know about new publications in order to be informed about new developments and about activities that are ongoing or pending. This involves the dissemination of information by abstracting services, publishers, and libraries.

Alternatively, an engineer may be facing a specific problem and is looking for a solution, or he may be starting some new research and needs to know what has been published about the subject in the past. This involves the retrieval of already existing literature.

26.3.1 The Dissemination of Information

Abstracting Services

Abstracting services (or information suppliers) 'undo' the original 'packaging' of primary literature, and treat the articles in journals, the papers in congress proceedings, and the chapters in books as separate publications. They then 'repackage' these items according to subject. Sometimes they include part of the 'grey literature' too. The titles of these repackaged items, with an abstract of their contents, are published in abstract journals.

An excellent example of how scientists are being helped to cope with 'the literature explosion' is the service provided by the Commonwealth Agricultural Bureaux International/CABI. Each year, under the very broad heading of agriculture, CABI abstracting services search through 10 000 journals and an unknown number of books, annual reports, proceedings, theses, and government reports. Publications selected during this work are inserted in the CABI database. The information available in the database is made available to customers through abstract journals.

Online Retrieval, Compact Discs

The information available in databases is also the basis for the following services:

- **Online Retrieval:** The database is made available by 'host organizations', which offer databases on various subjects. Access to this host organization is possible with the use of a microcomputer, linked via a communication or phone network to the host.
- **Compact Disc:** In some countries, telephone lines are unreliable and access to the host is difficult. Database producers have overcome this problem by making their databases available on compact disc. Anyone in possession of a microcomputer with a compact disc reader can retrieve information from the database. A subscription to the CABI compact disc, to give an example, costs about U.S. \$2500.

Selective Dissemination of Information

Many libraries offer the service of a selective dissemination of information to their users. Each month, the library informs its users of the new literature in their field. Beforehand, the library has compiled an 'interest profile' for individuals or for small groups. This profile consists of keywords that indicate the subjects in which the person or group is interested. The profile is run off each month against the new information that has been fed into databases. Titles containing the keywords of the profile are thus retrieved and a printout is passed on to the person or the group. The cost of this service varies, depending on the number of titles retrieved, but it is usually about U.S. \$250. The ILRI Library provides this service on request.

ILRI Current Awareness Bulletin

Six times a year, the ILRI Library publishes a current awareness bulletin entitled Land Soil Water. This lists all publications and articles on these subjects received by the Library in the previous two months, including new publications on land drainage. It is available free of charge to alumni of the International Course on Land Drainage and to anyone else who is interested.

Subscriptions to Journals

A subscription to one or more journals is another good way to follow developments in land drainage. Because of the different interests of persons, it is difficult to advise which journals a drainage engineer should subscribe to. Section 26.4.5 gives a list of possible journals.

Land Drainage Symposia

About once every two or three years, an international symposium on land drainage is held. The papers presented at the symposium are published in its proceedings. These usually cover many different facets of land drainage.

Publishers and Booksellers

Commercial publishers and booksellers announce their latest publications in their catalogues, which they will supply on request. One bookseller, among others, who offers a Selective Dissemination of Information/SDI service of newly published books is Dawson, Book Division.

International Organizations

The International Rice Research Institute/IRRI publishes the titles of publications of international agricultural research and development centres, in Publications of International Agricultural Research and Development Centres.

Newsletters

Newsletters, for example, Land and Water International published by NEDECO contain reviews of new publications, information on conferences being organized, and so on.

Pages of Contents

The Centro Internacional de Agricultura Tropical/CIAT publishes Pages of Contents: Soils and Plant Nutrition. This presents the contents pages of all well-known journals in the field of land and water development.

The International Livestock Centre for Africa/ILCA publishes A Quarterly Bulletin of Contents : Forage Agronomy and Soil Science.

Annual Reports

Many well-known organizations publish an annual report describing their current activities and/or new developments in land drainage. These reports are often available free of charge and are sent each year to interested parties.

26.3.2 Retrieval of Information

Online Retrieval

Databases available online or on compact disc can easily be searched with keywords that describe a subject someone is interested in. On request and free of charge, various organizations will run a search for researchers and engineers from developing countries and send them a list of relevant titles. FAO and ILRI are two such organizations; another is the Centre Technique de Coopération Agricole et Rurale/CTA.

Systematic Literature Search

A more time-consuming but excellent way of searching literature starts with consulting the tertiary literature. Tertiary literature is a guide to abstract journals and journals on the subject in which one is interested. Letters requesting the information needed can be sent to experts on the subject or to leading institutes.

Snowball Method

In the reference list of an author's publication, he lists publications which he consulted when writing his book or article. These publications, in their turn, also list references to publications relevant to their subject. This linking of citations can be used to retrieve literature. It is called the 'snowball method'. The researcher begins by consulting one of the most recent articles on his subject and then proceeds to consult the literature cited in its references. He repeats the process with the literature cited in those works, and so on. The disadvantages of the method are that the researcher is dependent on the thoroughness of the literature study made by the author of his original article, that literature in languages not familiar to that author is not likely to be included, and that only literature older than the first article is found.

26.3.3 Document Delivery

In the ways described above, a drainage engineer will find the titles of many publications. The ones he wants to consult may not be available in a nearby library or even in the country. In that case, he can often borrow them from document delivery organizations.

Organizations that will supply these publications are ILRI, CTA, and the international organizations of the Consultative Group of International Agricultural Research/CGIAR (e.g. ILCA, CIAT, and the International Institute of Tropical Agriculture/IITA).

Documents can also be requested from the British Library Document Supply Centre.

Document Donation Schemes

The suggestions that have been made on how to keep in touch with new developments and how to retrieve relevant literature usually involve money. Many countries, however, are experiencing an economic decline and are suffering from a shortage of foreign exchange. In these circumstances, international donors can be asked for help. When approaching these donors, one should carefully spell out the needs; it must be explained how and by whom the material will be used.

It is difficult for institutions and individuals to know who to approach for assistance. In an article by Carol Priestley (*The Book Famine: a selective directory for book and journal assistance to universities in Africa*), she writes about some of the major document donation schemes in existence. Several of these organizations are listed below.

More information can be found in the article, which is available as a reprint from the International African Institute or in the ILRI Library. The donor organizations are:

- Educational Low-Priced Books Scheme, British Council: Book Coupons Programme; and British Council: Resale Scheme. Contact your local British Council representative;
- Head, Information and Documentation, Swedish Agency for Research Cooperation with Developing Countries;
- Third World Academy of Science, Donation Programme;
- CTA.

26.4 Information Sources on Land Drainage

26.4.1 Tertiary Literature

Tertiary literature gives information on abstract journals, journals, addresses of institutions, dictionaries, etc. It may have titles such as Sources of Information on An example is:

Naber, G.

Drainage : An Annotated Guide to Books and Journals

Wageningen, ILRI, 1984. 37 p.

Gives an overview of sources of information, abstract journals, journals, bibliographies, directories, dictionaries, and books. Several titles are illustrated by their front cover.

26.4.2 Abstract Journals

Abstract journals list titles of publications with an abstract of their contents. Examples are:

- Soils and Fertilizers
Published twelve times a year by CABI. Subscription price U.S. \$680/year.
- Irrigation and Drainage Abstracts
Published five times a year by CABI. Subscription price U.S. \$160/year.
- Bibliography of Irrigation, Drainage and Flood Control
Published once a year by the International Commission on Irrigation and Drainage/ICID, India.

26.4.3 Databases

The book Online Databases in the Medical and Life Sciences, published by Elsevier, lists various interesting databases and their products.

The following databases cover the field of tropical agriculture. Although not entirely concerned with land drainage, they will be of interest to land drainage engineers. They are also available on compact disc:

- **AGRICOLA**, produced by the U.S. Department of Agriculture, National Agricultural Library;

- **AGRIS**, International Information System for the Agricultural Sciences and Technology, produced by AGRIS Coordinating Centre, FAO;
- **CAB Abstracts**, produced by CAB International, available online in DIALOG, DIMDI, and ESA. Contains about 2 million citations, with abstracts, to the worldwide literature in the agricultural sciences and related areas of applied biology;
- **PASCAL Agroline**, produced by the Centre National de la Recherche Scientifique, Centre de Documentation Scientifique et Technique (CNRS/CDST), Institut National de la Recherche Agronomique. Also produces an abstract journal entitled PASCAL Thema 280: Sciences agronomiques, productions végétales;
- **TROPAG (ATA)**, produced by the Royal Institute of the Tropics/KIT. Also produces an abstract journal entitled Abstracts on Tropical Agriculture.

26.4.4 Hosts or Information Suppliers

Hosts are institutions that offer online databases containing titles of publications. Examples are:

- **DIALOG**, Dialog Information Services Inc.;
- **DIMDI**;
- **ESA-IRS**, European Space Agency Information Retrieval Service.

26.4.5 Journals

The Bibliography of Irrigation, Drainage, and Flood Control, published by ICID, lists a number of journals that contain articles on drainage. Details of some of these journals are given below.

Journal of Irrigation and Drainage Engineering

Published six times a year by the American Society of Civil Engineers, Irrigation and Drainage Division.

Editor: Otto J. Helweg. Subscription U.S. \$110.

The journal covers all phases of irrigation and drainage engineering, hydrology, and related water-management subjects such as watershed management, weather modification, water quality, groundwater and surface water. The journal emphasizes new developments and research papers, as well as case studies and practical applications of engineering.

Irrigation and Drainage Systems : An International Journal

Published four times a year by Kluwer Academic Publishers.

Editor: M.G. Bos. Subscription U.S. \$80.

The journal covers the following topics: influence of the water supply on the planning and management of the irrigation system; design criteria of drainage systems; efficiency of irrigation water use; management of irrigation/drainage schemes; adaptation of irrigation/drainage schemes so as to avoid water-related diseases; influence of irrigation and drainage on the ecosystem.

Agricultural Water Management : An International Journal

Published eight times a year by Elsevier Science Publishing BV

Editor: J. van Schilfgaard. Subscription U.S. \$335.

The scope covers irrigation and drainage of cultivated areas; collection and storage of precipitation water in relation to soil properties and vegetation cover; the role of ground- and surface water in nutrient cycling; water-balance problems; exploitation and protection of water resources; control of flooding; water quality and pollution both by, and of, agricultural water; effects of land uses on water resources; water for recreation in rural areas; economic and legal aspects of water use.

ICID Bulletin : Irrigation, Drainage, and Flood Control = Bulletin CIID : irrigation, drainage, et maîtrise des crues

Published twice a year by ICID.

Editor: Dr. W. Nicholaichuk. Subscription U.S. \$30.

The objectives of ICID are to stimulate and promote the development and application of the art, science, and technique of engineering, agriculture, economics, ecology, and social science in managing water and land resources for irrigation, drainage, flood control and river training and/or for research in a more comprehensive manner adopting up-to-date techniques. Articles on these subjects are published in the ICID Bulletin, which includes the addresses of the active ICID National Committees.

Agribook Magazine/Drainage Contractor

Published five times a year by AIS Communication Ltd.

Editor: Peter Darbishire. Subscription U.S. \$12.

The journal covers practical aspects of land drainage. Gives a great deal of attention to installation equipment and techniques. Includes advertisements for equipment and materials.

Transactions of the ASAE

Published six times a year by the American Society of Agricultural Engineers/ASAE.

Editor of Soil and Water Division: Gary D. Bubenzer. Subscription U.S. \$160.

This journal contains six divisions of which the Division of Soil and Water is related to drainage.

Zeitschrift für Kulturtechnik und Landentwicklung = Journal of Rural Engineering and Development

Published six times a year by Paul Parey.

Editor: Dr Bernhard Scheffer. Subscription U.S. \$130.

Nearly all the articles are in German.

Irrigazione e drenaggio : organo del centro internazionale di studi sull'irrigazione

Published by Edagricole S.p.A.

Editor: Prof. Ariosto Degan. Subscription U.S. \$25.

All articles are about irrigation and drainage and are written in Italian. Also includes articles on the non-Italian situation.

A selection of journals covering disciplines related to drainage (e.g. soil science, hydrology, agronomy, agricultural engineering, water resources, erosion, and soil conservation) are listed below:

- Agronomy Journal, published by the American Society of Agronomy.
- Crop Science, published by the Crop Science Society of America.
- Journal of Hydrology, published by Elsevier.
- Agricultural Engineering, published by the American Society of Agricultural Engineers.
- Journal of Soil Science, published by Blackwell.
- Soil Science Society of America Journal.
- Soil Science, published by Williams and Wilkins.
- Soil Use and Management, published by Blackwell.
- Journal of Soil and Water Conservation, published by the Soil and Water Conservation Society.
- Water Resources Bulletin, published by the American Water Resources Association.
- Water Resources Research, published by the American Geophysical Union.

26.4.6 Newsletters

Many international organizations publish newsletters that report their current activities. Examples are:

Land and Water International

Published three times a year free of charge by Netherlands Engineering Consultants/ NEDECO.

The newsletter reports on land and water projects, on-going or complete anywhere in the world.

Land and Water

Newsletter for field staff of the Land and Water Development Division, FAO.

ODU Bulletin

Quarterly newsletter of the Overseas Development Unit of Hydraulics Research/ HR-ODU.

GRID, Magazine of the IPTRID Network is published twice a year.

26.4.7 Books

1992

Ochs, W.J. and B.G. Bishay

Drainage guidelines

World Bank, 1992. 186 p. Technical Paper No. 195

This book provides research results on, and experience with, agricultural drainage. It has

been developed to guide Bank staff, consultants and borrowing-country technicians as they work through the project cycle, seeking to assist planners and designers, as well as those responsible for implementation and follow-up. The guidelines were designed to help improve the quality of drainage measures for both irrigated and rainfed agriculture under a wide range of climatic conditions, with the core objectives of improving the sustainability of agricultural lands and of protecting the environment. The relationship between water management and agricultural production is crucial. Thus, sound drainage investments must be considered when planning and developing projects.

Smart, P. and J.G. Herbertson (Eds.)

Drainage design

Blackie Academic, 1992. 298 p.

A review of the principles and methods of drainage, with emphasis on design. North American, European Community, and United Kingdom practice and the practice in developing countries are included throughout. The book covers drainage applications which may be faced by civil or agricultural engineers.

1990

Schultz, B.

Guidelines on the construction of horizontal subsurface drainage systems

International Commission on Irrigation and Drainage, New Delhi. 1990. 236 p.

These guidelines give general criteria and recommendations for the construction of horizontal subsurface drainage systems. The book starts with an inventory of subsurface drainage systems and then briefly reviews design aspects. It gives attention to drainage materials and to equipment to install the drains. It then recommends construction methods, and describes operation and maintenance. Finally, it treats the cost-benefit analysis of projects. Includes a glossary.

1989

Amer, M.H. and N.A. de Ridder

Land drainage in Egypt

Drainage Research Institute, Cairo. 1989. 377 p.

In 1976, an Egyptian-Dutch Advisory Panel on Land Drainage was established. Its objective was to provide the Egyptian Government with integrated advice in its efforts to control waterlogging and salinity. Five separate projects were formulated. The experience gained from them has led to a better understanding of Egypt's drainage problems and of the remedial measures that can be taken.

The book reflects seven different issues: Drainage survey and design practices; Drainage technology; Operation and maintenance of drainage systems; Vertical drainage feasibility in the Nile Valley; Re-use of drainage water for irrigation; Economic evaluation of drainage projects; Institutional and management aspects of drainage projects.

The book differs from many others in that it provides in-depth guidance to practising engineers in planning and designing drainage systems. It presents new approaches to the drainage of problem areas (unstable soils, heavy soils, artesian conditions), which are found, not only in Egypt, but all over the world.

1076

International Commission on Irrigation and Drainage

Planning the management, operation, and maintenance of irrigation and drainage systems : A guide for the preparation of strategies and manuals

World Bank, Washington. 1989. 150 p. Technical Paper No. 99.

This book was prepared as a reference document for organizations that are responsible for the operation and maintenance of irrigation and drainage systems. Its aim is to assist such organizations in developing strategies and preparing plans for proper and effective operation and maintenance. It provides the basis for the preparation of manuals needed by managers and staff in performing necessary activities at the proper time. The guide provides a comprehensive list of issues that should be addressed in such manuals, and lists published materials and working papers that will assist in the formulation of plans for operation and maintenance.

1988

Hoorn, J.W. van

Agrohydrology – Recent developments : Proceedings of the Symposium Agrohydrology at the International Agricultural Centre/IAC Wageningen, The Netherlands, 29 September – 1 October 1987.

Elsevier, Amsterdam. 1988. 550 p. Agricultural Water Management. Vol. 14.

About half of the papers are about drainage, some of them dealing particularly with the effects of drainage on crops and farm management; others deal with such subjects as preferential flow and the drainage of special soils.

Theme 1: Effects of drainage on crop and farm management (contains 22 papers);

Theme 2: Water conservation; Theme 3: Hydrology of nature reserves; Theme 4: Re-use and disposal of drainage waters from irrigated areas.

1987

Eggelsman, R.

Subsurface drainage instructions. 2nd Edition.

Parey, Hamburg. 1987. 336 p. Bulletin of the National Committee of the Federal Republic of Germany. ICID. No. 6.

English translation of Dränanleitung für Landbau, Ingenieurbau und Landschaftsbau, published in 1981.

Contents: General subjects; Water and soil; Field investigations; Subsurface drainage methods; Subsurface drainage efficiency; Hydraulic calculation; Drainage project-technical planning principles; Drainage materials; Construction of subsurface drainage; Maintenance of drainage.

The subject of saline soils has also been treated in view of the absolute necessity for drainage to complement irrigation in many developing countries.

Framji, K.K., B.C. Garg, and S.P. Kaushish

Design practices for covered drains in an agricultural land drainage system : A worldwide survey

International Commission on Irrigation and Drainage, New Delhi. 1987. 438 p.

The book consists of three parts:

- Part I is a review of the various aspects of engineering design (materials, design criteria, spacing, depth, and dimensions);
- Part II contains the country reports from Canada, China, Czechoslovakia, Egypt, Federal Republic of Germany, France, German Democratic Republic, Hungary, India (Maharashtra), Iraq, Ireland, Japan, Jordan, Netherlands, Pakistan, Poland, Portugal, Romania, and the U.S.A.;
- Part III contains the ASAE Engineering Practice No. 369: Design of agricultural drainage – Pumping plants. This gives principles and practices useful to engineers in the planning and design of pumping plants for the drainage of agricultural land.

Vos, J. (Ed.)

Proceedings, Symposium 25th International Course on Land Drainage : Twenty-five years of drainage experience

ILRI, Wageningen. 1987. 353 p. Publication 42.

This book compiles the results of the Silver Jubilee Symposium, which was held to mark the occasion of the 25th anniversary of the annual International Course on Land Drainage. During the Symposium, five major topics were discussed in separate sessions: Drainage in the humid temperate regions; Drainage in the (semi-)arid regions; Drainage in the humid tropical regions; Drainage machines and materials; Organization of the maintenance of drainage projects.

The topics were introduced by one or two keynote speakers, after which a number of country papers were presented and discussed.

1986

Farr, E. and W.C. Henderson

Land drainage

Longman, London. 1986. 251 p. (Longman Handbooks on Agriculture).

The aim of this book is to provide, in practical and theoretical terms, a broad view of the subject of land drainage. Some basic knowledge of the natural processes that influence land and soil fertility is provided. The authors have attempted to find a balance between sound drainage techniques and design theories. The book describes simply, and with a minimum of calculation, the principles of scientific design and where to apply them. It includes a comprehensive guide to practical land drainage techniques.

Martínez Beltrán, J.

Drenaje agrícola (in Spanish)

Min. de Agricultura, Pesca y Alimentación, Madrid. 1986. Vol. 1. (Series de ingeniería rural y desarrollo agrario. Manual técnico; No. 5).

This book reviews the basic principles governing groundwater flow and soil moisture fluxes. It discusses drainage problems and their possible solutions, using the concept of salt and water balances. It treats drain spacing equations, the determination of soil hydraulic properties, and subsurface drainage criteria. It covers the design, installation, and maintenance of pipe drainage systems. The book concludes with a chapter on salt-affected soils and leaching techniques.

1078

Rao, K.V.G.K., O.P. Singh, and R.K. Gupta

Drainage investigations for salinity control in Haryana

Central Soil Salinity Research Institute, Karnal. 1986. 95 p. Technical Bulletin 10.
Central Soil Salinity Research Institute.

The contents of this Bulletin are based on five years of investigations conducted on three subsurface drainage pilot areas in representative saline areas in Haryana State, India. Experiments were performed to resolve the urgent issues on the depth and spacing of drains, drainage materials, and efficient ways of utilizing poor-quality groundwaters for the leaching of excess soluble salts.

1984

Centre National du Machinisme Agricole, du Génie Rural, des Eaux et des Forêts
(Antony) Division Drainage et Assainissements Agricoles ONIC – Ministère de
l'Agriculture (Paris) Comité de Pilotage National de l'Opération Drainage

L'expérimentation en drainage agricole (in French)

CEMAGREF, Antony. 1984. 95 p. Etudes du CEMAGREF, No. N.511.

The first part of the report sets out the present technological drainage problems and defines the lay-out of experimental fields. It is explained how experiments should be executed in order to find answers to the questions raised by the technicians. The criteria for selecting suitable areas for experiments are treated. An example of an experiment in Bresse de l'Ain is given. The second part gives an outline of a protocol to be adhered to in drainage experiments. The third part describes how data collected from field experiments should be interpreted.

Three documents are appended to the first part: The first is entitled 'Manual for Drainage Experiments'; The second deals with intensive hydraulic experiments; The third gives an example of an agreement for the set-up of an experiment and tells how to use the results of the experiments.

Framji, K.K., B.C. Garg, and S.P. Kaushish

Design practices of open drainage channels in an agricultural land drainage system:
A worldwide survey

ICID, New Delhi. 1984. 343 p.

This volume on open drainage channels consists of two parts:

Part I is devoted to a general review of the design aspects of open drainage channels: system layout, design capacity, channel shape, roughness coefficient, permissible channel velocity, longitudinal channel slope, side slope; Part II contains the country reports of Australia, Bangladesh, Canada, Colombia, Czechoslovakia, Egypt, France, Federal Republic of Germany, German Democratic Republic, Great Britain, Greece, India, Iraq, Ireland, Japan, Malaysia, Morocco, Portugal, Saudi Arabia, Sudan, and the U.S.A.

Castle D.A., J. McCunnall, and I.M. Tring

Field drainage : Principles and practices

Batsford Academic and Educational Ltd., London, United Kingdom. 1984. 250 p.

The book follows the field drainage design process systematically through the stages of the site survey and soil examination; choice of drain layout; depth and spacing;

and determination of pipe sizes. The main theoretical aspects of water movement in soils and pipe hydraulics are covered. The presentation throughout concentrates on demonstrating how theory is put into practice. Sections are devoted to specific techniques such as pumped drainage, and problems such as ochre and salinity. The concluding chapters deal with the use of maps and plans, and with legislation and conservation.

A special feature of the book is its presentation of new ideas on the design of field drainage pipe systems, arising from research by the Ministry of Agriculture Fisheries and Food/MAFF, Field Drainage Experimental Unit.

1983

Food and Agriculture Organisation of the United Nations

Guidelines for the preparation of irrigation and drainage projects. Revised Edition.
FAO, Rome. 1983. 31 p.

Gives guidelines for the main text of a feasibility study, which provides the answers to questions that might be raised in the course of project appraisal.

Smedema, L.K., and D. Rycroft

Land drainage : Planning and design of agricultural drainage systems

Batsford Academic and Educational Ltd., London, United Kingdom. 1983. 376 p.

The text discusses the diagnosis of agricultural drainage problems and their solutions, based on an understanding of the physical principles involved. Land drainage is treated as being a field of applied soil physics and applied hydrology. All major drainage problems are covered, each in its particular environment and field of application:

Groundwater drainage; Watertable control; Surface drainage of sloping and flat lands; Shallow drainage of heavy land; Drainage for salinity control in irrigated land; Drainage and reclamation of polders; Drainage for seepage control; Main drainage: design discharges, canal design, outlets.

The book stresses the universal relationships between the main design variables and soil, climatology, and other relevant environmental conditions.

1982

Baumli, G.R.

Principles of project formulation for irrigation and drainage projects

American Society of Civil Engineers, New York. 1982. 132 p.

This report sets forth the generally accepted and proven principles of project formulation, and provides a guide and checklist for the planning and review of irrigation and drainage projects.

Project formulation involves a series of steps starting with the determination of objectives by the decision-makers, identification and definition of problems and needs, evaluation of available resources, development of alternative means of resolving problems and meeting the needs, evaluation of the alternatives, and selection and implementation of the recommended plan. For all these steps, guidelines are given.

1080

Wehry, A., I. David, and T.E. Man

Probleme actuale in tehnica Drenajului (in Romanian)

Facula, Timisoara. 1982. 237 p.

Actual problems in the drainage technique. This Romanian book contains a summary in English and consists of three parts: Methods and models of calculation in subsurface drainage; Hydraulic and technological problems of filter materials; Design of drainage systems.

1981

Concaret, J.

Drainage agricole : théorie et pratique (in French)

(= Agricultural drainage : Theory and practice)

Chambre Régionale d'Agriculture de Bourgogne, Dijon. 1981. 509 p.

Five sections and four appendices deal with the techniques and applications of drainage, equipment and material, drainage networks and their maintenance. The book also includes pedological and hydrological background information, historical and legal aspects, and methods of soil analysis in relation to drainage problems.

Framji, K.K., B.C. Gary, and S.D.L. Luthra (Eds.)

Irrigation and drainage in the world : A global review. 3rd Edition.

ICID, New Dehli. 1981. 2 Volumes.

An introductory chapter reviews, in global perspective, the object, role, and development of irrigation and drainage, and the demographic trends in less developed and more advanced countries vis-à-vis the related food production, the availability of arable land, and the development and use of water resources by 2000 A.D. Briefly touched upon are economics, financing, and appraisal of irrigation and drainage projects, with some general conclusions at the end. Material on each country is arranged under the following headings: Physiography; Climate and rainfall; Population and size of holdings; Land resources; Water resources; Brief history of irrigation and drainage; Irrigation and drainage methods used; Statistics relating to irrigation and drainage; Important projects; Field water management; Problems relating to irrigation and drainage; Present developments, future plans, and potentials; Administration of irrigation and drainage projects; Economics of irrigation and drainage projects; Financing of irrigation and drainage projects; New technology and its application; Water laws and inter-state agreements; International water agreements and treaties; Research on irrigation and drainage; Other features.

1980

Bowler, D.G.

The drainage of wet soils

Hodder and Stoughton, London. 1980. 259 p.

Contents: Soils in relation to drainage; The water properties of soils; Hydrology of drainage systems; Surveying for drainage systems; The use of aerial photography in farm drainage practice; Surface drainage; Subsurface drainage; Mole drainage; The drainage of peat soils; Pumping to remove drainage water; Ditching and pipe trenching

machinery; Some important management and maintenance practices; The use of subsurface drainage systems for water harvesting.

Parker, T.K.

Drainage system design

Indian Agricultural Research Institute, New Delhi. 1980. 193 p. Design Manual No. 1. Water Technology Centre.

A detailed description in both practical and theoretical terms of a drainage system designed in-house for a research farm. The manual is intended both as a guide to the design and construction of similar systems and as a study model.

The Drainage Contractor. Black Book II

Agri-Book Magazine, Exeter. 1980. 64 p. Drainage Contractor Special Number 2.

A compendium of manufacturers and distributors of back-fillers and drainage machines (e.g. wheel-type, chain-type, trenchless machines). A photograph of each machine is accompanied by a description and specifications.

1979

Beers, W.F.J. van

Some nomographs for the calculation of drain spacings. 3rd Edition.

ILRI, Wageningen. 1979. 48 pp. Bulletin 8.

Also includes nomographs for non-steady state flow and for homogeneous soil with an impermeable layer at great depth. In addition, the author elaborates a specific type of nomograph meant to help determine more accurately the effect of various factors on drainage systems performance.

Drainage principles and applications

ILRI, Wageningen. 1979. Volume 1: 241 p.; Volume 2: 374 p.; Volume 3: 364 p.; Volume 4: 470 p. ILRI Publication 16.

This four-volume book on drainage principles and applications is based on lectures delivered at the International Course on Land Drainage, which is held annually by the International Institute for Land Reclamation and Improvement, Wageningen, The Netherlands. The book presents the basic principles of land drainage with applications.

Although each volume can be used separately, reference is often made to the other volumes to avoid repetition. The four volumes complement one another and provide a coverage of all the various topics useful to those engaged in drainage engineering.

Also available is a Spanish version published in 1977, entitled:

Principios y aplicaciones del drenaje (en cuatro volúmenes).

1978

Drainage manual : A water resources technical publication : A guide to integrating plant, soil, and water relationships for drainage of irrigated lands

United States Bureau of Reclamation/USBR, United States Department of the Interior/USDI, Washington D.C. 1978. 286 p.

Engineering tools and concepts useful in planning, constructing, and maintaining drainage systems for successful long-term irrigation projects.

1082

A ready reference for making accurate estimates of drainage requirements. All methods and techniques covered have proven to be very satisfactory through observed field conditions in irrigated lands throughout the world.

1975

Grassi, C.J.

Manual de drenaje agrícola (= Agricultural drainage manual) (in Spanish).

Centro Interamericano de Desarrollo Integral de Aguas y Tierras/CIDIAT, Mérida. 1975. 197 p.

Contents: Introduction; Drainage and its relation to the soil and the crops; Movement of water through the soil; Sources of excess water; Drainage surveys and investigations; Groundwater surveys; Determining hydraulic conductivity; Permeability studies; Diagnosis of drainage problems; Flow of water towards the drain; Drainage methods; Some construction aspects of drainage systems.

Christiansen, J.E. and C.J. Grassi

Manual de drenaje en tierras de riego (= Drainage manual for irrigated lands) (in Spanish)

Departamento de Desarrollo Regional de la Organización de Estados Americanos/OAS, Mérida. 1975. 150 p. Publicación del Centro Interamericano de Desarrollo Integral de Aguas y Tierras/CIDIAT.

The manual focusses on drainage problems in irrigation projects in Latin America. Soil physical properties and their relation to drainage are discussed. The next chapters discuss the theoretical background to salinity control and the possible sources of excess water in irrigated fields.

1974

Schilfgaard, J. van, (Ed.)

Drainage for agriculture

American Society of Agronomy, Madison. 1974. 700 p. Agronomy No. 17.

Contents: Drainage and crop production; Current drainage practices; Materials and methods; Saturated flow theory and its application; Unsaturated flow theory and its application; Salts and water movement; Quality of drainage water; Models and analogues for the study of groundwater flow; Determining soil properties; Water management systems.

1973

Drainage of agricultural land : A practical handbook for the planning, design, construction, and maintenance of agriculture drainage systems

Water Information Center, Port Washington. 1973. 430 p.

The text of Drainage of Agricultural Land is a faithful reproduction of Section 16, 'Drainage of Agricultural Land' of the National Engineering Handbook, issued in 1971 by the Soil Conservation Service, U.S. Department of Agriculture. The only changes by the publisher are the correction of a few minor typographical errors, the

renumbering of pages, the modification of type faces on selected pages, and the addition of an index.

Contents: Principles of drainage; Drainage investigations; Surface drainage; Subsurface drainage; Open ditches for drainage – design, construction, and maintenance; Dikes; Drainage pumping; Drainage of organic soils; Drainage of tidal lands.

1970

Kinori, B.Z.

Manual of surface drainage engineering

Elsevier, Amsterdam. 1970. 224 p.

The aim of the manual is to bring together for the practical engineer the wide variety of knowledge about main drainage systems. Theoretical explanations are given briefly, the emphasis being placed on practical methods for the design of surface drainage projects.

The first part of the manual discusses: Open channel hydraulics; Scour; Stability of earth channels; The water drop.

The second part discusses: The design and construction of channel linings. The appendix treats the biological protection of waterways and drainage channels in Mediterranean and semi-arid conditions.

26.4.8 Institutions

Some of the main institutions working in land drainage are listed below in the alphabetical order of the country in which they are located. More names and addresses of institutions can be found in the following two directories.

Agricultural research centres : A world directory of organizations and programmes. 8th Edition.

Longman, Harlow. 1986. 2 Volumes. 1138 p.

- Of the centres listed in this directory, about one hundred of them are totally or partly involved in research on land drainage.

Directory of land reclamation and water management organizations in the world.

ICID, New Delhi. 1979. 261 p.

- This directory is an attempt to list all organizations concerned directly or indirectly with irrigation, drainage, and flood-control projects, multipurpose and river-bank development, and overall planning of water resources.

Belgium

National Institute of Agricultural Engineering = Rijksstation voor Landbouwtechniek

Van Gansberghelaan 115, Ghent, B-9220 Merelbeke, Belgium.

Annual Report available.

Canada

Centre for Drainage Studies

McGill University, MacDonald College, Ste. Anne De Bellevue, Quebec, Canada
H9X 1C0.

Egypt

Drainage Research Institute

Delta Barrage, El-Kanater, Egypt.

Finland

Finnish Field Drainage Centre

Simonkatu 12 A, Helsinki SF-00101, Finland.

France

**Centre National du Machinisme Agricole, du Génie Rural des Eaux et des Forêts/
CEMAGREF**

Parc de Tourvoie, B.P. 121, Antony 92160, France.

India

Central Soil Salinity Research Institute, Karnal 132001, India.

International

FAO's Land and Water Development Division

- Publishes Irrigation and Drainage Papers. Up to now, forty six papers have been published.

International Council for Irrigation and Drainage/ICID

- Many countries in the world have a National ICID Committee. Addresses can be found in the ICID Bulletin. ICID also publishes special publications and the Bibliography of Irrigation, Drainage, River Training, and Flood Control.

International Program for Technology Transfer in Irrigation and Drainage/IPTRID
c/o Hydraulics Research, Wallingford, U.K.

Netherlands, The

International Institute for Land Reclamation and Improvement/ILRI

Landinrichtingsdienst (= Government Service for Land and Water Use)/LD

P.O. Box 20021, 3502 LA Utrecht, The Netherlands.

Annual Report available.

Pakistan

International Waterlogging and Salinity Research Institute/IWASRI

13 West Wood Colony, Thoker Niaz Beg, Lahore, Pakistan

United Kingdom

Hydraulics Research, Overseas Development Unit, Wallingford, U.K.

Cranfield Institute of Technology, Silsoe College, Bedford, U.K.

United States of America

American Society of Agricultural Engineers/ASAE

- Almost every year, ASAE organizes a National Drainage Symposium. The

proceedings of these symposia are available through ASAE. ASAE also publishes Agricultural Engineering Papers, many of which are about drainage.

American Society of Civil Engineers/ASCE

Soil Conservation Service

P.O. Box 2890, Washington DC, 20013, U.S.A.

U.S. Bureau of Reclamation/USBR

Denver Federal Center, Denver, Colorado CO 80255, U.S.A.

U.S. Salinity Laboratory

4500 Glenwood Drive, Riverside, California CA 92501, U.S.A.

26.4.9 Drainage Bibliographies

Crook, C.B.

Drainage of agricultural land : An annotated bibliography of selected references 1956-1964

USDA, Washington. 1968. 524 p. (National Agricultural Library, Library list No. 91).

Davis, E.G. and M.L. Gould

Drainage of agricultural land : A bibliography of selected references

USDA, Washington. 1956. 200 p. (Miscellaneous Publication 713).

Gupta, S.K. and I.C. Gupta

Global research on drainage in agriculture : An annotated bibliography 1960-1986

Naurang Rai Concept Publishing Co., New Delhi. 1987. 659 p.

Vries, C.A. de and B.C.P.M. van Baak

Drainage of agricultural land : A bibliography

Wageningen: ILRI, 1966. 28 p. (Bibliography No. 5).

26.4.10 Multilingual Dictionaries

Kennedy, M.N.

A Handbook of irrigation and drainage terms: English-French = Irrigation et drainage: guide pratique des termes, Français-Anglais

Newhouse, Bishop's Waltham. 1981. 44 p.

Kosuth, P.

Vocabulaire de l'hydraulique du drainage agricole

CEMAGREF, Antony. 1985. 39 p. (Technologies de l'agriculture; études du CEMAGREF No. N.524). Terms in German, English, Spanish, French, and Russian.

Papadopoulos, G.E.

Multilingual technical dictionary on irrigation and drainage: Greek-English-

French-German = Dictionnaire technique multilingue des irrigations et du drainage: Grec-Anglais-Français-Allemand = Fachwörter für Bewässerung und Entwässerung: Griechisch-Englisch Französisch-Deutsch
ICID, Athens. 1975. 1060 p.

Deutsches Nationales Komitee der International Commission for Irrigation and Drainage (Bonn)

Multilingual technical dictionary on irrigation and drainage: English-French-German = Dictionnaire technique multilingue des irrigations et du drainage: Anglais-Français-Allemand = Fachwörter für Bewässerung und Entwässerung: Englisch-Französisch-Deutsch
Franckh'sche Verlagshandlung, Stuttgart. 1971. 948 p.

Shybladzay, K.K.

Multilingual technical dictionary of irrigation and drainage: Russian-English-French = Dictionnaire technique multilingue des irrigations et du drainage: Russe-Anglais-Français
ICID, Moskva. 1978. 543 p.

Toyoda, H.

Technical dictionary on irrigation and drainage
Japan International Cooperation Agency, Tokyo. 1977. 450 p.
Irrigation and Drainage Course. Uchihara. International Agricultural Training Centre.

26.4.11 Proceedings of International Drainage Symposia

The proceedings of five international workshops, symposia, or conferences on land drainage have been published so far. Each contains a list of participants and their addresses. The titles are:

Wesseling, J. (Ed.)

Proceedings of the International Drainage Workshop, 16-20 May 1978, Wageningen, The Netherlands
ILRI, Wageningen. 1979. 731 p. (Publication 25).

Proceedings 2nd International Drainage Workshop, Washington D.C., U.S.A., 5-11 December 1982

Corrugated Plastic Tubing Association/CPTA, Carmel. 1982, 240 p.
(CPTA; 7 Hensel Court, Carmel, Indiana IN 46032, U.S.A.).

Saavaliainen, J. and P. Vakkilainen (Eds.)

Proceedings of International Seminar on Land Drainage, 9-11 July 1986, Helsinki, Finland
Helsinki University of Technology, Department of Civil Engineering, Water Engineering. 1986. 503 p.

Proceedings Third International Workshop on Land Drainage, 7-11 December 1987
Ohio State University, Department of Agricultural Engineering, Columbus, Ohio
OH 43201, U.S.A., 1987. 750 p.

Lesaffre, B. (Ed.)

Fourth International Workshop Land Drainage = Quatrième séminaire
international drainage agricole, February 1990, Cairo, Egypt
CEMAGREF, Antony. 1990. 294 p.

Vlotman, W.F. (ed.). Proceedings 5th Technical Drainage Workshop,

Subsurface drainage on problematic irrigated soils : Sustainability and cost
effectiveness. IWASRI, Lahore, Pakistan, 1992. 3 Vol.

Almost every year ASAE organizes a National Drainage Symposium. The proceedings
of these symposia are available through ASAE.

26.4.12 Equipment Suppliers

- **M/s Phax Systems Ltd.**, Ivel Road, Shefford, Bedfordshire, SG17 5JU, U.K.
- **Thomas Scientific**, P.O. Box 99, Sweden Bora, NJ 08085-0099, U.S.A.
- **Eijkelkamp Agrisearch Equipment**, P.O. Box 4, 6987 ZG Giesbeek, The Netherlands.

26.4.13 Teaching and Training Facilities

M.Sc. Course on Soil and Water

Wageningen University of Agriculture.

Agricultural Water Management

Cranfield Institute of Technology, Silsoe College.

A 12-weeks course with course contents as follows: Irrigation, drainage, soil
conservation, water supply, storage methods, technical management. Leading to
a Certificate of Attendance.

Drainage and Land Reclamation Engineering

Cranfield Institute of Technology, Silsoe College.

Course on plant water relationship, soil and plant analysis, hydrology, soil
physics, soil mechanics, field drainage, reclamation, soil management, irrigation
engineering, water supply. Leading to an M.Sc. degree.

Soil and Water Engineering

Cranfield Institute of Technology, Silsoe College.

Course on soil-water relations, soil and plant analysis, hydrology, water
resources, soil physics, water flow in soil, soil mechanics, irrigation engineering,
drainage, soil conservation. Leading to a postgraduate diploma/M.Sc.

Hydraulic Engineering: Land and Water Development

International Institute for Hydraulic and Environmental Engineering/IHE.

A course on soil and water resources development; hydraulic, agronomic, socio-economic, and climatic aspects; land reclamation; irrigation and drainage systems management. Leading to a diploma. Diploma course extendable to M.Sc.

International Course on Land Drainage

International Institute for Land Reclamation and Improvement/ILRI.

A course on subsurface drainage in humid zones, subsurface drainage in irrigated arid zones, surface drainage of flat lands with high rainfall. Leading to a Certificate of Attendance.

List of Addresses

(see also section 26.4.8)

- AIS Communication Ltd., 145 Thames Road West, Exeter, Ontario, NOM 1S3, Canada.
- American Society of Agricultural Engineers/ASAE, 2950 Niles Road, St Joseph, MI 49085-9659, U.S.A.
- American Society of Civil Engineers/ASCE, Irrigation and Drainage Division, Publication Office, 345 East 47th Street, New York, NY 10017-2398, U.S.A.
- British Library Document Supply Centre, Boston Spa, Wetherby, West Yorkshire, LS23 7BQ, United Kingdom. Telex 557381, Fax 44 937 546333.
- Centre Technique de Coopération Agricole et Rurale/CTA, P.O. Box 380, 6700 AJ Wageningen, The Netherlands.
- Centro Internacional de Agricultura Tropical/CIAT, Apartado Aereo 6713, Cali, Colombia.
- Commonwealth Agricultural Bureaux International/CABI, Wallingford, Oxon OX10 8DE, United Kingdom. Telex 847964, Fax 0491 33508.
- Cranfield Institute of Technology, Silsoe College, Silsoe, Bedford MK45 4DT, U.K.
- Dawson, Book Division, Crane Close, Dennington Road, Wellingborough, Northants NN8 2 QG, United Kingdom, Fax: 0933 225993.
- Dialog Information Services Inc., CAP Coordinator, Customer Services Department, P.O. Box 10 010, Palo Alto, California CA 94303-9620, U.S.A.
- DIMDI, Postfach 420580, 5000 Köln 41, Germany. Telex 8881364, Fax 49 221 411429
- Edagricole S.p.A., Casella Postale 2157, 40139 Bologna, Italy.
- Elsevier Science Publishing B.V., P.O. Box 211, 1000 AE Amsterdam, The Netherlands.
- European Space Agency Information Retrieval Service/ESA-IRS, Via Galileo Galilei, 00044 Frascati, Rome, Italy. Telex 610637, Fax 3(39/6)94180361
- Food and Agriculture Organization of the United Nations/FAO, Via delle Terme di Caracalla, 00100 Rome, Italy.
- Hydraulics Research, Overseas Development Unit/HR-ODU, Wallingford, Oxfordshire, OX10 8BA, United Kingdom.
- Institut National de la Recherche Agronomique/INRA, Route de Saint-Cyr, F 78026 Versailles Cedex, France.
- International African Institute, Lionel Robbins Building, 10 Portugal Street, London WC2A 2HD, United Kingdom.
- International Commission on Irrigation and Drainage/ICID, 48 Nyaya Marg, Chanakyapuri, New Delhi-110021, India.
- International Institute for Hydraulic and Environmental Engineering/IHE, Oude Delft 95, 2601 DA Delft, The Netherlands.
- International Institute for Land Reclamation and Improvement/ILRI, P.O. Box 45, 6700 AA Wageningen, The Netherlands.
- International Livestock Centre for Africa/ILCA, P.O. Box 5689, Addis Ababa, Ethiopia.
- Kluwer Academic Publishers, P.O. Box 17, 3300 AA Dordrecht, The Netherlands.
- National Agricultural Library, Beltsville, Maryland MA 20706, U.S.A.

Netherlands Engineering Consultants/NEDECO, Bezuidenhoutseweg 1, 2594 AB The Hague, The Netherlands.

Paul Parey, Lindenstrasse 44-47, D-1000 Berlin 61, Germany.

Royal Institute of the Tropics/KIT, Mauritskade 63, 1092 AD Amsterdam, The Netherlands.

Swedish Agency for Research Cooperation with Developing Countries/SAREC, Birger Jarlsgatan 61, S-105, 25 Stockholm, Sweden.

Third World Academy of Science, Donation Programme, P.O. Box 586, 34126 Trieste, Italy.

Wageningen University of Agriculture, P.O. Box 8130, 6700 EW Wageningen, The Netherlands.

List of Abbreviations

AGRIS	International Information System for the Agricultural Sciences and Technology
ASAE	American Society of Agricultural Engineers
CABI	Commonwealth Agricultural Bureaux International
CEMAGREF	Centre National du Machinisme Agricole, du Génie Rural, des Eaux et des Forêts
CIAT	Centro Internacional de Agricultura Tropical
CTA	Centre technique de Coopération Agricole et Rurale
EEC	European Economic Community
FAO	Food and Agriculture Organization of the United Nations
HR-ODU	Overseas Development Unit of Hydraulics Research
ICID	International Commission on Irrigation and Drainage
IITA	Institute of Tropical Agriculture
ILCA	International Livestock Centre for Africa
ILRI	International Institute for Land Reclamation and Improvement
IPTRID	International Program for Technology Research in Irrigation and Drainage
IWASRI	International Waterlogging and Salinity Research Institute
KIT	Royal Institute of the Tropics
NEDECO	Netherlands Engineering Consultants
ODU	see HR-ODU
USDA	United States Department of Agriculture

List of principal symbols and units

Symbol	Definition	Units
a, A	Cross-sectional area, drained area	m ² , km ²
a	Distance	m
A	Amplitude	m
AMC	Antecedent Moisture Condition	—
b	Bottom width of a canal, drain, or outlet	m
B	Canal width	m
B	Distance, length	m
B/C	Benefit / Cost ratio	—
c	Compression, consolidation constant	—
c	Distance between corrugations	mm
c	Euler's constant ($c = 0.5772$)	—
c, C	Hydraulic resistance	d
c _p	Specific heat of air at constant pressure	J/kg K
C	Chézy coefficient	m ^{0.5} /s
C	Salt concentration	meq/l
C ₁	Vegetal retardance curve index	—
C _u	Coefficient of uniformity	—
CEC	Cation Exchange Capacity	meq/100g
CN	Curve Number	—
d, D	Depth, equivalent depth, thickness, height	m
d	Degrees of freedom	—
d	Diameter	mm, m
D	Duration of unit storm period (unit hydrograph)	h
D	Surface runoff	mm
D(θ)	Soil-water diffusivity	d ⁻¹
e	Efficiency	—
e	Vapour pressure	kPa
e	Void ratio	—
E	Evaporation	mm, mm/d
E	Vapour flux density	kg/m ² s
E	Modulus of elasticity	Pa
E	Elevation	m
EC	Electrical conductivity at 25°C	dS/m
ESP	Exchangeable Sodium Percentage	—
ET	Evapotranspiration	mm, mm/d
f, F	Frequency	—
f	Efficiency	—
f	Clay, mineral, or organic matter content (dry mass fraction)	—

F	Actual retention (Curve Number method)	mm
F	Freeboard	m
F	Force	N
Fr	Froude number	—
g	Acceleration due to gravity	m/s ²
G	Gravity force per unit area	Pa
G	Heat flux density into the soil or water body	W/m ²
G	Capillary rise	mm, mm/d
h, H	Altitude, elevation, height, water depth	m
h, H	(Energy) head or head loss	m
Δh	Change in watertable depth	m, mm
H	Flux density of sensible heat into the air	W/m ²
H	Saturated thickness of a (semi-)confined aquifer	m
H	Tidal range	m
ΔH	(Energy) head loss	m
HW	High Waterlevel	m
I	Infiltration	mm, mm/d
I	Irrigation	mm, mm/d
I _a	Initial abstraction (Curve Number method)	mm
I _l	Leaf area index	—
J	Julian day number	—
k	Corrugation height	m
k	Crop coefficient	—
K	Hydraulic conductivity	m/d
KD, KH	Transmissivity	m ² /d
L	Leakage factor	m
L	Length, spacing, width	m
LF	Leaching fraction	—
m	Mass of soil, water, dry solids	kg
m _{sl} , MSL	Mean Sea Level	m
n	Daily duration of bright sunshine	h
n	Manning's resistance coefficient	—
n, N	Number	—
n	Rotational speed	rev/s
n	Water factor of clay	—
N	Torque in the pump shaft	J
NHW	Number of days with a High Water level	—
NPSH	Net Positive Suction Head	m
O ₉₀	Pore size of envelope retaining 90% of soil fraction	m
p, P	Pressure	Pa
p	Penetration depth of a tubewell into an aquifer	m
P	Precipitation	mm, mm/d
P	Wetted perimeter	m
P	Power consumption	W
PI	Plasticity Index	—
q, Q	Discharge, flow rate, runoff rate, flux	m ³ /d, m ² /d, m/d
q	Drainage coefficient, drainable surplus	mm/d

q/h	Drainage intensity ratio	d ⁻¹
Q	Accumulated runoff depth (Curve Number method)	mm
r	Correlation coefficient	—
r, R	Distance, radius	m
r	Diffusion resistance	s/m
R	Percolation	mm, mm/d
R	Radiation	W/m ²
Re	Reynolds number	—
RH	Relative Humidity	—
RSC	Residual Sodium Carbonate	meq/l
s	Distance	m
s	(Watertable) drawdown	cm, m
s	Hydraulic gradient	—
s	Slope	—
s	Standard deviation	—
S	Salt concentration	t/ha
S	Pitch of the blades of an Archimedean screw	m
S	Potential maximum retention (Curve Number method)	mm
S	Seepage	mm, mm/d
S	Subsidence	m
S	Storativity	—
SAR	Sodium Adsorption Ratio	meq ^{0.5} /l ^{0.5}
SE _x	Sum of Exceedances of the watertable level x	cm
SMC	Soil Moisture Content	—
t, T	Time, period	yr, d, s
t _f	Student's t-value with f degrees of freedom	—
T	Thickness	m
T	Temperature	°C
T	Transpiration	mm, mm/d
u	Wetted perimeter	m
u	Wind speed	m/s
U	Specific surface ratio	—
v	Velocity	m/s
V	Volume	m ³
w, W	Width	m
w	Soil-water content (fraction of total dry mass)	—
w	Flow resistance	d
W	Soil moisture	mm
W	Water storage	mm
x	Distance	m
y	Water depth	m
Y	Yield	t/ha
z	Depth, height	m
z	Elevation head	m
z	Side slope ratio (horizontal/vertical)	—
Z	Amount of salt	mm dS/m
α, θ, φ	Angle	degrees, rad

α	Coefficient, factor, parameter	—
α, β	Compressibility	Pa ⁻¹
Δ	Difference	—
ε	Porosity	—
η	Dynamic viscosity	kg/m s
η	Pump efficiency	—
θ	Soil-water content (volume fraction)	—
μ	Drainable pore space, specific yield	—
ν	Kinematic viscosity	m ² /s
ξ	Energy loss factor	—
ρ	Density	kg/m ³
σ	Standard deviation of a distribution	—
σ	Surface tension of water against air	kg/s ²
τ	Stress	Pa
φ	Latitude	rad
Φ	Velocity potential	m ² /d
ψ	Water potential	m, Pa, J/kg
Ψ	Stream function	m ² /d
ω	Wave frequency	d ⁻¹
∇	Differential operator	—
∇^2	Laplacean operator	—

Glossary

- Acid sulphate soil:** A soil with a pH below 4 as a result of the oxidation of pyrite to sulphuric acid.
- Acidity:** A property of (soil) water characterized by a pH below 7.
- Actual evapotranspiration:** The sum of the quantities of water vapour evaporated from the soil and transpired by plants when the soil-water content is less than optimal. (See **Potential evapotranspiration.**)
- Aerodynamic resistance:** A resistance, similar to Ohm's law, encountered by the diffusion of water vapour from a soil or a crop canopy to the external, turbulent air at a certain height.
- Affinity laws:** A set of equations that allows a prediction of the changes in the performance of rotodynamic pumps (discharge, head, and power) as a result of slight changes in pump speed or impeller size.
- Agricultural drainage:** See **Drainage.**
- Agro-ecological zone:** A land area characterized by its suitability for agriculture according to climatic and soil criteria.
- Albedo:** The fraction of the incident short-wave radiation that is reflected by a particular surface on earth (e.g. water, a green canopy, bare soil).
- Alkali soil:** See **Sodic soil.**
- Alkalinity:** A property of (soil) water, characterized by a pH between 7 and 14.
- Allowable velocity:** Flow velocity of water in an open channel, just below the velocity that would cause bed material to detach.
- Alluvial plain:** A plain bordering a river, formed by the deposition of alluvium eroded from areas of higher elevation.
- Anisotropic:** Having different physical properties when measured in different directions.
- Apparent velocity:** A fictitious velocity of water flowing through a porous medium (e.g. soil), better referred to as the discharge per unit area. Used in Darcy's Equation.
- Application efficiency:** The ratio between the quantity of irrigation water effectively used by the crop, and the quantity of water supplied to a field. (See **Irrigation efficiency.**)
- Aquiclude:** A soil layer that is virtually impermeable to water.
- Aquifer:** A water-bearing soil layer.
- Aquifer test:** A procedure to determine the hydraulic characteristics of an aquifer. Water is pumped, for a certain time and at a certain rate, from a well in the aquifer, and regular measurements are made of the watertable in the well and in its vicinity, either during pumping (see **Pumping test**) and/or after the pumping has stopped (see **Recovery test**).
- Aquitard:** A soil layer with a low, but measurable, permeability.
- Atterberg limits:** See **Consistency limits.**
- Augerhole method:** A technique to determine the saturated hydraulic conductivity of a soil at a certain depth by augering a cylindrical hole in the soil, bailing water from it, and measuring the rate of water-level rise in the hole.
- Available soil water:** The quantity of water available to plants, defined as the quantity of water retained in the soil that is smaller than field capacity and larger than the permanent wilting point.
- Base flow:** Water flow appearing in a river or stream as a result of groundwater discharge, with a characteristic delayed reaction to recharge. Most clearly visible after direct runoff has stopped.
- Basin irrigation:** A system of surface irrigation in which water is ponded on level land parcels surrounded by earthen bunds or banks.
- Bed load:** Granular material (sand, silt, gravel, soil, and rock detritus), transported by a stream on or immediately above its bed by rolling, sliding, or saltation.
- Bedding:** A surface drainage method accomplished by ploughing land to form a series of low narrow ridges, separated by parallel furrows. Water from the furrows discharges into a perpendicular field drain at the lower end of the field.
- Bulk density:** The mass of soil per unit volume in an undisturbed condition. Normally equivalent to the dry bulk density (i.e. when only the dry soil mass is considered), but sometimes to the wet bulk density (i.e. when the mass of water present is also considered).
- Canal seepage:** Water leaving a canal by capillary action and percolation through its wet perimeter, causing a rise in the watertable in the vicinity of the canal.

Canopy resistance: A resistance encountered by water vapour diffusing from the internal cell walls, through the sub-stomatal cavities and the stomata, to the canopy surface.

Capacitance method: A non-destructive, in-situ method that uses the dielectric properties of soil components to determine the soil-water content in the unsaturated zone.

Capillary fringe: The zone above the free watertable where some or all of the capillary interstices are filled with water; this water is continuous with the water in the saturated zone, but is held above that zone by capillarity against gravity.

Capillary rise: The upward movement of water from a free watertable due to adhesion of water to the tubular soil pores (capillaries) and the cohesion of water molecules. A distinction should be made between the rate and the height of capillary rise.

Catchment: See **Drainage basin**.

Cation Exchange Capacity (CEC): The total quantity of cations that a negatively-charged unit soil mass can adsorb, usually expressed as milliequivalents per 100 grams. Measured values depend somewhat on the determination method.

Cavitation: The formation of cavities in flow, due to low or negative pressure as a result of high velocity. These cavities are filled with air and water vapour. In rotodynamic pumps, the implosion of these air bubbles may cause impellers and pump housing to wear.

Centrifugal pump: A rotodynamic pump with radial flow, its inlet being near the centre of the impeller and its outlet along its periphery. The water follows the curved impeller vanes away from the centre.

Collector drain: A drain that collects water from the field drainage system and carries it to the main drain for disposal. It may be either an open ditch or a pipe drain.

Compaction: The change in soil volume produced artificially by momentary load applications such as rolling, tamping, or vibration.

Composite drainage system: A drainage system in which field drains and collector drains are buried.

Compression: The change in soil volume produced by the application of a static external load.

Confidence interval: An interval around the computed value within which a given percentage of values of a repeatedly sampled variate is expected to be found.

Confined aquifer: A completely saturated aquifer whose upper and lower boundaries are aquicludes. In confined aquifers, the pressure of the water is usually higher than atmospheric pressure. Completely confined aquifers are rare.

Consistency limits: Soil physical values indicating the ease with which the soil can be deformed (i.e. a plastic limit and a liquid limit); also called Atterberg limits.

Consolidation: The gradual, slow compression of a cohesive soil due to weight acting on it, which occurs as water and/or air are driven out of the voids in the soil. Consolidation only occurs in clays or other soils of low permeability.

Consumptive use: See **Evapotranspiration**

Continuity: The fundamental law of hydrodynamics, which states that, for incompressible fluids and for flow independent of time, the sum of differential changes in flow velocities in all directions must be zero.

Conveyance efficiency: See **Irrigation efficiency**

Conveyance losses: Water losses due to evaporation, percolation, or breaches in the network of irrigation canals or pipes between the source of water and the field.

Correlation coefficient: A measure of the linear interdependence of two variates, ranging from -1 (perfect negative correlation) to $+1$ (perfect positive correlation).

Critical depth: (1) The depth of flow in a channel of specified dimensions at which the specific energy is a minimum for a given discharge. (2) The depth to which the watertable will fall in the absence of seepage or natural drainage, and at which capillary rise is reduced to almost zero.

Critical flow: The flow condition at which the discharge is maximum for a given specific energy, or at which the specific energy is minimum for a given discharge.

Crop coefficient: The ratio of evapotranspiration from an area covered with a specific crop, at a specific stage of growth, to the reference evapotranspiration at that time.

Crop water requirement: See **Potential evapotranspiration**.

Crowning: The process of forming the surface of land into a series of broad low beds separated by parallel field laterals.

Culvert: A square, oval, or round closed conduit used to transport water horizontally under a highway, railway, canal, or embankment.

Design discharge: A specific value of the flow rate, which, after the frequency and the duration of exceedance have been considered, is selected for designing the dimensions of a structure or a system, or a part thereof.

Diffuse double layer: An imaginary water layer of limited extent around soil-particle surfaces. In this layer, cations are more concentrated than in the surrounding soil solution, because of the negatively-charged particle surface, and anions are repelled.

Direct runoff: That portion of excess rainfall that turns into overland flow.

Discharge hydrograph: A graph or a table showing the flow rate as a function of time at a given location in a stream.

Distribution efficiency: See **Irrigation efficiency**.

Diversion channel: A channel constructed across a slope to intercept surface runoff and conduct it to a safe outlet.

Diversion drain: See **Interceptor drain**.

Drain: A channel, pipe, or duct for conveying surface water or groundwater.

Drain spacing: The horizontal distance between the centre lines of adjacent parallel drains.

Drainage: The removal of excess surface and subsurface water from the land to enhance crop growth, including the removal of soluble salts from the soil.

Drainable pore space: The ratio of the change in soil-water content in the profile above the watertable to the corresponding rise/fall of the watertable, in the absence of evaporation. (See **Specific yield**.)

Drainable surplus: The amount of water that must be removed from an area within a certain period so as to avoid an unacceptable rise in the levels of groundwater or surface water.

Drainage base: The water level at the outlet of a drained area.

Drainage basin: The entire area drained by a natural stream or artificial drain in such a way that all flow originating in the area is discharged through a single outlet.

Drainage coefficient: The discharge of a subsurface drainage system, expressed as a depth of water that must be removed within a certain time.

Drainage criterion: A specified numerical value of one or more drainage parameters that allow a design to be calculated with drainage equations.

Drainage effluent: The water flowing out of a drainage system and that must be disposed of either by gravity flow or by pumping.

Drainage gate: A gravity outlet fitted with a vertically-moving gate or with a horizontally-hinged door or plate (flap gate).

Drainage intensity: (1) An agricultural drainage criterion based on the ratio between the design discharge and the depth of the watertable. (2) The number of drainage provisions (e.g. natural or artificial open drains, pipe drains, or tubewells) per unit area.

Drainage sluice: A gravity outlet fitted with vertically-hinged doors, opening if the inner water level is higher than the outer water level, and vice versa, so that drainage takes place during low tides.

Drainage survey: An inventory of conditions that affect the drainage of an area, made at various levels, ranging from reconnaissance to design level.

Drainage system: (1) A natural system of streams and/or water bodies by which an area is drained. (2) An artificial system of land forming, surface and subsurface drains, related structures, and pumps (if any), by which excess water is removed from an area.

Drainage techniques: The various physical methods that have been devised to improve the drainage of an area.

Dynamic viscosity: In fluid dynamics, the ratio between the shear stress acting along any plane between neighbouring fluid elements, and the rate of deformation of the velocity gradient perpendicular to this plane.

Ecosystem: A dynamic arrangement of plants and animals with their non-living surroundings of soil, air, water, nutrients, and energy.

Effective porosity: See **Drainable pore space**.

Electrical Conductivity (EC): The reciprocal of the electrical resistance measured between opposite faces of a centimetre cube of an aqueous solution at a specified temperature, usually 25°C. It is a measure of the concentration of salts.

Elevation head: The vertical distance to a point above a reference level.

Energy dissipator: A hydraulic structure in which the total hydraulic head of water in a canal is safely reduced by providing a protected approach section, a drop, a stilling basin, and a protected outlet transition.

Entrance head: The head required to overcome the entrance resistance of a pipe drain. (See **Entrance resistance**.)

Entrance resistance: The extra resistance to water flow in the vicinity of a drain pipe, due to a decreased permeability of the material around the drain and/or to a contraction of the flow lines resulting from the small drain openings.

Envelope: Material placed around pipe drains to serve one or a combination of the following functions: (1) to prevent the movement of soil particles into the drain; (2) to lower entrance resistances in the immediate vicinity of the drain openings by providing material that is more permeable than the surrounding soil; (3) to provide suitable bedding for the drain; (4) to stabilize the soil material on which the drain is being laid.

Environmental impact: The effect on the environment of a certain human interference (e.g. artificial drainage).

Ephemeral stream: A stream or portion of a stream that flows only in direct response to precipitation. It receives little or no water from springs and no long-continued supply from melting snow or other sources. Its channel is at all times above the watertable.

Equipotential line: A line in a plane with a constant value of the velocity potential, equalling the product of the hydraulic conductivity and the hydraulic head.

Equivalent depth: Depth to the imaginary impermeable layer, introduced by Hooghoudt to take into account the radial flow resistance near drains in deep homogeneous soils.

Estuary: The mouth of a river, subject to tidal effects, where fresh water and sea water mix.

Evaluation: The assessment of the degree of success of a planned project or process, often undertaken at a specific moment (e.g. upon completion).

Evaporation: (1) The physical process by which a liquid (or solid) is transformed into the gaseous state. (2) The quantity of water per unit area that is lost as water vapour from a water body, a wet crop, or the soil.

Evapotranspiration: The quantity of water used for transpiration by vegetation and lost by evaporation from the soil.

Excess rainfall: That part of the rain of a given storm that falls at intensities exceeding the soil's infiltration capacity and is thus available for direct runoff.

Exchangeable Sodium Percentage (ESP): The fraction of the soil's cation exchange capacity that is occupied by sodium ions. It is a yardstick of sodicity problems in soils.

Feasibility study: A study of the existing and future parameters of a drainage (or other) project, done in such detail that a reasonable estimate of its profitability can be made.

Field capacity: The volumetric water content of a soil after rapid gravity drainage has ceased. It usually occurs about two days after the soil profile has been thoroughly wetted by precipitation or irrigation.

Field drain: (1) In surface drainage, a shallow graded channel, usually with relatively flat side slopes, which collects water within a field. (2) In subsurface drainage, a field ditch, a mole drain, or a pipe drain that collects groundwater within a field.

Field drainage system: A network that gathers the excess water from the land by means of field drains, possibly supplemented by measures to promote the flow of excess water to these drains.

Field lateral: See **Field drain**.

Filter: A layer or combination of layers of pervious materials, designed and installed to provide drainage, yet prevent the movement of soil particles in the flowing water.

Finite-difference method: A method used to solve differential equations by approximating them as algebraic terms over a grid.

Finite-element method: A method used to solve differential equations by approximating them as algebraic terms over a triangular network.

Flow-net diagram: A family of equipotential lines intersected at right angles by a family of streamlines in a cross-section in a porous medium, indicating certain flow patterns, and most often drawn as approximate squares.

Free water surface: See **Watertable**.

Frequency analysis: A statistical method of analyzing hydrological or other data, which uses the observed number of occurrences to predict how often a phenomenon may occur in the future and to assess the reliability of this prediction.

Frequency distribution: (1) A tabular arrangement of empirical data by classes, together with the corresponding class frequencies. (2) A mathematical expression of the relationship between a value and its theoretical frequency.

Froude number: A hydraulic number representing the ratio of inertia forces and gravity forces acting upon water, and making it possible to distinguish between subcritical and supercritical flow velocities.

Gamma-ray attenuation: The reduction in emitted gamma-ray transport in a wet soil, due to absorption by solids and water, allowing soil-water changes to be measured.

Gravel mole: A mole drain filled with gravel material.

Gravel pack: An artificially-graded filter placed immediately around a well screen so as to increase the local permeability, to prevent soil particles from entering the well, and to allow a somewhat larger slot size in the well screen.

Gravimetric method: A method of measuring the water content of the soil, based on determining the weight loss from a number of oven-dried field samples obtained by coring or augering.

Gravitational potential: Energy status of water due to its position in the gravity field. If expressed per unit weight, it is also called gravitational head. (See also **Elevation head**.)

Gravity outlet structure: A drainage structure in an area with variable outer water levels, so that drainage can take place by gravity when outside water levels are low.

Groundwater: Water in land beneath the soil surface, under conditions where the pressure in the water is greater than or equal to atmospheric pressure, and where all the voids are filled with water.

Groundwater quality: A judgement of the chemical suitability of groundwater for normal purposes such as irrigation, drinking water, fish ponds, or industrial use.

Gypsum requirement: The mass of calcium sulphate per unit area that would be required to reduce the exchangeable sodium percentage of the top layer of a sodic soil to an agriculturally acceptable level.

Habitat: The natural home of a plant or animal.

Horizontal drainage: A method of groundwater drainage in which low watertables are maintained by pipe drains or open ditches.

Hydraulic conductivity: The constant of proportionality in Darcy's Law, defined as the volume of water that will move through a porous medium in unit time, under a unit hydraulic gradient, through a unit area, measured at right angles to the direction of flow.

Hydraulic head: The elevation of the water level in a piezometer with respect to a reference level; it equals the sum of the pressure head and the elevation head.

Hydraulic resistance: A property of semi-confined aquifers, also called resistance against vertical flow, which is the ratio of the saturated thickness of the overlying aquitard and its hydraulic conductivity for vertical flow.

Hydraulic soil properties: Properties of the soil profile that affect the flow of water (e.g. hydraulic conductivity, soil-water content, specific water capacity, or diffusivity), often as a function of pressure head.

Hydrograph: A graph showing, for a given point, the stage, discharge, velocity, or other properties of water flow as a function of time.

Hydrological regime: The characteristic behaviour of water in a drainage basin over a period, based on conditions of channels, water and sediment discharge, precipitation, evapotranspiration, subsurface water, pollution, etc.

Hyetograph: A plot of rainfall depth or intensity as a function of time, shown in the form of a histogram.

Hysteresis: The lag phenomenon that soil-water tension at a given water content depends on the past history of wetting and drying cycles.

Ideal drain: A drain without entrance resistance.

Impeller pump: See **Centrifugal pump**

Interception: (1) The capture and subsequent evaporation of part of the rainfall by a crop canopy or other structure, so that it does not reach the ground. (2) The capture and removal of surface runoff, so that it does not reach the protected area. (3) The capture and subsequent removal of upward groundwater seepage, so that it does not reach the rootzone of crops.

Interceptor drain: A drain installed across the flow of groundwater to collect subsurface flow before it re-surfaces, normally used on long slopes and on shallow permeable surface soils overlying relatively impermeable subsoils.

Interflow: Water that has infiltrated into a soil and moves laterally through the upper soil horizons towards ditches or streams as shallow, perched groundwater above the main groundwater level.

Irrigation: The supply, distribution, and controlled applications of water to agricultural land to improve the cultivation of crops.

Irrigation efficiency: Ratio of the volume of components of the water balance of irrigation schemes, expressed as a percentage, and defined as the ratio of output over input, whereby the output (of some quantity) is a conversion of an input (of the same quantity). There are definitions covering the conveyance and distribution and application of water for plant growth.

Irrigation interval: The time between the start of successive water applications on the same field.

Isobath: A line on a map, connecting all points on a land surface that have the same height above the watertable.

Isotropic: Having the same physical properties in all directions.

K-value: See **Hydraulic conductivity**.

Kinematic viscosity: The dynamic viscosity divided by the fluid density.

Lacustrine plain: A plain originally formed as the bed of a lake from which the water has disappeared.

Laminar flow: Flow of water in separate thin layers, not influenced by adjacent layers perpendicular to the direction of flow.

Land drainage: see **Drainage**.

Land forming: Changing the micro-topography of the land to meet the requirements of surface drainage or irrigation. In land forming for surface drainage, two processes are recognized: land grading and land planing.

Land grading: Forming the surface of the land to predetermined grades so that each row or surface slopes to a drain.

Land planing: Smoothing the land surface with a land plane to eliminate minor depressions and irregularities without changing the general topography.

Land reclamation: Making land capable of more intensive use by changing its general character: (1) by drainage of excessively wet land; (2) by reclamation of submerged land from seas, lakes, and rivers, and; (3) by modification of its saline, sodic, or acid character.

Leaching: Removing soluble salts by the passage of water through soil.

Leaching requirement: The fraction of irrigation water entering the soil that must flow effectively through and beyond the rootzone to prevent a build-up of salinity resulting from the addition of solutes in the water.

Leakage factor: A geohydrological factor that determines the distribution of the leakage into a semi-confined aquifer through the overlying aquitard.

Log-normal distribution: A transformed normal distribution in which the variate is replaced by its logarithm. It is used empirically for hydrological frequency analysis.

Longitudinal profile: An annotated design drawing of a canal along its centre line, showing original ground levels, canal bank levels, design water levels, bed levels, and other relevant engineering information.

Lysimeter: A soil-filled container, in which a crop may or may not be grown, to determine one or more terms of the soil-water balance.

Main drain: The principal drain of an area, receiving water from collector drains, diversion drains, or interceptor drains, and conveying this water to an outlet for disposal outside the area.

Main drainage system: A water conveyance system that receives water from the field drainage systems, surface runoff, interflow, and groundwater flow, and transports it to the outlet point.

Mathematical model: A model that simulates a system's behaviour by a set of equations, perhaps together with logical statements, by expressing relationships between variables and parameters.

Matric head: The matric potential expressed as work per unit weight, or in metres water column. It is negative above a watertable.

Matric potential: The work that has to be done per unit quantity of pure water to overcome the attractive forces of water molecules and the attraction of water molecules to solid surfaces.

Mechanical analysis: Determining the particle-size distribution of a soil by screening, sieving, or other means of mechanical separation.

Mean Sea Level (MSL): The average water level in a tidal area.

Miscible displacement: Salt displacement in soils caused by a combination of molecular diffusion and dispersion (i.e. the mixing of solutions by uneven flow velocities).

Modelling: The simulation of some physical or abstract phenomenon or system with another system believed to obey the same physical laws or abstract rules of logic, in order to predict the behaviour of the former by experimenting with the latter.

Mole drain: An unlined underground drainage channel, formed by pulling a solid object, usually a solid cylinder with a wedge-shaped point at one end, through the soil at the proper slope and depth, without a trench having to be dug.

Net Positive Suction Head (NPSH): A head related to centrifugal pumps, expressed as 'available' at a certain site or as 'required' by the manufacturer. The available NPSH is calculated from the atmospheric pressure, the vapour pressure, and the dynamic suction head. If NPSH available drops below NPSH required, cavitation is likely to occur.

Neutron scattering: The phenomenon that fast neutrons, emitted from a radio-active source, are scattered and slowed down, mainly by hydrogen ions. As hydrogen ions are mainly present in water, neutron scattering can be used to measure soil-water content.

Normal distribution: A symmetrical, bell-shaped, infinite, continuous distribution, theoretically representing the distribution of accidental errors about their mean.

Observation well: A small-diameter pipe, at least 25 mm in diameter, in which the depth of the watertable can be observed. It is placed in the soil and perforated over a length equal to the distance over which the watertable is expected to fluctuate.

Open drain: A drain with an exposed water surface that conveys drainage water.

Open water evaporation: The theoretical quantity of water that leaves an infinite shallow water surface as vapour under the prevailing meteorological conditions. The rate of open water evaporation is often estimated with Penman's Equation.

Organic soils: Soils with a high content of composed or decomposed organic carbon and a low mineral content.

Osmotic potential: The work that has to be done per unit quantity of pure water to overcome the effect of ions in the soil solution. If expressed per unit weight, it is also called osmotic head.

Outlet: The terminal point of the entire drainage system, from where it discharges into a major element of the natural open water system of the region (e.g. river, lake, or sea).

Outlet drain: A drain that conveys collected water away from the drained area or project, either in the form of a natural channel or as a constructed drain.

Overland flow: Water flowing over the soil surface towards rills, rivulets, channels, and rivers. It is the main source of direct runoff.

Oxidation: The process in the soil by which organic carbon is converted to carbon dioxide and lost to the atmosphere.

Pan evaporation: The quantity of water lost from a standard meteorological measuring pan as water vapour.

Parent material: Weathered rock material from which soil is formed.

Peak runoff: The maximum rate of runoff at a given point or from a given area, measured during a specified period, in reaction to rainfall.

Percolation: The gravity-induced downward flow of water through soil, especially in saturated or nearly saturated soil at hydraulic gradients of one or less.

Permeability: (1) Qualitatively, the quality or state of a porous medium relating to the readiness with which such a medium conducts or transmits fluids. (2) Quantitatively, the specific property governing the rate or readiness with which a porous medium transmits fluids under standard conditions. See also **Hydraulic conductivity**.

pF: The numerical measure of the energy with which water is held in the soil, expressed as the common logarithm of the absolute value of the matric head in centimetres of water.

pH: A measure of the hydrogen ion concentration in a solution, expressed as the common logarithm of the reciprocal of the hydrogen ion concentration in mol per litre.

Phreatic level: See **Watertable**.

Phreatic surface: See **Watertable**.

Piezometer: A small-diameter pipe used to observe the hydraulic head of groundwater. It is placed in, or driven into, the subsoil so that there is no leakage around the pipe. Water can only enter the pipe through a short screen at the bottom of the pipe, or through the bottom only.

Piezometric head: See **Hydraulic head**.

Piezometric surface: The imaginary surface through all the points to which the water rises in piezometers penetrating an aquifer.

Pipe drain: A buried pipe – regardless of material, size, or shape – that conveys drainage water from a piece of land to a collector drain or to a main drain.

Polder: A tract of low land, reclaimed from the sea or another body of water, by endiking it. In a polder, runoff is controlled by sluicing or pumping, and the watertable is independent of the watertable in the adjacent areas.

Pores: See **Voids**.

Porosity: The volume of voids as a fraction of the volume of the soil.

Post-authorization study: A detailed design study that is undertaken after a project has been approved.

Potential head: See **Hydraulic head**.

Potential evapotranspiration: The theoretical quantity of water that, under the prevailing meteorological conditions, and when soil water is not a limiting factor, is lost as water vapour from an extensive cropped surface.

Precipitation: The total amount of water received from the sky (rain, drizzle, snow, hail, fog, condensation, hoar frost, and rime).

Preferential flow: Water flow in the soil through passages such as cracks, macropores, and other cavities, at a much faster rate than water flow within structural elements.

Pressure head: The hydrostatic pressure of water in the soil at a certain point, expressed as the height of a water column that can be supported by the pressure. The pressure head is negative in the unsaturated zone and the capillary fringe.

Probability: The chance that a prescribed event will occur, represented as a pure number (p) in the range $0 \leq p \leq 1$. It can be estimated empirically from the relative frequency (i.e. the number of times the particular event occurs, divided by the total count of all events in the class considered).

Protective lining: A covering for the natural bed of an open canal, made of material that is less prone to detachment by the flowing water, to enable higher flow velocities.

Pump characteristic curve: A graphic description of the performance of a pump, often showing curves for head, efficiency, power, and (for centrifugal pumps) required NPSH versus the discharge on the horizontal axis.

Pump efficiency: The hydraulic efficiency of a pump, expressed as the ratio of energy converted into useful work to the energy applied to the pump shaft, or as the ratio of the water power to the brake power.

Pumping test: A field test to find the hydraulic characteristics of an aquifer, based on the analysis of the drawdown of the watertable in the vicinity of a pumped well during pumping (See **Aquifer test**).

Radial flow: Groundwater flow towards the wet perimeter of a drain, whereby the flow lines resemble converging radii.

Radial resistance: A resistance against water flow caused by radially converging flow lines.

Reaction factor: A factor that expresses the speed at which the drainage system of an area is able to lower the watertable after a recharge by rainfall or irrigation.

Recession curve: Generally, the falling limb of a hydrograph, representing the decreasing runoff from the surface water, subsurface water, and groundwater.

Reconnaissance study: An initial, exploratory study into the conditions affecting an existing problem. Its results should allow the extent of the problem to be weighed and possible solutions in general terms to be found.

Recovery test: A test to find the hydraulic characteristics of an aquifer, based on the reduction in drawdown of the watertable in a pumped well after pumping has stopped (See **Aquifer test**).

Reference evapotranspiration: The theoretical quantity of water lost by evapotranspiration from a specified crop or surface, reflecting the prevailing climatic conditions on site. Multiplied by a crop coefficient, it gives the potential evapotranspiration.

Regression analysis: A statistical technique applied to paired data to determine the degree or intensity of mutual association of a dependent variable with one or more independent variables.

Relaxation method: A computational method to obtain steadily improved approximations of the solution of a system of simultaneous difference equations that approximate the solution of a given differential equation.

Relief drain: A drain used to lower the groundwater over relatively large, flat areas where the drainage source is percolation from precipitation or irrigation, and where gradients of both the watertable and subsurface strata do not permit the sufficient lateral movement of the groundwater.

Resistance blocks: Small blocks of material in which two electrodes are embedded that measure the electrical resistance between them in dependence of the water content in the blocks. As this water is in equilibrium with surrounding soil water, resistance blocks allow soil-water tension in a certain range to be measured.

Return flow: Water that reaches a source of groundwater or surface water after being released from the point of use, and thus becomes available for further use.

Return period: The time in which a hydrological event is estimated to re-occur according to a selected statistical criterion. It is the reciprocal of an estimated frequency.

Re-use: The use of the same water several times (e.g. using irrigation return flow or drainage water for irrigation).

Reynolds number: A hydraulic number that represents the ratio of inertia forces to viscous forces, allowing laminar flow and turbulent flow to be distinguished.

Rip-rap: Broken stones or boulders placed compactly or irregularly on dams, levees, dikes, or similar embankments, and at the downstream end of structures, to protect earth surfaces from the action of waves, current, and flowing water.

River gauging: Measuring the velocity of river water, and the area of cross-section of the water, to determine the discharge.

Roughness coefficient: A dimensionless parameter appearing in Manning's Equation for uniform steady flow in open canals, related to surface irregularity, vegetal drag, and material retardance of the wetted perimeter.

Saline soil: A non-sodic soil containing soluble salts in such quantities that they interfere with the growth of most plants.

Saline-sodic soil: A soil that contains sufficient exchangeable sodium and soluble salts to interfere with the growth of most plants.

Salinity: The content of totally dissolved solids in irrigation water or the soil solution, expressed either as a concentration or as a corresponding electrical conductivity.

Salinization: The accumulation of soluble salts at the surface, or at some point below the surface, of the soil profile.

Salt balance: Equating all inputs and outputs of soluble salts, for a volume of soil or for a hydrological area, to the change in salt storage over a given period of time.

Salt equilibrium: A situation in an agricultural soil where there is no long-term change in the salt content of the rootzone.

Salt storage: The accumulation of salts in the rootzone of an agricultural soil.

Salt tolerance: The degree to which crop development and production are not susceptible to high total salt and specific ion concentrations in the soil solution.

Saturated soil paste: A particular mixture of soil and water that glistens as it reflects light, flows slightly when the container is tipped, and slides freely and cleanly from a spatula for all soils except those with a high clay content.

Saturation extract: The solution extracted from a saturated soil paste.

Saturation percentage: The water content of a soil sample that has been brought to saturation by the addition of water during stirring, expressed as grams of water per 100 grams of dry soil.

Scaling: A frequently used technique to account for spatial variability.

Scarifying: The breaking up of the soil profile within 0.10 m of the surface.

Seepage: (1) The slow movement of water through small cracks, pores, or interstices of a material, in or out of a body of surface or subsurface water. (2) The loss of water by infiltration from a canal reservoir or other body of water, or from a field.

Semi-confined aquifer: A completely saturated aquifer that is bounded above by an aquitard and below by an aquiclude or an aquitard.

Semi-diurnal tide: A tide with two high and two low waters in a day.

Shrinkage: The change in volume of a soil, produced by capillary stresses when the soil is drying.

Simulation: The representation of a physical system by a device such as a computer or a model that imitates the behaviour of the system; a simplified version of a situation in the real world.

Single-well test: A test to find the hydraulic characteristics of an aquifer, based on measured drawdowns of the water level in a pumped well (i.e. without using observation wells or piezometers).

Singular drainage system: A drainage system in which the field drains are buried and all field drains discharge into open collector drains.

Sodicity: A soil feature indicating a problem of high sodium content. See **Sodic soil**.

Sodic soil: A soil that contains sufficient exchangeable sodium to interfere with soil structure and the growth of most crops, without appreciable quantities of other soluble salts being present.

Sodium Adsorption Ratio (SAR): A ratio for soil extracts and irrigation water that expresses the relative activity of sodium ions in exchange reactions with soil. An adjusted SAR is used to classify irrigation water according to its potential to cause infiltration problems because of its high relative sodium content.

Soil classification: The organization of types of soil in a systematic and meaningful way, based on practical characteristics and criteria.

Soil fertility: The capacity of a soil to supply the nutrients needed for the growth of crops.

Soil horizon: A layer of soil or soil material approximately parallel to the land surface, and differing from adjacent genetically-related layers in physical, chemical, and biological properties or characteristics (e.g. colour, structure, texture, consistency, or degree of acidity or alkalinity).

Soil profile: The vertical sequence of soil layers, from the soil surface downwards, caused by soil formation.

Soil ripening: The process that transforms a soft, water-saturated, and reduced sediment into a soil that can be used for agriculture. A distinction is made between biological, chemical, and physical ripening.

Soil salinity: The presence of salts in the soil profile that impair crop production.

Soil salinization: See **Salinization**.

Soil structure: The combination or aggregation of primary soil particles into aggregates or clusters (peds) that are separated from adjoining peds by surfaces of weakness.

Soil survey: The systematic examination of soils in the field, including the laboratory analysis of specific samples, their description, and mapping.

Soil texture: The relative proportions of the various-sized groups of individual soil grains in a mass of soil. Specifically, it refers to the proportions of clay, silt, and sand smaller than 2 mm in diameter (fine earth fraction).

Soil-water content: The volume of water in a soil as a fraction of the total soil volume. Normally determined by the drying of a soil sample to a constant weight at a standard temperature. Sometimes expressed as a mass fraction.

Soil-water diffusivity: The ratio of the unsaturated conductivity to the specific water capacity of the soil at a certain water content.

Soil-water potential: The energy required to move a unit quantity of water from the reference state to the point of consideration. In soil-water systems, the energy state of the water at the watertable is usually taken as the reference state. Potentials may be expressed as energy per unit mass (J/kg), energy per unit volume (Pa), or energy per unit weight (m water column).

Soil-water retention: The soil property that part of the soil water is retained by surface tension and molecular forces against the influence of gravity.

Soil-water retention curve: The graphic representation of soil-water content as a function of its pressure head, also called a pF curve.

Soil-water tension: The force per unit area that must be exerted to remove water from the soil; sometimes loosely expressed in metres or centimetres water column.

Spatial variability: The phenomenon that a property does not have a constant value within a certain area, but that individual values depart from a central tendency.

Specific speed: A characteristic parameter for a pump as a function of the shaft speed, the discharge, and the head, which facilitates the choice between different rotodynamic pumps (axial flow, mixed flow, radial flow).

Specific volume: The volume of a unit mass of dry soil in an undisturbed condition, equalling the reciprocal of the dry bulk density of the soil.

Specific water capacity: The slope of the curve relating soil-water content to its pressure head.

Specific yield: The volume of water stored or released per unit surface area of an unconfined aquifer, per unit change in head. It virtually equals the effective porosity, or the drainable pore space, because the compressibility can be ignored. See **Drainable pore space**.

Standard deviation: A statistical measure of dispersion of a frequency distribution, equal to the positive square root of the mean squared deviation of a number of individual measurements of a variate from their population mean.

Steady state: (1) A condition in which the input energy equals the output energy. (2) A fluid motion in which the velocities at every point of the field are independent of time in either magnitude or direction.

Storage coefficient: See **Storativity**.

Storativity: The volume of water released or stored per unit surface area of a confined aquifer, per unit change in the component of head normal to that surface. It depends on the compressibilities of the aquifer material and the fluid.

Streamline: A line whose tangent at any point in a fluid is parallel to the instantaneous velocity of the fluid at that point, in steady-state flow coinciding with the trajectories of the fluid particles.

Sub-critical flow: Water flow at a mean velocity less than critical; the Froude number is smaller than 1. See also **Critical flow**.

Sub-irrigation: Irrigation of plants with water delivered to the roots from below.

Subsidence: Downward movement of the ground surface for any reason (e.g. mining, pumping of groundwater), as a combined effect of compaction and compression, consolidation, oxidation, and shrinkage.

Subsurface drainage: The removal of excess water and salts from soils via groundwater flow to the drains, so that the watertable and rootzone salinity are controlled.

Subsurface drainage system: A man-made system that induces excess water and salts to flow via the soil to wells, mole drains, pipe drains, and/or open drains, from where it can be evacuated.

Supercritical flow: Water flow at a mean velocity above critical; the Froude number is larger than 1. See also **Critical flow**.

Supplementary irrigation: Irrigation used to supplement direct rainfall that in itself would be inadequate to meet the crop water requirements.

Surface drainage: The diversion or orderly removal of excess water from the surface of the land by means of improved natural or constructed channels, supplemented when necessary by the shaping and grading of land surfaces to such channels.

Surface drainage system: A system of drainage measures, such as channels and land forming, meant to divert excess surface water away from an agricultural area in order to prevent waterlogging.

Surface irrigation: Irrigation whereby the water flows over the soil surface, thereby partially wetting the soil through infiltration, as in basin, border, and furrow irrigation.

Surface runoff: Water that reaches a stream, be it large or very small, by travelling over the surface of the soil.

Suspended load: The relatively fine part of the sediment load that is distributed throughout the flow cross-section and stays in suspension for appreciable lengths of time.

Swelling: Opposite of **Shrinkage**.

Tail recession: The part of the downward leg of a hydrograph below the inflection point (i.e. where the hydrograph section can be reasonably approximated by a decay curve).

Tensiometer: A porous cup, filled with water, that is buried in the soil at the point of interest to measure soil-water tension.

Terrace: A flat, or nearly flat, area of land bounded on at least one side by a definite steep slope rising upward from it, and on the other sides by downward slopes.

Textural class: The name of a soil group with a particular range of sand, silt and clay percentages, of which the sum is 100% (e.g. sandy clay is: 45-65% sand, 0-20% silt, 35-55% clay).

Textural triangle: A triangle indicating the boundary limits of the sand, silt, and clay percentages for each textural class.

Texture: See **Soil texture**.

Tidal drainage: The removal of excess water from an area, by gravity, to outer water that has periodic low water levels owing to tides.

Tidal river: A river whose water level is influenced by tidal water-level fluctuations over a considerable distance.

Tide: The periodic fluctuation of the seawater level that results from the gravitational attraction of the moon and the sun acting upon the rotating earth.

Tile drain: See **Pipe drain**

Total energy head: The energy of water per unit weight, equalling the sum of the velocity head, the elevation head, and the pressure head.

Tractive stress: The force per unit of wet canal area that acts on the bed material, trying to dislodge it, against cohesion, internal repose, and gravity.

Transient flow: See **Unsteady flow**.

Transition: The section of a canal or a structure that ensures an undisturbed connection between different cross-sectional profiles.

Transmissivity: The rate at which water is transmitted through a unit width of aquifer under a unit hydraulic gradient. It equals the product of the average hydraulic conductivity and the thickness of the aquifer.

Transpiration: The quantity of water evaporating via the cuticula and the stomata of a dry crop canopy to the outside atmosphere.

Trencher: A drainage machine that digs a trench in which a drain pipe and envelope are laid.

Tubewell: A circular well that can be used to dispose of subsurface water, to control groundwater levels, or to relieve hydraulic pressures, where local physical conditions are appropriate for their use.

Tubewell drainage: The control of an existing or potential high watertable, or of artesian groundwater, through a group of adequately-spaced wells.

Tubewell drainage system: A network of tubewells to lower the watertable, including provisions for running the pumps, and drains to dispose of the excess water.

Turbulent flow: Flow of water, agitated by cross-currents and eddies, as opposed to laminar flow. Any particle may move in any direction with respect to any other particle, and the head loss is approximately proportional to the second power of the velocity.

Two-way regression: A regression analysis of two data sets in which neither variable is considered to be the independent variable (See **Regression analysis**).

Unconfined aquifer: A permeable bed only partly filled with water, overlying a relatively impermeable layer. The upper boundary of an unconfined aquifer is formed by a free watertable under atmospheric pressure.

Uniform flow: Flow of water with no change in depth or any other element of flow (e.g. cross-sectional area, velocity, and hydraulic gradient) from section to section along a canal.

Unit hydrograph: The direct runoff hydrograph resulting from 1 mm of excess rainfall, generated uniformly over a drainage area at a constant rate, during a specified period of time or duration.

Unsaturated flow: Water flow in the unsaturated zone of the soil.

Unsaturated zone: The soil layer above the free watertable, where soil pores contain both air and water.

Unsteady flow: Flow in which the velocity changes, with time, in magnitude or direction.

Vadose zone: The soil between the surface and the watertable. It includes the unsaturated zone and the capillary fringe.

Vapour pressure: The partial pressure of water vapour in the atmosphere.

Vegetated waterway: An earthen channel to dispose of excess water safely, and therefore lined with vegetation to stabilize the channel and prevent erosion.

Velocity head: The energy of water per unit weight due to its flow velocity.

Vertical drainage: See **Tubewell drainage**.

Voids: Small cavities in the soil, occupied by air or water or both.

Void ratio: Ratio of the volume of pores to the volume of solids in a soil.

Water balance: The equation of all inputs and outputs of water, for a volume of soil or for a hydrological area, with the change in storage, over a given period of time.

Water factor: The mass of water adsorbed by a unit mass of soil, used as a measure of the degree of physical soil ripening.

Water-holding capacity: See **Field capacity**.

Waterlogging: The accumulation of excess water on the soil surface or in the rootzone of the soil.

Water management: The planning, monitoring, and administration of water resources for various purposes.

Water potential: See **Soil-water potential**.

Water quality: A judgement of the chemical, physical, and biological characteristics of water and of its suitability for a particular purpose.

Watershed: See **Drainage basin**.

Watertable: The locus of points at which the pressure in the groundwater is equal to atmospheric pressure. The watertable is the upper boundary of groundwater.

Weighting: A statistical method of adjusting the results of observations by taking into account the fact that not all the data may be of equal reliability or importance.

Well field: See **Tubewell drainage system**.

Well screen: A perforated casing that provides mechanical stabilization to the inflow area of a well, preventing it from collapsing and reducing the inflow of soil particles into the pump.

Wetlands: Lands whose saturation with water is the dominant factor determining the nature of soil development and the types of plant and animal communities that live in the soil and on its surface.

Wilting point: The soil-water content at which plants wilt and fail to recover turgidity; also called the permanent wilting point.

Index

- Acid sulphate soils, 108
 - Acidification, 1048
 - Adjustment factor, 156
 - Admiralty method, 1011
 - Adsorption, 399
 - Aeration, *see* Soil aeration
 - Aeration zone, 604
 - Aerodynamic
 - diffusion resistance, 154
 - evaporation equivalent, 169
 - resistance, 159
 - term, 155
 - Affinity laws, 976
 - Agricultural soil qualities, 79
 - Agro-ecological zone map, 695
 - semi-arid regions, 673
 - sub-humid zones, 680
 - temperate humid zone, 670
 - tropical humid zones, 682
 - Air entrapment, 900
 - Albedo, 156
 - Alkali soils, 109
 - Alkalinity, 99
 - Allowable velocity, 768
 - correction factors, 772
 - Alluvial
 - fan, 34
 - lowlands, 1045
 - plain, 34, 305
 - soils, 436, 443
 - fine-textured, 108
 - Ancient civilizations, 24
 - Anisotropy, 84, 436
 - Antecedent
 - moisture condition, 125, 128
 - precipitation index, 129
 - Apparent velocity, 233
 - Aquiclude, 43
 - Aquifer, 43
 - boundaries, 374
 - confined, 43
 - elastic storage, 371
 - hydraulic characteristics, 341
 - leaky, 445
 - semi-confined, 44, 305, 311
 - drawdown, 355, 368
 - specific storage, 47, 328
 - thickness, 934
 - system water balance, 611
 - test, 341, 610
 - analysis, 348
 - assumptions, 350
 - duration, 347
 - execution, 345
 - late-time drawdown deviations, 374
 - preparation, 341
 - semi-confined calculation, 358, 369
 - single well tests, 375
 - site geology, 375
 - site selection, 341
 - steady-state drawdown, 357
 - synthetic recovery data, 361
 - time measurement, 346
 - unconfined calculation, 366
 - unconfined, 43, 316, 361, 609
 - deep, 443
 - drawdown, 350
 - medium-deep, 442
 - shallow, 441
- Aquitard, 44, 934
 - leakage, 356
- Archimedean screw
 - description, 966
 - dimensioning, 969
 - discharge characteristics, 967
- Artesian conditions, 43
- Atmometer, 151
- Atterberg limits, 90, 740
- Auger hole method, 455, 457
 - equipment, 460
 - inversed, 461
 - principle, 457
 - procedure, 460
 - theory, 458
- Axial-flow pump, 966, 971
-
- Bank-full flow, 736
- Base flow, 68, 117
- Base saturation, 98
- Basic allowable velocity, 769
- Basin length, 785
- Bed-and-furrow system, 802
- Bedding system, 800
 - bed width, 802
 - construction, 801
- Bell-mouth diameter, 987
- Benefit-cost ratio, 657, 1062
- Bernoulli equation, 230
- Bessel function, modified, 357
- Best-fitting land slope, 809
- Black alkali soils, 99
- Black cotton soils, 108

- Blaney-Criddle formula, 152
- Blind junctions, 841
- Borehole maintenance, 960
- Boundary conditions, 410, 621
 - groundwater flow, 249
- Bowen ratio, 153
- Braided river, 36
- Broad-crested weir, 781, 1022
- Bulk density, 92, 384
 - dry, 387
 - wet, 386, 481, 487
- Bypass, 418, 572, 574, 591, 593
- Cambered beds, 802
- Canal
 - allowable velocity, 773
 - bottom
 - hydraulic resistance, 339
 - infiltration rate, 338
 - reduced seepage, 338
 - cross section, 721, 750
 - curvature, 749
 - depth/width ratio, 745
 - freeboard, 735
 - geometry factor, 756
 - maintenance, 762
 - normal discharge, 735
 - partially penetrating, 324
 - permissible velocity, 764
 - preliminary design, 731
 - profiles, 750
 - seepage, 514, 1059
 - analog solutions, 334
 - calculation, 322, 335
 - linear level change, 324
 - models, 332
 - steady-state, 334
 - sudden level change, 317
 - side slope, 742
 - stability, 764
 - structures, 721
 - system
 - discharge capacity, 739
 - lay-out, 727
 - mapping, 732
 - storage capacity, 739
- Canalized drainage stream, 727
- Canopy diffusion resistance, 158, 159
- Capacitance method, 387
- Capillary
 - flux, 559
 - fringe, 226, 605
 - rise, 96, 256, 390, 403, 520, 558, 606, 615, 653, 1055
 - height, 391, 409, 566
 - rate, 566
 - salinization, 533
- Cation adsorption, 536
- Cation exchange capacity, 88, 97, 536
- Cauchy condition, 410, 423
- Cauchy-Riemann equations, 248
- Cavitation, 978
- Censored data series, 188
- Centrifugal pump, 970
- Channel: compound section, 763
- Checked drainage, 636, 637
- Chemical amendments, 598
- Classification
 - drainage systems, 637
 - sodic waters, 584
 - soil, 104, 540
 - FAO-Unesco, 105, 541
 - unified system, 740
 - US Salinity Laboratory, 540
 - USDA/SCS, 105
 - USSR, 541
- Clastic sediment, 40
- Clay
 - content, 493
 - mineralogy, 89
 - physico-chemical characteristics, 88
 - tiles, 830
- Climatic data, 695, 716
- CLIMWAT, 170
- Coastal plain, 39, 445
- Coefficient of determination, 211
- Collector
 - criteria, 671
 - design procedure, 887
 - drain, 29, 638, 884
 - drainage, 652
 - installation, 860
 - multiple-diameter, 887, 888
 - open, 848
 - pipes, 848
 - outlet, 840
- Combination method, 146
- Compressibility
 - aquifer, 328
 - water, 329
- Compression
 - constant, 484
 - index, 483
 - peat, 506
- Computer
 - data bank, 961
 - model FRYMO, 500
 - models, 27
 - program CAPSEV, 403, 409
 - program SATEM, 358, 361, 373
 - programs for ET, 170
- Computer-aided design, 721
- Concentration factor, 548, 575
- Concrete pipes, 830

- Confidence
 - analysis, 185
 - belt, 186, 216
 - interval, 176, 185, 215
 - statement, 211
- Conservation of mass, 228
- Consolidation, 477, 480, 486
 - theory, 483
 - total pressure, 487
- Consolidometer, 486
- Constant-head method, 454
- Contact erosion, 897
- Continuity equation, 229, 406
- Contour lines, 694
- Contraction resistance, 891, 893
- Contractor, 722
- Control gates, 638
- Conveyance
 - efficiency, 521, 524
 - system, 514
- Correlation coefficient, 211
- Corrosion, 953, 963
- Cost estimates, 721
- Cost-benefit analysis, 705, 1062
- Cost-effectiveness analysis, 1063
- Crop coefficient, 156, 165
- Crop response, 645
- Crop water requirements, 165
- Cropping lay-out, 852
- CROPWAT, 170
- Crust method, 412
- Culvert, 790
 - friction losses, 795
 - long, 1025
 - short, 1025
 - transition losses, 791
- Cumulative frequency, 179
- Curve Number, 123, 127, 128
 - estimation, 126
 - factors, 124
 - method, 121
 - actual retention, 121
 - flat areas, 130
 - initial abstraction, 121
 - land treatment, 124
 - land use or cover, 124
 - potential maximum retention, 121
 - sloping areas, 131
- Cut/fill ratio, 809
- Daily inequality, 1006
- Darcy, 71, 232, 307, 405, 435, 935
 - applications, 238
 - validity, 237
 - Weisbach equation, 876
- Databases, 1072
- De Zeeuw-Hellinga
 - calculation, 290
 - equation, 287
- De-watering, 860
- Dead furrows, 800
- Deep borings, 700
- Deep percolation, 96, 443, 545, 579
- Delayed-yield effect, 374
- Delta plain, 37
- Depression storage, 117
- Design, *see also* Canal, Drainage
 - considerations, 27
 - collector, 887
 - discharge, 175, 650, 651, 736
 - optimum capacity, 738
 - documents, 829
 - drainage level, 1019
 - field drain, 884
 - frequency, 175
 - peak runoff rate, 142
 - rainfall, 116, 175
 - return period, 111
 - study, 720
 - water level, 735
 - watertable depth, 946
- Desorption, 399
- Diagnostic plot, 371
- Dielectrical soil properties, 389
- Diffuse double-layer, 88, 538
- Diffusor, 972
- Dirichlet condition, 410, 423
- Discharge
 - coefficient, 1023
 - hydrograph, 926
- Dislocation of soil particles, 896, 898
- Dispersion, 571
- Displacement, 160
- Disposal drain, 638
- Distance-drawdown analysis, 349
 - semi-confined, 368
 - unconfined, 365
- Distribution, *see also* Frequency distribution
 - efficiency, 521, 524
 - system, 514
- Diurnal tides, 1010
- Diversion drain, 825
- Donnan equation, 266
- Drain
 - alignment, 720, 849
 - depth, 844
 - critical, 856, 895
 - discharge, 266, 580
 - measurement, 902
 - ideal, 271, 473, 891, 892
 - line performance, 890
 - non-ideal, 893, 895
 - open, 29, 827

- outfall, 1057
- pipes, 830
 - hydraulic gradient, 874
 - hydraulics, 869
- spacing, 266, 716, 844, 845
 - calculations, 277, 288
- Drainable
 - pore space, 46, 95, 284, 288, 402, 614
 - porosity, 95, 402, 650
 - surplus, 305, 601, 612, 945, 946
 - calculation, 629
- Drainage, 608
 - agricultural effects, 657
 - aims, 533
 - art, 26
 - base, 844
 - basin, 118
 - characteristics, 118
 - size, 143
 - benefits, 643
 - bibliographies, 1086
 - canals, 725
 - design criteria, 735
 - design water level, 735
 - field check, 731
 - system
 - cost, 737
 - optimum design discharge, 738
 - planning, 731
 - quantity estimates, 721
 - capacity, 718
 - coastal plains, 727
 - coefficient, 883
 - conditions, 441, 457
 - criterion, 27, 277, 288, 292, 383, 635, 642, 656, 706, 707, 846
 - agricultural, 635
 - factors, 641
 - index, 642
 - Egypt, 673
 - Guyana, 683
 - Indonesia, 686
 - NW India, 681
 - Peru, 675, 679
 - technical, 635
 - design
 - criteria, 419
 - agricultural, 277, 288, 292, 635
 - steady, unsteady, 292
 - technical, 278, 288, 292
 - detailed, 829
 - discharge, 189, 718
 - equations
 - steady-state, 263, 275, 649
 - comparison, 275
 - discussion, 275
 - two-layered profile, 272, 276, 295
 - unsteady-state, 263, 283, 649
 - comparison, 292
 - discussion, 288
 - problem, 111
- effects
 - direct, 640, 1041
 - downstream, 1053
 - indirect, 641, 1042
 - local side-effects, 1044
 - negative, 641
 - positive, 641
 - upstream side-effects, 1060
- efficiency, 1056
- effluent, 1053
 - disposal options, 1055
- experimental fields, 456
- failure, 907
- field experiments, 900
- gravity, 638
- health, 1051
- heavy clay soils, 301
- hill-side, 299
- history, 24
- horizontal, 638, 651
- intensity, 277
- intermediate solution, 818
- investigation, 33, 707
 - network, 708
- lay-out, 852
 - herringbone system, 847
 - parallel grid system, 847
 - random system, 847
- machines, 855, 856
 - comparison, 859
 - grade-control system, 856
 - monitoring, 723
 - trenchers, 856
 - trenchless, 856
 - vertical plough, 856
 - V-plough, 856
- monitoring and evaluation, 723
- natural, 44, 50, 306, 443, 610, 699
- need, 23, 643, 700
- network, 706
- objectives, 1041
- off-season, 646
- outlet, 29, 694, 729
- pipe, *see* Pipe drainage
- problems, 693, 698
- problem soils, 107
- projects, 1041
 - alternative options, 1061
 - planning, 691
 - proposed land use, 697
- pumping, 638
- retention reservoir, 727
- simulation models, 427

- sloping lands, 294, 726
- sluice, 1001, 1020
 - self-operating, 1021
- special situations, 294
- strategies, 425
- structures, 725
 - regulating, 727
- subsidence, 477
- subsurface, *see* Subsurface drainage
- surface, *see* Surface drainage
- survey, 27, 691
 - Pakistan, 703
 - Peru, 701
- system
 - combined, 728, 817, 828
 - cross-slope, 822
 - operation and maintenance, 722
 - parallel open ditches, 817
 - storage capacity, 651
 - sustainability, 383
 - testing, 900, 902, 906
 - principles, 901
 - techniques, 25
 - types, 635
- theories, 26
- tubewell, *see* Tubewell drainage
- vertical, 638
- water
 - quality, 1039
 - re-use, 515, 523, 653, 1056
- works
 - execution, 722
 - inspection, 722
- Drawdown, 317, 349
 - data, 346
 - corrected, 352
 - deviating curves, 371
 - well field, 939, 942
- Dupuit
 - assumptions, 253
 - formula, 255, 313
 - well flow equation, 258
- Dupuit-Forchheimer assumptions, 252, 264, 284
- Duration analysis, 187

- Earth-moon system, 1005
- Earthmoving equipment, 807
- Earthwork volume, 809
- Ecosystem, 1042
 - destruction, 1043
- Edelman's auxiliary variable, 317
- Effective
 - porosity, 46, 95, 609,
 - see also* Drainable pore space
 - soil depth
 - deep profile, 448
 - layered soil, 450
 - soil stress, 481
 - well radius, 948
- Electrical
 - conductivity, 58, 98, 533
 - map, 623
 - resistance blocks, 396
- Electroneutrality, 538
- Elevation head, 94, 230, 393
- Encrustation, 899, 961, 962
- Endoscope, 926
- Energy
 - balance, 152
 - concept, 391
 - dissipator, 780
 - baffle-block, 786
 - drop height, 782
 - inclined drop, 786
 - selection, 783
 - straight-drop, 784
 - kinetic, 229
 - losses
 - culvert, 791
 - culvert bends, 794
 - water, *see* Water
- Engineering
 - factors, 619, 643, 657
 - judgment, 26
- Entrance resistance, 467, 470, 471, 910
 - calculation, 893
- Envelope, 832
 - design, 833
 - functions, 832
 - filter, 835
 - hydraulic, 835
 - material, 271, 833
 - mineral, 833
 - organic, 833, 839
 - synthetic, 833, 837
 - pore size, 839
- Environmental
 - aspects, 1041
 - concern, 27, 30
 - disturbance, 1043
 - factors, 643
 - impact, 1042
 - assessment, 1060
 - checklist, 1062
 - priority ranking, 1063
- Equipment suppliers, 1088
- Equipotential lines, 243
- Equivalent
 - depth, 268, 286
 - drain radius, 270
- Ernst equation, 265, 272
 - calculation, 282
 - geometry factor, 274

- Erosion, 1050
 - control techniques, 726
 - control terrace, 823
- Error function, 318
- Esker, 41
- Estuary mixing parameter, 1015
- Eutrophication, 1054
- Evaporation, 607
 - demand, 150
 - method, 413
 - network, 718
 - open water, 152, 155
 - pan, 150, 166
 - plant transpiration, 161
 - ponds, 1058
 - radiative equivalent, 168
 - soil, 161
- Evapotranspiration, 28, 145, 514, 606
 - actual, 147
 - concepts, 145
 - cropped surfaces, 156
 - developments, 145
 - dry crop, 157
 - limited soil-water supply, 163
 - measurements, 147
 - partial soil cover, 161
 - partitioning, 162
 - potential, 147
 - estimation, 165
 - empirical methods, 146, 151
 - FAO modified Penman, 146, 156
 - one-step, 147
 - two-step, 147, 165
 - Penman, 152, 155
 - Penman-Monteith, 146, 157, 167
 - physically-based methods, 146
 - weighting term, 167
 - reference, 147, 156, 160, 165, 166
 - computation, 167
 - REF-ET, 170
 - solar radiation, 171
 - wet crop, 156
- Excess
 - rainfall, 118, 133
 - surface water, 1059
- Exchange coefficient, 536
- Exchangeable sodium, 536
 - effect, 539
 - percentage, 98, 536
- Extraterrestrial radiation, 172
- Falling-head method, 454
- Fallow re-salinization, 946
- FAO Modified Penman method, 146, 156
- Feasibility study, 691, 705
 - density of observations, 708
 - preliminary design, 731
- Field
 - application efficiency, 521, 526
 - capacity, 94, 398
 - drain, 29, 814, 884
 - design procedure, 884
 - lay-out, 816
 - outlet, 840
 - V-shaped, 814
 - W-shaped, 814
 - drainage
 - criteria, 670
 - sub-areas, 715
 - system, 636
 - parallel, 816, 847
 - random, 816, 847
 - irrigation losses, 556
 - lateral, 815
 - salt balance, 526
 - water balance, 526
- Filter
 - construction, 779
 - function, 835
 - material beneath riprap, 776
 - natural build-up, 897
 - permeability, 776
 - stability, 777
 - strip, 825
- Fissure development, 914, 917
- Flap gate, 1025
- Floccules, 538
- Flood plain, 36, 441
- Flood protection, 636, 698
- Flow
 - above drain level, 267
 - below drain level, 267
 - conditions near a pipe drain, 891
 - domain, 602
 - horizontal, 238, 273
 - net, 337, 448, 590, 624, 626
 - diagrams, 244
 - literature, 1067
 - overland, 117
 - pipe *see* Pipe flow
 - radial, 273
 - steady-state, 347, 407
 - subcritical velocity, 753
 - supercritical velocity, 753
 - to drains, 29
 - basic assumptions, 263
 - subsurface, 263
 - to pumped wells, 30
 - turbulent, 752
 - uniform, 751, 773
 - unsteady-state, 407, 410
 - vertical, 239, 272
 - steady-state, 408

- Flushing
 - drain pipes, 866
 - effect, 868
 - machine, 867
- Fluvisols, 106, 108
- Forchheimer equation, 254
- Fossil salts, 520
- Free water surface, 225, 250
- Frequency
 - analysis, 175
 - interval method, 176
 - relative frequency, 176
 - density function, 193
 - distribution, 191, 644
 - censored, 179
 - comparison, 203
 - exponential, 201
 - extreme values, 198
 - fitting, 192
 - parametric method, 192
 - plotting method, 192
 - Gumbel distribution, 198
 - log-exponential, 202
 - log-normal, 198
 - mean value, 193
 - median, 194
 - mode, 194
 - normal distribution, 193
 - censored, 196
 - standard, 195
 - standard deviation, 193
 - duration analysis, 187
 - exceedance, 177
 - non-exceedance, 179
 - occurrence, 176
 - recurrence predictions, 181
- Fresh-water head, 231
- Friction factor, 876
- Froude number, 754, 783, 1016, 1023

- Gamma-ray attenuation, 386
- Gapon equation, 536
- Gas diffusion, 96
- Gated culvert, 1001, 1024
- Geological
 - cross-sections, 696
 - map, 696
- Geomorphology, 441
- Geostatistics, 84, 425
- Geotextiles, 779, 825, 833
- Glacial plain, 41
- Gley, 91
- Gleysols, 106
- Glover-Dumm
 - calculation, 288
 - equation, 284, 286
- Graded river, 36

- Grading curve, 835
- Gravel
 - envelopes, 834
 - moles, 926
 - pack, 49, 343, 957
- Gravimetric method, 384
- Gravitational
 - head, 393
 - potential, 392
- Gravity outlet
 - see also* Drainage sluice
 - capacity, 1027
 - computation errors, 1035
 - construction, 1037
 - crest level, 1037
 - critical flow, 1023
 - design, 1020
 - discharge, 1023, 1024
 - doors, 1038
 - drainage period, 1002
 - flushing, 1040
 - gates, 1038
 - location, 1027
 - operation, 1039
 - outer water level, 1003
 - sedimentation, 1039
 - storage
 - calculation, 1030, 1034
 - level, 1020
 - period, 1002
 - volume, 1002
 - structures, 1001
 - subcritical flow, 1022
 - types, 1020
 - width calculation, 1028, 1033
- Grid
 - point elevation, 809
 - survey, 508
 - system, 710
- Ground pressure, 481
- Groundwater
 - balance, 609, 649
 - data
 - collection, 47
 - interpretation, 65
 - processing, 59
 - definition, 225
 - depletion curve, 121
 - depth change, 525
 - divide, 603
 - flow, 29, 225, 305, 701
 - boundary
 - free water surface, 250
 - impervious layer, 249
 - plane of symmetry, 249
 - seepage surface, 251
 - water at rest, 251

- one-dimensional, 247
- partial differential equation, 621
- problems, 341
- steady, 254
- two-dimensional, 240, 248
- unconfined, 252
- unsteady differential equation, 285, 317
- hydraulic boundary, 44
- hydrograph, 59, 65
- inflow, 609
- integrated models, 622
- interception, 445
- investigations, 33
- maps, 59, 61, 69
 - interpretation, 69
- model
 - numerical, 620
 - prediction, 621
 - SGMP, 629
 - simulation, 629
 - steady-state, 621
 - types, 621
 - unsteady-state, 621
- observation
 - frequency, 907
 - network, 52, 719
 - density of observations, 53, 708
 - lay-out, 52
 - spacing, 53
 - period, 907
 - well, 48, *see also* Piezometer
 - correlation, 66
 - depth, 53
 - elevation, 54
 - wetted tape method, 54
- outflow, 609, 615
- profile in a dam, 256
- quality, 56, 617, 936
 - chemical constituents, 59
 - map, 64, 73
 - measurements, 58
- recession curve, 61
- recharge, 632
 - Punjab, 518
- runoff, 68, 117, 120
 - rating curve, 68
- seepage, 546
- salt balance, 619
- Guelph method, 455
- Gypsum, 535
 - application efficiency, 599
 - requirement, 598
 - saturated irrigation water, 557
- Habitat, 1045
- Hand-dug well, 48
- Hanging-water-column method, 401
- Hantush inflection-point method, 356, 358
- Hantush well function, 356
- Hantush-Jacob
 - drawdown equation, 356
 - method, 369
- Harmonic
 - analysis, 1008
 - motion, 325
- Head-differences map, 64, 73
- Head-discharge relationship, 781
- Herringbone system, 847
- High-water line, 739
- Highly saline subsoil, 562
- Histosols, 106, 108, 503
- Homogeneous soils, 275
- Hooghoudt
 - calculation, 278
 - equation, 264, 265
 - simplified, 287
 - equivalent depth, 268, 286
 - nomographs, 268
 - series solution, 268, 280
 - tables, 268
 - application, 278, 280
- Hosts, 1073
- Humus, 89
- Hydraulic
 - characteristic, 984
 - accuracy, 358
 - conductivity, 46, 96, 233, 265, 406, 487, 492
 - see also* K-value, permeability
 - function, 424
 - horizontal, 436, 442
 - map, 714
 - measurements, 435, 708
 - vertical, 273, 436
 - saturated, 415, 435
 - drop, 754
 - gradient, 265, 436
 - head, 44, 50, 93, 230, 251, 308, 315, 393
 - measurements, 902
 - tidal influence, 327
 - jump, 754, 784
 - output power, 969
 - overpressure, 489
 - pressure, 328, 481
 - pump losses, 982
 - radius, 755
 - resistance, 47, 308, 356, 439, 933, 934
 - soil properties, 28, 104
 - accuracy, 425
 - unsaturated, 410, *see also* K, K(h), K-theta
- Hydrocompaction, 478
- Hydrodynamic period, 489
- Hydrodynamics, 228
- Hydrogeological sub-areas, 612
- Hydrogeology, 33

- Hydrograph, 119, 329
 - base length, 121, 134
 - composite, 134, 139
 - single-peaked, 119, 120
- Hydrologic
 - cycle, 116
 - data, 716
 - analysis, 175
 - regime, 695
- Hydrological
 - soil group, 125
 - soil-cover complex, 126
 - soil-group map, 126
- Hyetograph, 134
- Hysteresis, 95, 399, 613

- Impact evaluation methods, 1062
- Impeller
 - pumps
 - description, 970
 - hydraulic behaviour, 971
 - size nomograph, 992
 - speed, 978
- Impermeable layer, 267, 715
- In-service training, 722
- Infiltration, 96, 586, 588, 606, 607
 - wetting front, 461
- Infiltrometer, 461, 596
- Information
 - addresses, 1089
 - dissemination, 1069
 - document delivery, 1071
 - quality, 1068
 - retrieval, 1067, 1070
 - sources, 1072
- Infrastructure, 850
- Institutions, 1084
 - aspects, 705, 719
- Intensified cropping, 1054
- Intensity-duration-frequency curve, 115
- Inter-disciplinary approach, 669
- Interception
 - estimation, 148
 - formula, 150
 - surface runoff, 726
- Interceptor
 - drain, 28, 825
 - height, 300
 - drainage, 298, 636
 - canal, 727
- Interflow, 117
- Interfluvial, 69
- Intergranular pressure, 328, 480, 483
- Interior plain, 39
- Internal rate of return, 1062
- Inundation damage, 736

- Inverse
 - Hooghoudt equation, 529
 - models, 622
- Inversed auger hole method, 456
 - procedure, 464
 - theory, 461
- Investment costs, 736
- Ion concentration, 533
- Iron ochre, 899
- Irreversible shrinkage, 491, 503
- Irrigation, 608
 - drainage, 513, 533, 652
 - basins, 806
 - efficiency, 521, 632, 654, 1055
 - increase, 524
 - project, 521
 - environmental effects, 513
 - operational spills, 515
 - regime, 654
 - water
 - bicarbonate, 583
 - requirement, 523
 - salinity, 576
 - sodium hazard, 580, 581
- Isobath, 63
- Isohyets, 113
- Isopluvials, 113
- Isothermal evaporation, 155
- Isotropy, 236

- Jacob's straight-line method, 351, 353, 372
- Jensen-Haise formula, 152

- K-estimation: indirect, 413
 - parameter estimates, 413
 - parameter optimization, 415
- K-measurement: direct, 412
 - crust method, 412
 - instantaneous profile method, 412
 - sorptivity, 412
- K(h) prediction, 413
 - soil texture, 413
 - soil-water retention, 414
- K(h) relationship, 409
- K-theta relationship, 411
 - inverse method, 415
- K-value, 435, *see also* Hydraulic conductivity
 - Darcy, 234
 - determination, 450
 - correlation, 451
 - grain-size distribution, 453
 - pore-size distribution, 452
 - soil mapping unit, 453
 - soil texture, 451
 - extraction, 455
 - hydraulic, 451
 - in-situ, 451

- large-scale, 456
 - parallel-drain methods, 466
 - small-scale, 454, 457
 - infiltration, 455
 - Guelph method, 455
 - shallow well pump-in method, 455
 - laboratory methods, 451, 453
 - flow induction, 454
 - permeameter method, 456
 - soil sampling, 453
 - geometric mean, 438
 - granular materials, 237
 - horizontal, 455
 - internal variability, 437
 - layered soils, 439
 - parallel drains, 466
 - representative K-value, 438, 441
 - semi-confined aquifers, 444
 - time trend, 440
 - unconfined aquifers, 441
 - variability, 436
 - seasonal, 440
 - weighted average, 439
 - Kirkham equation, 264
 - Kopeccky ring, 453
- Lake plain, 40
- Land
- classification, 697
 - crowning, 802
 - drainage, 23, *see also* Drainage
 - definition, 24
 - objectives, 640, 1041
 - evaluation, 107
 - form, 33
 - forming, 800
 - farm size, 820
 - grading, 803
 - calculations, 807
 - centroid, 808
 - design, 804, 807
 - operations, 807
 - planing, 803
 - reclamation, 478
 - slope, 447
 - subsidence, *see* Subsidence
 - use, 519
 - map, 101, 126
 - planning, 692
- Langelier-Bower nomograph, 582
- Laplace
- equation, 248, 406
 - operator, 248
- Lateral, *see* Field drain
- Latosol, 440
- Leaching, 527, 608, 652, 1042, 1050
 - depth, 546, 597
 - calculation, 593, 594
 - rule of thumb, 597
- efficiency coefficient, 569, 573
- equations, 591
- fraction, 546, 567, 575, 579
- intermittent, 589
- irrigation and rainfall, 575
- ponding, 589
- requirement, 28, 544, 546, 564, 584, 654
- techniques, 589
- Leaf area index, 162
- Leakage factor, 47, 308, 332, 356
 - determination, 309
- Least squares method, 205, 210, 1011
- Leg fissures, 914
- Lime, 535
- Literature
- abstract journals, 1072
 - bibliography, 1067
 - books, 1075
 - grey, 1067
 - journals, 1073
 - multilingual dictionaries, 1086
 - newsletters, 1075
 - primary, 1067
 - proceedings of symposia, 1087
 - tertiary, 1072
- Lithology, 714
- Loess, 43
- Logarithmic type curve, 322
- Longitudinal profile, 721, 750
- Lunar tide, 1005
- Lysimeter, 148
- Macroporosity, 418
- Magnum terrace, 823
- Main drainage, 699, *see also* Drainage
 - canal, 29, *see also* Canal
 - maintenance equipment, 746
 - system, 725
 - design, 706
 - system, 636
 - lay-out of canals, 725
- Maintenance
- canal, 762
 - pipe drainage systems, 865
 - pumps, 962
- Manholes, 842, 904
- Manning
- equation, 747, 755, 870, 876
 - resistance coefficient, 756
 - grain roughness component, 759
 - surface irregularity component, 759
 - vegetal drag component, 760
 - vegetal retardance, 761
- Manometric pump head, 982
- Mass conservation, 406

- Mass flow of gas, 96
- Matric head, 94, 392
- Matrix potential, 392
- Maximum recharge, 947
- Measurements
 - drain testing, 907
 - drain discharges, 902
 - evapotranspiration, 147
 - groundwater salinity, 58
 - hydraulic head, 902
 - overpressure, 903
 - soil-water pressure head, 394
 - soil-water suction, 396
- Mechanical
 - concept, 390
 - sounder, 55
- Meteorological data, 167
- Mineral soils, 89
- Miscible displacement, 571
- Mixed tides, 1011
- Mixed-flow pump, 966, 970
- Modelling
 - groundwater flow, 620, 629
 - drain depth and crop yield, 427
 - drainage for salinity control, 431
 - water supply and surface drainage, 430
- Modulus of elasticity, 329
- Mole
 - channel
 - failure, 918
 - grade, 922
 - grade control, 923
 - outlet, 921
 - stability, 918
 - stability requirements, 919
 - drain
 - depth, 920
 - formation, 913
 - spacing, 920
 - length of run, 921
 - drainage, 913
 - flow paths, 914, 917
 - introduction, 926
 - investigations, 926
 - foot diameter, 921
 - plough, 913
 - expander, 913, 921
 - floating, 925
 - foot, 913
 - front-skid, 924
 - mounted, 923
 - scrubbing, 924
 - types, 923
 - wedge, 917
 - timing, 920
- Mottling, 91
- Mountains, 33
- Muck soils, 89
- Multi-criteria analysis, 1063
- Multi-piezometer well, 54
- Natural
 - drainage, 44, 50, 306, 443, 610, 699
 - resources, 1043
- Net
 - positive suction head, 980
 - present value, 958, 1062
- Neumann condition, 410, 423
- Neutron
 - probe, 615
 - scattering, 385
- Nichols terrace, 822
- Nile hydrology, 516
- Nitrogen fertilizer, 668
- Nodal
 - areas, 622
 - network, 422
 - points, 712
- Non-erodible velocity, 804, 824
- Non-linearity, 620
- Non-return valve, 990
- Numerical
 - methods, 421
 - boundary conditions
 - lower, 423
 - upper, 422
 - finite difference, 421, 621
 - finite element, 422, 621
 - initial conditions, 422
 - leaching calculation, 594
 - synthetic Newton-Raphson, 871
 - models
 - calibration, 424
 - groundwater, 620
 - input, 621
 - Cauchy condition, 410, 423
 - Dirichlet condition, 410, 423
 - Neumann condition, 410, 423
 - shrinkage, 500
 - validation, 424
- Nutrient supply, 667
- Off-season drainage, 646
- Open
 - augerholes, 904
 - collectors, 848
 - drains, 29, 827
 - variable, 295
- Organic
 - carbon oxidation, 477, 503
 - matter, 89
 - content, 493
 - decomposition, 503
 - soils, 89, 108, 503, 504

- Osmotic
 - head, 393
 - potential, 392
 - salinity effect, 542
- Outlet, *see* Drainage outlet, Gravity outlet
- Oven-dry point, 398
- Over-designing, 738
- Overland flow, 117
- Overpressure, 911
- Oxidation
 - organic carbon, 477, 503
 - pyrite, 104
- Pan evaporation, 150, 166
- Particle-size distribution, 85
- Peak
 - discharge, 636
 - drainage requirement, 946
 - runoff, 119
 - rate, 111, 136
 - estimation, 139
- Peat, 89, 108
- Pedo-transfer functions, 413
- Pedogenesis, 78
- Penetration ratio, 943
- Penman
 - FAO modified, 146, 156
 - formula, 155
 - method, 152
- Penman-Monteith
 - approach, 157, 167
 - equation, 146
- Perched watertable, 44, 915
- Percolation, 96, 515, 606
 - losses, 578
 - net, 575
- Periodicity, 222
- Permeability, 44, 96, 585
 - see also* Hydraulic conductivity, K-value
- pF, *see* Soil-water retention
- Photo mosaic, 731
- Phreatic
 - conditions, 43
 - surface definition, 225
- Piezometer, 49, 231, 344, 610, 902, 903
 - see also* Groundwater observation well
 - depth, 344
 - head, 50, 230
 - method, 455
 - network, 905
 - number, 345
 - spacing, 344
 - confined aquifers, 345
 - semi-confined aquifers, 345
 - unconfined aquifers, 344
- Pipe
 - connections, 841
 - diameter, 846, 870
 - drain, 29, 827
 - area drained, 870, 884
 - bridges, 842
 - chemical deposits, 899
 - cleaning, 866
 - gradient, 846, 870, 874
 - flow equation, 870
 - adapted, 872
 - full-flowing, 870
 - laminar, 234
 - non-uniform, 872
 - partially full, 871
 - envelope, *see* Envelope
 - invert level, 845
 - length, 870, 884
 - multiple-diameter, 885
 - outlets, 840
 - physical conditions, 895
 - plastic, 830
 - corrugated, 831
 - corrugations, 877
 - double-walled, 831
 - PE, PP, PVC, 831
 - smooth, 831
 - quality, 832
 - root growth, 899
 - roughness, 875
 - safety factor, 881
 - sedimentation, 882
 - single-diameter, 885
- drainage, 639
 - implementation, 827
 - inspection, 722
 - frequency, 866
 - methods, 863
 - level recording, 864
 - rodding, 863
 - routine checks, 866
 - installation, 854
 - effects, 895
 - logistics, 861
 - post-construction check, 866
 - special conditions, 862
 - staking out, 854
 - supervision, 863
 - wet conditions, 862
 - performance monitoring, 865
 - structures, 840
 - systems
 - composite, 847
 - design, 829
 - lay-out, 846
 - maintenance, 865
 - operation, 865
 - singular, 847
 - testing, 900

- measurements, 907
 - discharge, 902
 - hydraulic head, 902
 - overpressure, 903
- Piping, 898
- Plains, 33
- Plane method, 808, 810
- Planosols, 106, 109, 437
- Plasticity index, 90
- Playa, 40
- Plinthosols, 107
- Pluviograph, 115
- Pluviometer, 115
- Point rainfall, 112
- Poiseuille equation, 234
- Polder, 25, 636
- Ponded water case, 590, 912
- Porchet method, 462
- Pore-size distribution, 92
- Porosity, 91, 233, 481, 486, 504
- Post-authorization study, 691, 720, 829
- Potential head, 50, 230
- Precipitation, 607, *see also* Rainfall
 - bicarbonate, 583
 - calcium carbonate, 580
 - magnesium carbonate, 583
 - slightly-soluble salts, 583
- Preferential flow, 418
 - sink term, 419
 - source term, 419
- Pressure
 - head, 94, 230, 393
 - logger, 55
 - membrane method, 402
 - pan method, 402
- Probability paper
 - Gumbel, 200
 - normal, 196
- Production casing, 950, 953
- Profile method, 811
 - calculation, 812
- Proportionality principle, 134
- Protective lining, 773
 - sieve curves, 777
 - stone size, 773
- Pseudo-steady-state
 - aquifer tests, 347, 365
 - drawdowns, 366
- Psychometric constant, 154, 168
 - modified, 159, 168
- Pump, 965
 - adjustment, 984
 - best-efficiency point, 972, 975
 - capacity, 945
 - characteristic, 984
 - dimensions, 978
 - discharge
 - aquifer tests, 347
 - measurement, 347
 - driver, 995
 - maintenance, 962
 - power, 993, 995
 - power reduction, 995
 - efficiency, 969, 974
 - housing, 950, 952
 - maintenance, 962
 - net positive suction head, 980
 - operating point, 984
 - operating range, 974
 - relations diagram, 991
 - selection, 990
 - shaft input power, 969, 974, 993
 - specific speed, 974
 - static head, 983
 - submersible, 957, 962
 - system characteristic, 986
 - total head, 982
 - types, 966
 - axial flow, 966, 971
 - centrifugal, 970
 - impeller, 970
 - mixed-flow, 966, 970
 - screw
 - advantages, 967
 - disadvantages, 967
- Pumping station, 699, 965
 - design, 986
 - multiple-sump, 989
 - single-sump, 987
 - sump model tests, 987
 - location, 997
 - multiple, 853
 - parallel pumping, 987
- Pumping test, 349
- Pyrite oxidation, 104
- Quick-sand, 845
- Radial flow, 273
 - resistance, 70, 296, 892
 - towards a drain, 296
 - hydraulic conductivity, 436, 442, 443
 - pump, 966
- Radiation
 - net, 168
 - long-wave, 169
 - short-wave, 168
 - term, 155
- Rainfall
 - analysis, 111
 - depth-area, 112
 - depth-area-duration, 114
 - depth-duration-frequency, 115, 188
 - maximum totals, 187

- moving totals, 187
 - ranking of data, 181
 - successive totals, 187
- areal, 112
- depth, 111
- intensity, 111
- irrigation schemes, 523
- maximum ratios, 116
- observation network, 717
- phenomena, 111
- records, 717
- regime, 654
- Rainfall-frequency
 - analysis, 115, 718
 - approach, 111
- Rainfall-runoff relationship, 123, 718
- Ratio method, 205, 206
- Rational method, 137
 - drainage basin slope, 138
 - maximum length of travel, 138
 - time of concentration, 137
- Reaction factor, 286, 287, 293
- Recharge, 256
 - non-uniform, 287.
- Reclamation, 490, 915
 - considerations, 588
 - field tests, 596
 - newly reclaimed soils, 490
 - saline sodic soils, 598
 - salt-affected soils, 588
 - sodic soils, 598
 - time required, 597
- Reconnaissance survey, 49, 691, 692
 - basic data, 694
 - basic data collection, 692
- Recovery
 - groundwater, 515, 523
 - test, 349
- Regression
 - analysis, 175, 205, 474
 - coefficient, 209
 - constant, 209
 - intermediate, 215
 - reduced sum of squares, 210
 - segmented, 217
 - break points, 217
 - two-way, 214, 469
 - y upon x, 209
- Relaxation method, 259
- Remote sensing, 163
- Reservoir
 - analysis, 1035
 - series, with bypass, 593
 - single, with bypass, 591
- Residual
 - drawdown, 360
 - data, 361
 - sodium carbonate, 583
 - soil-water content, 414
- Resistance network, 296
- Return
 - flows, 515
 - period, 181
 - conditional, 184
- Reynolds number, 237, 752
- Richards' equation, 407
- Rip-rap, 774
- River
 - catchment, 612
 - deltas, 445
 - floods, 1014
 - gauging network, 719
 - plain, 34
 - runoff, 613
- Rootzone
 - depth, 97
 - drying, 561
 - four-layered, 567, 573, 594
 - leaching, 567
 - one-layered, 544, 573
 - salinity: estimating, 578
 - salt balance, 544
- Roughness length, 160
- Row drain, 817
- Runoff
 - calculation procedure, 141
 - cycle, 116
 - direct, 117, 120, 707
 - depth estimation, 129
 - hydrograph, 120
 - rate, 133
 - time distribution, 133
 - groundwater, 68, 117, 120
 - hydrograph, 118
 - peak runoff reliability, 143
 - phenomena, 116
 - response characteristic, 124
 - surface, 515
 - total, 117
- Sabakh soil, 541
- Saline
 - soils, 109, 540
 - groundwater head, 231
 - seep, 519
 - sodic soils, 540
- Salinity, 98, 440, 519, 533, 652, 669
 - classification, 543
 - control, 28, 533, 652, 1041, 1054
 - drainage, 579
 - effects
 - crop growth, 542
 - local, 520
 - regional, 519
 - specific ion, 542

- long-term, 575
- natural, 696
- sources, 57
- subsoil salts, 520
- Salinization, 104, 513, 533, 1048
 - with seepage, 562
 - without seepage, 561
- Salt
 - affected soils, 540
 - salic horizon, 542
 - balance, 601
 - assumptions, 545
 - equations, 617
 - groundwater zone, 619
 - rootzone, 544
 - studies, 620
 - surface, 617
 - total, 619
 - unsaturated zone, 618
 - build-up, 619
 - concentration, 98, 533
 - displacement, 569
 - equilibrium, 544
 - calculation, 550
 - equation, 549
 - intrusion, 1015
 - calculation, 1018, 1019
 - maximum length, 1017
 - minimum length, 1016
 - rootzone, 548
 - slightly soluble, 556
 - storage, 548
 - calculation, 550
 - equation, 549
 - tolerance, 542
- Sand
 - pumping, 963
 - trap, 957
- SAR
 - ESP nomogram, 537
 - irrigation water, 580
 - soil solution, 580, 585
- Saturated
 - extract, 534
 - paste, 534
 - thickness, 46
 - zone, 225
 - model, 622
 - water balance, 609
 - salt balance, 619
- Savenije method, 1017
- Scaling, 425
- Scarification, 803
- Scouring
 - outlets, 1039
 - protection, 773
- Sediment
 - bed-material load, 768
 - suspended, 768
 - transport, 765
- Sedimentation
 - primary, 898
 - secondary, 898
- Seepage, 69, 305, 443, 1049
 - area, 67
 - dam, 312
 - dike, 313
 - calculation, 315
 - downward, 610
 - equation, 308
 - open channels, 332
 - river, 305
 - spatial distribution, 309
 - surface, 251
 - unsteady, 316
 - upward, 44
 - calculation, 311
- SE_x index, 648
- Shear stress, 227
- Sheet flow, 806
- Sheet piles, 1039
- Shrinkage, 477, 489
 - calculation
 - heterogeneous soil, 499
 - homogeneous soil, 498
 - estimation, 494
 - density-comparison method, 494
- Silt content, 559, 566
- Simulation model, 420
 - data input, 424
 - SWACROP, 420, 426, 427
 - SWATRE, 162, 164, 431
- Single-well test, 341, 358
 - aquifer tests, 375
 - residual drawdown, 363
 - unconfined calculation, 353
- Siphon, 791, 1025
- Sodic soils, 109, 539, 540
 - natric horizon, 542
- Sodicity, 98, 533, 440, 585, 668
 - crop growth, 542
- Sodification, 104
- Sodium
 - adsorption ratio, 98, 536
 - adjusted, 586
 - hazard, 580, 581
 - plant sensitivity, 544
- Soil, 77
 - acidity, 99, 440, 669
 - aeration, 492, 1042
 - aggregates, 90
 - air, 96
 - carbon dioxide pressure, 585

- alluvial, 436, 443
- alkali, 109
 - black, 99
- bearing capacity, 665
- black cotton, 108
- characteristics, 85
- classification, *see* Classification
- colour, 91
- compaction, 477
- compression, 477, 480
- conditions, 77
- consistency, 90, 740
 - limits, 90, 740
 - Atterberg, 90, 742
 - liquid, 90
 - plastic, 90
 - plasticity index, 90
- consolidation, *see* Consolidation
- crack formation, 492
- crust, 539
- data
 - collection, 100
 - drainage design, 28, 277, 292
 - existing, 101
 - measuring programme, 101
- deficiencies, 109
- depth, 97
- dispersion, 539
- drying, 1042
- fertility, 99
- formation, 77
 - factors, 78
 - climate, 78
 - human activity, 80
 - organisms, 80
 - parent material, 78
 - time, 80
 - topography, 78
 - processes, 80
 - biological, 81
 - chemical, 81
 - physical, 80
- heterogeneity, 83
- homogeneity, 83
- horizons, 81
 - functional, 414
 - master, 82
 - soil differentiation, 81
- map, 99, 700, 708
- mapping, 103
- matrix, 93
- mechanics, 477
- mineral, 89
- mineral composition, 87
- muck, 89
- organic, 89, 108, 503, 504
- peat, 108
- peds, 90
- phases, 91
- physical behaviour, 537
- pit, 700
- pores
 - macro-pores, 93
 - meso-pores, 93
 - micro-pores, 93
- pressure calculation, 481
- profile, 82
 - master horizons, 82
 - stratification, 845
- properties, 90, 451
 - drainage, 104
 - physical, 91
- ripening, 104, 108, 490
 - biological, 491
 - chemical, 490
 - classification, 493
 - physical, 490
- saline, 109, 540
- salt-affected, 540
- sodic, 109, 539, 540
- salinity *see* Salinity
- samples
 - disturbed, 100
 - undisturbed, 100
- saturation, 397
- specific heat capacity, 97
- stability, 897
- structure, 90, 539, 664
- subsidence, *see* Subsidence
- suitability, 697
- survey, 99, 103
 - systematic, 696
- taxonomy, 541, 697
- temperature, 97, 664
- texture, 85, 578, 833
- visual observations, 100
- water
 - balance method, 147, 544
 - characteristic, 397, 424, 614
 - content, 92, 403, 613
 - mass basis, 384
 - measurement, 383
 - volume basis, 384
 - diffusivity, 412
 - dynamics
 - basic concepts, 389
 - mathematical models, 420
 - extract, 535
 - flow simulation, 419
 - mixing, 546
 - movement equation, 416
 - retention, 93, 94, 397
 - curve, 94, 397, 613
 - determination, 400

- in situ, 400
- laboratory, 401
- porous medium, 401
- suction, 94, 395
- suction plate method, 401
- storage, 606
- storage coefficient, 402
- tension, 395
- zone, 605
- workability, 649, 665
- Solonchak, 106, 541
- Solonetz, 107, 541
- Solubility
 - calcium carbonate, 556, 581
 - gypsum, 556
- Sorjan system, 803
- Sorptivity, 412
- Source-sink system, 566
- Spatial variability, 425, 436, 620, 631
 - hydraulic soil parameters, 425
 - water balance terms, 425
- Specific
 - surface
 - area, 88
 - ratio, 453
 - volume, 494
 - water capacity, 407
 - yield, 46, 95, 317, 351, 364, 372, 609, 614
 - calculation, 353
 - recovery, 361
 - underestimation, 363
- Statistical analysis, 456
- Step-drawdown test, 353
- Stomatal resistance, 157
- Storativity, 46, 328, 350
- Storm surges, 1013
- Stream function, 242
- Streamlines, 240
 - refraction, 245
- Structural stability, 919
- Student
 - distribution, 207
 - t-test, 221
- Sub-irrigation, 529
- Subcatchment, 612
- Subsidence, 30, 104, 440, 477, 483, 667, 1046
 - calculation, 485
 - computer model, 489
 - degree, 479
 - effects
 - direct, 486
 - drainage, 479, 508
 - land use, 478
 - secular, 486
 - structures, 479
 - organic soils, 503
 - calculation, 507
 - equations, 504
 - oxidation, 505
 - peat, 504
 - rate, 479
 - time-dependent, 486
- Subsurface drainage, 29, 301, 631, 715
 - see also* Pipe drainage, Tubewell drainage
 - rice fields, 851
 - problems, 699
 - soil features, 102
 - system, 636, 639, 827
 - types, 827
- Superposition principle, 135
- Surface
 - drainage, 29, 301, 651, 799
 - definition, 799
 - design capacity, 115
 - problems, 698
 - regular, 637
 - sloping-area, 821
 - soil features, 103
 - system, 636, 639, 799
 - flushing, 590
 - mulch, 560
 - run-off, 515, 726
 - salt balance, 617
 - stagnant water, 912
 - water balance, 607
 - water inlets, 843
 - water storage, 607, 818
- Survey procedures, 691
- Sustainable land use, 1043
- Swelling and shrinkage, 89, 440

- Tail recession, 466
- Tensiometer, 93, 393, 395
- Terrace, 821
- Terzaghi theory, 483
- Textural triangle, 87
- Thalweg, 849
- Theis
 - equation, 350
 - recovery method, 361
 - well function, 351
- Thiem
 - Dupuit equation, 365, 368
 - straight-line method, 365
- Thiessen method, 113
- Thoma number, 980
- Tidal
 - amplitude, 1009
 - angular speed, 1009
 - components, 1008
 - current, 1013
 - drainage, 1001
 - fluctuations propagation, 329
 - level, 1009

- phase lag, 1009
- prediction, 1011
- river, 1011
- sluice simulation model, 1036
- wave, 1004
 - amplitude, 326, 331
 - ratio, 330
 - reduction, 327
 - frequency, 326
 - phase shift, 327, 331
 - transmission
 - semi-confined, 327
 - unconfined, 327
- Tide, 1003
 - mixed, 1011
 - neap tide, 1007
 - semi-diurnal, 1006, 1011
 - spring tide, 1006
- Till, 41
- Time
 - domain reflectometry, 389
 - drawdown analysis, 349, 350, 364
 - semi-confined, 355
 - unconfined, 350
 - intensity rainfall graph, 134
 - invariance principle, 134
 - concentration, 137
 - recovery analysis, 349, 360, 364
 - series
 - extrapolation, 222
 - missing data, 223
 - periodicity, 222
 - screening, 175, 220
 - stability, 220
 - to peak, 136
 - trend, 220
- Topographic
 - grid survey, 807
 - map, 694, 731
- Tractive stress, 766
- Training facilities, 1088
- Transmissivity, 46, 239, 273, 317, 351, 364, 365, 372, 439, 628, 933, 934
 - calculation, 322, 353
 - overestimate, 363
- Transpiration rate, 416
- Trash rack, 996
- Trench backfill, 834
 - erosion, 862
- Trenchers, 856
- Trenchless drainage machines, 856
- Tubewell, 28, 520, *see also* Well
 - depth calculation, 955
 - design discharge, 945
 - drainage, 30, 631, 639, 651, 931
 - advantages, 932
 - disadvantages, 932
 - equations, 937
 - feasibility, 933
 - systems, 931
- irrigation, 936
- operating factor, 945
- public, 931
- pump, 957
- system design, 944
- Turc formula, 151
- Unit hydrograph, 133
 - dimensional, 136
 - dimensionless, 136
 - parametric, 136
- Unit storm period, 133
- Unsaturated zone, 226, 263, 383
 - flow equation, 406
 - hydraulic conductivity, 410
 - model, 621
 - salt balance, 618
 - water balance, 604
- V-plough, 856
- Vadose zone, 604
 - intermediate, 605
- Van Genuchten equation, 414
 - shape factor, 414
- Van Os & Abraham method, 1016
- Vapour pressure
 - deficit, 170
 - method, 402
- Varve, 42
- Vector-borne diseases, 1052
- Vegetated waterways, 824
- Vegetation map, 101
- Velocity
 - coherent earthen canals, 769
 - grassed channels, 769
 - head, 230
 - potential, 243
- Vertical plough, 856
- Vertisols, 106, 108, 437
- Void ratio, 483
- Volute, 972
- Water
 - available, 95, 398
 - balance, 27, 513, 521, 601
 - analysis, 612, 622, 624
 - applications, 612
 - calculation, 625
 - changes, 519
 - components, 602
 - equations, 601, 617
 - features, 602
 - integrated, 610
 - overall, 611

- studies, 631
- surface, 607
- time, 602, 616
- top-soil, 610
- unsaturated zone, 604
- density, 226, 1036
- development, 705
- energy, 229
- kinetic, 229
 - potential, 229
 - pressure, 229
 - total head, 230, 753
- extraction by plant roots, 416
 - sink term, 416
- factor, 493
- flow in isotropic media, 406
- holding capacity, 95
- level
 - fluctuations, 325
 - indicator, 55
 - measurement, 54, 346
 - recorder, 55
 - losses from irrigation systems, 513
- lifting devices, 965
- management change, 525
- potential, 93, 391
 - mass basis, 392
 - volume basis, 392
 - weight basis, 392
- quality, 719
- readily available, 399
- related diseases, 1052
- retention, *see* Soil water retention
- transmitting properties, 96
- uptake functions, 417
- use efficiency, 28
- viscosity, 227
 - dynamic, 227
 - kinematic, 227
- Waterlogging**, 513, 578, 635, 1041
- Watertable**, 609
 - contour map, 61, 69, 260, 623
 - crop production, 659
 - definition, 225
 - depth, 615, 707
 - critical, 561, 660
 - design, 946
 - map, 63, 72, 623
 - optimum, 565
 - permissible, 647, 656
 - drawdown, 656
 - fluctuation, 650
 - map, 63, 72
 - height, 265
 - index, 644, 645
 - critical duration, 651
 - lowering, 1046
 - measurement frequency, 56
 - shape, 69
 - soil conditions, 663
 - to discharge ratio, 656
 - yield relationships, 659
- Well**, *see also* Tubewell
 - cased, 49
 - depth, 950
 - design, 950
 - development, 954
 - diameter, 951
 - distance calculation, 947
 - field
 - configuration, 948
 - design, 947
 - computer program, 960
 - flow
 - equation, 341
 - steady-state, 937
 - steady-state, 257
 - formation, 952
 - location, 342
 - log, 345
 - losses, 952
 - non-linear, 352
 - maintenance, 960
 - pattern
 - rectangular, 940
 - triangular, 937
 - penetration
 - full, 343
 - partial, 343, 366, 369, 372, 942
 - physical plugging, 962
 - records, 961
 - rehabilitation, 961
 - screen, 343
 - corrosion, 962
 - diameter, 955
 - entrance velocity, 945, 954
 - functions, 953
 - length, 955
 - section, 950, 953
 - semi-confined aquifers, 343
 - slot size, 954
 - unconfined aquifers, 343
 - spacing calculation, 949
 - system design optimization, 958
 - pointing, 860
 - uncased, 48
- Wetlands**, 1044
- Weisbach-Darcy Equation**, 796
- Wilting point**, 95, 398

