

SEMINAR

Application Ecosan and Resource Oriented Sanitation –
The New Challenge for Indonesian Wastewater Management in Rural Area

THE DOMESTIC WASTEWATER MANAGEMENT IN INDONESIA

Prayatni Soewondo and Marisa Handajani
prayatnisoe@yahoo.com

Environmental Engineering Program
Faculty of Civil and Environmental Engineering



Institut Teknologi Bandung
March, 2012

Contents :

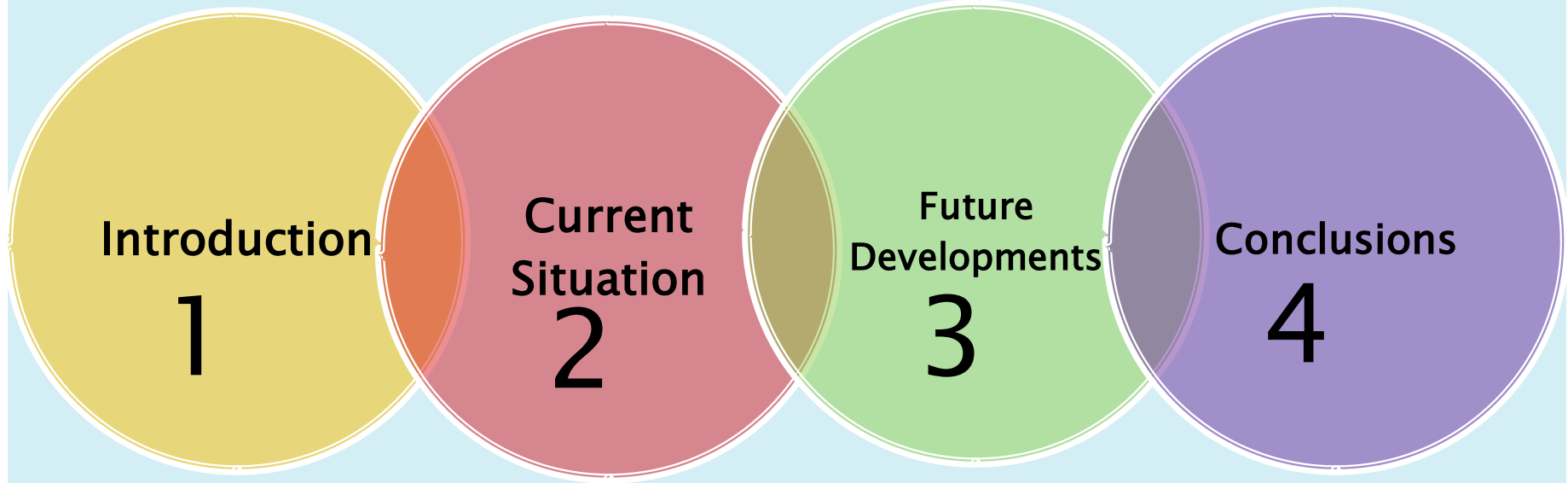

1. Introduction

- ✓ The major pollutant in Indonesia comes from domestic wastewater;
- ✓ It contributes about 70 % of organic loads in urban rivers
- ✓ The water quality trends to decrease, as example:
 - some parameters COD, BOD, nitrogen and phosphate; always increases annually



MAP OF BANDUNG

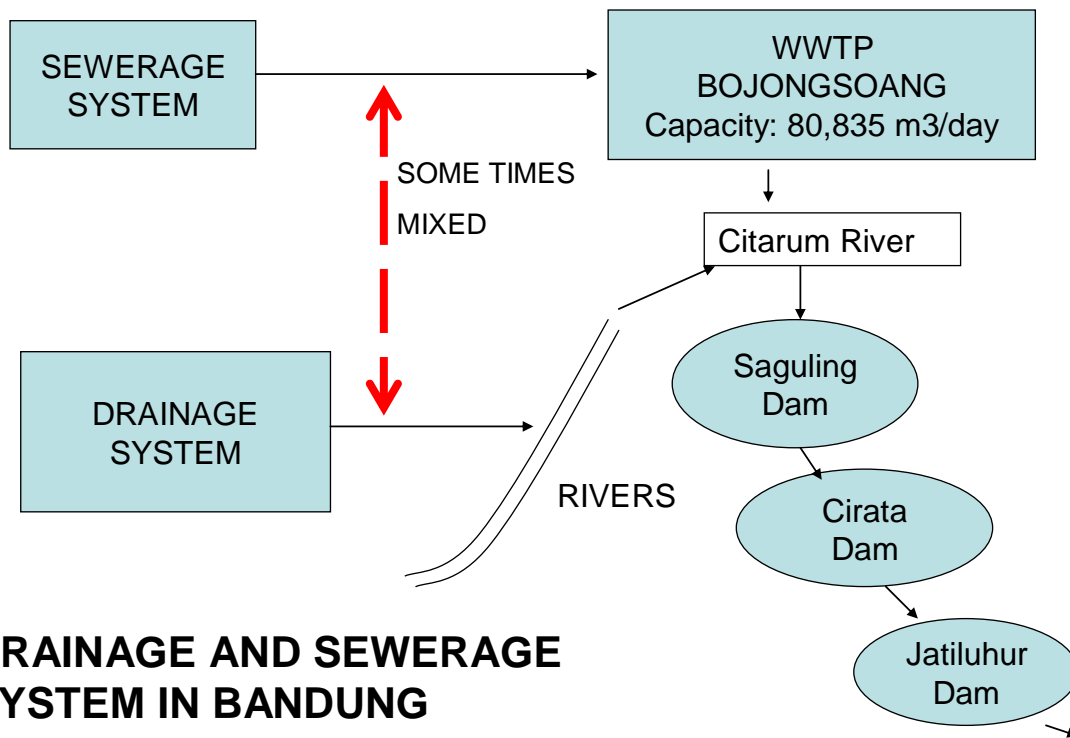
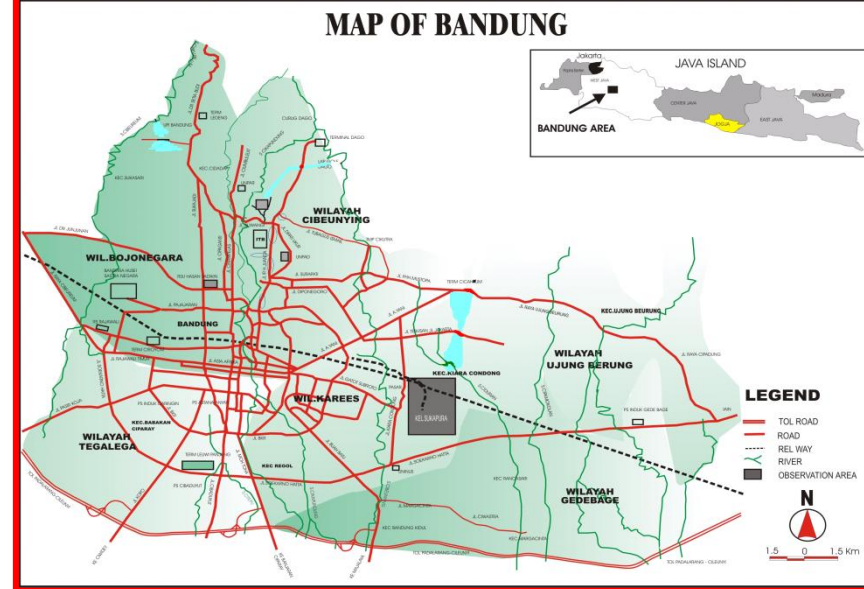

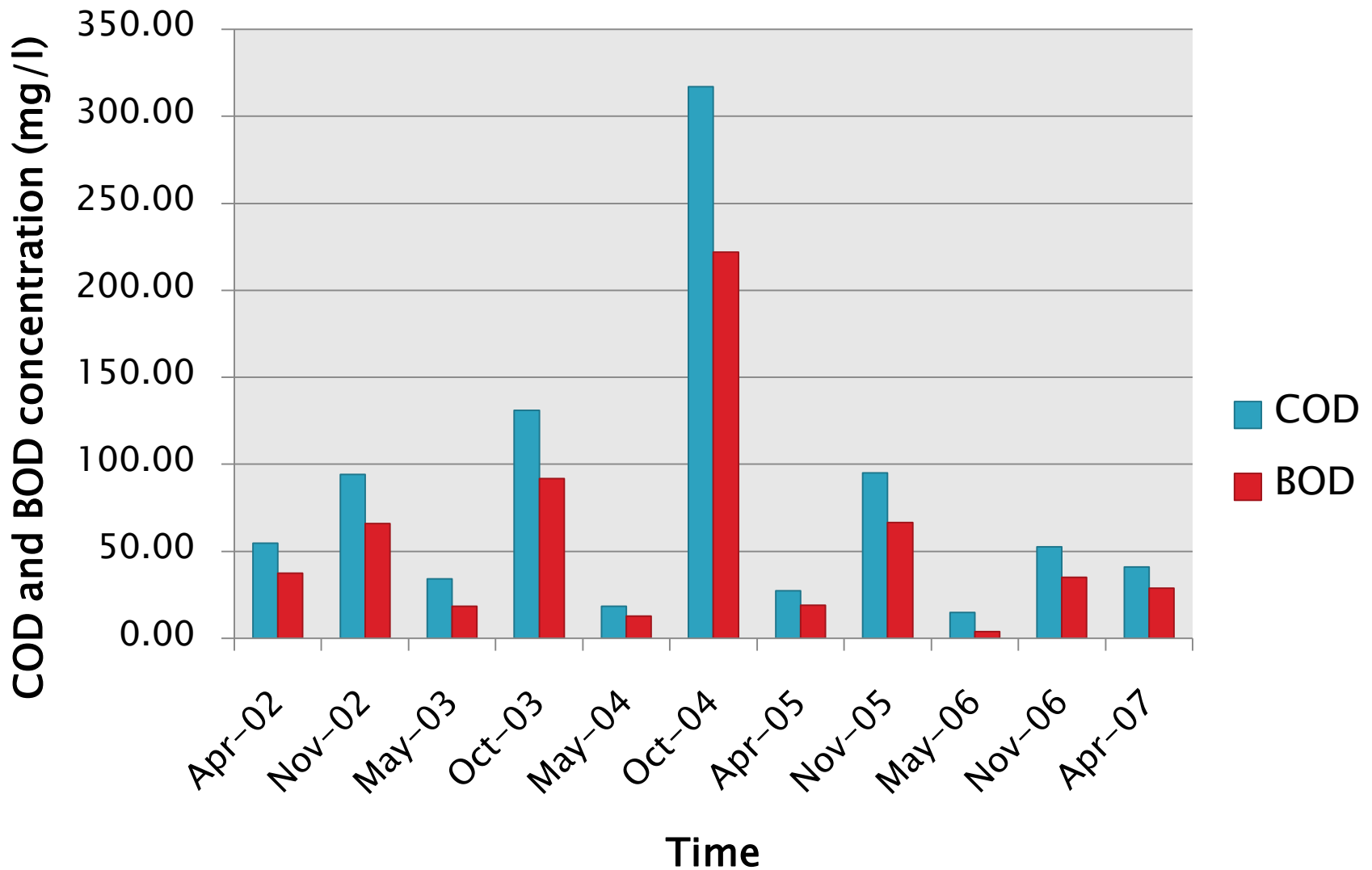

The concentration of BOD and COD in Citarum river, Nanjung during wet and dry seasons, 2002–2007

2. Current Situation

- The population is around 237.5 million (BPS, 2010)
- The population lives : 42 % in urban area and 58 % in rural area (BPS, 2006)
- Basic facilities of sanitation : 69.51 % in urban area and 33.96 % in rural area (Bappenas, 2009)
- Most of the people in Indonesia build their basic infrastructure of sanitation by self-supporting means.
- In national scale, only 51.19 % of population has basic sanitation facilities (Bappenas, 2009)

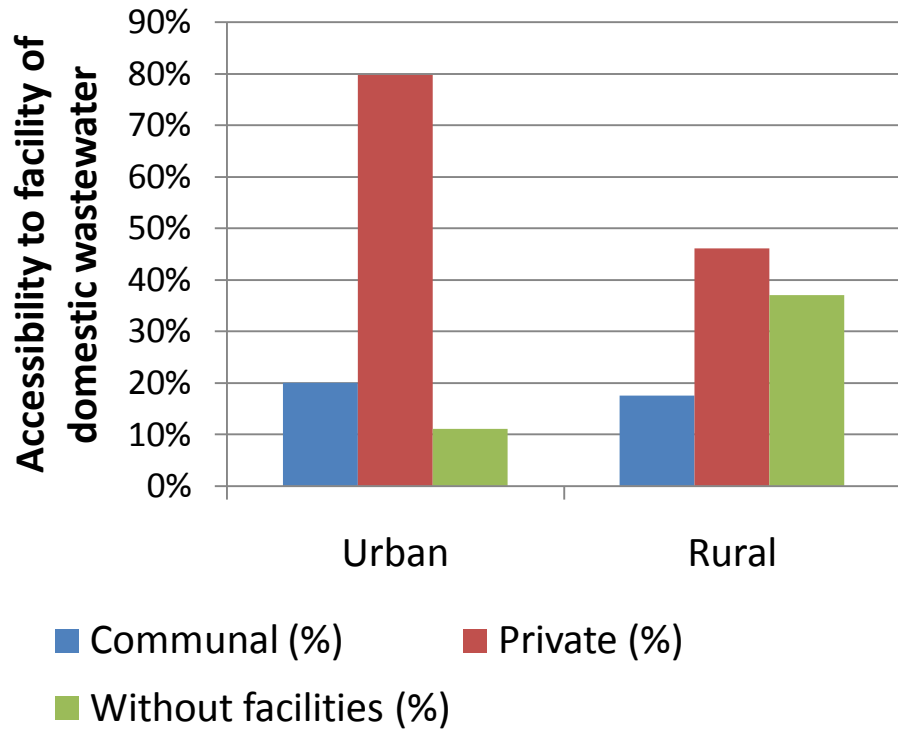

Source: National Action Plan, 2003

The accessibility of basic sanitation in Indonesia, 2000

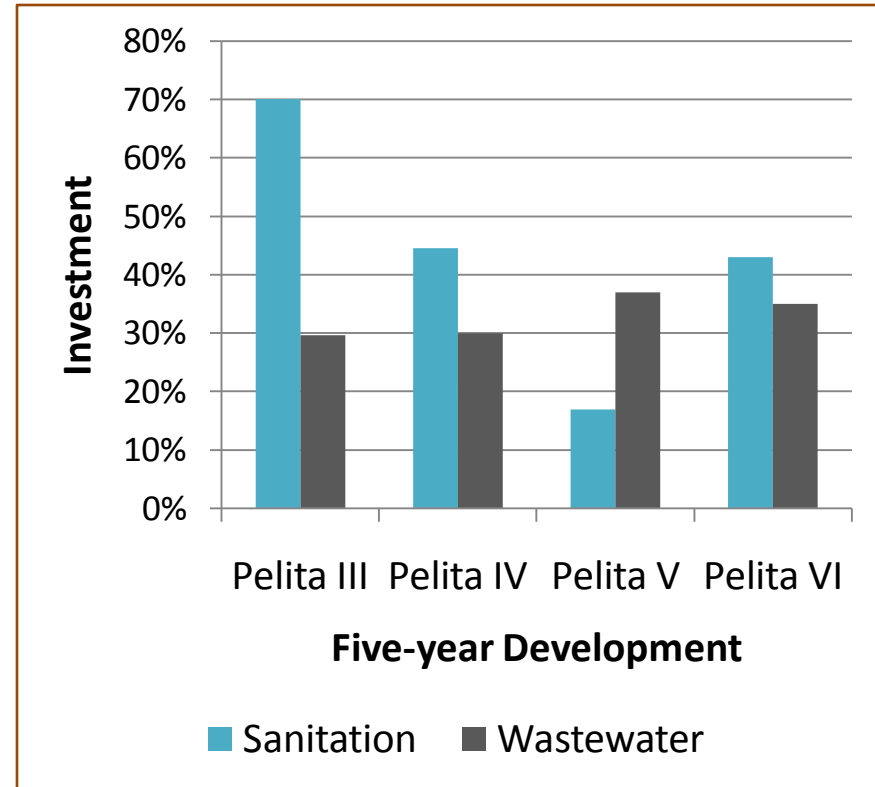

The investment of five-year development in Indonesia for sanitation (include water supply) and infrastructure of wastewater

Table 1 Profile of Domestic Wastewater Treatment in Indonesia (2000)

No	City	Population (person)	Served Area (Ha)	Served Population		Served Area		Capacity and Efficiency WWTP		Art of treatment
				Person	%	Ha	%	m3/day	%Eff	
(1)	(2)	(3)	(4)	(5)	(6)	(7)	(8)	(9)	(10)	(11)
1	Balikpapan	436.029	50.331	7.764	1,8	40	0,1	800	Tad	ExAE
2	Banjarmasin	579.362	7.200	50	0,0	20	0,3	500	93,3	RBC
3	Bandung	2.250.000	16.729	420.000	18,7	6.000	35,9	243.000	91,7	S.POND
4	Cirebon	269.478	3.736	60.000	22,3	120	3,2	13.500	Tad	S.POND
5	Denpasar (*)	459.384	23.653	181.600	35,2	1.655	7,0	51.000	Tad	AELGN
6	Jakarta	9.175.600	65.570	1.659.000	20,3	6.260	9,6	462.600	66,7	AELGN
7	Medan	1.974.300	26.5	51.000	2,6	450	1,7	30.000	Tad	UASB
8	Prapat (*)	10.000	192,1	10.500	10,5	71,6	37,27	2.010	85,0	AELGN
9	Surakarta	539.387	4.404	4.000	0,7	60	1,4	2.000	95,8	AELGN
10	Tangerang	1.320.600	18.378	45.700	3,5	82	0,4	5.500	Tad	OXD
11	Yogyakarta	906.237	20.304	60.726	6,7	1.220	6	15.500	87,9	OXL
12	Total	17.910.377	236.805	2.489.940	13,9	15.977	6.75	826.410		

(a)



(b)



**Wastewater Treatment
Plant in Medan (a) and
Jakarta (b)**

Table 2 Communal and Private On Site Systems in Urban Areas (2000)

Province	Served	Communal Septic Tank		Sewerage		Capacity IPLT	Sum	MCK	Sum
	Population	%	person	%	Person	m ³ /day	IPLT		Cities
(2)	(3)	(4)	(5)	(6)	(7)	(8)	(9)	(10)	(11)
Sumatera	17,884,336	31.85	5,696,724	0.29	51,000	2.95	1,571	1,149	129
Jawa + Bali	75,049,732	22.84	17,140,506	3.24	2,430,426	1,885.35	357	3,797	141
Kalimantan	5,259,688	31.48	1,655,720	0.15	7,814	188.00	757	299	37
NTB+NTT	3,796,301	5.82	221,004	-	-	1.25	6	579	12
Sulawesi	6,103,336	6.93	422,909	-	-	1.50	10	283	63
Maluku + Papua	1,319,168	18.18	239,765	-	-	0.25	2	120	17
TOTAL	109,41	23.19	25,376,628	2.28	2,489,240	2,079	2,703	6,227	399



As example :

MCK= Mandi, Cuci dan Kakus (Bath, wash and water closet) around Bandung and Tangerang



Challenges

- ▶ Less than *5 million people (2%) are connected to sanitary sewers*
- ▶ Investment Needed *USD 5.00/capita/year, currently level of investment reaches only USD 0.55/capita/year*
- ▶ Huge investment required vs. Low investment priority by most local governments vs. low WTP for sanitation services.
- ▶ Awareness!!
- ▶ Lack of quality comprehensive sanitation planning at local levels.
- ▶ Limited number of experts:
 - technical
 - government and community facilitators

POLICIES (BAPENAS)

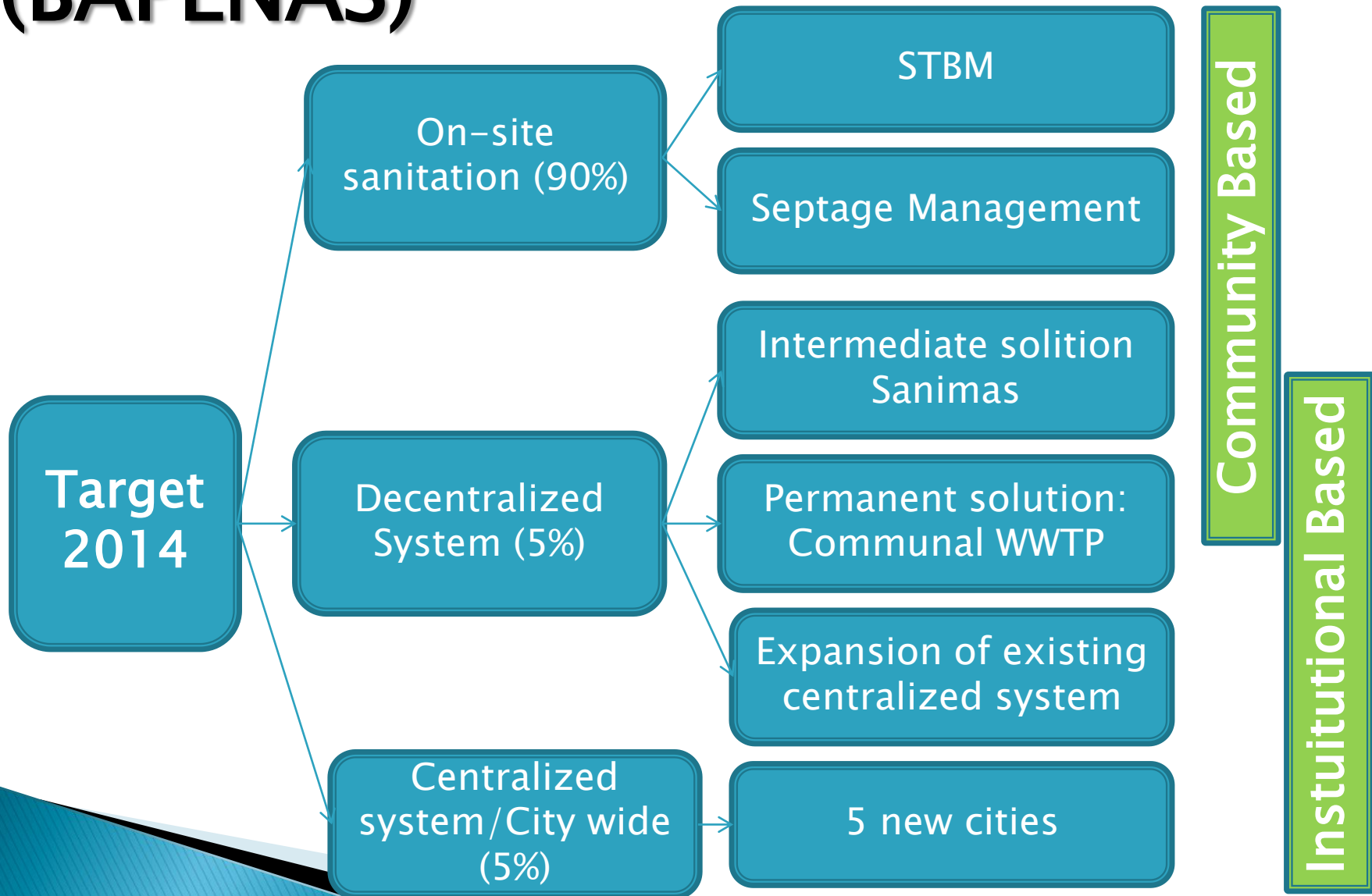

3. Future Development :

- ▶ The development of ecological system might be a good alternative to develop the recycling system
- ▶ To increase the accessibility of basic sanitation facilities : **75.175 % in 2015**

- ▶ How to manage the wastewater from domestic and small-medium scale enterprises???



Location of Slaughtering Houses and Tofu Industries Near Bandung

Inlet

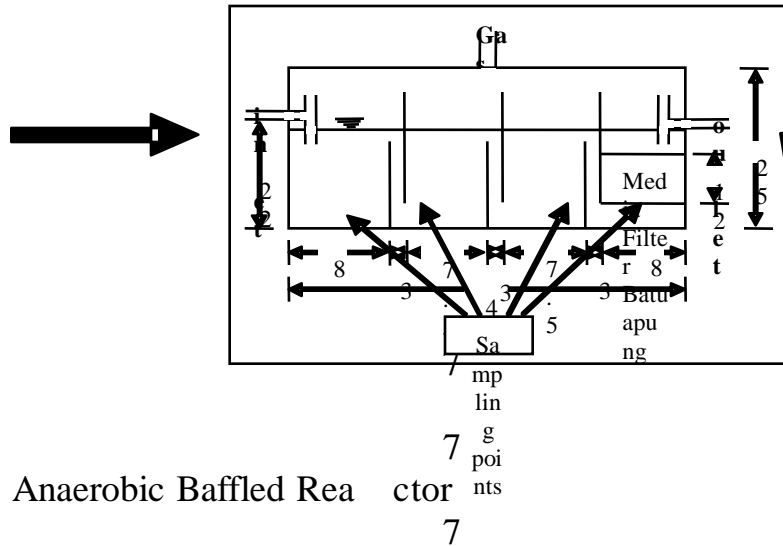

Wetland reactor

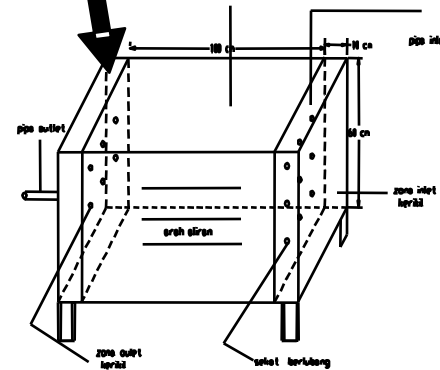

Outlet



Two Stages of Wastewater Treatment Using Modifications of Anaerobic Baffled Reactor and Constructed Wetland to Domestic and SME Wastewater

- ▶ How to manage
the domestic wastewater ???
 - Off site treatment
 - On site treatment



Wastewater Management System

1. Off site system

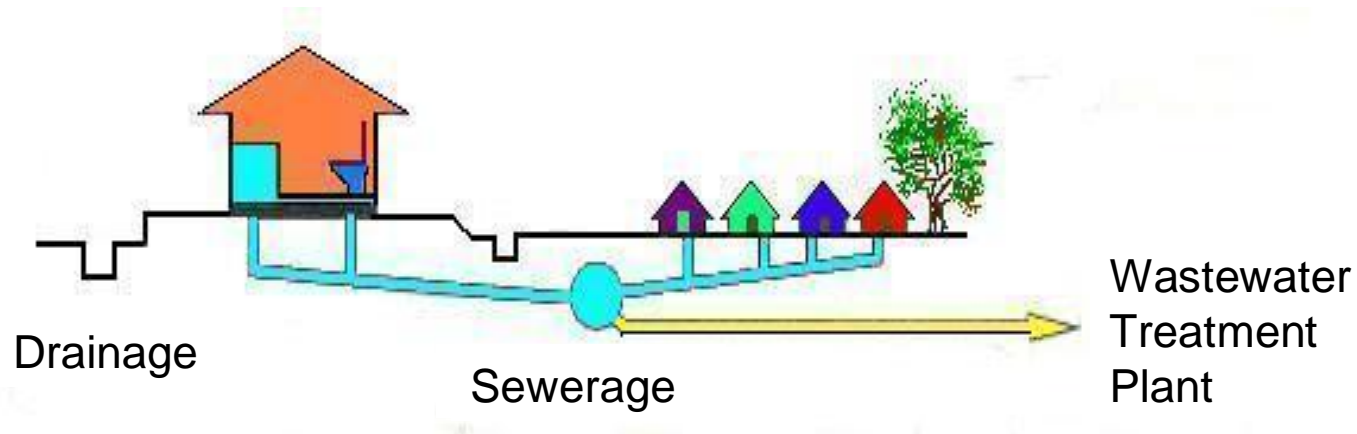

2. On site system



Wastewater Management Model (Wastewater Separation)

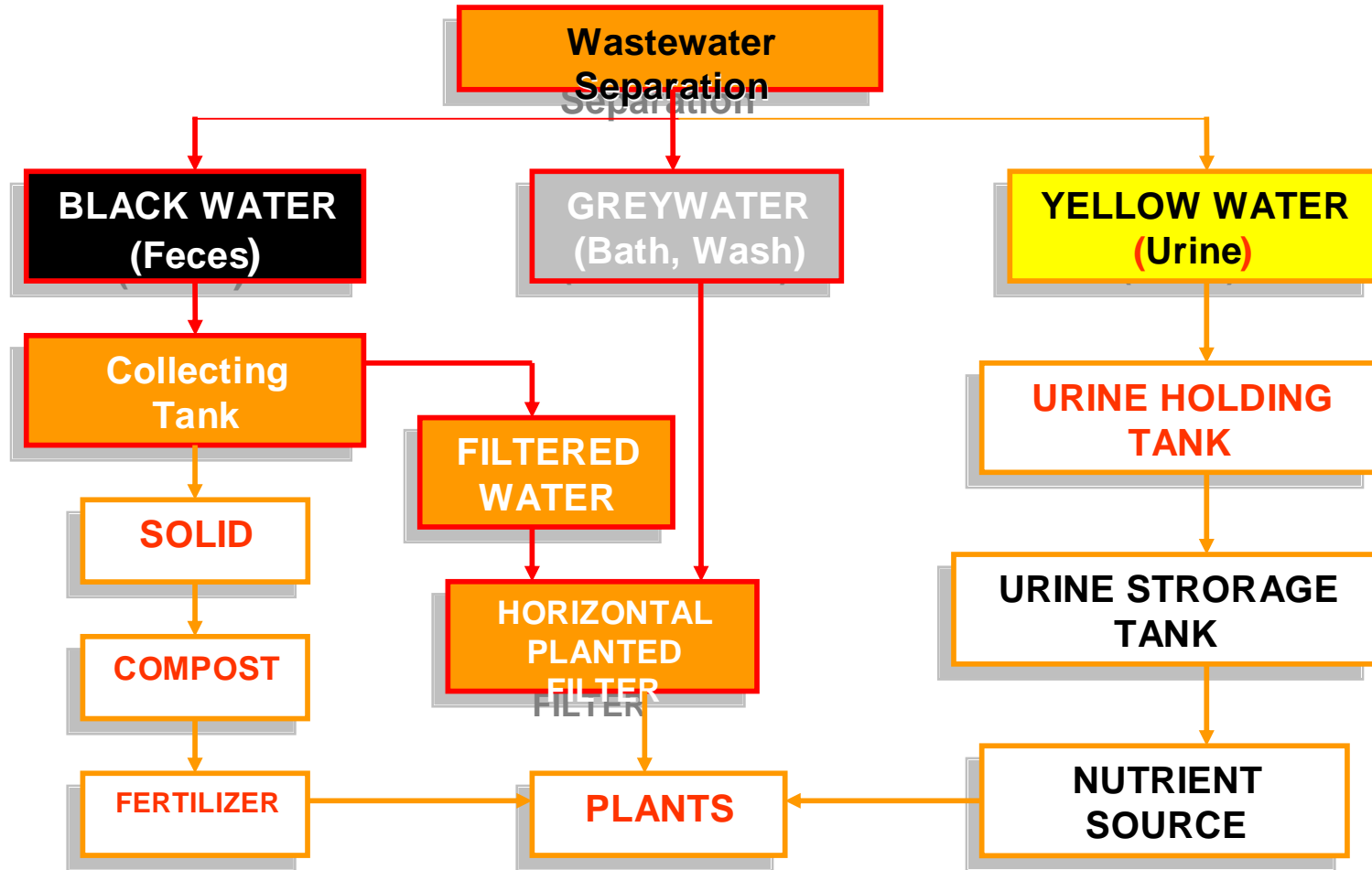

The following are the strategic in improving wastewater treatments :

- Increase the access to domestic wastewater services, both on-site and off-site, in urban and rural areas;
- Increase the financial capacities for wastewater infrastructure developments, both on-site and off-site, and also recover treatment cost to insure services;
- Increase the societies contribution on developing housing effluent of domestic wastewater treatment system;
- Increase the work of wastewater treatment institution and separate function between regulator and operator;
- Develop a regulation and apply treatments according to the enacted guidelines.

4. Conclusions :

- Almost half of the Indonesian populations have no accessibility to wastewater facilities, which can potentially pollute the body of water.
- By increasing both systems (on site and off site), the degradation of raw water quality can be reduced.
- The development of technology can play as the key role in improving these facilities.
- Community Participation is also very important to be concerned about.

Thank you